

FT-415 / 416

Technical Supplement



FT-415



FT-416

YAESU MUSEN CO., LTD.

C.P.O. Box 1500, Tokyo, Japan

YAESU U.S.A.

17210 Edwards Rd., Cerritos, California 90703
U.S.A.

YAESU EUROPE B.V.

Snipweg 3. 1118AA Schiphol, The Netherlands

YAESU UK LTD.

Unit 2, Maple Grove Business Centre

Lawrence Rd., Hounslow, Middlesex TW4 6DR, UK

Case Disassembly & PCB Access

- With the radio off, remove the soft case, if used, and the battery pack.
- Referring to Figure 1, remove the four screws on the bottom, and carefully remove the bottom cover (but not its wires).
- Remove the screws on each side of the rear cover, as shown in Figure 2.
- Gently separate the front and rear halves of the case slightly at the left side, just until you can see the flat cable connecting the two halves.
- Using a small screwdriver and referring to Figure 3, pry up on each side of the flat cable socket

until you can pull the cable free. Then fold the front half to the right (Figure 4).

- The IF Unit can be removed from the rear half of the transceiver by removing the three screws shown in Figure 5.
- When reassembling the transceiver, push the flat cable disconnected above back into its socket (Figure 6), and press down on each side of the socket alternately using a small screwdriver. Then align the upper edge of the front panel with the front edge of the top panel, and press the halves together gently.

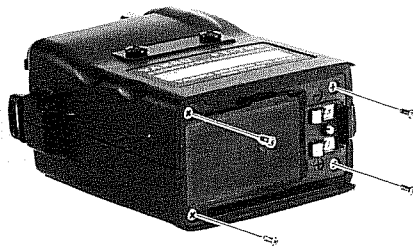

Fig. 1

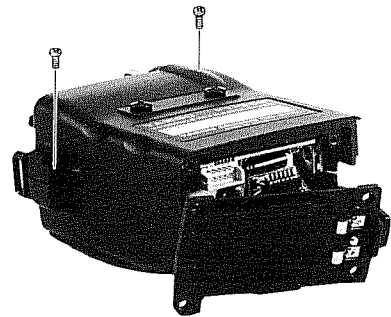

Fig. 2

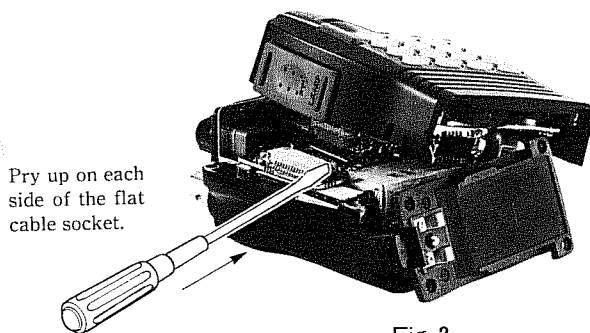

Fig. 3

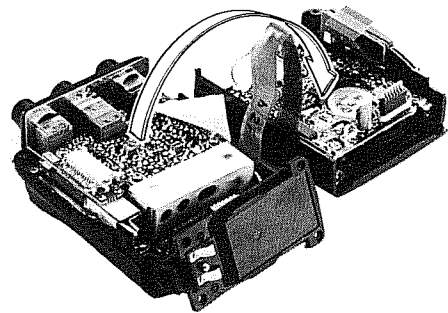

Fig. 4

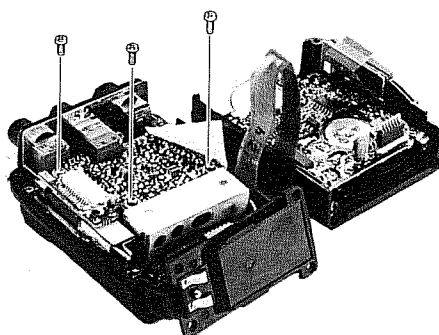
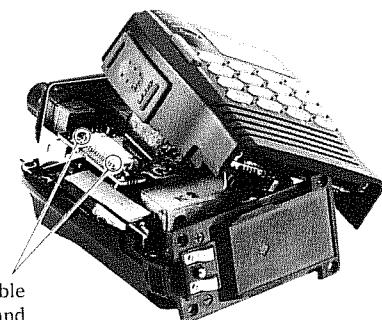

Fig. 5



Push the flat cable into its socket, and press down on each side of the socket alternately.

Fig. 6

Packaging

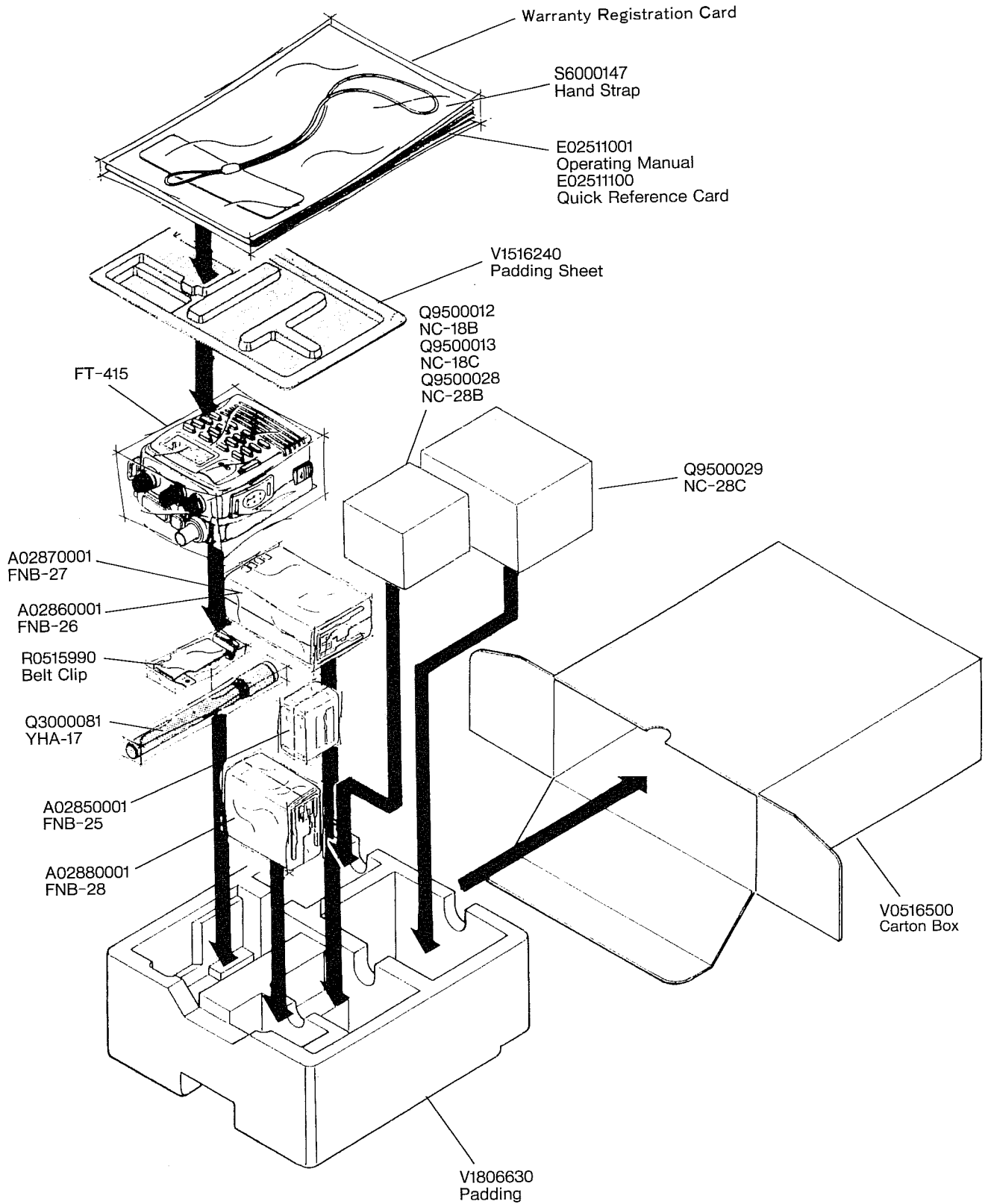

Exploded View (FT-416)

No.	YAESU P/N	Description	Qty.
①	U9900004	TAPTITE SCREW M2X4	5
②	U9900012	TAPTITE SCREW M2X4	6
③	U00103001	PAN HEAD SCREW M2X3	6
④	U07240101	PAN HEAD SCREW M2X4#1	4
⑤	U20203027	BINDING HEAD SCREW M2.6X3B SUS	2
⑥	U9900040	TAPTITE SCREW M2X12.5B SUS	2
⑦	U30103001	FLAT HEAD SCREW M2X3	2
⑧	U60100301	HEX NUT N2	1
⑨	R6137860	SUPPORT	1

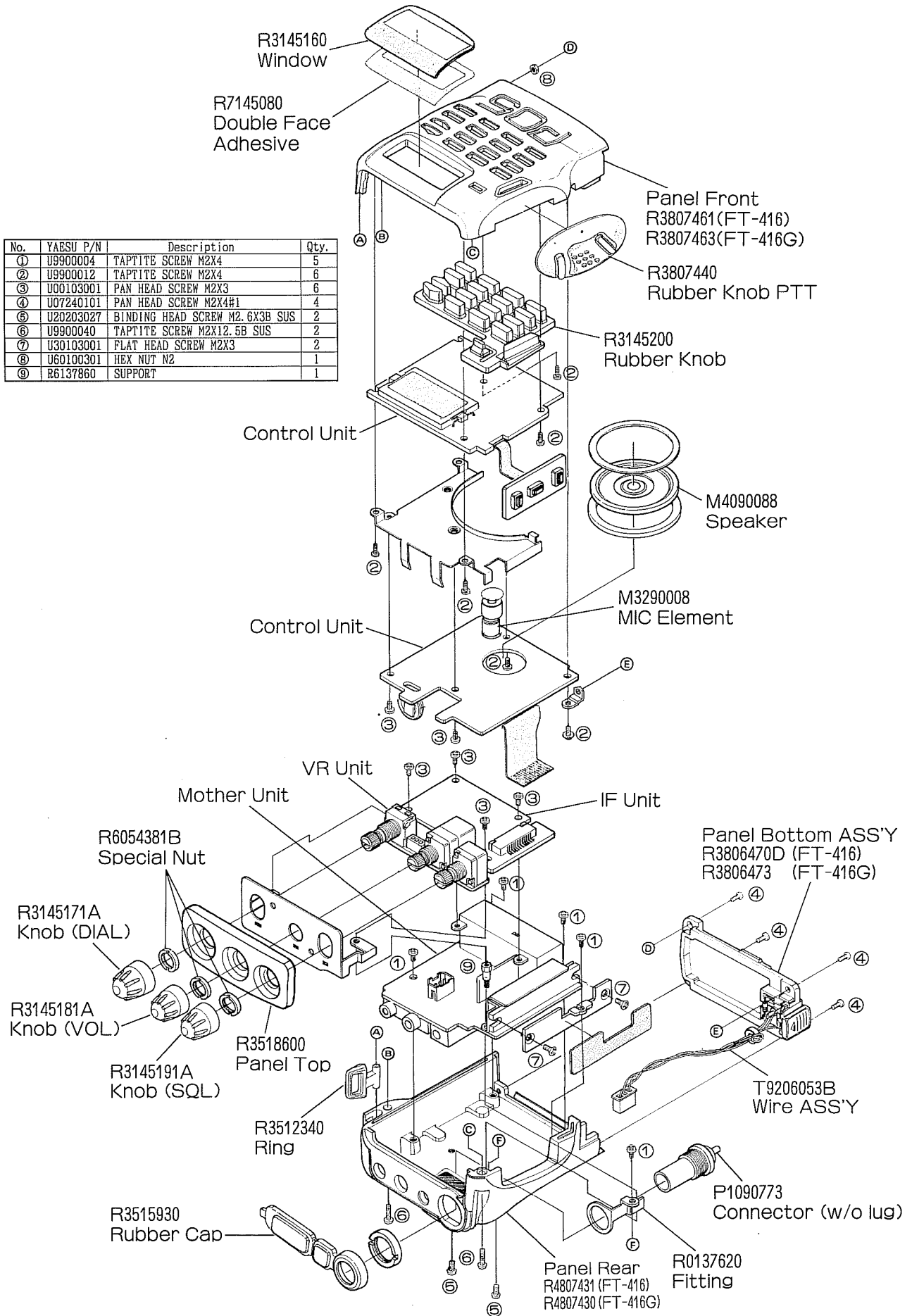

Chip Component Information

Capacitor

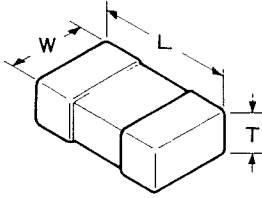

(Unit : mm)

Type	L	W	T
3216	3.2	1.6	0.45~0.60
2125	2.0	1.25	0.35~0.50
1608	1.6	0.8	0.65~0.95

Tantalum Capacitor

Negative

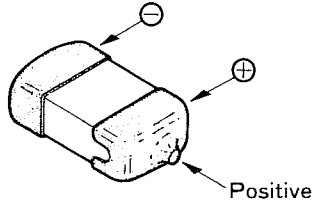

Positive

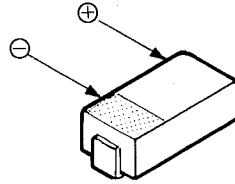

Examples :
J475 = 6.3V 4.7 μ F

G	4.0V	D	20V
J	6.3V	E	25V
A	10V	V	35V
C	16V		

Polarized, Unmarked
(determine value from layout
and Parts List)

Resistors

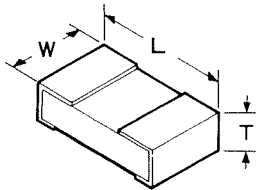

(Unit : mm)

Type	L	W	T
1/10	2.0	1.25	0.45
1/16	1.6	0.8	0.45

Type RMC 1/10W, 1/16W
Marking* 100, 222, 473.....

473		
Ten unit	One unit	Multiplier code
0	0	10 ⁰
1	1	10 ¹
2	2	10 ²
3	3	10 ³
4	4	10 ⁴
5	5	10 ⁵
6	6	10 ⁶
7	7	10 ⁷
8	8	10 ⁸
9	9	10 ⁹

Examples :

100 = 10 Ω

222 = 2.2k Ω

473 = 47k Ω

INDICATED LETTERS

1 2 3 4

5 6 7 :

9 0 .

Diodes

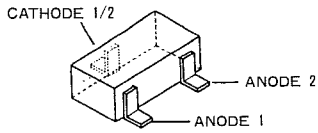

SLM-23VMWS
(D2018)
DAN202U
(D1001, 1002, 1004)
(1005, 1008, 1021)
2008

DAP202U
(D2019)
1SS321
(D1017)
1SS301
(D0101)

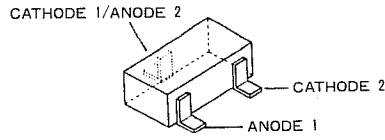

1SS302
(D1007, 1018, 2001)
(2009, 3001, 3003)
3004

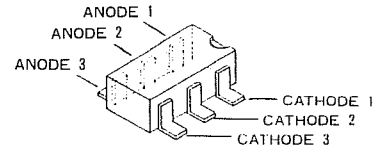

IMN10
(D2003)

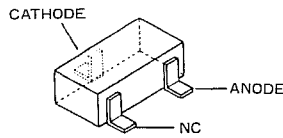

SLM-13MWS
(D2013, 2014, 2015)
2016

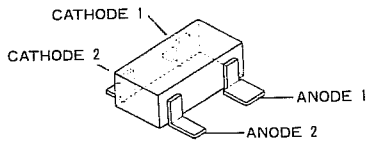

1SS272
(D2004, 2006, 2010)
2011
1SS319
(D2007)

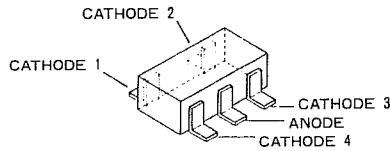

FMP1
(D2002, 2005)

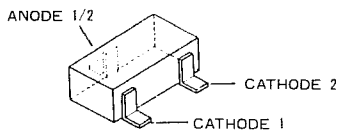

1SS300
(D6005)

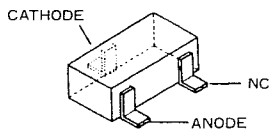

1SS294
(D3002)
02CZ2.0X
(D1003)

Circuit Description

The FT-45/46 electronics consists of two major boards: the Motherboard (or Mother Unit) and the Control Unit, and several minor boards: the IF Unit, Pager Unit (DTMF decoder), Clock Unit (PLL reference), VR Unit (top panel controls) and optional FTS-17A Tone Squelch Unit. Also, two daughter cards are mounted on the Motherboard: the PLL Unit and the APC Unit. The Motherboard includes the receiver front end, the later transmitter stages, battery charger, supply regulation and switching circuits. The Control Unit includes the microprocessor, display, keypad, transmitter audio and VOX circuits. While reading this description, you can refer to the block diagram for an overview of the major circuit blocks, and to the schematic diagrams for component details.

Receive Signal Path

Incoming RF from the antenna jack on the Motherboard passes through a lowpass filter and a $\frac{1}{4}$ -wave antenna switching network consisting of coil L1005, capacitors C1035 & C1050, and diodes D1011 & D1014. Signals within the frequency range of the transceiver are then passed by a varactor-tuned bandpass filter consisting of T1004 and D1019/D1020 before RF amplification by Q1016 (2SC4537). The amplified RF is then bandpass filtered again by varactor-tuned resonators T1003/D1015/D1016, T1002/D1012/D1013 and T1001/D1009/D1010 to ensure pure in-band input to 1st mixer Q1008 (2SK882Y).

Buffered 122.3 ~ 132.3-MHz output from the PLL Unit is amplified by Q1002 (2SC3120) and applied to the 1st mixer. The resulting 17.7-MHz 1st mixer product is passed through dual monolithic crystal filters XF1001/XF1002 (± 7.5 kHz BW) to strip away all but the desired signal, which is then delivered to the IF Unit.

The 1st IF signal from the Motherboard is amplified by Q3002 (2SC4215Y) and applied to FM IF subsystem IC Q3004 (MC3372ML), which contains the 2nd mixer, 2nd local oscillator, limiter amplifier, noise amplifier, S-meter amplifier and squelch gates. A 2nd local signal is generated from 17.245 MHz crystal X3001, which produces the 455 kHz 2nd IF when mixed with the 1st IF signal within Q3004. The 2nd IF is passed through ceramic filter CF3001 to strip away unwanted mixer products, and then applied to the limiter amp in Q3004, which removes amplitude variations in the 455

kHz IF before detection of the speech by ceramic discriminator CD3001.

Detected audio is de-emphasized and filtered by Q3007 and Q3011 (2SC4116GR $\times 2$), and then passed through audio muting gate Q3016 (2SJ-125D). This filtered receiver audio is then mixed with the beep or DTMF tone from the Control Unit, passed through the **VOL** control on the VR Unit, and returned for final amplification by Q3014 (NJM386BD) on the IF Unit before delivery via the Motherboard to the **EAR** jack and loudspeaker.

Squelch Control

The squelch circuit consists of noise detector D3003, a highpass filter and squelch trigger within Q3004 on the IF Unit, and control circuitry within microprocessor Q2007 (HD404618-A13H) on the Control Unit.

When no carrier is received, noise at the output of the detector stage in Q3004 is amplified and highpass filtered by the noise amp section of Q3004, and then rectified by D3003 to provide a DC control voltage for the squelch switching section within Q3004. With no carrier, pin 14 of Q3004 is high. This signal is delivered to pin 1 of main microprocessor Q2007 on the Control Unit as the Scan Stop signal, which turns off the green (busy) half of **BUSY/TX** LED via shift/store register Q2012 (μ PD74HC4094G). Another output of Q2012 also raises the AF MUTE line, cutting receiver audio at Q3016 on the IF Unit. Meanwhile, AFCNT pin 80 of the microprocessor turns off the DC supply to audio amplifier Q3014 via Q3005 (2SC4116GR), Q3006 (2SB799ML), Q3009 (IMD2) and Q3010 (DTC144EU) on the IF Unit, thus silencing the receiver while no signal is being received, and during transmission.

When a carrier appears at the discriminator, noise is removed from the output, causing pin 14 of Q3004 to go low. This signals the microprocessor to activate the green half of the **BUSY/TX** LED through Q2012. The microprocessor then checks for CTCSS tone detection from the FTS-17A Tone Squelch Unit (if installed), and for Digital Code Squelch information. If not transmitting and tone squelch is not activated, or if the received tone matches that programmed, the microprocessor signals Q2012 to switch Q3016 to allow audio to pass to the amplifier and loudspeaker.

frequency, so as to produce a 5-kHz or 6.25-kHz derivative of the current VCO frequency. Meanwhile, the reference divider section of Q6006 divides the 12.8-MHz crystal reference from the Clock Unit by 2560 (or 2048) to produce the 5-kHz (or 6.25-kHz) loop reference (respectively).

The 5-kHz (or 6.25-kHz) signal from the programmable divider (derived from the VCO) and that derived from the reference oscillator are applied to the phase detector section of Q6006, which produces a dual 5-V pulsed output with pulse duration depending on the phase difference between the input signals. This pulse train is passed to the Clock Unit for lowpass filtering, and then returned to varactors D6003/D6004 (for the transmitter) and D6001/D6002 (for the receiver) on the PLL Unit.

Changes in the level of the DC voltage applied to the varactors affect the reactance in the tank circuit of the VCO, changing the oscillating frequency of the VCO according to the phase difference between the signals derived from the VCO and the crystal reference oscillator. The VCO is thus phase-locked to the crystal reference oscillator.

The output of receiver VCO Q6001, after buffering by Q6003, is delivered to the Main Unit for amplification by Q1002 before application to the 1st mixer, as described previously.

Transmitter VCO Q6005 oscillates between 140 and 150 MHz according to the programmed transmit frequency. The remainder of the PLL circuitry is shared with the receiver. However, the dividing data from the microprocessor is such that the VCO frequency is at the actual transmit frequency (rather than offset for IFs, as in the receiving case). Also, the transmitter VCO is modulated by the filtered speech audio applied to the tank circuit at D6005, as described previously. Transmit and receive 5-V buses select which VCO is to be active by Q6008 (DTC144EU, for the receiver) and Q6007 (DTC144EU, for the transmitter). FET Q7003 (2SK880GR) on the Clock Unit buffers the VCV line for application to the tracking bandpass filters in the receiver front end on the Motherboard.

Transmit Inhibit

When the transmit PLL is unlocked, UL pin 7 of PLL chip Q6006 goes high. This unlock signal is

diode-ORed with the receive 5-V bus and applied to Q4008 on the APC Unit to disable the transmitter as described above under the APC description.

Miscellaneous Circuits

Battery Charger & Power Control

The EXT DC jack on the Motherboard applies voltage to the B+ line through diode D1006 to operate the transceiver, and through regulator Q1005 (2SB799-ML) to the charging terminal of the battery. The outer (negative) contact of the EXT DC jack disconnects the negative side of the battery from direct chassis ground connection, placing diode D1021 in line instead when a plug is inserted in the jack. When the power is switched on, the B+ line on the Motherboard feeds transmitter RF power module Q1007 and the APC Unit directly, and 5-V regulator Q1006. The B+ voltage is also applied to Q2006 (1MZ1) on the Control Unit for low battery indication, and to LED driver Q2013 (2SD1366A) on the Control Unit for the LED indicator and display lamps.

Transmit/Receive Switching & Power Saving

Closing the PTT switch on the Control Unit pulls one side of the microphone low, which turns on Q2008 (1MZ1), pulling PTT pin 18 of microprocessor Q2007 low. This causes pin 2 of Q2007 to go low, and the resulting signal turns on Q1013 (DTA123YU) on the Motherboard to apply 5 volts to the T5 line for the transmitter circuitry, and turns off Q1012/Q1009 (DTC144EU/DTA143XU) to disable the receiver. Pin 18 of the microprocessor can also be pulled low by amplified microphone audio from Q2009 via VOX controller Q2010 (DTC124TU) when an external microphone is used and the VOX function is enabled by the microprocessor via Q2012 pin 14.

When the Power Saver feature is activated by the operator, the microprocessor periodically pulls pin 79 low, which enables the 5-V buses for the receiver via Q1010 (DTA123YU) when not transmitting.

Beeper Q2005 (μ PD4013BG- $\frac{1}{2}$) generates keypad beeps, passed via Q2011 to the Motherboard for amplification along with receiver audio. The other half of Q2005 is used to generate an 88.5-Hz CTCSS tone in Japanese versions only, which is filtered by Q2009- $\frac{2}{4}$. These stages are not used in other versions.

Alignment

The FT-415/416 has been carefully aligned at the factory for the specified performance across the amateur band. Realignment should therefore not be necessary except in the event of a component failure. Sets under warranty should be serviced only by authorized Yaesu representatives, or the warranty policy may be voided.

The following procedures cover the sometimes critical and tedious adjustments not normally required once the transceiver has left the factory. However, if damage occurs and some parts subsequently be replaced, realignment might be required. If a sudden problem occurs during normal operation, it is likely due to component failure; realignment should not be done until after the faulty component has been replaced.

We recommend that servicing be performed only by authorized Yaesu service technicians who are experienced with the circuitry and fully equipped for repair and alignment. Therefore, if a fault is suspected, contact the dealer from whom the transceiver was purchased for instructions regarding repair. Authorized Yaesu service technicians realign all circuits and make complete

performance checks to ensure compliance with factory specifications after replacing any faulty components.

Those who do undertake any of the following alignments are cautioned to proceed at their own risk. Problems caused by unauthorized attempts at realignment are not covered by the warranty policy. Also, Yaesu must reserve the right to change circuits and alignment procedures in the interest of improved performance, without notifying owners.

Under no circumstances should any alignment be attempted unless the normal function and operation of the transceiver are clearly understood, the cause of the malfunction has been clearly pinpointed and any faulty components replaced, and the need for realignment determined to be absolutely necessary.

The following test equipment (and thorough familiarity with its correct use) is necessary for complete realignment. Correction of problems caused by misalignment resulting from use of improper test equipment is not covered under the warranty policy. While most steps do not require all of the equipment listed, the interactions of some

Circuit Board Locations

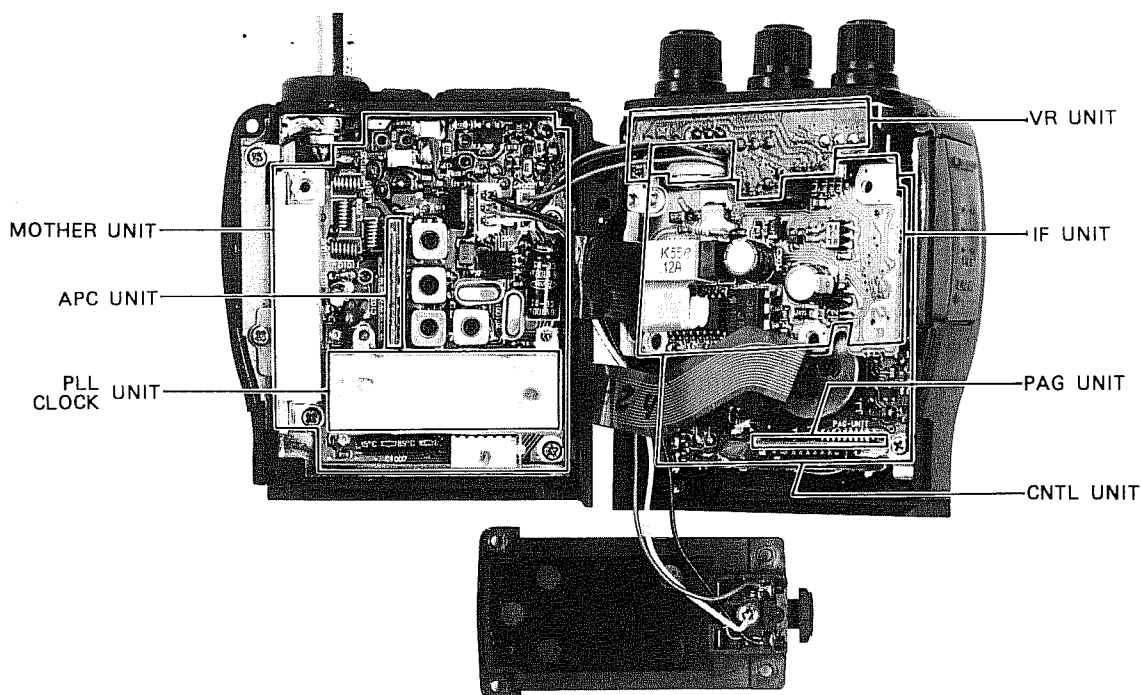

PLL & Transmitter Alignment Points

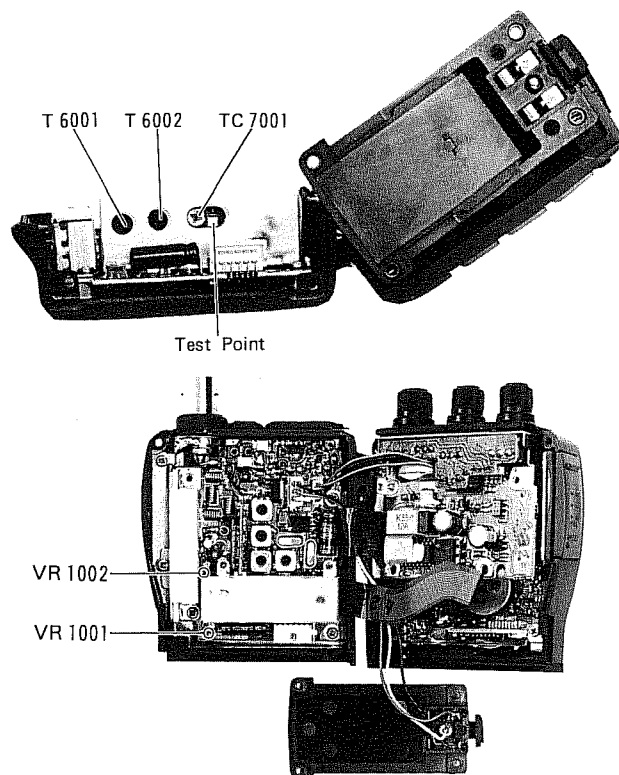

Deviation & Modulation Level

- While tuned to the center of the band (145 or 146 MHz), set the AF generator attenuator for 25 mV output at 1 kHz to the external MIC jack.
- Key the transmitter and adjust VR1001 on the Motherboard for ± 4.5 kHz deviation on the deviation meter.
- Reduce the AF injection level to 1.5 through 4 mV, and confirm deviation ± 3.5 kHz.

Transmitter S/N Check

Reduce the 1-kHz AF generator injection to 0dB with ± 3.5 -kHz deviation, and turn on the linear detector BPF (300 Hz ~ 3 kHz). Key the transmitter, and confirm 40dB S/N or better.

VOX Circuit Check

- Press **F|M** and then **8/VOX** as necessary to select Hi VOX sensitivity. Set the AF generator for 2.5 mV injection at 1 kHz, and confirm that the VOX keys the transmitter.
- Again press **F|M** and then **8/VOX** as necessary, to select Low VOX sensitivity. Set the AF generator for 4 mV injection at 1 kHz, and confirm that the VOX keys the transmitter.

DTMF Circuit Check

Hold the PTT switch and confirm ± 2 to ± 3.8 -kHz deviation when pressing a keypad key.

Receiver Alignment Points

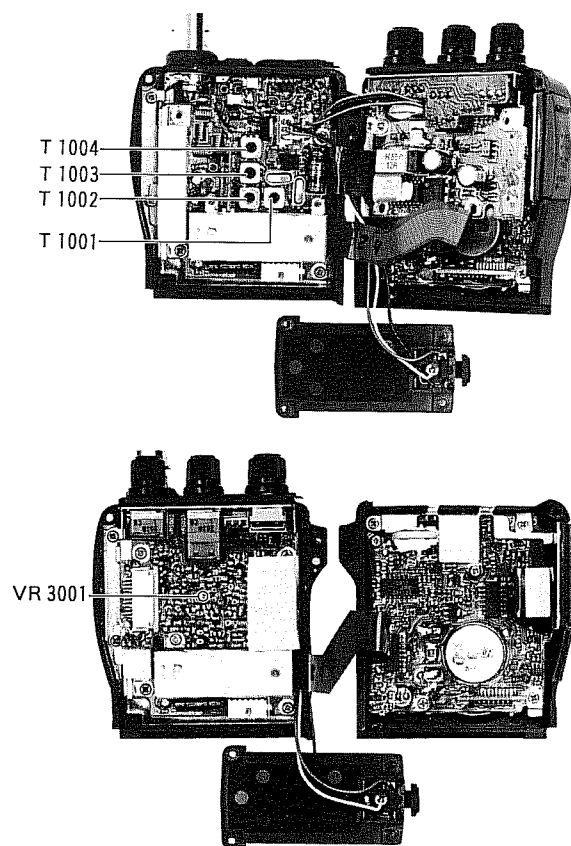

Receiver

Set up the test equipment as shown below.

Sensitivity: Interstage Transformers

- With the transceiver and RF signal generator both tuned to band center (145 or 146 MHz), modulate the RF signal generator with ± 3.5 kHz deviation of a 1-kHz tone, and inject 40 dB μ at the antenna jack.
- Adjust T1001 through T1004 on the Motherboard for maximum S-meter indication. Then reduce the injection level to -9 dB μ and confirm at least 12 dB SINAD.

S-Meter Calibration

While tuned to the center of the band (145 or 146 MHz), inject 20 dB μ and adjust VR3001 on the Motherboard so that all S-meter segments are just on.

Receiver Alignment Setup

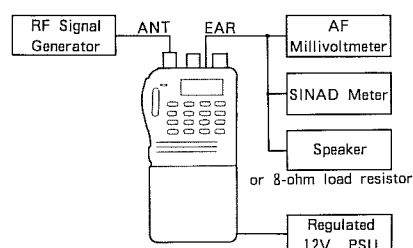

Block Diagram

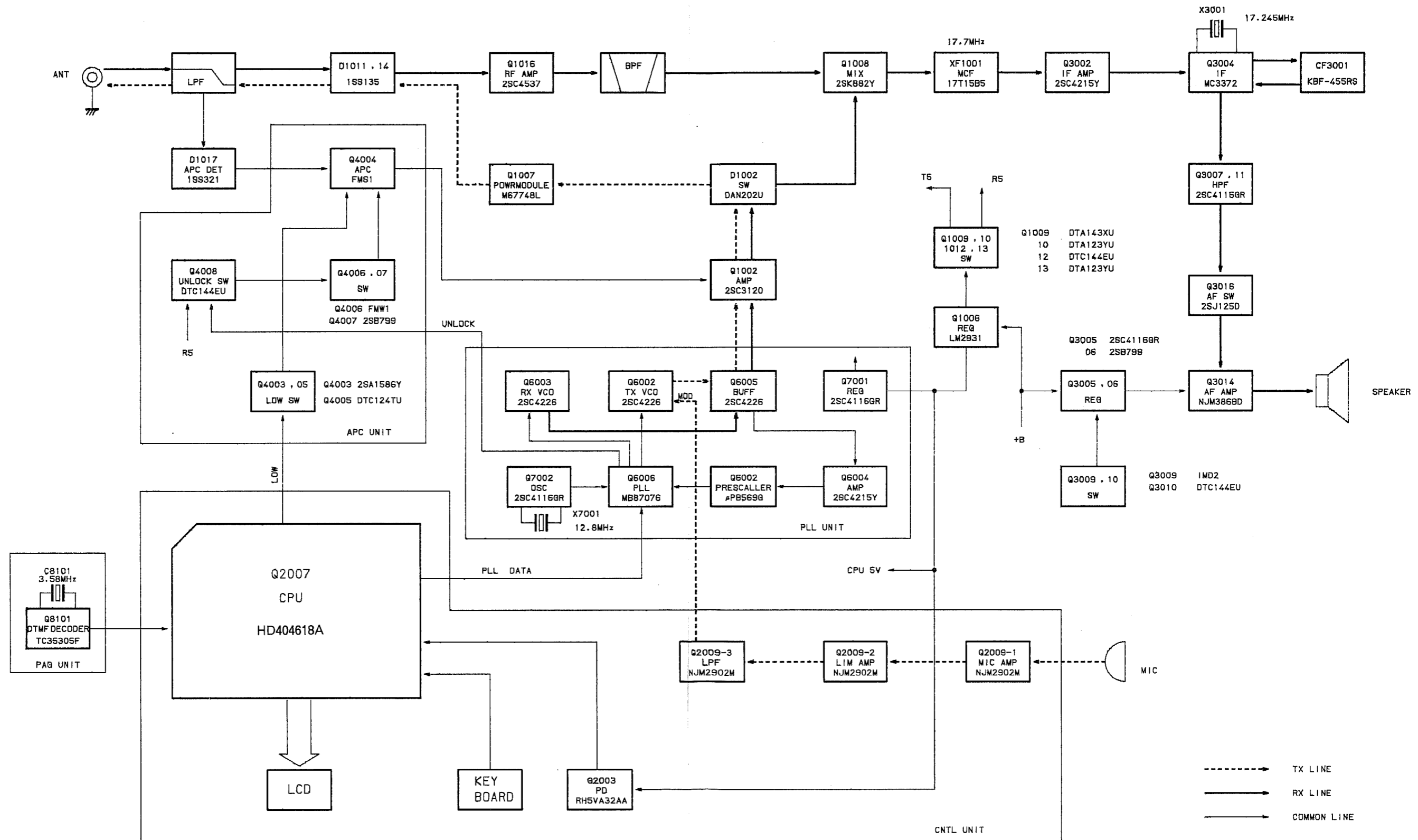

Mother Unit Parts List

REF.	DESCRIPTION	VALUE	WV	TOL.	MFGR'S DESIG	YAESU P/N	VERS.
*** MOTHER UNIT ***							
	PCB With APC, CLOCK, PLL UNIT					CP3357003	TYP A2
	PCB With APC, CLOCK, PLL UNIT					CP3357004	TYP A1
	PCB With APC, CLOCK, PLL UNIT					CP3357005	TYP A3
	PCB With APC, CLOCK, PLL UNIT					CP3357006	TYP B1
	PCB With APC, CLOCK, PLL UNIT					CP3357007	TYP B3
	Printed Circuit Board					F3213101D	
C 1001	CHIP CAP.	0.001uF	50V	B	GRM39B102M50PT	K22174809	
C 1002	CHIP CAP.	0.001uF	50V	B	GRM39B102M50PT	K22174809	
C 1003	CHIP CAP.	100pF	50V	CH	GRM39CH101J50PT	K22174235	
C 1004	CHIP CAP.	0.001uF	50V	B	GRM39B102M50PT	K22174809	
C 1005	CHIP CAP.	100pF	50V	CH	GRM39CH101J50PT	K22174235	
C 1006	CHIP CAP.	0.001uF	50V	B	GRM39B102M50PT	K22174809	
C 1007	AL. ELECTRO. CAP.	100uF	10V		10VB-100 (M) CC	K40109026	
C 1008	CHIP CAP.	0.1uF	25V	B	GRM40B104M25PT	K22140811	
C 1009	CHIP CAP.	0.1uF	25V	B	GRM40B104M25PT	K22140811	
C 1010	CHIP CAP.	0.001uF	50V	B	GRM39B102M50PT	K22174809	
C 1012	TANTALUM CHIP CAP.	4.7uF	6.3V		F950J475MSAAF1Q2	K78080002	
C 1013	CHIP CAP.	0.001uF	50V	B	GRM39B102M50PT	K22174809	
C 1014	CHIP CAP.	0.1uF	25V	B	GRM40B104M25PT	K22140811	
C 1016	CHIP CAP.	0.001uF	50V	B	GRM39B102M50PT	K22174809	
C 1018	CHIP CAP.	0.001uF	50V	B	GRM39B102M50PT	K22174809	
C 1019	TANTALUM CAP.	3.3uF	16V		DN1C3R3M1S	K70127335	
C 1020	CHIP CAP.	0.001uF	50V	B	GRM39B102M50PT	K22174809	
C 1021	CHIP CAP.	10pF	50V	CH	GRM39CH100D50PT	K22174211	
C 1022	CHIP CAP.	0.001uF	50V	B	GRM39B102M50PT	K22174809	
C 1023	CHIP CAP.	5pF	50V	CH	GRM39CH050C50PT	K22174206	
C 1024	TANTALUM CHIP CAP.	2.2uF	16V		F951C225MSAAF1Q2	K78120002	
C 1025	AL. ELECTRO. CAP.	100uF	16V		CEDSM1C101M	K40129060	
C 1026	CHIP CAP.	0.001uF	50V	B	GRM39B102M50PT	K22174809	
C 1027	CHIP CAP.	0.001uF	50V	B	GRM39B102M50PT	K22174809	
C 1028	CHIP CAP.	0.001uF	50V	B	GRM39B102M50PT	K22174809	
C 1029	CHIP CAP.	0.001uF	50V	B	GRM39B102M50PT	K22174809	
C 1031	AL. ELECTRO. CAP.	4.7uF	16V		RC3-16V4R7MS	K40129059	
C 1032	TANTALUM CHIP CAP.	10uF	6.3V		F950J106MTAAF1Q2	K78080003	
C 1033	CHIP CAP.	0.001uF	50V	B	GRM39B102M50PT	K22174809	
C 1034	CHIP CAP.	0.001uF	50V	B	GRM39B102M50PT	K22174809	
C 1035	CHIP CAP.	18pF	50V	CH	GRM39CH180J50PT	K22174217	
C 1036	CHIP CAP.	12pF	50V	CH	GRM39CH120J50PT	K22174213	
C 1037	TANTALUM CAP.	10uF	6.3V		DNOJ100M1S	K70087106	
C 1038	CHIP CAP.	0.01uF	25V	B	GRM39B103M25PT	K22144802	
C 1039	CHIP CAP.	0.001uF	50V	B	GRM39B102M50PT	K22174809	
C 1040	CHIP CAP.	27pF	50V	CH	GRM39CH270J50PT	K22174221	
C 1041	CHIP CAP.	1pF	50V	CK	GRM39CK010C50PT	K22174202	
C 1042	CHIP CAP.	6pF	50V	CH	GRM39CH060D50PT	K22174207	
C 1043	CHIP CAP.	0.001uF	50V	B	GRM39B102M50PT	K22174809	
C 1044	CHIP CAP.	47pF	50V	CH	GRM39CH470J50PT	K22174227	
C 1045	CHIP CAP.	1pF	50V	CK	GRM39CK010C50PT	K22174202	
C 1046	CHIP CAP.	47pF	50V	CH	GRM39CH470J50PT	K22174227	
C 1048	CHIP CAP.	150pF	50V	CH	GRM39CH151J50PT	K22174239	
C 1050	CHIP CAP.	22pF	50V	CH	GRM39CH220J50PT	K22174219	
C 1052	CHIP CAP.	47pF	50V	CH	GRM39CH470J50PT	K22174227	

Mother Unit Parts List

REF.	DESCRIPTION	VALUE	WV	TOL.	MFGR'S DESIG	YAESU P/N	VERS.
D 1020	DIODE				HVU306A5TRF	G2070132	
D 1021	DIODE				DAN202U T106	G2070162	
D 1023	DIODE				1SS314 TPH3	G2070122	
J 1001	CONNECTOR				HSJ1468-01-120	P1090691	
J 1002	WIRE-ASSY					T9206052	
J 1003	CONNECTOR				53020-1010	P0090682	
J 1004	CONNECTOR				SB20-03WS	P0090610	
J 1005	CONNECTOR				HEC3600-01-110	P0090809	
L 1002	CHIP COIL	0.1uH			LQN2AR10K	L1690011	
L 1003	COIL	4.7uH			32CS 380LB-4R7M=P	L1690035	
L 1004	COIL	1uH			32CS 380LB-1ROM=P	L1690016	
L 1005	COIL				6.5T3. ODO. 5UEW R	L0020427A	
L 1006	COIL				6.5T2. ODO. 5UEW R	L0021774	
L 1008	COIL				6.5T2. ODO. 5UEW R	L0021774	
L 1010	COIL				6.5T2. ODO. 5UEW R	L0021774	
Q 1001	TRANSISTOR				2SC4116GR TE85R	G3341167G	
Q 1002	TRANSISTOR				2SC3120TE85R	G3331207	
Q 1003	TRANSISTOR				DTC114EU T106	G3070084	
Q 1005	TRANSISTOR				2SB799-T2ML	G3207997L	
Q 1006	IC				LM2931AZ-5.0	G1090785	
Q 1007	IC				M67748L	G1091200	
Q 1008	FET				2SK882Y TE85R	G3808827Y	
Q 1009	TRANSISTOR				DTA143XU T107	G3070050	
Q 1010	TRANSISTOR				DTA123YU T107	G3070038	
Q 1012	TRANSISTOR				DTC144EU T107	G3070041	
Q 1013	TRANSISTOR				DTA123YU T107	G3070038	
Q 1016	TRANSISTOR				2SC4537 TR	G3345377	
Q 1018	TRANSISTOR				DTC144EU T107	G3070041	
Q 1019	TRANSISTOR				DTA144EU T106	G3070079	
R 1003	CHIP RES.	1K	1/16W		RMC1/16 102JATP	J24185102	
R 1004	CHIP RES.	100	1/16W		RMC1/16 101JATP	J24185101	
R 1005	CHIP RES.	1.8M	1/16W		RMC1/16 185JATP	J24185185	
R 1006	CHIP RES.	5.6K	1/16W		RMC1/16 562JATP	J24185562	
R 1007	CHIP RES.	4.7K	1/16W		RMC1/16 472JATP	J24185472	
R 1009	CHIP RES.	10K	1/16W		RMC1/16 103JATP	J24185103	
R 1010	CHIP RES.	15K	1/16W		RMC1/16 153JATP	J24185153	
R 1012	CHIP RES.	820	1/16W		RMC1/16 821JATP	J24185821	
R 1013	CHIP RES.	56	1/10W		RMC1/10T 560J	J24205560	
R 1014	CHIP RES.	1K	1/10W		RMC1/10T 102J	J24205102	
R 1015	CHIP RES.	12	1/10W		RMC1/10T 120J	J24205120	
R 1016	CHIP RES.	1K	1/10W		RMC1/10T 102J	J24205102	
R 1017	CHIP RES.	12	1/10W		RMC1/10T 120J	J24205120	
R 1018	CHIP RES.	2.2K	1/16W		RMC1/16 222JATP	J24185222	
R 1019	CHIP RES.	2.7K	1/16W		RMC1/16 272JATP	J24185272	
R 1020	CHIP RES.	1.2K	1/16W		RMC1/16 122JATP	J24185122	
R 1021	CHIP RES.	100	1/16W		RMC1/16 101JATP	J24185101	
R 1022	CHIP RES.	150	1/10W		RMC1/10T 151J	J24205151	
R 1023	CHIP RES.	100K	1/16W		RMC1/16 104JATP	J24185104	
R 1024	CHIP RES.	100K	1/16W		RMC1/16 104JATP	J24185104	
R 1025	CHIP RES.	47K	1/16W		RMC1/16 473JATP	J24185473	
R 1026	CHIP RES.	100K	1/16W		RMC1/16 104JATP	J24185104	

Mother Unit Board Layout

MOTHER UNIT (No.10××)

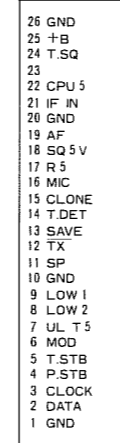
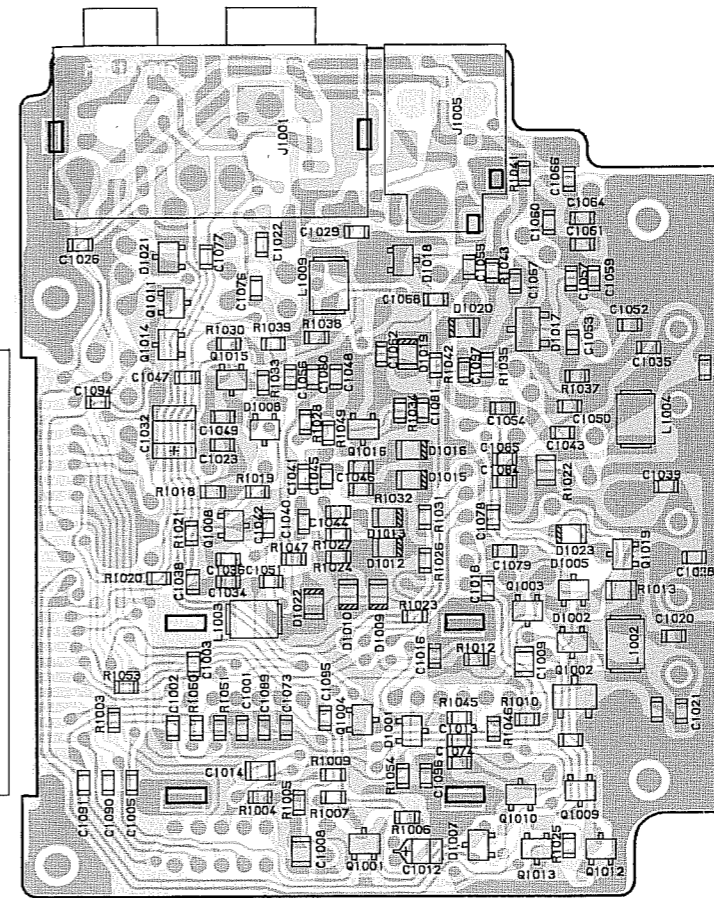
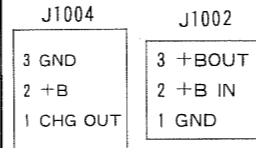
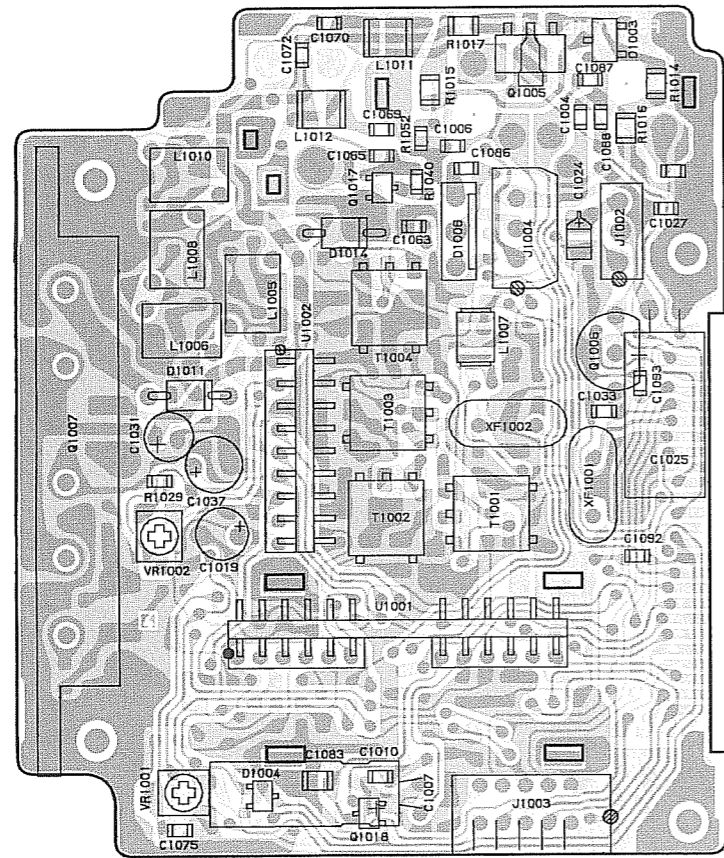

obverse view of "chip-only" side

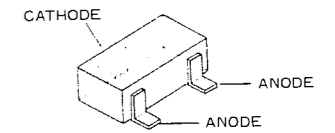

1SS321(F9)
(D1017)
DAN202U(N)
(D1001, 1002, 1004)
1005, 1008, 1021

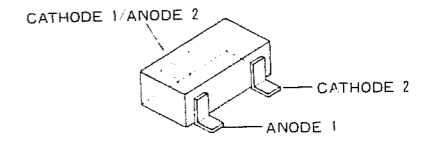

1SS302(C3)
(D1007, 1018)

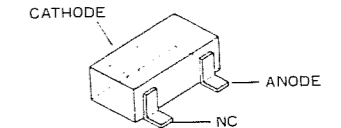

02CZ2.0X(15)
(D1003)

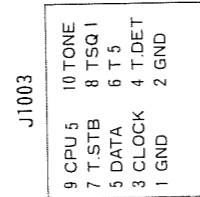

obverse view of "component" side

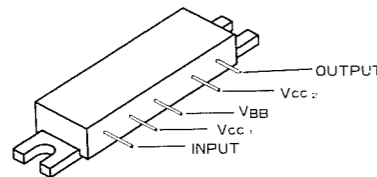

M67748L
(Q1007)

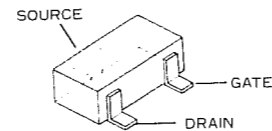

2SK882Y(TY)
(Q1008)

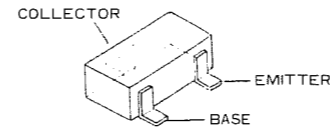

DTC144EU(26) (Q1012, 1018)	2SC4537(MI) (Q1016)
DTA123YU(52) (Q1010, 1013)	2SC4116GR(LG) (Q1001)
DTA143XU(33) (Q1009)	DTC114EU(14) (Q1003)
2SC3120(HB) (Q1002)	DTA144EU(16) (Q1019)

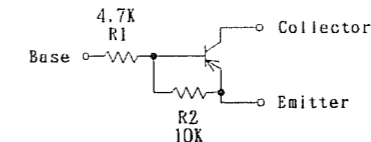

DTA143XU CIRCUIT DIAGRAM

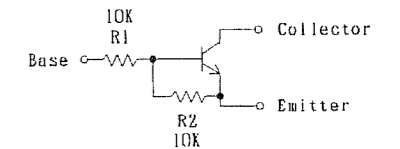

DTC114EU CIRCUIT DIAGRAM

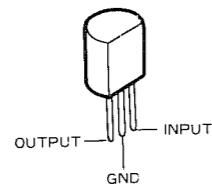

LM2931AZ-5.0
(Q1006)

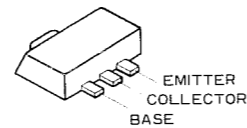

2SB799(ML)
(Q1005)

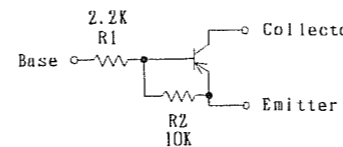

DTA123YU CIRCUIT DIAGRAM

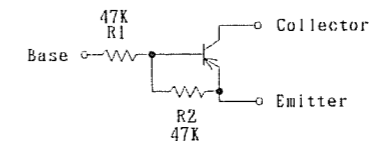

DTA144EU CIRCUIT DIAGRAM

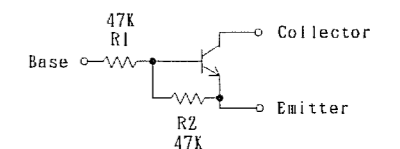

DTC144EU CIRCUIT DIAGRAM

Control Unit Parts List

REF.	DESCRIPTION	VALUE	WV	TOL.	MFGR'S DESIG	YAESU P/N	VERS.
*** CNTL UNIT ***							
	PCB With Components					CS1025002	TYP A1
	PCB With Components					CS1025003	TYP A2
	PCB With Components					CS1025004	TYP A3
	PCB With Components					CS1025005	TYP B1
	PCB With Components					CS1025006	TYP B3
	Printed Circuit Board					F3242000A	
BT2001	LITHIUM BATTERY				CR1220-VJ2H	Q9000554	
C 2001	CHIP CAP.	0.001uF	50V	B	GRM39B102M50PT	K22174809	
C 2002	CHIP CAP.	0.001uF	50V	B	GRM39B102M50PT	K22174809	
C 2003	CHIP CAP.	0.1uF	25V	B	GRM40B104M25PT	K22140811	
C 2004	TANTALUM CHIP CAP.	0.68uF	35V		TEMSVA1V684M-8R	K78160030	
C 2005	CHIP CAP.	0.01uF	25V	B	GRM39B103K25PT	K22144803	
C 2007	CHIP CAP.	100pF	50V	CH	GRM39CH101J50PT	K22174235	
C 2008	CHIP CAP.	120pF	50V	CH	GRM39CH121J50PT	K22174237	
C 2009	CHIP CAP.	0.001uF	50V	B	GRM39B102M50PT	K22174809	
C 2010	CHIP CAP.	0.1uF	25V	B	GRM40B104M25PT	K22140811	
C 2011	CHIP CAP.	0.001uF	50V	B	GRM39B102M50PT	K22174809	
C 2012	TANTALUM CHIP CAP.	4.7uF	6.3V		TEMSVA0J475M-8R	K78080017	
C 2013	CHIP CAP.	0.0047uF	50V	B	GRM39B472M50PT	K22174817	
C 2014	CHIP CAP.	0.001uF	50V	B	GRM39B102M50PT	K22174809	
C 2015	CHIP CAP.	0.001uF	50V	B	GRM39B102M50PT	K22174809	
C 2016	CHIP CAP.	0.001uF	50V	B	GRM39B102M50PT	K22174809	
C 2017	CHIP CAP.	0.001uF	50V	B	GRM39B102M50PT	K22174809	
C 2018	TANTALUM CHIP CAP.	15uF	6.3V		TEMSVB20J156M-8R	K78080023	
C 2019	TANTALUM CHIP CAP.	4.7uF	6.3V		TEMSVA0J475M-8R	K78080017	
C 2020	TANTALUM CHIP CAP.	4.7uF	6.3V		TEMSVA0J475M-8R	K78080017	
C 2021	CHIP CAP.	0.01uF	25V	B	GRM39B103K25PT	K22144803	
C 2022	CHIP CAP.	0.1uF	25V	B	GRM40B104M25PT	K22140811	
C 2023	CHIP CAP.	0.1uF	25V	B	GRM40B104M25PT	K22140811	
C 2024	CHIP CAP.	0.1uF	25V	B	GRM40B104M25PT	K22140811	
C 2025	CHIP CAP.	100pF	50V	CH	GRM39CH101J50PT	K22174235	
C 2026	CHIP CAP.	0.1uF	25V	B	GRM40B104M25PT	K22140811	
C 2027	CHIP CAP.	0.01uF	25V	B	GRM39B103K25PT	K22144803	
C 2028	TANTALUM CHIP CAP.	4.7uF	6.3V		TEMSVA0J475M-8R	K78080017	
C 2029	CHIP CAP.	0.001uF	50V	B	GRM39B102M50PT	K22174809	
C 2030	CHIP CAP.	0.001uF	50V	B	GRM39B102M50PT	K22174809	
C 2031	CHIP CAP.	0.1uF	25V	B	GRM40B104M25PT	K22140811	
C 2032	CHIP CAP.	0.01uF	25V	B	GRM39B103K25PT	K22144803	
C 2033	CHIP CAP.	0.022uF	25V	B	GRM40B223K25PT	K22140812	
C 2034	CHIP CAP.	0.1uF	25V	B	GRM40B104M25PT	K22140811	
C 2035	CHIP CAP.	0.01uF	25V	B	GRM39B103K25PT	K22144803	
C 2036	CHIP CAP.	0.001uF	50V	B	GRM39B102M50PT	K22174809	
C 2037	CHIP CAP.	0.022uF	25V	B	GRM40B223K25PT	K22140812	
C 2038	CHIP CAP.	0.0022uF	50V	B	GRM39B222K50PT	K22174822	
C 2039	CHIP CAP.	0.001uF	50V	B	GRM39B102M50PT	K22174809	
C 2040	CHIP CAP.	0.1uF	25V	B	GRM40B104M25PT	K22140811	
C 2042	CHIP CAP.	2.2uF	16V		EMK316F225Z00T	K22122001	
C 2043	CHIP CAP.	0.001uF	50V	B	GRM39B102M50PT	K22174809	
C 2044	CHIP CAP.	0.001uF	50V	B	GRM39B102M50PT	K22174809	
C 2045	CHIP CAP.	0.001uF	50V	B	GRM39B102M50PT	K22174809	

REF.	DESCRIPTION	VALUE	WV	TOL.	MFGR'S DESIG	YAESU P/N	VERS.
Q 2010	TRANSISTOR				DTC124TU T106	G3070065	
Q 2011	TRANSISTOR				2SC4215Y TE85R	G3342157Y	
Q 2012	IC				UPD74HC4094G-T2	G1091222	
Q 2013	TRANSISTOR				2SD1368CB TL	G3413688B	
Q 2014	IC				TC4S81F TE85R	G1090895	
R 2001	CHIP RES.	12K	1/16W		RMC1/16 123JATP	J24185123	
R 2002	CHIP RES.	6. 8K	1/16W		RMC1/16 682JATP	J24185682	
R 2003	CHIP RES.	1M	1/16W		RMC1/16 105JATP	J24185105	
R 2004	CHIP RES.	33K	1/16W		RMC1/16 333JATP	J24185333	
R 2005	CHIP RES.	22K	1/16W		RMC1/16 223JATP	J24185223	
R 2006	CHIP RES.	22K	1/16W		RMC1/16 223JATP	J24185223	
R 2007	CHIP RES.	0	1/16W		RMC1/16 000JATP	J24185000	
R 2008	CHIP RES.	22K	1/16W		RMC1/16 223JATP	J24185223	
R 2009	CHIP RES.	22K	1/16W		RMC1/16 223JATP	J24185223	
R 2010	CHIP RES.	4. 7K	1/16W		RMC1/16 472JATP	J24185472	
R 2011	CHIP RES.	470	1/16W		RMC1/16 471JATP	J24185471	
R 2012	CHIP RES.	220	1/16W		RMC1/16 221JATP	J24185221	
R 2013	CHIP RES.	220K	1/16W		RMC1/16 224JATP	J24185224	
R 2014	CHIP RES.	100K	1/16W		RMC1/16 104JATP	J24185104	
R 2015	CHIP RES.	1M	1/16W		RMC1/16 105JATP	J24185105	
R 2016	CHIP RES.	22K	1/16W		RMC1/16 223JATP	J24185223	
R 2017	CHIP RES.	10K	1/16W		RMC1/16 103JATP	J24185103	
R 2018	CHIP RES.	22K	1/16W		RMC1/16 223JATP	J24185223	
R 2019	CHIP RES.	47K	1/16W		RMC1/16 473JATP	J24185473	
R 2020	CHIP RES.	2. 2K	1/16W		RMC1/16 222JATP	J24185222	
R 2021	CHIP RES.	22K	1/16W		RMC1/16 223JATP	J24185223	
R 2022	CHIP RES.	4. 7K	1/16W		RMC1/16 472JATP	J24185472	
R 2023	CHIP RES.	100	1/16W		RMC1/16 101JATP	J24185101	
R 2024	CHIP RES.	1. 5K	1/16W		RMC1/16 152JATP	J24185152	
R 2025	CHIP RES.	22K	1/16W		RMC1/16 223JATP	J24185223	
R 2026	CHIP RES.	5. 6K	1/16W		RMC1/16 562JATP	J24185562	
R 2027	CHIP RES.	47K	1/16W		RMC1/16 473JATP	J24185473	
R 2028	CHIP RES.	100K	1/16W		RMC1/16 104JATP	J24185104	
R 2029	CHIP RES.	22K	1/16W		RMC1/16 223JATP	J24185223	
R 2030	CHIP RES.	470	1/16W		RMC1/16 471JATP	J24185471	
R 2031	CHIP RES.	470K	1/16W		RMC1/16 474JATP	J24185474	
R 2032	CHIP RES.	4. 7K	1/16W		RMC1/16 472JATP	J24185472	
R 2033	CHIP RES.	150K	1/16W		RMC1/16 154JATP	J24185154	
R 2034	CHIP RES.	33K	1/16W		RMC1/16 333JATP	J24185333	
R 2035	CHIP RES.	10K	1/16W		RMC1/16 103JATP	J24185103	
R 2036	CHIP RES.	3. 3K	1/16W		RMC1/16 332JATP	J24185332	
R 2037	CHIP RES.	120K	1/16W		RMC1/16 124JATP	J24185124	
R 2038	CHIP RES.	150K	1/16W		RMC1/16 154JATP	J24185154	
R 2039	CHIP RES.	10K	1/16W		RMC1/16 103JATP	J24185103	
R 2040	CHIP RES.	4. 7K	1/16W		RMC1/16 472JATP	J24185472	
R 2041	CHIP RES.	22K	1/16W		RMC1/16 223JATP	J24185223	
R 2042	CHIP RES.	33K	1/16W		RMC1/16 333JATP	J24185333	
R 2043	CHIP RES.	3. 3K	1/16W		RMC1/16 332JATP	J24185332	
R 2044	CHIP RES.	330K	1/16W		RMC1/16 334JATP	J24185334	
R 2045	CHIP RES.	2. 2M	1/16W		RMC1/16 225JATP	J24185225	
R 2046	CHIP RES.	220	1/16W		RMC1/16 221JATP	J24185221	
R 2047	CHIP RES.	100K	1/16W		RMC1/16 104JATP	J24185104	
R 2048	CHIP RES.	3. 3M	1/16W		RMC1/16 335JATP	J24185335	
R 2049	CHIP RES.	470	1/16W		RMC1/16 471JATP	J24185471	

Control Unit Board Layout

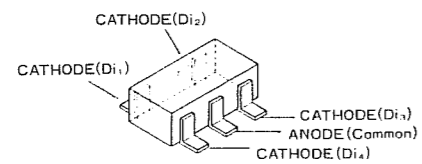
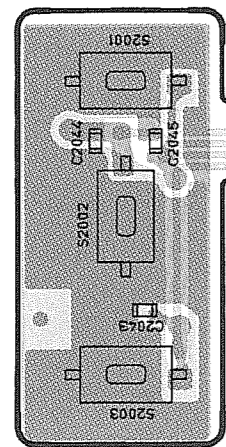
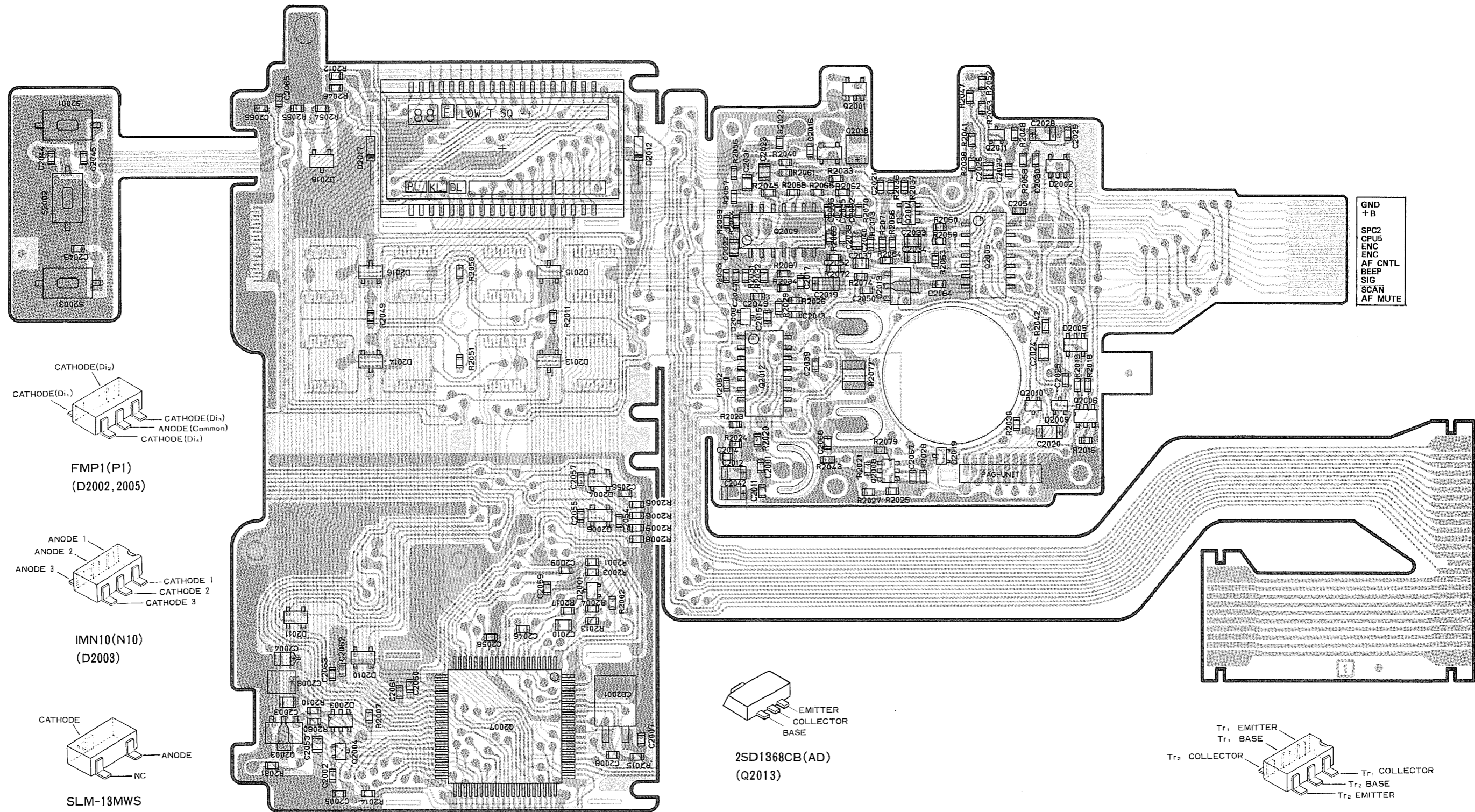

FMP1 (P1)
(D2002, 2005)

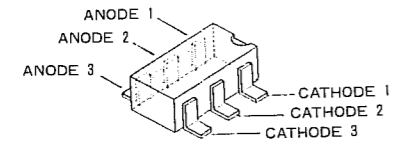

IMN10 (N10)
(D2003)

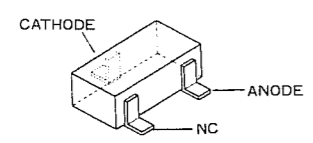

SLM-13MWS
(D2013, 2014, 2015)
2016

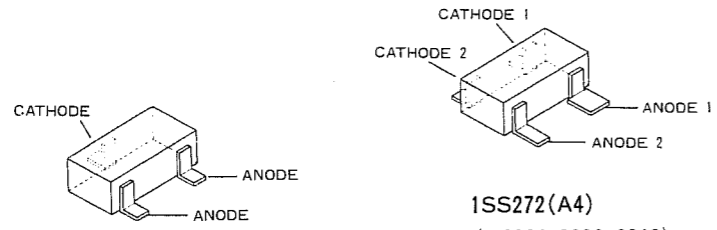

1SS272 (A4)
(D2004, 2006, 2010)
2011
1SS319 (A4)
(D2007)

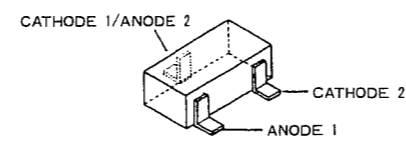

1SS302 (C3)
(D2001, 2009)

DAN202U (N) DAP202U (P)
(D2008) (D2019)
SLM-23VMWS
(D2018)

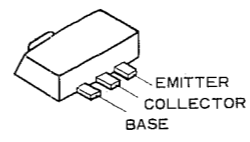

2SD1368CB (AD)
(Q2013)

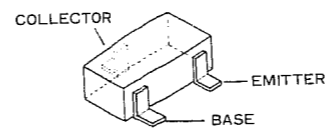

DTA124EU (15)
(Q2004)
DTC124TU (05)
(Q2010)
2SC4215Y (QY)
(Q2011)

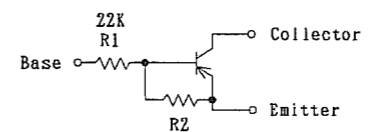

DTA124EU CIRCUIT DIAGRAM

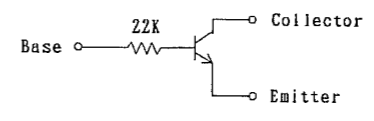

DTC124TU CIRCUIT DIAGRAM

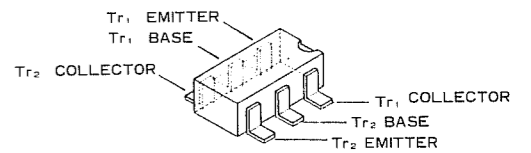

IMZ1 (Z1)
(Q2006, 2008)

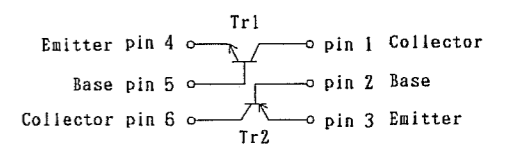

IMZ1 CIRCUIT DIAGRAM

- GND
- +B
- SPC2
- CPU5
- ENC
- ENC
- AF CNTL
- BEEP
- SIG
- SCAN
- AF MUTE

Control Unit Schematic Diagram

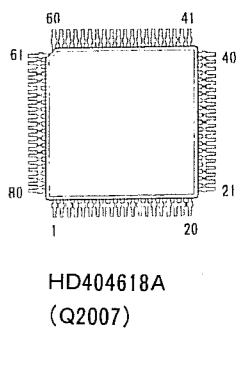
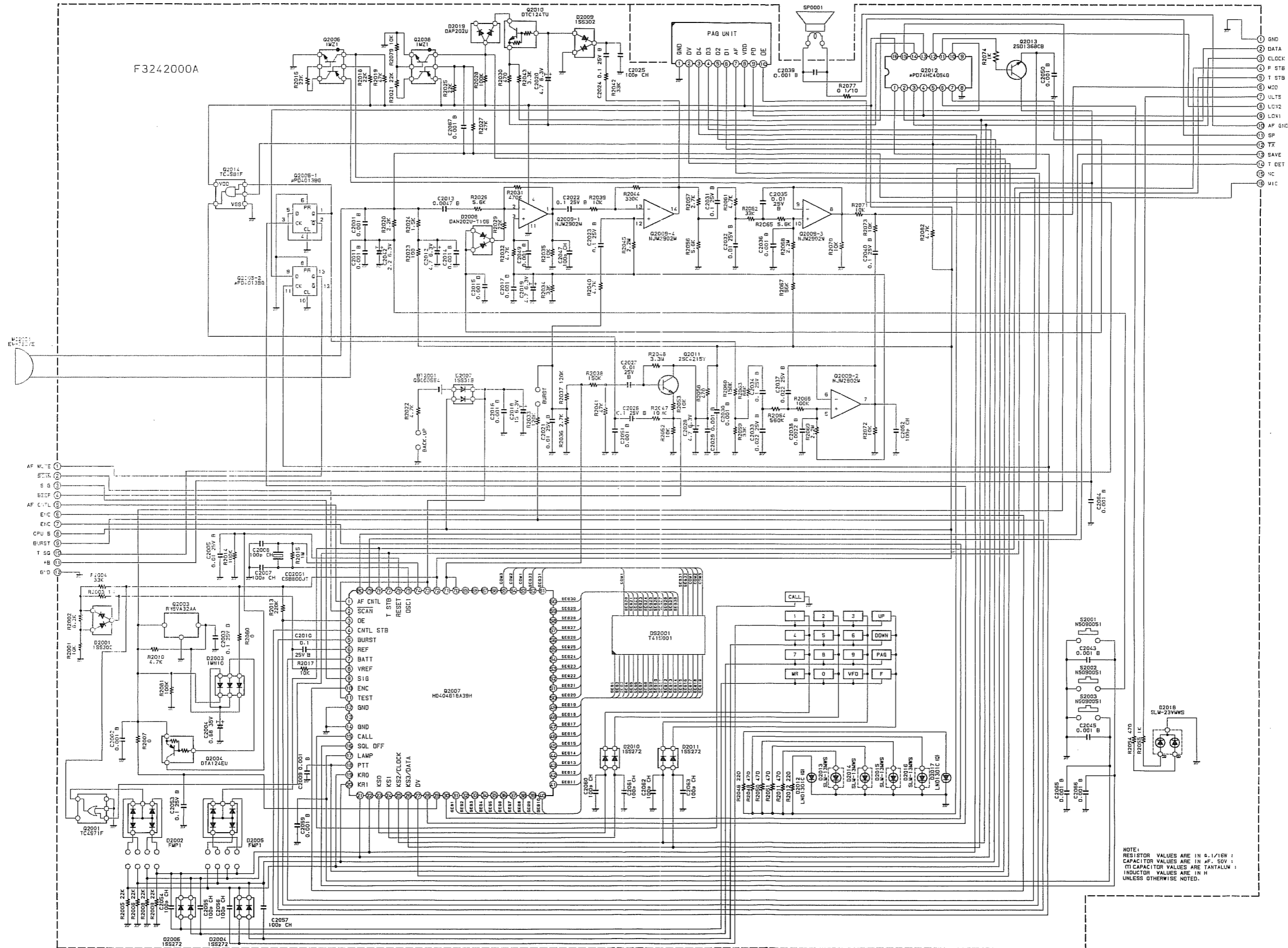

HD404618A
(Q2007)

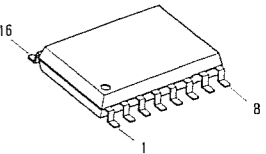

μPD74HC4094G
(Q2012)

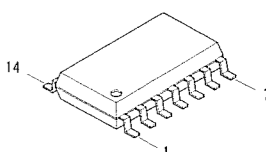

μPD4013BG
(Q2005)
NJM2902M
(Q2009)

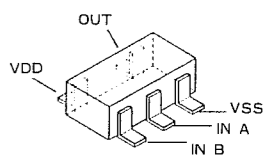

TC4571F (C4)
(Q2001)
TC4581F (C2)
(Q2014)

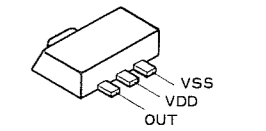

RH5VA32AA (C2)
(Q2003)

NOTE:
RESISTOR VALUES ARE IN Ω, 1/16W;
CAPACITOR VALUES ARE IN μF, 50V;
(T) CAPACITOR VALUES ARE TANTALUM;
INDUCTOR VALUES ARE IN H
UNLESS OTHERWISE NOTED.

IF Unit Parts List

REF.	DESCRIPTION	VALUE	WV	TOL.	MFR'S DESIG	YAESU P/N	VERS.
*** IF UNIT ***							
	PCB With Components					CA0647003	TYP A2
	PCB With Components					CA0647004	TYP A3
	PCB With Components					CA0647005	TYP B1
	PCB With Components					CA0647006	TYP B3
	PCB With Components					CA0647008	TYP A1
	Printed Circuit Board					F3213102F	
C 3003	CHIP CAP.	0.01uF	25V	B	GRM39B103M25PT	K22144802	
C 3004	CHIP CAP.	100pF	50V	CH	GRM39CH101J50PT	K22174235	
C 3006	CHIP CAP.	0.01uF	25V	B	GRM39B103M25PT	K22144802	
C 3007	CHIP CAP.	0.01uF	25V	B	GRM39B103M25PT	K22144802	
C 3009	CHIP CAP.	56pF	50V	CH	GRM39CH560J50PT	K22174229	
C 3010	CHIP CAP.	120pF	50V	CH	GRM39CH121J50PT	K22174237	
C 3011	TANTALUM CHIP CAP.	4.7uF	6.3V		TEMSVA0J475M-8R	K78080017	
C 3012	CHIP CAP.	0.022uF	25V	B	GRM40B223K25PT	K22140812	
C 3013	CHIP CAP.	0.001uF	50V	B	GRM39B102M50PT	K22174809	
C 3014	CHIP CAP.	0.01uF	25V	B	GRM39B103M25PT	K22144802	
C 3015	CHIP CAP.	0.1uF	25V	B	GRM40B104M25PT	K22140811	
C 3016	CHIP CAP.	82pF	50V	CH	GRM39CH820J50PT	K22174233	
C 3017	CHIP CAP.	82pF	50V	CH	GRM39CH820J50PT	K22174233	
C 3018	AL. ELECTRO. CAP.	100uF	10V		RC3-10V101M	K40109030	
C 3019	TANTALUM CHIP CAP.	47uF	6.3V		F950J476MFCAF1	K78080013	
C 3020	CHIP CAP.	0.1uF	25V	B	GRM40B104M25PT	K22140811	
C 3021	CHIP CAP.	100pF	50V	CH	GRM39CH101J50PT	K22174235	
C 3022	CHIP CAP.	0.01uF	25V	B	GRM39B103M25PT	K22144802	
C 3023	CHIP CAP.	0.1uF	25V	B	GRM40B104M25PT	K22140811	
C 3024	CHIP CAP.	0.1uF	25V	B	GRM40B104M25PT	K22140811	
C 3025	CHIP CAP.	0.01uF	25V	B	GRM39B103M25PT	K22144802	
C 3026	CHIP CAP.	0.001uF	50V	B	GRM39B102M50PT	K22174809	
C 3027	CHIP CAP.	0.01uF	25V	B	GRM39B103M25PT	K22144802	
C 3028	CHIP CAP.	0.0018uF	50V	B	GRM39B182M50PT	K22174812	
C 3029	CHIP CAP.	0.001uF	50V	B	GRM39B102M50PT	K22174809	
C 3030	CHIP CAP.	0.0018uF	50V	B	GRM39B182M50PT	K22174812	
C 3031	CHIP CAP.	0.1uF	25V	B	GRM40B104M25PT	K22140811	
C 3032	TANTALUM CHIP CAP.	4.7uF	6.3V		TEMSVA0J475M-8R	K78080017	
C 3033	CHIP CAP.	0.1uF	25V	B	GRM40B104M25PT	K22140811	
C 3035	TANTALUM CHIP CAP.	4.7uF	6.3V		TEMSVA0J475M-8R	K78080017	
C 3036	AL. ELECTRO. CAP.	100uF	10V		RC3-10V101M	K40109030	
C 3037	CHIP CAP.	0.047uF	50V	F	GRM40F473Z50PT	K22171008	
C 3039	CHIP CAP.	0.1uF	25V	B	GRM40B104M25PT	K22140811	
C 3040	CHIP CAP.	0.1uF	25V	B	GRM40B104M25PT	K22140811	
C 3042	CHIP CAP.	0.0047uF	50V	B	GRM40B472M50PT	K22170813	
C 3043	CHIP CAP.	0.1uF	25V	B	GRM40B104M25PT	K22140811	
C 3044	TANTALUM CHIP CAP.	1uF	16V		TESVA1C105M1-8R	K78120009	
C 3045	CHIP CAP.	0.001uF	50V	B	GRM39B102M50PT	K22174809	
C 3046	CHIP CAP.	0.0047uF	50V	B	GRM39B472M50PT	K22174817	
C 3047	CHIP CAP.	0.0047uF	50V	B	GRM39B472M50PT	K22174817	
C 3048	CHIP CAP.	0.001uF	50V	B	GRM39B102M50PT	K22174809	
C 3049	CHIP CAP.	0.01uF	25V	B	GRM39B103M25PT	K22144802	
C 3050	CHIP CAP.	0.01uF	25V	B	GRM39B103M25PT	K22144802	
C 3051	CHIP CAP.	0.022uF	50V	B	GRM40B223M50PT	K22170821	
C 3052	CHIP CAP.	0.001uF	50V	B	GRM39B102M50PT	K22174809	

REF.	DESCRIPTION	VALUE	WV	TOL.	MFGR'S DESIG	YAESU P/N	VERS.
R 3030	CHIP RES.	150K	1/16W		RMC1/16 154JATP	J24185154	
R 3031	CHIP RES.	15K	1/16W		RMC1/16 153JATP	J24185153	
R 3032	CHIP RES.	22K	1/16W		RMC1/16 223JATP	J24185223	
R 3033	CHIP RES.	2.2K	1/16W		RMC1/16 222JATP	J24185222	
R 3034	CHIP RES.	2.2M	1/16W		RMC1/16 225JATP	J24185225	
R 3035	CHIP RES.	4.7	1/16W		RMC1/16 4R7JATP	J24185479	
R 3036	CHIP RES.	10K	1/16W		RMC1/16 103JATP	J24185103	
R 3037	CHIP RES.	47K	1/16W		RMC1/16 473JATP	J24185473	
R 3042	CHIP RES.	470K	1/16W		RMC1/16 474JATP	J24185474	
R 3043	CHIP RES.	4.7K	1/16W		RMC1/16 472JATP	J24185472	
R 3044	CHIP RES.	22K	1/16W		RMC1/16 223JATP	J24185223	
R 3045	CHIP RES.	220K	1/16W		RMC1/16 224JATP	J24185224	
R 3046	CHIP RES.	10K	1/16W		RMC1/16 103JATP	J24185103	
R 3047	CHIP RES.	150	1/16W		RMC1/16 151JATP	J24185151	
R 3048	CHIP RES.	100K	1/16W		RMC1/16 104JATP	J24185104	
R 3049	CHIP RES.	100K	1/16W		RMC1/16 104JATP	J24185104	
R 3050	CHIP RES.	10K	1/16W		RMC1/16 103JATP	J24185103	
R 3051	CHIP RES.	10K	1/16W		RMC1/16 103JATP	J24185103	
R 3052	CHIP RES.	270K	1/16W		RMC1/16 274JATP	J24185274	
R 3056	CHIP RES.	330	1/16W		RMC1/16 331JATP	J24185331	
R 3057	CHIP RES.	470K	1/16W		RMC1/16 474JATP	J24185474	
R 3058	CHIP RES.	2.7K	1/16W		RMC1/16 272JATP	J24185272	
R 3059	CHIP RES.	56K	1/16W		RMC1/16 563JATP	J24185563	
R 3060	CHIP RES.	100K	1/16W		RMC1/16 104JATP	J24185104	
R 3061	CHIP RES.	5.6K	1/16W		RMC1/16 562JATP	J24185562	
VR3001	POT.	220K			RH03AYAJ5X	J51778224	
X 3001	XTAL	17.245MHz				H0102986	
	XTAL HOLDER					R3129530	

IF Unit Board Layout

YAESU P/N VERS.

IF UNIT(No.30××)

- J24185154
- J24185153
- J24185223
- J24185222
- J24185225
- J24185479
- J24185103
- J24185473
- J24185474
- J24185223
- J24185224
- J24185103
- J24185151
- J24185104
- J24185104
- J24185103
- J24185103
- J24185274
- J24185331
- J24185474
- J24185272
- J24185563
- J24185104
- J24185562

- J51778224
- H0102986
- R3129530

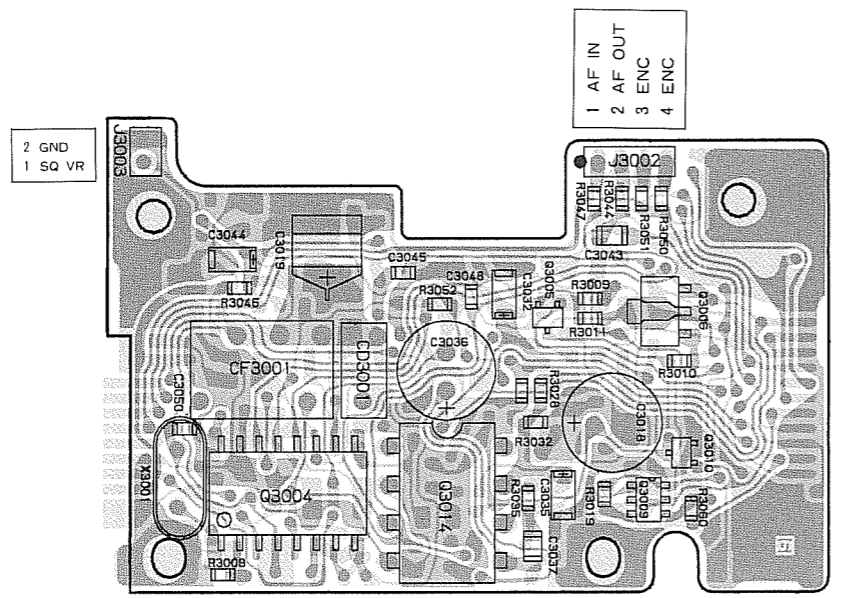

obverse view of "component" side

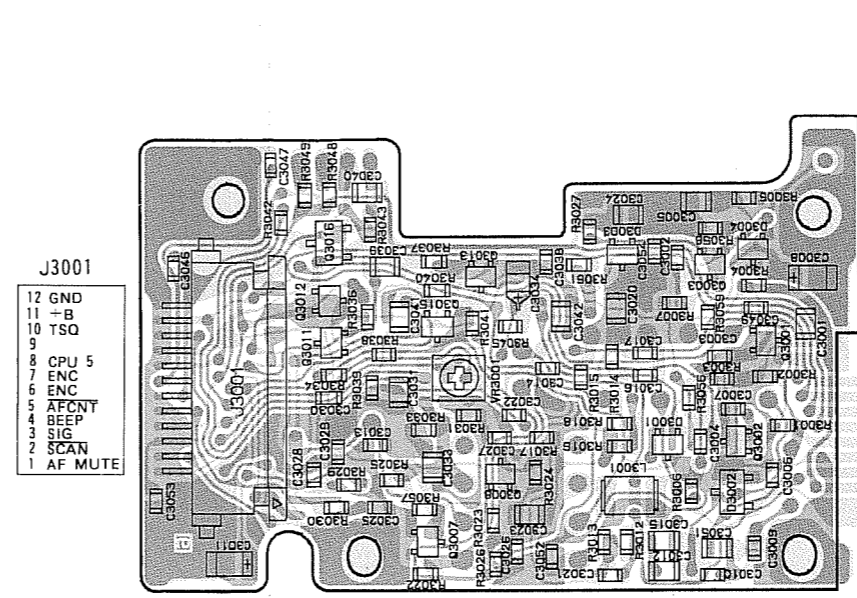

obverse view of "chip-only" side

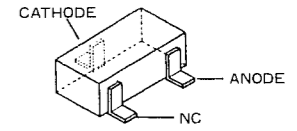

1SS294 (A9)
(D3002)

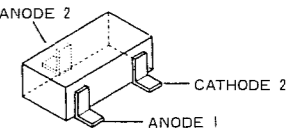

1SS302 (C3)
(D3001, 3003, 3004)

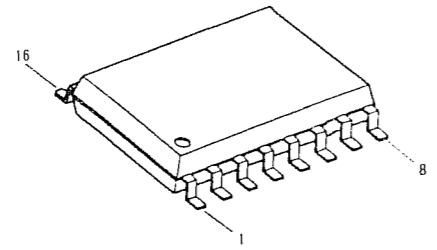

MC3372ML
(Q3004)

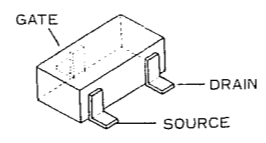

2SJ125D (JD)
(Q3016)

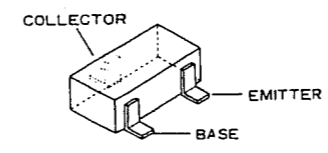

DTC144EU (26)
(Q3003, 3010, 3013)
2SC4116GR (LG)
(Q3005, 3007, 3011)
2SC4215Y (QY)
(Q3002)

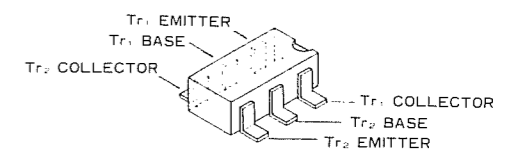

IMD2 (D2)
(Q3009)

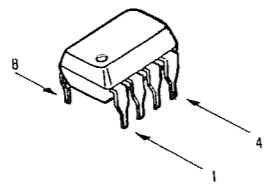

NJM386BD
(Q3014)

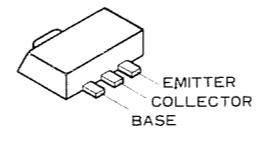

2SB799 (ML)
(Q3006)

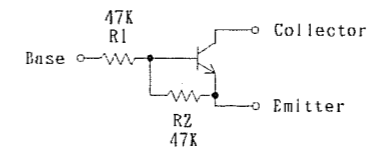

DTC144EU CIRCUIT DIAGRAM

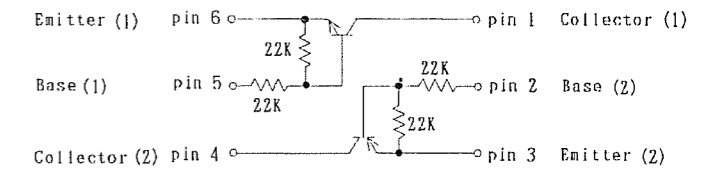

IMD2 CIRCUIT DIAGRAM

IF Unit Schematic Diagram

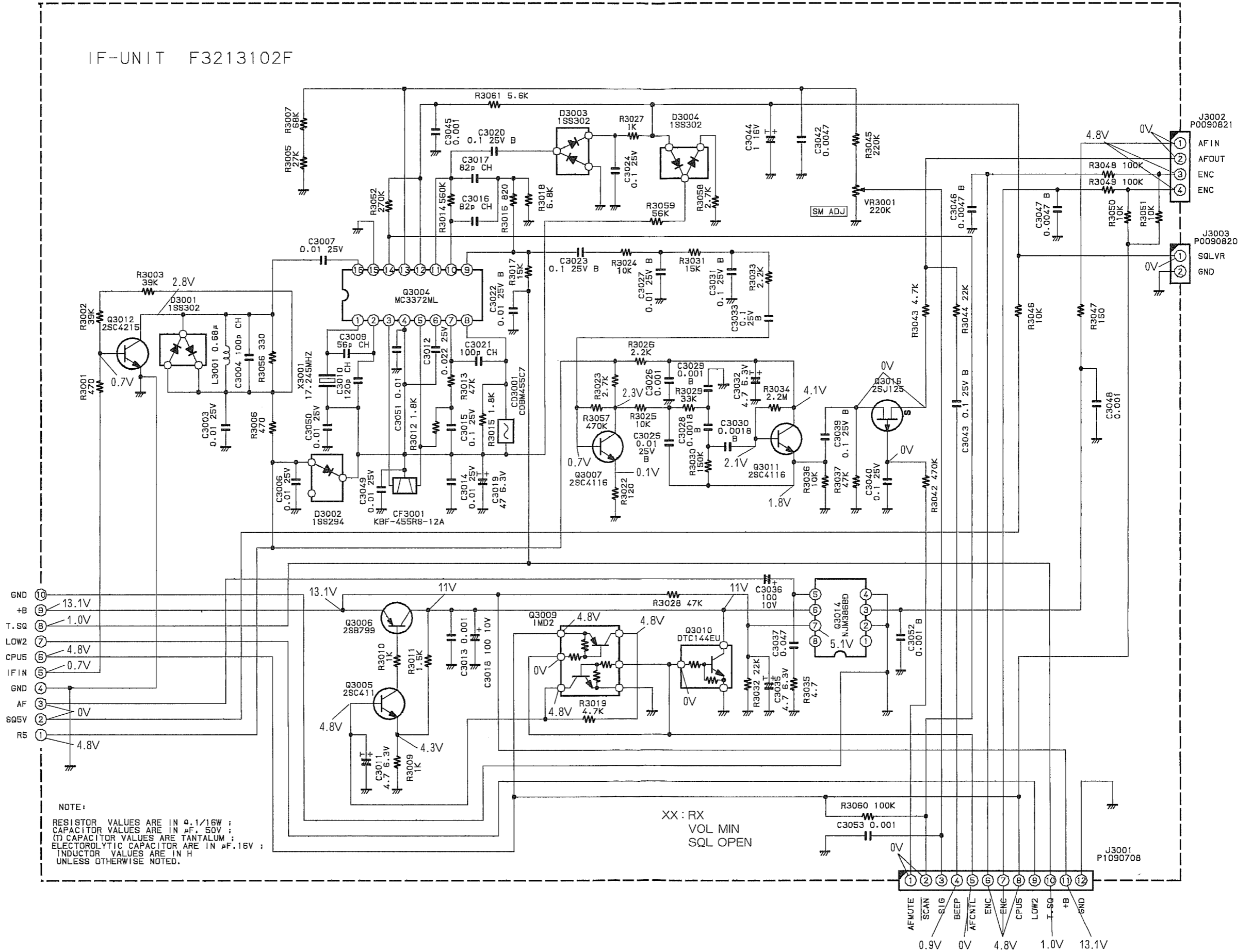

APC Unit Parts List

REF.	DESCRIPTION	VALUE	WV	TOL.	MFGR'S DESIG	YAESU P/N	VERS.
*** APC UNIT ***							
	PCB With Components					CA0646001	
	Printed Circuit Board					F3243102	
C 4001	CHIP CAP.	0.001uF	50V	B	GRM39B102M50PT	K22174809	
C 4002	TANTALUM CHIP CAP.	1uF	16V		F951C105MRAAF1Q2	K78120013	
C 4003	CHIP CAP.	0.047uF	50V	F	GRM40F473Z50PT	K22171008	
C 4004	CHIP CAP.	0.001uF	50V	B	GRM39B102M50PT	K22174809	
J 4001	CONNECTOR				9230B-1-09Z009-T	P0090657	
Q 4001	TRANSISTOR				2SB799-T2ML	G3207997L	
Q 4002	TRANSISTOR				2SC4116GR TE85R	G3341167G	
Q 4003	TRANSISTOR				2SA1586Y TE85R	G3115867Y	
Q 4004	TRANSISTOR				FMS1 T98	G3070008	
Q 4005	TRANSISTOR				DTC124TU T106	G3070065	
Q 4006	TRANSISTOR				FMW1 T98	G3070009	
Q 4007	TRANSISTOR				2SB799-T2ML	G3207997L	
Q 4008	TRANSISTOR				DTC144EU T107	G3070041	
R 4001	CHIP RES.	3.3K	1/16W		RMC1/16 332JATP	J24185332	
R 4002	CHIP RES.	1K	1/16W		RMC1/16 102JATP	J24185102	
R 4003	CHIP RES.	22K	1/16W		RMC1/16 223JATP	J24185223	
R 4004	CHIP RES.	220K	1/16W		RMC1/16 224JATP	J24185224	
R 4005	CHIP RES.	1K	1/16W		RMC1/16 102JATP	J24185102	
R 4006	CHIP RES.	8.2K	1/16W		RMC1/16 822JATP	J24185822	
R 4007	CHIP RES.	12K	1/16W		RMC1/16 123JATP	J24185123	
R 4008	CHIP RES.	100K	1/16W		RMC1/16 104JATP	J24185104	
R 4009	CHIP RES.	10K	1/16W		RMC1/16 103JATP	J24185103	
R 4010	CHIP RES.	2.7K	1/16W		RMC1/16 272JATP	J24185272	
R 4012	CHIP RES.	3.3K	1/16W		RMC1/16 332JATP	J24185332	
R 4013	CHIP RES.	1K	1/16W		RMC1/16 102JATP	J24185102	
R 4014	CHIP RES.	10K	1/16W		RMC1/16 103JATP	J24185103	
R 4015	CHIP RES.	1K	1/16W		RMC1/16 102JATP	J24185102	

APC Unit Board Layout & Schematic Diagram

VERS.

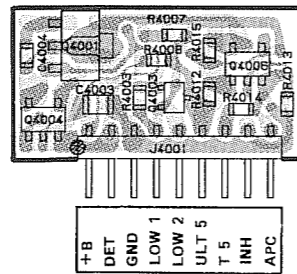

obverse view of "component" side

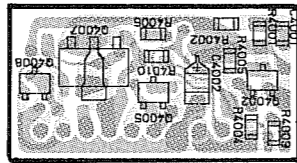

obverse view of "chip-only" side

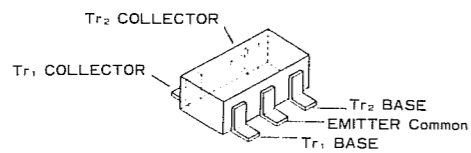
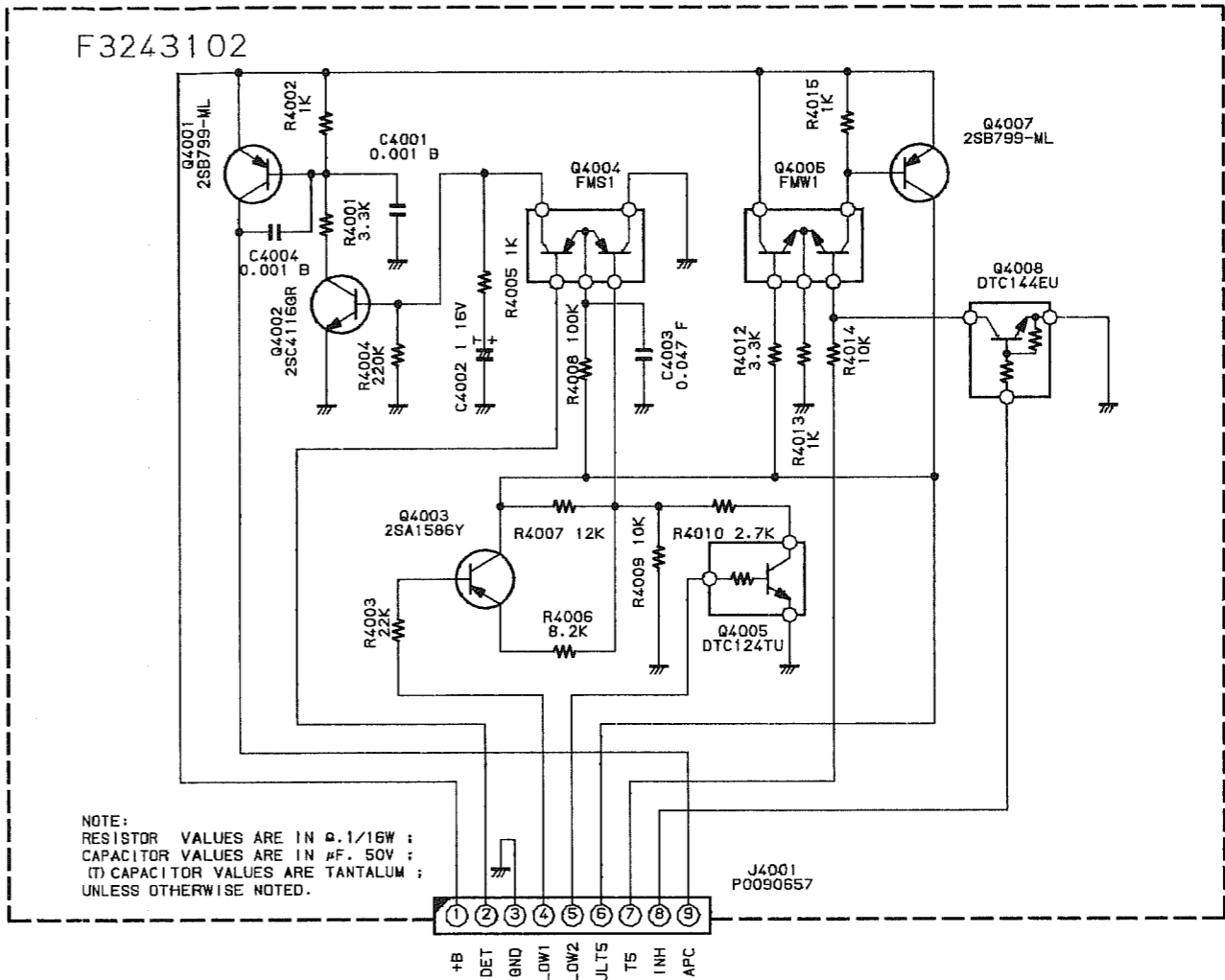

FMW1(W1)
(Q4006)
FMS1(S1)
(Q4004)

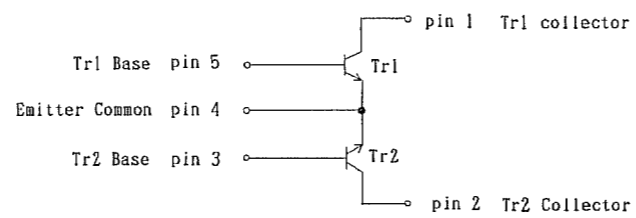

FMW1 CIRCUIT DIAGRAM

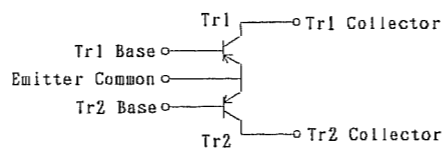

FMS1 CIRCUIT DIAGRAM

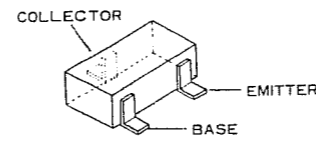

DTC144EU(26)
(Q4008)
DTC124TU(05)
(Q4005)
2SC4116GR(LG)
(Q4002)
2SA1586Y(SY)
(Q4003)

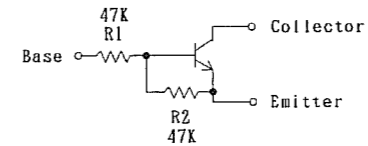

DTC144EU CIRCUIT DIAGRAM

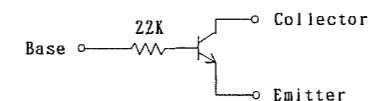

DTC124TU CIRCUIT DIAGRAM

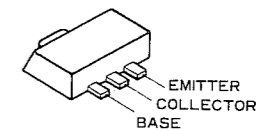

2SB799(ML)
(Q4001, 4007)

VR Unit Parts List

REF.	DESCRIPTION	VALUE	WV	TOL.	MFGR'S DESIG	YAESU P/N	VERS.
*** VR UNIT ***							
	PCB With Components					CS1026001	
	Printed Circuit Board					F3243102	
S 5001	ROTARY CODE S.W.				EC09P20-04	Q9000442	
VR5001	POT.	20K		A/SW	RK097	J60800173	
VR5002	POT.	50K		B	RK0971110	J60800174	
	SPECIAL NUT					R6054381B	

VR Unit Board Layout & Schematic Diagram

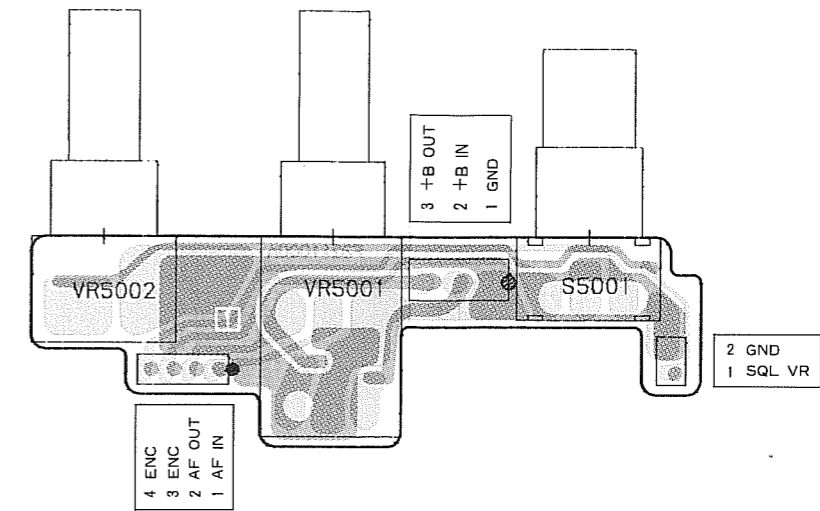

obverse view of "component" side

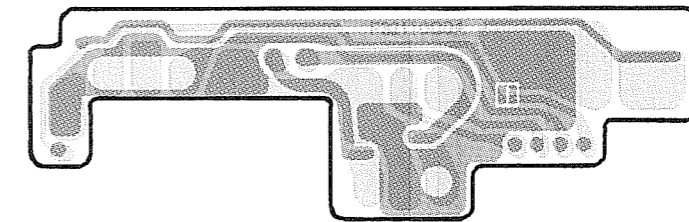

obverse view of "solder" side

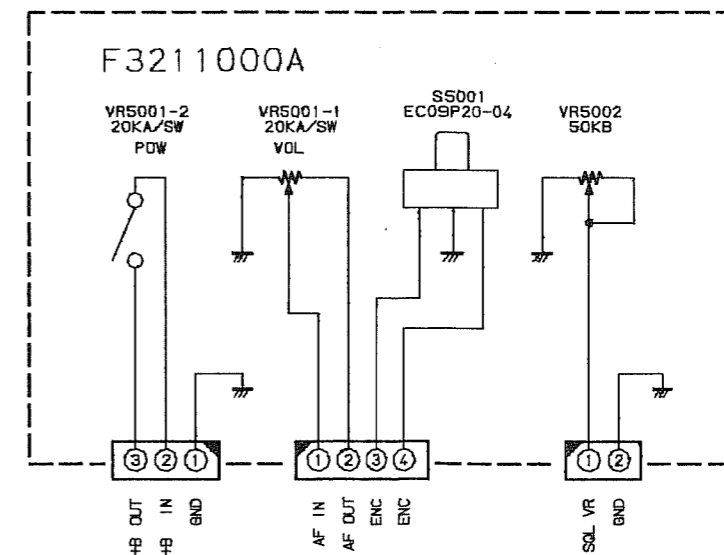

PLL Unit Parts List

REF.	DESCRIPTION	VALUE	WV	TOL.	MFGR'S DESIG	YAESU P/N	VERS.
*** PLL UNIT ***							
	PCB With CLOCK UNIT					CP3361003	TYP A1
	PCB With CLOCK UNIT					CP3361004	TYP A2
	PCB With CLOCK UNIT					CP3361005	TYP A3
	PCB With CLOCK UNIT					CP3361006	TYP B1
	PCB With CLOCK UNIT					CP3361007	TYP B3
	Printed Circuit Board					F3243101	
C 6001	CHIP CAP.	0.001uF	50V	B	GRM39B102M50PT	K22174809	
C 6002	CHIP CAP.	0.001uF	50V	B	GRM39B102M50PT	K22174809	
C 6003	CHIP CAP.	0.001uF	50V	B	GRM39B102M50PT	K22174809	
C 6004	CHIP CAP.	0.01uF	25V	B	GRM39B103K25PT	K22144803	
C 6005	CHIP CAP.	220pF	50V	CH	GRM39CH221J50PT	K22174243	
C 6006	CHIP CAP.	18pF	50V	CH	GRM39CH180J50PT	K22174217	
C 6007	CHIP CAP.	27pF	50V	CH	GRM39CH270J50PT	K22174221	
C 6008	CHIP CAP.	0.5pF	50V	CK	GRM39CK0R5C50PT	K22174201	
C 6009	CHIP CAP.	10pF	50V	CH	GRM39CH100D50PT	K22174211	
C 6010	CHIP CAP.	0.001uF	50V	B	GRM39B102M50PT	K22174809	
C 6011	CHIP CAP.	5pF	50V	CH	GRM39CH050C50PT	K22174206	
C 6012	TANTALUM CHIP CAP.	4.7uF	6.3V		TEMSVAOJ475M-8R	K78080017	
C 6013	CHIP CAP.	3pF	50V	CJ	GRM39CJ030C50PT	K22174204	
C 6014	CHIP CAP.	12pF	50V	CH	GRM39CH120J50PT	K22174213	
C 6015	CHIP CAP.	0.001uF	50V	B	GRM39B102M50PT	K22174809	
C 6016	CHIP CAP.	0.001uF	50V	B	GRM39B102M50PT	K22174809	
C 6017	CHIP CAP.	33pF	50V	CH	GRM39CH330J50PT	K22174223	
C 6018	CHIP CAP.	27pF	50V	CH	GRM39CH270J50PT	K22174221	
C 6019	CHIP CAP.	0.5pF	50V	CK	GRM39CK0R5C50PT	K22174201	
C 6020	CHIP CAP.	22pF	50V	CH	GRM39CH220J50PT	K22174219	
C 6021	CHIP CAP.	1pF	50V	CK	GRM39CK010C50PT	K22174202	
C 6022	CHIP CAP.	10pF	50V	CH	GRM39CH100D50PT	K22174211	
C 6023	CHIP CAP.	270pF	50V	B	GRM39B271M50PT	K22174802	
C 6024	CHIP CAP.	0.001uF	50V	B	GRM39B102M50PT	K22174809	
C 6025	CHIP CAP.	0.001uF	50V	B	GRM39B102M50PT	K22174809	
C 6026	CHIP CAP.	0.001uF	50V	B	GRM39B102M50PT	K22174809	
C 6027	CHIP CAP.	0.001uF	50V	B	GRM39B102M50PT	K22174809	
C 6028	CHIP CAP.	470pF	50V	B	GRM39B471M50PT	K22174805	
C 6029	CHIP CAP.	0.001uF	50V	B	GRM39B102M50PT	K22174809	
D 6001	DIODE				HVU306A5TRF	G2070132	
D 6002	DIODE				HVU306A5TRF	G2070132	
D 6003	DIODE				HVU306A5TRF	G2070132	
D 6004	DIODE				HVU306A5TRF	G2070132	
D 6005	DIODE				1SS300 TE85R	G2070084	
J 6001	CONNECTOR				9230B-1-03Z003-T	P0090702	
J 6002	CONNECTOR				9230B-1-06Z009-T	P0090675	
J 6003	CONNECTOR				9230B-1-06Z009-T	P0090675	
J 6004	CONNECTOR				9230B-1-03Z003-T	P0090702	
L 6001	CHIP COIL	0.056uH			LQN2A56NM	L1690008	
L 6002	M. RFC	1uH			LER015T1ROM	L1690119	
L 6003	M. RFC	1uH			LER015T1ROM	L1690119	

PLL Unit Board Layout & Schematic Diagram

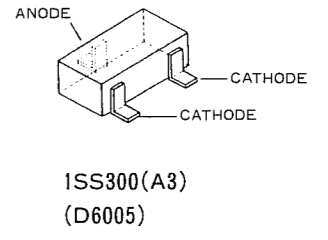
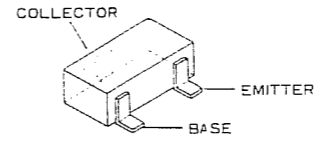
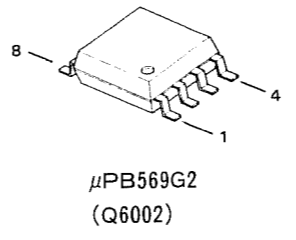
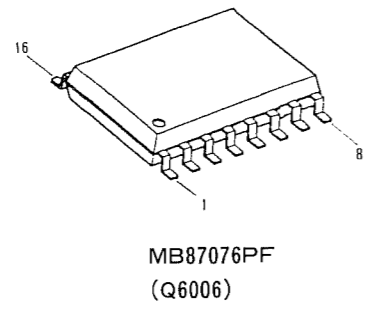
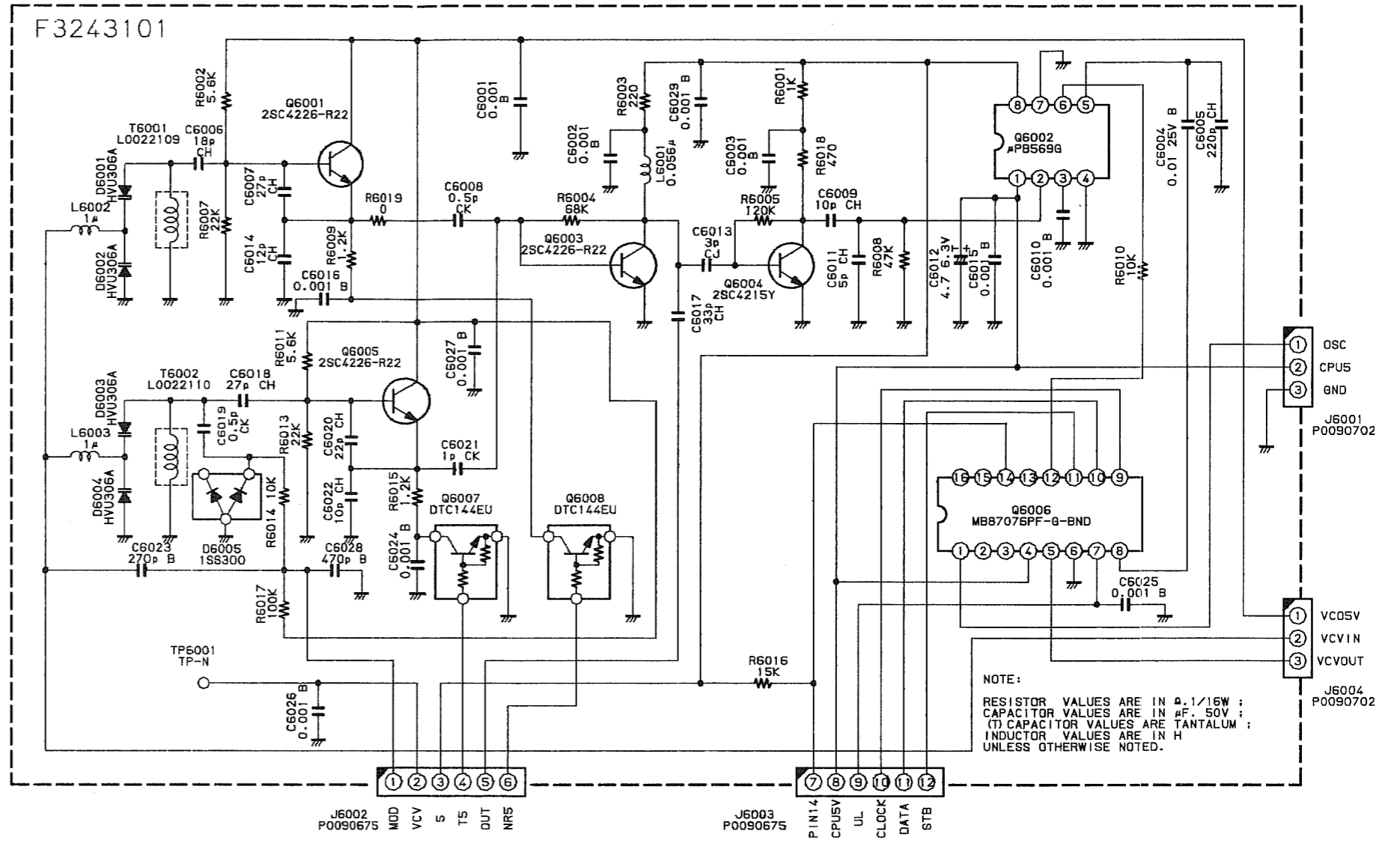
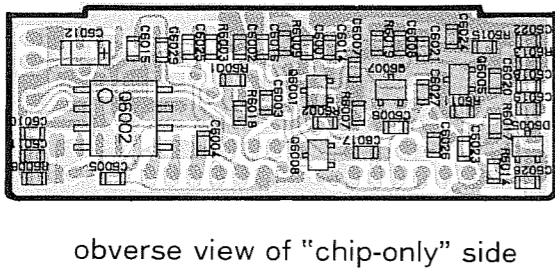
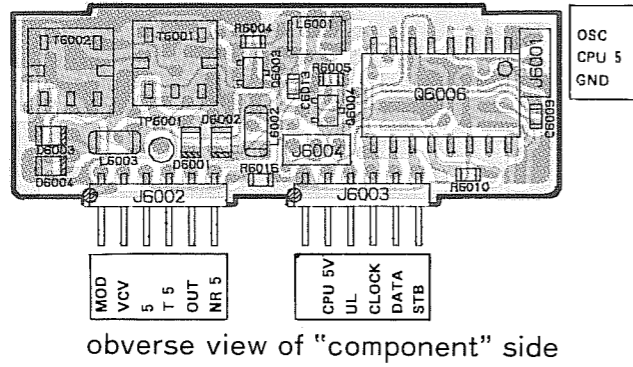

2SC4226(R22)
(Q6001, 6003, 6005)
2SC4215Y(QY)
(Q6004)

Clock Unit Parts List

REF.	DESCRIPTION	VALUE	WV	TOL.	MFR'S DESIG	YAESU P/N	VERS.
*** CLOCK UNIT ***							
	PCB With Components					CP3362001	
	Printed Circuit Board					F3249101A	
C 7001	CHIP CAP.	0.01uF	25V	B	GRM39B103M25PT	K22144802	
C 7002	TANTALUM CHIP CAP.	4.7uF	6.3V		TEMSVA0J475M-8R	K78080017	
C 7003	CHIP CAP.	0.001uF	50V	B	GRM39B102M50PT	K22174809	
C 7004	TANTALUM CHIP CAP.	4.7uF	6.3V		TEMSVA0J475M-8R	K78080017	
C 7005	CHIP CAP.	0.01uF	25V	B	GRM39B103M25PT	K22144802	
C 7006	CHIP CAP.	0.001uF	50V	B	GRM39B102M50PT	K22174809	
C 7007	CHIP CAP.	150pF	50V	CH	GRM39CH151J50PT	K22174239	
C 7008	CHIP CAP.	27pF	50V	CH	GRM39CH270J50PT	K22174221	
C 7009	CHIP CAP.	27pF	50V	CH	GRM39CH270J50PT	K22174221	
C 7010	CHIP CAP.	150pF	50V	CH	GRM39CH151J50PT	K22174239	
C 7011	TANTALUM CHIP CAP.	0.33uF	35V		TESVA1V334M1-8R	K78160028	
C 7012	CHIP CAP.	0.1uF	25V	B	GRM40B104M25PT	K22140811	
C 7014	TANTALUM CHIP CAP.	2.2uF	20V		TESVB21D225M8R	K78130010	
Q 7001	TRANSISTOR				2SC4116GR TE85R	G3341167G	
Q 7002	TRANSISTOR				2SC4116GR TE85R	G3341167G	
Q 7003	FET				2SK880GR TE85R	G3808807G	
R 7001	CHIP RES.	100	1/16W		RMC1/16 101JATP	J24185101	
R 7002	CHIP RES.	4.7K	1/16W		RMC1/16 472JATP	J24185472	
R 7003	CHIP RES.	1M	1/16W		RMC1/16 105JATP	J24185105	
R 7004	CHIP RES.	4.7K	1/16W		RMC1/16 472JATP	J24185472	
R 7005	CHIP RES.	4.7K	1/16W		RMC1/16 472JATP	J24185472	
R 7006	CHIP RES.	1K	1/16W		RMC1/16 102JATP	J24185102	
R 7007	CHIP RES.	3.3K	1/16W		RMC1/16 332JATP	J24185332	
R 7008	CHIP RES.	100K	1/16W		RMC1/16 104JATP	J24185104	
R 7009	CHIP RES.	2.2K	1/16W		RMC1/16 222JATP	J24185222	
TC7001	TRIMMER CAP.	20pF			ECR-JA020E12X	K91000151	
X 7001	XTAL	12.800MHz				H0102911	
	XTAL HOLDER					R3129530	

Clock Unit Board Layout & Schematic Diagram

CLOCK UNIT (No. 70 x x)

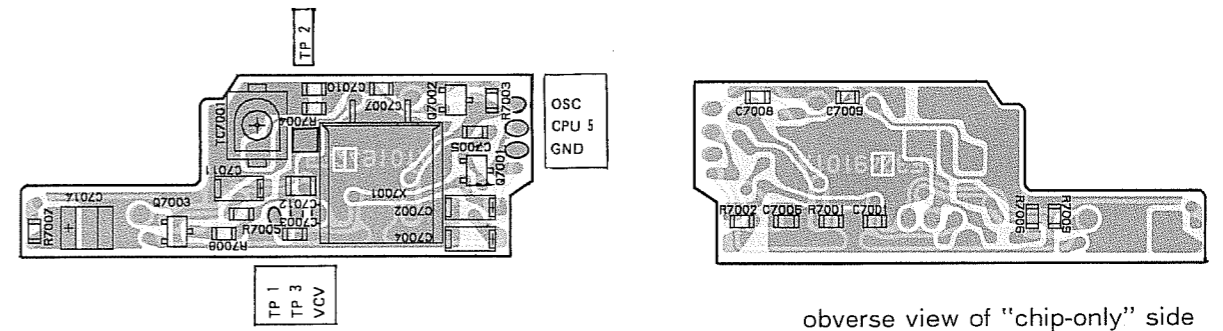

obverse view of "component" side

obverse view of "chip-only" side

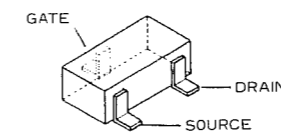

2SK880GR(XG)
(Q7003)

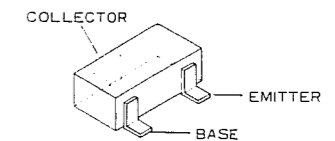

2SC4116GR(LG)
(Q7001, 7002)

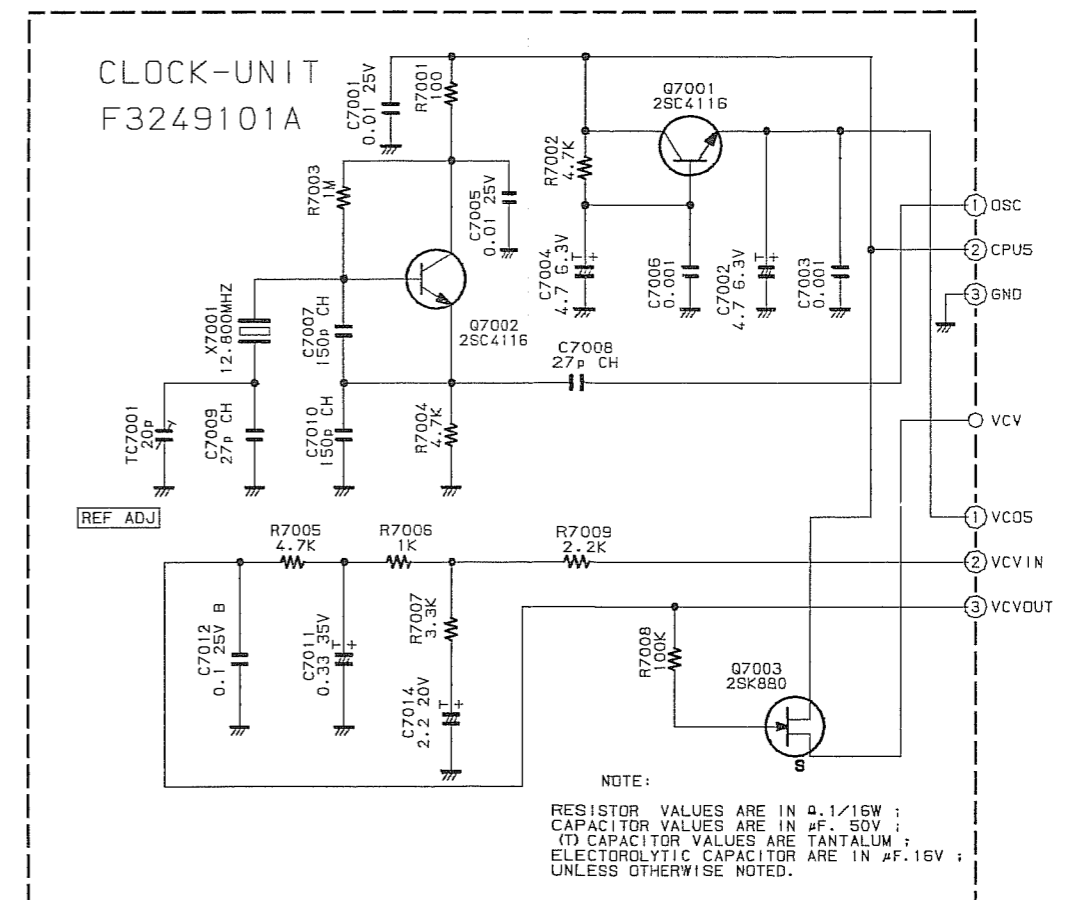

Pager Unit Parts List

REF.	DESCRIPTION	VALUE	WV	TOL.	MFGR'S DESIG	YAESU P/N	VERS.
*** PAG UNIT ***							
PCB With Components						CA0609001	
Printed Circuit Board						F3237101	
C 8001	CHIP CAP.	0.01uF	25V	B	GRM39B103M25PT	K22144802	
C 8002	CHIP CAP.	0.1uF	25V	B	GRM40B104M25PT	K22140811	
C 8003	CHIP CAP.	33pF	50V	CH	GRM39CH330J50PT	K22174223	
C 8004	CHIP CAP.	33pF	50V	CH	GRM39CH330J50PT	K22174223	
C08001	CERAMIC OSC				CSA3.58MG	H7900510	
Q 8001	IC				TC35305F-11 TP2	G1091177	
R 8001	CHIP RES.	22K	1/16W		RMC1/16 223JATP	J24185223	

Pager Unit Board Layout & Schematic Diagram

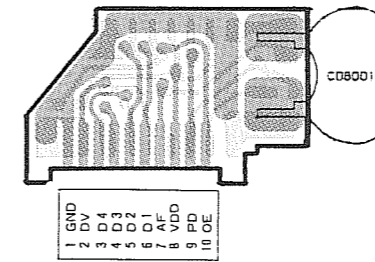

obverse view of "component" side

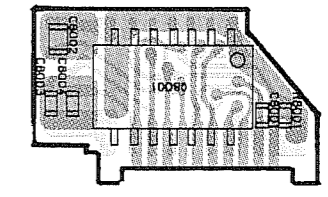

obverse view of "chip-only" side

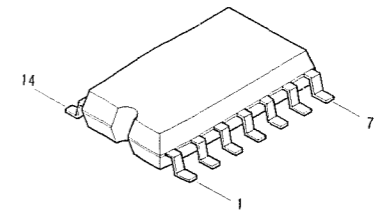

TC35305F
(Q8001)

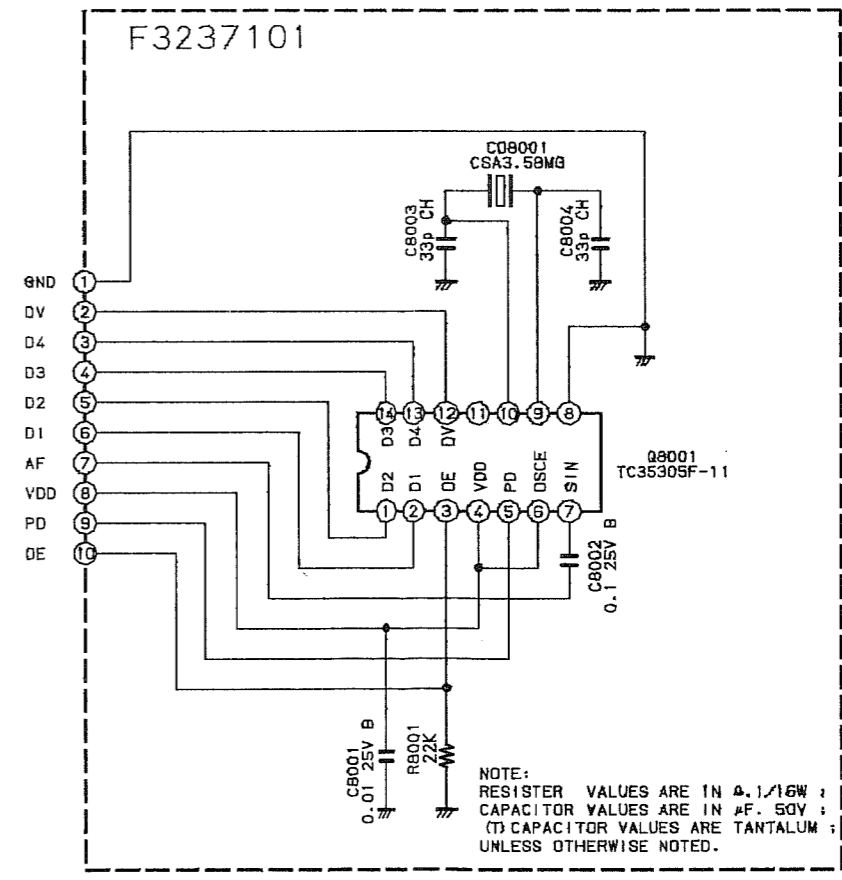

FTS - 17A Tone Squelch Unit Installation

The FTS-17A is a subaudible CTCSS (Continuous Tone-Controlled Squelch System) Encoder/Decoder, which offers programmable selection of 38 tones for transmission, and matching filter/detectors for reception. Transmit-only ("T", or encode) and transmit/receive ("T SQ", or encode/decode) modes are selectable from keys on the transceiver. Operation is described in the Operating Manual.

- Make sure the transceiver is off. Remove the hard or soft case, if used, and the battery pack.
- Remove the four screws affixing the battery mounting plate on the bottom of the transceiver and carefully lift and then rotate the plate 180°.
- Locate 10-pin connector J1003 inside the bottom of the transceiver, and press the FTS-17A onto it as shown below, solder side out.

Replace the battery mounting plate and its four screws, and the battery pack.

CTCSS Tone Frequencies (Hz)			
67.0	100.0	141.3	203.5
71.9	103.5	146.2	210.1
74.4	107.2	151.4	218.1
77.0	110.9	156.7	225.7
79.7	114.8	162.2	233.6
82.5	118.8	167.9	241.8
85.4	123.0	173.8	250.3
88.5	127.3	179.9	—
91.5	131.8	186.2	—
94.8	136.5	192.8	—

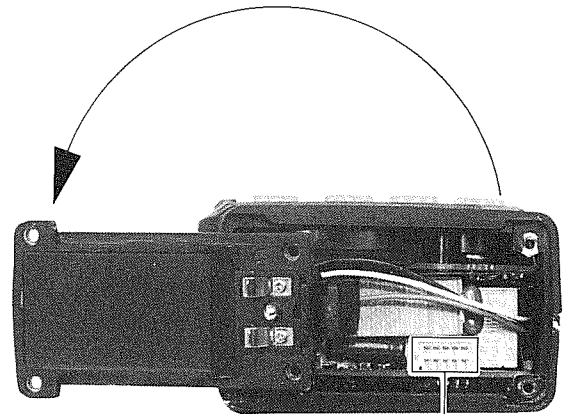
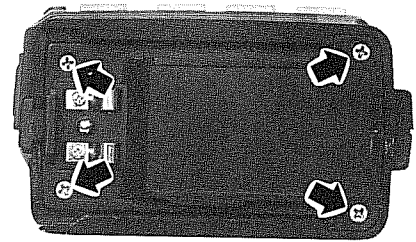

10-pin Connector

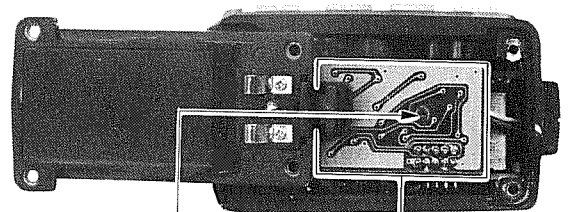

VR101

FTS-17A

FTS - 17A Board Layout & Schematic Diagram

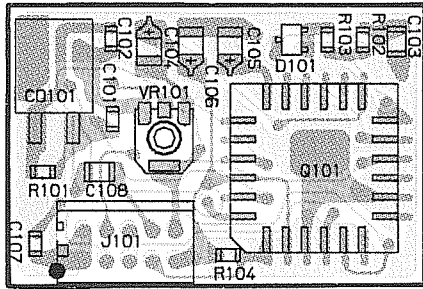

J101

1	GND
2	GND
3	CLOCK
4	TDDET
5	DATA
6	T5
7	TSTB
8	TSQ1
9	CPU5
10	TONE

obverse view of "component" side

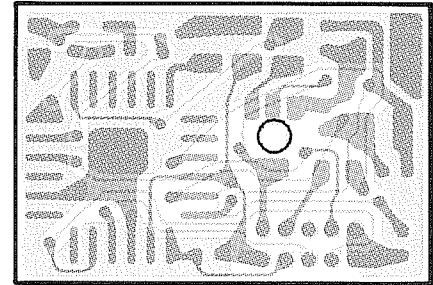

obverse view of "solder" side

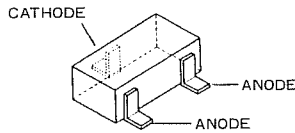

1SS301
(D0101)

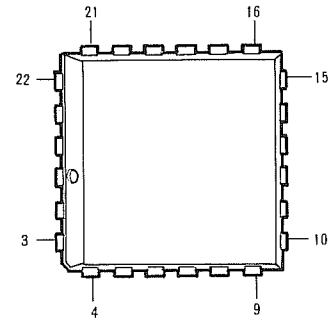

MX365LH
(Q0101)

F3220100

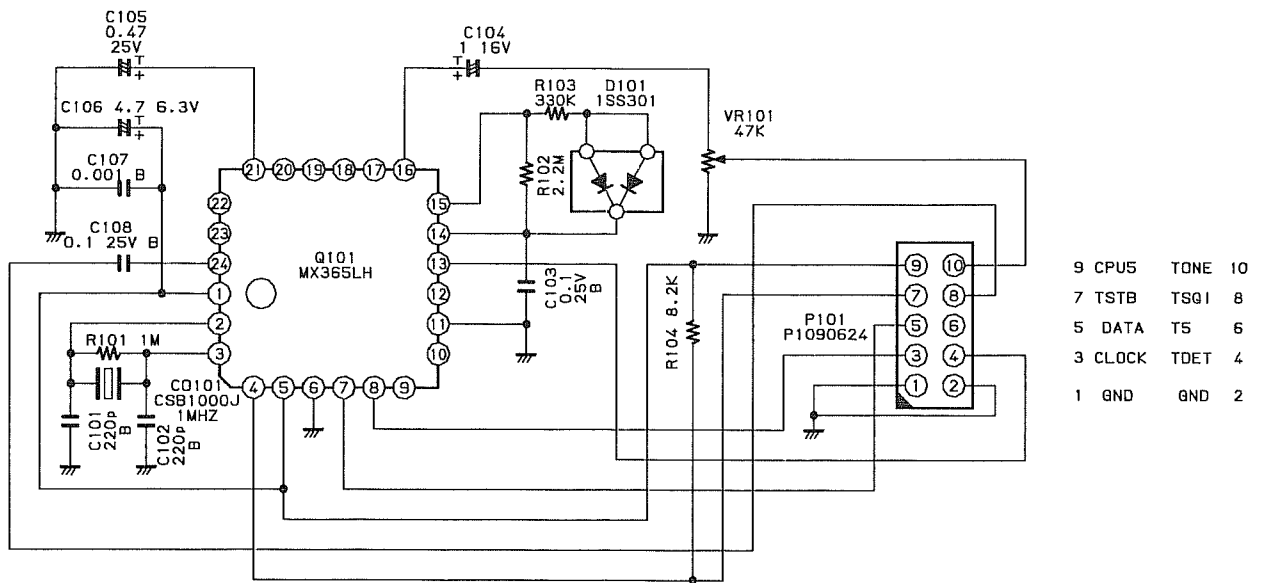

NOTE:
RESISTOR VALUES ARE IN Ω/16W ;
CAPACITOR VALUES ARE IN μF. 50V ;
(T) CAPACITOR VALUES ARE TANTALUM ;
UNLESS OTHERWISE NOTED.

9	CPU5	TONE	10
7	TSTB	TSQ1	8
5	DATA	T5	6
3	CLOCK	TDDET	4
1	GND	GND	2

Contents

1. Hardware Information

Case Disassembly & PCB Access	1-1
Exploded View	1-2
Packing	1-3
Exploded View (FT-416)	1-5

2. Chip Component Information

2-1

3. Circuit Description

3-1

4. Alignment

4-1

5. PCB Circuitry

Block Diagram	5-1
Mother Unit Parts List	5-2
Mother Unit Board Layout	5-6
Mother Unit Schematic Diagram	5-7
Control(CNTL) Unit Parts List	5-8
Control(CNTL) Unit Board Layout	5-12
Control(CNTL) Unit Schematic Diagram	5-13
IF Unit Parts List	5-14
IF Unit Board Layout	5-16
IF Unit Schematic Diagram	5-17
APC Unit Parts List, Board Layout & Schematic Diagram	5-18
VR Unit Parts List, Board Layout & Schematic Diagram	5-19
PLL Unit Parts List	5-20
PLL Unit Board Layout & Schematic Diagram	5-22
Clock Unit Parts List, Board Layout & Schematic Diagram	5-23
Pager(PAG) Unit Parts List, Board Layout & Schematic Diagram	5-24

6. FTS-17A Tone Squelch Unit(Option)

Installation	6-1
Parts List	6-2
Board Layout & Circuit Diagram	6-3

Exploded View

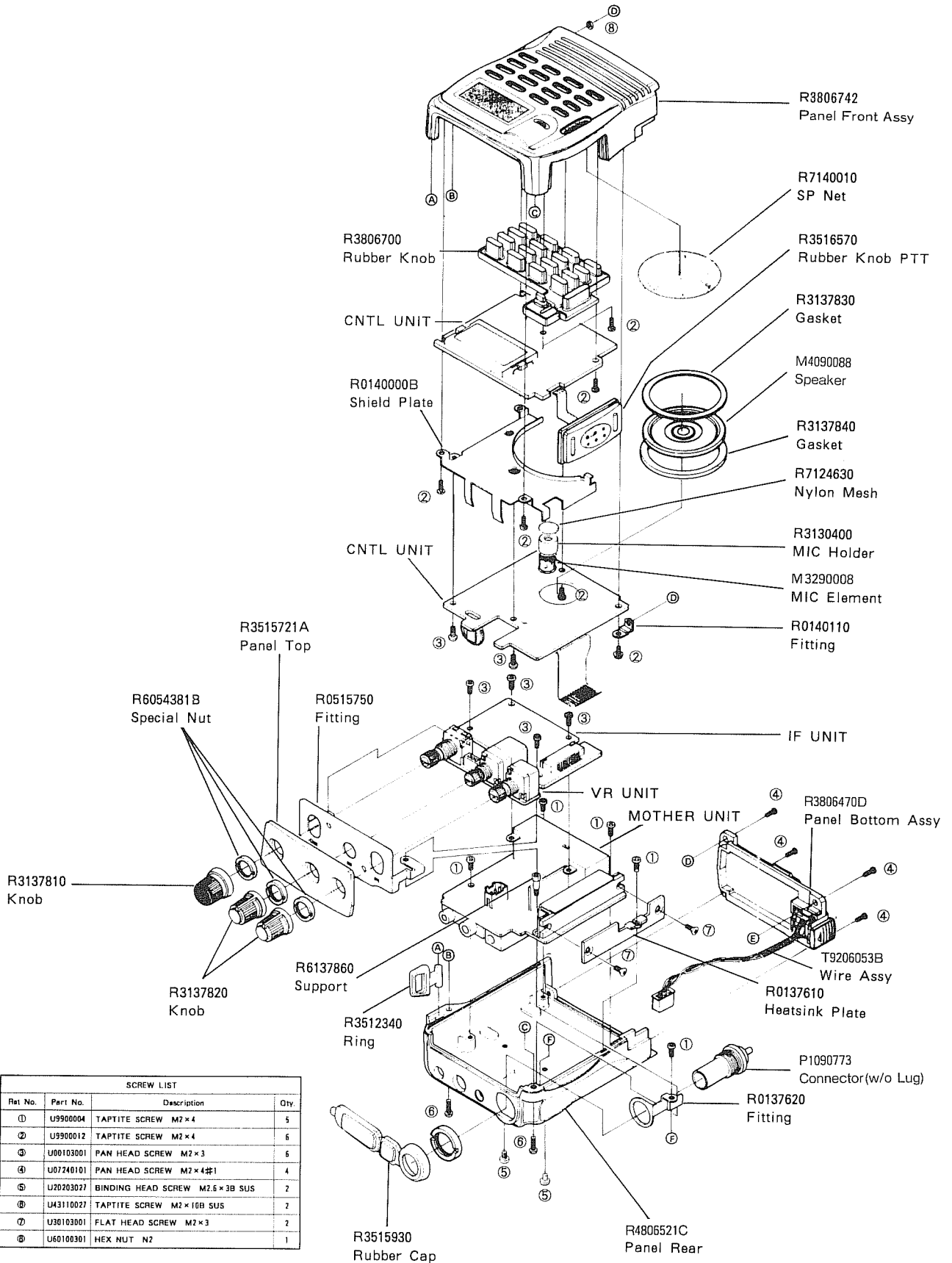

SCREW LIST			
Ref. No.	Part No.	Description	Qty.
①	U9900004	TAPTITE SCREW M2×4	5
②	U9900012	TAPTITE SCREW M2×4	6
③	U00103001	PAN HEAD SCREW M2×3	6
④	U07240101	PAN HEAD SCREW M2×4#1	4
⑤	U20203027	BINDING HEAD SCREW M2.6×3B SUS	2
⑥	U43110027	TAPTITE SCREW M2×10B SUS	2
⑦	U30103001	FLAT HEAD SCREW M2×3	2
⑧	U60100301	HEX NUT N2	1

Notes

adjustments may require more complex adjustments afterwards. Do not attempt to perform only a single step unless it is clearly isolated electrically from all other steps. Rather, have all test equipment ready before beginning, and follow all steps in a section in the order presented.

Required Test Equipment

- RF Signal Generator with calibrated output level at 200 MHz
- Deviation Meter (linear detector, with 300-Hz ~ 3-kHz BPF)
- AF Millivoltmeter
- SINAD Meter
- Inline Wattmeter with 5% accuracy at 200 MHz
- Regulated DC Power Supply adjustable from 5 to 13V, 2 A, with milliammeter (0 to 2000 mA)
- 50-Ω Dummy Load: 10 W at 200 MHz
- Freq. Counter: ± 0.2 -ppm accuracy at 200 MHz
- AF Signal Generator
- DC Voltmeter: high impedance
- VHF Sampling Coupler

Alignment Preparation & Precautions

A 50-Ω dummy load and inline wattmeter must be connected to the main antenna jack in all procedures that call for transmission, except where specified otherwise. Correct alignment is not possible with an antenna.

After completing one step, read the following step to determine whether the same test equipment will be required. If not, remove the test equipment (except dummy load and wattmeter, if connected) before proceeding.

Correct alignment requires that the transceiver and test equipment be at the same temperature as the surrounding air, which should be held constant between 20 and 30 °C (68 ~ 86 °F). When the transceiver is brought into the shop from hot or cold air it should be allowed some time for thermal equalization with the environment before alignment.

Alignments must only be made with oscillator shields and circuit boards firmly affixed in place. Also, the test equipment must be thoroughly warmed up before beginning.

Note: Signal levels in dB referred to in the alignment procedure are based on 0 dB μ = 0.5 dB μ V.

PLL & Transmitter

Set up the test equipment as shown here for transmitter alignment. Maintain the supply voltage at 12.0 V for all steps.

PLL & Transmitter Alignment Setup

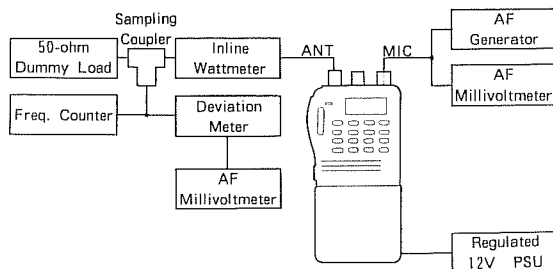

PLL VCV (Varactor Control Voltage) & Ref. Osc.

- Connect the positive lead of the DC voltmeter to the test point on the PLL Unit, and the negative lead to chassis ground.
- Tune the transceiver to 145.000 MHz and adjust TC7001 for 145 MHz \pm 100 Hz on the counter.
- Tune the transceiver to 144.000 MHz, key the transmitter, and adjust transformer T6001 on the VCO Unit for 0.7 \pm 0.05V on the voltmeter.
- Return to receive, and adjust T6002 for 1.1 \pm 0.05V on the meter.
- Retune to the frequency indicated below for the version being aligned, and confirm the indicated receive and transmit VCV on the meter.

Version	Frequency	Tx VCV	Rx VCV
A1 & B2	148 MHz	<1.2V	<1.8V
B1	146 MHz	<1V	<1.5V

Transmitter Output Power

- Tune to the center of the band (145 or 146 MHz), and select the high power setting (press **F|J** \rightarrow **3/LOW**, and then **3/LOW** again, if necessary).
- Key the transmitter and adjust VR1002 on the Mother Board for peak on the wattmeter (at least 5.5W with less than 1.7A supply current).
- Press **F|J** \rightarrow **3/LOW** again and select each of the low settings, confirming the output and display indicated below.

Low Selection	RF Output	Bargraph Segments
L1	0.3 ~ 1W	3
L2	1.3 ~ 2W	6
L3	2.5 ~ 3.5W	9

- Select the **L1** low power setting, and transmit at the low and high band edges to confirm transmitter output between 0.2 and 1W.

Notes

Transmit Signal Path

Speech input from the microphone is delivered to the Control Unit for amplification and pre-emphasis by Q2009 (NJM2902M- $\frac{1}{4}$). To prevent over-deviation, the audio is processed by IDC (instantaneous deviation control) stage Q2009- $\frac{4}{4}$, and then lowpass filtered by Q2009- $\frac{3}{4}$ before delivery to the modulator on the VCO Unit. If an external microphone is used, PTT switching is controlled by Q2008 (1MZ1), which signals the microprocessor when the impedance at the microphone jack drops. If VOX is enabled, a sample of the output of the IDC stage is used to activate the transmitter via Q2010 (DTC124TU).

If Tone Burst or DTMF is enabled for transmission, the tone is generated by microprocessor Q2007 and mixed with transmitter audio at the IDC stage. Also, the tone is passed via Q2011 (2SC4215Y) to the Motherboard for output to the loudspeaker, as mentioned above. The microprocessor also disables microphone input to Q2009 via Q2012 and D2008, and modulator input via Q1003 (DTC144EU) when transmission is disabled.

The modulating audio is delivered via modulation level trimmer VR1001 on the Motherboard to diode D6005 (1SS300) on the PLL Unit, frequency modulating the PLL carrier up to ± 5 kHz from the unmodulated carrier at the transmitting frequency. Also, if a CTCSS tone is generated by the optional FTS-17A Unit, it is buffered by Q1001 (2SC4116GR) on the Motherboard, and delivered to the PLL Unit with the modulating audio. The modulated signal from transmitter VCO Q6005 (2SC4226-R22) is buffered by Q6003 (2SC4226-R22) and delivered to the Motherboard for amplification by Q1002 (2SC3120), and final amplification by PA module Q1007 (M67748L). The transmit signal then passes through $\frac{1}{4}$ -wave antenna switch D1011 and a 3-pole lowpass filter to suppress non-harmonic radiation before delivery to the antenna.

Automatic Transmit Power Control

RF power output from the final amplifier is sampled by C1053 and C1060, and rectified by D1017 (1SS321). The resulting DC is delivered to high/low power controller Q4004 (FMS1) on the APC Unit, which selects high or two low power levels via Q4003 (2SA1586Y) and Q4005 (DTC124TU), controlled by the microprocessor via Q2012 on the Control Unit. The output of Q4004 is inverted by Q4002 (2SC4116GR), and passed by Q4001 (2SB799-ML) back to the input of final am-

plifier Q1007 on the Motherboard, to regulate the drive level via Q1019 (DTA144EU) under varying antenna loading conditions and power level selection. If the PLL is unlocked, or while receiving, the INH line causes the ULT5 line to be raised via Q4008 (DTC144EU), Q4006 (FMW1) and Q4007 (2SB799-ML), which biases the final amplifier off and disables the front panel keys.

Spurious Suppression

Generation of spurious products by the transmitter is minimized by the fundamental carrier frequency being equal to the final transmitting frequency, modulated directly in the transmit VCO. Additional harmonic suppression is provided by a lowpass filter consisting of L1006, L1008, L1010 and C1052, C1057, C1059, C1061 and C1066 on the Motherboard, resulting in more than 60 dB harmonic suppression (for transmitting frequencies in the amateur band) prior to delivery to the antenna.

PLL Frequency Synthesizer

PLL circuitry on the PLL Unit consists of separate transmit and receive VCOs (Q6005 and Q6001, both 2SC4226-R22), prescaler Q6002 (μ PB569B) and PLL subsystem IC Q6006 (MB87076PF-G-BND), which contains a reference divider, serial-to-parallel data latch, programmable divider and a phase comparator. Five-volt regulator Q1006 (LM2931AZ-5.0) on the Motherboard and filter Q7001 (2SC4116GR) on the Clock Unit provide the necessary stable supply voltage, and temperature compensating capacitors associated with 12.8-MHz crystal reference oscillator Q7002 (2SC4116GR) on the Clock Unit provide a stable reference frequency.

Receiver VCO Q6001 oscillates between 122.3 and 132.3 MHz according to the programmed receiving frequency. The VCO output is buffered by Q6003 (2SC4226-R22), and a sample of the output is buffered by Q6004 (2SC4215Y) for application to the prescaler Q6002. There the VCO signal is divided by 64 or 65, according to a control signal from the data latch section of Q6006, before being applied to the programmable divider section of Q6006.

The data latch section of Q6006 also receives serial dividing data from microprocessor Q2007 on the Control Unit, which causes the predivided VCO signal to be further divided by either 19,568 ~ 21,168 or 24,460 ~ 26,460 in the programmable divider section, depending upon the desired receive

Notes

Transistors

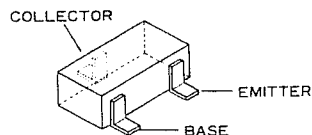

- DTC144EU
(Q1012, 1018, 3003, 3010
3013, 4008, 6007, 6008)
- DTA123YU
(Q1010, 1013)
- DTA143XU
(Q1009)
- DTA124EU
(Q2004)
- DTC124TU
(Q2010, 4005)
- 2SC3120
(Q1002)
- 2SC4226
(Q6001, 6003, 6005)
- 2SC4537
(Q1016)
- 2SC4116GR
(Q1001, 3005, 3007, 3011
4002, 7001, 7002)
- 2SC4215Y
(Q2011, 3002, 6004)
- 2SA1586Y
(Q4003)
- DTC114EU
(Q1003)
- DTA144EU
(Q1019)

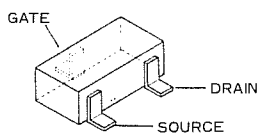

- 2SJ125D
(Q3016)
- 2SK880GR
(Q7003)

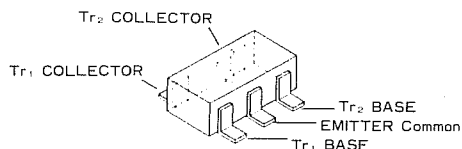

- FMW1
(Q4006)
- FMS1
(Q4004)

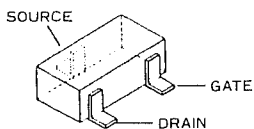

- 2SK882Y
(Q1008)

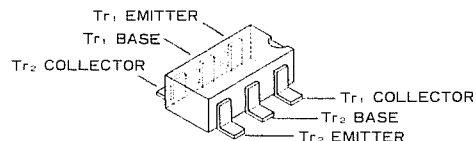

- IMD2
(Q3009)
- IMZ1
(Q2006, 2008)

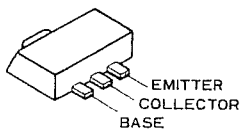

- 2SB799
(Q1005, 3006, 4001, 4007)
- 2SD1368CB
(Q2013)

Mother Unit Parts List

REF.	DESCRIPTION	VALUE	WV	TOL.	MFGR'S DESIG	YAESU P/N	VERS.
C 1053	CHIP CAP.	1pF	50V	CK	GRM39CK010C50PT	K22174202	
C 1054	CHIP CAP.	0.001uF	50V	B	GRM39B102M50PT	K22174809	
C 1055	CHIP CAP.	4pF	50V	CH	GRM39CH040C50PT	K22174205	
C 1057	CHIP CAP.	4pF	50V	CH	GRM39CH040C50PT	K22174205	
C 1059	CHIP CAP.	33pF	50V	CH	GRM39CH330J50PT	K22174223	
C 1060	CHIP CAP.	1pF	50V	CK	GRM39CK010C50PT	K22174202	
C 1061	CHIP CAP.	4pF	50V	CH	GRM39CH040C50PT	K22174205	
C 1062	CHIP CAP.	47pF	50V	CH	GRM39CH470J50PT	K22174227	
C 1064	CHIP CAP.	8pF	50V	CH	GRM39CH080D50PT	K22174209	
C 1066	CHIP CAP.	0.001uF	50V	B	GRM39B102M50PT	K22174809	
C 1067	CHIP CAP.	0.001uF	50V	B	GRM39B102M50PT	K22174809	
C 1068	CHIP CAP.	12pF	50V	CH	GRM39CH120J50PT	K22174213	
C 1073	CHIP CAP.	0.001uF	50V	B	GRM39B102M50PT	K22174809	
C 1074	CHIP CAP.	0.001uF	50V	B	GRM39B102M50PT	K22174809	
C 1075	CHIP CAP.	0.001uF	50V	B	GRM39B102M50PT	K22174809	
C 1077	CHIP CAP.	0.001uF	50V	B	GRM39B102M50PT	K22174809	
C 1078	CHIP CAP.	0.001uF	50V	B	GRM39B102M50PT	K22174809	
C 1079	CHIP CAP.	0.001uF	50V	B	GRM39B102M50PT	K22174809	
C 1080	CHIP CAP.	0.001uF	50V	B	GRM39B102M50PT	K22174809	
C 1081	CHIP CAP.	9pF	50V	CH	GRM39CH090D50PT	K22174210	
C 1083	CHIP CAP.	0.047uF	50V	B	GRM40B473M50PT	K22170823	
C 1084	CHIP CAP.	0.001uF	50V	B	GRM39B102M50PT	K22174809	
C 1085	CHIP CAP.	0.001uF	50V	B	GRM39B102M50PT	K22174809	
C 1086	CHIP CAP.	0.001uF	50V	B	GRM39B102M50PT	K22174809	
C 1087	CHIP CAP.	0.001uF	50V	B	GRM39B102M50PT	K22174809	
C 1088	CHIP CAP.	0.001uF	50V	B	GRM39B102M50PT	K22174809	
C 1089	CHIP CAP.	0.01uF	25V	B	GRM39B103M25PT	K22144802	
C 1090	CHIP CAP.	0.001uF	50V	B	GRM39B102M50PT	K22174809	
C 1091	CHIP CAP.	0.001uF	50V	B	GRM39B102M50PT	K22174809	
C 1092	CHIP CAP.	0.001uF	50V	B	GRM39B102M50PT	K22174809	
C 1093	CHIP CAP.	0.001uF	50V	B	GRM39B102M50PT	K22174809	
C 1094	CHIP CAP.	0.001uF	50V	B	GRM39B102M50PT	K22174809	
C 1095	CHIP CAP.	0.001uF	50V	B	GRM39B102M50PT	K22174809	
C 1096	CHIP CAP.	33pF	50V	CH	GRM39CH330J50PT	K22174223	
C 1097	CHIP CAP.	0.001uF	50V	B	GRM39B102M50PT	K22174809	
D 1001	DIODE				DAN202U T106	G2070162	
D 1002	DIODE				DAN202U T106	G2070162	
D 1003	DIODE				O2CZ2. OX TE85R	G2070124	
D 1004	DIODE				DAN202U T106	G2070162	
D 1005	DIODE				DAN202U T106	G2070162	
D 1006	DIODE				EA40QC04	G2090491	
D 1007	DIODE				1SS302 TE85R	G2070088	
D 1008	DIODE				DAN202U T106	G2070162	
D 1009	DIODE				HVU306A5TRF	G2070132	
D 1010	DIODE				HVU306A5TRF	G2070132	
D 1011	DIODE				1SS135 T-77	G2060005	
D 1012	DIODE				HVU306A5TRF	G2070132	
D 1013	DIODE				HVU306A5TRF	G2070132	
D 1014	DIODE				1SS135 T-77	G2060005	
D 1015	DIODE				HVU306A5TRF	G2070132	
D 1016	DIODE				HVU306A5TRF	G2070132	
D 1017	DIODE				1SS321 TE85R	G2070076	
D 1018	DIODE				1SS302 TE85R	G2070088	
D 1019	DIODE				HVU306A5TRF	G2070132	

Mother Unit Parts List

REF.	DESCRIPTION	VALUE	WV	TOL.	MFGR'S DESIG	YAESU P/N	VERS.
R 1027	CHIP RES.	100K	1/16W		RMC1/16 104JATP	J24185104	
R 1028	CHIP RES.	820	1/16W		RMC1/16 821JATP	J24185821	
R 1029	CHIP RES.	10K	1/16W		RMC1/16 103JATP	J24185103	
R 1031	CHIP RES.	100K	1/16W		RMC1/16 104JATP	J24185104	
R 1032	CHIP RES.	100K	1/16W		RMC1/16 104JATP	J24185104	
R 1034	CHIP RES.	100K	1/16W		RMC1/16 104JATP	J24185104	
R 1035	CHIP RES.	1.8K	1/16W		RMC1/16 182JATP	J24185182	
R 1037	CHIP RES.	10K	1/16W		RMC1/16 103JATP	J24185103	
R 1041	CHIP RES.	12K	1/16W		RMC1/16 123JATP	J24185123	
R 1042	CHIP RES.	100K	1/16W		RMC1/16 104JATP	J24185104	
R 1043	CHIP RES.	100K	1/16W		RMC1/16 104JATP	J24185104	
R 1044	CHIP RES.	0	1/16W		RMC1/16 000JATP	J24185000	DST EXP
R 1044	CHIP RES.	0	1/16W		RMC1/16 000JATP	J24185000	DST USA
R 1045	CHIP RES.	10K	1/16W		RMC1/16 103JATP	J24185103	
R 1046	CHIP RES.	10K	1/16W		RMC1/16 103JATP	J24185103	
R 1049	CHIP RES.	2.2K	1/16W		RMC1/16 222JATP	J24185222	
R 1050	CHIP RES.	2.2K	1/16W		RMC1/16 222JATP	J24185222	
R 1051	CHIP RES.	2.2K	1/16W		RMC1/16 222JATP	J24185222	
R 1052	CHIP RES.	4.7K	1/16W		RMC1/16 472JATP	J24185472	
R 1053	CHIP RES.	100K	1/16W		RMC1/16 104JATP	J24185104	
R 1054	CHIP RES.	4.7K	1/16W		RMC1/16 472JATP	J24185472	
T 1001	COIL				432AN-1315Z=P1	L0022106	
T 1002	COIL				432AN-1315Z=P1	L0022106	
T 1003	COIL				432AN-1314BY=P1	L0022107	
T 1004	COIL				432AN-1314BY=P1	L0022107	
VR1001	POT.	10K			RH03AYA14X	J51778103	
VR1002	POT.	10K			RH03AYA14X	J51778103	
XF1001	XTAL				17M15B2	H1102217	
XF1002	XTAL				17M15B2	H1102217	
	LEAF SPRING					R0140180	
	SHIELD CASE					R0137600A	
	HEATSINK PLATE					R0137610	
	XTAL HOLDER (2pcs)					R3129530	

Control Unit Parts List

REF.	DESCRIPTION	VALUE	WV	TOL.	MFGR'S DESIG	YAESU P/N	VERS.
C 2046	CHIP CAP.	0.001uF	50V	B	GRM39B102M50PT	K22174809	
C 2047	CHIP CAP.	0.001uF	50V	B	GRM39B102M50PT	K22174809	
C 2049	CHIP CAP.	0.001uF	50V	B	GRM39B102M50PT	K22174809	
C 2050	CHIP CAP.	0.001uF	50V	B	GRM39B102M50PT	K22174809	
C 2051	CHIP CAP.	0.001uF	50V	B	GRM39B102M50PT	K22174809	
C 2052	CHIP CAP.	0.001uF	50V	B	GRM39B102M50PT	K22174809	
C 2054	CHIP CAP.	100pF	50V	CH	GRM39CH101J50PT	K22174235	
C 2055	CHIP CAP.	100pF	50V	CH	GRM39CH101J50PT	K22174235	
C 2056	CHIP CAP.	100pF	50V	CH	GRM39CH101J50PT	K22174235	
C 2057	CHIP CAP.	100pF	50V	CH	GRM39CH101J50PT	K22174235	
C 2058	CHIP CAP.	0.001uF	50V	B	GRM39B102M50PT	K22174809	
C 2059	CHIP CAP.	0.001uF	50V	B	GRM39B102M50PT	K22174809	
C 2060	CHIP CAP.	100pF	50V	CH	GRM39CH101J50PT	K22174235	
C 2061	CHIP CAP.	100pF	50V	CH	GRM39CH101J50PT	K22174235	
C 2062	CHIP CAP.	100pF	50V	CH	GRM39CH101J50PT	K22174235	
C 2063	CHIP CAP.	100pF	50V	CH	GRM39CH101J50PT	K22174235	
C 2064	CHIP CAP.	0.001uF	50V	B	GRM39B102M50PT	K22174809	
C 2065	CHIP CAP.	0.001uF	50V	B	GRM39B102M50PT	K22174809	
C 2066	CHIP CAP.	0.001uF	50V	B	GRM39B102M50PT	K22174809	
C 2068	CHIP CAP.	0.001uF	50V	B	GRM39B102M50PT	K22174809	
C02001	CERAMIC OSC				CSB800JT	H7900530	
D 2001	DIODE				1SS302 TE85R	G2070088	
D 2002	DIODE				FMP1 T148	G2070130	
D 2003	DIODE				IMN10 T108	G2070078	
D 2004	DIODE				1SS272 TE85R	G2070048	
D 2005	DIODE				FMP1 T148	G2070130	
D 2006	DIODE				1SS272 TE85R	G2070048	
D 2007	DIODE				1SS319 TE85R	G2070080	
D 2008	DIODE				DAN202U T106	G2070162	
D 2009	DIODE				1SS302 TE85R	G2070088	
D 2010	DIODE				1SS272 TE85R	G2070048	
D 2011	DIODE				1SS272 TE85R	G2070048	
D 2012	LED				LN01301C(Q)	G2090495	
D 2013	LED				SLM-13MWS T-97B	G2070098	
D 2014	LED				SLM-13MWS T-97B	G2070098	
D 2015	LED				SLM-13MWS T-97B	G2070098	
D 2016	LED				SLM-13MWS T-97B	G2070098	
D 2017	LED				LN01301C(Q)	G2090495	
D 2018	LED				SLM-23VMWS T-97B	G2070096	
D 2019	DIODE				DAP202U T106	G2070160	
DS2001	LCD				T415001	G6090083	
MC2001	MIC ELEMENT				EM-78CYE	M3290008	
Q 2001	IC				TC4S71F TE85R	G1090906	
Q 2003	IC				RH5VA32AA-T1	G1091181	
Q 2004	TRANSISTOR				DTA124EU T106	G3070064	
Q 2005	IC				UPD4013BG-T2	G1091027	
Q 2006	TRANSISTOR				IMZ1 T108	G3070025	
Q 2007	IC				HD404618A	G1091541	
Q 2008	TRANSISTOR				IMZ1 T108	G3070025	
Q 2009	IC				NJM2902M	G1090908	

Control Unit Parts List

REF.	DESCRIPTION	VALUE	WV	TOL.	MFGR'S DESIG	YAESU P/N	VERS.
R 2050	CHIP RES.	470	1/16W		RMC1/16 471JATP	J24185471	
R 2051	CHIP RES.	470	1/16W		RMC1/16 471JATP	J24185471	
R 2052	CHIP RES.	10K	1/16W		RMC1/16 103JATP	J24185103	
R 2053	CHIP RES.	10K	1/16W		RMC1/16 103JATP	J24185103	
R 2054	CHIP RES.	470	1/16W		RMC1/16 471JATP	J24185471	
R 2055	CHIP RES.	1K	1/16W		RMC1/16 102JATP	J24185102	
R 2056	CHIP RES.	5.6K	1/16W		RMC1/16 562JATP	J24185562	
R 2057	CHIP RES.	2.7K	1/16W		RMC1/16 272JATP	J24185272	
R 2058	CHIP RES.	470	1/16W		RMC1/16 471JATP	J24185471	
R 2059	CHIP RES.	33K	1/16W		RMC1/16 333JATP	J24185333	
R 2060	CHIP RES.	150K	1/16W		RMC1/16 154JATP	J24185154	
R 2061	CHIP RES.	4.7K	1/16W		RMC1/16 472JATP	J24185472	
R 2062	CHIP RES.	33K	1/16W		RMC1/16 333JATP	J24185333	
R 2063	CHIP RES.	68K	1/16W		RMC1/16 683JATP	J24185683	
R 2064	CHIP RES.	560K	1/16W		RMC1/16 564JATP	J24185564	
R 2065	CHIP RES.	5.6K	1/16W		RMC1/16 562JATP	J24185562	
R 2066	CHIP RES.	100K	1/16W		RMC1/16 104JATP	J24185104	
R 2067	CHIP RES.	56K	1/16W		RMC1/16 563JATP	J24185563	
R 2068	CHIP RES.	2.2M	1/16W		RMC1/16 225JATP	J24185225	
R 2069	CHIP RES.	2.2M	1/16W		RMC1/16 225JATP	J24185225	
R 2070	CHIP RES.	10K	1/16W		RMC1/16 103JATP	J24185103	
R 2071	CHIP RES.	10K	1/16W		RMC1/16 103JATP	J24185103	
R 2072	CHIP RES.	10K	1/16W		RMC1/16 103JATP	J24185103	
R 2073	CHIP RES.	10K	1/16W		RMC1/16 103JATP	J24185103	
R 2074	CHIP RES.	1K	1/16W		RMC1/16 102JATP	J24185102	
R 2077	CHIP RES.	6.8	1/4W		RMC1/4 6R8JATP	J24245689	
R 2080	CHIP RES.	0	1/16W		RMC1/16 000JATP	J24185000	
R 2081	CHIP RES.	100K	1/16W		RMC1/16 104JATP	J24185104	
R 2082	CHIP RES.	4.7K	1/16W		RMC1/16 472JATP	J24185472	
R 2083	CHIP RES.	0	1/16W		RMC1/16 000JATP	J24185000	
S 2001	TACT SWITCH				SKQDAA	N5090051	
S 2002	TACT SWITCH				SKQDAA	N5090051	
S 2003	TACT SWITCH				SKQDAA	N5090051	
	SEAL 012 (2pcs)					R8138160	
	METAL HOLDER					R0137590	
	INTER CONNECTOR (2pcs)					R7137570	
	REFLECTOR					R7137580	

IF Unit Parts List

REF.	DESCRIPTION	VALUE	WV	TOL.	MFGR'S DESIG	YAESU P/N	VERS.
C 3053	CHIP CAP.	0.001uF	50V	B	GRM39B102M50PT	K22174809	
CD3001	CERAMIC DISC				CDBM455C7	H7900480	
CF3001	CERAMIC FILTER				KBF-455RS-12A	H3900405	
D 3001	DIODE				1SS302 TE85R	G2070088	
D 3002	DIODE				1SS294 TE85R	G2070058	
D 3003	DIODE				1SS302 TE85R	G2070088	
D 3004	DIODE				1SS302 TE85R	G2070088	
J 3001	CONNECTOR				52103-1217	P1090708	
J 3002	CONNECTOR				9230B-1-04Z025-T	P0090821	
J 3003	CONNECTOR				9230B-1-02Z025-T	P0090820	
L 3001	COIL	0.68uH			32CS 380NB-R68M=P.	L1690067	
Q 3002	TRANSISTOR				2SC4215Y TE85R	G3342157Y	
Q 3003	TRANSISTOR				DTC144EU T107	G3070041	
Q 3004	IC				MC3372ML	G1091108	
Q 3005	TRANSISTOR				2SC4116GR TE85R	G3341167G	
Q 3006	TRANSISTOR				2SB799-T2ML	G3207997L	
Q 3007	TRANSISTOR				2SC4116GR TE85R	G3341167G	
Q 3009	TRANSISTOR				IMD2 T108	G3070026	
Q 3010	TRANSISTOR				DTC144EU T107	G3070041	
Q 3011	TRANSISTOR				2SC4116GR TE85R	G3341167G	
Q 3013	TRANSISTOR				DTC144EU T107	G3070041	
Q 3014	IC				NJM386BD	G1091068	
Q 3016	FET				2SJ125D-T12-1D	G3701257D	
R 3001	CHIP RES.	470	1/16W		RMC1/16 471JATP	J24185471	
R 3002	CHIP RES.	39K	1/16W		RMC1/16 393JATP	J24185393	
R 3003	CHIP RES.	39K	1/16W		RMC1/16 393JATP	J24185393	
R 3005	CHIP RES.	27K	1/16W		RMC1/16 273JATP	J24185273	
R 3006	CHIP RES.	470	1/16W		RMC1/16 471JATP	J24185471	
R 3007	CHIP RES.	68K	1/16W		RMC1/16 683JATP	J24185683	
R 3009	CHIP RES.	1K	1/16W		RMC1/16 102JATP	J24185102	
R 3010	CHIP RES.	1K	1/16W		RMC1/16 102JATP	J24185102	
R 3011	CHIP RES.	1.5K	1/16W		RMC1/16 152JATP	J24185152	
R 3012	CHIP RES.	1.8K	1/16W		RMC1/16 182JATP	J24185182	
R 3013	CHIP RES.	47K	1/16W		RMC1/16 473JATP	J24185473	
R 3014	CHIP RES.	560K	1/16W		RMC1/16 564JATP	J24185564	
R 3015	CHIP RES.	1.8K	1/16W		RMC1/16 182JATP	J24185182	
R 3016	CHIP RES.	820	1/16W		RMC1/16 821JATP	J24185821	
R 3017	CHIP RES.	15K	1/16W		RMC1/16 153JATP	J24185153	
R 3018	CHIP RES.	6.8K	1/16W		RMC1/16 682JATP	J24185682	
R 3019	CHIP RES.	4.7K	1/16W		RMC1/16 472JATP	J24185472	
R 3022	CHIP RES.	120	1/16W		RMC1/16 121JATP	J24185121	
R 3023	CHIP RES.	2.7K	1/16W		RMC1/16 272JATP	J24185272	
R 3024	CHIP RES.	10K	1/16W		RMC1/16 103JATP	J24185103	
R 3025	CHIP RES.	10K	1/16W		RMC1/16 103JATP	J24185103	
R 3026	CHIP RES.	2.2K	1/16W		RMC1/16 222JATP	J24185222	
R 3027	CHIP RES.	1K	1/16W		RMC1/16 102JATP	J24185102	
R 3028	CHIP RES.	47K	1/16W		RMC1/16 473JATP	J24185473	
R 3029	CHIP RES.	33K	1/16W		RMC1/16 333JATP	J24185333	

PLL Unit Parts List

REF.	DESCRIPTION	VALUE	WV	TOL.	MFGR'S DESIG	YAESU P/N	VERS.
Q 6001	TRANSISTOR				2SC4226-T2B R22	G3342267B	
Q 6002	IC				UPB569G2-E1	G1090870	
Q 6003	TRANSISTOR				2SC4226-T2B R22	G3342267B	
Q 6004	TRANSISTOR				2SC4215Y TE85R	G3342157Y	
Q 6005	TRANSISTOR				2SC4226-T2B R22	G3342267B	
Q 6006	IC				MB87076PF-G-BND-TF	G1090934	
Q 6007	TRANSISTOR				DTC144EU T107	G3070041	
Q 6008	TRANSISTOR				DTC144EU T107	G3070041	
R 6001	CHIP RES.	1K	1/16W		RMC1/16 102JATP	J24185102	
R 6002	CHIP RES.	5.6K	1/16W		RMC1/16 562JATP	J24185562	
R 6003	CHIP RES.	220	1/16W		RMC1/16 221JATP	J24185221	
R 6004	CHIP RES.	68K	1/16W		RMC1/16 683JATP	J24185683	
R 6005	CHIP RES.	120K	1/16W		RMC1/16 124JATP	J24185124	
R 6007	CHIP RES.	22K	1/16W		RMC1/16 223JATP	J24185223	
R 6008	CHIP RES.	47K	1/16W		RMC1/16 473JATP	J24185473	
R 6009	CHIP RES.	1.2K	1/16W		RMC1/16 122JATP	J24185122	
R 6010	CHIP RES.	10K	1/16W		RMC1/16 103JATP	J24185103	
R 6011	CHIP RES.	5.6K	1/16W		RMC1/16 562JATP	J24185562	
R 6013	CHIP RES.	22K	1/16W		RMC1/16 223JATP	J24185223	
R 6014	CHIP RES.	10K	1/16W		RMC1/16 103JATP	J24185103	
R 6015	CHIP RES.	1.2K	1/16W		RMC1/16 122JATP	J24185122	
R 6016	CHIP RES.	15K	1/16W		RMC1/16 153JATP	J24185153	
R 6017	CHIP RES.	100K	1/16W		RMC1/16 104JATP	J24185104	
R 6018	CHIP RES.	470	1/16W		RMC1/16 471JATP	J24185471	
R 6019	CHIP RES.	0	1/16W		RMC1/16 000JATP	J24185000	
T 6001	COIL				140M	L0022109	
T 6002	COIL				140M	L0022110	
TP6001	TP-N				IPS-1091	Q5000082	
	SHIELD COVER ASSY					R0137650	
	SHIELD CASE					R0515760	

FTS - 17A Parts List

REF	YAESU P/N	DESCRIPTION	MFGR'S DESIG.	VALUE	WV	TOL.	VERS.
*** T-SQL-UNIT ***							
	F3220101	P.C.B. W/O COMP.					
C 0101	K22174801	CHIP CAP.	GRM39B221M50PT	220pF	50V	B	
C 0102	K22174801	CHIP CAP.	GRM39B221M50PT	220pF	50V	B	
C 0103	K22140811	CHIP CAP.	GRM40B104M25PT	0.1uF	25V	B	
C 0104	K78120013	TANTALUM CHIP CAP.	F951C105MRAAF1Q2	1uF	16V		
C 0105	K78140012	TANTALUM CHIP CAP.	F951E474MRAAF1Q2	0.47uF	25V		
C 0106	K78080002	TANTALUM CHIP CAP.	F950J475MSAAF1Q2	4.7uF	6.3V		
C 0107	K22174809	CHIP CAP.	GRM39B102M50PT	0.001uF	50V	B	
C 0108	K22140811	CHIP CAP.	GRM40B104M25PT	0.1uF	25V	B	
CO0101	H7900550	CERAMIC OSC	CSB1000J221T		1MHZ		
D 0101	G2070086	DIODE	1SS301 TE85R				
P 0101	P1090624	CONNECTOR	52022-1010				
Q 0101	G1090897	IC	MX365LH				
R 0101	J24185105	CHIP RES.	RMC1/16 105JATP	1M	1/16W		
R 0102	J24185225	CHIP RES.	RMC1/16 225JATP	2.2M	1/16W		
R 0103	J24185334	CHIP RES.	RMC1/16 334JATP	330K	1/16W		
R 0104	J24185822	CHIP RES.	RMC1/16 822JATP	8.2K	1/16W		
VR0101	J51780473	POT.	RH04BPAS4X 47K	47K			
	R7130200	SPONGE					

**Copyright © 1993
Yaesu Musen Co., Ltd.
All rights reserved.**

No portion of this manual
may be reproduced
without the permission of
Yaesu Musen Co., Ltd.

Printed in Japan.