

COMMUNICATIONS RECEIVER

VR-500

Technical Supplement

©2001 VERTEX STANDARD CO., LTD. Printed in Japan.

VERTEX STANDARD CO., LTD.
4-8-8 Nakameguro, Meguro-Ku, Tokyo 153-8644, Japan
VERTEX STANDARD
US Headquarters
17210 Edwards Rd., Cerritos, CA 90703, U.S.A.
International Division
8350 N.W. 52nd Terrace, Suite 201, Miami, FL 33166, U.S.A.
YAESU EUROPE B.V.
P.O. Box 75525, 1118 ZN Schiphol, The Netherlands
YAESU UK LTD.
Unit 12, Sun Valley Business Park, Winnall Close
Winchester, Hampshire, SO23 0LB, U.K.
YAESU GERMANY GmbH
Am Kronberger Hang 2, D-65824 Schwalbach, Germany
VERTEX STANDARD HK LTD.
Unit 5, 20/F., Seaview Centre, 139-141 Hoi Bun Road,
Kwun Tong, Kowloon, Hong Kong

Introduction

This manual provides technical information necessary for servicing the Yaesu VR-500 Communications Receiver. Information on its installation and operation can be found in the VR-500 Operating Manual, which is provided with the receiver, and Accessory information may be found in the documents accompanying the optional equipment.

The VR-500 is a high-performance miniature communications receiver providing general coverage reception from 100 kHz to 1300 MHz on the CW, SSB (LSB and USB), AM, and FM (Wide and Narrow bandwidths) modes (this coverage includes the AM and FM broadcast bands, HF Short-wave Bands up to 16 MHz, VHF and UHF TV bands, the VHF AM aircraft band, and a wide range of commercial and public safety frequencies!).

Servicing this equipment requires expertise in handling surface mount chip components. Attempts by unqualified persons to service this equipment may result in permanent damage not covered by warranty. For the major circuit boards, each side of the board is identified by the type of the majority of components installed on that side. In most cases one side has only chip components, and the other has either a mixture of both chip and lead compo-

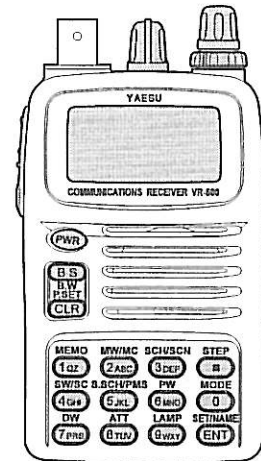

nents (trimmers, coils, electrolytic capacitors, packaged ICs, etc.), or lead components only.

While we believe the technical information in this manual is correct, VERTEX STANDARD assumes no liability for damage that may occur as a result of typographical or other errors that may be present. Your cooperation in pointing out any inconsistencies in the technical information would be appreciated. VERTEX STANDARD reserves the right to make changes in this receiver and the alignment procedures, in the interest of technological improvement, without notification of owners.

Contents

Specifications	2
Exploded View & Miscellaneous Parts	3
Circuit Description	5
Alignment	7
Block Diagram	14
Board Unit (Schematics, Layouts & Parts)	
μCOM Unit	15
AF Unit	27
RF Unit	37
VCO Unit	53
SW Unit	57

Specifications

Frequency Range:	USA 0.1000 MHz ~ 1299.9995 MHz (Cellular Blocked) EXP 0.1000 MHz ~ 29.9995 MHz 50.0000 MHz ~ 53.9995 MHz 88.0000 MHz ~ 107.9995 MHz 144.0000 MHz ~ 147.9995 MHz 430.0000 MHz ~ 449.9995 MHz 1240.0000 MHz ~ 1299.9995 MHz
Receiving Mode:	NFM/WFM/AM/SSB/CW
Antenna Impedance:	50 Ω unbalanced, BNC receptacle
Channel Step:	0.05/0.1/1/5/6.25/9/10/12.5/15/20/30/50/100 kHz
Operating Temp.:	-10 °C ~ +50 °C
Sensitivity:	0.1 ~ 5 MHz: AM 1.5 μ V (10 dB S/N) SSB/CW 0.6 μ V (10 dB S/N) 5 ~ 370 MHz: AM 1.0 μ V (10 dB S/N) SSB/CW 0.5 μ V (10 dB S/N) NFM 0.5 μ V (12dB SINAD) WFM 1.5 μ V (12 dB SINAD) 370 ~ 520 MHz: SSB/CW 0.5 μ V (10 dB S/N) NFM 0.5 μ V (12 dB SINAD) WFM 1.8 μ V (12 dB SINAD) 520 ~ 1300 MHz: SSB/CW 0.8 μ V (10 dB S/N) NFM 1.2 μ V (12dB SINAD) WFM 3.0 μ V (12 dB SINAD)
Memory Channels:	Regular Memories: 1000 Channels "Skip" Memories: 100 Channels Search Band Memories: 10 Channels Dual Watch Memories: 10 Channels Priority Memory: 1 Channel
Supply Voltage:	2.2 ~ 3.5 V DC; Inner Battery (Nominal: 3.0 V DC) 9.0 V DC ~ 16.0 V DC (EXT DC)
Current Consumption:	115 mA (Receive) 55 mA (Standby, Saver off) 15 mA (Standby, Saver on)
AF Output:	90 mW (@Battery) 125 mW (@EXT DC)
Case Size:	58 x 95 x 30 mm (W x H x D) w/o knob
Weight:	Approx. 220 g w/battery & antenna

Specifications are subject to change without notice or obligation.

Exploded View & Miscellaneous Parts

No.	YAESU P/N	Description	Qty.
①	U07240307	PAN HEAD SCREW M2X4B#3	2
②	U9900096	PAN HEAD SCREW M2X5B#3	2
③	U07130301	PAN HEAD SCREW M1.7X3#3	9
④	U9900095	PAN HEAD SCREW M1.7X3.5B#1	2

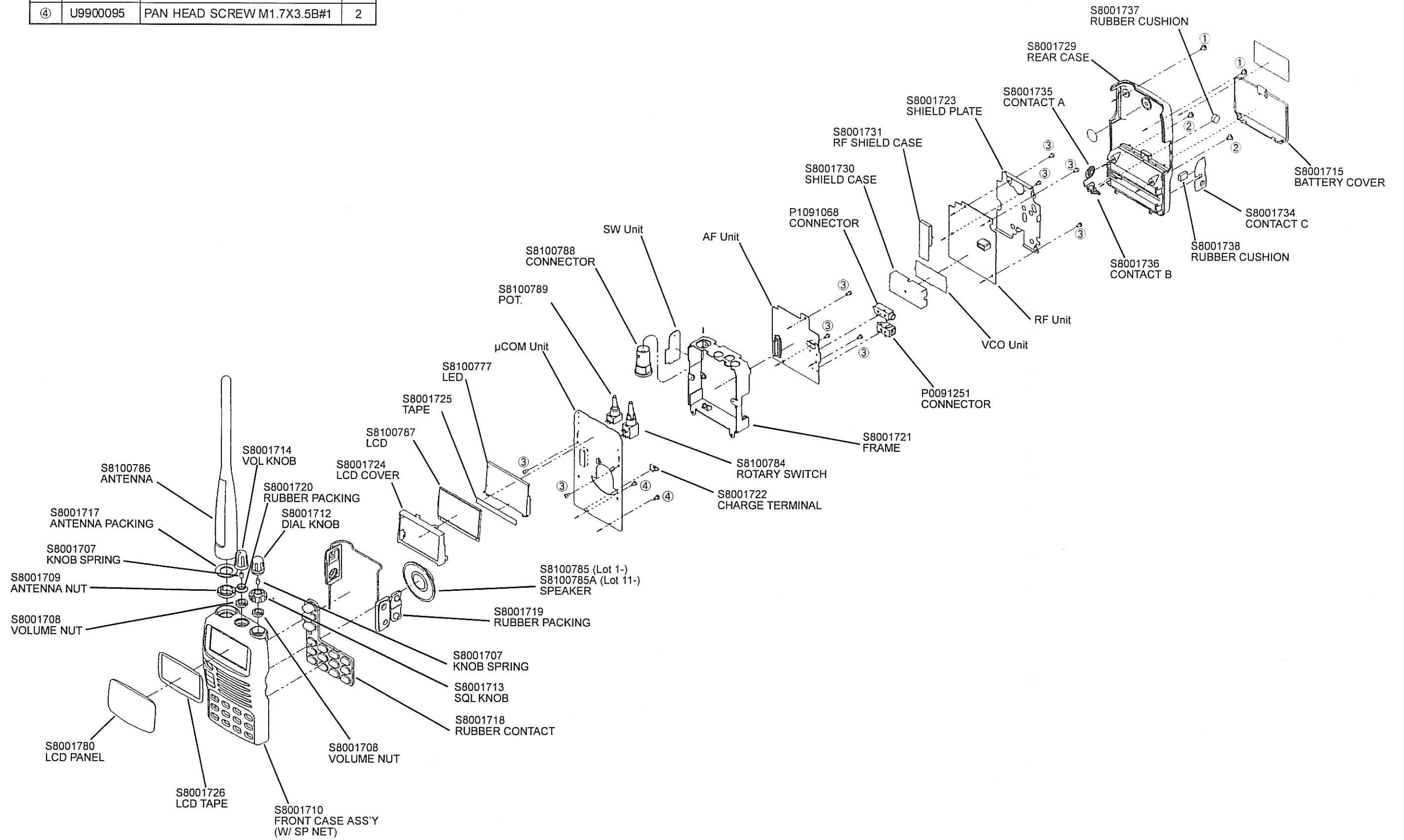

The VR-500 circuitry includes three modules: (1) the RF Unit, (2) the CNTL Unit, and (3) the AF Unit.

The RF Unit is a module consisting of the front-end unit, 1st IF amplifier, 2nd IF amplifier, PLL circuit, and power supply. The AF Unit consists of the 3rd IF amplifier, detector circuit, audio amplifier, and power supply. The CNTL unit includes the CPU, LCD, LCD driver, and EEPROM.

RF Unit

Incoming RF signal from the antenna jack is fed through the ATT circuit to a diode switch, then to one of the nine band-pass filters and RF amplifiers selected by the receive frequency data from the microprocessor.

	Frequency Range	RF amplifier
Band 1	0.10000 ~ 1.99995 MHz	Q508 (2SC5006)
Band 2	2.00000 ~ 49.99995 MHz	Q513 (2SC4215Y)
Band 3	50.00000 ~ 109.99995 MHz	Q508 (2SC5006)
Band 4	110.00000 ~ 159.99995 MHz	Q518 (2SC5006)
Band 5	160.00000 ~ 259.99995 MHz	Q517 (2SC5006)
Band 6	260.00000 ~ 369.99995 MHz	Q523 (2SC5006)
Band 7	370.00000 ~ 469.99995 MHz	Q520 (2SC5006)
Band 8	470.00000 ~ 779.99995 MHz	Q524 (2SC5010)
Band 9	780.00000 ~ 1299.99995 MHz	Q526 (uPC2748T)

The amplified RF signal is delivered to the 1st IF mixer Q528 (μ PC2757T) along with the 1st local signal from the PLL circuit, which produces the 248.45 MHz or 429.15 MHz 1st IF signal.

The 248.45 MHz 1st IF signal is fed through the roofing filter, F502 (LSFB19-248-220K0), to the 1st IF amplifier Q532 (2SC5006). In the case of the 429.15 MHz 1st IF, the signal is fed through filter F501 (LSFB19-429-800K0) to IF amplifier Q530 (2SC5006).

The filtered and amplified 1st IF signal is delivered to the 2nd IF mixer Q534 (3SK318) along with the 2nd local signal from the PLL circuit, which produces the 10.7 MHz 2nd IF signal. The 10.7 MHz 2nd IF signal is fed through ceramic filter F503 (SFECV10.7MA5-Z) and 2nd IF amplifier Q535 (2SC4215Y) to the IF subsystem IC Q302 (TA31136FN) on the AF Unit, which contains the 3rd IF mixer, 3rd local signal oscillator, and FM detector.

The 1st local VCO Q705 (2SC5010) and Q711 (2SC5006) oscillates between 371.55 and 880.90 MHz according to the programmed receiving frequency. The 1st local signal is fed through buffer amplifiers Q702 and Q709 (both μ PA811T) to the 1st IF mixer Q528.

The 2nd local VCO Q537 (2SC5006) oscillates at 237.75 MHz or 259.15 MHz, according to the programmed receiving frequency. The 2nd local signal is fed through

buffer amplifier Q536 (2SC5006) to the 2nd IF mixer Q534.

PLL IC Q541 (MB15F02PFV) consists of a data shift register, reference frequency divider, phase comparator, and charge pump. Serial PLL data from the microprocessor is converted into parallel data by the shift register in the PLL IC and latched into the comparative frequency divider and reference frequency divider to set a frequency dividing ratio for each. A 15.2 MHz reference signal produced by X501 and Q542 (2SC4617) is delivered to the PLL IC. The internal reference frequency divider divides the 15.2 MHz reference by 3040 (or 2432) to obtain a reference frequency of 5 kHz (or 6.25 kHz), which is applied to the phase comparator for the 1st local PLL loop. Meanwhile, the internal reference frequency divider divides the 15.2 MHz reference by 1520 (or 1216) to obtain a reference frequency of 10 kHz (or 12.5 kHz), which is applied to the phase comparator for the 2nd local PLL loop.

AF Unit

The 10.7 MHz 2nd IF signal from the RF Unit is delivered to the 3rd IF mixer section in the IF subsystem IC Q302 along with the reference signal generated by 10.245 MHz crystal X301, which results in the 455 kHz 3rd IF signal.

If the signal is a (455 kHz) NFM signal, it is fed through ceramic filter F302 (KBF-455RS-15A), to strip away any unwanted mixer products, and is then applied to the discriminator in the IF subsystem IC Q302, which produces the demodulated audio.

In the case of a 455 kHz WFM signal, it is applied directly to the discriminator in the IF subsystem IC Q302, which produce the demodulated audio.

For AM signals, the IF energy is fed through ceramic filter F302 (KBF-455RS-15A), and is then applied to the 3rd IF amplifier Q343, Q311 and Q314 (all 2SC4617R). The amplified 455 kHz AM signal is delivered to the AM detector Q315 (MA729), which produces the demodulated audio.

SSB/CW signals are fed through ceramic filter F301 (KBF-455RS-4AS), then applied to the 3rd IF amplifier Q343, Q311 and Q314 (all 2SC4617R). The amplified 455 kHz SSB/CW signal is delivered to the ring demodulator Q319 and Q320 (both MA729) along with the 456.5 kHz (LSB/CW) or 453.5 kHz (USB) BFO local, generated by ceramic oscillator X302 and Q317 (2SC4617R), thus producing the demodulated audio.

The demodulated audio is fed through analog switch Q323 (BU4094BCFV) to the audio pre-amplifier Q333 (UMX2N).

Circuit Description

The amplified audio signal is fed through audio volume potentiometer R151 on the CNTL Unit to the AF amplifier Q336 (**2SA1588Y**), and the amplified audio signal is ultimately fed through the EAR jack to the internal speaker or an external earphone.

Required Test Equipment

The following test equipment (and thorough familiarity with its correct use) is necessary for complete realignment. Correction of problems caused by misalignment resulting from use of improper test equipment is not covered under the warranty policy. While most steps do not require all of the equipment listed, the interactions of some adjustments may require that more complex adjustments be performed afterwards. Do not attempt to perform only a single step unless it is clearly isolated electrically from all other steps. Have all test equipment ready before beginning, and follow all of the steps in a section in the order presented.

1. RF Signal Generator with calibrated output level at 1300 MHz
2. Deviation Meter (linear detector)
3. AF Millivoltmeter
4. SINAD Meter
5. Regulated DC Power Supply adjustable from 3 to 15 DC, 1A
6. Frequency Counter: >0.1 ppm accuracy at 1300 MHz
7. AF Signal Generator
8. DC Voltmeter: high impedance
9. DC Ammeter
10. 8 Ω AF Dummy Load
11. Spectrum Analyzer

Alignment Preparation & Precautions

Correct alignment requires that the ambient temperature be the same as that of the receiver and test equipment, and that this temperature be held constant between 20° and 30° C (68° ~ 86° F). When the receiver is brought into the shop from hot or cold air it should be allowed some time for thermal equalization with the environment before alignment. If possible, alignments should be made with oscillator shields and circuit boards firmly affixed in place. Also, the test equipment must be thoroughly warmed up before beginning.

Note: Signal levels in dB referred to in this procedure are based on 0 dB μ = 0.5 μ V(closed circuit).

Test Setup

Set up the test equipment as shown below for receiver alignment.

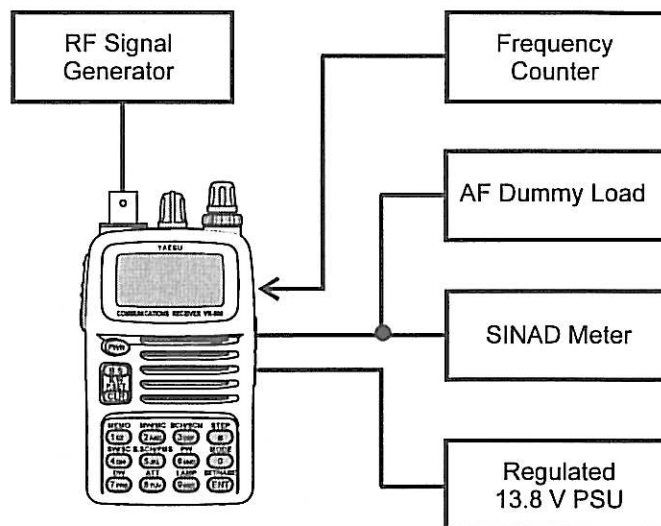

1st Local Frequency

- Set the VR-500 to 100.050 MHz, NFM mode.
- Connect the RF probe of the Frequency Counter to TP3, and adjust C620 for a reading 529.15 MHz (\pm 200 Hz) on the Frequency Counter.

3rd Local Frequency

- Set the VR-500 to 100.000 MHz, LSB mode.
- Insert the RF probe of the Spectrum Analyzer into the nest at the left side of the chassis, as shown below.

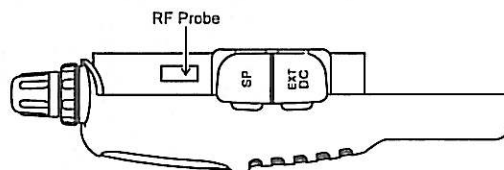

- Adjust R303 for a reading 10.2465 MHz (\pm 100 Hz) on the Spectrum Analyzer.

BFO 1

- Set the VR-500 to 10.050 MHz, LSB mode.
- Connect the RF Signal Generator to the Antenna jack.
- Inject a 100.050 MHz 10 dB μ signal from the RF Signal Generator, and adjust R358 to the point where the AF output level is minimized.

BFO 2

- Set the VR-500 to 10.050 MHz, USB mode.
- Connect the RF Signal Generator to the Antenna jack.
- Inject a 100.050 MHz, 10 dB μ signal from the RF Signal Generator, and adjust R357 to the point where the AF output level is minimized.

AF NFM Detector Coil

- Set the VR-500 to 100.050 MHz, NFM mode.
- Connect the RF Signal Generator to the Antenna jack.
- Inject a 100.050 MHz, 60 dBμ (1 kHz tone @ ±3.5 kHz deviation) signal from the RF Signal Generator, and adjust L306 to the point where the AF output signal has minimum distortion.

RF Voltage

- Connect the DC voltmeter to TP1, and confirm a DC voltmeter reading of 2.9 ~ 3.2 V.
- Connect the DC voltmeter to TP2, and confirm a DC voltmeter reading of 2.7 ~ 3.0 V.
- Connect the DC voltmeter to TP6, and confirm a DC voltmeter reading of 9.7 ~ 10.7 V.

1st VCO VCV

- Connect the DC voltmeter to TP4, and referring to table below, tune the VR-500 to each frequency listed. Then confirm that the correct voltage is present.

Frequency	VGV Voltage
620.000 MHz	1.4 ~ 2.3 V
668.350 MHz	2.5 ~ 4.2 V
668.450 MHz	0.8 ~ 1.6 V
778.350 MHz	3.0 ~ 5.0 V
778.450 MHz	0.6 ~ 1.3 V
280.800 MHz	6.4 ~ 7.0 V
280.900 MHz	0.7 ~ 1.4 V
1299.500 MHz	3.2 ~ 3.9 V

Idle Current

- Connect the 3.0 VDC power source, via the DC ammeter, to the battery terminal (not the EXT DC jack) on the VR-500.
- Set the SQL knob fully clockwise, and set the radio to the NFM mode.
- Disable the Battery Saver via MENU #5 (Save).
- Referring to table below, tune the VR-500 to each frequency listed, then confirm that the correct Idle Current is present.

Frequency	Idle Current
1.050 MHz	less than 60 mA
10.050 MHz	less than 60 mA
100.050 MHz	less than 60 mA
150.050 MHz	less than 60 mA
200.050 MHz	less than 60 mA
300.050 MHz	less than 60 mA
400.050 MHz	less than 60 mA
600.050 MHz	less than 60 mA
1299.950 MHz	less than 65 mA

2nd VCO VCV

- Connect the DC voltmeter to TP5, and referring to table below, tune the VR-500 to each frequency listed. Then confirm that the correct voltage is present.

Frequency	VGV Voltage
320.000 MHz	0.7 ~ 1.4 V
1000.000 MHz	1.4 ~ 2.1 V

Sensitivity

- Connect the RF Signal Generator to the Antenna jack.
- Set the VR-500 to NFM mode.
- Referring to table below, tune the RF Signal Generator and VR-500 to each frequency listed, then confirm that at least 12 dB SINAD is observed at the level shown.

Frequency	12 dB SINAD
30.050 MHz	Better than -3dBu
51.050 MHz	Better than -3dBu
107.950 MHz	Better than -3dBu
137.950 MHz	Better than -3dBu
145.950 MHz	Better than -2dBu
159.950 MHz	Better than 0dBu
160.050 MHz	Better than -3dBu
180.050 MHz	Better than -3dBu
230.050 MHz	Better than -3dBu
250.050 MHz	Better than -3dBu
369.950 MHz	Better than +6dBu
459.950 MHz	Better than -1dBu
469.950 MHz	Better than 0dBu
779.950 MHz	Better than +8dBu
835.050 MHz	Better than +5dBu
859.950 MHz	Better than +5dBu
1299.950 MHz	Better than +6dBu

- Set the VR-500 to WFM mode.
- Referring to the table below, tune the RF Signal Generator and VR-500 to each frequency listed, then confirm that at least 12 dB SINAD is observed at the level shown.

Frequency	12 dB SINAD
107.950 MHz	Better than +8dBu
224.950 MHz	Better than +9dBu
459.950 MHz	Better than +12dBu
619.950 MHz	Better than +15dBu
769.950 MHz	Better than +25dBu
1259.950 MHz	Better than +20dBu

Alignment

- Set the VR-500 to the AM mode.
- Referring to the table below, tune the RF Signal Generator and VR-500 to each frequency listed, then confirm that at least 10 dB S/N is observed at the frequency shown.

Frequency	10 dB S/N
0.285 MHz	Better than +20dBu
0.525 MHz	Better than +12dBu
2.050 MHz	Better than +15dBu
5.050 MHz	Better than +8dBu
49.950 MHz	Better than +7dBu
109.950 MHz	Better than +8dBu
138.050 MHz	Better than +7dBu
225.050 MHz	Better than +7dBu

- Set the VR-500 to the LSB mode.
- Referring to table below, tune the RF Signal Generator and VR-500 to each frequency listed, then confirm that at least 10 dB S/N is observed.

Frequency	10 dB S/N
2.050 MHz	Better than +6dBu
28.950 MHz	Better than -2dBu

- Set the VR-500 to the USB mode.
- Referring to table below, tune the RF Signal Generator and VR-500 to each frequency listed, then confirm that at least 10 dB S/N is observed.

Frequency	10 dB S/N
2.050 MHz	Better than +6dBu
28.950 MHz	Better than -2dBu

- Set the VR-500 to the CW mode.
- Referring to table below, tune the RF Signal Generator and VR-500 to each frequency listed, then confirm that at least 10 dB S/N is observed.

Frequency	10 dB S/N
2.050 MHz	Better than +6dBu
28.950 MHz	Better than -2dBu

S-meter & Squelch

Presetting (used in steps to follow)

- Disable the ATT function, if activated.
- Disable the Battery Saver, OFF Timer, and RF Squelch via MENU #5 (Save), MENU #6 (OFF Timer), and MENU #19 (RF Squelch) respectively, if these functions are activated.
- Set MENU # 1 (Receive Mode) to "MANUAL."
- Set these frequencies into the PMS memories:
 Low band edge frequency (1:L): 1250.3750 MHz
 Start Frequency (2:S): 123.1250 MHz
 High Band edge Frequency (3:U): 448.2500 MHz
- Presetting is now completed; the "Battery" icon will blink.

NFM S-meter

- Preset the VR-500 via the previous steps.
- Set the VR-500 to 100.050 MHz, NFM mode.
- Connect the RF Signal Generator to the Antenna jack.
- Press the [9] key while pressing the [FUNC] key to activate the S-meter adjustment process ("S Meter Set" will appear).
- Inject a 100.050 MHz, 20 dB μ (1 kHz tone @ ± 3.5 kHz deviation) signal from the RF Signal Generator. Press the [1] key while pressing the [FUNC] key, then press the [B.S] key until the beep is heard; this saves the new setting. This routine is the S-meter "Full-Scale" adjustment.
- Reduce the RF Signal Generator output level to -1 dB μ . Press the [2] key while pressing the [FUNC] key, and then press the [B.S] key until the beep is heard; this saves the new setting. This routine is the S-meter "S-2" adjustment.
- Press the [CLR] key to return to normal operation.
- Increase the RF Signal Generator output level so that the VR-500 S-meter deflection is "Full-Scale," and confirm that the RF Signal Generator output level is 20 dB μ ± 4 dB.
- Reduce the RF Signal Generator output level so that the VR-500 S-meter deflection is just "S-2," and confirm that the RF Signal Generator output level is -1 dB μ ± 4 dB.

WFM S-meter

- Preset the VR-500 via the procedure described above.
- Set the VR-500 to 100.050 MHz, WFM mode.
- Connect the RF Signal Generator to the Antenna jack.
- Press the [9] key while pressing the [FUNC] key to activate the S-meter adjustment process ("S Meter Set" will appear).
- Inject a 100.050 MHz, 40 dB μ (1 kHz tone @ ± 75 kHz deviation) signal from the RF Signal Generator. Press the [1] key while pressing the [FUNC] key, and then press the [B.S] key until the beep is heard; this saves the new setting. This routine is the S-meter "Full-Scale" adjustment.
- Reduce the RF Signal Generator output level to 10 dB μ . Press the [2] key while pressing the [FUNC] key, then press the [B.S] key. This routine is the S-meter "S-2" adjustment.
- Press the [CLR] key to return to normal operation.
- Increase the RF Signal Generator output level so that the VR-500 S-meter deflection is "Full-Scale," and confirm that the RF Signal Generator output level is 40 dB μ ± 4 dB.

- Reduce the RF Signal Generator output level so that the VR-500 S-meter deflection is just "S-2," and confirm that the RF Signal Generator output level is 10 dB μ \pm 4 dB.

AM S-meter

- Preset the VR-500 per the procedure described previously.
- Set the VR-500 to 1.050 MHz, AM mode.
- Connect the RF Signal Generator to the Antenna jack.
- Press the [9] key while pressing the [FUNC] key to activate the S-meter adjustment process ("S Meter Set" will appear).
- Inject a 1.050 MHz, 25 dB μ (1 kHz tone @ 30% modulation) signal from the RF Signal Generator. Press the [1] key while pressing the [FUNC] key, and then press the [B.S] key until the beep is heard; this saves the new setting. This routine is the S-meter "Full-Scale" adjustment.
- Reduce the RF Signal Generator output level to -2 dB μ ; press the [2] key while pressing the [FUNC] key, then press the [B.S] key. This routine is the S-meter "S-2" adjustment.
- Press the [CLR] key to return to normal operation.
- Increase the RF Signal Generator output level so that the VR-500 S-meter deflection is "Full-Scale," and confirm that the RF Signal Generator output level is 25 dB μ \pm 4 dB.
- Reduce the RF Signal Generator output level so that the VR-500 S-meter deflection is just "S-2," and confirm that the RF Signal Generator output level is -2 dB μ \pm 4 dB.

SSB S-meter

- Preset the VR-500 using the procedure described previously.
- Set the VR-500 to 10.050 MHz, LSB mode.
- Connect the RF Signal Generator to the Antenna jack.
- Press the [9] key while pressing the [FUNC] key to activate the S-meter adjustment process ("S Meter Set" will appear).
- Inject a 10.050 MHz, 30 dB μ signal from the RF Signal Generator. Press the [1] key while pressing the [FUNC] key, and then press the [B.S] key to until the beep is heard; this saves the new setting. This routine is the S-meter "Full-Scale" adjustment.
- Reduce the RF Signal Generator output level to -2 dB μ , then press the [2] key while pressing the [FUNC] key. This routine is the S-meter "S-2" adjustment.
- Press the [CLR] key to return to normal operation.

- Increase the RF Signal Generator output level so that the VR-500 S-meter deflection is "Full-Scale," and confirm that the RF Signal Generator output level is 30 dB μ \pm 4 dB.
- Reduce the RF Signal Generator output level so that the VR-500 S-meter deflection is just "S-2," and confirm that the RF Signal Generator output level is -2 dB μ \pm 4 dB.

NFM Squelch

- Preset the VR-500 using the procedure described previously.
- Set the VR-500 to 100.050 MHz, NFM mode.
- Connect the RF Signal Generator to the Antenna jack.
- Press the [8] key while pressing the [FUNC] key to activate the S-meter adjustment process ("Squelch Set" will appear).
- Inject a 100.050 MHz, 0 dB μ (1 kHz tone @ \pm 3.5 kHz deviation) signal from the RF Signal Generator. Press the [2] key while pressing the [FUNC] key, and then press the [B.S] key; this routine is the Squelch "Tight" adjustment.
- Reduce the RF Signal Generator output level to -15 dB μ . Press the [1] key while pressing the [FUNC] key, and then press the [B.S] key; this routine is the Squelch "threshold" adjustment.
- Press the [3] key while pressing the [FUNC] key, then press [BS] key until the beep is heard; this saves the new Squelch setting.
- Press the [CLR] key to return to normal operation.
- Turn off the RF Signal Generator and set the SQL knob so that the background noise is just silenced.
- Turn on the RF Signal Generator and increase the RF Signal Generator output level so that the VR-500 Squelch is just opened; confirm that the RF Signal Generator output level is -15 dB μ \pm 4 dB.
- Set the SQL knob fully clockwise, then increase the RF Signal Generator output level so that the VR-500 Squelch is just opened; confirm that the RF Signal Generator output level is 0 dB μ \pm 4 dB.

WFM Squelch

- Preset the VR-500 using the procedure described previously.
- Set the VR-500 to 100.050 MHz, WFM mode.
- Connect the RF Signal Generator to the Antenna jack.
- Press the [8] key while pressing the [FUNC] key to activate the S-meter adjustment process ("Squelch Set" will appear).
- Inject a 100.050 MHz, 20 dB μ (1 kHz tone @ \pm 3.5 kHz

Alignment

deviation) signal from the RF Signal Generator. Press the [2] key while pressing the [FUNC] key, and then press the [B.S] key; this routine is the Squelch "Tight" adjustment.

- Reduce the RF Signal Generator output level to -3 dB μ . Press the [1] key while pressing the [FUNC] key, and then press the [B.S] key; this routine is the Squelch "Threshold" adjustment.
- Press the [3] key while pressing the [FUNC] key, then press the [BS] key until the beep is heard; this saves the new Squelch setting.
- Press the [CLR] key to return to normal operation.
- Turn off the RF Signal Generator and set the SQL knob so that the background noise is just silenced.
- Turn on the RF Signal Generator and increase the RF Signal Generator output level so that the VR-500 Squelch is just opened; confirm that the RF Signal Generator output level is 20 dB μ ± 4 dB.
- Set the SQL knob fully clockwise, then increase the RF Signal Generator output level so that the VR-500 Squelch is just opened; confirm that the RF Signal Generator output level is -3 dB μ ± 4 dB.

AM Squelch

- Preset the VR-500 per the procedure described previously.
- Set the VR-500 to 1.050 MHz, AM mode.
- Connect the RF Signal Generator to the Antenna jack.
- Press the [8] key while pressing the [FUNC] key to activate the S-meter adjustment process ("Squelch Set" will appear).
- Inject a 1.050 MHz, 0 dB μ (1 kHz tone @ 30% modulation) signal from the RF Signal Generator. Press the [2] key while pressing the [FUNC] key, and then press the [B.S] key; this routine is the Squelch "Tight" adjustment.
- Reduce the RF Signal Generator output level to -15 dB μ . Press the [1] key while pressing the [FUNC] key, and then press the [B.S] key; this routine is the Squelch "Threshold" adjustment.
- Press the [3] key while pressing the [FUNC] key, then press [BS] key until the beep is heard; this saves the new Squelch setting.
- Press the [CLR] key to return to normal operation.
- Turn off the RF Signal Generator and set the SQL knob so that the background noise is just silenced.
- Turn on the RF Signal Generator and increase the RF Signal Generator output level so that the VR-500 Squelch is just opened; confirm that the RF Signal Generator output level is 0 dB μ ± 4 dB.

- Set the SQL knob fully clockwise, then increase the RF Signal Generator output level so that the VR-500 Squelch is just opened; confirm that the RF Signal Generator output level is -15 dB μ ± 4 dB.

LSB Squelch

- Preset the VR-500 per the procedure described previously.
- Set the VR-500 to 10.050 MHz, LSB mode.
- Connect the RF Signal Generator to the Antenna jack.
- Press the [8] key while pressing the [FUNC] key to activate the S-meter adjustment process ("Squelch Set" will appear).
- Inject a 10.050 MHz, -1 dB μ signal from the RF Signal Generator. Press the [2] key while pressing the [FUNC] key, and then press the [B.S] key; this routine is the Squelch "Tight" adjustment.
- Reduce the RF Signal Generator output level to -14 dB μ . Press the [1] key while pressing the [FUNC] key, and then press the [B.S] key; this routine is the Squelch "Threshold" adjustment.
- Press the [3] key while pressing the [FUNC] key, then press [BS] key until the beep is heard; this saves the new Squelch setting.
- Press the [CLR] key to return to normal operation.
- Turn off the RF Signal Generator and set the SQL knob so that the background noise is just silenced.
- Turn on the RF Signal Generator and increase the RF Signal Generator output level so that the VR-500 Squelch is just opened; confirm that the RF Signal Generator output level is -1 dB μ ± 4 dB.
- Set the SQL knob fully clockwise, then increase the RF Signal Generator output level so that the VR-500 Squelch is just opened; confirm that the RF Signal Generator output level is -14 dB μ ± 4 dB.

AF Output

- Connect the RF Signal Generator to the Antenna jack, and connect the DC volt meter and 8Ω dummy load to the SP jack.
- Connect the 13.8 VDC power source to the EXT DC jack.
- Set the VR-500 to 100.050 MHz NFM mode, and rotate the VOL knob fully clockwise.
- Inject a 60 dB μ from the RF Signal Generator; confirm that the DC voltmeter reading is more than 1.10 V (150 mW with 8Ω load).
- Disconnect the 13.8 VDC power source from the EXT DC jack, then connect the 3.0 VDC power source to the Battery terminal; confirm that the DC voltmeter

reading is more than 0.85 V (90 mW with 8 Ω load).

- Repeat the above steps in the WFM, AM, LSB, USB, and CW modes, and confirm that the AF output level is more than 150 mW @ 13.8 VDC and 90 mW @ 3.0 VDC.

ATT

- Set the VR-500 to 100.050 MHz, NFM mode.
- Connect the RF Signal Generator to the Antenna jack.
- Inject a 100.050 MHz, NFM signal from the RF Signal Generator; confirm that the 12 dB SINAD difference between the ATT "ON" and "OFF" conditions is 15 ~ 25 dB.

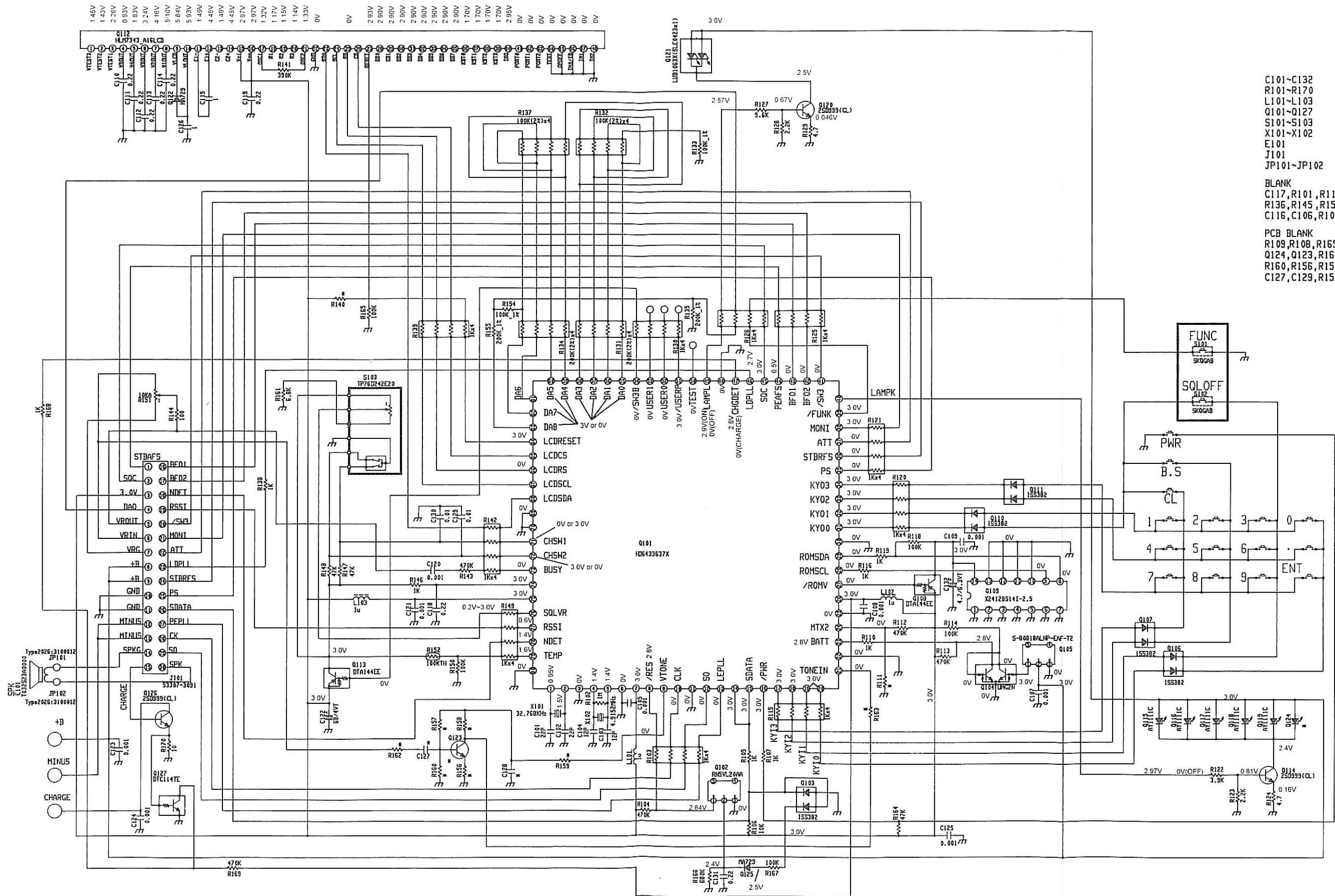

- C101-C132
- R101-R170
- L101-L103
- Q101-Q103
- S101-S103
- X101-X102
- E101
- J101
- JP101-JP102

- BLANK
- C117, R101, R117
- R136, R145, R153
- C116, C106, R108, R109

- PCB BLANK
- R109, R108, R165, R111
- Q124, Q123, R162, R157
- R160, R156, R158, R163
- C127, C129, R159, R140

Parts Layout

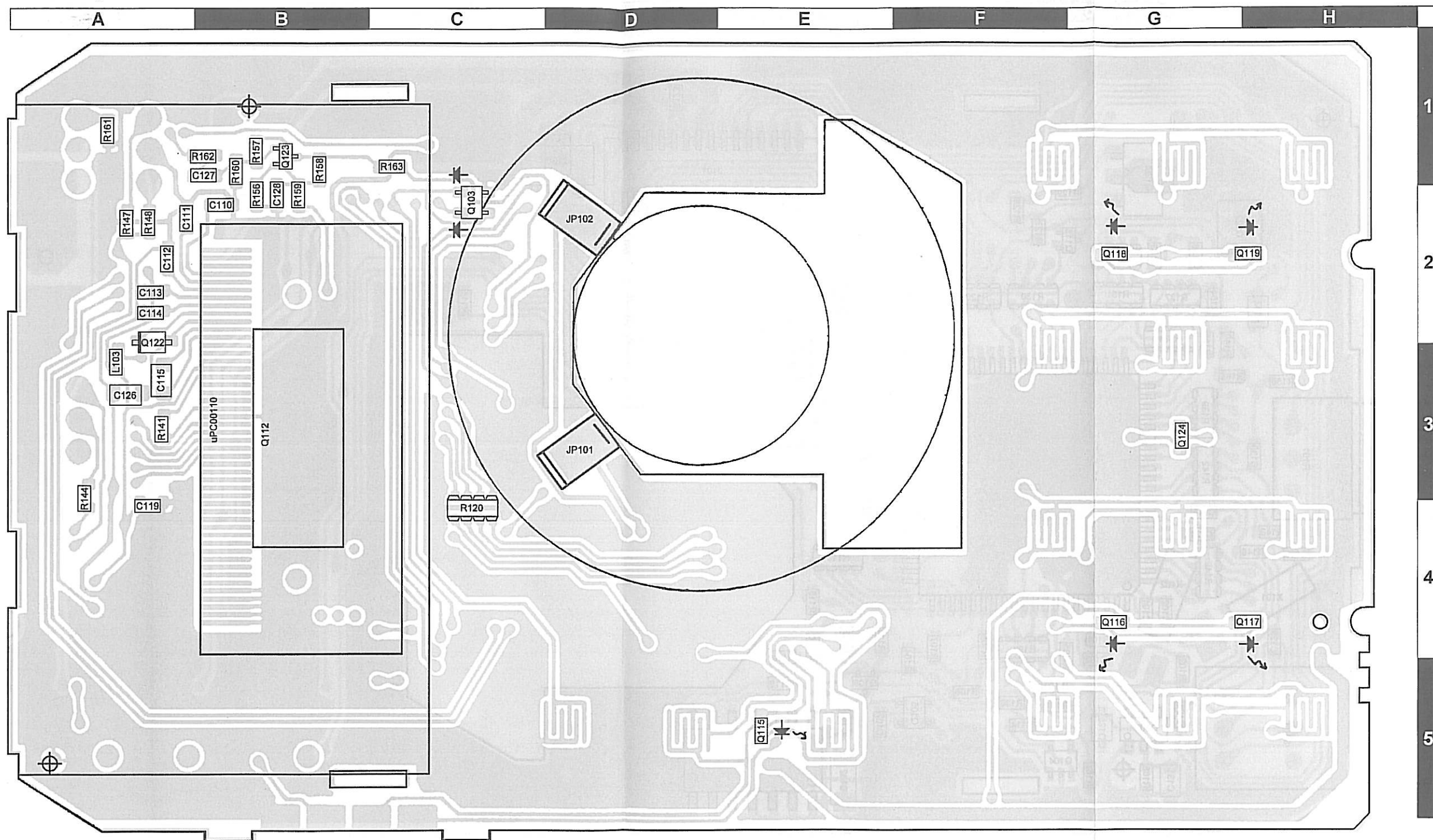

Side A

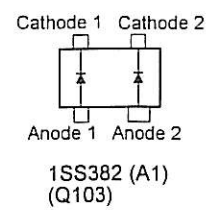

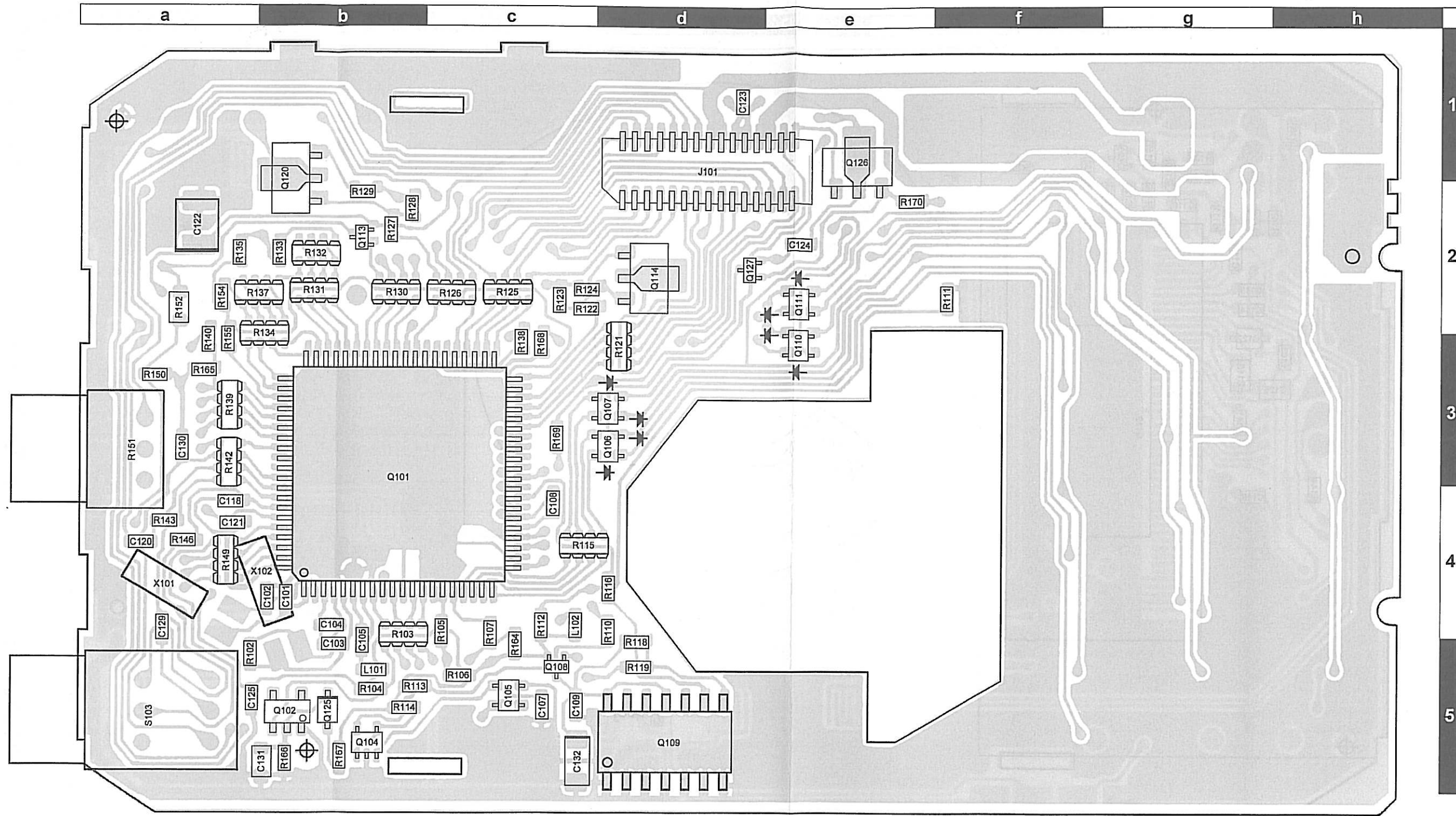

Side B

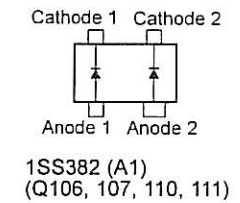
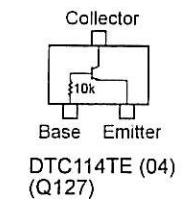
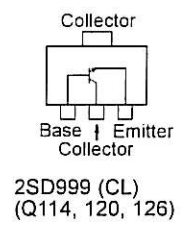
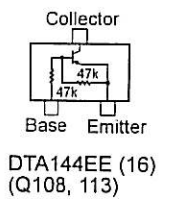
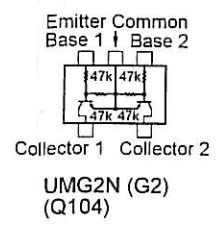
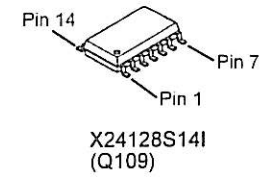
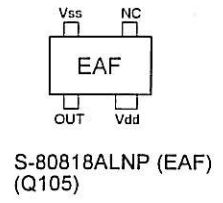
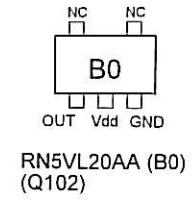
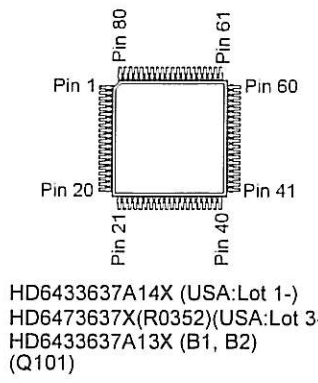

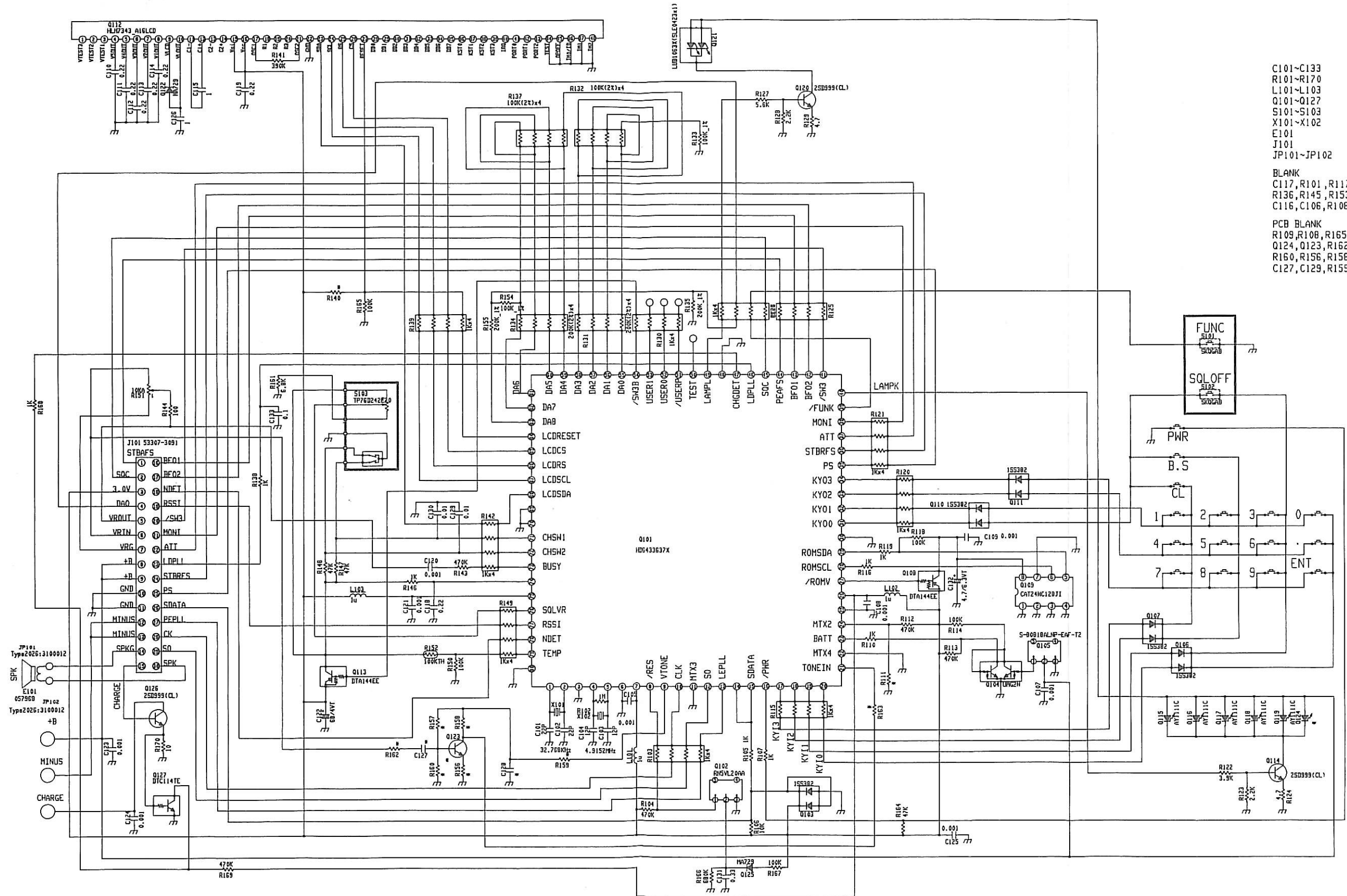

- C101~C133
- R101~R170
- L101~L103
- Q101~Q127
- S101~S103
- X101~X102
- E101
- J101
- JP101~JP102

- BLANK
- C117, R101, R117
- R136, R145, R153
- C116, C106, R108, R109

- PCB BLANK
- R109, R108, R165, R111
- Q124, Q123, R162, R157
- R160, R156, R158, R163
- C127, C129, R159, R140

Parts Layout

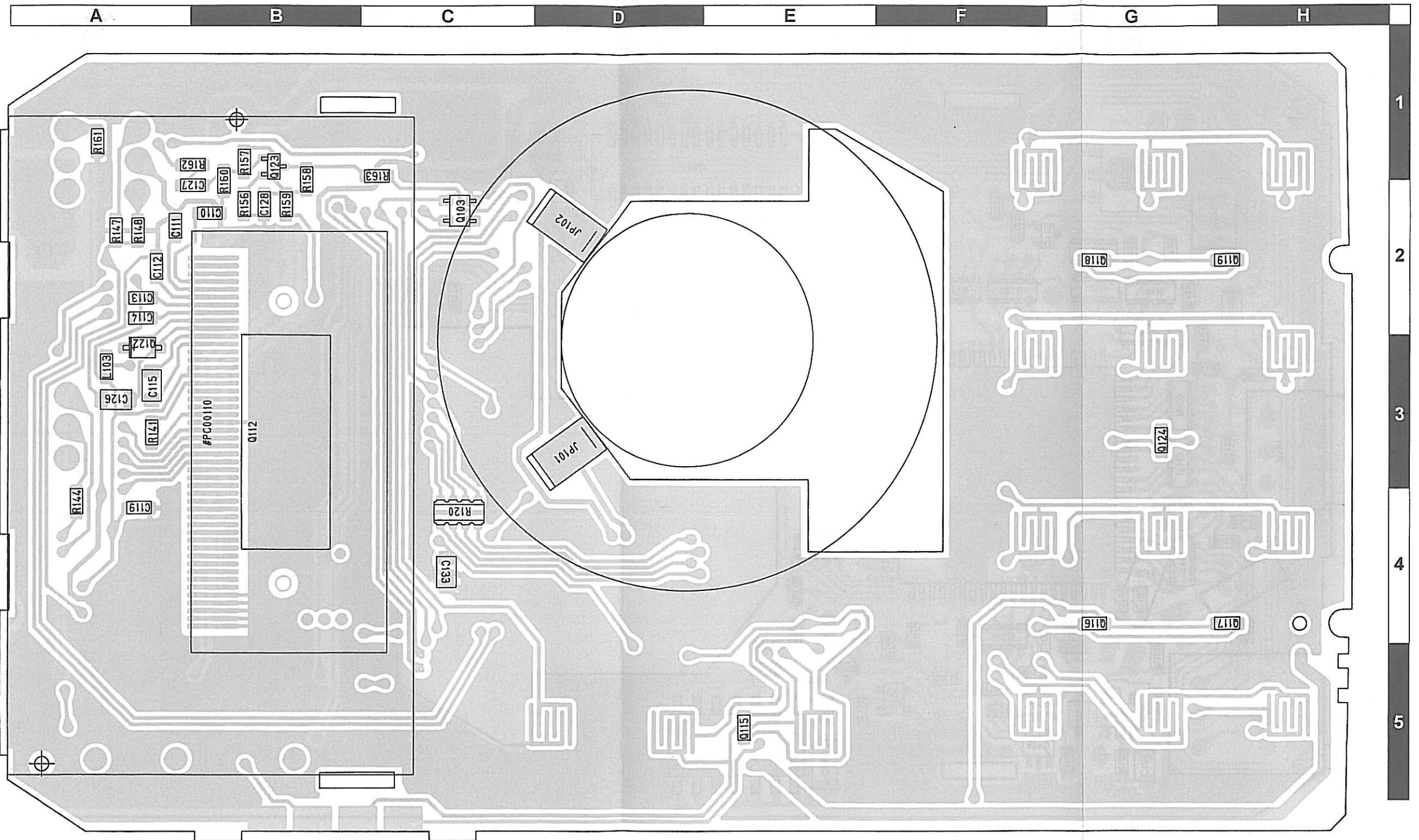

Side A

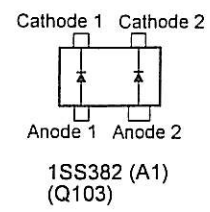

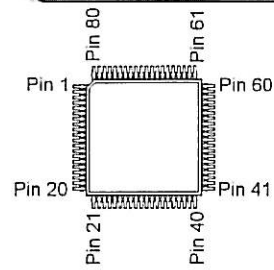
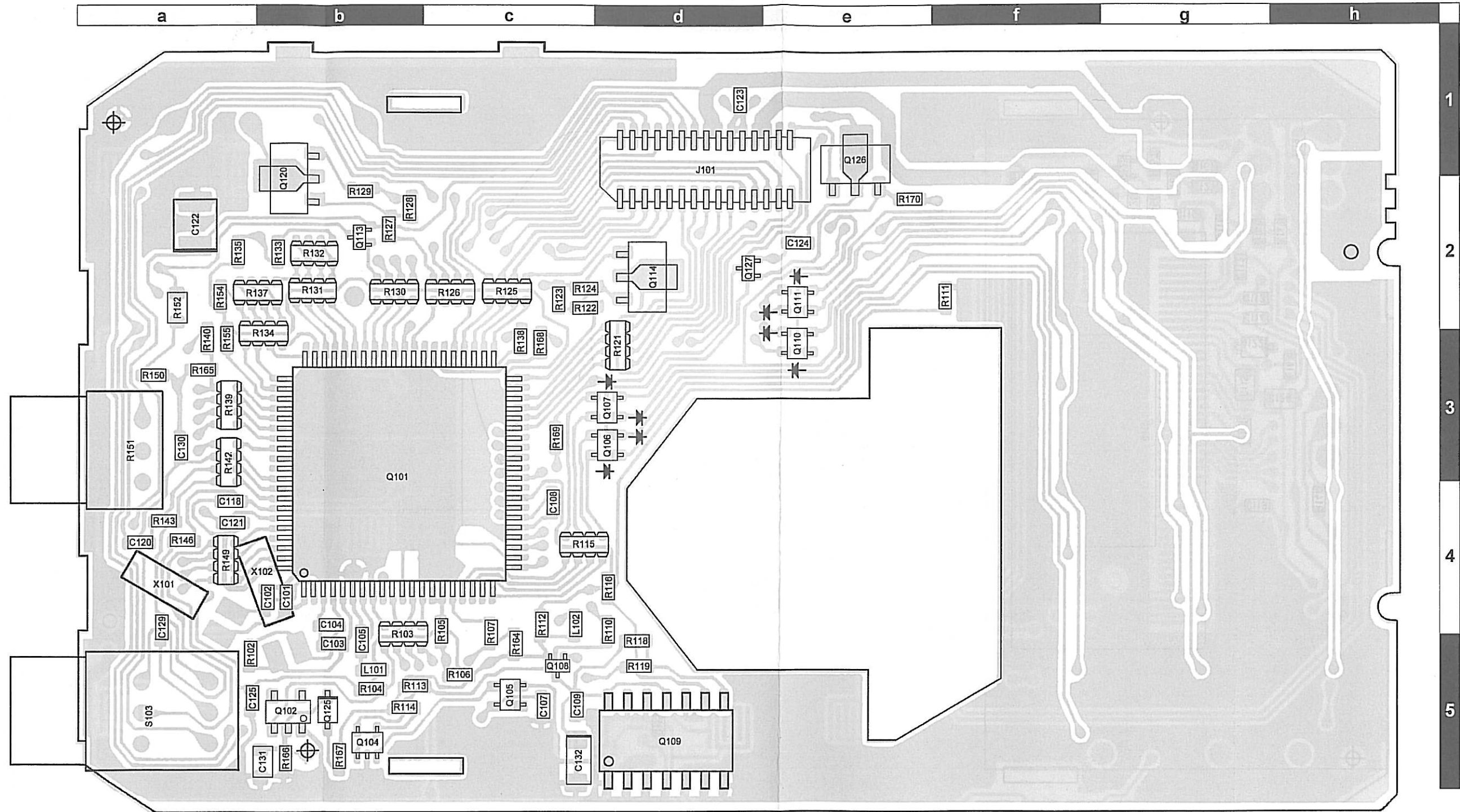

HD6433637A14X (USA:Lot 1-)
 HD6473637X(R0352)(USA:Lot 3-)
 HD6433637A20X(R0352)(USA:Lot 11-)
 HD6433637A13X (B1, B2)
 (Q101)

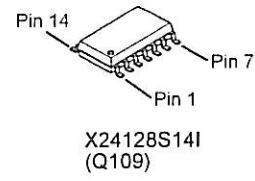
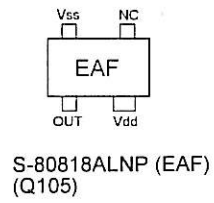
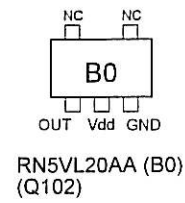

Side B

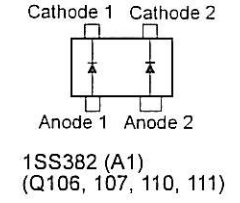
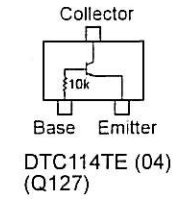
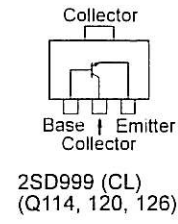
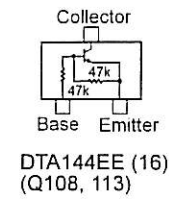
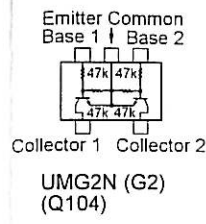

Parts List

REF.	DESCRIPTION	VALUE	V/W	TOL.	MFR'S DESIG	VXSTD P/N	VERS.	LOT.	SIDE	LAY ADR
*** μCOM UNIT ***										
	PCB with Components	(USA)				Q7000364	VERSION USA			
	PCB with Components	(EXP)				Q7000365	VERSION B1			
	PCB with Components	(EXP)				Q7000366	VERSION B2			
C101	CHIP CAP.	22pF	50V	CH	GRM39CH220J50PT	K22174219		1-	B	
C102	CHIP CAP.	22pF	50V	CH	GRM39CH220J50PT	K22174219		1-	B	
C103	CHIP CAP.	12pF	50V	CH	GRM39CH120J50PT	K22174213		1-	B	
C104	CHIP CAP.	12pF	50V	CH	GRM39CH120J50PT	K22174213		1-	B	
C105	CHIP CAP.	0.001uF	50V	B	GRM39B102K50PT	K22174821		1-	B	
C107	CHIP CAP.	0.001uF	50V	B	GRM39B102K50PT	K22174821		1-	B	
C108	CHIP CAP.	0.001uF	50V	B	GRM39B102K50PT	K22174821		1-	B	
C109	CHIP CAP.	0.001uF	50V	B	GRM39B102K50PT	K22174821		1-	B	
C110	CHIP CAP.	0.22uF	10V	B	GRM39B224K10PT	K22104801		1-	A	
C111	CHIP CAP.	0.22uF	10V	B	GRM39B224K10PT	K22104801		1-	A	
C112	CHIP CAP.	0.22uF	10V	B	GRM39B224K10PT	K22104801		1-	A	
C113	CHIP CAP.	0.22uF	10V	B	GRM39B224K10PT	K22104801		1-	A	
C114	CHIP CAP.	0.22uF	10V	B	GRM39B224K10PT	K22104801		1-	A	
C115	CHIP CAP.	1uF	10V	B	GRM40B105K10PT	K22100802		1-	A	
C118	CHIP CAP.	0.22uF	10V	B	GRM39B224K10PT	K22104801		1-	B	
C119	CHIP CAP.	0.22uF	10V	B	GRM39B224K10PT	K22104801		1-	A	
C120	CHIP CAP.	0.001uF	50V	B	GRM39B102K50PT	K22174821		1-	B	
C121	CHIP CAP.	0.001uF	50V	B	GRM39B102K50PT	K22174821		1-	B	
C122	CHIP TA.CAP.	68uF			TEMSVB20G686M-8R	K78060033		1-	B	
C123	CHIP CAP.	0.001uF	50V	B	GRM39B102K50PT	K22174821		1-	B	
C124	CHIP CAP.	0.001uF	50V	B	GRM39B102K50PT	K22174821		1-	B	
C125	CHIP CAP.	0.001uF	50V	B	GRM39B102K50PT	K22174821		1-	B	
C126	CHIP CAP.	1uF	10V	B	GRM40B105K10PT	K22100802		1-	A	
C129	CHIP CAP.	0.01uF	25V	B	GRM39B103K25PT	K22144803		1-	B	
C130	CHIP CAP.	0.01uF	25V	B	GRM39B103K25PT	K22144803		1-	B	
C131	CHIP CAP.	0.22uF	16V	B	GRM40B224M16PT	K22120806		1-	B	
C131	CHIP CAP.	0.33uF	16V	B	GRM40B334K16PT	K22120807		11-	B	
C132	CHIP TA.CAP.	4.7uF	6.3V		TEMSVA0J475M-8R	K78080017		1-	B	
C133	CHIP CAP.	0.1uF	25V	B	GRM40B104M25PT	K22140811	USA	11-		
C133	CHIP CAP.	0.1uF	16V	B	GRM39B104K16PT	K22124805	B1	7-		
C133	CHIP CAP.	0.1uF	16V	B	GRM39B104K16PT	K22124805	B2	7-		
C133	CHIP CAP.	0.1uF	25V	B	GRM40B104M25PT	K22140811	B1	9-		
C133	CHIP CAP.	0.1uF	25V	B	GRM40B104M25PT	K22140811	B2	9-		
E101	SPEAKER				T032S23A0000	S8100785		1-	A	
J101	CONNECTOR				53307-3091	P1091066		1-	B	
JP101	SHIELD FINGER				2026 3100012	S5000196		1-	A	
JP102	SHIELD FINGER				2026 3100012	S5000196		1-	A	
L101	M.RFC	1uH			MLF1608A1R0KT	L1690930		1-	B	
L102	M.RFC	1uH			MLF1608A1R0KT	L1690930		1-	B	
L103	M.RFC	1uH			MLF1608A1R0KT	L1690930		1-	A	
Q101	IC				HD6433637A14X	S8100820	USA	1-	B	b3
Q101	IC				HD6473637X(R0352)	S8100884	USA	3-	B	b3
Q101	IC				HD6433637A20X(R0352)	S8100908	USA	11-	B	b3
Q101	IC				HD6433637A13X	S8100819	B1	1-	B	b3
Q101	IC				HD6433637A13X	S8100819	B2	1-	B	b3
Q102	IC				RN5VL20AA-TR	G1093071		1-	B	b5
Q103	DIODE				1SS382(TE85R)	G2070732		1-	A	C2
Q104	TRANSISTOR				UMG2N TR	G3070088		1-	B	b5
Q105	IC				S-80818ALNP-EAF-T2	G1093073		1-	B	c5
Q106	DIODE				1SS382(TE85R)	G2070732		1-	B	d3
Q107	DIODE				1SS382(TE85R)	G2070732		1-	B	d3
Q108	TRANSISTOR				DTA144EE TL	G3070074		1-	B	c5
Q109	IC				X24128S14I-2.5	G1093079		1-	B	d5
Q109	IC				CAT24WC128JI-TE13	G1093247		8-	B	d5
Q110	DIODE				1SS382(TE85R)	G2070732		1-	B	e3
Q111	DIODE				1SS382(TE85R)	G2070732		1-	B	e2
Q112	LCD				HLM7343	S8100787		1-	A	B3
Q113	TRANSISTOR				DTA144EE TL	G3070074		1-	B	b2
Q114	TRANSISTOR				2SD999-T1 CL	G3409998L		1-	B	d2
Q115	LED				AY1111C-TR	G2070740		1-	A	E5
Q116	LED				AY1111C-TR	G2070740		1-	A	G4
Q117	LED				AY1111C-TR	G2070740		1-	A	H4
Q118	LED				AY1111C-TR	G2070740		1-	A	G2

CAT24WC128JI

G1093247

μCOM Unit

REF.	DESCRIPTION	VALUE	V/W	TOL.	MFR'S DESIG	VXSTD P/N	VERS.	LOT.	SIDE	LAY ADR
Q119	LED				AY1111C-TR	G2070740		1-	A	G2
Q120	TRANSISTOR				2SD999-T1 CL	G3409998L		1-	B	b1
Q121	LED				LUB1063X(SLE0423x1)	S8100777		1-	A	B3
Q122	DIODE				MA729-(TX)	G2070320		1-	A	A2
Q125	DIODE				MA729-(TX)	G2070320		1-	B	b5
Q126	TRANSISTOR				2SD999-T1 CL	G3409998L		1-	B	e1
Q127	TRANSISTOR				DTC114TE TL	G3070225		1-	B	d2
Q128	DIODE				1SS387(TPL3)	G2070606	B1	7-8	B	c3
Q128	DIODE				1SS387(TPL3)	G2070606	B2	7-8	B	c3
R102	CHIP RES.	1M	1/16W	5%	RMC1/16 105JATP	J24185105		1-	B	
R103	CHIP RES.	1k		5%	TSMB08WJ102V	S8100792		1-	B	
R104	CHIP RES.	470k	1/16W	5%	RMC1/16 474JATP	J24185474		1-	B	
R105	CHIP RES.	1k	1/16W	5%	RMC1/16 102JATP	J24185102		1-	B	
R106	CHIP RES.	10k	1/16W	5%	RMC1/16 103JATP	J24185103		1-	B	
R107	CHIP RES.	1k	1/16W	5%	RMC1/16 102JATP	J24185102		1-	B	
R110	CHIP RES.	1k	1/16W	5%	RMC1/16 102JATP	J24185102		1-	B	
R111	CHIP RES.	0	1/16W	5%	RMC1/16 000JATP	J24185000		1-	B	
R111	CHIP RES.	0	1/16W	5%	RMC1/16 000JATP	J24185000	B1	5-	B	
R112	CHIP RES.	470k	1/16W	5%	RMC1/16 474JATP	J24185474		1-	B	
R113	CHIP RES.	470k	1/16W	5%	RMC1/16 474JATP	J24185474		1-	B	
R114	CHIP RES.	100k	1/16W	5%	RMC1/16 104JATP	J24185104		1-	B	
R115	CHIP RES.	1k		5%	TSMB08WJ102V	S8100792		1-	B	
R116	CHIP RES.	1k	1/16W	5%	RMC1/16 102JATP	J24185102		1-	B	
R118	CHIP RES.	100k	1/16W	5%	RMC1/16 104JATP	J24185104		1-	B	
R119	CHIP RES.	1k	1/16W	5%	RMC1/16 102JATP	J24185102		1-	B	
R120	CHIP RES.	1k		5%	TSMB08WJ102V	S8100792		1-	A	
R121	CHIP RES.	1k		5%	TSMB08WJ102V	S8100792		1-	B	
R122	CHIP RES.	3.9k	1/16W	5%	RMC1/16 392JATP	J24185392		1-	B	
R123	CHIP RES.	2.2k	1/16W	5%	RMC1/16 222JATP	J24185222		1-	B	
R124	CHIP RES.	4.7	1/16W	5%	RMC1/16 4R7JATP	J24185479		1-	B	
R125	CHIP RES.	1k		5%	TSMB08WJ102V	S8100792		1-	B	
R126	CHIP RES.	1k		5%	TSMB08WJ102V	S8100792		1-	B	
R127	CHIP RES.	5.6k	1/16W	5%	RMC1/16 562JATP	J24185562		1-	B	
R128	CHIP RES.	2.2k	1/16W	5%	RMC1/16 222JATP	J24185222		1-	B	
R129	CHIP RES.	4.7	1/16W	5%	RMC1/16 4R7JATP	J24185479		1-	B	
R130	CHIP RES.	1k		5%	TSMB08WJ102V	S8100792		1-	B	
R131	CHIP RES.	200k		2%	TSMB08WG204V	S8100791		1-	B	
R132	CHIP RES.	100k		2%	TSMB08WG104V	S8100790		1-	B	
R133	CHIP RES.	100k	1/16W	1%	RMC1/16 104FTP	J24183104		1-	B	
R134	CHIP RES.	200k		2%	TSMB08WG204V	S8100791		1-	B	
R135	CHIP RES.	200k	1/16W	1%	RMC1/16 204FTP	J24183204		1-	B	
R137	CHIP RES.	100k		2%	TSMB08WG104V	S8100790		1-	B	
R138	CHIP RES.	1k	1/16W	5%	RMC1/16 102JATP	J24185102		1-	B	
R138	CHIP RES.	330k	1/16W	5%	RMC1/16 334JATP	J24185334	B1	7-	B	
R138	CHIP RES.	330k	1/16W	5%	RMC1/16 334JATP	J24185334	B2	7-	B	
R138	CHIP RES.	1k	1/16W	5%	RMC1/16 102JATP	J24185102	B1	9-	B	
R138	CHIP RES.	1k	1/16W	5%	RMC1/16 102JATP	J24185102	B2	9-	B	
R139	CHIP RES.	1k		5%	TSMB08WJ102V	S8100792		1-	B	
R141	CHIP RES.	390k	1/16W	5%	RMC1/16 394JATP	J24185394		1-	A	
R142	CHIP RES.	1k		5%	TSMB08WJ102V	S8100792		1-	B	
R143	CHIP RES.	470k	1/16W	5%	RMC1/16 474JATP	J24185474		1-	B	
R144	CHIP RES.	100	1/16W	5%	RMC1/16 101JATP	J24185101		1-	A	
R146	CHIP RES.	1k	1/16W	5%	RMC1/16 102JATP	J24185102		1-	B	
R147	CHIP RES.	47k	1/16W	5%	RMC1/16 473JATP	J24185473		1-	A	
R148	CHIP RES.	47k	1/16W	5%	RMC1/16 473JATP	J24185473		1-	A	
R149	CHIP RES.	1k	1/8W	5%	TSMB08WJ102V	S8100792		1-	B	
R150	CHIP RES.	100k	1/16W	5%	RMC1/16 104JATP	J24185104		1-	B	
R151	POT.				TP76N00-10KA	S8100789		1-	B	
R152	THERMISTOR				NT732A104K	G9090125		1-	B	
R154	CHIP RES.	100k	1/16W	1%	RMC1/16 104FTP	J24183104		1-	B	
R155	CHIP RES.	200k	1/16W	1%	RMC1/16 204FTP	J24183204		1-	B	
R161	CHIP RES.	6.8k	1/16W	5%	RMC1/16 682JATP	J24185682		1-	A	
R164	CHIP RES.	47k	1/16W	5%	RMC1/16 473JATP	J24185473		1-	B	
R165	CHIP RES.	100k	1/16W	5%	RMC1/16 104JATP	J24185104		1-	B	
R166	CHIP RES.	680k	1/16W	5%	RMC1/16 684JATP	J24185684		1-	B	
R167	CHIP RES.	100k	1/16W	5%	RMC1/16 104JATP	J24185104		1-	B	
R168	CHIP RES.	1k	1/16W	5%	RMC1/16 102JATP	J24185102		1-	B	

REF.	DESCRIPTION	VALUE	V/W	TOL.	MFR'S DESIG	VXSTD P/N	VERS.	LOT.	SIDE	LAY ADR
R169	CHIP RES.	470k	1/16W	5%	RMC1/16 474JATP	J24185474		1-	B	
R170	CHIP RES.	10	1/16W	5%	RK73K2AS100J	S8100793		1-	B	
S103	ROTARY SWITCH				TP76D242E20	S8100784		1-	B	
X101	XTAL	32.768KHz			C-002RX-ZA-32.768KHz	S8100778		1-	B	
X102	XTAL	4.9152MHz			38CHT 4.9152MHz	S8100780		1-	B	
X102	XTAL	4.9152MHz			AT-38 4.9152MHz	S8100882		8-	B	
	LCD COVER					S8001724		1-		
	TAPE					S8001725		1-		

μ COM Unit

Note:

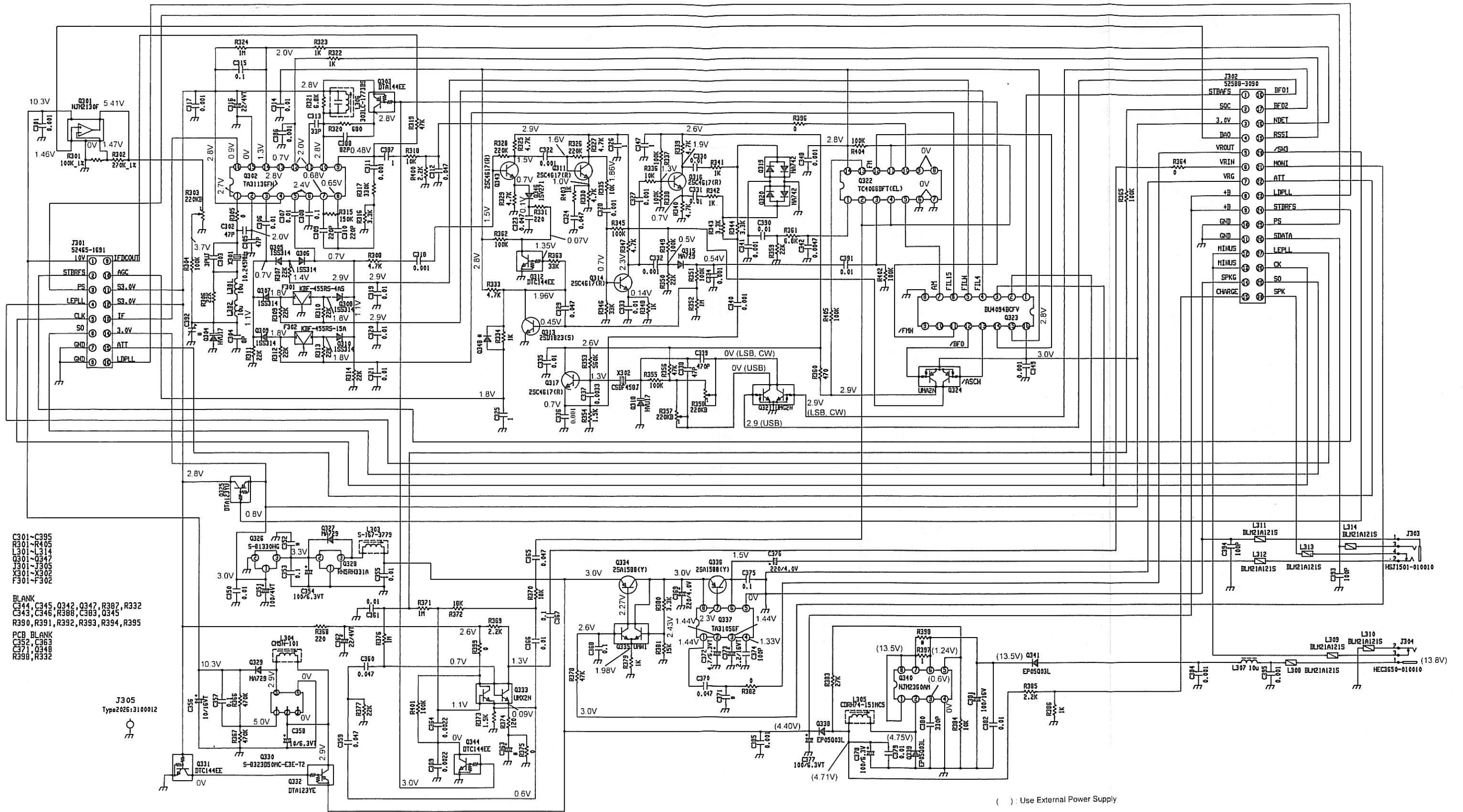

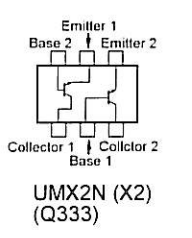
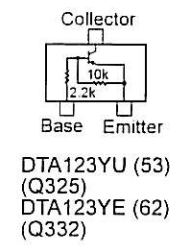
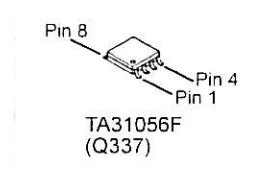
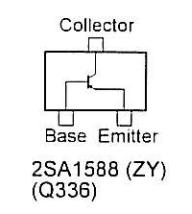
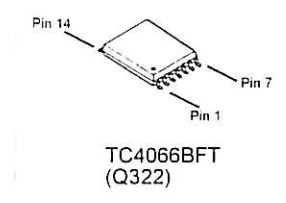
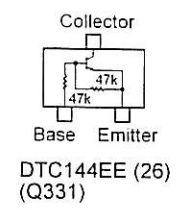
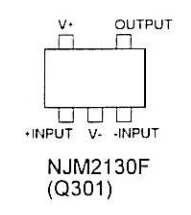
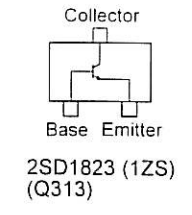

Parts List

REF.	DESCRIPTION	VALUE	V/W	TOL.	MFR'S DESIG	VXSTD P/N	VERS.	LOT.	SIDE	LAY ADR
*** AF UNIT ***										
PCB with Components						Q7000367				
C301	CHIP CAP.	0.001uF	50V	B	GRM39B102K50PT	K22174821		1-	A	
C302	CHIP CAP.	47pF	50V	CH	GRM39CH470J50PT	K22174227		1-	B	
C303	CHIP CAP.	3pF	50V	UJ	GRM39UJ030B50PT	K22174337		1-	B	
C304	CHIP CAP.	8pF	50V	CH	GRM39CH080D50PT	K22174209		1-	B	
C305	CHIP CAP.	47pF	50V	CH	GRM39CH470J50PT	K22174227		1-	B	
C306	CHIP CAP.	0.01uF	25V	B	GRM39B103K25PT	K22144803		1-	A	
C307	CHIP CAP.	0.01uF	25V	B	GRM39B103K25PT	K22144803		1-	A	
C308	CHIP CAP.	0.1uF	16V	B	GRM39B104K16PT	K22124805		1-	A	
C309	CHIP CAP.	220pF	50V	CH	GRM39CH221J50PT	K22174243		1-	B	
C310	CHIP CAP.	220pF	50V	CH	GRM39CH221J50PT	K22174243		1-	B	
C311	CHIP CAP.	0.001uF	50V	B	GRM39B102K50PT	K22174821		1-	B	
C312	CHIP CAP.	0.047uF	16V	B	GRM39B473K16PT	K22124804		1-	B	
C313	CHIP CAP.	33pF	50V	CH	GRM39CH330J50PT	K22174223		1-	A	
C314	CHIP CAP.	0.01uF	25V	B	GRM39B103K25PT	K22144803		1-	A	
C315	CHIP CAP.	0.1uF	16V	B	GRM39B104K16PT	K22124805		1-	A	
C315	CHIP CAP.	0.047uF	16V	B	GRM39B473K16PT	K22124800	B1	7-	A	
C315	CHIP CAP.	0.047uF	16V	B	GRM39B473K16PT	K22124800	B2	7-	A	
C316	CHIP TA.CAP.	22uF	6.3V		TEMSVA0J226M-8R	K78080047		1-	B	
C316	CHIP TA.CAP.	22uF	4V		TEMSVA0G226M-8R	K78060023		2-	B	
C317	CHIP CAP.	0.001uF	50V	B	GRM39B102K50PT	K22174821		1-	B	
C318	CHIP CAP.	0.001uF	50V	B	GRM39B102K50PT	K22174821		1-	A	
C319	CHIP CAP.	0.01uF	25V	B	GRM39B103K25PT	K22144803		1-	A	
C320	CHIP CAP.	0.01uF	25V	B	GRM39B103K25PT	K22144803		1-	A	
C321	CHIP CAP.	0.01uF	25V	B	GRM39B103K25PT	K22144803		1-	A	
C322	CHIP CAP.	0.001uF	50V	B	GRM39B102K50PT	K22174821		1-	A	
C323	CHIP CAP.	0.047uF	16V	B	GRM39R473K16PT	K22124810		1-	A	
C324	CHIP CAP.	0.047uF	16V	B	GRM39R473K16PT	K22124810		1-	A	
C325	CHIP CAP.	1uF	10V	B	GRM40B105K10PT	K22100802		1-	B	
C326	CHIP CAP.	1uF	10V	B	GRM40B105K10PT	K22100802		1-	A	
C327	CHIP CAP.	0.001uF	50V	B	GRM39B102K50PT	K22174821		1-	A	
C328	CHIP CAP.	0.001uF	50V	B	GRM39B102K50PT	K22174821		1-	A	
C329	CHIP CAP.	0.047uF	16V	B	GRM39B473K16PT	K22124804		1-	B	
C330	CHIP CAP.	0.01uF	25V	B	GRM39B103K25PT	K22144803		1-	A	
C331	CHIP CAP.	0.01uF	25V	B	GRM39B103K25PT	K22144803		1-	A	
C332	CHIP CAP.	0.001uF	50V	B	GRM39B102K50PT	K22174821		1-	A	
C333	CHIP CAP.	0.01uF	25V	B	GRM39B103K25PT	K22144803		1-	A	
C334	CHIP CAP.	0.001uF	50V	B	GRM39B102K50PT	K22174821		1-	A	
C335	CHIP CAP.	0.01uF	25V	B	GRM39B103K25PT	K22144803		1-	A	
C336	CHIP CAP.	470pF	50V	B	GRM39B102K50PT	K22174821		1-	A	
C336	CHIP CAP.	0.001uF	50V	B	GRM39B102K50PT	K22174821	USA	5-	A	
C336	CHIP CAP.	0.001uF	50V	B	GRM39B102K50PT	K22174821	B1	5-	A	
C336	CHIP CAP.	0.001uF	50V	B	GRM39B102K50PT	K22174821	B2	5-	A	
C337	CHIP CAP.	0.0033uF	50V	B	GRM39B332K50PT	K22174831		1-	A	
C338	CHIP CAP.	47pF	50V	CH	GRM39CH470J50PT	K22174227		1-	B	
C338	CHIP CAP.	68pF	50V	CH	GRM39CH680J50PT	K22174231		4-	B	
C339	CHIP CAP.	470pF	50V	CH	GRM39CH471J50PT	K22174249		1-	B	
C340	CHIP CAP.	0.001uF	50V	B	GRM39B102K50PT	K22174821		1-	A	
C341	CHIP CAP.	0.001uF	50V	B	GRM39B102K50PT	K22174821		1-	B	
C342	CHIP CAP.	0.0047uF	50V	B	GRM39B472K50PT	K22174833		1-	B	
C347	CHIP CAP.	1uF	10V	B	GRM40B105K10PT	K22100802		1-	A	
C348	CHIP CAP.	0.001uF	50V	B	GRM39B102K50PT	K22174821		1-	B	
C349	CHIP CAP.	0.001uF	50V	B	GRM39B102K50PT	K22174821		1-	A	
C350	CHIP CAP.	0.01uF	25V	B	GRM39B103K25PT	K22144803		1-	A	
C351	CHIP TA.CAP.	100uF	4V		TEMSVC0G107M12R	K78060021		1-	B	
C351	CHIP TA.CAP.	220uF	4V		SK4-0G227M-RD	K78060014		11-	B	
C353	CHIP CAP.	0.1uF	16V	B	GRM39B104K16PT	K22124805		1-	A	
C354	CHIP TA.CAP.	100uF	6.3V		TEMSVC0J107M12R	K78080049		1-	A	
C355	CHIP CAP.	0.01uF	25V	B	GRM39B103K25PT	K22144803		1-	A	
C356	CHIP TA.CAP.	10uF	16V		TEMSVB21C106M-8R	K78120025		1-	A	
C357	CHIP CAP.	0.1uF	16V	B	GRM39B104K16PT	K22124805		1-	A	
C358	CHIP TA.CAP.	10uF	6.3V		TEMSVA0J106M-8R	K78080027		1-	A	
C359	CHIP CAP.	0.047uF	16V	B	GRM39R473K16PT	K22124810		1-	B	
C360	CHIP CAP.	0.047uF	16V	B	GRM39R473K16PT	K22124810		1-	B	
C361	CHIP CAP.	0.01uF	25V	B	GRM39B103K25PT	K22144803		1-	B	
C362	CHIP TA.CAP.	22uF	6.3V		TEMSVA0J226M-8R	K78080047		1-	B	

AF Unit

REF.	DESCRIPTION	VALUE	V/W	TOL.	MFR'S DESIG	VXSTD P/N	VERS.	LOT.	SIDE	LAY ADR
C362	CHIP TA.CAP.	22uF	4V		TEMSVA0G226M-8R	K78060023		2-	B	
C364	CHIP CAP.	0.0022uF	50V	B	GRM39B222K50PT	K22174822		1-	B	
C365	CHIP CAP.	0.047uF	16V	B	GRM39R473K16PT	K22124810		1-	B	
C366	CHIP CAP.	0.01uF	25V	B	GRM39B103K25PT	K22144803		1-	B	
C367	CHIP CAP.	0.1uF	16V	B	GRM39B104K16PT	K22124805		1-	B	
C368	CHIP CAP.	0.1uF	16V	B	GRM39B104K16PT	K22124805		1-	A	
C369	AL.ELECTRO.CAP.	220uF	4V		UZS0G221MCR1GB	K48060006		1-	B	
C370	CHIP CAP.	0.047uF	16V	B	GRM39B473K16PT	K22124804		1-	B	
C372	CHIP TA.CAP.	4.7uF	6.3V		TEMSVA0J475M-8R	K78080017		1-	B	
C373	CHIP TA.CAP.	2.2uF	16V		TEMSVA1C225M-8R	K78120015		1-	B	
C374	CHIP CAP.	100pF	50V	CH	GRM39CH101J50PT	K22174235		1-	B	
C375	CHIP CAP.	0.1uF	16V	B	GRM39B104K16PT	K22124805		1-	B	
C376	AL.ELECTRO.CAP.	220uF	4V		UZS0G221MCR1GB	K48060006		1-	B	
C377	CHIP TA.CAP.	100uF	6.3V		TEMSVC0J107M12R	K78080049		1-	A	
C378	AL.ELECTRO.CAP.	100uF	6.3V		UZS0J101MCR1GB	K48080009		1-	A	
C379	CHIP CAP.	0.01uF	25V	B	GRM39B103K25PT	K22144803		1-	A	
C380	CHIP CAP.	330pF	50V	CH	GRM39CH331J50PT	K22174253		1-	A	
C381	AL.ELECTRO.CAP.	100uF	16V		ECEV1CA101WP	K48120012		1-	A	
C382	CHIP CAP.	0.01uF	25V	B	GRM39B103K25PT	K22144803		1-	A	
C384	CHIP CAP.	0.001uF	50V	B	GRM39B102K50PT	K22174821		1-	A	
C385	CHIP CAP.	0.001uF	50V	B	GRM39B102K50PT	K22174821		1-	A	
C386	CHIP CAP.	0.001uF	50V	B	GRM39B102K50PT	K22174821		1-	A	
C386	CHIP CAP.	0.047uF	16V	B	GRM39B473K16PT	K22124804	USA	8-	A	
C386	CHIP CAP.	0.047uF	16V	B	GRM39B473K16PT	K22124804	B1	9-	A	
C386	CHIP CAP.	0.047uF	16V	B	GRM39B473K16PT	K22124804	B2	9-	A	
C387	CHIP CAP.	1uF	10V	B	GRM40B105K10PT	K22100802		1-	B	
C388	CHIP CAP.	82pF	50V	CH	GRM39CH820J50PT	K22174233		1-	A	
C389	CHIP CAP.	0.0022uF	50V	B	GRM39B222K50PT	K22174822		1-	B	
C390	CHIP CAP.	0.01uF	25V	B	GRM39B103K25PT	K22144803		1-	B	
C391	CHIP CAP.	0.01uF	25V	B	GRM39B103K25PT	K22144803		1-	A	
C393	CHIP CAP.	100pF	50V	CH	GRM39CH101J50PT	K22174235	USA	5-	B	
C393	CHIP CAP.	100pF	50V	CH	GRM39CH101J50PT	K22174235	B1	5-	B	
C393	CHIP CAP.	100pF	50V	CH	GRM39CH101J50PT	K22174235	B2	5-	B	
C394	CHIP CAP.	100pF	50V	CH	GRM39CH101J50PT	K22174235	USA	5-	B	
C394	CHIP CAP.	100pF	50V	CH	GRM39CH101J50PT	K22174235	B1	5-	B	
C394	CHIP CAP.	100pF	50V	CH	GRM39CH101J50PT	K22174235	B2	5-	B	
C395	CHIP CAP.	0.001uF	50V	B	GRM39B102K50PT	K22174821		5-	B	
F301	CERAMIC FILTER				KBF-455RS-4AS	H3900529		1-	B	
F302	CERAMIC FILTER				KBF-455RS-15A	H3900406		1-	B	
J301	CONNECTOR				52465-1691	P0091251		1-	B	
J302	CONNECTOR				52588-3090	P0091250		1-	A	
J303	CONNECTOR				HSJ1501-010010	P1091068		1-	B	
J304	CONNECTOR				HEC3650-010010	P0091252		1-	B	
J305	SHIELD FINGER				2026 3100012	S5000196	USA	5-	B	
J305	SHIELD FINGER				2026 3100012	S5000196	B1	5-	B	
J305	SHIELD FINGER				2026 3100012	S5000196	B2	5-	B	
L301	M.RFC				ELJ-FC100JF	L1690935		1-	B	
L302	M.RFC				ELJ-FC100JF	L1690935		1-	B	
L303	RF TRANS.				S-167-3779	S8100775		1-	A	
L304	M.RFC				CM5N-101	S8100776		1-	A	
L305	M.RFC				CDRH74-151MC5	L1690932		1-	A	
L306	RF TRANS.				303LC-1773BS=P1	S8100774		1-	B	
L307	M.RFC				ELJ-PC100KF	L1690933		1-	B	
L308	FERRITE BEADS				BLM21A121SPT	L9190108		5-	B	
L308	FERRITE BEADS				BLM11A121SPT	L9190110		8-	B	
L309	FERRITE BEADS				BLM11A121SPT	L9190110	USA	5-	B	
L309	FERRITE BEADS				BLM11A121SPT	L9190110	B1	5-	B	
L309	FERRITE BEADS				BLM11A121SPT	L9190110	B2	5-	B	
L310	FERRITE BEADS				BLM11A121SPT	L9190110	USA	5-	B	
L310	FERRITE BEADS				BLM11A121SPT	L9190110	B1	5-	B	
L310	FERRITE BEADS				BLM11A121SPT	L9190110	B2	5-	B	
L311	FERRITE BEADS				BLM11A121SPT	L9190110	USA	5-	B	
L311	FERRITE BEADS				BLM11A121SPT	L9190110	B1	5-	B	
L311	FERRITE BEADS				BLM11A121SPT	L9190110	B2	5-	B	
L312	FERRITE BEADS				BLM11A121SPT	L9190110	USA	5-	A	
L312	FERRITE BEADS				BLM11A121SPT	L9190110	B1	5-	A	
L312	FERRITE BEADS				BLM11A121SPT	L9190110	B2	5-	A	

REF.	DESCRIPTION	VALUE	V/W	TOL.	MFR'S DESIG	VXSTD P/N	VERS.	LOT.	SIDE	LAY ADR
L313	FERRITE BEADS				BLM11A121SPT	L9190110	USA	5-	B	
L313	FERRITE BEADS				BLM11A121SPT	L9190110	B1	5-	B	
L313	FERRITE BEADS				BLM11A121SPT	L9190110	B2	5-	B	
L314	FERRITE BEADS				BLM11A121SPT	L9190110	USA	5-	B	
L314	FERRITE BEADS				BLM11A121SPT	L9190110	B1	5-	B	
L314	FERRITE BEADS				BLM11A121SPT	L9190110	B2	5-	B	
Q301	IC				NJM2130F(TE1)	G1093074		1-	B	d3
Q302	IC				TA31136FN(EL)	G1091605		1-	A	D3
Q303	TRANSISTOR				DTA144EE TL	G3070074		1-	A	C3
Q304	DIODE				HVU17-TL	G2070736		1-	B	b4
Q305	DIODE				1SS314 TPH3	G2070122		1-	A	E3
Q306	DIODE				1SS314 TPH3	G2070122		1-	A	D3
Q307	DIODE				1SS314 TPH3	G2070122		1-	A	E3
Q308	DIODE				1SS314 TPH3	G2070122		1-	A	D3
Q309	DIODE				1SS314 TPH3	G2070122		1-	A	E3
Q310	DIODE				1SS314 TPH3	G2070122		1-	A	D3
Q311	TRANSISTOR				2SC4617 TL R	G3346178R		1-	A	D2
Q312	TRANSISTOR				DTC144EE TL	G3070075		1-	A	D2
Q313	TRANSISTOR				2SD1823S(TX)	G3418238S		1-	B	b2
Q314	TRANSISTOR				2SC4617 TL R	G3346178R		1-	A	E2
Q315	DIODE				MA729-(TX)	G2070320		1-	A	D1
Q316	TRANSISTOR				2SC4617 TL R	G3346178R		1-	A	D2
Q317	TRANSISTOR				2SC4617 TL R	G3346178R		1-	A	C3
Q318	DIODE				HVU17-TL	G2070736		1-	A	C3
Q319	DIODE				MA742-(TX)	G2070598		1-	A	D2
Q320	DIODE				MA742-(TX)	G2070598		1-	A	C2
Q321	TRANSISTOR				UMG2N TR	G3070088		1-	A	C2
Q322	IC				TC4066BFT(EL)	G1093081		1-	B	b1
Q323	IC				BU4094BCFV-E1	G1092128		1-	A	C2
Q324	TRANSISTOR				UMA2N TR	G3070213		1-	A	D1
Q325	TRANSISTOR				DTA123YU T106	G3070038		1-	B	d3
Q326	IC				S-81330HG-KB-T1	G1093069		1-	A	B4
Q327	DIODE				MA729-(TX)	G2070320		1-	A	B4
Q328	IC				RH5RH331A-T1	G1093072		1-	A	B4
Q328	IC				RH5RH351A-T1	G1093195		5-	A	B4
Q329	DIODE				MA729-(TX)	G2070320		1-	A	B2
Q330	IC				S-8323D50MC-E3E-T2	G1093075		1-	A	A2
Q331	TRANSISTOR				DTC144EE TL	G3070075		1-	B	d2
Q332	TRANSISTOR				DTA123YE TL	G3070094	USA	5-	B	d1
Q332	TRANSISTOR				DTA123YE TL	G3070094	B1	5-	B	d1
Q332	TRANSISTOR				DTA123YE TL	G3070094	B2	5-	B	d1
Q333	TRANSISTOR				UMX2N TR	G3070254		1-	B	a2
Q334	TRANSISTOR				2SA1588Y(TE85L)	G3115888Y		1-	A	C2
Q335	TRANSISTOR				UMW1N TR	G3070078		1-	A	C2
Q336	TRANSISTOR				2SA1588Y(TE85L)	G3115888Y		1-	B	c2
Q337	IC				TA31056F(TP1)	G1093070		1-	B	c2
Q338	DIODE				EP05Q03L	G2070734		1-	A	B3
Q339	DIODE				EP05Q03L	G2070734		1-	A	A3
Q340	IC				NJM2360AM(TE1)	G1093076		1-	A	A3
Q341	DIODE				EP05Q03L	G2070734		1-	A	A4
Q343	TRANSISTOR				2SC4617 TL R	G3346178R		1-	A	D2
Q344	TRANSISTOR				DTC144EE TL	G3070075		1-	A	D1
Q346	DIODE				1SV271 TPH3	G2070476		1-	A	D2
R301	CHIP RES.	100k	1/16W	1%	RMC1/16 104FTP	J24183104		1-	B	
R302	CHIP RES.	270k	1/16W	1%	RMC1/16 274FTP	J24183274		1-	B	
R303	POT.	220k			MVR22HXBRN224	J51799224		1-	B	
R304	CHIP RES.	100k	1/16W	5%	RMC1/16 104JATP	J24185104		1-	B	
R305	CHIP RES.	0	1/16W	5%	RMC1/16 000JATP	J24185000		1-	B	
R306	CHIP RES.	22k	1/16W	5%	RMC1/16 223JATP	J24185223		1-	B	
R307	CHIP RES.	22k	1/16W	5%	RMC1/16 223JATP	J24185223		1-	A	
R308	CHIP RES.	4.7k	1/16W	5%	RMC1/16 472JATP	J24185472		1-	A	
R309	CHIP RES.	22k	1/16W	5%	RMC1/16 223JATP	J24185223		1-	A	
R310	CHIP RES.	22k	1/16W	5%	RMC1/16 223JATP	J24185223		1-	A	
R311	CHIP RES.	22k	1/16W	5%	RMC1/16 223JATP	J24185223		1-	A	
R312	CHIP RES.	22k	1/16W	5%	RMC1/16 223JATP	J24185223		1-	A	
R313	CHIP RES.	22k	1/16W	5%	RMC1/16 223JATP	J24185223		1-	A	
R314	CHIP RES.	22k	1/16W	5%	RMC1/16 223JATP	J24185223		1-	A	

AF Unit

REF.	DESCRIPTION	VALUE	V/W	TOL.	MFR'S DESIG	VXSTD P/N	VERS.	LOT.	SIDE	LAY ADR
R315	CHIP RES.	150k	1/16W	5%	RMC1/16 154JATP	J24185154		1-	B	
R316	CHIP RES.	3.3k	1/16W	5%	RMC1/16 332JATP	J24185332		1-	B	
R317	CHIP RES.	330k	1/16W	5%	RMC1/16 334JATP	J24185334		1-	B	
R318	CHIP RES.	10k	1/10W	5%	RMC1/10T 103J	J24205103		1-	B	
R319	CHIP RES.	47k	1/16W	5%	RMC1/16 473JATP	J24185473		1-	B	
R320	CHIP RES.	680	1/16W	5%	RMC1/16 681JATP	J24185681		1-	A	
R321	CHIP RES.	6.8k	1/16W	5%	RMC1/16 682JATP	J24185682		1-	A	
R322	CHIP RES.	1k	1/10W	5%	RMC1/10T 102J	J24205102		1-	A	
R323	CHIP RES.	1k	1/10W	5%	RMC1/10T 102J	J24205102		1-	A	
R324	CHIP RES.	1M	1/16W	5%	RMC1/16 105JATP	J24185105		1-	A	
R325	CHIP RES.	4.7k	1/16W	5%	RMC1/16 472JATP	J24185472		1-	A	
R326	CHIP RES.	220k	1/16W	5%	RMC1/16 224JATP	J24185224		1-	A	
R327	CHIP RES.	4.7k	1/16W	5%	RMC1/16 472JATP	J24185472		1-	A	
R328	CHIP RES.	220k	1/16W	5%	RMC1/16 224JATP	J24185224		1-	A	
R329	CHIP RES.	4.7k	1/16W	5%	RMC1/16 472JATP	J24185472		1-	A	
R330	CHIP RES.	4.7k	1/16W	5%	RMC1/16 472JATP	J24185472		1-	A	
R331	CHIP RES.	220	1/16W	5%	RMC1/16 221JATP	J24185221		1-	A	
R333	CHIP RES.	4.7k	1/16W	5%	RMC1/16 472JATP	J24185472		1-	B	
R334	CHIP RES.	1k	1/16W	5%	RMC1/16 102JATP	J24185102		1-	B	
R335	CHIP RES.	10k	1/16W	5%	RMC1/16 103JATP	J24185103		1-	A	
R336	CHIP RES.	10k	1/16W	5%	RMC1/16 103JATP	J24185103		1-	A	
R337	CHIP RES.	100k	1/16W	5%	RMC1/16 104JATP	J24185104		1-	A	
R338	CHIP RES.	100k	1/16W	5%	RMC1/16 104JATP	J24185104		1-	A	
R339	CHIP RES.	4.7k	1/16W	5%	RMC1/16 472JATP	J24185472		1-	A	
R340	CHIP RES.	4.7k	1/16W	5%	RMC1/16 472JATP	J24185472		1-	A	
R341	CHIP RES.	1k	1/16W	5%	RMC1/16 102JATP	J24185102		1-	A	
R342	CHIP RES.	1k	1/16W	5%	RMC1/16 102JATP	J24185102		1-	A	
R343	CHIP RES.	3.3k	1/16W	5%	RMC1/16 332JATP	J24185332		1-	A	
R344	CHIP RES.	3.3k	1/16W	5%	RMC1/16 332JATP	J24185332		1-	A	
R345	CHIP RES.	100k	1/16W	5%	RMC1/16 104JATP	J24185104		1-	A	
R346	CHIP RES.	33k	1/16W	5%	RMC1/16 333JATP	J24185333		1-	A	
R347	CHIP RES.	4.7k	1/16W	5%	RMC1/16 472JATP	J24185472		1-	A	
R348	CHIP RES.	1k	1/16W	5%	RMC1/16 102JATP	J24185102		1-	A	
R349	CHIP RES.	100k	1/16W	5%	RMC1/16 104JATP	J24185104		1-	A	
R350	CHIP RES.	22k	1/16W	5%	RMC1/16 223JATP	J24185223		1-	A	
R351	CHIP RES.	100k	1/16W	5%	RMC1/16 104JATP	J24185104		1-	A	
R352	CHIP RES.	1M	1/16W	5%	RMC1/16 105JATP	J24185105		1-	A	
R353	CHIP RES.	560k	1/16W	5%	RMC1/16 564JATP	J24185564		1-	A	
R354	CHIP RES.	1.5k	1/16W	5%	RMC1/16 152JATP	J24185152		1-	A	
R355	CHIP RES.	100k	1/16W	5%	RMC1/16 104JATP	J24185104		1-	B	
R356	CHIP RES.	47k	1/16W	5%	RMC1/16 473JATP	J24185473		1-	B	
R357	POT.	220k			MVR22HXBRN224	J51799224		1-	B	
R358	POT.	220k			MVR22HXBRN224	J51799224		1-	B	
R359	CHIP RES.	22k	1/16W	5%	RMC1/16 223JATP	J24185223		1-	B	
R360	CHIP RES.	470	1/16W	5%	RMC1/16 471JATP	J24185471		1-	A	
R361	CHIP RES.	6.8k	1/16W	5%	RMC1/16 682JATP	J24185682		1-	B	
R362	CHIP RES.	100k	1/16W	5%	RMC1/16 104JATP	J24185104		1-	A	
R363	CHIP RES.	33k	1/16W	5%	RMC1/16 333JATP	J24185333		1-	A	
R364	CHIP RES.	0	1/16W	5%	RMC1/16 000JATP	J24185000		1-	B	
R365	CHIP RES.	100k	1/16W	5%	RMC1/16 104JATP	J24185104		1-	A	
R366	CHIP RES.	470k	1/16W	5%	RMC1/16 474JATP	J24185474		1-	A	
R367	CHIP RES.	470k	1/16W	5%	RMC1/16 474JATP	J24185474		1-	A	
R368	CHIP RES.	220	1/16W	5%	RMC1/16 221JATP	J24185221		1-	B	
R369	CHIP RES.	2.2k	1/16W	5%	RMC1/16 222JATP	J24185222		1-	B	
R370	CHIP RES.	18k	1/16W	5%	RMC1/16 183JATP	J24185183		1-	B	
R371	CHIP RES.	1M	1/16W	5%	RMC1/16 105JATP	J24185105		1-	B	
R372	CHIP RES.	18k	1/16W	5%	RMC1/16 183JATP	J24185183		1-	B	
R373	CHIP RES.	1.5k	1/16W	5%	RMC1/16 152JATP	J24185152		1-	B	
R374	CHIP RES.	120	1/16W	5%	RMC1/16 121JATP	J24185121		1-	B	
R375	CHIP RES.	0	1/16W	5%	RMC1/16 000JATP	J24185000		1-	B	
R376	CHIP RES.	1M	1/16W	5%	RMC1/16 105JATP	J24185105		1-	B	
R377	CHIP RES.	22k	1/16W	5%	RMC1/16 223JATP	J24185223		1-	B	
R378	CHIP RES.	47k	1/16W	5%	RMC1/16 473JATP	J24185473		1-	A	
R379	CHIP RES.	1k	1/16W	5%	RMC1/16 102JATP	J24185102		1-	A	
R380	CHIP RES.	3.3k	1/16W	5%	RMC1/16 332JATP	J24185332		1-	A	
R381	CHIP RES.	15k	1/16W	5%	RMC1/16 153JATP	J24185153		1-	A	
R382	CHIP RES.	0	1/16W	5%	RMC1/16 000JATP	J24185000		1-	B	

REF.	DESCRIPTION	VALUE	V/W	TOL.	MFR'S DESIG	VXSTD P/N	VERS.	LOT.	SIDE	LAY ADR
R383	CHIP RES.	27k	1/16W	5%	RMC1/16 273JATP	J24185273		1-	A	
R384	CHIP RES.	10k	1/16W	5%	RMC1/16 103JATP	J24185103		1-	A	
R385	CHIP RES.	2.2k	1/16W	5%	RMC1/16 222JATP	J24185222		1-	B	
R386	CHIP RES.	1k	1/16W	5%	RMC1/16 102JATP	J24185102		1-	B	
R396	CHIP RES.	0	1/16W	5%	RMC1/16 000JATP	J24185000		1-	B	
R397	CHIP RES.	1	1/16W	5%	RMC1/16 1R0JATP	J24185010		1-	A	
R399	CHIP RES.	0	1/16W	5%	RMC1/16 000JATP	J24185000		1-	B	
R400	CHIP RES.	2.2k	1/16W	5%	RMC1/16 222JATP	J24185222		1-	B	
R401	CHIP RES.	100k	1/16W	5%	RMC1/16 104JATP	J24185104		1-	B	
R402	CHIP RES.	100k	1/16W	5%	RMC1/16 104JATP	J24185104		1-	B	
R403	CHIP RES.	1k	1/10W	5%	RMC1/10T 102J	J24205102		1-	A	
R403	CARBON RES.	100k	1/6W	5%	RD16PJ104	J01225104		3-	A	
R403	CHIP RES.	100k	1/16W	5%	RMC1/16 104JATP	J24185104		4-	A	
R404	CARBON RES.	100k	1/6W	5%	RD16PJ104	J01225104		1-	B	
R404	CHIP RES.	100k	1/16W	5%	RMC1/16 104JATP	J24185104		5-	B	
R405	CHIP RES.	100k	1/16W	5%	RMC1/16S104JTH	J24189049		1-	B	
R405	CHIP RES.	100k	1/16W	5%	RMC1/16 104JATP	J24185104		5-	B	
X301	XTAL	10.245MHz			HC-49/T_10.245MHz	S8100781		1-	A	
X302	CERAMIC OSC.	458KHz			CSBF458J-TC01	H7901380		1-	A	

AF Unit
Note:

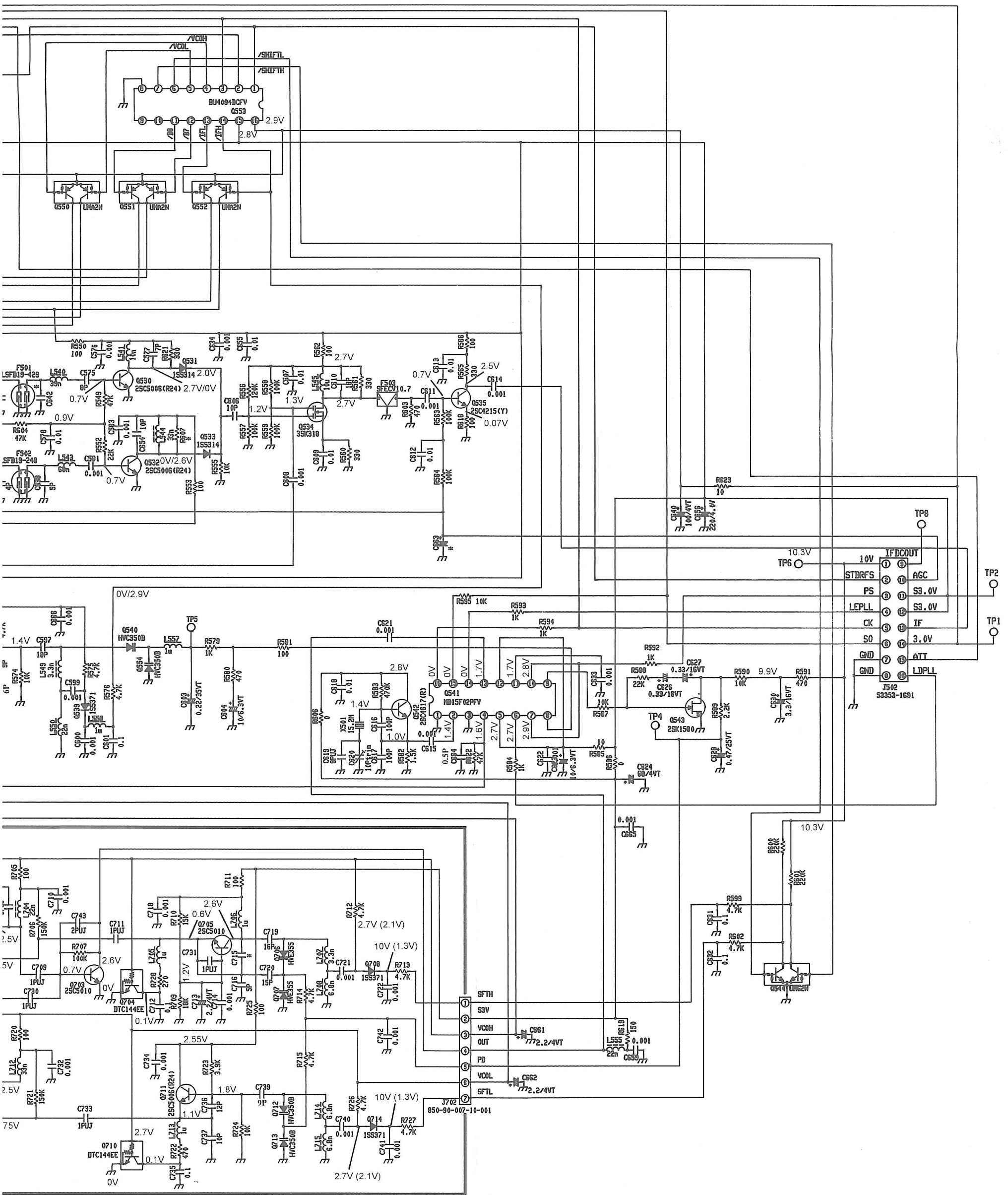

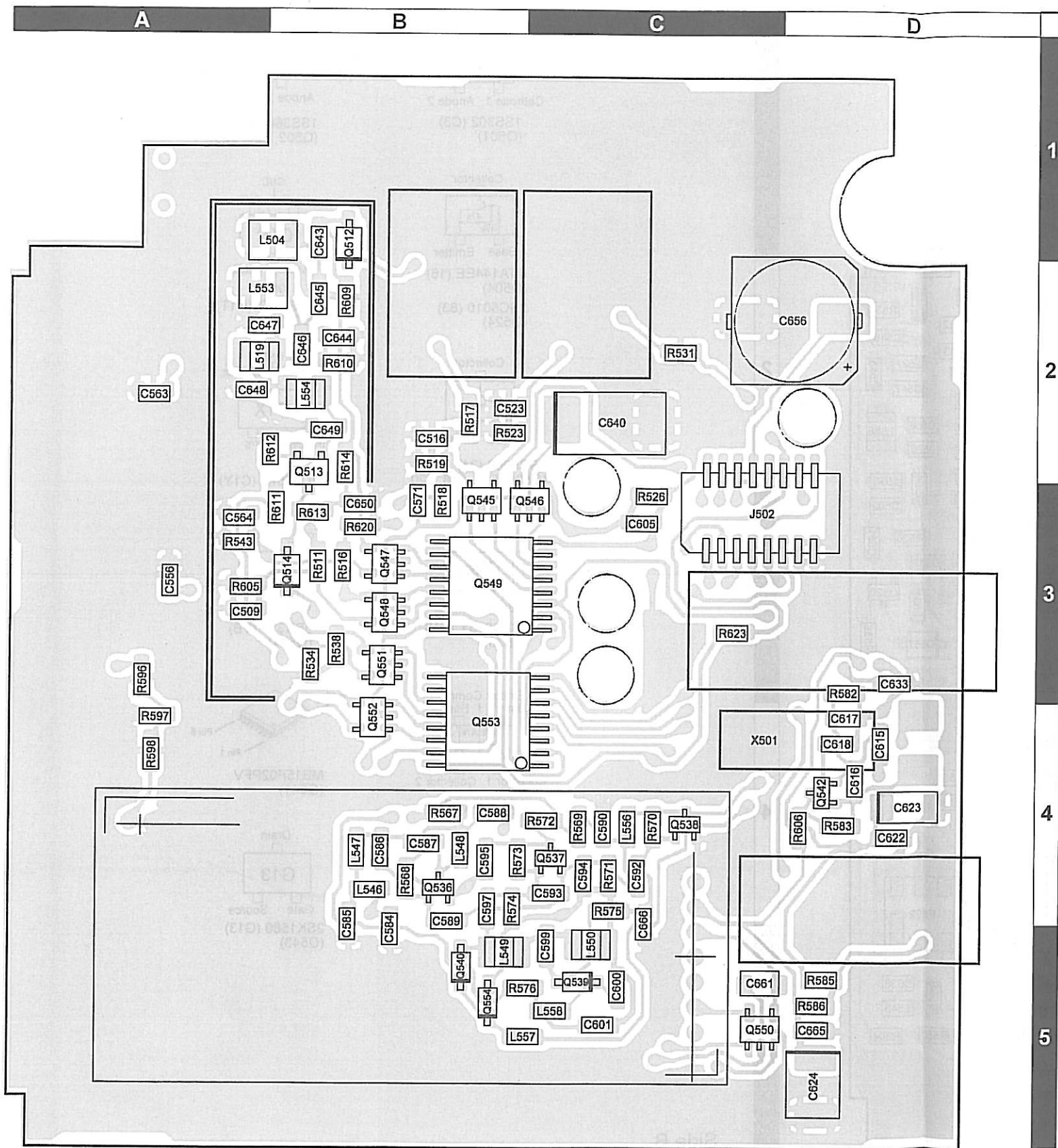

Side A

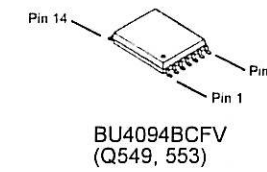
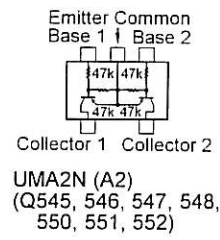
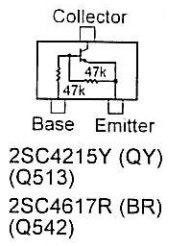
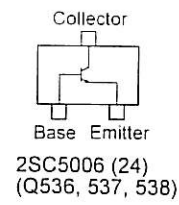

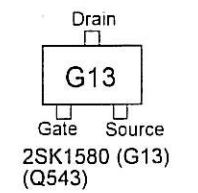
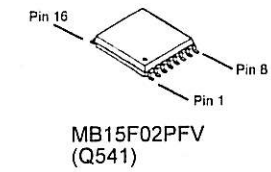
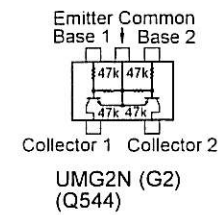
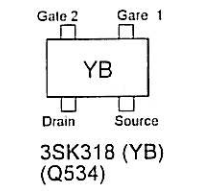
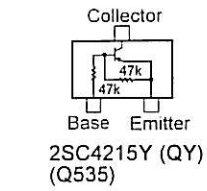
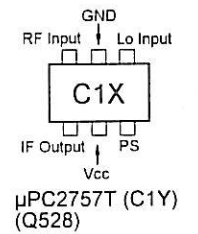
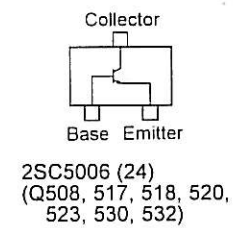
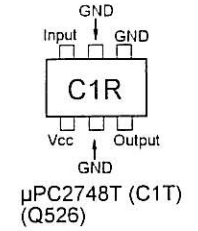
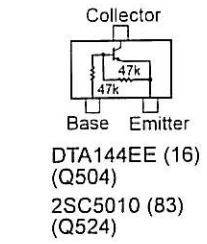
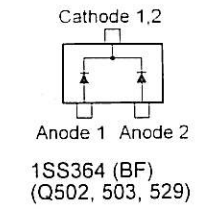
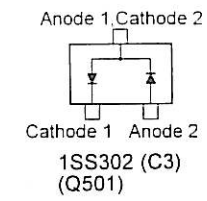
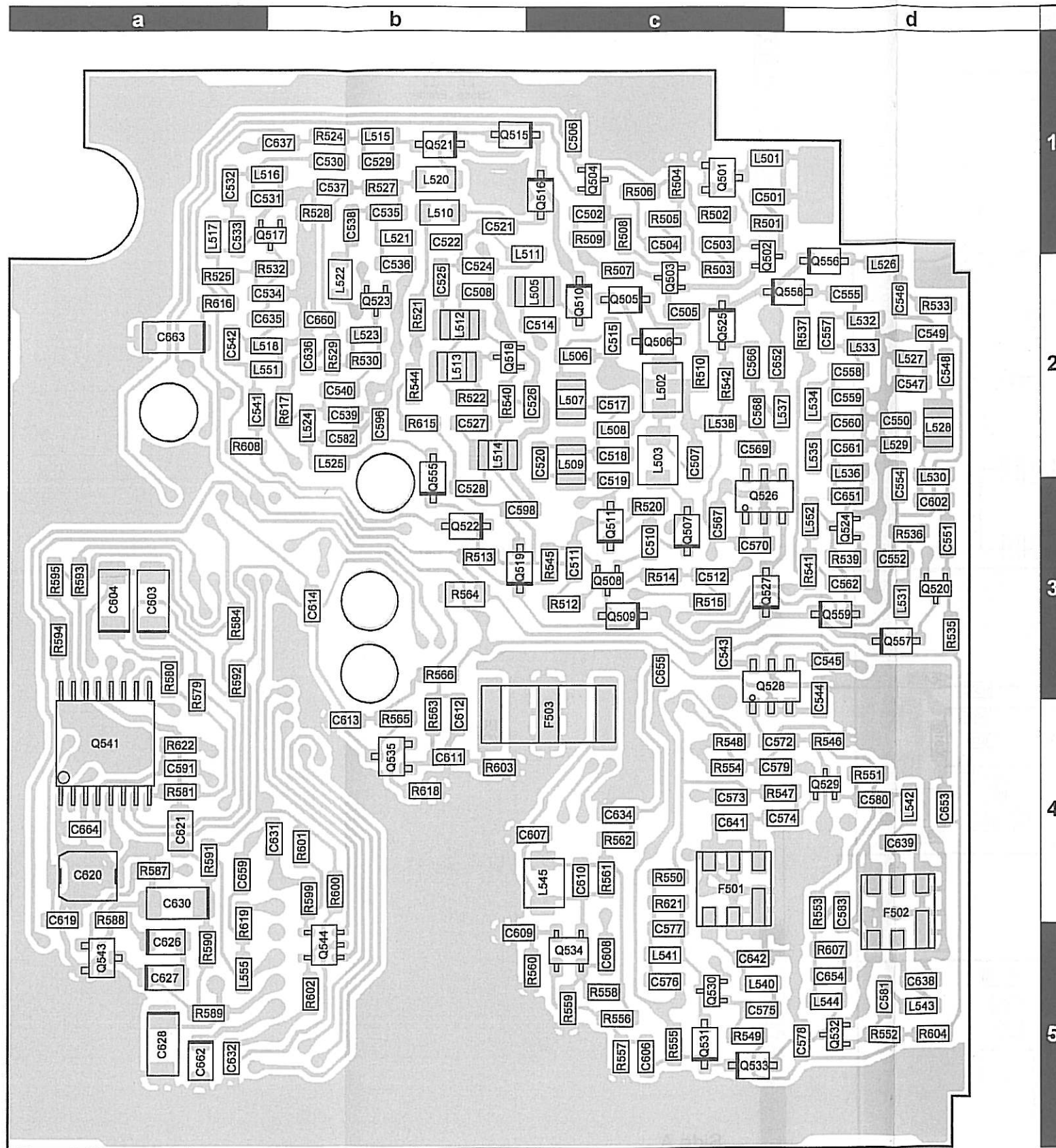

Side B

Circuit Diagram

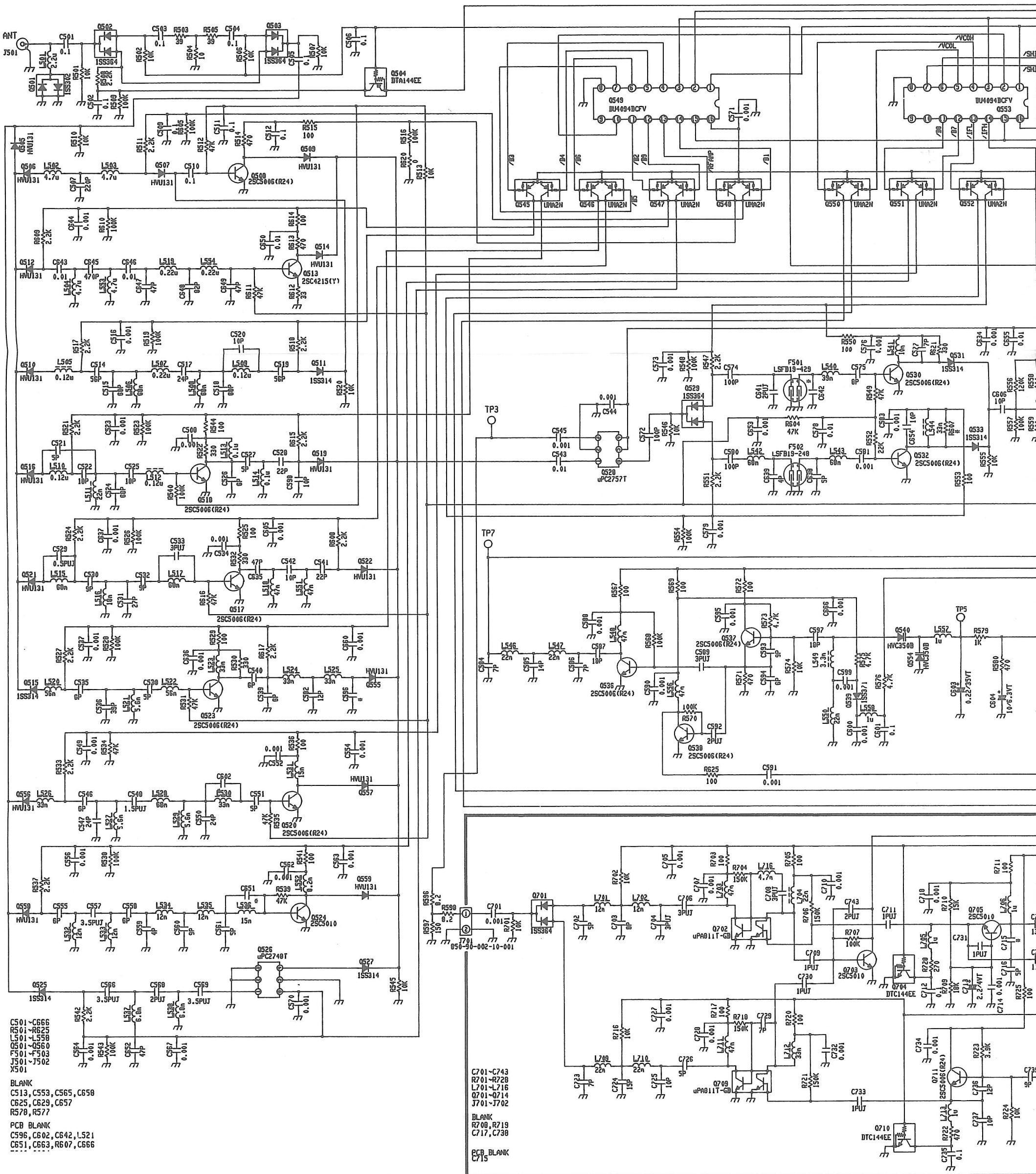

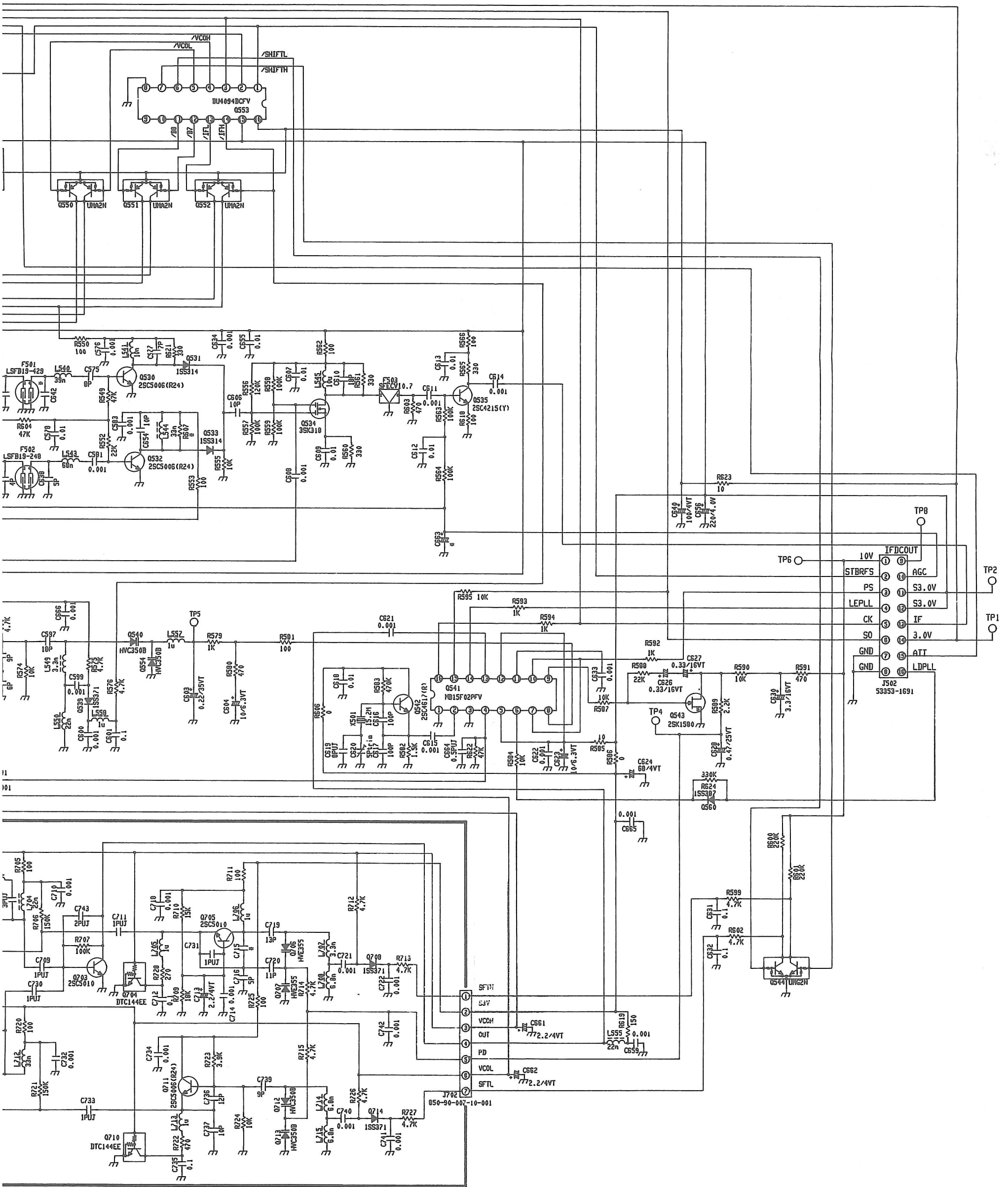

Parts Layout

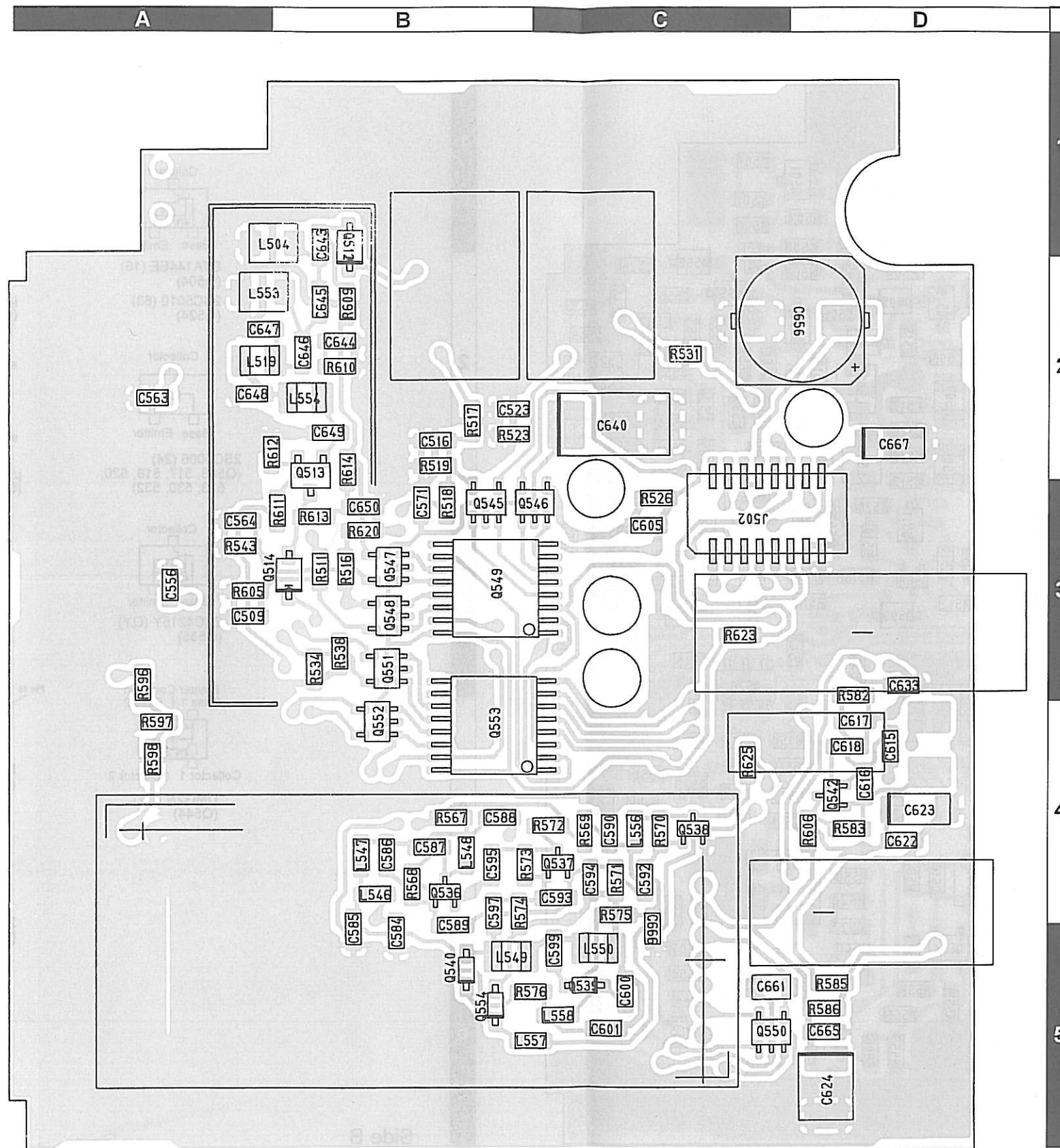

Side A

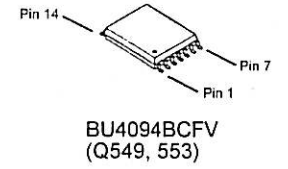
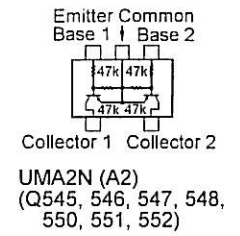
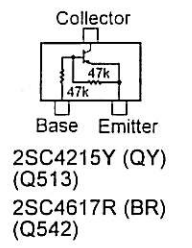
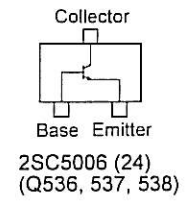

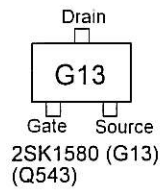
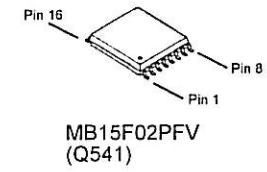
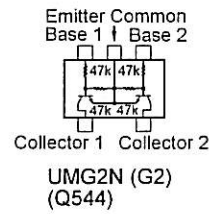
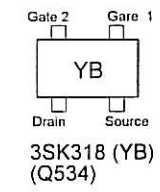
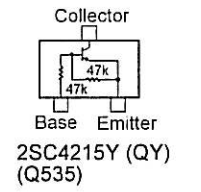
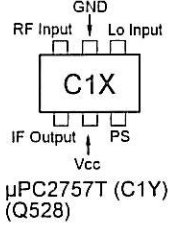
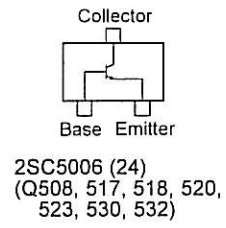
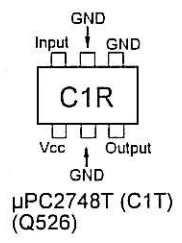
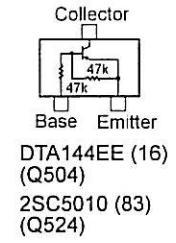
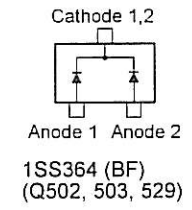
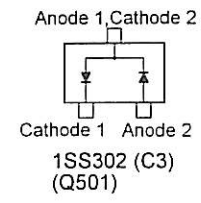

Side B

Parts List

REF.	DESCRIPTION	VALUE	V/W	TOL.	MFR'S DESIG	VXSTD P/N	VERS.	LOT.	SIDE	LAY ADR
*** RF UNIT ***										
PCB with Components						Q7000368				
C501	CHIP CAP.	0.1uF	16V	B	GRM39B104K16PT	K22124805		1-	B	
C502	CHIP CAP.	0.1uF	16V	B	GRM39B104K16PT	K22124805		1-	B	
C503	CHIP CAP.	0.1uF	16V	B	GRM39B104K16PT	K22124805		1-	B	
C504	CHIP CAP.	0.1uF	16V	B	GRM39B104K16PT	K22124805		1-	B	
C505	CHIP CAP.	0.1uF	16V	B	GRM39B104K16PT	K22124805		1-	B	
C506	CHIP CAP.	0.1uF	16V	B	GRM39B104K16PT	K22124805		1-	B	
C507	CHIP CAP.	220pF	50V	CH	GRM39CH221J50PT	K22174243		1-	B	
C508	CHIP CAP.	0.001uF	50V	B	GRM39B102K50PT	K22174821		1-	B	
C509	CHIP CAP.	0.1uF	16V	B	GRM39B104K16PT	K22124805		1-	A	
C510	CHIP CAP.	0.1uF	16V	B	GRM39B104K16PT	K22124805		1-	B	
C511	CHIP CAP.	0.1uF	16V	B	GRM39B104K16PT	K22124805		1-	B	
C512	CHIP CAP.	0.1uF	16V	B	GRM39B104K16PT	K22124805		1-	B	
C514	CHIP CAP.	56pF	50V	CH	GRM39CH560J50PT	K22174229		1-	B	
C515	CHIP CAP.	68pF	50V	CH	GRM39CH680J50PT	K22174231		1-	B	
C516	CHIP CAP.	0.001uF	50V	B	GRM39B102K50PT	K22174821		1-	A	
C517	CHIP CAP.	24pF	50V	CH	GRM39CH240J50PT	K22174220		1-	B	
C518	CHIP CAP.	68pF	50V	CH	GRM39CH680J50PT	K22174231		1-	B	
C519	CHIP CAP.	56pF	50V	CH	GRM39CH560J50PT	K22174229		1-	B	
C520	CHIP CAP.	10pF	50V	CH	GRM39CH100D50PT	K22174211		1-	B	
C521	CHIP CAP.	5pF	50V	CH	GRM39CH050C50PT	K22174206		1-	B	
C522	CHIP CAP.	18pF	50V	CH	GRM39CH180J50PT	K22174217		1-	B	
C523	CHIP CAP.	0.001uF	50V	B	GRM39B102K50PT	K22174821		1-	A	
C524	CHIP CAP.	68pF	50V	CH	GRM39CH680J50PT	K22174231		1-	B	
C525	CHIP CAP.	18pF	50V	CH	GRM39CH180J50PT	K22174217		1-	B	
C526	CHIP CAP.	6pF	50V	CH	GRM39CH060D50PT	K22174207		1-	B	
C527	CHIP CAP.	5pF	50V	CH	GRM39CH050C50PT	K22174206		1-	B	
C528	CHIP CAP.	22pF	50V	CH	GRM39CH220J50PT	K22174219		1-	B	
C529	CHIP CAP.	0.5pF	50V	UJ	GRM39UJ0R5B50PT	K22174333		1-	B	
C530	CHIP CAP.	9pF	50V	CH	GRM39CH090D50PT	K22174210		1-	B	
C531	CHIP CAP.	27pF	50V	CH	GRM39CH270J50PT	K22174221		1-	B	
C532	CHIP CAP.	9pF	50V	CH	GRM39CH090D50PT	K22174210		1-	B	
C533	CHIP CAP.	3pF	50V	UJ	GRM39UJ030B50PT	K22174337		1-	B	
C534	CHIP CAP.	0.001uF	50V	B	GRM39B102K50PT	K22174821		1-	B	
C535	CHIP CAP.	1.5pF	50V	UJ	GRM39UJ1R5B50PT	K22174335		1-	B	
C535	CHIP CAP.	6pF	50V	CH	GRM39CH060D50PT	K22174207	USA	5-	B	
C535	CHIP CAP.	6pF	50V	CH	GRM39CH060D50PT	K22174207	B1	5-	B	
C535	CHIP CAP.	6pF	50V	CH	GRM39CH060D50PT	K22174207	B2	5-	B	
C536	CHIP CAP.	10pF	50V	CH	GRM39CH100D50PT	K22174211		1-	B	
C536	CHIP CAP.	39pF	50V	CH	GRM39CH390J50PT	K22174225	USA	5-	B	
C536	CHIP CAP.	39pF	50V	CH	GRM39CH390J50PT	K22174225	B1	5-	B	
C536	CHIP CAP.	39pF	50V	CH	GRM39CH390J50PT	K22174225	B2	5-	B	
C537	CHIP CAP.	0.001uF	50V	B	GRM39B102K50PT	K22174821		1-	B	
C538	CHIP CAP.	7pF	50V	CH	GRM39CH070D50PT	K22174208	USA	1-	B	
C538	CHIP CAP.	7pF	50V	CH	GRM39CH070D50PT	K22174208	B1	1-	B	
C538	CHIP CAP.	7pF	50V	CH	GRM39CH070D50PT	K22174208	B2	1-	B	
C538	CHIP CAP.	5pF	50V	CH	GRM39CH050D50PT	K22174206	USA	5-	B	
C538	CHIP CAP.	5pF	50V	CH	GRM39CH050D50PT	K22174206	B1	5-	B	
C538	CHIP CAP.	5pF	50V	CH	GRM39CH050D50PT	K22174206	B2	5-	B	
C539	CHIP CAP.	6pF	50V	CH	GRM39CH060D50PT	K22174207		1-	B	
C540	CHIP CAP.	6pF	50V	CH	GRM39CH060D50PT	K22174207		1-	B	
C541	CHIP CAP.	22pF	50V	CH	GRM39CH220J50PT	K22174219		1-	B	
C542	CHIP CAP.	10pF	50V	CH	GRM39CH100D50PT	K22174211		1-	B	
C543	CHIP CAP.	0.01uF	25V	B	GRM39B103K25PT	K22144803		1-	B	
C544	CHIP CAP.	0.001uF	50V	B	GRM39B102K50PT	K22174821		1-	B	
C545	CHIP CAP.	0.001uF	50V	B	GRM39B102K50PT	K22174821		1-	B	
C546	CHIP CAP.	6pF	50V	CH	GRM39CH060D50PT	K22174207		1-	B	
C547	CHIP CAP.	24pF	50V	CH	GRM39CH240J50PT	K22174220		1-	B	
C548	CHIP CAP.	1.5pF	50V	UJ	GRM39UJ1R5B50PT	K22174335		1-	B	
C549	CHIP CAP.	0.001uF	50V	B	GRM39B102K50PT	K22174821		1-	B	
C550	CHIP CAP.	24pF	50V	CH	GRM39CH240J50PT	K22174220		1-	B	
C551	CHIP CAP.	5pF	50V	CH	GRM39CH050C50PT	K22174206		1-	B	
C552	CHIP CAP.	0.001uF	50V	B	GRM39B102K50PT	K22174821		1-	B	
C554	CHIP CAP.	0.001uF	50V	B	GRM39B102K50PT	K22174821		1-	B	
C555	CHIP CAP.	6pF	50V	CH	GRM39CH060D50PT	K22174207		1-	B	
C556	CHIP CAP.	0.001uF	50V	B	GRM39B102K50PT	K22174821		1-	A	

RF Unit

REF.	DESCRIPTION	VALUE	V/W	TOL.	MFR'S DESIG	VXSTD P/N	VERS.	LOT.	SIDE	LAY ADR
C557	CHIP CAP.	3.5pF	50V	UJ	GRM39UJ3R5B50PT	K22174338		1-	B	
C558	CHIP CAP.	6pF	50V	CH	GRM39CH060D50PT	K22174207		1-	B	
C559	CHIP CAP.	4pF	50V	CH	GRM39CH040C50PT	K22174205		1-	B	
C560	CHIP CAP.	9pF	50V	CH	GRM39CH090D50PT	K22174210		1-	B	
C561	CHIP CAP.	5pF	50V	CH	GRM39CH050C50PT	K22174206		1-	B	
C562	CHIP CAP.	0.001uF	50V	B	GRM39B102K50PT	K22174821		1-	B	
C563	CHIP CAP.	0.001uF	50V	B	GRM39B102K50PT	K22174821		1-	A	
C564	CHIP CAP.	0.001uF	50V	B	GRM39B102K50PT	K22174821		1-	A	
C566	CHIP CAP.	3.5pF	50V	UJ	GRM39UJ3R5B50PT	K22174338		1-	B	
C567	CHIP CAP.	0.001uF	50V	B	GRM39B102K50PT	K22174821		1-	B	
C568	CHIP CAP.	2pF	50V	UJ	GRM39UJ020B50PT	K22174336		1-	B	
C569	CHIP CAP.	3.5pF	50V	UJ	GRM39UJ3R5B50PT	K22174338		1-	B	
C570	CHIP CAP.	0.001uF	50V	B	GRM39B102K50PT	K22174821		1-	B	
C571	CHIP CAP.	0.001uF	50V	B	GRM39B102K50PT	K22174821		1-	A	
C572	CHIP CAP.	100pF	50V	CH	GRM39CH101J50PT	K22174235		1-	B	
C573	CHIP CAP.	0.001uF	50V	B	GRM39B102K50PT	K22174821		1-	B	
C574	CHIP CAP.	100pF	50V	CH	GRM39CH101J50PT	K22174235		1-	B	
C575	CHIP CAP.	8pF	50V	CH	GRM39CH080D50PT	K22174209		1-	B	
C576	CHIP CAP.	0.001uF	50V	B	GRM39B102K50PT	K22174821		1-	B	
C577	CHIP CAP.	7pF	50V	CH	GRM39CH070D50PT	K22174208		1-	B	
C578	CHIP CAP.	0.01uF	25V	B	GRM39B103K25PT	K22144803		1-	B	
C579	CHIP CAP.	0.001uF	50V	B	GRM39B102K50PT	K22174821		1-	B	
C580	CHIP CAP.	100pF	50V	CH	GRM39CH101J50PT	K22174235		1-	B	
C581	CHIP CAP.	0.001uF	50V	B	GRM39B102K50PT	K22174821		1-	B	
C582	CHIP CAP.	12pF	50V	CH	GRM39CH120J50PT	K22174213		1-	B	
C583	CHIP CAP.	0.001uF	50V	B	GRM39B102K50PT	K22174821		1-	B	
C584	CHIP CAP.	7pF	50V	CH	GRM39CH070D50PT	K22174208		1-	A	
C585	CHIP CAP.	14pF	50V	CH	GRM39CH140J50PT	K22174264		1-	A	
C586	CHIP CAP.	7pF	50V	CH	GRM39CH070D50PT	K22174208		1-	A	
C587	CHIP CAP.	18pF	50V	CH	GRM39CH180J50PT	K22174217		1-	A	
C588	CHIP CAP.	0.001uF	50V	B	GRM39B102K50PT	K22174821		1-	A	
C589	CHIP CAP.	3pF	50V	UJ	GRM39UJ030B50PT	K22174337		1-	A	
C590	CHIP CAP.	0.001uF	50V	B	GRM39B102K50PT	K22174821		9-	A	
C591	CHIP CAP.	0.001uF	50V	B	GRM39B102K50PT	K22174821		1-	B	
C592	CHIP CAP.	2pF	50V	UJ	GRM39UJ020B50PT	K22174336		1-	B	
C593	CHIP CAP.	14pF	50V	CH	GRM39CH140J50PT	K22174264		1-	A	
C593	CHIP CAP.	9pF	50V	CH	GRM39CH090D50PT	K22174210	USA	5-	A	
C593	CHIP CAP.	9pF	50V	CH	GRM39CH090D50PT	K22174210	B1	5-	A	
C593	CHIP CAP.	9pF	50V	CH	GRM39CH090D50PT	K22174210	B2	5-	A	
C594	CHIP CAP.	3pF	50V	UJ	GRM39UJ030B50PT	K22174337		1-	A	
C594	CHIP CAP.	6pF	50V	CH	GRM39CH060D50PT	K22174207	USA	5-	A	
C594	CHIP CAP.	6pF	50V	CH	GRM39CH060D50PT	K22174207	B1	5-	A	
C594	CHIP CAP.	6pF	50V	CH	GRM39CH060D50PT	K22174207	B2	5-	A	
C595	CHIP CAP.	0.001uF	50V	B	GRM39B102K50PT	K22174821		1-	A	
C597	CHIP CAP.	18pF	50V	CH	GRM39CH180J50PT	K22174217		1-	A	
C598	CHIP CAP.	10pF	50V	CH	GRM39CH100D50PT	K22174211		1-	B	
C599	CHIP CAP.	0.001uF	50V	B	GRM39B102K50PT	K22174821		1-	A	
C600	CHIP CAP.	0.001uF	50V	B	GRM39B102K50PT	K22174821		1-	A	
C601	CHIP CAP.	0.1uF	16V	B	GRM39B104K16PT	K22124805		1-	A	
C603	CHIP TA.CAP.	0.22uF	35V		TESVA1V224M1-8R	K78160027		1-	B	
C604	CHIP TA.CAP.	10uF	6.3V		TEMSVA0J106M-8R	K78080027		1-	B	
C605	CHIP CAP.	0.001uF	50V	B	GRM39B102K50PT	K22174821		1-	A	
C606	CHIP CAP.	10pF	50V	CH	GRM39CH100D50PT	K22174211		1-	B	
C607	CHIP CAP.	0.01uF	25V	B	GRM39B103K25PT	K22144803		1-	B	
C608	CHIP CAP.	0.001uF	50V	B	GRM39B102K50PT	K22174821		1-	B	
C609	CHIP CAP.	0.01uF	25V	B	GRM39B103K25PT	K22144803		1-	B	
C610	CHIP CAP.	18pF	50V	CH	GRM39CH180J50PT	K22174217		1-	B	
C611	CHIP CAP.	0.001uF	50V	B	GRM39B102K50PT	K22174821		1-	B	
C612	CHIP CAP.	0.01uF	25V	B	GRM39B103K25PT	K22144803		1-	B	
C613	CHIP CAP.	0.01uF	25V	B	GRM39B103K25PT	K22144803		1-	B	
C614	CHIP CAP.	0.001uF	50V	B	GRM39B102K50PT	K22174821		1-	B	
C615	CHIP CAP.	0.001uF	50V	B	GRM39B102K50PT	K22174821		1-	A	
C616	CHIP CAP.	100pF	50V	CH	GRM39CH101J50PT	K22174235		1-	A	
C617	CHIP CAP.	100pF	50V	CH	GRM39CH101J50PT	K22174235		1-	A	
C618	CHIP CAP.	0.01uF	25V	B	GRM39B103K25PT	K22144803		1-	A	
C619	CHIP CAP.	8pF	50V	UJ	GRM39UJ080D50PT	K22174308		1-	B	
C620	TRIMMER CAP.	10pF			CTZ2S-10A-W2-P	K91000256		1-	B	

REF.	DESCRIPTION	VALUE	V/W	TOL.	MFR'S DESIG	VXSTD P/N	VERS.	LOT.	SIDE	LAY ADR
C620	TRIMMER CAP.	5pF			CTZ2S-05A-W2-P	K91000268		8-	B	
C621	CHIP CAP.	0.001uF	50V	B	GRM40B102K50PT	K22170825		1-	B	
C622	CHIP CAP.	0.001uF	50V	B	GRM39B102K50PT	K22174821		1-	A	
C623	CHIP TA.CAP.	10uF	6.3V		TEMSVA0J106M-8R	K78080027		1-	A	
C624	CHIP TA.CAP.	68uF			TEMSVB20G686M-8R	K78060033		1-	A	
C626	CHIP TA.CAP.	0.33uF	16V		TESVSP1C334M-8R	K78120029		1-	B	
C627	CHIP TA.CAP.	0.33uF	16V		TESVSP1C334M-8R	K78120029		1-	B	
C628	CHIP TA.CAP.	0.47uF	35V		TEMSVA1V474M-8R	K78160029		1-	B	
C630	CHIP TA.CAP.	3.3uF	16V		TEMSVA1C335M-8R	K78120021		1-	B	
C631	CHIP CAP.	0.1uF	16V	B	GRM39B104K16PT	K22124805		1-	B	
C632	CHIP CAP.	0.1uF	16V	B	GRM39B104K16PT	K22124805		1-	B	
C633	CHIP CAP.	0.001uF	50V	B	GRM39B102K50PT	K22174821		1-	A	
C634	CHIP CAP.	0.001uF	50V	B	GRM39B102K50PT	K22174821		1-	B	
C635	CHIP CAP.	47pF	50V	CH	GRM39CH470J50PT	K22174227		1-	B	
C636	CHIP CAP.	0.001uF	50V	B	GRM39B102K50PT	K22174821		1-	B	
C637	CHIP CAP.	0.001uF	50V	B	GRM39B102K50PT	K22174821		1-	B	
C638	CHIP CAP.	5pF	50V	CH	GRM39CH050C50PT	K22174206		1-	B	
C639	CHIP CAP.	4pF	50V	CH	GRM39CH040C50PT	K22174205		1-	B	
C640	CHIP TA.CAP.	100uF	4V		TEMSVCOG107M12R	K78060021		1-	A	
C641	CHIP CAP.	2pF	50V	UJ	GRM39UJ020B50PT	K22174336		1-	B	
C643	CHIP CAP.	0.01uF	25V	B	GRM39B103K25PT	K22144803		1-	A	
C644	CHIP CAP.	0.001uF	50V	B	GRM39B102K50PT	K22174821		1-	A	
C645	CHIP CAP.	470pF	50V	B	GRM39B471K50PT	K22174832		1-	A	
C646	CHIP CAP.	0.01uF	25V	B	GRM39B103K25PT	K22144803		1-	A	
C647	CHIP CAP.	47pF	50V	CH	GRM39CH470J50PT	K22174227		1-	A	
C648	CHIP CAP.	82pF	50V	CH	GRM39CH820J50PT	K22174233		1-	A	
C649	CHIP CAP.	47pF	50V	CH	GRM39CH470J50PT	K22174227		1-	A	
C650	CHIP CAP.	0.01uF	25V	B	GRM39B103K25PT	K22144803		1-	A	
C652	CHIP CAP.	47pF	50V	CH	GRM39CH470J50PT	K22174227		1-	B	
C653	CHIP CAP.	0.001uF	50V	B	GRM39B102K50PT	K22174821		1-	B	
C654	CHIP CAP.	10pF	50V	CH	GRM39CH100D50PT	K22174211		1-	B	
C655	CHIP CAP.	0.01uF	25V	B	GRM39B103K25PT	K22144803		1-	B	
C656	AL.ELECTRO.CAP.	220uF	4V		UZSOG221MCR1GB	K48060006		1-	A	
C659	CHIP CAP.	0.001uF	50V	B	GRM39B102K50PT	K22174821		1-	B	
C660	CHIP CAP.	0.001uF	50V	B	GRM39B102K50PT	K22174821		1-	B	
C661	CHIP TA.CAP.	2.2uF	4V		TESVSP0G225M-8R	K78060025		1-	A	
C662	CHIP TA.CAP.	2.2uF	4V		TESVSP0G225M-8R	K78060025		1-	B	
C664	CHIP CAP.	0.5pF	50V	UJ	GRM39UJ0R5B50PT	K22174333	USA	5-	B	
C664	CHIP CAP.	0.5pF	50V	UJ	GRM39UJ0R5B50PT	K22174333	B1	5-	B	
C664	CHIP CAP.	0.5pF	50V	UJ	GRM39UJ0R5B50PT	K22174333	B2	5-	B	
C665	CHIP CAP.	0.001uF	50V	B	GRM39B102K50PT	K22174821		5-	A	
C666	CHIP CAP.	0.001uF	50V	B	GRM39B102K50PT	K22174821	USA	5-	A	
C666	CHIP CAP.	0.001uF	50V	B	GRM39B102K50PT	K22174821	B1	5-	A	
C666	CHIP CAP.	0.001uF	50V	B	GRM39B102K50PT	K22174821	B2	5-	A	
C667	CHIP TA.CAP.	2.2uF	4V		TESVSP0G225M-8R	K78060025	USA	-10		
F501	SAW FILTER				LSFB19-429-800K0	S8100782		1-	B	
F502	SAW FILTER				LSFB19-248-220K0	S8100783		1-	B	
F503	CERAMIC FILTER				SFCEV10.7MA5-Z	H3900530		1-	B	
J501	CONNECTOR				BNCR-S Z2	S8100788		1-		
J502	CONNECTOR				53353-1691	P1091067		1-	A	
L501	M.RFC	2.2uH			MLF1608A2R2KT	L1690931		1-	B	
L502	M.RFC	4.7uH			ELJ-FC4R7JF	L1690934		1-	B	
L503	M.RFC	4.7uH			ELJ-FC4R7JF	L1690934		1-	B	
L504	M.RFC	4.7uH			ELJ-FC4R7JF	L1690934		1-	A	
L505	CHIP COIL	0.12uH			LQN21AR12J04	L1690621		1-	B	
L506	M.RFC	0.068uH			ELJ-RE68N3F3	L1690724		1-	B	
L507	CHIP COIL	0.22uH			LQN21AR22J04	L1690600		1-	B	
L508	M.RFC	0.068uH			ELJ-RE68N3F3	L1690724		1-	B	
L509	CHIP COIL	0.12uH			LQN21AR12J04	L1690621		1-	B	
L510	M.RFC	0.22uH			ELJ-NDR12JF	L1690936		1-	B	
L511	M.RFC	0.022uH			ELJ-RE22N3F2	L1690718		1-	B	
L512	CHIP COIL	0.12uH			LQN21AR12J04	L1690621		1-	B	
L513	CHIP COIL	0.1uH			LQN21AR10J04	L1690620		1-	B	
L514	CHIP COIL	0.1uH			LQN21AR10J04	L1690620		1-	B	
L515	M.RFC	0.068uH			ELJ-RE68N3F3	L1690724		1-	B	
L516	M.RFC	0.018uH			ELJ-RE18N3F2	L1690717		1-	B	
L517	M.RFC	0.068uH			ELJ-RE68N3F3	L1690724		1-	B	

RF Unit

REF.	DESCRIPTION	VALUE	V/W	TOL.	MFR'S DESIG	VXSTD P/N	VERS.	LOT.	SIDE	LAY ADR
L518	M.RFC	0.047uH			ELJ-RE47NJF2	L1690722		1-	B	
L519	CHIP COIL	0.22uH			LQN21AR22J04	L1690600		1-	A	
L520	M.RFC	0.12uH			ELJ-NDR12JF	L1690936		1-	B	
L520	M.RFC	0.056uH			ELJ-ND56NJF	L1690982	USA	5-	B	
L520	M.RFC	0.056uH			ELJ-ND56NJF	L1690982	B1	5-	B	
L520	M.RFC	0.056uH			ELJ-ND56NJF	L1690982	B2	5-	B	
L521	CHIP COIL	0.0056uH			LQG11A5N6S00T1	L1690749	USA	5-	B	
L521	CHIP COIL	0.0056uH			LQG11A5N6S00T1	L1690749	B1	5-	B	
L521	CHIP COIL	0.0056uH			LQG11A5N6S00T1	L1690749	B2	5-	B	
L522	M.RFC	0.12uH			ELJ-NDR12JF	L1690936		1-	B	
L522	M.RFC	0.056uH			ELJ-ND56NJF	L1690982	USA	5-	B	
L522	M.RFC	0.056uH			ELJ-ND56NJF	L1690982	B1	5-	B	
L522	M.RFC	0.056uH			ELJ-ND56NJF	L1690982	B2	5-	B	
L523	M.RFC	0.033uH			ELJ-RE33NJF2	L1690720		1-	B	
L524	M.RFC	0.033uH			ELJ-RE33NJF2	L1690720		1-	B	
L525	M.RFC	0.033uH			ELJ-RE33NJF2	L1690720		1-	B	
L526	M.RFC	0.033uH			ELJ-RE33NJF2	L1690720		1-	B	
L527	M.RFC	0.0056uH			ELJ-RE5N6JF2	L1690711		1-	B	
L528	CHIP COIL	0.068uH			LQN21A68NJ04	L1690605		1-	B	
L529	M.RFC	0.0056uH			ELJ-RE5N6JF2	L1690711		1-	B	
L530	M.RFC	0.033uH			ELJ-RE33NJF2	L1690720		1-	B	
L531	M.RFC	0.015uH			ELJ-RE15NJF2	L1690716		1-	B	
L532	CHIP COIL	0.012uH			LQG11A12NJ00T1	L1690753		1-	B	
L533	CHIP COIL	0.012uH			LQG11A12NJ00T1	L1690753		1-	B	
L534	CHIP COIL	0.012uH			LQG11A12NJ00T1	L1690753		1-	B	
L535	CHIP COIL	0.012uH			LQG11A12NJ00T1	L1690753		1-	B	
L536	CHIP COIL	0.015uH			LQG11A15NJ00T1	L1690754		1-	B	
L537	CHIP COIL	0.0068uH			LQG11A6N8J00T1	L1690750		1-	B	
L538	CHIP COIL	0.0068uH			LQG11A6N8J00T1	L1690750		1-	B	
L540	M.RFC	0.039uH			ELJ-RE39NJF2	L1690721		1-	B	
L541	CHIP COIL	0.01uH			LQG11A10NJ00T1	L1690752		1-	B	
L542	M.RFC	0.068uH			ELJ-RE68NJF3	L1690724		1-	B	
L543	M.RFC	0.068uH			ELJ-RE68NJF3	L1690724		1-	B	
L544	CHIP COIL	0.033uH			LQG11A33NJ00T1	L1690758		1-	B	
L545	M.RFC	10uH			ELJ-FC100JF	L1690935		1-	B	
L546	M.RFC	0.022uH			LL1608-FH22NJ	L1690865		1-	A	
L547	M.RFC	0.022uH			LL1608-FH22NJ	L1690865		1-	A	
L548	M.RFC	0.047uH			LL1608-FH47NJ	L1690869		1-	A	
L549	CHIP COIL	0.0033uH			LQN21A3N3D04	L1690606		1-	A	
L550	CHIP COIL	0.022uH			LQN21A22NJ04	L1690613		1-	A	
L551	M.RFC	0.047uH			ELJ-RE47NJF2	L1690722		1-	B	
L552	CHIP COIL	0.0082uH			LQG11A8N2J00T1	L1690751		1-	B	
L553	M.RFC	4.7uH			ELJ-FC4R7JF	L1690934		1-	A	
L554	CHIP COIL	0.22uH			LQN21AR22J04	L1690600		1-	A	
L555	M.RFC	0.022uH			LL1608-FH22NJ	L1690865		1-	B	
L556	M.RFC	0.047uH			LL1608-FH47NJ	L1690869		1-	A	
L557	M.RFC	1uH			MLF1608A1R0KT	L1690930		1-	A	
L558	M.RFC	1uH			MLF1608A1R0KT	L1690930		1-	A	
Q501	DIODE				1SS302 TE85R	G2070088		1-	B	c1
Q502	DIODE				1SS364(TE85R)	G2070730		1-	B	c2
Q503	DIODE				1SS364(TE85R)	G2070730		1-	B	c2
Q504	TRANSISTOR				DTA144EE TL	G3070074		1-	B	c1
Q505	DIODE				HVU131TRF	G2070462		1-	B	c2
Q506	DIODE				HVU131TRF	G2070462		1-	B	c2
Q507	DIODE				HVU131TRF	G2070462		1-	B	c3
Q508	TRANSISTOR				2SC5006-T1	G3350068		1-	B	c3
Q509	DIODE				HVU131TRF	G2070462		1-	B	c3
Q510	DIODE				HVU131TRF	G2070462		1-	B	c2
Q511	DIODE				1SS314 TPH3	G2070122		1-	B	c3
Q512	DIODE				HVU131TRF	G2070462		1-	A	B1
Q513	TRANSISTOR				2SC4215Y TE85R	G3342157Y		1-	A	B2
Q514	DIODE				HVU131TRF	G2070462		1-	A	B3
Q515	DIODE				1SS314 TPH3	G2070122		1-	B	b1
Q516	DIODE				HVU131TRF	G2070462		1-	B	c1
Q517	TRANSISTOR				2SC5006-T1	G3350068		1-	B	b2
Q518	TRANSISTOR				2SC5006-T1	G3350068		1-	B	b2
Q519	DIODE				HVU131TRF	G2070462		1-	B	b3

REF.	DESCRIPTION	VALUE	V/W	TOL.	MFR'S DESIG	VXSTD P/N	VERS.	LOT.	SIDE	LAY ADR
Q520	TRANSISTOR				2SC5006-T1	G3350068		1-	B	d3
Q521	DIODE				HVU131TRF	G2070462		1-	B	b1
Q522	DIODE				HVU131TRF	G2070462		1-	B	b3
Q523	TRANSISTOR				2SC5006-T1	G3350068		1-	B	b2
Q524	TRANSISTOR				2SC5010-T1	G3350108		1-	B	d3
Q525	DIODE				1SS314 TPH3	G2070122		1-	B	c2
Q526	IC				UPC2748T-E3	G1093077		1-	B	c3
Q527	DIODE				1SS314 TPH3	G2070122		1-	B	c3
Q528	IC				UPC2757T-E3	G1093078		1-	B	c3
Q529	DIODE				1SS364(TE85R)	G2070730		1-	B	d4
Q530	TRANSISTOR				2SC5006-T1	G3350068		1-	B	c5
Q531	DIODE				1SS314 TPH3	G2070122		1-	B	c5
Q532	TRANSISTOR				2SC5006-T1	G3350068		1-	B	d5
Q533	DIODE				1SS314 TPH3	G2070122		1-	B	c5
Q534	FET				3SK318 TL	G4803188		1-	B	c5
Q535	TRANSISTOR				2SC4215Y TE85R	G3342157Y		1-	B	b4
Q536	TRANSISTOR				2SC5006-T1	G3350068		1-	A	B4
Q537	TRANSISTOR				2SC5006-T1	G3350068		1-	A	C4
Q538	TRANSISTOR				2SC5006-T1	G3350068		1-	A	C4
Q539	DIODE				1SS371(TPH3)	G2070728		1-	A	C5
Q540	DIODE				HVC350B-TRF	G2070596		1-	A	B5
Q541	IC				MB15F02PFV	G1093080		1-	B	a4
Q542	TRANSISTOR				2SC4617 TL R	G3346178R		1-	A	D4
Q543	FET				2SK1580-T1	G3815808		1-	B	a5
Q544	TRANSISTOR				UMG2N TR	G3070088		1-	B	b5
Q545	TRANSISTOR				UMA2N TR	G3070213		1-	A	B3
Q546	TRANSISTOR				UMA2N TR	G3070213		1-	A	C3
Q547	TRANSISTOR				UMA2N TR	G3070213		1-	A	B3
Q548	TRANSISTOR				UMA2N TR	G3070213		1-	A	B3
Q549	IC				BU4094BCFV-E1	G1092128		1-	A	B3
Q550	TRANSISTOR				UMA2N TR	G3070213		1-	A	C5
Q551	TRANSISTOR				UMA2N TR	G3070213		1-	A	B3
Q552	TRANSISTOR				UMA2N TR	G3070213		1-	A	B4
Q553	IC				BU4094BCFV-E1	G1092128		1-	A	B4
Q554	DIODE				HVC350B-TRF	G2070596		1-	A	B5
Q555	DIODE				HVU131TRF	G2070462		1-	B	b3
Q556	DIODE				HVU131TRF	G2070462		1-	B	d2
Q557	DIODE				HVU131TRF	G2070462		1-	B	d3
Q558	DIODE				HVU131TRF	G2070462		1-	B	d2
Q559	DIODE				HVU131TRF	G2070462		1-	B	d3
Q560	DIODE				1SS387(TPL3)	G2070606	USA	11-		
Q560	DIODE				1SS387(TPL3)	G2070606	B1	9-		
Q560	DIODE				1SS387(TPL3)	G2070606	B2	9-		
R501	CHIP RES.	10k	1/16W	5%	RMC1/16 103JATP	J24185103		1-	B	
R502	CHIP RES.	10k	1/16W	5%	RMC1/16 103JATP	J24185103		1-	B	
R503	CHIP RES.	39	1/16W	5%	RMC1/16 390JATP	J24185390		1-	B	
R504	CHIP RES.	10	1/16W	5%	RMC1/16 100JATP	J24185100		1-	B	
R505	CHIP RES.	39	1/16W	5%	RMC1/16 390JATP	J24185390		1-	B	
R506	CHIP RES.	10k	1/16W	5%	RMC1/16 103JATP	J24185103		1-	B	
R507	CHIP RES.	10k	1/16W	5%	RMC1/16 103JATP	J24185103		1-	B	
R508	CHIP RES.	2.2k	1/16W	5%	RMC1/16 222JATP	J24185222		1-	B	
R509	CHIP RES.	100k	1/16W	5%	RMC1/16 104JATP	J24185104		1-	B	
R510	CHIP RES.	10k	1/16W	5%	RMC1/16 103JATP	J24185103		1-	B	
R511	CHIP RES.	2.2k	1/16W	5%	RMC1/16 222JATP	J24185222		1-	A	
R512	CHIP RES.	47k	1/16W	5%	RMC1/16 473JATP	J24185473		1-	B	
R513	CHIP RES.	10k	1/16W	5%	RMC1/16 103JATP	J24185103		1-	B	
R514	CHIP RES.	470	1/16W	5%	RMC1/16 471JATP	J24185471		1-	B	
R515	CHIP RES.	100	1/16W	5%	RMC1/16 101JATP	J24185101		1-	B	
R516	CHIP RES.	100k	1/16W	5%	RMC1/16 104JATP	J24185104		1-	A	
R517	CHIP RES.	2.2k	1/16W	5%	RMC1/16 222JATP	J24185222		1-	A	
R518	CHIP RES.	2.2k	1/16W	5%	RMC1/16 222JATP	J24185222		1-	A	
R519	CHIP RES.	100k	1/16W	5%	RMC1/16 104JATP	J24185104		1-	A	
R520	CHIP RES.	10k	1/16W	5%	RMC1/16 103JATP	J24185103		1-	B	
R521	CHIP RES.	2.2k	1/16W	5%	RMC1/16 222JATP	J24185222		1-	B	
R522	CHIP RES.	330	1/16W	5%	RMC1/16 331JATP	J24185331		1-	B	
R523	CHIP RES.	100k	1/16W	5%	RMC1/16 104JATP	J24185104		1-	A	
R524	CHIP RES.	2.2k	1/16W	5%	RMC1/16 222JATP	J24185222		1-	B	

RF Unit

REF.	DESCRIPTION	VALUE	V/W	TOL.	MFR'S DESIG	VXSTD P/N	VERS.	LOT.	SIDE	LAY ADR
R525	CHIP RES.	100	1/16W	5%	RMC1/16 101JATP	J24185101		1-	B	
R526	CHIP RES.	100k	1/16W	5%	RMC1/16 104JATP	J24185104		1-	A	
R527	CHIP RES.	2.2k	1/16W	5%	RMC1/16 222JATP	J24185222		1-	B	
R528	CHIP RES.	100k	1/16W	5%	RMC1/16 104JATP	J24185104		1-	B	
R529	CHIP RES.	100	1/16W	5%	RMC1/16 101JATP	J24185101		1-	B	
R530	CHIP RES.	330	1/16W	5%	RMC1/16 331JATP	J24185331		1-	B	
R531	CHIP RES.	47k	1/16W	5%	RMC1/16 473JATP	J24185473		1-	A	
R532	CHIP RES.	330	1/16W	5%	RMC1/16 331JATP	J24185331		1-	B	
R533	CHIP RES.	2.2k	1/16W	5%	RMC1/16 222JATP	J24185222		1-	B	
R534	CHIP RES.	47k	1/16W	5%	RMC1/16 473JATP	J24185473		1-	A	
R535	CHIP RES.	47k	1/16W	5%	RMC1/16 473JATP	J24185473		1-	B	
R536	CHIP RES.	100	1/16W	5%	RMC1/16 101JATP	J24185101		1-	B	
R537	CHIP RES.	2.2k	1/16W	5%	RMC1/16 222JATP	J24185222		1-	B	
R538	CHIP RES.	100k	1/16W	5%	RMC1/16 104JATP	J24185104		1-	A	
R539	CHIP RES.	47k	1/16W	5%	RMC1/16 473JATP	J24185473		1-	B	
R540	CHIP RES.	100k	1/16W	5%	RMC1/16 104JATP	J24185104		1-	B	
R541	CHIP RES.	100	1/16W	5%	RMC1/16 101JATP	J24185101		1-	B	
R542	CHIP RES.	2.2k	1/16W	5%	RMC1/16 222JATP	J24185222		1-	B	
R543	CHIP RES.	100k	1/16W	5%	RMC1/16 104JATP	J24185104		1-	A	
R544	CHIP RES.	100	1/16W	5%	RMC1/16 101JATP	J24185101		1-	B	
R545	CHIP RES.	10k	1/16W	5%	RMC1/16 103JATP	J24185103		1-	B	
R546	CHIP RES.	10k	1/16W	5%	RMC1/16 103JATP	J24185103		1-	B	
R547	CHIP RES.	2.2k	1/16W	5%	RMC1/16 222JATP	J24185222		1-	B	
R548	CHIP RES.	100k	1/16W	5%	RMC1/16 104JATP	J24185104		1-	B	
R549	CHIP RES.	47k	1/16W	5%	RMC1/16 473JATP	J24185473		1-	B	
R550	CHIP RES.	100	1/16W	5%	RMC1/16 101JATP	J24185101		1-	B	
R551	CHIP RES.	2.2k	1/16W	5%	RMC1/16 222JATP	J24185222		1-	B	
R552	CHIP RES.	22k	1/16W	5%	RMC1/16 223JATP	J24185223		1-	B	
R553	CHIP RES.	100	1/16W	5%	RMC1/16 101JATP	J24185101		1-	B	
R554	CHIP RES.	100k	1/16W	5%	RMC1/16 104JATP	J24185104		1-	B	
R555	CHIP RES.	10k	1/16W	5%	RMC1/16 103JATP	J24185103		1-	B	
R556	CHIP RES.	120k	1/16W	5%	RMC1/16 124JATP	J24185124		1-	B	
R557	CHIP RES.	100k	1/16W	5%	RMC1/16 104JATP	J24185104		1-	B	
R558	CHIP RES.	100k	1/16W	5%	RMC1/16 104JATP	J24185104		1-	B	
R559	CHIP RES.	100k	1/16W	5%	RMC1/16 104JATP	J24185104		1-	B	
R560	CHIP RES.	330	1/16W	5%	RMC1/16 331JATP	J24185331		1-	B	
R561	CHIP RES.	330	1/16W	5%	RMC1/16 331JATP	J24185331		1-	B	
R562	CHIP RES.	100	1/16W	5%	RMC1/16 101JATP	J24185101		1-	B	
R563	CHIP RES.	100k	1/16W	5%	RMC1/16 104JATP	J24185104		1-	B	
R564	CHIP RES.	100k	1/10W	5%	RMC1/10T 104J	J24205104		1-	B	
R565	CHIP RES.	330	1/16W	5%	RMC1/16 331JATP	J24185331		1-	B	
R566	CHIP RES.	100	1/16W	5%	RMC1/16 101JATP	J24185101		1-	B	
R567	CHIP RES.	100	1/16W	5%	RMC1/16 101JATP	J24185101		1-	A	
R568	CHIP RES.	100k	1/16W	5%	RMC1/16 104JATP	J24185104		1-	A	
R569	CHIP RES.	100	1/16W	5%	RMC1/16 101JATP	J24185101		1-	A	
R570	CHIP RES.	100k	1/16W	5%	RMC1/16 104JATP	J24185104		1-	A	
R571	CHIP RES.	470	1/16W	5%	RMC1/16 471JATP	J24185471		1-	A	
R572	CHIP RES.	100	1/16W	5%	RMC1/16 101JATP	J24185101		1-	A	
R573	CHIP RES.	4.7k	1/16W	5%	RMC1/16 472JATP	J24185472		1-	A	
R574	CHIP RES.	10k	1/16W	5%	RMC1/16 103JATP	J24185103		1-	A	
R575	CHIP RES.	4.7k	1/16W	5%	RMC1/16 472JATP	J24185472		1-	A	
R576	CHIP RES.	4.7k	1/16W	5%	RMC1/16 472JATP	J24185472		1-	A	
R579	CHIP RES.	1k	1/16W	5%	RMC1/16 102JATP	J24185102		1-	B	
R580	CHIP RES.	470	1/16W	5%	RMC1/16 471JATP	J24185471		1-	B	
R581	CHIP RES.	100	1/16W	5%	RMC1/16 101JATP	J24185101		1-	B	
R582	CHIP RES.	1.5k	1/16W	5%	RMC1/16 152JATP	J24185152		1-	A	
R583	CHIP RES.	470k	1/16W	5%	RMC1/16 474JATP	J24185474		1-	A	
R584	CHIP RES.	1k	1/16W	5%	RMC1/16 102JATP	J24185102		1-	B	
R584	CHIP RES.	10k	1/16W	5%	RMC1/16 103JATP	J24185103	USA	11-	B	
R584	CHIP RES.	10k	1/16W	5%	RMC1/16 103JATP	J24185103	B1	7-	B	
R584	CHIP RES.	10k	1/16W	5%	RMC1/16 103JATP	J24185103	B2	7-	B	
R585	CHIP RES.	10	1/16W	5%	RMC1/16 100JATP	J24185100		1-	A	
R586	CHIP RES.	0	1/16W	5%	RMC1/16 000JATP	J24185000		1-	A	
R587	CHIP RES.	10k	1/16W	5%	RMC1/16 103JATP	J24185103		1-	B	
R588	CHIP RES.	22k	1/16W	5%	RMC1/16 223JATP	J24185223		1-	B	
R589	CHIP RES.	2.2k	1/16W	5%	RMC1/16 222JATP	J24185222		1-	B	
R590	CHIP RES.	10k	1/16W	5%	RMC1/16 103JATP	J24185103		1-	B	

REF.	DESCRIPTION	VALUE	V/W	TOL.	MFR'S DESIG	VXSTD P/N	VERS.	LOT.	SIDE	LAY ADR
R591	CHIP RES.	470	1/16W	5%	RMC1/16 471JATP	J24185471		1-	B	
R592	CHIP RES.	1k	1/16W	5%	RMC1/16 102JATP	J24185102		1-	B	
R593	CHIP RES.	1k	1/16W	5%	RMC1/16 102JATP	J24185102		1-	B	
R594	CHIP RES.	1k	1/16W	5%	RMC1/16 102JATP	J24185102		1-	B	
R595	CHIP RES.	1k	1/16W	5%	RMC1/16 102JATP	J24185102		1-	B	
R596	CHIP RES.	8.2	1/16W	5%	RMC1/16 8R2JATP	J24185829		1-	A	
R597	CHIP RES.	150	1/16W	5%	RMC1/16 151JATP	J24185151		1-	A	
R598	CHIP RES.	8.2	1/16W	5%	RMC1/16 8R2JATP	J24185829		1-	A	
R599	CHIP RES.	4.7k	1/16W	5%	RMC1/16 472JATP	J24185472		1-	B	
R600	CHIP RES.	220k	1/16W	5%	RMC1/16 224JATP	J24185224		1-	B	
R601	CHIP RES.	220k	1/16W	5%	RMC1/16 224JATP	J24185224		1-	B	
R602	CHIP RES.	4.7k	1/16W	5%	RMC1/16 472JATP	J24185472		1-	B	
R603	CHIP RES.	470	1/16W	5%	RMC1/16 471JATP	J24185471		1-	B	
R604	CHIP RES.	47k	1/16W	5%	RMC1/16 473JATP	J24185473		1-	B	
R605	CHIP RES.	100k	1/16W	5%	RMC1/16 104JATP	J24185104		1-	A	
R606	CHIP RES.	0	1/16W	5%	RMC1/16 000JATP	J24185000		1-	A	
R608	CHIP RES.	2.2k	1/16W	5%	RMC1/16 222JATP	J24185222		1-	B	
R609	CHIP RES.	2.2k	1/16W	5%	RMC1/16 222JATP	J24185222		1-	A	
R610	CHIP RES.	100k	1/16W	5%	RMC1/16 104JATP	J24185104		1-	A	
R611	CHIP RES.	47k	1/16W	5%	RMC1/16 473JATP	J24185473		1-	A	
R612	CHIP RES.	33	1/16W	5%	RMC1/16 330JATP	J24185330		1-	A	
R613	CHIP RES.	470	1/16W	5%	RMC1/16 471JATP	J24185471		1-	A	
R614	CHIP RES.	100	1/16W	5%	RMC1/16 101JATP	J24185101		1-	A	
R615	CHIP RES.	2.2k	1/16W	5%	RMC1/16 222JATP	J24185222		1-	B	
R616	CHIP RES.	47k	1/16W	5%	RMC1/16 473JATP	J24185473		1-	B	
R617	CHIP RES.	2.2k	1/16W	5%	RMC1/16 222JATP	J24185222		1-	B	
R618	CHIP RES.	100	1/16W	5%	RMC1/16 101JATP	J24185101		1-	B	
R619	CHIP RES.	150	1/16W	5%	RMC1/16 151JATP	J24185151		1-	B	
R620	CHIP RES.	0	1/16W	5%	RMC1/16 000JATP	J24185000		1-	A	
R621	CHIP RES.	330	1/16W	5%	RMC1/16 331JATP	J24185331		1-	B	
R622	CHIP RES.	33k	1/16W	5%	RMC1/16 333JATP	J24185333		1-	B	
R622	CHIP RES.	47k	1/16W	5%	RMC1/16 473JATP	J24185473	USA	5-	B	
R622	CHIP RES.	47k	1/16W	5%	RMC1/16 473JATP	J24185473	B1	5-	B	
R622	CHIP RES.	47k	1/16W	5%	RMC1/16 473JATP	J24185473	B2	5-	B	
R623	CHIP RES.	10	1/16W	5%	RMC1/16 100JATP	J24185100		1-	A	
R624	CHIP RES.	330k	1/16W	5%	RMC1/16 334JATP	J24185334		9-		
R625	CHIP RES.	100	1/16W	5%	RMC1/16 101JATP	J24185101	B1	14-		
R625	CHIP RES.	100	1/16W	5%	RMC1/16 101JATP	J24185101	B2	14-		
X501	XTAL	15.2MHz			38CHT 15.2MHz	S8100779		1-	A	
X501	XTAL	15.2MHz			HT-38 15.2MHz	S8100883		8-	A	
	RF SHIELD CASE					S8001731		1-		
	SHIELD PLATE					S8001723		1-		

RF Unit
Note:

Parts Layout

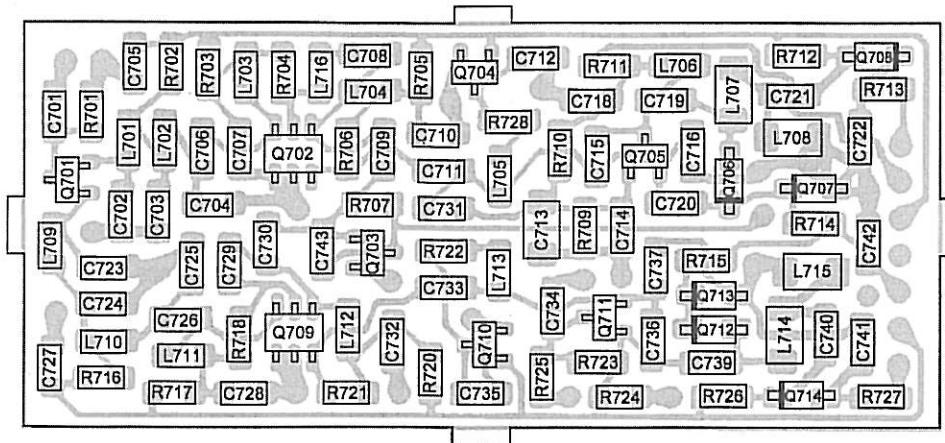

Side A

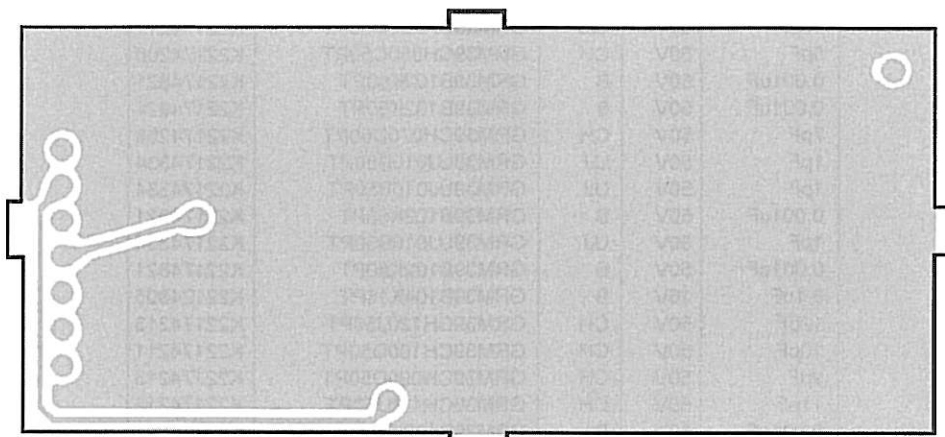

Side B

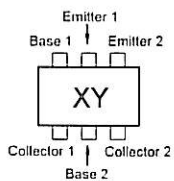

μPA811T (XY)
(Q702, 709)

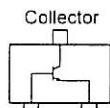

2SC5006 (24)
(Q711)
2SC5010 (83)
(Q703, 705)

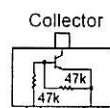

DTC144EE (26)
(Q704, 710)

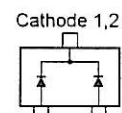

1SS364 (BF)
(Q701)

VCO Unit

Parts List

REF.	DESCRIPTION	VALUE	V/W	TOL.	MFR'S DESIG	YAESU P/N	VERS.	LOT.	SIDE	LAY ADR
*** VCO UNIT ***										
PCB with Components						Q7000308				
C701	CHIP CAP.	0.001uF	50V	B	GRM39B102K50PT	K22174821		1-	A	
C702	CHIP CAP.	5pF	50V	CH	GRM39CH050C50PT	K22174206		1-	A	
C703	CHIP CAP.	8pF	50V	CH	GRM39CH080D50PT	K22174209		1-	A	
C704	CHIP CAP.	3pF	50V	UJ	GRM39UJ030B50PT	K22174337		1-	A	
C705	CHIP CAP.	0.001uF	50V	B	GRM39B102K50PT	K22174821		1-	A	
C706	CHIP CAP.	3pF	50V	UJ	GRM39UJ030B50PT	K22174337		1-	A	
C707	CHIP CAP.	0.001uF	50V	B	GRM39B102K50PT	K22174821		1-	A	
C708	CHIP CAP.	3pF	50V	UJ	GRM39UJ030B50PT	K22174337		1-	A	
C709	CHIP CAP.	1pF	50V	UJ	GRM39UJ010B50PT	K22174334		1-	A	
C710	CHIP CAP.	0.001uF	50V	B	GRM39B102K50PT	K22174821		1-	A	
C711	CHIP CAP.	1pF	50V	UJ	GRM39UJ010B50PT	K22174334		1-	A	
C712	CHIP CAP.	0.1uF	16V	B	GRM39B104K16PT	K22124805		1-	A	
C713	CHIP TA. CAP.	2.2uF	4V		TESVSP0G225M-8R	K78060025		1-	A	
C714	CHIP CAP.	0.001uF	50V	B	GRM39B102K50PT	K22174821		1-	A	
C716	CHIP CAP.	5pF	50V	CH	GRM39CH050C50PT	K22174206		1-	A	
C718	CHIP CAP.	0.001uF	50V	B	GRM39B102K50PT	K22174821		1-	A	
C719	CHIP CAP.	16pF	50V	CH	GRM39CH160J50PT	K22174216		1-	A	
C720	CHIP CAP.	15pF	50V	CH	GRM39CH150J50PT	K22174215		1-	A	
C721	CHIP CAP.	0.001uF	50V	B	GRM39B102K50PT	K22174821		1-	A	
C722	CHIP CAP.	0.001uF	50V	B	GRM39B102K50PT	K22174821		1-	A	
C723	CHIP CAP.	7pF	50V	CH	GRM39CH070D50PT	K22174208		1-	A	
C724	CHIP CAP.	15pF	50V	CH	GRM39CH150J50PT	K22174215		1-	A	
C725	CHIP CAP.	10pF	50V	CH	GRM39CH100D50PT	K22174211		1-	A	
C726	CHIP CAP.	5pF	50V	CH	GRM39CH050C50PT	K22174206		1-	A	
C727	CHIP CAP.	0.001uF	50V	B	GRM39B102K50PT	K22174821		1-	A	
C728	CHIP CAP.	0.001uF	50V	B	GRM39B102K50PT	K22174821		1-	A	
C729	CHIP CAP.	7pF	50V	CH	GRM39CH070D50PT	K22174208		1-	A	
C730	CHIP CAP.	1pF	50V	UJ	GRM39UJ010B50PT	K22174334		1-	A	
C731	CHIP CAP.	1pF	50V	UJ	GRM39UJ010B50PT	K22174334		1-	A	
C732	CHIP CAP.	0.001uF	50V	B	GRM39B102K50PT	K22174821		1-	A	
C733	CHIP CAP.	1pF	50V	UJ	GRM39UJ010B50PT	K22174334		1-	A	
C734	CHIP CAP.	0.001uF	50V	B	GRM39B102K50PT	K22174821		1-	A	
C735	CHIP CAP.	0.1uF	16V	B	GRM39B104K16PT	K22124805		1-	A	
C736	CHIP CAP.	12pF	50V	CH	GRM39CH120J50PT	K22174213		1-	A	
C737	CHIP CAP.	10pF	50V	CH	GRM39CH100D50PT	K22174211		1-	A	
C739	CHIP CAP.	9pF	50V	CH	GRM39CH090D50PT	K22174213		-1	A	
C739	CHIP CAP.	11pF	50V	CH	GRM39CH110J50PT	K22174212		2-	A	
C740	CHIP CAP.	0.001uF	50V	B	GRM39B102K50PT	K22174821		1-	A	
C741	CHIP CAP.	0.001uF	50V	B	GRM39B102K50PT	K22174821		1-	A	
C742	CHIP CAP.	0.001uF	50V	B	GRM39B102K50PT	K22174821		1-	A	
C743	CHIP CAP.	2pF	50V	UJ	GRM39UJ020B50PT	K22174336		1-	A	
J701	CONNECTOR				850-90-002-10-001	P0091248		1-	A	
J702	CONNECTOR				850-90-007-10-001	P0091249		1-	A	
L701	CHIP COIL	0.012uH			LQG11A12NJ00T1	L1690753		1-	A	
L702	CHIP COIL	0.012uH			LQG11A12NJ00T1	L1690753		1-	A	
L703	M.RFC	0.047uH			LL1608-FH47NJ	L1690869		1-	A	
L704	M.RFC	0.022uH			LL1608-FH22NJ	L1690865		1-	A	
L705	M.RFC	1uH			MLF1608A1R0KT	L1690930		1-	A	
L706	M.RFC	1uH			MLF1608A1R0KT	L1690930		1-	A	
L707	CHIP COIL	0.0033uH			LQP21A3N3C14	L1690928		1-	A	
L708	CHIP COIL	0.0068uH			LQP21A6N8C14	L1690929		1-	A	
L709	M.RFC	0.022uH			LL1608-FH22NJ	L1690865		1-	A	
L710	M.RFC	0.022uH			LL1608-FH22NJ	L1690865		1-	A	
L711	M.RFC	0.047uH			LL1608-FH47NJ	L1690869		1-	A	
L712	M.RFC	0.033uH			ELJ-RE33NJF2	L1690720		1-	A	
L713	M.RFC	1uH			MLF1608A1R0KT	L1690930		1-	A	
L714	CHIP COIL	0.0068uH			LQN21A6N8D04	L1690607		1-	A	
L715	CHIP COIL	0.0068uH			LQN21A6N8D04	L1690607		1-	A	
L716	CHIP COIL	0.0047uH			LQG11A4N7S00T1	L1690748		1-	A	
Q701	DIODE				1SS364(TE85R)	G2070730		1-	A	
Q702	TRANSISTOR				UPA811T-T1	G3070253		1-	A	
Q703	TRANSISTOR				2SC5010-T1	G3350108		1-	A	
Q704	TRANSISTOR				DTC144EE TL	G3070075		1-	A	
Q705	TRANSISTOR				2SC5010-T1	G3350108		1-	A	
Q706	DIODE				HVE355TRF	G2070738		1-	A	

VCO Unit

REF.	DESCRIPTION	VALUE	V/W	TOL.	MFR'S DESIG	YAESU P/N	VERS.	LOT.	SIDE	LAY ADR
Q707	DIODE				HVE355TRF	G2070738		1-	A	
Q708	DIODE				1SS371(TPH3)	G2070728		1-	A	
Q709	TRANSISTOR				UPA811T-T1	G3070253		1-	A	
Q710	TRANSISTOR				DTC144EE TL	G3070075		1-	A	
Q711	TRANSISTOR				2SC5006-T1	G3350068		1-	A	
Q712	DIODE				HVC350B-TRF	G2070596		1-	A	
Q713	DIODE				HVC350B-TRF	G2070596		1-	A	
Q714	DIODE				1SS371(TPH3)	G2070728		1-	A	
R701	CHIP RES.	10k	1/16W	5%	RMC1/16 103JATP	J24185103		1-	A	
R702	CHIP RES.	10k	1/16W	5%	RMC1/16 103JATP	J24185103		1-	A	
R703	CHIP RES.	100	1/16W	5%	RMC1/16 101JATP	J24185101		1-	A	
R704	CHIP RES.	150k	1/16W	5%	RMC1/16 154JATP	J24185154		1-	A	
R705	CHIP RES.	100	1/16W	5%	RMC1/16 101JATP	J24185101		1-	A	
R706	CHIP RES.	150k	1/16W	5%	RMC1/16 154JATP	J24185154		1-	A	
R707	CHIP RES.	100k	1/16W	5%	RMC1/16 104JATP	J24185104		1-	A	
R709	CHIP RES.	18k	1/16W	5%	RMC1/16 183JATP	J24185183		1-	A	
R710	CHIP RES.	15k	1/16W	5%	RMC1/16 153JATP	J24185153		1-	A	
R711	CHIP RES.	100	1/16W	5%	RMC1/16 101JATP	J24185101		1-	A	
R712	CHIP RES.	4.7k	1/16W	5%	RMC1/16 472JATP	J24185472		1-	A	
R713	CHIP RES.	4.7k	1/16W	5%	RMC1/16 472JATP	J24185472		1-	A	
R714	CHIP RES.	4.7k	1/16W	5%	RMC1/16 472JATP	J24185472		1-	A	
R715	CHIP RES.	4.7k	1/16W	5%	RMC1/16 472JATP	J24185472		1-	A	
R716	CHIP RES.	10k	1/16W	5%	RMC1/16 103JATP	J24185103		1-	A	
R717	CHIP RES.	100	1/16W	5%	RMC1/16 101JATP	J24185101		1-	A	
R718	CHIP RES.	150k	1/16W	5%	RMC1/16 154JATP	J24185154		1-	A	
R720	CHIP RES.	100	1/16W	5%	RMC1/16 101JATP	J24185101		1-	A	
R721	CHIP RES.	150k	1/16W	5%	RMC1/16 154JATP	J24185154		1-	A	
R722	CHIP RES.	470	1/16W	5%	RMC1/16 471JATP	J24185471		1-	A	
R723	CHIP RES.	3.9k	1/16W	5%	RMC1/16 392JATP	J24185392		1-	A	
R724	CHIP RES.	10k	1/16W	5%	RMC1/16 103JATP	J24185103		1-	A	
R725	CHIP RES.	100	1/16W	5%	RMC1/16 101JATP	J24185101		1-	A	
R726	CHIP RES.	4.7k	1/16W	5%	RMC1/16 472JATP	J24185472		1-	A	
R727	CHIP RES.	4.7k	1/16W	5%	RMC1/16 472JATP	J24185472		1-	A	
R728	CHIP RES.	270	1/16W	5%	RMC1/16 271JATP	J24185271		1-	A	
	SHIELD CASE					S8001730		1-	A	

VCO Unit

Note:

Parts Layout

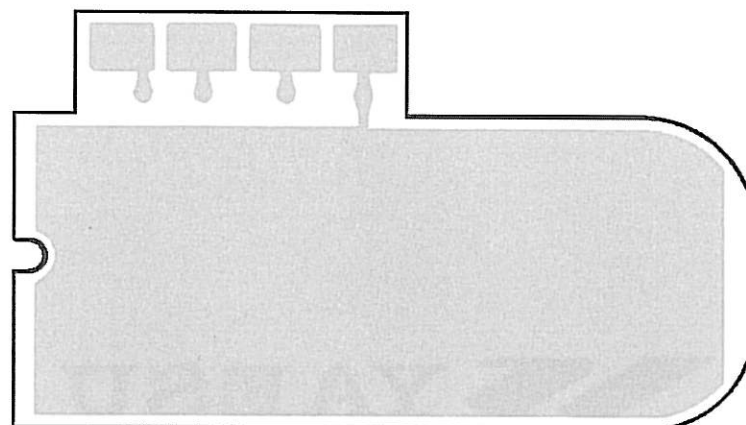
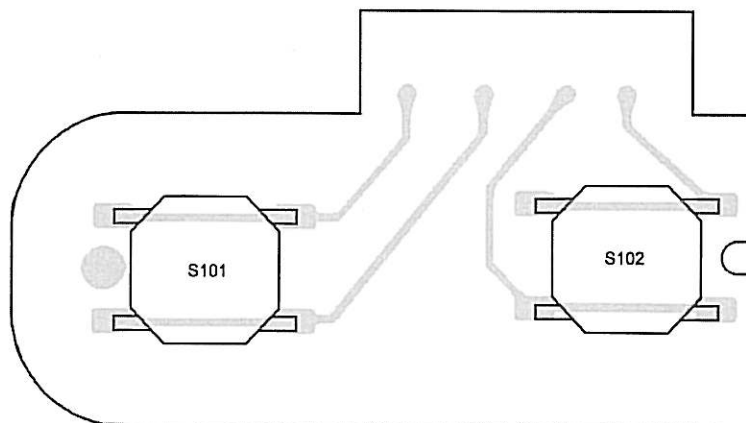

Parts List

REF.	DESCRIPTION	VALUE	V/W	TOL.	MFR'S DESIG	YAESU P/N	VERS.	LOT.	SIDE	LAY ADR
*** SW UNIT ***										
PCB with Components						Q7000306				
S101	TACT SWITCH				SKQGAB	N5090113		1-		
S102	TACT SWITCH				SKQGAB	N5090113		1-		



Copyright 2001
VERTEX STANDARD CO., LTD.
All rights reserved

No portion of this manual
may be reproduced without
the permission of
VERTEX STANDARD CO., LTD.

Printed in Japan.

0104N-BE



E 1 3 4 2 9 0 0 1