

COMMUNICATIONS
RECEIVER

VR-160

Technical Supplement

©2010 VERTEX STANDARD CO., LTD.

EH037M91A

VERTEX STANDARD CO., LTD.
4-8-8 Nakameguro, Meguro-Ku, Tokyo 153-8644, Japan

**VERTEX STANDARD
US Headquarters**
10900 Walker Street, Cypress, CA 90630, U.S.A.

YAESU UK LTD.
Unit 12, Sun Valley Business Park, Winnall Close
Winchester, Hampshire, SO23 0LB, U.K.

VERTEX STANDARD HK LTD.
Unit 5, 20/F., Seaview Centre, 139-141 Hoi Bun Road,
Kwun Tong, Kowloon, Hong Kong

VERTEX STANDARD (AUSTRALIA) PTY., LTD.
Normanby Business Park, Unit 14/45 Normanby Road
Notting Hill 3168, Victoria, Australia



Introduction

This manual provides the technical information necessary for servicing the VR-160 Communications Receiver.

Servicing this equipment requires expertise in handling surface-mount chip components. Attempts by non-qualified persons to service this equipment may result in permanent damage not covered by the warranty, and may be illegal in some countries.

Two PCB layout diagrams provided for each double-sided board in this transceiver. Each side of the board is referred to by the type of the majority of components installed on that side ("Side A" or "Side B"). In most cases one side has only chip components, and the other has either a mixture of both chip and leaded components (trimmers, coils, electrolytic capacitors, ICs, etc.), or leaded components only.

While we believe the information in this manual to be correct, VERTEX STANDARD assumes no liability for damage that may occur as a result of typographical or other errors that may be present. Your cooperation in pointing out any inconsistencies in the technical information would be appreciated.

Important Note

This receiver was assembled using Pb (lead) free solder, based on the RoHS specification.

Only lead-free solder (Alloy Composition: Sn-3.0Ag-0.5Cu) should be used for repairs performed on this apparatus. The solder stated above utilizes the alloy composition required for compliance with the lead-free specification, and any solder with the above alloy composition may be used.

Contents

Introduction	1
Specifications	2
Exploded View & Miscellaneous Parts	4
Block Diagram	5
Circuit Description	7
Alignment	9
Board Unit (Schematics, Layouts & Parts)	
MAIN Unit	13
SW Unit	29
VCO Unit	33

Specifications

General

Frequency Ranges Normal Band	0.1 - 1.8 MHz (BC Band)
	1.8 - 30 MHz (SW Band)
	30 - 76 MHz (50 MHz HAM)
	76 - 108 MHz (FM Radio Band)
	108 - 137 MHz (Air Band)
	137 - 174 MHz (144 MHz HAM)
	174 - 222 MHz (VHF TV)
	222 - 420 MHz (GEN1)
	420 - 470 MHz (430 MHz HAM)
	470 - 770 MHz (UHF TV)
	770 - 1000 MHz (GEN2)
	1000 - 1300MHz (1.2GHz HAM)
Frequency Ranges Radio Band	0.504 - 1.795 MHz (AM Broadcast)
	76 - 89.9 MHz (FM Broadcast)
Channel Steps:	5 / 8.33 / 9 / 10 / 12.5 / 15 / 20 / 25 / 50 / 100 kHz
Frequency Stability:	±5 ppm (-10 °C to +60 °C)
Antenna Impedance:	50-ohm
Supply Voltage:	Nominal: 3.7 V DC, FNB-82LI Battery Operation 6.0 V DC, PA-46C/U AC Adapter Operation Operating: 3.5 ~ 7.0 V, Negative Ground (EXT DC Jack)
Current Consumption:	140mA (Receive, Normal Band, VOL level: 20) 100mA (Receive, Radio Band, VOL level: 20) 58mA (Standby, Saver Off) 20mA (Standby, Saver On) 300uA (Auto Power Off)
Operating Temperature:	-20 °C to +60 °C
Battery Charging Temp. Range:	-5 °C to +35 °C
Case Size:	47 (W) ± 81 (H) ± 23 (D) mm (FNB-82LI W/O knob & antenna) 47 (W) ± 81 (H) ± 31 (D) mm (FBA-37 W/O knob & antenna)
Weight:	130 g With FNB-82LI & antenna 185 g With FBA-37 & antenna

Specifications

Receiver

Circuit Type:

AM, NFM: Double-Conversion Superheterodyne

WFM: Triple-Conversion Superheterodyne

AM Radio/FM Radio: Single-Conversion Superheterodyne

Intermediate Frequencies:

1st: 47.25MHz (AM, NFM)

1st: 45.8MHz (WFM)

2nd: 450 kHz (AM, NFM)

2nd: 10.7MHz (WFM)

3rd: 1MHz (WFM)

1st: 130 kHz (AM / FM Radio)

Sensitivity:

1 μ V for 12 dB SINAD (0.1 - 0.5 MHz, NFM)

1 μ V for 10 dB SN (0.5 - 1.8 MHz, AM Radio)

1 μ V for 10 dB SN (1.8 - 30 MHz, AM)

0.35 μ V TYP for 12 dB SINAD (30 - 54 MHz, NFM)

0.5 μ V TYP for 12 dB SINAD (54 - 76 MHz, NFM)

1 μ V TYP for 12 dB SINAD (76 - 108 MHz, FM Radio)

0.5 μ V TYP for 10 dB SN (108 - 137 MHz, AM)

0.2 μ V for 12 dB SINAD (137 - 140 MHz, NFM)

0.16 μ V for 12 dB SINAD (140 - 150 MHz, NFM)

0.2 μ V for 12 dB SINAD (150 - 174 MHz, NFM)

1 μ V for 12 dB SINAD (174 - 222 MHz, WFM)

0.5 μ V for 12 dB SINAD (300 - 350 MHz, NFM)

0.2 μ V for 12 dB SINAD (350 - 400 MHz, NFM)

0.18 μ V for 12 dB SINAD (400 - 470 MHz, NFM)

1 μ V for 12 dB SINAD (470 - 540 MHz, WFM)

1.5 μ V TYP for 12 dB SINAD (540 - 800 MHz, WFM)

0.5 μ V TYP for 12 dB SINAD (800 - 1000 MHz, NFM)

0.7 μ V TYP for 12dB SINAD (1000 - 1300 MHz, NFM)

Selectivity:

NFM, AM 12 kHz / 35 kHz (-6 dB / -60 dB) Without AM Radio Band

WFM 200 kHz / 300 kHz (-6 dB / -20 dB) Without FM Radio Band

AF Output:

50mW @ 8 W for 10 % THD (@ 4.5 V)

100mW @8 W for 10 % THD (@ 6 V)

Exploded View & Miscellaneous Parts

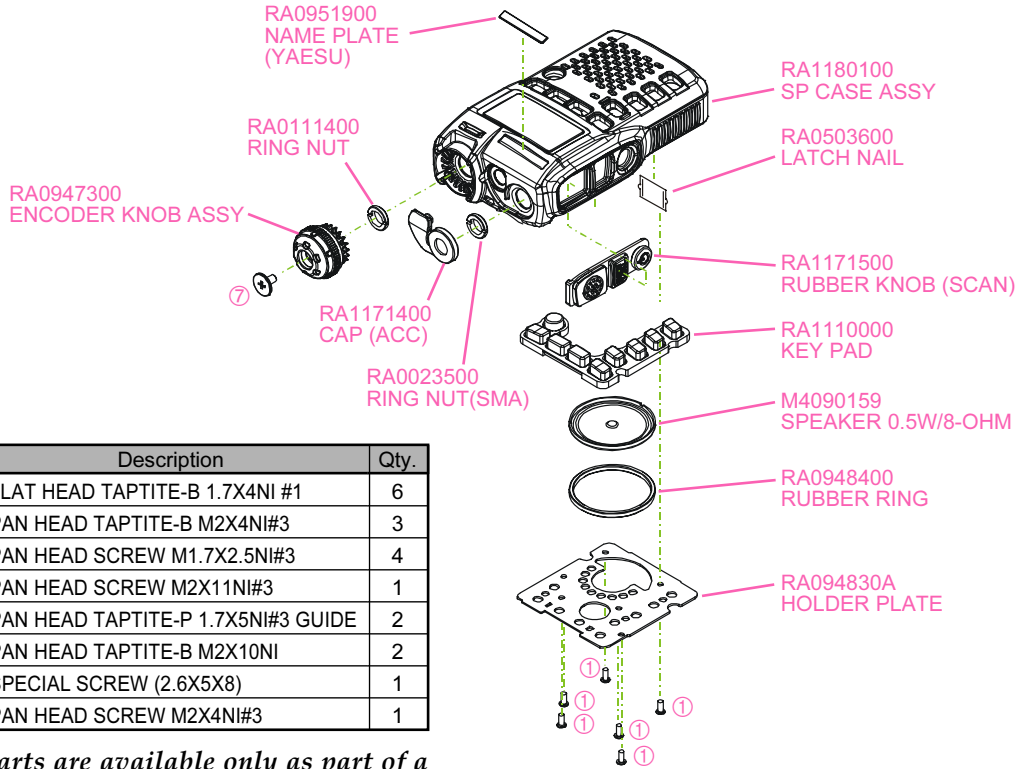

No.	VXSTD P/N	Description	Qty.
①	U9900220	FLAT HEAD TAPTITE-B 1.7X4NI #1	6
②	U9900068	PAN HEAD TAPTITE-B M2X4NI#3	3
③	U07125302	PAN HEAD SCREW M1.7X2.5NI#3	4
④	U9900156	PAN HEAD SCREW M2X11NI#3	1
⑤	U9900044	PAN HEAD TAPTITE-P 1.7X5NI#3 GUIDE	2
⑥	U44110002	PAN HEAD TAPTITE-B M2X10NI	2
⑦	RA0918600	SPECIAL SCREW (2.6X5X8)	1
⑧	U07240302	PAN HEAD SCREW M2X4NI#3	1

Non-designated parts are available only as part of a designated assembly.

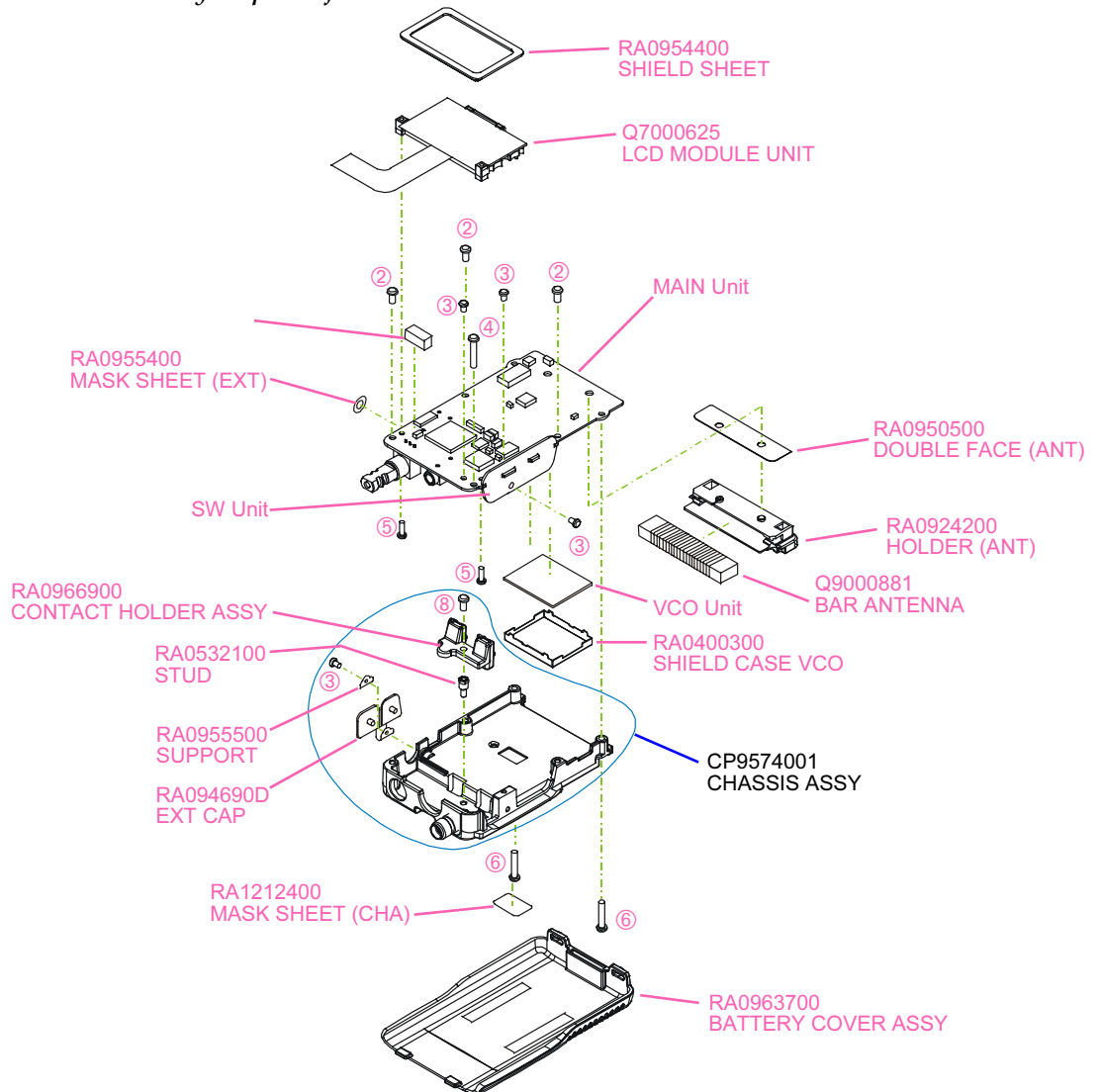

Block Diagram

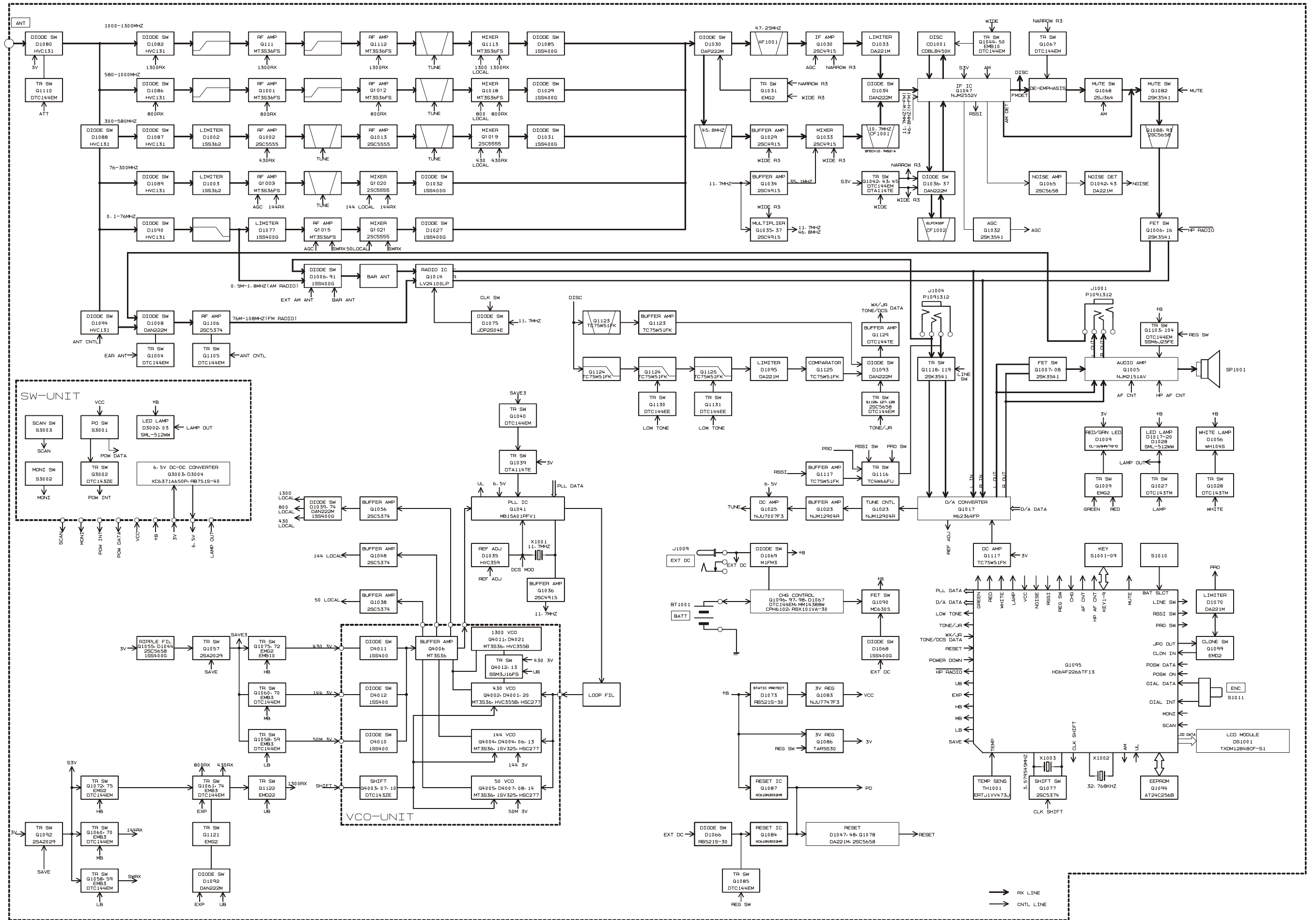

Block Diagram

Note

Circuit Description

The VR-160 consists of a MAIN-UNIT, a SW-UNIT, and a VCO-UNIT. The MAIN-UNIT contains the receiver front end, PLL IC, switching circuits, the CPU, audio ICs, and the power circuitry for the LCD, the IF, and audio ICs and the VCO-UNIT for receive local signal oscillation.

Receiver Signal Flow

The VX-160E includes four receiver front ends, each optimized for a particular frequency range and mode combination.

(1) HF Bands Reception (MW ~ 76 MHz)

Received signals between MW and 76 MHz pass through the ANT SW circuit, ANT switch circuit and protector diode **D1090 (HVC131)** before additional filtering by a band-pass filter prior to application to RF amplifier **Q1015 (MT3S36FS)**. The amplified RF signal is pass through the band-pass filter to first mixer **Q1021 (2SC5555)**. Meanwhile, HF and VHF output from the VCO-UNIT is amplified by **Q1032 (2SC5374)** and applied through diode ANT switch **D1027 (1SS400G)** to mixer **Q1021 (2SC5555)** as the first local signal.

The 47.25 MHz intermediate frequency product of the mixer is delivered to the IF circuit.

The TUNE voltage from the CPU is amplified by DC amplifier **Q1025 (NJU7007F3)**.

(2) VHF Bands Reception (76 MHz ~ 300 MHz)

Received signals between 76 and 300 MHz pass through the ANT SW circuit, VHF ANT switch circuit and protector diode **D1089 (HVC131)** before additional filtering by a band-pass filter prior to application to RF amplifier **Q1003 (MT3S36FS)**. The amplified RF signal is pass through the band-pass filter to first mixer **Q1020 (2SC5555)**. Meanwhile, VHF output from the VCO-UNIT is amplified by **Q1048 (2SC5374)** and applied through diode T/R switch **D1032 (1SS400G)** to mixer **Q1020 (2SC5555)** as the first local signal.

The 47.25 MHz intermediate frequency product of the mixer is delivered to the IF circuit.

The TUNE voltage from the CPU is amplified by DC amplifier **Q1025 (NJU7007F3)** and applied to varactors **D1011 (1SV325)**, **D1012 (1SV325)**, **D1013 (1SV331)**, **D1014 (1SV325)**, **D1015 (1SV325)**, **D1016 (1SV331)**, **D1025 (1SV325)**, and **D1026 (1SV325)** in the variable frequency band-pass filters. By changing the electrostatic capacitance of the varactors, optimum filter characteristics are provided for each specific operating frequency.

(3) UHF Bands Reception (300 MHz ~ 580 MHz)

Received signals between 300 and 580 MHz pass through the Triplexer circuit, low-pass filter/high-pass filter circuit, UHF ANT switch circuit and protector diode **D1087** and **D1088 (HVC131)** before additional filtering by a band-pass filter prior to application to RF amplifier **Q1002 (2SC5555)**. The amplified RF signal is pass through the band-pass filter, RF amplifier **Q1013 (2SC5555)** and band-pass filter to first mixer **Q1019 (2SC5555)**. Meanwhile, UHF output from the VCO-UNIT is amplified by **Q1056 (2SC5374)** and applied through diode ANT switch **D1039 (DAM222M)** to mixer **Q1019 (2SC5555)** as the first local signal.

The 47.25 MHz intermediate frequency product of the mixer is delivered to the IF circuit.

The TUNE voltage from the CPU is amplified by DC amplifier **Q1025 (NJU7007F3)** and applied to varactors **D1005**, **D1010**, **D1023**, and **D1024** (all **HVC358B**) in the variable frequency band-pass filters. By changing the electrostatic capacitance of the varactors, optimum filter characteristics are provided for each specific operating frequency.

(4) UHF Bands Reception (580 MHz ~ 1000 MHz)

Received signals between 580 and 1000 MHz pass through the Triplexer circuit, low-pass filter/high-pass filter circuit, UHF ANT switch circuit and protector diode **D1086 (HVC131)** before additional filtering by a band-pass filter prior to application to RF amplifier **Q1001 (MT3S36FS)**. The amplified RF signal is pass through the band-pass filter, RF amplifier **Q1012 (MT3S36FS)** and band-pass filter to first mixer **Q1018 (MT3S36FS)**. Meanwhile, UHF output from the VCO-UNIT is amplified by **Q1056 (2SC5374)** and applied through diode ANT switch **D1039 (DAM222M)** to mixer **Q1018 (MT3S36FS)** as the first local signal.

The 47.25 MHz intermediate frequency product of the mixer is delivered to the IF circuit.

The TUNE voltage from the CPU is amplified by DC amplifier **Q1025 (NJU7007F3)** and applied to varactors **D1021** and **D1022** (all **1SV331**) in the variable frequency band-pass filters. By changing the electrostatic capacitance of the varactors, optimum filter characteristics are provided for each specific operating frequency.

Circuit Description

(5) UHF Bands Reception (1000 MHz ~ 1300 MHz)

Received signals between 1000 and 1300 MHz pass through the Triplexer circuit, low-pass filter/high-pass filter circuit, UHF ANT switch circuit and protector diode **D1082 (HVC131)** before additional filtering by a band-pass filter prior to application to RF amplifier **Q1111 (MT3S36FS)**. The amplified RF signal is pass through the band-pass filter, RF amplifier **Q1112 (MT3S36FS)** and band-pass filter to first mixer **Q1113 (MT3S36FS)**. Meanwhile, UHF output from the VCO-UNIT is amplified by **Q1056 (2SC5374)** and applied through diode ANT switch **D1074 (1SS400G)** to mixer **Q1113 (MT3S36FS)** as the first local signal.

The 47.25 MHz intermediate frequency product of the mixer is delivered to the IF circuit.

The TUNE voltage from the CPU is amplified by DC amplifier **Q1025 (NJU7007F3)** and applied to varactors **D1083** and **D1084** (all **HVC3558**) in the variable frequency band-pass filters. By changing the electrostatic capacitance of the varactors, optimum filter characteristics are provided for each specific operating frequency.

(6) 47.25-MHz First Intermediate Frequency

The 47.25 MHz first intermediate frequency from first mixers is delivered from the first mixer to IF circuit. On the MAIN-UNIT, the IF for AM and FM-narrow signals is passed through diode switch **D1030 (DAP222M)** and 47.25 MHz monolithic crystal filter (MCF) XF1001 to narrow IF amplifier **Q1030 (2SC4915)** for input to IF IC **Q1047 (NJM2552V)** after amplitude limiting by **D1033 (DA221M)**.

Meanwhile, a portion of the output of 11.7 MHz crystal X1001 is multiplied fourfold by **Q1035** and **Q1037** (both **2SC4915**) to provide the 46.8 MHz second local signal, applied to the Narrow IF IC. Within the IC, this signal is mixed with the 47.25 MHz first intermediate frequency signal to produce the 450 kHz second intermediate frequency.

This second IF is filtered by ceramic filter CF1002 and amplified by the limiting amplifier within the Narrow IF IC before quadrature detection by ceramic discriminator CD1001.

Demodulated audio is output from pin 11 of the Narrow IF IC through narrow mute analog switch **Q1068 (2SJ364)**.

The resulting audio is amplified by AF amplifier **Q1005 (NJM2151AV)**, and output through EAR jack J1001 to internal speaker SP1001 or an external earphone.

PLL Frequency Synthesizer

PLL IC **Q1041 (MB15A01PFV1)** on the MAIN-UNIT consists of a data shift register, reference frequency divider, phase comparator, charge pump, intermittent operation circuit, and band selector switch. Serial PLL data from the CPU is converted into parallel data by the shift register in the PLL IC and is latched into the comparative frequency divider and reference frequency divider to set a frequency dividing ratio for each. An 11.7 MHz reference signal produced by X1001 is input to REF pin 1 of the PLL IC. The internal reference frequency divider divides the 11.7 MHz reference by 2,050 (or 1,640) to obtain a reference frequency of 5 kHz (or 6.25 kHz), which is applied to the phase comparator. Meanwhile, a sample of the output of VHF VCO Q4004 or UHF VCO Q4002 on the VCO-UNIT, buffered by Q4006, is input to the PLL IC, where it is frequency-divided by the internal comparative frequency divider to produce a comparative frequency also applied to the phase comparator. The phase comparator compares the phase between the reference frequency and comparative frequency to output a pulse corresponding to the phase difference between them. This pulse is input to the charge pump, and the output from the charge pump passes through a loop filter composed of R1280, R1281, R1170 and either C1185, C1187 and R1170, C1186, C1188 and C1189, which convert the pulse into a corresponding smoothed varactor control voltage (VCV). The VCV is applied to varactor **D4007 (1SV325)** in the MW ~ 76 MHz VCO tank circuit, or to varactor **D4001 (HVC355B)** in the UHF VCO tank circuit, to varactor **D4004** and **D4013** (both **1SV325**) in the VHF VCO tank circuit, or to varactor **D4001 (HVC355B)** in the UHF VCO tank circuit, or to varactor **D4021 (HVC355B)** in the 1200MHz VCO tank circuit, to eliminate phase difference between the reference frequency and comparative frequency, and so locking the VCO oscillation frequency to the reference crystal. The VCO frequency is determined by the frequency-dividing ratio sent from the CPU to the PLL IC. During receiver power save operation, the PLL circuit operates intermittently to reduce current consumption, for which the intermittent operation control circuit reduces the lock-up time.

Introduction

The VR-160 is carefully aligned at the factory for the specified performance across the amateur band. Realignment should therefore not be necessary except in the event of a component failure. Only an authorized VERTEX STANDARD representative should perform all component replacement and service, or the warranty policy may be void. The following procedures cover adjustments that are not normally required once the transceiver has left the factory. However, if damage occurs and some parts are subsequently replaced, realignment may be required. If a sudden problem occurs during normal operation, it is likely due to component failure; realignment should not be done until after the faulty component has been replaced. We recommend that servicing be performed only by authorized VERTEX STANDARD service technicians who are experienced with the circuitry and fully equipped for repair and alignment. If a fault is suspected, contact the dealer from whom the transceiver was purchased for instructions regarding repair. Authorized VERTEX STANDARD service technicians realign all circuits and make complete performance checks to ensure compliance with factory specifications after replacing any faulty components. Those who do undertake any of the following alignments are cautioned to proceed at their own risk. Problems caused by unauthorized attempts at realignment are not covered by the warranty policy. In addition, VERTEX STANDARD reserves the right to change circuits and alignment procedures in the interest of improved performance, without notifying owners.

Under no circumstances should any alignment be attempted unless the normal function and operation of the transceiver is clearly understood, the cause of the malfunction has been clearly pinpointed, any faulty components are replaced, and realignment is determined to be absolutely necessary.

The following test equipment (and familiarity with its use) is necessary for complete realignment. Correction of problems caused by misalignment resulting from use of improper test equipment is not covered under the warranty policy. While most steps do not require all of the equipment listed, the interactions of some adjustments may require that additional adjustments be performed. Do not attempt to perform only a single step unless it is clearly isolated electrically from all other steps. Have all test equipment ready before beginning and, follow all of the steps in a section in the order presented.

Required Test Equipment

- RF Signal Generator with calibrated output level at 1300 MHz
- SINAD Meter
- Frequency Counter: 0.2-ppm accuracy at 1300 MHz
- DC Voltmeter: high impedance
- 8-ohm AF Dummy Load
- Regulated DC Power Supply adjustable from 3.7 to 6 V DC, 2A

Alignment Preparation & Precautions

Correct alignment requires that the ambient temperature of the transceiver be the same as that of the test equipment, and that the temperature be held constant between 68 ~ 86 °F (20 ~ 30 °C). When the transceiver is brought into the shop from hot or cold air, it should be allowed some time to come to room temperature before alignment. Whenever possible, alignments should be made with oscillator shields and circuit boards firmly affixed in place. The test equipment must be thoroughly warmed up before beginning.

Note: Signal levels in dB referred to in the alignment procedure are based on 0 dB μ =0.5 μ V (closed circuit).

Test Setup

Set up the test equipment as shown below for transceiver alignment, and apply 4.4 V DC power to the transceiver. Refer to the drawings for Alignment Points.

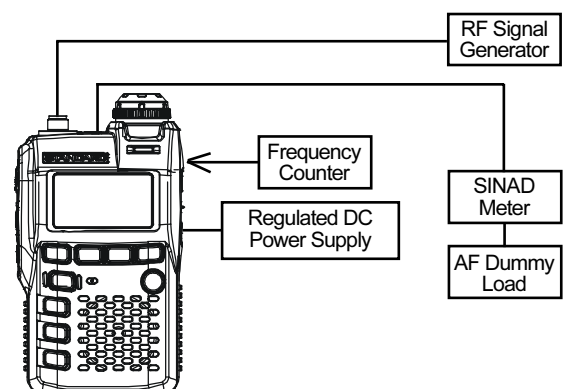

Alignment

Internal System Alignment Routine

This uses a programmed routine in the transceiver, which simplifies many previously complex discrete component settings and adjustments with digitally controlled settings via front panel buttons and LCD indications.

To enter the alignment mode:

- Program the alignment password "AH037M" into the CW ID memory via the Set Mode Item 37: OPEN MESSAGE. (See the box below for programming the alignment password.)
- Turn off the transceiver.
- Press and hold in the [**BANK**] button while powering the radio on to enter the alignment mode.
- In the alignment mode, each adjustment item is shown on the LCD in the Memory Channel Number display slot, and is selected by rotating the DIAL knob.

Warning!: Do not change the alignment items which are not described in the adjustment procedures.

Programming the Alignment Password

1. Press and hold in the [**BANK**] key for one second to enter the Set mode.
2. Rotate the DIAL knob to select Set Mode Item 37: OPEN MESSAGE.
Note: Do not forget to pull the DIAL knob to rotate the DIAL knob.
3. Press the [**BANK**] key momentarily to enable adjustment of this Set Mode Item.
4. Rotate the DIAL knob to set this Item to "MESSAGE".
5. Press the [**V/M**] key momentarily to display any previously stored Password.
Note the previously stored Password, so you can re-enter it later.
7. Rotate the DIAL knob to select the "A", then press the [**V/M**] key momentarily to save the "A" and move on to the next character.
8. Repeat the previous step to complete the alignment password "AH037M".
9. Press and hold in the [**BANK**] button while powering the radio on to enter the alignment mode.

PLL Reference Frequency Adjustment (REF)

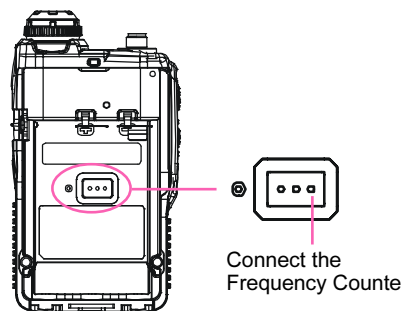
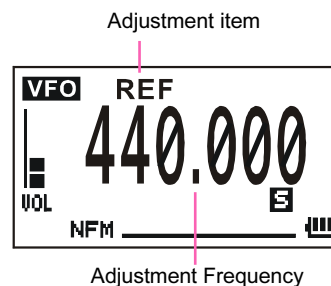

- Rotate the DIAL knob to select the alignment item "rEF".
- Press the [**V/M**] key.
- Press the PTT switch, then rotate the DIAL knob so that the Frequency Counter reading is 392.750 MHz \pm 200 Hz.
- Press the [**V/M**] key again.

430 MHz band

RX Tune Adjustment

- Connect the RF Signal Generator to the ANT jack, and then set the output level to -10 dB μ V at the 435.100 MHz (with 1 kHz tone @ \pm 3.5 kHz deviation).
- Connect the SINAD meter to the MIC/SP jack
- Rotate the DIAL knob one click counter-clockwise to select the alignment item "TUN".
- Press the [**V/M**] key.
- Rotate the DIAL knob for minimum deflection of the SINAD meter.
- Press the [**V/M**] key again.

Squelch Threshold Adjustment

- Connect the RF Signal Generator to the ANT jack, and then set the output level to -12 dB μ V at the 435.100 MHz (with 1 kHz tone @ \pm 3.5 kHz deviation).
- Rotate the DIAL knob three clicks clockwise to select the alignment item "THL".
- Press the [**V/M**] key.
- Press the [**FW**] key twice, and then press the [**V/M**] key again.

Squelch Tight Adjustment

- Connect the RF Signal Generator to the ANT jack, and then set the output level to -5 dB μ V at the 435.100 MHz (with 1 kHz tone @ \pm 3.5 kHz deviation).
- Rotate the DIAL knob one click clockwise to select the alignment item "TIG".
- Press the [V/M] key.
- Press the [FW] key twice, and then press the [V/M] key again.

NFM S-Meter S-1 Adjustment

- Connect the RF Signal Generator to the ANT jack, and then set the output level to -7 dB μ V at the 435.100 MHz (with 1 kHz tone @ \pm 3.5 kHz deviation).
- Rotate the DIAL knob one click clockwise to select the alignment item "S1".
- Press the [V/M] key.
- Press the [FW] key twice, and then press the [V/M] key again.

NFM S-Meter Full Scale Adjustment

- Connect the RF Signal Generator to the ANT jack, and then set the output level to +20 dB μ V at the 435.100 MHz (with 1 kHz tone @ \pm 3.5 kHz deviation).
- Rotate the DIAL knob one click clockwise to select the alignment item "S9".
- Press the [V/M] key.
- Press the [FW] key twice, and then press the [V/M] key again.

WFM S-Meter S-1 Adjustment

- Connect the RF Signal Generator to the ANT jack, and then set the output level to 0 dB μ V at the 435.100 MHz (with 1 kHz tone @ \pm 20 kHz deviation).
- Rotate the DIAL knob one click clockwise to select the alignment item "S1".
- Press the [V/M] key.
- Press the [FW] key twice, and then press the [V/M] key again.

WFM S-Meter Full Scale Adjustment

- Connect the RF Signal Generator to the ANT jack, and then set the output level to +20 dB μ V at the 435.100 MHz (with 1 kHz tone @ \pm 20 kHz deviation).
- Rotate the DIAL knob one click clockwise to select the alignment item "S9".
- Press the [V/M] key.
- Press the [FW] key twice, and then press the [V/M] key again.

50 MHz band

Press the [BAND] button to switch the alignment band to 50 MHz Band.

Squelch Threshold Adjustment

- Connect the RF Signal Generator to the ANT jack, and then set the output level to -4 dB μ V at the 52.100 MHz (with 1 kHz tone @ \pm 3.5 kHz deviation).
- Rotate the DIAL knob one click clockwise to select the alignment item "THL".
- Press the [V/M] key.
- Press the [FW] key twice, and then press the [V/M] key again.

Squelch Tight Adjustment

- Connect the RF Signal Generator to the ANT jack, and then set the output level to +3 dB μ V at the 52.100 MHz (with 1 kHz tone @ \pm 3.5 kHz deviation).
- Rotate the DIAL knob one click clockwise to select the alignment item "TIG".
- Press the [V/M] key.
- Press the [FW] key twice, and then press the [V/M] key again.

NFM S-Meter S-1 Adjustment

- Connect the RF Signal Generator to the ANT jack, and then set the output level to 0 dB μ V at the 52.100 MHz (with 1 kHz tone @ \pm 3.5 kHz deviation).
- Rotate the DIAL knob one click clockwise to select the alignment item "S1".
- Press the [V/M] key.
- Press the [FW] key twice, and then press the [V/M] key again.

NFM S-Meter Full Scale Adjustment

- Connect the RF Signal Generator to the ANT jack, and then set the output level to +20 dB μ V at the 52.100 MHz (with 1 kHz tone @ \pm 3.5 kHz deviation).
- Rotate the DIAL knob one click clockwise to select the alignment item "S9".
- Press the [V/M] key.
- Press the [FW] key twice, and then press the [V/M] key again.

Alignment

WFM S-Meter S-1 Adjustment

- Connect the RF Signal Generator to the ANT jack, and then set the output level to +8 dB μ V at the 52.100 MHz (with 1 kHz tone @ \pm 20 kHz deviation).
- Rotate the DIAL knob one click clockwise to select the alignment item "S1".
- Press the [V/M] key.
- Press the [FW] key twice, and then press the [V/M] key again.

WFM S-Meter Full Scale Adjustment

- Connect the RF Signal Generator to the ANT jack, and then set the output level to +25 dB μ V at the 52.100 MHz (with 1 kHz tone @ \pm 20 kHz deviation).
- Rotate the DIAL knob one click clockwise to select the alignment item "S9".
- Press the [V/M] key.
- Press the [FW] key twice, and then press the [V/M] key again.

144 MHz Band

Press the [BAND] button to switch the alignment band to 144 MHz Band.

RX Tune Adjustment

- Connect the RF Signal Generator to the ANT jack, and then set the output level to -10 dB μ V at the 145.100 MHz (with 1 kHz tone @ \pm 3.5 kHz deviation).
- Connect the SINAD meter to the MIC/SP jack
- Rotate the DIAL knob clockwise until the alignment item "TUN" appears.
- Press the [V/M] key.
- Rotate the DIAL knob for minimum deflection of the SINAD meter.
- Press the [V/M] key again.

Squelch Threshold Adjustment

- Connect the RF Signal Generator to the ANT jack, and then set the output level to -12 dB μ V at the 145.100 MHz (with 1 kHz tone @ \pm 3.5 kHz deviation).
- Rotate the DIAL knob counter-clockwise until the alignment item "THL" appears
- Press the [V/M] key.
- Press the [FW] key twice, and then press the [V/M] key again.

Squelch Tight Adjustment

- Connect the RF Signal Generator to the ANT jack, and then set the output level to -5 dB μ V at the 145.100 MHz (with 1 kHz tone @ \pm 3.5 kHz deviation).

- Rotate the DIAL knob one click clockwise to select the alignment item "TIG".
- Press the [V/M] key.
- Press the [FW] key twice, and then press the [V/M] key again.

NFM S-Meter S-1 Adjustment

- Connect the RF Signal Generator to the ANT jack, and then set the output level to -7 dB μ V at the 145.100 MHz (with 1 kHz tone @ \pm 3.5 kHz deviation).
- Rotate the DIAL knob one click clockwise to select the alignment item "S1".
- Press the [V/M] key.
- Press the [FW] key twice, and then press the [V/M] key again.

NFM S-Meter Full Scale Adjustment

- Connect the RF Signal Generator to the ANT jack, and then set the output level to +20 dB μ V at the 145.100 MHz (with 1 kHz tone @ \pm 3.5 kHz deviation).
- Rotate the DIAL knob one click clockwise to select the alignment item "S9".
- Press the [V/M] key.
- Press the [FW] key twice, and then press the [V/M] key again.

WFM S-Meter S-1 Adjustment

- Connect the RF Signal Generator to the ANT jack, and then set the output level to 0 dB μ V at the 145.100 MHz (with 1 kHz tone @ \pm 20 kHz deviation).
- Rotate the DIAL knob one click clockwise to select the alignment item "S1".
- Press the [V/M] key.
- Press the [FW] key twice, and then press the [V/M] key again.

WFM S-Meter Full Scale Adjustment

- Connect the RF Signal Generator to the ANT jack, and then set the output level to +20 dB μ V at the 145.100 MHz (with 1 kHz tone @ \pm 20 kHz deviation).
- Rotate the DIAL knob one click clockwise to select the alignment item "S9".
- Press the [V/M] key.
- Press the [FW] key twice, and then press the [V/M] key again.

This completes the internal alignment routine for all bands. To save all settings and exit, press the [S.BNK] button.

MAIN Unit Circuit Diagram

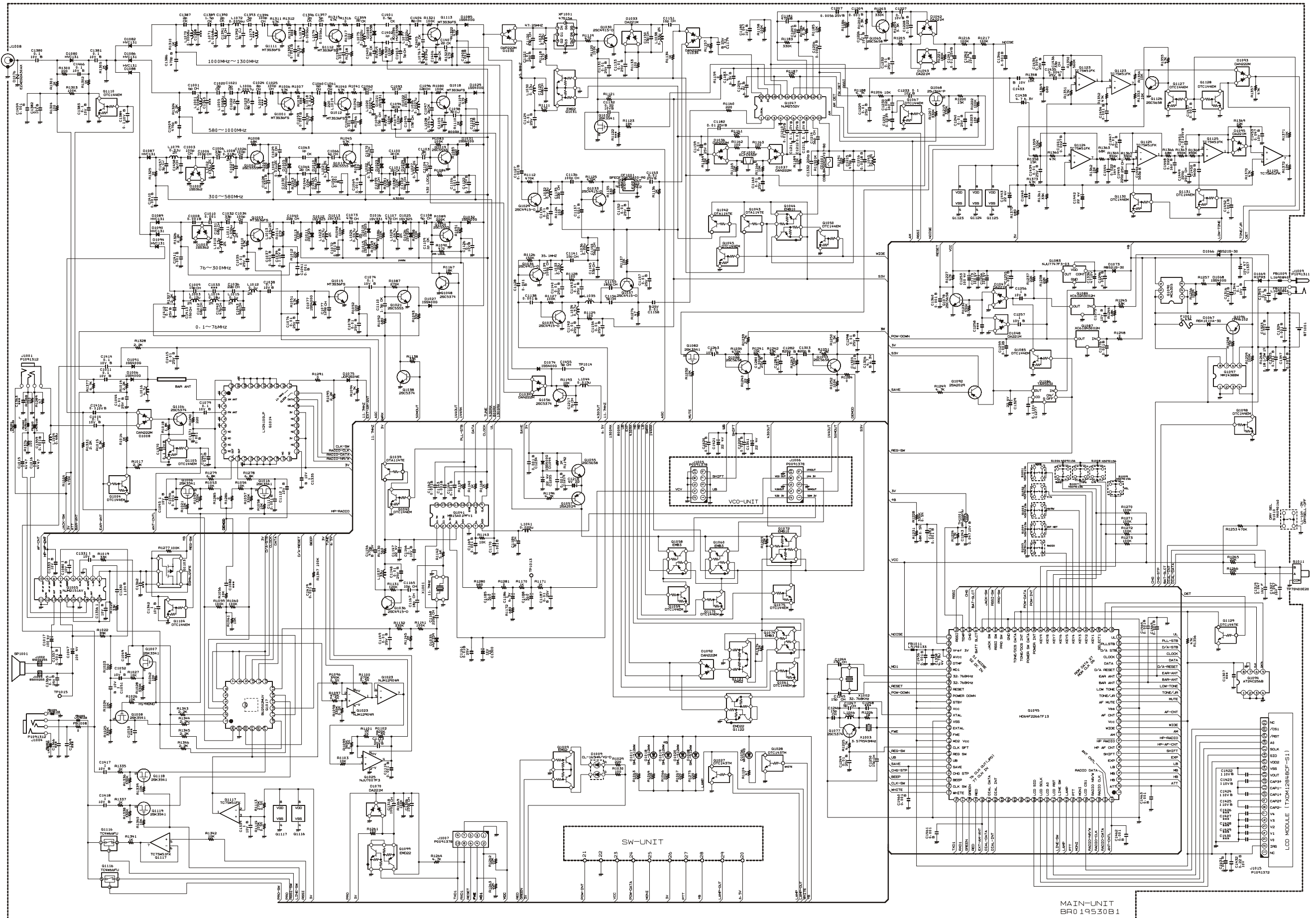

MAIN-UNIT
BR019530B1

MAIN Unit

Note

MAIN Unit

Parts Layout (Side A)

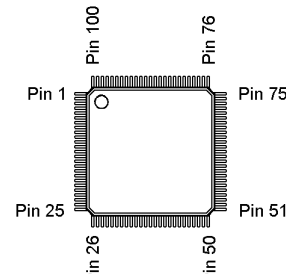
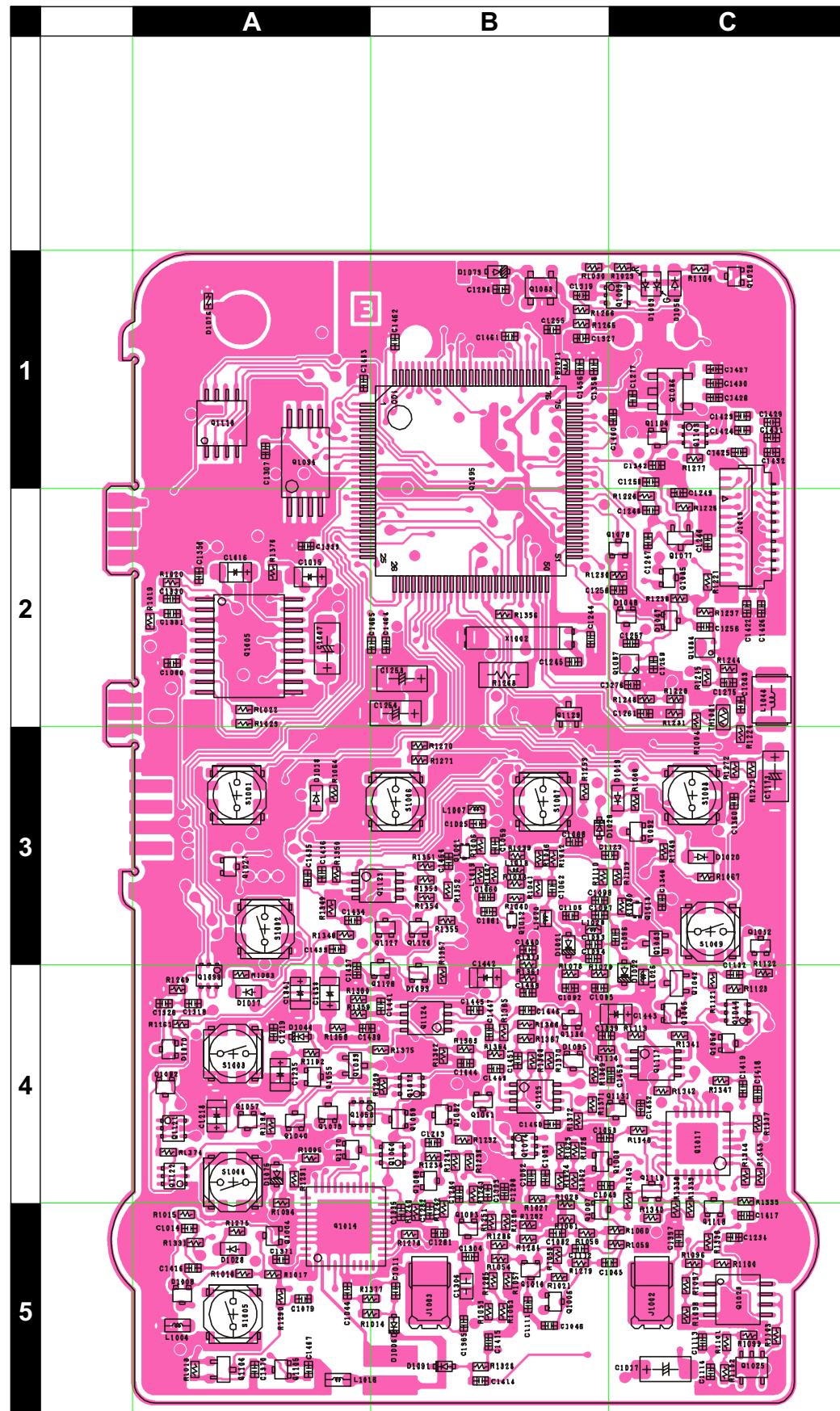

HD64F2266TF13V
(Q1095)

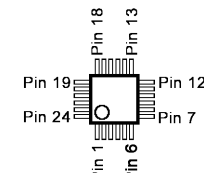

BU2502MUV
(Q1017)

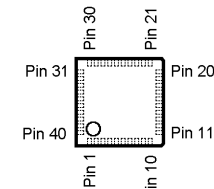

LV24100LP
(Q1014)

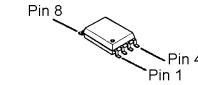

AT24C256
(Q1094)
NJM12904R
(Q1023)
TC4W66FU
(Q1116)
TC75W51FK
(Q1117, 1123, 1124, 1125)

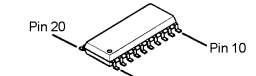

NJM2151AV
(Q1005)

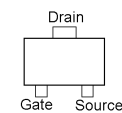

2SK3541
(Q1006, 1007, 1008, 1016, 1032, 1082, 1118, 1119)

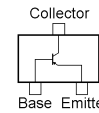

2SA2029 (F*)
(Q1057, 1092)

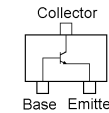

2SC5374 (NA)
(Q1077, 1106)
2SC5658 (B*)
(Q1055, 1078, 1088, 1093, 1126)

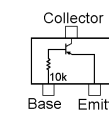

DTA114TE (94)
(Q1039, 1042, 1043)

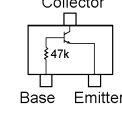

DTC144TE (96)
(Q1129)

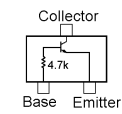

DTC143TM (03)
(Q1027, 1028)

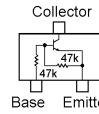

DTC144EM (26)
(Q1004, 1040, 1045, 1050, 1059, 1061, 1075, 1085, 1104, 1105, 1127, 1128, 1130, 1131, 1170)

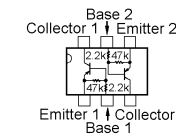

EMB10 (B10)
(Q1044, 1072)

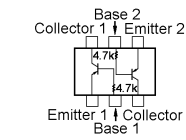

EMB3 (B3)
(Q1058, 1060, 1074)

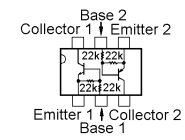

EMD2 (D2)
(Q1099, 1122)

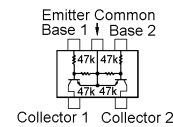

EMG2 (G2)
(Q1009, 1121)

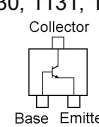

MT3S36FS (21)
(Q1001, 1012, 1018)

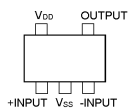

NJU7007F3 (B3)
(Q1025)

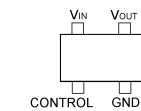

NJU7747F4
(Q1083)

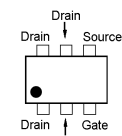

SSM6J25FE (PH)
(Q1103)

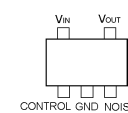

TAR5S30
(Q1086)

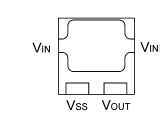

XC61GN3002HR
(Q1084, 1087)

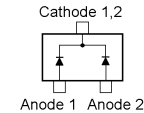

DAN222M (N)
(D1008, 1092, 1093)

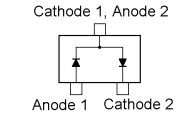

DA221M (K)
(D1047, 1048, 1070, 1095)

MAIN Unit

Parts Layout (Side B)

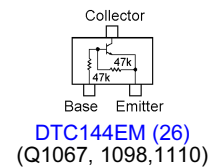
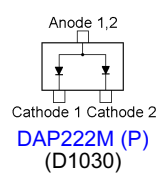
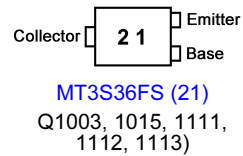
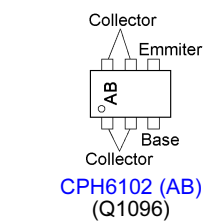
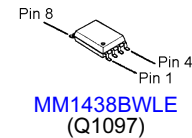
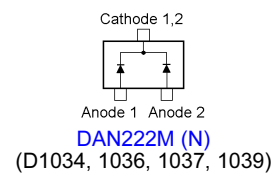
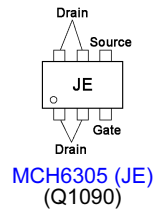
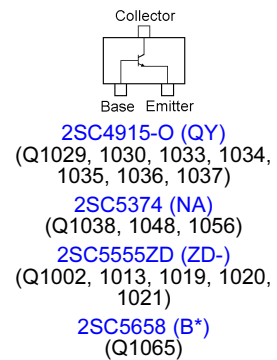
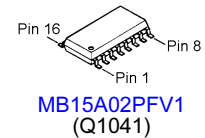
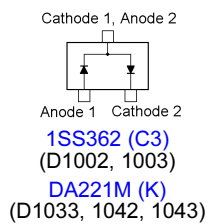
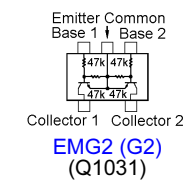
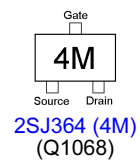
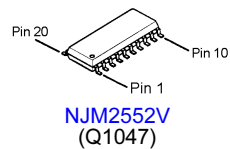
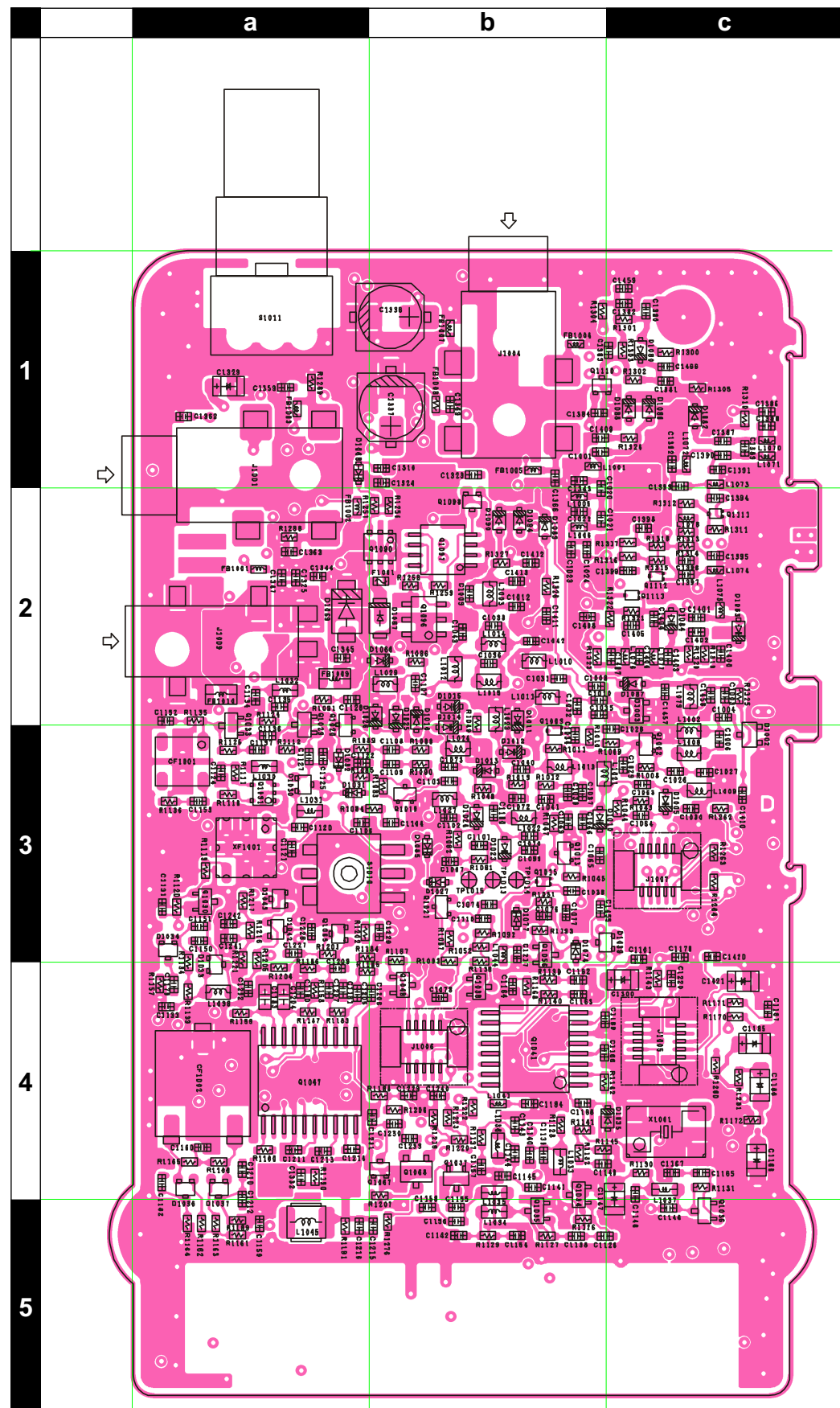

MAIN Unit

Parts List

REF	DESCRIPTION	VALUE	V/W	TOL.	MFR'S DESIG	VXSTD P/N	VERS.	LOT	SIDE	LAY ADR
P.C.B. with Components (W/ SW Unit, VCO Unit)						CS2051403	TYP B1			
						CS2051404	TYP B2			
	Printed Circuit Board					FR019530C		1-		
	Printed Circuit Board					FR019530D		5-		
C 1001	CHIP CAP.	6pF	50V	CH	UMK105CH060DV-F	K22178254		1-	B	b1
C 1003	CHIP CAP.	100pF	50V	CH	UMK105CH101JV-F	K22178282		1-	B	c2
C 1004	CHIP CAP.	100pF	50V	CH	UMK105CH101JV-F	K22178282		1-	B	c2
C 1006	CHIP CAP.	33pF	50V	CH	UMK105CH330JV-F	K22178270		1-	B	c3
C 1008	CHIP CAP.	0.001uF	50V	B	UMK105B102KW-F	K22178829		1-	B	b2
C 1009	CHIP CAP.	15pF	50V	CH	UMK105CH150JV-F	K22178262		1-	B	b2
C 1010	CHIP CAP.	0.001uF	50V	B	UMK105B102KW-F	K22178829		1-	B	b2
C 1011	CHIP CAP.	0.1uF	10V	B	GRM155B11A104KA01D	K22108802		1-	A	B5
C 1012	CHIP CAP.	68pF	50V	CH	UMK105CH680JV-F	K22178278		1-	B	b2
C 1014	CHIP CAP.	0.1uF	10V	B	GRM155B11A104KA01D	K22108802		1-	A	A5
C 1015	CHIP TA.CAP.	47uF	4V		TEESVP0G476M8R	K78060050		1-	A	A2
C 1016	CHIP TA.CAP.	47uF	4V		TEESVP0G476M8R	K78060050		1-	A	A2
C 1017	CHIP TA.CAP.	100uF	4V		TEESVA0G107M8R	K78060051		1-	A	C5
C 1020	CHIP CAP.	2pF	50V	CK	GRM1554C1H2R0CZ01D	K22178204		1-	B	b2
C 1021	CHIP CAP.	5pF	50V	CH	UMK105CH050CV-F	K22178253		1-	B	b2
C 1022	CHIP CAP.	8pF	50V	CH	UMK105CH080DV-F	K22178256		1-	B	b2
C 1023	CHIP CAP.	8pF	50V	CH	UMK105CH080DV-F	K22178256		1-	B	b2
C 1024	CHIP CAP.	8pF	50V	CH	UMK105CH080DV-F	K22178256		1-	B	b2
C 1025	CHIP CAP.	100pF	50V	CH	UMK105CH101JV-F	K22178282		1-	A	B3
C 1026	CHIP CAP.	100pF	50V	CH	UMK105CH101JV-F	K22178282		1-	B	c3
C 1028	CHIP CAP.	0.001uF	50V	B	UMK105B102KW-F	K22178829		1-	B	c3
C 1029	CHIP CAP.	4pF	50V	CH	UMK105CH040CV-F	K22178252		1-	B	c3
C 1030	CHIP CAP.	220pF	50V	CH	GRM1552C1H221JA01D	K22179713		1-	B	c3
C 1031	CHIP CAP.	68pF	50V	CH	UMK105CH680JV-F	K22178278		1-	B	b2
C 1032	CHIP CAP.	33pF	50V	CH	UMK105CH330JV-F	K22178270		1-	B	b2
C 1034	CHIP CAP.	100pF	50V	CH	UMK105CH101JV-F	K22178282		1-	B	b3
C 1035	CHIP CAP.	0.01uF	25V	B	GRM155B11E103KA01D	K22148834		1-	B	b2
C 1036	CHIP CAP.	22pF	50V	CH	UMK105CH220JV-F	K22178266		1-	B	b2
C 1037	CHIP CAP.	0.001uF	50V	B	UMK105B102KW-F	K22178829		1-	B	b3
C 1038	CHIP CAP.	0.1uF	10V	B	GRM155B11A104KA01D	K22108802		1-	B	b3
C 1039	CHIP CAP.	0.1uF	10V	B	GRM155B11A104KA01D	K22108802		1-	B	b3
C 1040	CHIP CAP.	22pF	50V	CH	UMK105CH220JV-F	K22178266		1-	B	b3
C 1041	CHIP CAP.	0.001uF	50V	B	UMK105B102KW-F	K22178829		1-	B	b3
C 1042	CHIP CAP.	47pF	50V	CH	UMK105CH470JV-F	K22178274		1-	B	b2
C 1043	CHIP CAP.	56pF	50V	CH	UMK105CH560JV-F	K22178276		1-	B	b2
C 1044	CHIP CAP.	0.01uF	25V	B	GRM155B11E103KA01D	K22148834		1-	A	A5
C 1045	CHIP CAP.	1uF	10V	B	GRM155B31A105KE15D	K22108809		1-	A	B5
C 1046	CHIP CAP.	0.001uF	50V	B	UMK105B102KW-F	K22178829		1-	A	B5
C 1047	CHIP TA.CAP.	100uF	4V		TEESVA0G107M8R	K78060051		1-	A	A2
C 1051	CHIP CAP.	1uF	10V	B	GRM155B31A105KE15D	K22108809		1-	A	B4
C 1052	CHIP CAP.	1uF	10V	B	GRM155B31A105KE15D	K22108809		1-	A	B4
C 1059	CHIP CAP.	0.001uF	50V	B	GRM155B11H102KA01D	K22178809		1-	A	B3
C 1060	CHIP CAP.	6pF	50V	CH	UMK105CH060DV-F	K22178254		1-	A	B3
C 1061	CHIP CAP.	8pF	50V	CH	GRM1552C1H8R0DZ01D	K22178210		1-	A	B3
C 1062	CHIP CAP.	3pF	50V	CJ	UMK105CJ030CV-F	K22178251		1-	A	B3
C 1063	CHIP CAP.	1pF	50V	CK	UMK105CK010CV-F	K22178248		1-	B	c3
C 1064	CHIP CAP.	2pF	50V	CK	UMK105CK020CV-F	K22178250		1-	B	c3
C 1065	CHIP CAP.	56pF	50V	CH	UMK105CH560JV-F	K22178276		1-	B	b3
C 1066	CHIP CAP.	4pF	50V	CH	UMK105CH040CV-F	K22178252		1-	B	b3
C 1067	CHIP CAP.	0.001uF	50V	B	UMK105B102KW-F	K22178829		1-	B	b3
C 1068	CHIP CAP.	0.001uF	50V	B	GRM155B11H102KA01D	K22178809		1-	A	B3
C 1069	CHIP CAP.	0.001uF	50V	B	UMK105B102KW-F	K22178829		1-	B	b3
C 1070	CHIP CAP.	4pF	50V	CH	UMK105CH040CV-F	K22178252		1-	B	b3
C 1072	CHIP CAP.	0.001uF	50V	B	UMK105B102KW-F	K22178829		1-	B	b3
C 1073	CHIP CAP.	47pF	50V	CH	UMK105CH470JV-F	K22178274		1-	B	b3
C 1074	CHIP CAP.	0.1uF	10V	B	GRM155B11A104KA01D	K22108802		1-	B	b3
C 1076	CHIP CAP.	0.01uF	25V	B	GRM155B11E103KA01D	K22148834		1-	B	b3
C 1077	CHIP CAP.	100pF	50V	CH	UMK105CH101JV-F	K22178282		1-	B	b3
C 1077	CHIP CAP.	120pF	50V	CH	UMK105CH121JV-F	K22178284		3-	B	b3
C 1078	CHIP CAP.	0.01uF	25V	B	GRM155B11E103KA01D	K22148834		1-	B	b4
C 1079	CHIP CAP.	0.1uF	10V	B	GRM155B11A104KA01D	K22108802		1-	A	A5
C 1080	CHIP CAP.	1uF	10V	B	GRM155B31A105KE15D	K22108809		1-	A	A2
C 1092	CHIP CAP.	15pF	50V	CH	UMK105CH150JV-F	K22178262		1-	A	B4
C 1093	CHIP CAP.	1pF	50V	CK	UMK105CK010CV-F	K22178248		1-	A	B3
C 1094	CHIP CAP.	2pF	50V	CK	GRM1554C1H2R0CZ01D	K22178204		1-	A	B3
C 1095	CHIP CAP.	15pF	50V	CH	UMK105CH150JV-F	K22178262		1-	A	B4
C 1096	CHIP CAP.	12pF	50V	CH	GRM1552C1H120JZ01D	K22178214		1-	A	C3
C 1097	CHIP CAP.	2pF	50V	CK	GRM1554C1H2R0CZ01D	K22178204		1-	A	B3
C 1098	CHIP CAP.	3pF	50V	CJ	UMK105CJ030CV-F	K22178251		1-	A	B3

MAIN Unit

Parts List

REF	DESCRIPTION	VALUE	V/W	TOL.	MFR'S DESIG	VXSTD P/N	VERS.	LOT	SIDE	LAY ADR
C 1099	CHIP CAP.	56pF	50V	CH	UMK105CH560JV-F	K22178276		1-	B	b3
C 1100	CHIP CAP.	1pF	50V	CK	UMK105CK010CV-F	K22178248		1-	B	b3
C 1101	CHIP CAP.	2pF	50V	CK	UMK105CK020CV-F	K22178250		1-	B	b3
C 1102	CHIP CAP.	56pF	50V	CH	UMK105CH560JV-F	K22178276		1-	B	b3
C 1103	CHIP CAP.	3pF	50V	CJ	UMK105CJ030CV-F	K22178251		1-	B	b3
C 1104	CHIP CAP.	3pF	50V	CJ	UMK105CJ030CV-F	K22178251		1-	B	b3
C 1105	CHIP CAP.	5pF	50V	CH	UMK105CH050CV-F	K22178253		1-	A	B3
C 1106	CHIP CAP.	0.001uF	50V	B	UMK105B102KW-F	K22178829		1-	B	a3
C 1107	CHIP CAP.	47pF	50V	CH	UMK105CH470JV-F	K22178274		1-	B	b2
C 1108	CHIP CAP.	9pF	50V	CH	UMK105CH090DV-F	K22178257		1-	B	b3
C 1109	CHIP CAP.	1pF	50V	CK	GRM1554C1H1R0BZ01D	K22178287		1-	B	b3
C 1110	CHIP CAP.	1.5pF	50V	CK	GRM1554C1H1R5BZ01D	K22178288		1-	B	b3
C 1111	CHIP CAP.	0.001uF	50V	B	UMK105B102KW-F	K22178829		1-	A	B5
C 1112	CHIP CAP.	1uF	10V	B	GRM155B31A105KE15D	K22108809		1-	A	B5
C 1113	CHIP CAP.	0.01uF	25V	B	GRM155B11E103KA01D	K22148834		1-	A	C5
C 1114	CHIP CAP.	0.001uF	50V	B	UMK105B102KW-F	K22178829		1-	A	C5
C 1120	CHIP CAP.	33pF	50V	CH	UMK105CH330JV-F	K22178270		1-	B	a3
C 1121	CHIP CAP.	0.01uF	25V	B	GRM155B11E103KA01D	K22148834		1-	B	a3
C 1122	CHIP CAP.	0.1uF	10V	B	GRM155B11A104KA01D	K22108802		1-	B	a3
C 1123	CHIP CAP.	0.001uF	50V	B	GRM155B11H102KA01D	K22178809		1-	A	B3
C 1124	CHIP CAP.	0.01uF	25V	B	GRM155B11E103KA01D	K22148834		1-	B	a3
C 1125	CHIP CAP.	68pF	50V	CH	UMK105CH680JV-F	K22178278		1-	B	a3
C 1126	CHIP CAP.	0.1uF	10V	B	GRM155B11A104KA01D	K22108802		1-	B	a2
C 1127	CHIP CAP.	0.001uF	50V	B	UMK105B102KW-F	K22178829		1-	B	a3
C 1128	CHIP CAP.	0.001uF	50V	B	UMK105B102KW-F	K22178829		1-	B	b5
C 1131	CHIP CAP.	0.01uF	25V	B	GRM155B11E103KA01D	K22148834		1-	B	a3
C 1132	CHIP CAP.	0.22uF	10V	B	GRM155B31A224KE18D	K22108808		1-	A	C4
C 1133	CHIP CAP.	0.01uF	25V	B	GRM155B11E103KA01D	K22148834		1-	B	a4
C 1134	CHIP CAP.	0.01uF	25V	B	GRM155B11E103KA01D	K22148834		1-	B	a2
C 1135	CHIP CAP.	22pF	50V	CH	UMK105CH220JV-F	K22178266		1-	B	a2
C 1136	CHIP CAP.	100pF	50V	CH	UMK105CH101JV-F	K22178282		1-	B	a3
C 1137	CHIP CAP.	0.001uF	50V	B	UMK105B102KW-F	K22178829		1-	B	a3
C 1138	CHIP CAP.	0.001uF	50V	B	UMK105B102KW-F	K22178829		1-	B	b5
C 1139	CHIP CAP.	100pF	50V	CH	UMK105CH101JV-F	K22178282		1-	B	b4
C 1140	CHIP CAP.	0.01uF	25V	B	GRM155B11E103KA01D	K22148834		1-	B	b4
C 1141	CHIP CAP.	10pF	50V	CH	UMK105CH100DV-F	K22178258		1-	B	b4
C 1142	CHIP CAP.	0.01uF	25V	B	GRM155B11E103KA01D	K22148834		1-	B	b5
C 1143	CHIP CAP.	0.01uF	25V	B	GRM155B11E103KA01D	K22148834		1-	B	b4
C 1144	CHIP CAP.	56pF	50V	CH	UMK105CH560JV-F	K22178276		1-	B	b4
C 1145	CHIP CAP.	33pF	50V	CH	UMK105CH330JV-F	K22178270		1-	B	b4
C 1146	CHIP CAP.	470pF	25V	B	TMK105B471K-F	K22148816		1-	B	c5
C 1147	CHIP TA.CAP.	22uF	4V		TEESVPOG226M8R	K78060047		1-	B	c4
C 1148	CHIP CAP.	0.01uF	25V	B	GRM155B11E103KA01D	K22148834		1-	B	c4
C 1149	CHIP CAP.	0.01uF	25V	B	GRM155B11E103KA01D	K22148834		1-	B	b4
C 1150	CHIP CAP.	15pF	50V	CH	UMK105CH150JV-F	K22178262		1-	B	a3
C 1151	CHIP CAP.	10pF	50V	CH	UMK105CH100DV-F	K22178258		1-	B	a3
C 1152	CHIP CAP.	0.01uF	25V	B	GRM155B11E103KA01D	K22148834		1-	B	a2
C 1153	CHIP CAP.	0.01uF	25V	B	GRM155B11E103KA01D	K22148834		1-	B	a3
C 1154	CHIP CAP.	0.01uF	25V	B	GRM155B11E103KA01D	K22148834		1-	B	b5
C 1155	CHIP CAP.	180pF	50V	CH	GRM1552C1H181JA01D	K22179711		1-	B	b5
C 1156	CHIP CAP.	5pF	50V	CH	UMK105CH050CV-F	K22178253		1-	B	b5
C 1157	CHIP CAP.	0.01uF	25V	B	GRM155B11E103KA01D	K22148834		1-	B	b4
C 1158	CHIP CAP.	0.01uF	25V	B	GRM155B11E103KA01D	K22148834		1-	B	b5
C 1159	CHIP CAP.	0.01uF	25V	B	GRM155B11E103KA01D	K22148834		1-	B	a5
C 1160	CHIP CAP.	0.01uF	25V	B	GRM155B11E103KA01D	K22148834		1-	B	a4
C 1161	CHIP CAP.	0.01uF	25V	B	GRM155B11E103KA01D	K22148834		1-	B	c3
C 1162	CHIP CAP.	0.001uF	50V	B	UMK105B102KW-F	K22178829		1-	B	b4
C 1163	CHIP CAP.	0.001uF	50V	B	UMK105B102KW-F	K22178829		1-	B	b4
C 1164	CHIP CAP.	0.001uF	50V	B	UMK105B102KW-F	K22178829		1-	B	b4
C 1165	CHIP CAP.	10pF	50V	CH	UMK105CH100DV-F	K22178258		1-	B	c4
C 1166	CHIP CAP.	0.1uF	10V	B	GRM155B11A104KA01D	K22108802		1-	B	b4
C 1167	CHIP CAP.	18pF	50V	CH	UMK105CH180JV-F	K22178264		1-	B	c4
C 1168	CHIP CAP.	220pF	50V	CH	GRM1552C1H221JA01D	K22179713		1-	B	b4
C 1169	CHIP CAP.	0.001uF	50V	B	UMK105B102KW-F	K22178829		1-	B	b4
C 1170	CHIP CAP.	0.001uF	50V	B	UMK105B102KW-F	K22178829		1-	B	c3
C 1173	CHIP TA.CAP.	100uF	4V		TEESVA0G107M8R	K78060051		1-	A	C3
C 1179	CHIP CAP.	0.01uF	25V	B	GRM155B11E103KA01D	K22148834		1-	B	a4
C 1180	CHIP CAP.	0.047uF	10V	B	GRM155B11A473KA01D	K22108801		1-	B	a4
C 1181	CHIP CAP.	470pF	50V	B	UMK105B471KW-F	K22178825		1-	B	a4
C 1182	CHIP CAP.	0.01uF	25V	B	GRM155B11E103KA01D	K22148834		1-	B	a4
C 1183	CHIP CAP.	4.7uF	6.3V	B	JMK107BJ475MA-T	K22084803		1-	B	a4
C 1184	CHIP CAP.	7pF	50V	CH	UMK105CH070DV-F	K22178255		1-	B	b4
C 1185	CHIP TA.CAP.	0.1uF	20V		SKF-1D104M-RP	K78130049		1-	B	c4

MAIN Unit

Parts List

REF	DESCRIPTION	VALUE	V/W	TOL.	MFR'S DESIG	VXSTD P/N	VERS.	LOT	SIDE	LAY ADR
C 1186	CHIP TA.CAP.	1uF	6.3V		TEESVP0J105M8R	K78080028		1-	B	c4
C 1187	CHIP CAP.	0.01uF	25V	B	GRM155B11E103KA01D	K22148834		1-	B	c4
C 1188	CHIP TA.CAP.	0.1uF	20V		SKF-1D104M-RP	K78130049		1-	B	c4
C 1204	CHIP CAP.	4.7uF	6.3V	B	JMK107BJ475MA-T	K22084803		1-	B	a4
C 1205	CHIP CAP.	470pF	50V	B	UMK105B471KW-F	K22178825		1-	B	a4
C 1206	CHIP CAP.	0.0047uF	50V	B	GRM155B11H472KA01D	K22178838		1-	B	b4
C 1207	CHIP CAP.	0.0056uF	25V	B	GRM155B11E562KA01D	K22148802		1-	B	a4
C 1209	CHIP CAP.	0.001uF	50V	B	UMK105B102KW-F	K22178829		1-	B	a4
C 1210	CHIP CAP.	0.01uF	25V	B	GRM155B11E103KA01D	K22148834		1-	B	a4
C 1211	CHIP CAP.	0.1uF	10V	B	GRM155B11A104KA01D	K22108802		1-	B	a4
C 1212	CHIP CAP.	0.01uF	25V	B	GRM155B11E103KA01D	K22148834		1-	B	a4
C 1213	CHIP CAP.	0.1uF	10V	B	GRM155B11A104KA01D	K22108802		1-	B	a4
C 1214	CHIP CAP.	56pF	50V	CH	UMK105CH560JV-F	K22178276		1-	B	a4
C 1215	CHIP CAP.	470pF	50V	B	UMK105B471KW-F	K22178825		1-	B	b5
C 1216	CHIP CAP.	0.0018uF	50V	B	UMK105B182KW-F	K22178832		1-	B	a5
C 1217	CHIP CAP.	7pF	50V	CH	UMK105CH070DV-F	K22178255		1-	B	b3
C 1218	CHIP TA.CAP.	22uF	4V		TEESVP0G226M8R	K78060047		1-	A	A4
C 1219	CHIP CAP.	0.001uF	50V	B	UMK105B102KW-F	K22178829		1-	A	A4
C 1220	CHIP CAP.	0.001uF	50V	B	UMK105B102KW-F	K22178829		1-	B	c4
C 1226	CHIP CAP.	0.1uF	10V	B	GRM155B11A104KA01D	K22108802		1-	B	b3
C 1227	CHIP CAP.	0.1uF	10V	B	GRM155B11A104KA01D	K22108802		1-	B	a3
C 1228	CHIP CAP.	0.0022uF	50V	B	UMK105B222KW-F	K22178833		1-	B	a3
C 1229	CHIP CAP.	0.01uF	25V	B	GRM155B11E103KA01D	K22148834		1-	B	b4
C 1230	CHIP CAP.	0.022uF	16V	B	EMK105B223KW-F	K22128813		1-	B	b4
C 1231	CHIP CAP.	0.0039uF	50V	B	UMK105B392KW-F	K22178836		1-	B	b4
C 1232	CHIP CAP.	0.01uF	25V	B	GRM155B11E103KA01D	K22148834		1-	B	a4
C 1233	CHIP CAP.	0.1uF	10V	B	GRM155B11A104KA01D	K22108802		1-	B	b4
C 1234	CHIP CAP.	0.001uF	50V	B	UMK105B102KW-F	K22178829		1-	A	C5
C 1235	CHIP TA.CAP.	22uF	4V		TEESVP0G226M8R	K78060047		1-	A	A4
C 1240	CHIP CAP.	0.01uF	25V	B	GRM155B11E103KA01D	K22148834		1-	B	b4
C 1241	CHIP CAP.	0.01uF	25V	B	GRM155B11E103KA01D	K22148834		1-	B	a3
C 1242	CHIP CAP.	0.047uF	10V	B	GRM155B11A473KA01D	K22108801		1-	B	a3
C 1243	CHIP CAP.	0.047uF	10V	B	GRM155B11A473KA01D	K22108801		1-	A	C2
C 1244	CHIP CAP.	15pF	50V	CH	GRM1552C1H150JZ01D	K22178216		1-	A	B2
C 1245	CHIP CAP.	15pF	50V	CH	GRM1552C1H150JZ01D	K22178216		1-	A	B2
C 1246	CHIP CAP.	15pF	50V	CH	GRM1552C1H150JZ01D	K22178216		1-	A	C2
C 1247	CHIP CAP.	5pF	50V	CH	UMK105CH050CV-F	K22178253		1-	A	C2
C 1249	CHIP CAP.	0.01uF	25V	B	GRM155B11E103KA01D	K22148834		1-	A	C2
C 1250	CHIP CAP.	15pF	50V	CH	GRM1552C1H150JZ01D	K22178216		1-	A	C1
C 1250	CHIP CAP.	10pF	50V	CH	GRM1552C1H100JZ01D	K22178212		5-	A	C1
C 1253	CHIP TA.CAP.	100uF	4V		TEESVA0G107M8R	K78060051		1-	A	B2
C 1254	CHIP TA.CAP.	100uF	4V		TEESVA0G107M8R	K78060051		1-	A	B2
C 1255	CHIP CAP.	0.001uF	50V	B	UMK105B102KW-F	K22178829		1-	A	B1
C 1256	CHIP CAP.	1uF	10V	B	GRM155B31A105KE15D	K22108809		1-	A	C2
C 1257	CHIP CAP.	1uF	10V	B	GRM155B31A105KE15D	K22108809		1-	A	C2
C 1259	CHIP CAP.	0.001uF	50V	B	UMK105B102KW-F	K22178829		1-	A	C2
C 1261	CHIP CAP.	0.001uF	50V	B	UMK105B102KW-F	K22178829		1-	A	C2
C 1263	CHIP CAP.	0.1uF	10V	B	GRM155B11A104KA01D	K22108802		1-	A	B4
C 1275	CHIP CAP.	1uF	10V	B	GRM155B31A105KE15D	K22108809		1-	A	C2
C 1276	CHIP CAP.	0.001uF	50V	B	UMK105B102KW-F	K22178829		1-	A	C2
C 1277	CHIP CAP.	0.1uF	10V	B	GRM155B11A104KA01D	K22108802		1-	A	C1
C 1280	CHIP CAP.	0.0068uF	25V	B	GRM155B11E682KA01D	K22148803		1-	A	B4
C 1281	CHIP CAP.	0.001uF	50V	B	UMK105B102KW-F	K22178829		1-	A	B5
C 1282	CHIP CAP.	820pF	50V	B	GRM155B11H821KA01D	K22178808		1-	A	B5
C 1296	CHIP CAP.	0.001uF	50V	B	UMK105B102KW-F	K22178829		1-	A	B1
C 1298	CHIP CAP.	0.01uF	25V	B	GRM155B11E103KA01D	K22148834		1-	A	B4
C 1300	CHIP TA.CAP.	10uF	10V		TEESVP1A106M8R	K78100074		1-	B	c4
C 1303	CHIP CAP.	820pF	50V	B	GRM155B11H821KA01D	K22178808		1-	A	B4
C 1304	CHIP CAP.	0.001uF	50V	B	UMK105B102KW-F	K22178829		1-	A	B5
C 1306	CHIP CAP.	4.7uF	6.3V	B	JMK107BJ475MA-T	K22084803		1-	A	B5
C 1316	CHIP CAP.	0.001uF	50V	B	UMK105B102KW-F	K22178829		1-	B	b1
C 1318	CHIP CAP.	100pF	50V	CH	GRM1552C1H101JD01D	K22178236		1-	A	A4
C 1319	CHIP CAP.	0.047uF	16V	F	GRM155F11C473ZA01D	K22129004		1-	A	B1
C 1323	CHIP CAP.	0.001uF	50V	B	UMK105B102KW-F	K22178829		1-	B	b1
C 1324	CHIP CAP.	0.001uF	50V	B	UMK105B102KW-F	K22178829		1-	B	b1
C 1325	CHIP CAP.	0.001uF	50V	B	UMK105B102KW-F	K22178829		1-	B	a2
C 1326	CHIP CAP.	100pF	50V	CH	GRM1552C1H101JD01D	K22178236		1-	A	A4
C 1327	CHIP CAP.	0.047uF	16V	F	GRM155F11C473ZA01D	K22129004		1-	A	B1
C 1329	CHIP TA.CAP.	22uF	4V		TEESVP0G226M8R	K78060047		1-	B	a1
C 1330	CHIP CAP.	1uF	10V	B	GRM155B31A105KE15D	K22108809		1-	A	A2
C 1331	CHIP CAP.	1uF	10V	B	GRM155B31A105KE15D	K22108809		1-	A	A2
C 1332	CHIP CAP.	220pF	50V	B	UMK105B221KW-F	K22178821		1-	B	a4
C 1333	CHIP CAP.	1uF	10V	B	GRM155B31A105KE15D	K22108809		1-	A	A2

MAIN Unit

Parts List

REF	DESCRIPTION	VALUE	V/W	TOL.	MFR'S DESIG	VXSTD P/N	VERS.	LOT	SIDE	LAY ADR
C 1335	CHIP CAP.	1uF	10V	B	GRM155B31A105KE15D	K22108809		1-	A	B5
C 1336	AL.ELECTRO.CAP.	47uF	10V		RV5-10V470M	K48100011		1-	B	b1
C 1337	AL.ELECTRO.CAP.	47uF	10V		RV5-10V470M	K48100011		1-	B	b1
C 1339	CHIP CAP.	1uF	10V	B	GRM155B31A105KE15D	K22108809		1-	A	B4
C 1341	CHIP TA.CAP.	22uF	4V		TEESVP0G226M8R	K78060047		1-	A	A4
C 1342	CHIP CAP.	1uF	10V	B	GRM155B31A105KE15D	K22108809		1-	A	C1
C 1344	CHIP CAP.	0.1uF	10V	B	GRM155B11A104KA01D	K22108802		1-	B	a2
C 1345	CHIP CAP.	0.1uF	10V	B	GRM155B11A104KA01D	K22108802		1-	B	a2
C 1346	CHIP CAP.	0.001uF	50V	B	UMK105B102KW-F	K22178829		1-	A	C3
C 1347	CHIP CAP.	0.001uF	50V	B	UMK105B102KW-F	K22178829		1-	B	a2
C 1356	CHIP CAP.	1uF	10V	B	GRM155B31A105KE15D	K22108809		1-	A	A2
C 1357	CHIP CAP.	0.001uF	50V	B	UMK105B102KW-F	K22178829		1-	A	C5
C 1358	CHIP CAP.	4.7uF	4V	BJ	AMK105BJ475MV-F	K22068801		1-	A	B1
C 1359	CHIP CAP.	0.001uF	50V	B	UMK105B102KW-F	K22178829		1-	B	a1
C 1360	CHIP CAP.	0.001uF	50V	B	UMK105B102KW-F	K22178829		1-	A	C3
C 1365	CHIP CAP.	0.01uF	25V	B	GRM155B11E103KA01D	K22148834		3-	A	B5
C 1370	CHIP CAP.	0.1uF	10V	B	GRM155B11A104KA01D	K22108802		1-	A	A5
C 1371	CHIP CAP.	0.001uF	50V	B	UMK105B102KW-F	K22178829		1-	A	A5
C 1380	CHIP CAP.	0.1uF	10V	B	GRM155B11A104KA01D	K22108802		1-	B	c1
C 1381	CHIP CAP.	0.1uF	10V	B	GRM155B11A104KA01D	K22108802		1-	B	c1
C 1382	CHIP CAP.	0.1uF	10V	B	GRM155B11A104KA01D	K22108802		1-	B	c1
C 1383	CHIP CAP.	0.1uF	10V	B	GRM155B11A104KA01D	K22108802		1-	B	c1
C 1384	CHIP CAP.	0.1uF	10V	B	GRM155B11A104KA01D	K22108802		1-	B	b1
C 1386	CHIP CAP.	470pF	50V	B	GRM155B11H471KA01D	K22178805		1-	B	c1
C 1387	CHIP CAP.	2pF	50V	CK	UMK105CK020CV-F	K22178250		1-	B	c1
C 1389	CHIP CAP.	1.5pF	50V	CK	UMK105CK1R5CV-F	K22178249		1-	B	c1
C 1390	CHIP CAP.	2pF	50V	CK	UMK105CK020CV-F	K22178250		1-	B	c1
C 1391	CHIP CAP.	6pF	50V	CH	UMK105CH060DV-F	K22178254		1-	B	c1
C 1392	CHIP CAP.	3pF	50V	CJ	UMK105CJ030CV-F	K22178251		1-	B	c1
C 1393	CHIP CAP.	5pF	50V	CH	UMK105CH050CV-F	K22178253		1-	B	c1
C 1394	CHIP CAP.	100pF	50V	CH	UMK105CH101JV-F	K22178282		1-	B	c2
C 1395	CHIP CAP.	0.001uF	50V	B	GRM155B11H102KA01D	K22178809		1-	B	c2
C 1396	CHIP CAP.	2pF	50V	CK	UMK105CK020CV-F	K22178250		1-	B	c2
C 1397	CHIP CAP.	5pF	50V	CH	UMK105CH050CV-F	K22178253		1-	B	c2
C 1398	CHIP CAP.	0.001uF	50V	B	GRM155B11H102KA01D	K22178809		1-	B	c2
C 1399	CHIP CAP.	2pF	50V	CK	UMK105CK020CV-F	K22178250		1-	B	c2
C 1400	CHIP CAP.	2pF	50V	CK	UMK105CK020CV-F	K22178250		1-	B	c2
C 1401	CHIP CAP.	0.5pF	50V	CK	UMK105CK0R5CV-F	K22178247		1-	B	c2
C 1402	CHIP CAP.	1pF	50V	CK	UMK105CK010CV-F	K22178248		1-	B	c2
C 1403	CHIP CAP.	5pF	50V	CH	UMK105CH050CV-F	K22178253		1-	B	c2
C 1404	CHIP CAP.	8pF	50V	CH	UMK105CH080DV-F	K22178256		1-	B	c2
C 1405	CHIP CAP.	1.5pF	50V	CK	UMK105CK1R5CV-F	K22178249		1-	B	c2
C 1406	CHIP CAP.	2pF	50V	CK	UMK105CK020CV-F	K22178250		1-	B	c2
C 1407	CHIP CAP.	2pF	50V	CK	UMK105CK020CV-F	K22178250		1-	B	c2
C 1408	CHIP CAP.	0.001uF	50V	B	GRM155B11H102KA01D	K22178809		1-	B	b2
C 1409	CHIP CAP.	470pF	50V	B	GRM155B11H471KA01D	K22178805		1-	B	b1
C 1410	CHIP CAP.	0.001uF	50V	B	GRM155B11H102KA01D	K22178809		1-	B	c3
C 1411	CHIP CAP.	0.001uF	50V	B	GRM155B11H102KA01D	K22178809		1-	B	b2
C 1412	CHIP CAP.	0.001uF	50V	B	GRM155B11H102KA01D	K22178809		1-	B	b2
C 1412	CHIP CAP.	0.01uF	25V	B	GRM155B11E103KA01D	K22148834		3-	B	b2
C 1413	CHIP CAP.	10pF	50V	CH	UMK105CH100DV-F	K22178258		1-	B	b2
C 1414	CHIP CAP.	0.1uF	10V	B	GRM155B11A104KA01D	K22108802		1-	A	B5
C 1415	CHIP CAP.	0.01uF	25V	B	GRM155B11E103KA01D	K22148834		1-	A	B5
C 1416	CHIP CAP.	0.1uF	10V	B	GRM155B11A104KA01D	K22108802		1-	A	A5
C 1417	CHIP CAP.	1uF	10V	B	GRM155B31A105KE15D	K22108809		1-	A	C5
C 1418	CHIP CAP.	1uF	10V	B	GRM155B31A105KE15D	K22108809		1-	A	C4
C 1419	CHIP CAP.	0.001uF	50V	B	UMK105B102KW-F	K22178829		1-	A	C4
C 1420	CHIP CAP.	0.001uF	50V	B	UMK105B102KW-F	K22178829		1-	B	c4
C 1421	CHIP TA.CAP.	22uF	4V		TEESVP0G226M8R	K78060047		1-	B	c4
C 1422	CHIP CAP.	1uF	10V	B	GRM155B31A105KE15D	K22108809		1-	A	C2
C 1423	CHIP CAP.	1uF	10V	B	GRM155B31A105KE15D	K22108809		1-	A	C1
C 1424	CHIP CAP.	1uF	10V	B	GRM155B31A105KE15D	K22108809		1-	A	C1
C 1425	CHIP CAP.	1uF	10V	B	GRM155B31A105KE15D	K22108809		1-	A	C1
C 1431	CHIP CAP.	0.001uF	50V	B	UMK105B102KW-F	K22178829		1-	A	C1
C 1432	CHIP CAP.	0.22uF	10V	B	GRM155B31A224KE18D	K22108808		1-	A	C1
C 1433	CHIP CAP.	1uF	10V	B	GRM155B31A105KE15D	K22108809		1-	A	A3
C 1434	CHIP CAP.	0.0047uF	25V	B	TMK105B472KW-F	K22148831		1-	A	A3
C 1435	CHIP CAP.	0.0047uF	25V	B	TMK105B472KW-F	K22148831		1-	A	A3
C 1436	CHIP CAP.	33pF	50V	CH	GRM1552C1H330JZ01D	K22178224		1-	A	A3
C 1437	CHIP CAP.	0.001uF	50V	B	UMK105B102KW-F	K22178829		1-	A	A4
C 1438	CHIP TA.CAP.	4.7uF	6.3V		TEESVP0J475M8R	K78080053		1-	A	A4
C 1439	CHIP CAP.	0.01uF	25V	B	GRM155B11E103KA01D	K22148834		1-	A	A4
C 1441	CHIP CAP.	0.0027uF	50V	B	UMK105B272KW-F	K22178834		1-	A	B4

MAIN Unit

Parts List

REF	DESCRIPTION	VALUE	V/W	TOL.	MFR'S DESIG	VXSTD P/N	VERS.	LOT	SIDE	LAY ADR
C 1442	CHIP TA.CAP.	22uF	4V		TEESVP0G226M8R	K78060047		1-	A	B4
C 1443	CHIP TA.CAP.	22uF	4V		TEESVP0G226M8R	K78060047		1-	A	C4
C 1444	CHIP CAP.	0.022uF	16V	B	GRM155B11C223KA01D	K22128806		1-	A	B4
C 1445	CHIP CAP.	220pF	25V	CH	TMK105CH221JV-F	K22148246		1-	A	B4
C 1446	CHIP CAP.	560pF	50V	B	UMK105B561KW-F	K22178826		1-	A	B4
C 1447	CHIP CAP.	0.01uF	25V	B	GRM155B11E103KA01D	K22148834		1-	A	B4
C 1448	CHIP CAP.	0.022uF	16V	B	GRM155B11C223KA01D	K22128806		1-	A	B4
C 1449	CHIP CAP.	220pF	25V	CH	TMK105CH221JV-F	K22148246		1-	A	B4
C 1450	CHIP CAP.	560pF	50V	B	UMK105B561KW-F	K22178826		1-	A	B4
C 1451	CHIP CAP.	0.01uF	25V	B	GRM155B11E103KA01D	K22148834		1-	A	B4
C 1452	CHIP CAP.	0.001uF	50V	B	UMK105B102KW-F	K22178829		1-	A	C4
C 1453	CHIP CAP.	0.047uF	10V	B	GRM155B11A473KA01D	K22108801		1-	A	C4
C 1454	CHIP CAP.	0.001uF	50V	B	UMK105B102KW-F	K22178829		1-	A	B3
C 1455	CHIP CAP.	5pF	50V	CH	UMK105CH050CV-F	K22178253		1-	B	b3
C 1456	CHIP CAP.	0.001uF	50V	B	UMK105B102KW-F	K22178829		1-	A	B1
C 1457	CHIP CAP.	3pF	50V	CJ	UMK105CJ030CV-F	K22178251		1-	B	c2
C 1458	CHIP CAP.	5pF	50V	CH	UMK105CH050CV-F	K22178253		1-	B	c2
C 1459	CHIP CAP.	0.001uF	50V	B	GRM155B11H102KA01D	K22178809		1-	B	c1
C 1460	CHIP CAP.	0.001uF	50V	B	GRM155B11H102KA01D	K22178809		1-	A	C1
C 1461	CHIP CAP.	0.001uF	50V	B	GRM155B11H102KA01D	K22178809		1-	A	B1
C 1462	CHIP CAP.	0.001uF	50V	B	GRM155B11H102KA01D	K22178809		1-	A	B1
C 1463	CHIP CAP.	0.001uF	50V	B	GRM155B11H102KA01D	K22178809		1-	A	A1
C 1464	CHIP CAP.	0.001uF	50V	B	GRM155B11H102KA01D	K22178809		1-	A	B2
C 1465	CHIP CAP.	0.001uF	50V	B	GRM155B11H102KA01D	K22178809		1-	A	A2
C 1466	CHIP CAP.	0.1uF	10V	B	GRM155B11A104KA01D	K22108802		1-	B	c1
C 1467	CHIP CAP.	0.001uF	50V	B	UMK105B102KW-F	K22178829		1-	A	A5
CD1001	CERAMIC DISC				CDBLB450KCAY07-B0	H7900930		1-		
CF1001	CERAMIC FILTER				SFECF10M7GA00-R0	H3900577		1-	B	a3
CF1002	CERAMIC FILTER				ELFC450F	H3900552		1-	B	a4
D 1002	DIODE				1SS362(TE85R.F)	G2070268		1-	B	c3
D 1003	DIODE				1SS362(TE85R.F)	G2070268		1-	B	c2
D 1005	DIODE				HVC358B TRF-E	G2070590		1-	B	c3
D 1006	DIODE				1SS400G T2R	G2070934		1-	A	B5
D 1008	DIODE				DAN222M T2L	G2070936		1-	A	A5
D 1009	LED				CL-165HR/YG-D-T	G2070860		1-	A	C1
D 1010	DIODE				HVC358B TRF-E	G2070590		1-	B	b3
D 1011	DIODE				1SV325(TPH3.F)	G2070848		1-	B	b2
D 1012	DIODE				1SV325(TPH3.F)	G2070848		1-	B	b3
D 1013	DIODE				1SV331(TPH3.F)	G2071044		1-	B	b3
D 1014	DIODE				1SV325(TPH3.F)	G2070848		1-	B	b3
D 1015	DIODE				1SV325(TPH3.F)	G2070848		1-	B	b2
D 1016	DIODE				1SV331(TPH3.F)	G2071044		1-	B	b2
D 1017	LED				SML-512WWT86	G2071104		1-	A	A4
D 1018	LED				SML-512WWT86	G2071104		1-	A	A3
D 1019	LED				SML-512WWT86	G2071104		1-	A	C3
D 1020	LED				SML-512WWT86	G2071104		1-	A	C3
D 1021	DIODE				1SV331(TPH3.F)	G2071044		1-	A	B3
D 1022	DIODE				1SV331(TPH3.F)	G2071044		1-	A	C4
D 1023	DIODE				HVC358B TRF-E	G2070590		1-	B	b3
D 1024	DIODE				HVC358B TRF-E	G2070590		1-	B	b3
D 1025	DIODE				1SV325(TPH3.F)	G2070848		1-	B	b2
D 1026	DIODE				1SV325(TPH3.F)	G2070848		1-	B	b2
D 1027	DIODE				1SS400G T2R	G2070934		1-	B	b3
D 1028	LED				SML-512WWT86	G2071104		1-	A	A5
D 1029	DIODE				1SS400G T2R	G2070934		1-	A	B3
D 1030	DIODE				DAP222M T2L	G2070938		1-	B	a3
D 1031	DIODE				1SS400G T2R	G2070934		1-	B	a3
D 1032	DIODE				1SS400G T2R	G2070934		1-	B	a3
D 1033	DIODE				DA221M T2L	G2070940		1-	B	a4
D 1034	DIODE				DAN222M T2L	G2070936		1-	B	a3
D 1035	DIODE				HVC359 TRF-E	G2070708		1-	B	c4
D 1036	DIODE				DAN222M T2L	G2070936		1-	B	a4
D 1037	DIODE				DAN222M T2L	G2070936		1-	B	a4
D 1039	DIODE				DAN222M T2L	G2070936		1-	B	b3
D 1042	DIODE				DA221M T2L	G2070940		1-	B	a3
D 1043	DIODE				DA221M T2L	G2070940		1-	B	a3
D 1044	DIODE				1SS400G T2R	G2070934		1-	A	A4
D 1047	DIODE				DA221M T2L	G2070940		1-	A	C2
D 1048	DIODE				DA221M T2L	G2070940		1-	A	C2
D 1056	LED				WH104S(TAPE)	G2071174		1-	A	C1
D 1066	DIODE				RB521S-30 TE61	G2070642		1-	B	b2
D 1067	DIODE				RSX101VA-30TR	G2070984		1-	B	b2
D 1068	DIODE				1SS400G T2R	G2070934		1-	B	a1

MAIN Unit

Parts List

REF	DESCRIPTION	VALUE	V/W	TOL.	MFR'S DESIG	VXSTD P/N	VERS.	LOT	SIDE	LAY ADR
D 1069	DIODE				M1FM3-6063	G2071090		1-	B	a2
D 1070	DIODE				DA221M T2L	G2070940		1-	A	A4
D 1073	DIODE				RB521S-30 TE61	G2070642		1-	A	B1
D 1074	DIODE				1SS400G T2R	G2070934		1-	B	b3
D 1075	DIODE				JDP2S04E(TAPE)	G2071180		1-	A	A4
D 1076	SURGE ABSORBER				EZAEG2A50AX	Q9000868		1-	A	A1
D 1077	DIODE				1SS400G T2R	G2070934		1-	B	b3
D 1080	DIODE				HVC131TRF-E	G2070676		1-	B	c1
D 1082	DIODE				HVC131TRF-E	G2070676		1-	B	c1
D 1083	DIODE				HVC355B TRF-E	G2070588		1-	B	c2
D 1084	DIODE				HVC355B TRF-E	G2070588		1-	B	c2
D 1085	DIODE				1SS400G T2R	G2070934		1-	B	b3
D 1086	DIODE				HVC131TRF-E	G2070676		1-	B	c1
D 1087	DIODE				HVC131TRF-E	G2070676		1-	B	c2
D 1088	DIODE				HVC131TRF-E	G2070676		1-	B	c1
D 1089	DIODE				HVC131TRF-E	G2070676		1-	B	b2
D 1090	DIODE				HVC131TRF-E	G2070676		1-	B	b2
D 1091	DIODE				1SS400G T2R	G2070934		1-	A	B5
D 1092	DIODE				DAN222M T2L	G2070936		1-	A	A4
D 1093	DIODE				DAN222M T2L	G2070936		1-	A	B4
D 1094	DIODE				HVC131TRF-E	G2070676		1-	B	b2
D 1095	DIODE				DA221M T2L	G2070940		1-	A	B4
DS1001	LCD MODULE				TXDM12848CF-S1	Q7000625		1-		
F 1001	CHIP FUSE	0.63A			FCC10 631ABPA	Q0000114		1-	B	b2
FB1001	FERRITE BEADS				BLM15BD102SN1D	L9190133		1-	B	a2
FB1002	FERRITE BEADS				BLM15BD102SN1D	L9190133		1-	B	a2
FB1003	FERRITE BEADS				BLM15BD102SN1D	L9190133		1-	B	a1
FB1004	FERRITE BEADS				BLM15BD102SN1D	L9190133		1-	B	b1
FB1005	FERRITE BEADS				BLM15BD102SN1D	L9190133		1-	B	b1
FB1007	FERRITE BEADS				BLM15BD102SN1D	L9190133		1-	B	b1
FB1008	CHIP RES.	0	1/16W	5%	RMC1/16S JPTH	J24189070		1-	B	b1
FB1009	CHIP COIL				BLM21PG300SN1D	L1690840		1-	B	a2
FB1010	CHIP COIL				BLM21PG300SN1D	L1690840		1-	B	a2
FB1011	FERRITE BEADS				BLM15BD102SN1D	L9190133		1-	A	B1
J 1001	CONNECTOR				MJC-041-B1Z-3.5T	P1091312		1-	B	a1
J 1002	SHIELD FINGER				1674954-1	S5000255		1-	A	C5
J 1003	SHIELD FINGER				1674954-1	S5000255		1-	A	B5
J 1004	CONNECTOR				MJC-041-B1Z-3.5T	P1091312		1-	B	b1
J 1005	CONNECTOR				AXK6F10345YP	P0091378		1-	B	c4
J 1006	CONNECTOR				AXK6F10345YP	P0091378		1-	B	b4
J 1007	CONNECTOR				AXK6F10345YP	P0091378		1-	B	c3
J 1009	CONNECTOR				MJC-051-A1-1-T	P1091311		1-	B	a2
J 1015	CONNECTOR				FH26-21S-0.3SHW(05)	P1091372		1-	A	C2
L 1001	M.RFC	0.0082uH			TFL0510-8N2	L1690810		1-	B	b1
L 1002	M.RFC	0.033uH		2%	C1608CB-33NG-RF	L1691038		1-	B	c3
L 1003	M.RFC	0.12uH		2%	C1608CB-R12G-RF	L1691100		1-	B	b2
L 1004	M.RFC	0.68uH			LK1608 R68K-T	L1690416		1-	A	A5
L 1005	M.RFC	0.0082uH			TFL0510-8N2	L1690810		1-	B	b2
L 1006	M.RFC	0.0047uH			TFL0510-4N7	L1690807		1-	B	b2
L 1008	M.RFC	0.018uH		2%	C1608CB-18NG-RF	L1691035		1-	B	c3
L 1009	M.RFC	0.01uH		2%	C1608CB-10NG-RF	L1691032		1-	B	c3
L 1010	M.RFC	0.15uH		2%	C1608CB-R15G-RF	L1691101		1-	B	b2
L 1011	M.RFC	0.056uH		2%	C1608CB-56NG-RF	L1691041		1-	B	b2
L 1012	M.RFC	0.1uH		2%	C1608CB-R10G-RF	L1691045		1-	B	b2
L 1013	M.RFC	0.15uH		2%	C1608CB-R15G-RF	L1691101		1-	B	b3
L 1014	M.RFC	0.18uH		2%	C1608CB-R18G-RF	L1691102		1-	B	b2
L 1015	M.RFC	0.1uH		2%	C1608CB-R10G-RF	L1691045		1-	B	b2
L 1016	M.RFC	4.7uH			LK1608 4R7K-T	L1690688		1-	A	A5
L 1018	M.RFC	0.01uH			TFL0510-10N	L1690811		1-	A	B3
L 1019	CHIP RES.	220	1/16W	5%	RMC1/16S 221JTH	J24189017		1-	A	B3
L 1020	M.RFC	0.0027uH		5%	C1005C-2N7J-RF	L1691338		1-	A	B3
L 1021	M.RFC	0.01uH		2%	C1608CB-10NG-RF	L1691032		1-	B	b3
L 1022	M.RFC	0.01uH		2%	C1608CB-10NG-RF	L1691032		1-	B	b3
L 1023	M.RFC	0.047uH		2%	C1608CB-47NG-RF	L1691040		1-	B	b2
L 1024	M.RFC	0.047uH		2%	C1608CB-47NG-RF	L1691040		1-	B	b3
L 1026	M.RFC	0.0027uH		5%	C1005C-2N7J-RF	L1691338		1-	A	C4
L 1027	M.RFC	0.01uH		2%	C1608CB-10NG-RF	L1691032		1-	B	b3
L 1028	M.RFC	0.0047uH			TFL0510-4N7	L1690807		1-	A	B3
L 1029	M.RFC	0.047uH		2%	C1608CB-47NG-RF	L1691040		1-	B	b2
L 1030	M.RFC	0.15uH			LK1608 R15K-T	L1690409		1-	B	a3
L 1031	M.RFC	0.39uH			LK1608 R39K-T	L1690413		1-	B	a3
L 1032	M.RFC	0.33uH			LK1608 R33K-T	L1690412		1-	B	a2
L 1033	M.RFC	0.22uH			LK1608 R22K-T	L1690410		1-	B	b4

MAIN Unit

Parts List

REF	DESCRIPTION	VALUE	V/W	TOL.	MFR'S DESIG	VXSTD P/N	VERS.	LOT	SIDE	LAY ADR
L 1034	M.RFC	0.47uH			LK1608 R47K-T	L1690414		1-	B	b5
L 1035	M.RFC	1uH			LK1608 1R0K-T	L1690687		1-	B	b4
L 1036	M.RFC	0.22uH			LK1608 R22K-T	L1690410		1-	B	b4
L 1037	M.RFC	33uH			LK1608 330M-T	L1690690		1-	B	c4
L 1038	M.RFC	0.33uH		2%	C1608CB-R33G-RF	L1691106		1-	B	a4
L 1041	M.RFC	0.022uH			TFL0510-22N	L1690815		1-	B	b4
L 1044	M.RFC	0.015uH			TFL0510-15N	L1690813		1-	B	b3
L 1045	M.RFC	10uH		2%	KQ1008TE100G	L1691216		1-	B	a5
L 1046	M.RFC	150uH			FLC32T-151J	L1690229		1-	A	C2
L 1070	M.RFC	0.0068uH			TFL0510-6N8	L1690809		1-	B	c1
L 1071	M.RFC	0.0068uH			TFL0510-6N8	L1690809		1-	B	c1
L 1072	M.RFC	0.0056uH			TFL0510-5N6	L1690808		1-	B	c1
L 1074	M.RFC	0.0056uH			TFL0510-5N6	L1690808		1-	B	c2
L 1075	M.RFC	0.0022uH			TFL0510-2N2	L1690803		1-	B	c2
L 1076	M.RFC	0.0039uH			TFL0510-3N9	L1690806		1-	B	c2
L 1077	M.RFC	0.0022uH			TFL0510-2N2	L1690803		1-	B	c2
L 1078	M.RFC	0.0056uH			TFL0510-5N6	L1690808		1-	B	c2
L 1079	M.RFC	0.01uH		2%	C1608CB-10NG-RF	L1691032		1-	B	c2
Q 1001	TRANSISTOR				MT3S36FS(TE85L.F)	G3070377		1-	A	B3
Q 1002	TRANSISTOR				2SC5555ZD-TR	G3355557		1-	B	c3
Q 1003	TRANSISTOR				MT3S36FS(TE85L.F)	G3070377		1-	B	b3
Q 1004	TRANSISTOR				DTC144EM T2L	G3070309		1-	A	A5
Q 1005	IC				NJM2151AV(TAPE)	G1094420		1-	A	A2
Q 1006	FET				2SK3541 T2L	G3835417		1-	A	B5
Q 1007	FET				2SK3541 T2L	G3835417		1-	A	B5
Q 1008	FET				2SK3541 T2L	G3835417		1-	A	B4
Q 1009	TRANSISTOR				EMG2 T2R	G3070304		1-	A	C1
Q 1012	TRANSISTOR				MT3S36FS(TE85L.F)	G3070377		1-	A	B3
Q 1013	TRANSISTOR				2SC5555ZD-TR	G3355557		1-	B	b3
Q 1014	IC				LV24100LP-TLM-E	G1094371		1-	A	A5
Q 1015	TRANSISTOR				MT3S36FS(TE85L.F)	G3070377		1-	B	b3
Q 1016	FET				2SK3541 T2L	G3835417		1-	A	B5
Q 1017	IC				BU2502MUV	G1094586		1-	A	C4
Q 1018	TRANSISTOR				MT3S36FS(TE85L.F)	G3070377		1-	A	C3
Q 1019	TRANSISTOR				2SC5555ZD-TR	G3355557		1-	B	b3
Q 1020	TRANSISTOR				2SC5555ZD-TR	G3355557		1-	B	a3
Q 1021	TRANSISTOR				2SC5555ZD-TR	G3355557		1-	B	b3
Q 1023	IC				NJM12904R-TE1	G1093337		1-	A	C5
Q 1025	IC				NJU7007F3-TE1	G1093617		1-	A	C5
Q 1027	TRANSISTOR				DTC143TM-T2L	G3070372		1-	A	A3
Q 1028	TRANSISTOR				DTC143TM-T2L	G3070372		1-	A	C1
Q 1029	TRANSISTOR				2SC4915-O(TE85L.F)	G33491580		1-	B	a2
Q 1030	TRANSISTOR				2SC4915-O(TE85L.F)	G33491580		1-	B	a3
Q 1031	TRANSISTOR				EMG2 T2R	G3070304		1-	B	a3
Q 1032	FET				2SK3541 T2L	G3835417		1-	A	C3
Q 1033	TRANSISTOR				2SC4915-O(TE85L.F)	G33491580		1-	B	a3
Q 1034	TRANSISTOR				2SC4915-O(TE85L.F)	G33491580		1-	B	b4
Q 1035	TRANSISTOR				2SC4915-O(TE85L.F)	G33491580		1-	B	b5
Q 1036	TRANSISTOR				2SC4915-O(TE85L.F)	G33491580		1-	B	c5
Q 1037	TRANSISTOR				2SC4915-O(TE85L.F)	G33491580		1-	B	b4
Q 1038	TRANSISTOR				2SC5374-TL	G3353748		1-	B	b4
Q 1039	TRANSISTOR				DTA114TE TL	G3070264		1-	A	A4
Q 1040	TRANSISTOR				DTC144EM T2L	G3070309		1-	A	A4
Q 1041	IC				MB15A01PFV1-G-BND-EFE1	G1092545		1-	B	b4
Q 1042	TRANSISTOR				DTA114TE TL	G3070264		1-	A	C4
Q 1043	TRANSISTOR				DTA114TE TL	G3070264		1-	A	C3
Q 1044	TRANSISTOR				EMB10 T2R	G3070302		1-	A	C4
Q 1045	TRANSISTOR				DTC144EM T2L	G3070309		1-	A	C4
Q 1047	IC				NJM2552V-TE1	G1094382		1-	B	a4
Q 1048	TRANSISTOR				2SC5374-TL	G3353748		1-	B	b4
Q 1050	TRANSISTOR				DTC144EM T2L	G3070309		1-	A	C4
Q 1055	TRANSISTOR				2SC5658 T2L Q/R	G3356588		1-	A	A4
Q 1056	TRANSISTOR				2SC5374-TL	G3353748		1-	B	b3
Q 1057	TRANSISTOR				2SA2029 T2L Q/R	G3120298		1-	A	A4
Q 1058	TRANSISTOR				EMB3 T2R	G3070303		1-	A	A4
Q 1059	TRANSISTOR				DTC144EM T2L	G3070309		1-	A	B4
Q 1060	TRANSISTOR				EMB3 T2R	G3070303		1-	A	B4
Q 1061	TRANSISTOR				DTC144EM T2L	G3070309		1-	A	B4
Q 1065	TRANSISTOR				2SC5658 T2L Q/R	G3356588		1-	B	a3
Q 1067	TRANSISTOR				DTC144EM T2L	G3070309		1-	B	b4
Q 1068	FET				2SJ364-P(TX)	G3703648P		1-	B	b4
Q 1072	TRANSISTOR				EMB10 T2R	G3070302		1-	A	B4
Q 1074	TRANSISTOR				EMB3 T2R	G3070303		1-	A	B4

MAIN Unit

Parts List

REF	DESCRIPTION	VALUE	V/W	TOL.	MFR'S DESIG	VXSTD P/N	VERS.	LOT	SIDE	LAY ADR
Q 1075	TRANSISTOR				DTC144EM T2L	G3070309		1-	A	A4
Q 1077	TRANSISTOR				2SC5374-TL	G3353748		1-	A	C2
Q 1078	TRANSISTOR				2SC5658 T2L Q/R	G3356588		1-	A	C2
Q 1082	FET				2SK3541 T2L	G3835417		1-	A	B4
Q 1083	IC				NJU7747F4-03-TE1	G1094425		1-	A	B1
Q 1084	IC				XC61GN3002HR	G1094470		1-	A	C2
Q 1085	TRANSISTOR				DTC144EM T2L	G3070309		1-	A	C2
Q 1086	IC				TAR5S30(TE85L.F)	G1093570		1-	A	C1
Q 1087	IC				XC61GN3002HR	G1094470		1-	A	C2
Q 1088	TRANSISTOR				2SC5658 T2L Q/R	G3356588		1-	A	B4
Q 1090	FET				MCH6305-TL	G3070301		1-	B	b2
Q 1092	TRANSISTOR				2SA2029 T2L Q/R	G3120298		1-	A	C3
Q 1093	TRANSISTOR				2SC5658 T2L Q/R	G3356588		1-	A	B5
Q 1094	IC				AT24C256B-TH-T	G1094384		1-	A	A1
Q 1095	IC				HD64F2266TF13V(FLASH)	G1093813		1-	A	B1
Q 1096	TRANSISTOR				CPH6102-TL	G3070223		1-	B	b2
Q 1097	IC				MM1438BWLE	G1093814		1-	B	b2
Q 1098	TRANSISTOR				DTC144EM T2L	G3070309		1-	B	b2
Q 1099	TRANSISTOR				EMD22 T2R	G3070402		1-	A	A4
Q 1103	FET				SSM6J25FE(TAPE)	G3070379		1-	A	C1
Q 1104	TRANSISTOR				DTC144EM T2L	G3070309		1-	A	C1
Q 1105	TRANSISTOR				DTC144EM T2L	G3070309		1-	A	A5
Q 1106	TRANSISTOR				2SC5374-TL	G3353748		1-	A	A5
Q 1110	TRANSISTOR				DTC144EM T2L	G3070309		1-	B	b1
Q 1111	TRANSISTOR				MT3S36FS(TE85L.F)	G3070377		1-	B	c2
Q 1112	TRANSISTOR				MT3S36FS(TE85L.F)	G3070377		1-	B	c2
Q 1113	TRANSISTOR				MT3S36FS(TE85L.F)	G3070377		1-	B	c2
Q 1116	IC				TC4W66FU(TE12L.F)	G1091676		1-	A	A1
Q 1117	IC				TC75W51FK	G1094676		1-	A	C4
Q 1118	FET				2SK3541 T2L	G3835417		1-	A	C5
Q 1119	FET				2SK3541 T2L	G3835417		1-	A	C4
Q 1121	TRANSISTOR				EMG2 T2R	G3070304		1-	A	A4
Q 1122	TRANSISTOR				EMD22 T2R	G3070402		1-	A	A4
Q 1123	IC				TC75W51FK	G1094676		1-	A	B3
Q 1124	IC				TC75W51FK	G1094676		1-	A	B4
Q 1125	IC				TC75W51FK	G1094676		1-	A	B4
Q 1126	TRANSISTOR				2SC5658 T2L Q/R	G3356588		1-	A	B3
Q 1127	TRANSISTOR				DTC144EM T2L	G3070309		1-	A	B3
Q 1128	TRANSISTOR				DTC144EM T2L	G3070309		1-	A	B4
Q 1129	TRANSISTOR				DTC144TE-TL	G3070280		1-	A	B2
Q 1130	TRANSISTOR				DTC144EM T2L	G3070309		1-	A	B4
Q 1131	TRANSISTOR				DTC144EM T2L	G3070309		1-	A	C4
Q 1170	TRANSISTOR				DTC144EM T2L	G3070309		1-	A	A4
R 1004	CHIP RES.	470k	1/16W	5%	RMC1/16S 474JTH	J24189057		1-	A	C2
R 1006	CHIP RES.	47k	1/16W	5%	RMC1/16S 473JTH	J24189045		1-	A	B3
R 1007	CHIP RES.	0	1/16W	5%	RMC1/16S JPTH	J24189070		1-	A	B3
R 1008	CHIP RES.	68k	1/16W	5%	RMC1/16S 683JTH	J24189047		1-	B	c3
R 1009	CHIP RES.	220	1/16W	5%	RMC1/16S 221JTH	J24189017		1-	B	c3
R 1010	CHIP RES.	47k	1/16W	5%	RMC1/16S 473JTH	J24189045		1-	B	b3
R 1011	CHIP RES.	270	1/16W	5%	RMC1/16S 271JTH	J24189018		1-	B	b3
R 1012	CHIP RES.	220	1/16W	5%	RMC1/16S 221JTH	J24189017		1-	B	b3
R 1013	CHIP RES.	100k	1/16W	5%	RMC1/16S 104JTH	J24189049		1-	B	b3
R 1014	CHIP RES.	2.2k	1/16W	5%	RMC1/16S 222JTH	J24189029		1-	A	A5
R 1015	CHIP RES.	3.3k	1/16W	5%	RMC1/16S 332JTH	J24189031		1-	A	A5
R 1016	CHIP RES.	1k	1/16W	5%	RMC1/16S 102JTH	J24189025		1-	A	A5
R 1017	CHIP RES.	2.2k	1/16W	5%	RMC1/16S 222JTH	J24189029		1-	A	A5
R 1018	CHIP RES.	1.8k	1/16W	5%	RMC1/16S 182JTH	J24189028		1-	A	A5
R 1019	CHIP RES.	33k	1/16W	5%	RMC1/16S 333JTH	J24189043		1-	A	A2
R 1020	CHIP RES.	33k	1/16W	5%	RMC1/16S 333JTH	J24189043		1-	A	A2
R 1021	CHIP RES.	10k	1/16W	5%	RMC1/16S 103JTH	J24189037		1-	A	B5
R 1022	CHIP RES.	39k	1/16W	5%	RMC1/16S 393JTH	J24189044		1-	A	A2
R 1023	CHIP RES.	560	1/16W	5%	RMC1/16S 561JTH	J24189022		1-	A	A2
R 1024	CHIP RES.	10k	1/16W	5%	RMC1/16S 103JTH	J24189037		1-	A	B4
R 1025	CHIP RES.	330k	1/16W	5%	RMC1/16S 334JTH	J24189055		1-	A	B4
R 1026	CHIP RES.	10k	1/16W	5%	RMC1/16S 103JTH	J24189037		1-	A	B4
R 1027	CHIP RES.	10k	1/16W	5%	RMC1/16S 103JTH	J24189037		1-	A	B4
R 1028	CHIP RES.	330k	1/16W	5%	RMC1/16S 334JTH	J24189055		1-	A	B4
R 1029	CHIP RES.	220	1/16W	5%	RMC1/16S 221JTH	J24189017		1-	A	C1
R 1030	CHIP RES.	100	1/16W	5%	RMC1/16S 101JTH	J24189013		1-	A	B1
R 1039	CHIP RES.	47	1/16W	5%	RMC1/16S 470JTH	J24189009		1-	A	B3
R 1040	CHIP RES.	47k	1/16W	5%	RMC1/16S 473JTH	J24189045		1-	A	B3
R 1041	CHIP RES.	0	1/16W	5%	RMC1/16S JPTH	J24189070		1-	A	B3
R 1042	CHIP RES.	100	1/16W	5%	RMC1/16S 101JTH	J24189013		1-	A	B3

MAIN Unit

Parts List

REF	DESCRIPTION	VALUE	V/W	TOL.	MFR'S DESIG	VXSTD P/N	VERS.	LOT	SIDE	LAY ADR
R 1043	CHIP RES.	100k	1/16W	5%	RMC1/16S 104JTH	J24189049		1-	B	c3
R 1044	CHIP RES.	100k	1/16W	5%	RMC1/16S 104JTH	J24189049		1-	B	c3
R 1045	CHIP RES.	47k	1/16W	5%	RMC1/16S 473JTH	J24189045		1-	B	b3
R 1046	CHIP RES.	0	1/16W	5%	RMC1/16S JPTH	J24189070		1-	A	B3
R 1047	CHIP RES.	100	1/16W	5%	RMC1/16S 101JTH	J24189013		1-	B	b3
R 1048	CHIP RES.	100k	1/16W	5%	RMC1/16S 104JTH	J24189049		1-	B	b3
R 1049	CHIP RES.	100k	1/16W	5%	RMC1/16S 104JTH	J24189049		1-	B	b2
R 1051	CHIP RES.	47k	1/16W	5%	RMC1/16S 473JTH	J24189045		1-	B	b3
R 1052	CHIP RES.	220	1/16W	5%	RMC1/16S 221JTH	J24189017		1-	B	b3
R 1053	CHIP RES.	10k	1/16W	5%	RMC1/16S 103JTH	J24189037		1-	A	B5
R 1054	CHIP RES.	10k	1/16W	5%	RMC1/16S 103JTH	J24189037		1-	A	B5
R 1055	CHIP RES.	330k	1/16W	5%	RMC1/16S 334JTH	J24189055		1-	A	B5
R 1056	CHIP RES.	10k	1/16W	5%	RMC1/16S 103JTH	J24189037		1-	A	B5
R 1057	CHIP RES.	330k	1/16W	5%	RMC1/16S 334JTH	J24189055		1-	A	B5
R 1058	CHIP RES.	10k	1/16W	5%	RMC1/16S 103JTH	J24189037		1-	A	B5
R 1059	CHIP RES.	100k	1/16W	5%	RMC1/16S 104JTH	J24189049		1-	A	C5
R 1060	CHIP RES.	100k	1/16W	5%	RMC1/16S 104JTH	J24189049		1-	A	C5
R 1061	CHIP RES.	10k	1/16W	5%	RMC1/16S 103JTH	J24189037		1-	A	B5
R 1062	CHIP RES.	10k	1/16W	5%	RMC1/16S 103JTH	J24189037		1-	A	B4
R 1063	CHIP RES.	220	1/16W	5%	RMC1/16S 221JTH	J24189017		1-	A	A4
R 1064	CHIP RES.	220	1/16W	5%	RMC1/16S 221JTH	J24189017		1-	A	A3
R 1066	CHIP RES.	220	1/16W	5%	RMC1/16S 221JTH	J24189017		1-	A	C3
R 1067	CHIP RES.	220	1/16W	5%	RMC1/16S 221JTH	J24189017		1-	A	C3
R 1078	CHIP RES.	100k	1/16W	5%	RMC1/16S 104JTH	J24189049		1-	A	B4
R 1079	CHIP RES.	100k	1/16W	5%	RMC1/16S 104JTH	J24189049		1-	A	B4
R 1080	CHIP RES.	100k	1/16W	5%	RMC1/16S 104JTH	J24189049		1-	A	C3
R 1081	CHIP RES.	100k	1/16W	5%	RMC1/16S 104JTH	J24189049		1-	B	b3
R 1082	CHIP RES.	100k	1/16W	5%	RMC1/16S 104JTH	J24189049		1-	B	b3
R 1083	CHIP RES.	100k	1/16W	5%	RMC1/16S 104JTH	J24189049		1-	B	b3
R 1084	CHIP RES.	47	1/16W	5%	RMC1/16S 470JTH	J24189009		1-	B	b3
R 1085	CHIP RES.	220	1/16W	5%	RMC1/16S 221JTH	J24189017		1-	B	a3
R 1086	CHIP RES.	100k	1/16W	5%	RMC1/16S 104JTH	J24189049		1-	B	b2
R 1087	CHIP RES.	270k	1/16W	5%	RMC1/16S 274JTH	J24189054		1-	B	b3
R 1088	CHIP RES.	100k	1/16W	5%	RMC1/16S 104JTH	J24189049		1-	B	b3
R 1089	CHIP RES.	220k	1/16W	5%	RMC1/16S 224JTH	J24189053		1-	B	a3
R 1090	CHIP RES.	470	1/16W	5%	RMC1/16S 471JTH	J24189021		1-	B	b3
R 1091	CHIP RES.	220	1/16W	5%	RMC1/16S 221JTH	J24189017		1-	B	a2
R 1092	CHIP RES.	330	1/16W	5%	RMC1/16S 331JTH	J24189019		1-	B	b3
R 1092	CHIP RES.	680	1/16W	5%	RMC1/16S 681JTH	J24189023		3-	B	b3
R 1093	CHIP RES.	330	1/16W	5%	RMC1/16S 331JTH	J24189019		1-	B	b3
R 1094	CHIP RES.	4.7k	1/16W	5%	RMC1/16S 472JTH	J24189033		1-	A	A4
R 1095	CHIP RES.	2.2k	1/16W	5%	RMC1/16S 222JTH	J24189029		1-	A	A4
R 1096	CHIP RES.	390k	1/16W	0.5%	MCR01MZPD3903	J24189331		1-	A	C5
R 1097	CHIP RES.	470k	1/16W	0.5%	MCR01MZPD4703	J24189332		1-	A	C5
R 1098	CHIP RES.	330k	1/16W	0.5%	MCR01MZPD3303	J24189330		1-	A	C5
R 1099	CHIP RES.	560k	1/16W	0.5%	MCR01MZPD5603	J24189335		1-	A	C5
R 1100	CHIP RES.	270k	1/16W	0.5%	MCR01MZPD2703	J24189329		1-	A	C5
R 1101	CHIP RES.	1M	1/16W	1%	MCR01MZSF1004	J24189333		1-	A	C5
R 1102	CHIP RES.	820k	1/16W	0.5%	MCR01MZPD8203	J24189336		1-	A	C5
R 1103	CHIP RES.	10k	1/16W	5%	RMC1/16S 103JTH	J24189037		1-	A	C5
R 1104	CHIP RES.	47	1/16W	5%	RMC1/16S 470JTH	J24189009		1-	A	C1
R 1109	CHIP RES.	470	1/16W	5%	RMC1/16S 471JTH	J24189021		1-	A	C3
R 1110	CHIP RES.	1k	1/16W	5%	RMC1/16S 102JTH	J24189025		1-	A	B3
R 1111	CHIP RES.	470	1/16W	5%	RMC1/16S 471JTH	J24189021		1-	B	a3
R 1112	CHIP RES.	470k	1/16W	5%	RMC1/16S 474JTH	J24189057		1-	B	a3
R 1113	CHIP RES.	270k	1/16W	0.5%	MCR01MZPD2703	J24189329		1-	A	C4
R 1114	CHIP RES.	100k	1/16W	0.5%	RR0510R-104-D	J24189167		1-	A	B4
R 1118	CHIP RES.	470	1/16W	5%	RMC1/16S 471JTH	J24189021		1-	B	a3
R 1119	CHIP RES.	470	1/16W	5%	RMC1/16S 471JTH	J24189021		1-	B	a3
R 1120	CHIP RES.	100k	1/16W	5%	RMC1/16S 104JTH	J24189049		1-	B	a3
R 1121	CHIP RES.	1k	1/16W	5%	RMC1/16S 102JTH	J24189025		1-	A	C4
R 1123	CHIP RES.	10k	1/16W	5%	RMC1/16S 103JTH	J24189037		1-	A	C4
R 1124	CHIP RES.	100	1/16W	5%	RMC1/16S 101JTH	J24189013		1-	B	a2
R 1125	CHIP RES.	470k	1/16W	5%	RMC1/16S 474JTH	J24189057		1-	B	a3
R 1126	CHIP RES.	150k	1/16W	5%	RMC1/16S 154JTH	J24189051		1-	B	b5
R 1127	CHIP RES.	100k	1/16W	5%	RMC1/16S 104JTH	J24189049		1-	B	b5
R 1128	CHIP RES.	100	1/16W	5%	RMC1/16S 101JTH	J24189013		1-	B	b4
R 1129	CHIP RES.	100	1/16W	5%	RMC1/16S 101JTH	J24189013		1-	B	b5
R 1130	CHIP RES.	560	1/16W	5%	RMC1/16S 561JTH	J24189022		1-	B	c4
R 1131	CHIP RES.	120k	1/16W	5%	RMC1/16S 124JTH	J24189050		1-	B	c4
R 1132	CHIP RES.	330k	1/16W	5%	RMC1/16S 334JTH	J24189055		1-	B	b4
R 1133	CHIP RES.	100	1/16W	5%	RMC1/16S 101JTH	J24189013		1-	B	a4
R 1134	CHIP RES.	1k	1/16W	5%	RMC1/16S 102JTH	J24189025		1-	B	a4

MAIN Unit

Parts List

REF	DESCRIPTION	VALUE	V/W	TOL.	MFR'S DESIG	VXSTD P/N	VERS.	LOT	SIDE	LAY ADR
R 1135	CHIP RES.	330	1/16W	5%	RMC1/16S 331JTH	J24189019		1-	B	a2
R 1136	CHIP RES.	1k	1/16W	5%	RMC1/16S 102JTH	J24189025		1-	B	a3
R 1137	CHIP RES.	10k	1/16W	5%	RMC1/16S 103JTH	J24189037		1-	B	b4
R 1138	CHIP RES.	33k	1/16W	5%	RMC1/16S 333JTH	J24189043		1-	B	b3
R 1139	CHIP RES.	1k	1/16W	5%	RMC1/16S 102JTH	J24189025		1-	B	b4
R 1140	CHIP RES.	1k	1/16W	5%	RMC1/16S 102JTH	J24189025		1-	B	b4
R 1141	CHIP RES.	100k	1/16W	5%	RMC1/16S 104JTH	J24189049		1-	B	b4
R 1142	CHIP RES.	3.3k	1/16W	5%	RMC1/16S 332JTH	J24189031		1-	B	b4
R 1142	CHIP RES.	5.6k	1/16W	5%	RMC1/16S 562JTH	J24189034		3-	B	b4
R 1143	CHIP RES.	10k	1/16W	5%	RMC1/16S 103JTH	J24189037		1-	B	c4
R 1145	CHIP RES.	1M	1/16W	5%	RMC1/16S 105JTH	J24189061		1-	B	b4
R 1157	CHIP RES.	1k	1/16W	5%	RMC1/16S 102JTH	J24189025		1-	B	a4
R 1158	CHIP RES.	100k	1/16W	5%	RMC1/16S 104JTH	J24189049		1-	B	a4
R 1159	CHIP RES.	0	1/16W	5%	RMC1/16S JPTH	J24189070		1-	B	a4
R 1160	CHIP RES.	220	1/16W	5%	RMC1/16S 221JTH	J24189017		1-	B	a4
R 1161	CHIP RES.	22k	1/16W	5%	RMC1/16S 223JTH	J24189041		1-	B	a5
R 1162	CHIP RES.	100	1/16W	5%	RMC1/16S 101JTH	J24189013		1-	B	a5
R 1163	CHIP RES.	100	1/16W	5%	RMC1/16S 101JTH	J24189013		1-	B	a5
R 1164	CHIP RES.	10k	1/16W	5%	RMC1/16S 103JTH	J24189037		1-	B	a5
R 1165	CHIP RES.	10k	1/16W	5%	RMC1/16S 103JTH	J24189037		1-	B	a4
R 1166	CHIP RES.	10k	1/16W	5%	RMC1/16S 103JTH	J24189037		1-	B	a4
R 1167	CHIP RES.	18k	1/16W	5%	RMC1/16S 183JTH	J24189040		1-	B	b3
R 1168	CHIP RES.	1k	1/16W	5%	RMC1/16S 102JTH	J24189025		1-	B	b4
R 1170	CHIP RES.	1k	1/16W	5%	RMC1/16S 102JTH	J24189025		1-	B	c4
R 1171	CHIP RES.	1k	1/16W	5%	RMC1/16S 102JTH	J24189025		1-	B	c4
R 1172	CHIP RES.	680	1/16W	5%	RMC1/16S 681JTH	J24189023		1-	B	c4
R 1183	CHIP RES.	330k	1/16W	5%	RMC1/16S 334JTH	J24189055		1-	B	a4
R 1184	CHIP RES.	3.3k	1/16W	5%	RMC1/16S 332JTH	J24189031		1-	B	a3
R 1185	CHIP RES.	10k	1/16W	5%	RMC1/16S 103JTH	J24189037		1-	B	a4
R 1186	CHIP RES.	680	1/16W	5%	RMC1/16S 681JTH	J24189023		1-	B	a4
R 1187	CHIP RES.	22k	1/16W	5%	RMC1/16S 223JTH	J24189041		1-	B	a4
R 1188	CHIP RES.	4.7k	1/16W	5%	RMC1/16S 472JTH	J24189033		1-	B	b4
R 1189	CHIP RES.	10k	1/16W	5%	RMC1/16S 103JTH	J24189037		1-	B	a5
R 1190	CHIP RES.	1k	1/16W	5%	RMC1/16S 102JTH	J24189025		1-	B	a5
R 1191	CHIP RES.	220	1/16W	5%	RMC1/16S 221JTH	J24189017		1-	B	a5
R 1192	CHIP RES.	1k	1/16W	5%	RMC1/16S 102JTH	J24189025		1-	A	A4
R 1193	CHIP RES.	10k	1/16W	5%	RMC1/16S 103JTH	J24189037		1-	B	b3
R 1194	CHIP RES.	4.7k	1/16W	5%	RMC1/16S 472JTH	J24189033		1-	A	A4
R 1202	CHIP RES.	3.3k	1/16W	5%	RMC1/16S 332JTH	J24189031		1-	B	a3
R 1203	CHIP RES.	330k	1/16W	5%	RMC1/16S 334JTH	J24189055		1-	B	a3
R 1204	CHIP RES.	3.3k	1/16W	5%	RMC1/16S 332JTH	J24189031		1-	B	a4
R 1205	CHIP RES.	1k	1/16W	5%	RMC1/16S 102JTH	J24189025		1-	B	a3
R 1206	CHIP RES.	10k	1/16W	5%	RMC1/16S 103JTH	J24189037		1-	B	b4
R 1207	CHIP RES.	330k	1/16W	5%	RMC1/16S 334JTH	J24189055		1-	B	b4
R 1209	CHIP RES.	10k	1/16W	5%	RMC1/16S 103JTH	J24189037		1-	A	B4
R 1216	CHIP RES.	100k	1/16W	5%	RMC1/16S 104JTH	J24189049		1-	B	a3
R 1217	CHIP RES.	100k	1/16W	5%	RMC1/16S 104JTH	J24189049		1-	B	a3
R 1219	CHIP RES.	330k	1/16W	5%	RMC1/16S 334JTH	J24189055		1-	B	b4
R 1220	CHIP RES.	15k	1/16W	5%	RMC1/16S 153JTH	J24189039		1-	B	b4
R 1221	CHIP RES.	180k	1/16W	5%	RMC1/16S 184JTH	J24189052		1-	B	a3
R 1222	CHIP RES.	100k	1/16W	5%	RMC1/16S 104JTH	J24189049		1-	B	b4
R 1223	CHIP RES.	10k	1/16W	5%	RMC1/16S 103JTH	J24189037		1-	B	b4
R 1224	CHIP RES.	47k	1/16W	5%	RMC1/16S 473JTH	J24189045		1-	A	C3
R 1225	CHIP RES.	4.7k	1/16W	5%	RMC1/16S 472JTH	J24189033		1-	A	C2
R 1226	CHIP RES.	1M	1/16W	5%	RMC1/16S 105JTH	J24189061		1-	A	C2
R 1227	CHIP RES.	47k	1/16W	5%	RMC1/16S 473JTH	J24189045		1-	A	C2
R 1228	CHIP RES.	330k	1/16W	0.5%	MCR01MZPD3303	J24189330		1-	A	C2
R 1230	CHIP RES.	330k	1/16W	5%	RMC1/16S 334JTH	J24189055		1-	A	C2
R 1231	CHIP RES.	68k	1/16W	0.5%	RR0510R-683-D	J24189163		1-	A	C2
R 1232	CHIP RES.	10k	1/16W	5%	RMC1/16S 103JTH	J24189037		1-	A	B4
R 1234	CHIP RES.	470k	1/16W	5%	RMC1/16S 474JTH	J24189057		1-	A	B4
R 1237	CHIP RES.	22k	1/16W	5%	RMC1/16S 223JTH	J24189041		1-	A	C2
R 1238	CHIP RES.	22k	1/16W	5%	RMC1/16S 223JTH	J24189041		1-	A	C2
R 1239	CHIP RES.	2.7k	1/16W	5%	RMC1/16S 272JTH	J24189030		1-	A	B4
R 1240	CHIP RES.	22	1/16W	5%	RMC1/16S 220JTH	J24189005		1-	A	B5
R 1241	CHIP RES.	10k	1/16W	5%	RMC1/16S 103JTH	J24189037		1-	A	B4
R 1242	CHIP RES.	33k	1/16W	5%	RMC1/16S 333JTH	J24189043		1-	A	B5
R 1243	CHIP RES.	150k	1/16W	5%	RMC1/16S 154JTH	J24189051		1-	A	B4
R 1244	CHIP RES.	68k	1/16W	5%	RMC1/16S 683JTH	J24189047		1-	A	C2
R 1245	CHIP RES.	33k	1/16W	5%	RMC1/16S 333JTH	J24189043		1-	A	C2
R 1248	CHIP RES.	0	1/16W	5%	RMC1/16S JPTH	J24189070		1-	A	C2
R 1249	CHIP RES.	4.7k	1/16W	5%	RMC1/16S 472JTH	J24189033		1-	A	C3
R 1250	CHIP RES.	1.5k	1/16W	5%	RMC1/16S 152JTH	J24189027		1-	A	B5

MAIN Unit

Parts List

REF	DESCRIPTION	VALUE	V/W	TOL.	MFR'S DESIG	VXSTD P/N	VERS.	LOT	SIDE	LAY ADR
R 1251	CHIP RES.	2.2M	1/16W	5%	RMC1/16S 225JTH	J24189065		1-	A	B5
R 1252	CHIP RES.	100k	1/16W	5%	RMC1/16S 104JTH	J24189049		1-	A	B5
R 1253	CHIP RES.	470k	1/16W	5%	RMC1/16S 474JTH	J24189057		1-	A	B3
R 1256	CHIP RES.	100k	1/16W	5%	RMC1/16S 104JTH	J24189049		1-	B	b2
R 1257	CHIP RES.	0	1/16W	5%	RMC1/16S JPTH	J24189070		1-	B	b2
R 1258	CHIP RES.	150	1/16W	5%	RMC1/16S 151JTH	J24189015		1-	B	b2
R 1259	CHIP RES.	100k	1/16W	5%	RMC1/16S 104JTH	J24189049		1-	B	b2
R 1261	CHIP RES.	100	1/16W	5%	RMC1/16S 101JTH	J24189013		1-	A	A4
R 1262	CHIP RES.	22k	1/16W	5%	RMC1/16S 223JTH	J24189041		1-	B	c3
R 1263	CHIP RES.	22k	1/16W	5%	RMC1/16S 223JTH	J24189041		1-	B	c3
R 1264	CHIP RES.	4.7k	1/16W	5%	RMC1/16S 472JTH	J24189033		1-	B	c3
R 1265	CHIP RES.	22k	1/16W	5%	RMC1/16S 223JTH	J24189041		1-	A	B1
R 1266	CHIP RES.	22k	1/16W	5%	RMC1/16S 223JTH	J24189041		1-	A	B1
R 1268	CHIP RES.	0.18	1/2W	1%	RLC32-R180FTP	J24279034		1-	A	B2
R 1269	CHIP RES.	100k	1/16W	5%	RMC1/16S 104JTH	J24189049		1-	A	A4
R 1270	CHIP RES.	100k	1/16W	5%	RMC1/16S 104JTH	J24189049		1-	A	B3
R 1271	CHIP RES.	100k	1/16W	5%	RMC1/16S 104JTH	J24189049		1-	A	B3
R 1272	CHIP RES.	100k	1/16W	5%	RMC1/16S 104JTH	J24189049		1-	A	C3
R 1273	CHIP RES.	100k	1/16W	5%	RMC1/16S 104JTH	J24189049		1-	A	C3
R 1275	CHIP RES.	220	1/16W	5%	RMC1/16S 221JTH	J24189017		1-	A	A5
R 1276	CHIP RES.	47	1/16W	5%	RMC1/16S 470JTH	J24189009		1-	B	b5
R 1277	CHIP RES.	100k	1/16W	5%	RMC1/16S 104JTH	J24189049		1-	A	C1
R 1278	CHIP RES.	6.8k	1/16W	5%	RMC1/16S 682JTH	J24189035		1-	A	B5
R 1279	CHIP RES.	6.8k	1/16W	5%	RMC1/16S 682JTH	J24189035		1-	A	B5
R 1280	CHIP RES.	680	1/16W	5%	RMC1/16S 681JTH	J24189023		1-	B	c4
R 1281	CHIP RES.	0	1/16W	5%	RMC1/16S JPTH	J24189070		1-	B	c4
R 1284	CHIP RES.	0	1/16W	5%	RMC1/16S JPTH	J24189070		1-	A	B5
R 1285	CHIP RES.	0	1/16W	5%	RMC1/16S JPTH	J24189070		1-	A	B5
R 1286	CHIP RES.	0	1/16W	5%	RMC1/16S JPTH	J24189070		1-	A	B5
R 1288	CHIP RES.	100	1/16W	5%	RMC1/16S 101JTH	J24189013		1-	B	a2
R 1289	CHIP RES.	47	1/16W	5%	RMC1/16S 470JTH	J24189009		1-	B	a1
R 1290	CHIP RES.	220	1/16W	5%	RMC1/16S 221JTH	J24189017		1-	A	A5
R 1291	CHIP RES.	0	1/16W	5%	RMC1/16S JPTH	J24189070		1-	A	A4
R 1300	CHIP RES.	4.7k	1/16W	5%	RMC1/16S 472JTH	J24189033		1-	B	c1
R 1300	CHIP RES.	220	1/16W	5%	RMC1/16S 221JTH	J24189017		3-	B	c1
R 1301	CHIP RES.	1k	1/16W	5%	RMC1/16S 102JTH	J24189025		1-	B	c1
R 1302	CHIP RES.	1k	1/16W	5%	RMC1/16S 102JTH	J24189025		1-	B	c1
R 1303	CHIP RES.	100k	1/16W	5%	RMC1/16S 104JTH	J24189049		1-	B	c1
R 1304	CHIP RES.	100	1/16W	5%	RMC1/16S 101JTH	J24189013		1-	B	b1
R 1305	CHIP RES.	1k	1/16W	5%	RMC1/16S 102JTH	J24189025		1-	B	c1
R 1310	CHIP RES.	1k	1/16W	5%	RMC1/16S 102JTH	J24189025		1-	B	c1
R 1311	CHIP RES.	47k	1/16W	5%	RMC1/16S 473JTH	J24189045		1-	B	c2
R 1312	CHIP RES.	0	1/16W	5%	RMC1/16S JPTH	J24189070		1-	B	c2
R 1314	CHIP RES.	47	1/16W	5%	RMC1/16S 470JTH	J24189009		1-	B	c2
R 1315	CHIP RES.	47k	1/16W	5%	RMC1/16S 473JTH	J24189045		1-	B	c2
R 1316	CHIP RES.	0	1/16W	5%	RMC1/16S JPTH	J24189070		1-	B	c2
R 1317	CHIP RES.	100	1/16W	5%	RMC1/16S 101JTH	J24189013		1-	B	c2
R 1318	CHIP RES.	0	1/16W	5%	RMC1/16S JPTH	J24189070		1-	B	c2
R 1319	CHIP RES.	100k	1/16W	5%	RMC1/16S 104JTH	J24189049		1-	B	c2
R 1320	CHIP RES.	100k	1/16W	5%	RMC1/16S 104JTH	J24189049		1-	B	c2
R 1321	CHIP RES.	100k	1/16W	5%	RMC1/16S 104JTH	J24189049		1-	B	c2
R 1322	CHIP RES.	470	1/16W	5%	RMC1/16S 471JTH	J24189021		1-	B	c2
R 1323	CHIP RES.	470	1/16W	5%	RMC1/16S 471JTH	J24189021		1-	B	b2
R 1324	CHIP RES.	2.2k	1/16W	5%	RMC1/16S 222JTH	J24189029		1-	B	c1
R 1325	CHIP RES.	1k	1/16W	5%	RMC1/16S 102JTH	J24189025		1-	B	c2
R 1326	CHIP RES.	2.2k	1/16W	5%	RMC1/16S 222JTH	J24189029		1-	B	b2
R 1327	CHIP RES.	2.2k	1/16W	5%	RMC1/16S 222JTH	J24189029		1-	B	b2
R 1328	CHIP RES.	2.2k	1/16W	5%	RMC1/16S 222JTH	J24189029		1-	A	B5
R 1331	CHIP RES.	2.2k	1/16W	5%	RMC1/16S 222JTH	J24189029		1-	A	A5
R 1335	CHIP RES.	1k	1/16W	5%	RMC1/16S 102JTH	J24189025		1-	A	C4
R 1336	CHIP RES.	330k	1/16W	5%	RMC1/16S 334JTH	J24189055		1-	A	C5
R 1337	CHIP RES.	1k	1/16W	5%	RMC1/16S 102JTH	J24189025		1-	A	C4
R 1338	CHIP RES.	330k	1/16W	5%	RMC1/16S 334JTH	J24189055		1-	A	C5
R 1339	CHIP RES.	10k	1/16W	5%	RMC1/16S 103JTH	J24189037		1-	A	C5
R 1340	CHIP RES.	10k	1/16W	5%	RMC1/16S 103JTH	J24189037		1-	A	C5
R 1341	CHIP RES.	1k	1/16W	5%	RMC1/16S 102JTH	J24189025		1-	A	C4
R 1342	CHIP RES.	10k	1/16W	5%	RMC1/16S 103JTH	J24189037		1-	A	C4
R 1343	CHIP RES.	2.2k	1/16W	5%	RMC1/16S 222JTH	J24189029		1-	A	C4
R 1344	CHIP RES.	2.2k	1/16W	5%	RMC1/16S 222JTH	J24189029		1-	A	C4
R 1345	CHIP RES.	2.2k	1/16W	5%	RMC1/16S 222JTH	J24189029		1-	A	C4
R 1346	CHIP RES.	2.2k	1/16W	5%	RMC1/16S 222JTH	J24189029		1-	A	C4
R 1347	CHIP RES.	100k	1/16W	5%	RMC1/16S 104JTH	J24189049		1-	A	C4
R 1348	CHIP RES.	10k	1/16W	5%	RMC1/16S 103JTH	J24189037		1-	A	A3

MAIN Unit

Parts List

REF	DESCRIPTION	VALUE	V/W	TOL.	MFR'S DESIG	VXSTD P/N	VERS.	LOT	SIDE	LAY ADR
R 1349	CHIP RES.	680	1/16W	5%	RMC1/16S 681JTH	J24189023		1-	A	A3
R 1350	CHIP RES.	560k	1/16W	5%	RMC1/16S 564JTH	J24189058		1-	A	A3
R 1351	CHIP RES.	47k	1/16W	5%	RMC1/16S 473JTH	J24189045		1-	A	B3
R 1352	CHIP RES.	47k	1/16W	5%	RMC1/16S 473JTH	J24189045		1-	A	B3
R 1353	CHIP RES.	10k	1/16W	5%	RMC1/16S 103JTH	J24189037		1-	A	B3
R 1354	CHIP RES.	10k	1/16W	5%	RMC1/16S 103JTH	J24189037		1-	A	B3
R 1355	CHIP RES.	47k	1/16W	5%	RMC1/16S 473JTH	J24189045		1-	A	B3
R 1356	CHIP RES.	47k	1/16W	5%	RMC1/16S 473JTH	J24189045		1-	A	B2
R 1357	CHIP RES.	47k	1/16W	5%	RMC1/16S 473JTH	J24189045		1-	A	B4
R 1358	CHIP RES.	15k	1/16W	5%	RMC1/16S 153JTH	J24189039		1-	A	A4
R 1359	CHIP RES.	150k	1/16W	5%	RMC1/16S 154JTH	J24189051		1-	A	A4
R 1360	CHIP RES.	47k	1/16W	5%	RMC1/16S 473JTH	J24189045		1-	A	A4
R 1361	CHIP RES.	33k	1/16W	5%	RMC1/16S 333JTH	J24189043		1-	A	B4
R 1362	CHIP RES.	10k	1/16W	5%	RMC1/16S 103JTH	J24189037		1-	A	B4
R 1363	CHIP RES.	68k	1/16W	5%	RMC1/16S 683JTH	J24189047		1-	A	B4
R 1364	CHIP RES.	390k	1/16W	5%	RMC1/16S 394JTH	J24189056		1-	A	B4
R 1365	CHIP RES.	390k	1/16W	5%	RMC1/16S 394JTH	J24189056		1-	A	B4
R 1366	CHIP RES.	68k	1/16W	5%	RMC1/16S 683JTH	J24189047		1-	A	B4
R 1367	CHIP RES.	390k	1/16W	5%	RMC1/16S 394JTH	J24189056		1-	A	B4
R 1368	CHIP RES.	390k	1/16W	5%	RMC1/16S 394JTH	J24189056		1-	A	B4
R 1369	CHIP RES.	12k	1/16W	5%	RMC1/16S 123JTH	J24189038		1-	A	B4
R 1370	CHIP RES.	47k	1/16W	5%	RMC1/16S 473JTH	J24189045		1-	A	B4
R 1371	CHIP RES.	10k	1/16W	5%	RMC1/16S 103JTH	J24189037		1-	A	B4
R 1372	CHIP RES.	10k	1/16W	5%	RMC1/16S 103JTH	J24189037		1-	A	B4
R 1373	CHIP RES.	47k	1/16W	5%	RMC1/16S 473JTH	J24189045		1-	A	B3
R 1374	CHIP RES.	10k	1/16W	5%	RMC1/16S 103JTH	J24189037		1-	A	A4
R 1375	CHIP RES.	680	1/16W	5%	RMC1/16S 681JTH	J24189023		1-	A	B4
R 1376	CHIP RES.	100	1/16W	5%	RMC1/16S 101JTH	J24189013		1-	A	A2
R 1377	CHIP RES.	4.7k	1/16W	5%	RMC1/16S 472JTH	J24189033		1-	A	A5
R 1378	CHIP RES.	0	1/16W	5%	RMC1/16S JPTH	J24189070		1-4		
S 1001	TACT SWITCH				SKRWAE030	N5090156		1-	A	A3
S 1002	TACT SWITCH				SKRWAE030	N5090156		1-	A	A3
S 1003	TACT SWITCH				SKRWAE030	N5090156		1-	A	A4
S 1004	TACT SWITCH				SKRWAE030	N5090156		1-	A	A4
S 1005	TACT SWITCH				SKRWAE030	N5090156		1-	A	A5
S 1006	TACT SWITCH				SKRWAE030	N5090156		1-	A	B3
S 1007	TACT SWITCH				SKRWAE030	N5090156		1-	A	B3
S 1008	TACT SWITCH				SKRWAE030	N5090156		1-	A	C3
S 1009	TACT SWITCH				SKRWAE030	N5090156		1-	A	C3
S 1010	DETECTION SWITCH				SPPW811203	N4090160		1-	B	a3
S 1011	ROTARY ENCODER				TP70N00E20 RY-8401	Q9000880		1-	B	a1
TH1001	THERMISTOR				ERTJ1VV473J	G9090122		1-	A	C2
X 1001	XTAL XV00117	11.7MHz			11.7MHZ	H0103330A		1-	B	c4
X 1002	XTAL SSP-T7-F	32.768kHz			32.768KHZ	H0103327		1-	A	B2
X 1003	XTAL AT-38	3.579545MHz				3.579545MHZ	H0103403		1-	
XF1001	XTAL FILTER				47S15A 47.25MHZ	H1102411		1-	B	a3
	LIGHT GUIDE ASSY					RA1218800		1-		
	LIGHT GUIDE ASSY					RA121880A		3-		

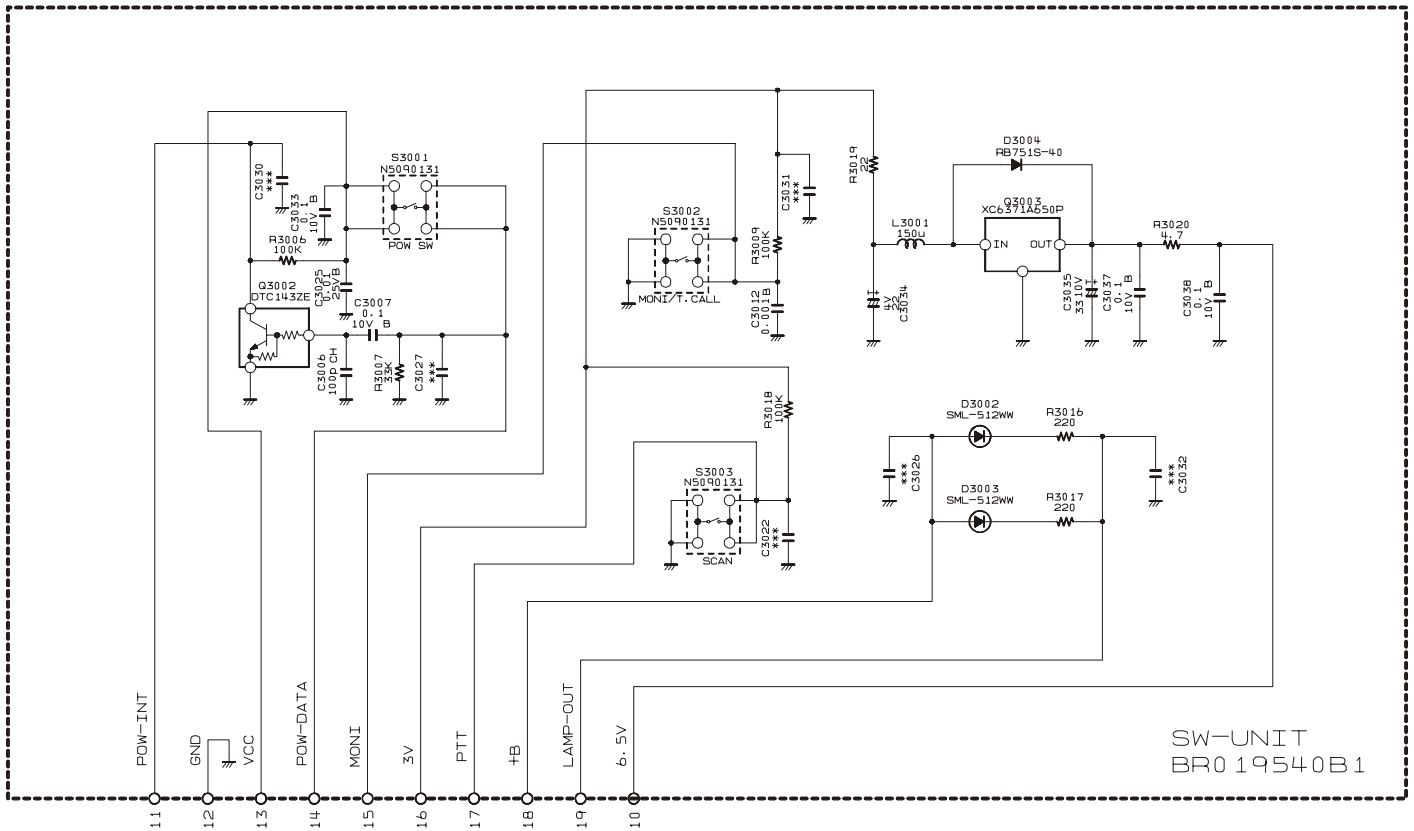

SW Unit

Parts Layout (Side A)

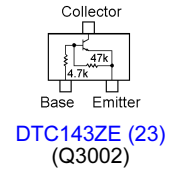
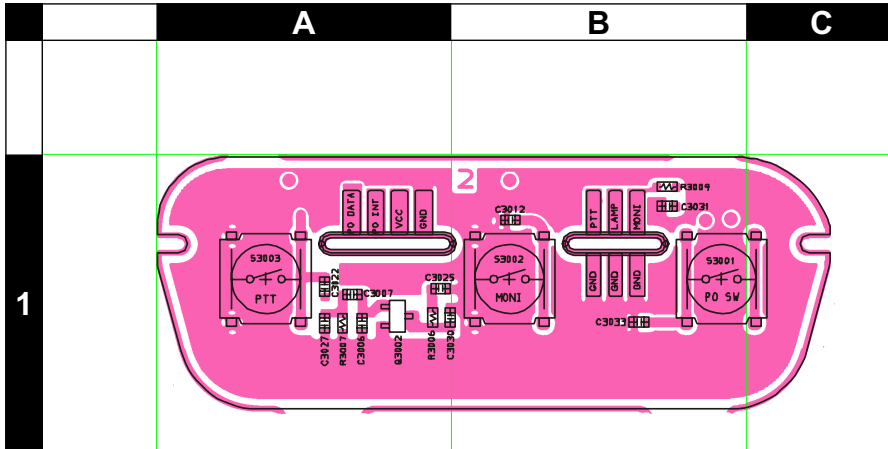

Parts Layout (Side B)

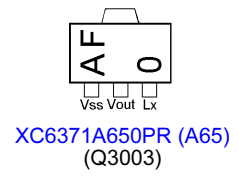
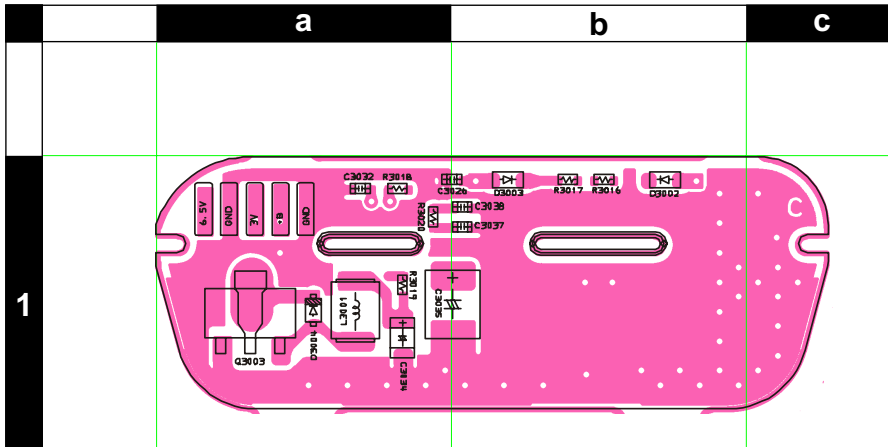

SW Unit

Parts List

REF	DESCRIPTION	VALUE	V/W	TOL.	MFR'S DESIG	VXSTD P/N	VERS.	LOT	SIDE	LAY ADR
	P.C.B. with Components					CS2052101				
	Printed Circuit Board					FR019540C		1-		
C 3006	CHIP CAP.	100pF	50V	CH	UMK105CH101JV-F	K22178282		1-	A	A1
C 3007	CHIP CAP.	0.1uF	10V	B	GRM155B11A104KA01D	K22108802		1-	A	A1
C 3012	CHIP CAP.	0.001uF	50V	B	UMK105B102KW-F	K22178829		1-	A	B1
C 3025	CHIP CAP.	0.01uF	25V	B	GRM155B11E103KA01D	K22148834		1-	A	A1
C 3033	CHIP CAP.	0.1uF	10V	B	GRM155B11A104KA01D	K22108802		1-	A	B1
C 3034	CHIP TA.CAP.	22uF	4V		TEESVP0G226M8R	K78060047		1-	B	a1
C 3035	CHIP TA.CAP.	33uF	10V		TEESVB21A336M8R	K78100047		1-	B	b1
C 3037	CHIP CAP.	0.1uF	10V	B	GRM155B11A104KA01D	K22108802		1-	B	b1
C 3038	CHIP CAP.	0.1uF	10V	B	GRM155B11A104KA01D	K22108802		1-	B	b1
D 3002	LED				SML-512WWT86	G2071104		1-	B	b1
D 3003	LED				SML-512WWT86	G2071104		1-	B	b1
D 3004	DIODE				RB751S-40TE61	G2070850		1-	B	a1
L 3001	M.RFC	150uH			FLC32P-T-151K	L1690661		1-	B	a1
Q 3002	TRANSISTOR				DTC143ZE TL	G3070102		1-	A	A1
Q 3003	IC				XC6371A650PR	G1094017		1-	B	a1
R 3006	CHIP RES.	100k	1/16W	5%	RMC1/16S 104JTH	J24189049		1-	A	A1
R 3007	CHIP RES.	33k	1/16W	5%	RMC1/16S 333JTH	J24189043		1-	A	A1
R 3009	CHIP RES.	100k	1/16W	5%	RMC1/16S 104JTH	J24189049		1-	A	B1
R 3016	CHIP RES.	220	1/16W	5%	RMC1/16S 221JTH	J24189017		1-	B	b1
R 3017	CHIP RES.	220	1/16W	5%	RMC1/16S 221JTH	J24189017		1-	B	b1
R 3018	CHIP RES.	100k	1/16W	5%	RMC1/16S 104JTH	J24189049		1-	B	a1
R 3019	CHIP RES.	22	1/16W	5%	RMC1/16S 220JTH	J24189005		1-	B	a1
R 3020	CHIP RES.	4.7	1/16W	5%	RMC1/16S 4R7JTH	J24189066		1-	B	a1
S 3001	TACT SWITCH				SOT-152HST	N5090131		1-	A	B1
S 3002	TACT SWITCH				SOT-152HST	N5090131		1-	A	B1
S 3003	TACT SWITCH				SOT-152HST	N5090131		1-	A	A1

SW Unit

Note

VCO Unit

Circuit Diagram

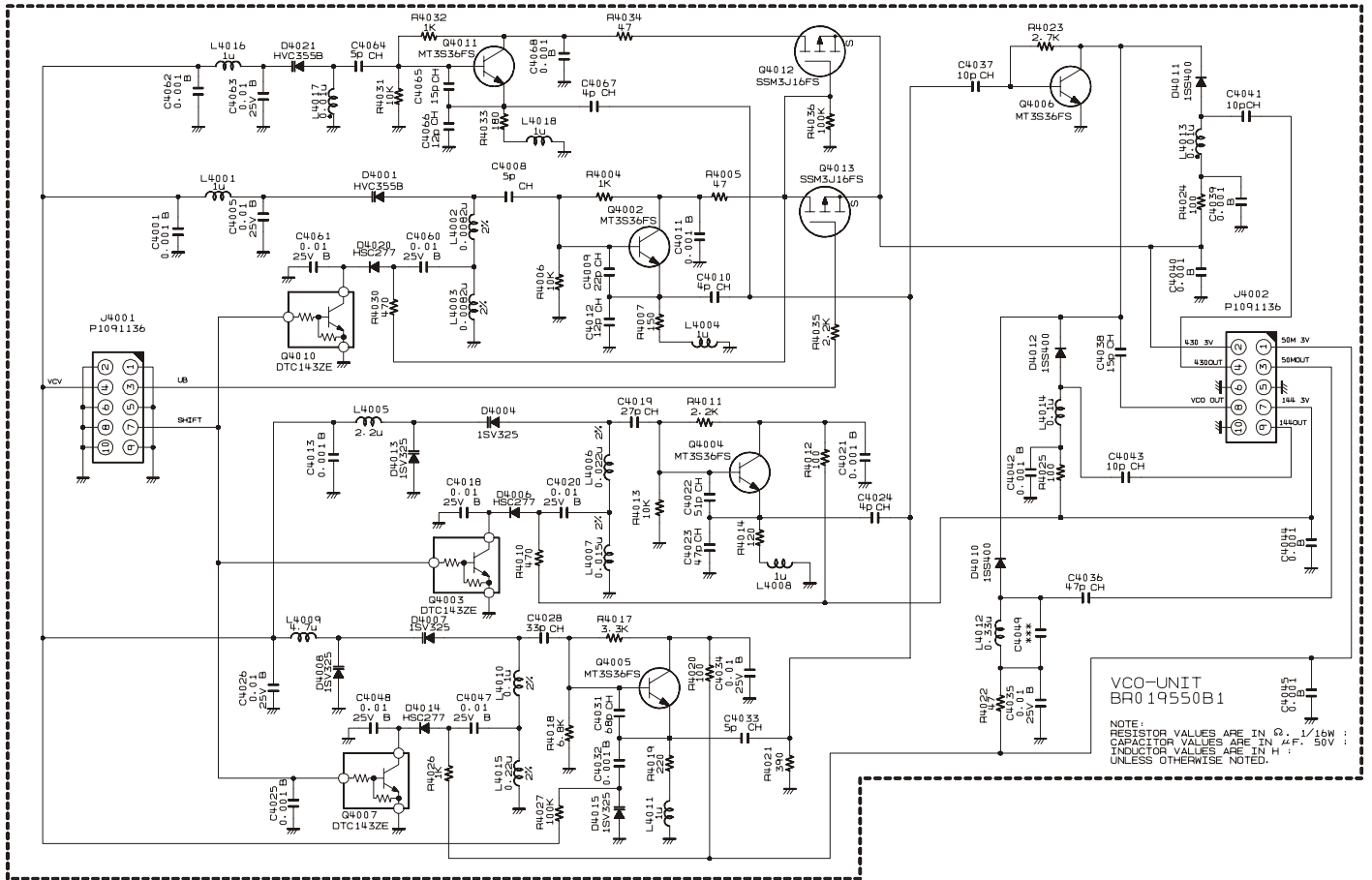

VCO Unit

Parts Layout (Side A)

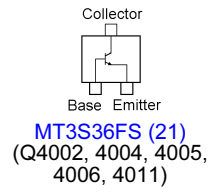
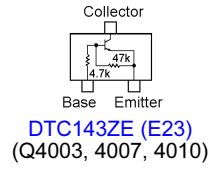
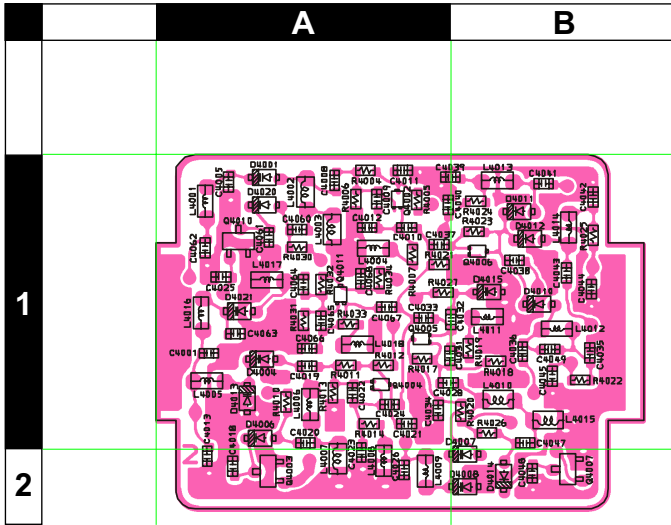

Parts Layout (Side B)

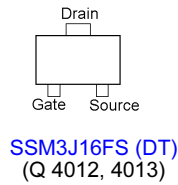
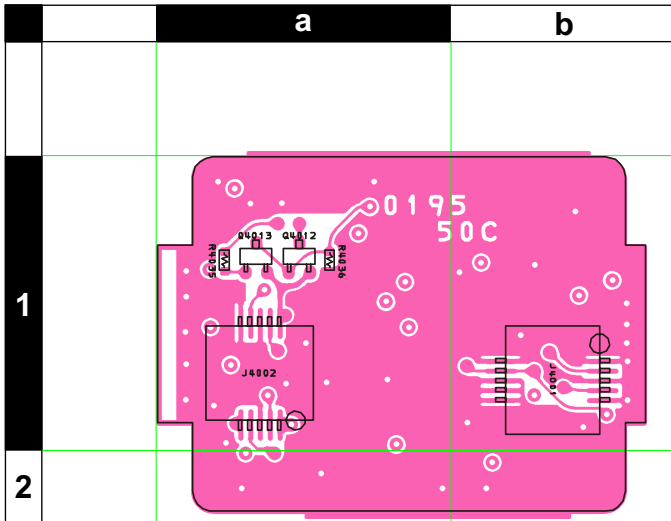

VCO Unit

Parts List

REF	DESCRIPTION	VALUE	V/W	TOL.	MFR'S DESIG	VXSTD P/N	VERS.	LOT	SIDE	LAY ADR
	P.C.B. with Components					CB4782001				
	Printed Circuit Board					FR019550C		1-		
C 4001	CHIP CAP.	0.001uF	50V	B	UMK105B102KW-F	K22178829		1-	A	A1
C 4005	CHIP CAP.	0.01uF	25V	B	GRM155B11E103KA01D	K22148834		1-	A	A1
C 4008	CHIP CAP.	5pF	50V	CH	GRM1552C1H5R0BZ01D	K22178292		1-	A	A1
C 4009	CHIP CAP.	22pF	50V	CH	GRM1552C1H220GZ01D	K22179707		1-	A	A1
C 4010	CHIP CAP.	4pF	50V	CH	UMK105CH040CV-F	K22178252		1-	A	A1
C 4011	CHIP CAP.	0.001uF	50V	B	UMK105B102KW-F	K22178829		1-	A	A1
C 4012	CHIP CAP.	12pF	50V	CH	GRM1552C1H120JZ01D	K22178214		1-	A	A1
C 4013	CHIP CAP.	0.001uF	50V	B	UMK105B102KW-F	K22178829		1-	A	A2
C 4018	CHIP CAP.	0.01uF	25V	B	GRM155B11E103KA01D	K22148834		1-	A	A2
C 4019	CHIP CAP.	27pF	50V	CH	GRM1552C1H270JZ01D	K22178222		1-	A	A1
C 4020	CHIP CAP.	0.01uF	25V	B	GRM155B11E103KA01D	K22148834		1-	A	A1
C 4021	CHIP CAP.	0.001uF	50V	B	UMK105B102KW-F	K22178829		1-	A	A1
C 4022	CHIP CAP.	51pF	50V	CH	GRM1552C1H510GZ01D	K22179710		1-	A	A1
C 4023	CHIP CAP.	47pF	50V	CH	GRM1552C1H470GZ01D	K22179709		1-	A	A2
C 4024	CHIP CAP.	4pF	50V	CH	UMK105CH040CV-F	K22178252		1-	A	A1
C 4025	CHIP CAP.	0.001uF	50V	B	UMK105B102KW-F	K22178829		1-	A	A1
C 4026	CHIP CAP.	0.01uF	25V	B	GRM155B11E103KA01D	K22148834		1-	A	A2
C 4028	CHIP CAP.	33pF	50V	CH	UMK105CH330JV-F	K22178270		1-	A	A1
C 4031	CHIP CAP.	68pF	50V	CH	UMK105CH680JV-F	K22178278		1-	A	A1
C 4032	CHIP CAP.	0.001uF	50V	B	UMK105B102KW-F	K22178829		1-	A	A1
C 4033	CHIP CAP.	5pF	50V	CH	UMK105CH050CV-F	K22178253		1-	A	A1
C 4034	CHIP CAP.	0.01uF	25V	B	GRM155B11E103KA01D	K22148834		1-	A	A1
C 4035	CHIP CAP.	0.01uF	25V	B	GRM155B11E103KA01D	K22148834		1-	A	B1
C 4036	CHIP CAP.	47pF	50V	CH	UMK105CH470JV-F	K22178274		1-	A	B1
C 4037	CHIP CAP.	10pF	50V	CH	UMK105CH100DV-F	K22178258		1-	A	A1
C 4038	CHIP CAP.	15pF	50V	CH	UMK105CH150JV-F	K22178262		1-	A	B1
C 4039	CHIP CAP.	0.001uF	50V	B	UMK105B102KW-F	K22178829		1-	A	A1
C 4040	CHIP CAP.	0.001uF	50V	B	UMK105B102KW-F	K22178829		1-	A	A1
C 4041	CHIP CAP.	10pF	50V	CH	UMK105CH100DV-F	K22178258		1-	A	B1
C 4042	CHIP CAP.	0.001uF	50V	B	UMK105B102KW-F	K22178829		1-	A	B1
C 4043	CHIP CAP.	10pF	50V	CH	UMK105CH100DV-F	K22178258		1-	A	B1
C 4044	CHIP CAP.	0.001uF	50V	B	UMK105B102KW-F	K22178829		1-	A	B1
C 4045	CHIP CAP.	0.001uF	50V	B	UMK105B102KW-F	K22178829		1-	A	B1
C 4047	CHIP CAP.	0.01uF	25V	B	GRM155B11E103KA01D	K22148834		1-	A	B1
C 4048	CHIP CAP.	0.01uF	25V	B	GRM155B11E103KA01D	K22148834		1-	A	B2
C 4060	CHIP CAP.	0.01uF	25V	B	GRM155B11E103KA01D	K22148834		1-	A	A1
C 4061	CHIP CAP.	0.01uF	25V	B	GRM155B11E103KA01D	K22148834		1-	A	A1
C 4062	CHIP CAP.	0.001uF	50V	B	UMK105B102KW-F	K22178829		1-	A	A1
C 4063	CHIP CAP.	0.01uF	25V	B	GRM155B11E103KA01D	K22148834		1-	A	A1
C 4064	CHIP CAP.	5pF	50V	CH	GRM1552C1H5R0BZ01D	K22178292		1-	A	A1
C 4065	CHIP CAP.	15pF	50V	CH	GRM1552C1H150JZ01D	K22178216		1-	A	A1
C 4066	CHIP CAP.	12pF	50V	CH	GRM1552C1H120JZ01D	K22178214		1-	A	A1
C 4067	CHIP CAP.	4pF	50V	CH	UMK105CH040CV-F	K22178252		1-	A	A1
C 4068	CHIP CAP.	0.001uF	50V	B	UMK105B102KW-F	K22178829		1-	A	A1
D 4001	DIODE				HVC355B TRF-E	G2070588		1-	A	A1
D 4004	DIODE				1SV325(TPH3.F)	G2070848		1-	A	A1
D 4006	DIODE				HSC277TRF-E	G2070584		1-	A	A1
D 4007	DIODE				1SV325(TPH3.F)	G2070848		1-	A	A2
D 4008	DIODE				1SV325(TPH3.F)	G2070848		1-	A	A2
D 4010	DIODE				1SS400 TE61	G2070634		1-	A	B1
D 4011	DIODE				1SS400 TE61	G2070634		1-	A	B1
D 4012	DIODE				1SS400 TE61	G2070634		1-	A	B1
D 4013	DIODE				1SV325(TPH3.F)	G2070848		1-	A	A1
D 4014	DIODE				HSC277TRF-E	G2070584		1-	A	B2
D 4015	DIODE				1SV325(TPH3.F)	G2070848		1-	A	B1
D 4020	DIODE				HSC277TRF-E	G2070584		1-	A	A1
D 4021	DIODE				HVC355B TRF-E	G2070588		1-	A	A1
J 4001	CONNECTOR				AXK5F10335YP	P1091136		1-	B	b1
J 4002	CONNECTOR				AXK5F10335YP	P1091136		1-	B	a1
L 4001	M.RFC	1uH			LK1608 1R0K-T	L1690687		1-	A	A1
L 4002	M.RFC	0.0082uH		2%	C1608CB-8N2G-RF	L1691226		1-	A	A1
L 4003	M.RFC	0.0082uH		2%	C1608CB-8N2G-RF	L1691226		1-	A	A1
L 4004	M.RFC	1uH			LK1608 1R0K-T	L1690687		1-	A	A1
L 4005	M.RFC	2.2uH			LK1608 2R2K-T	L1690634		1-	A	A1
L 4006	CHIP COIL	0.022uH		2%	LQW18AN22NG00D	L1690884		1-	A	A1
L 4007	M.RFC	0.015uH		2%	C1608CB-15NG-RF	L1691034		1-	A	A2
L 4008	M.RFC	1uH			LK1608 1R0K-T	L1690687		1-	A	A2
L 4009	M.RFC	4.7uH			LK1608 4R7K-T	L1690688		1-	A	A2
L 4010	M.RFC	0.1uH		2%	C1608CB-R10G-RF	L1691045		1-	A	B1
L 4011	M.RFC	1uH			LK1608 1R0K-T	L1690687		1-	A	B1
L 4012	M.RFC	0.33uH			LK1608 R33K-T	L1690412		1-	A	B1

VCO Unit

Parts List

REF	DESCRIPTION	VALUE	V/W	TOL.	MFR'S DESIG	VXSTD P/N	VERS.	LOT	SIDE	LAY ADR
L 4013	M.RFC	0.01uH			HK1608 10NJ-T	L1690516		1-	A	B1
L 4014	M.RFC	0.1uH			LK1608 R10K-T	L1690407		1-	A	B1
L 4015	M.RFC	0.22uH		2%	C1608CB-R22G-RF	L1691103		1-	A	B1
L 4016	M.RFC	1uH			LK1608 1R0K-T	L1690687		1-	A	A1
L 4017	M.RFC	0.0082uH		2%	C1608CB-8N2G-RF	L1691226		1-	A	A1
L 4018	M.RFC	1uH			LK1608 1R0K-T	L1690687		1-	A	A1
Q 4002	TRANSISTOR				MT3S36FS(TE85L.F)	G3070377		1-	A	A1
Q 4003	TRANSISTOR				DTC143ZE TL	G3070102		1-	A	A2
Q 4004	TRANSISTOR				MT3S36FS(TE85L.F)	G3070377		1-	A	A1
Q 4005	TRANSISTOR				MT3S36FS(TE85L.F)	G3070377		1-	A	A1
Q 4006	TRANSISTOR				MT3S36FS(TE85L.F)	G3070377		1-	A	B1
Q 4007	TRANSISTOR				DTC143ZE TL	G3070102		1-	A	B2
Q 4010	TRANSISTOR				DTC143ZE TL	G3070102		1-	A	A1
Q 4011	TRANSISTOR				MT3S36FS(TE85L.F)	G3070377		1-	A	A1
Q 4012	FET				SSM3J16FS	G3070429		1-	B	a1
Q 4013	FET				SSM3J16FS	G3070429		1-	B	a1
R 4004	CHIP RES.	1k	1/16W	5%	RMC1/16S 102JTH	J24189025		1-	A	A1
R 4005	CHIP RES.	47	1/16W	5%	RMC1/16S 470JTH	J24189009		1-	A	A1
R 4006	CHIP RES.	10k	1/16W	5%	RMC1/16S 103JTH	J24189037		1-	A	A1
R 4007	CHIP RES.	150	1/16W	5%	RMC1/16S 151JTH	J24189015		1-	A	A1
R 4010	CHIP RES.	470	1/16W	5%	RMC1/16S 471JTH	J24189021		1-	A	A1
R 4011	CHIP RES.	2.2k	1/16W	5%	RMC1/16S 222JTH	J24189029		1-	A	A1
R 4012	CHIP RES.	100	1/16W	5%	RMC1/16S 101JTH	J24189013		1-	A	A1
R 4013	CHIP RES.	10k	1/16W	5%	RMC1/16S 103JTH	J24189037		1-	A	A1
R 4014	CHIP RES.	120	1/16W	5%	RMC1/16S 121JTH	J24189014		1-	A	A1
R 4017	CHIP RES.	3.3k	1/16W	5%	RMC1/16S 332JTH	J24189031		1-	A	A1
R 4018	CHIP RES.	6.8k	1/16W	5%	RMC1/16S 682JTH	J24189035		1-	A	B1
R 4019	CHIP RES.	220	1/16W	5%	RMC1/16S 221JTH	J24189017		1-	A	A1
R 4020	CHIP RES.	100	1/16W	5%	RMC1/16S 101JTH	J24189013		1-	A	A1
R 4021	CHIP RES.	390	1/16W	5%	RMC1/16S 391JTH	J24189020		1-	A	A1
R 4022	CHIP RES.	47	1/16W	5%	RMC1/16S 470JTH	J24189009		1-	A	B1
R 4023	CHIP RES.	2.7k	1/16W	5%	RMC1/16S 272JTH	J24189030		1-	A	B1
R 4024	CHIP RES.	100	1/16W	5%	RMC1/16S 101JTH	J24189013		1-	A	B1
R 4025	CHIP RES.	100	1/16W	5%	RMC1/16S 101JTH	J24189013		1-	A	B1
R 4026	CHIP RES.	1k	1/16W	5%	RMC1/16S 102JTH	J24189025		1-	A	B1
R 4027	CHIP RES.	100k	1/16W	5%	RMC1/16S 104JTH	J24189049		1-	A	A1
R 4030	CHIP RES.	470	1/16W	5%	RMC1/16S 471JTH	J24189021		1-	A	A1
R 4031	CHIP RES.	10k	1/16W	5%	RMC1/16S 103JTH	J24189037		1-	A	A1
R 4032	CHIP RES.	1k	1/16W	5%	RMC1/16S 102JTH	J24189025		1-	A	A1
R 4033	CHIP RES.	180	1/16W	5%	RMC1/16S 181JTH	J24189016		1-	A	A1
R 4034	CHIP RES.	47	1/16W	5%	RMC1/16S 470JTH	J24189009		1-	A	A1
R 4035	CHIP RES.	2.2k	1/16W	5%	RMC1/16S 222JTH	J24189029		1-	B	a1
R 4036	CHIP RES.	100k	1/16W	5%	RMC1/16S 104JTH	J24189049		1-	B	a1
	SHIELD CASE VCO					RA0400300		1-		

