

# COMMUNICATIONS RECEIVER

## VR-120D

### Technical Supplement

©2002 VERTEX STANDARD CO., LTD. Printed in Japan.

EH011M90A

#### VERTEX STANDARD CO., LTD.

4-8-8 Nakameguro, Meguro-Ku, Tokyo 153-8644, Japan

#### VERTEX STANDARD

##### US Headquarters

17210 Edwards Rd., Cerritos, CA 90703, U.S.A.

##### International Division

8350 N.W. 52nd Terrace, Suite 201, Miami, FL 33166, U.S.A.

#### YAESU EUROPE B.V.

P.O. Box 75525, 1118 ZN Schiphol, The Netherlands

#### YAESU UK LTD.

Unit 12, Sun Valley Business Park, Winnall Close  
Winchester, Hampshire, SO23 0LB, U.K.

#### VERTEX STANDARD HK LTD.

Unit 5, 20/F., Seaview Centre, 139-141 Hoi Bun Road,  
Kwun Tong, Kowloon, Hong Kong

### Introduction

This manual provides technical information necessary for servicing the Yaesu VR-120D Communications Receiver. Information on its installation and operation can be found in the VR-120D Operating Manual, which is provided with the receiver, and Accessory information may be found in the documents accompanying the optional equipment.

The VR-120D is a high-performance miniature communications receiver providing general coverage reception from 100 kHz to 1300 MHz on the AM, and FM (Wide and Narrow bandwidths) modes (this coverage includes the AM and FM broadcast bands, HF Short-wave Bands up to 16 MHz, VHF and UHF TV bands, the VHF AM aircraft band, and a wide range of commercial and public safety frequencies!).

Servicing this equipment requires expertise in handling surface mount chip components. Attempts by unqualified persons to service this equipment may result in permanent damage not covered by warranty. For the major circuit boards, each side of the board is identified by the type of the majority of components installed on that side. In most cases one side has only chip components, and the other has either a mixture of both chip and lead components (trimmers, coils, electrolytic capacitors, packaged ICs, etc.), or lead components only.



While we believe the technical information in this manual is correct, VERTEX STANDARD assumes no liability for damage that may occur as a result of typographical or other errors that may be present. Your cooperation in pointing out any inconsistencies in the technical information would be appreciated. VERTEX STANDARD reserves the right to make changes in this receiver and the alignment procedures, in the interest of technological improvement, without notification of owners.

## Contents

<b>Specifications</b> .....	<b>2</b>
<b>Exploded View &amp; Miscellaneous Parts</b> .....	<b>3</b>
<b>Circuit Description</b> .....	<b>5</b>
<b>Alignment</b> .....	<b>7</b>
<b>Block Diagram</b> .....	<b>13</b>
<b>Board Unit (Schematics, Layouts &amp; Parts)</b>	
CNTL·AF Unit .....	15
RF Unit .....	23

# Alignment

*Note:*

# Specifications

<b>Frequency Range:</b>	USA: 100 kHz ~ 1299.995 MHz (Cellular Blocked) EXP: 100 kHz ~ 1299.995 MHz (Frequency range is varied per local law. Ask your YAESU dealer for details for frequency range in your country.)
<b>Receiving Mode:</b>	AM/FM/WFM
<b>Circuit Type:</b>	Triple Super-heterodyne
<b>Memory Channels:</b>	640 Channels
<b>Memory Bank:</b>	10 Banks (@ 64 Channels)
<b>Antenna Impedance:</b>	50-ohm unbalanced, BNC receptacle
<b>Intermediate Frequencies:</b>	248.45 MHz, 15 MHz, 450 kHz
<b>Sensitivity (Typical):</b>	200kHz ~ 5 MHz: AM 3.5 dB $\mu$ (1.5 $\mu$ V) 5 ~ 160 MHz: AM -4.4 dB $\mu$ (0.6 $\mu$ V) FM -10.4 dB $\mu$ (0.3 $\mu$ V) WFM-1.0 dB $\mu$ (0.9 $\mu$ V) 160 ~ 370 MHz: AM -4.4 dB $\mu$ (0.6 $\mu$ V) FM -10.4 dB $\mu$ (0.3 $\mu$ V) WFM-4.4 dB $\mu$ (0.6 $\mu$ V) 370 ~ 520 MHz: FM -10.4 dB $\mu$ (0.3 $\mu$ V) WFM0 dB $\mu$ (1.0 $\mu$ V) 520 ~ 1300 MHz: FM -3.0 dB $\mu$ (0.7 $\mu$ V) WFM9.5 dB $\mu$ (3.0 $\mu$ V)
<b>Selectivity:</b>	WFM: 200 kHz/-6 dB AM/FM: 16 kHz/-6 dB
<b>Conducted Spurious Emission:</b>	Less than -54 dBm
<b>Supply Voltage:</b>	2.2 ~ 3.5 V DC; Internal Battery (Nominal: 3.0 V DC) 5.5 ~ 10.0 V DC (EXT DC)
<b>Current Consumption:</b>	Approx. 95 mA (Receive, AF Output 50 mW, 8-ohm) Approx. 15 mA (Standby, Saver 1:4 on) Approx. 55 mA (Standby, Saver off)
<b>Operating Temp.:</b>	-10 °C ~ +50 °C
<b>AF Output:</b>	Approx. 80 mW (8-ohm)
<b>Case Size:</b>	85 x 59 x 26 mm (H x W x D) w/o knob
<b>Weight:</b>	Approx. 195 g w/battery & antenna

*Specifications are subject to change without notice.*

# Exploded View & Miscellaneous Parts

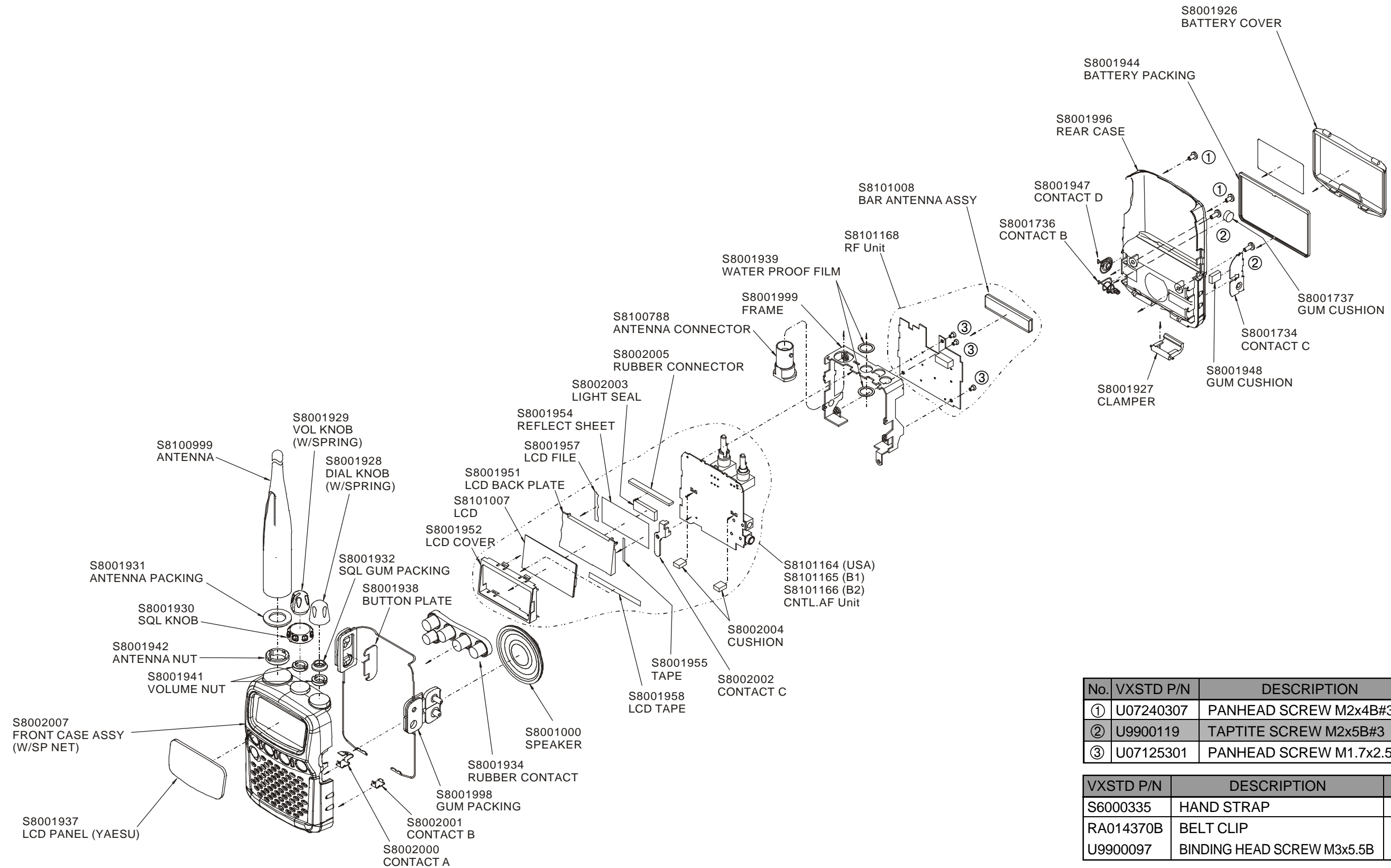

No.	VXSTD P/N	DESCRIPTION	QTY.
①	U07240307	PANHEAD SCREW M2x4B#3	2
②	U9900119	TAPTITE SCREW M2x5B#3	2
③	U07125301	PANHEAD SCREW M1.7x2.5#3	3

VXSTD P/N	DESCRIPTION	QTY.
S6000335	HAND STRAP	1
RA014370B	BELT CLIP	1
U9900097	BINDING HEAD SCREW M3x5.5B	1

## **Exploded View & Miscellaneous Parts**

*Note:*

# Circuit Description

**VR-120D** separates into two substrate blocks. It is RF unit and **CNTL•AF unit**.

ATT, ANT band path filter, bar ANT for AM, RFAMP, 1st•2ndMIX, 2ndIF-AMP, 3rdIF-DETC, PLL, 1st•2nd-VCO, AMDET circuit are had by the RF unit. Also, the **CNTL•AF unit** has a CPU, LCD, a power, AUDIO circuit, EEPROM.

## **RF Unit**

The signal which entered from ANT is stored in the band path filter below the entering to the ATT circuit.

It is amplified by RF-AMP Q216, Q217 which is common after the band path filter passage.

The amplified RF signal entry to 1st-MIX Q218 (**μPC2757T**) with the 1st local signal, it makes a 1st IF signal.

The 1st local oscillator is VCO Q241 (**2SC5006**). and oscillated signal is amplified in the buffering in Q240, Q239 (**2SC5006**).

The 1st-IF signal of 248.45MHz which passed the SAW filter of F202 are input to 2nd-MIX Q219 (**2SC5006**), it mix with the 2nd local signal of 263.45MHz, and makes a 2nd-IF signal.

Amplifying the 2nd-IF in Q220 **2SC4915**, and It detects and it gets a speech signal by IF IC of Q221 (**TA31136FN**).

3rd-IF is 450kHz. The AM detection is Q231 (**UMX2N**), it amplifies 3rd-IF signal and Q232 (**RB520S-30**) detects AM.

2nd-VCO is oscillated by Q229, and it is amplified by Q228.

PLL IC is Q235 (**MB15F02PFV**). It forms 1st and 2nd PLL circuit.

The standard crystal oscillation circuit is Q234 (**2SC4617**), it oscillates 14.55 MHz crystal.

The loop filter for 1st local is Q236 (**2SK1580**), its active type, and the loop filter for 2nd local is passive type by CR.

## **CNTL•AF unit**

The detected signal from the RF substrate, which is amplified by Q130 (**UMX2N**), and volume controlled signal amplified by Q123 (**TA31056F**), and it outputs a sound from the speaker.

The DC input of 3V, which boosts the voltage to 3.5V by the DC-DC converter Q116 (**XC6371A351PR**). It is stabilized to 3.2V by Q118 (**S-81332HG-KC**).

The main microprocessor is Q101 (**HD643837S**). EEPROM is Q115 (**AT24C64N-10SI1.8**).

The reset IC is Q112 (**RN5VL20AA**).

The 10V boost circuit for RF VCO, which boosts and detects by Q119, Q120, Q121 (**RB706F**).

Q122 (**2SC4617R**) is a ripple filter.

# Circuit Description

*Note:*

## **Introduction**

The **VR-120D** has been carefully aligned at the factory for the specified performance across the amateur band. Realignment should therefore not be necessary except in the event of a component failure. All component replacement and service should be performed only by an authorized Vertex Standard representative, or the warranty policy may be voided.

The following procedures cover the sometimes critical and tedious adjustments that are not normally required once the transceiver has left the factory. However, if damage occurs and some parts are replaced, realignment may be required. If a sudden problem occurs during normal operation, it is likely due to component failure; realignment should not be done until after the faulty component has been replaced.

We recommend that servicing be performed only by authorized Vertex Standard service technicians who are experienced with the circuitry and fully equipped for repair and alignment. Therefore, if a fault is suspected, contact the dealer from whom the transceiver was purchased for instructions regarding repair. Authorized Vertex Standard service technicians realign all circuits and make complete performance checks to ensure compliance with factory specifications after replacing any faulty components. Those who do undertake any of the following alignments are cautioned to proceed at their own risk. Problems caused by unauthorized attempts at realignment are not covered by the warranty policy. Also, Vertex Standard must reserve the right to change circuits and alignment procedures in the interest of improved performance, without notifying owners. Under no circumstances should any alignment be attempted unless the normal function and operation of the transceiver are clearly understood, the cause of the malfunction has been clearly pinpointed and any faulty components replaced, and the need for realignment determined to be absolutely necessary.

## **Required Test Equipment**

The following test equipment (and thorough familiarity with its correct use) is necessary for complete realignment. Correction of problems caused by misalignment resulting from use of improper test equipment is not covered under the warranty policy. While most steps do not require all of the equipment listed, the interactions of some adjustments may require that more complex adjustments be performed afterwards. Do not attempt to perform only a single step unless it is clearly isolated electrically from all other steps. Have all test equipment ready before beginning, and follow all of the steps in a section in the order presented.

- RF Signal Generator with calibrated output level at 1300 MHz
- Deviation Meter
- Frequency Counter:  $\pm 0.1$  ppm accuracy at 500 MHz
- DC Voltmeter: high impedance
- AF Dummy Load: 8-Ohms, 1W

**Note:** *Signal levels in dB referred to in this procedure are based on  $0 \text{ dB}\mu = 0.5 \mu\text{V}$  (closed circuit).*

## **Alignment Preparation & Precautions**

Correct alignment requires that the ambient temperature in the repair shop be the same as that of the receiver and test equipment, and that this temperature be held constant between 20 °C and 30 °C (68° ~ 86° F). When the receiver is brought into the shop from hot or cold air it should be allowed some time for thermal equalization with the environment before alignment. If possible, alignments should be made with oscillator shields and circuit boards firmly affixed in place. Also, the test equipment must be thoroughly warmed up before beginning.



# Alignment

## Test Setup

Set up the test equipment as shown below for receiver alignment.

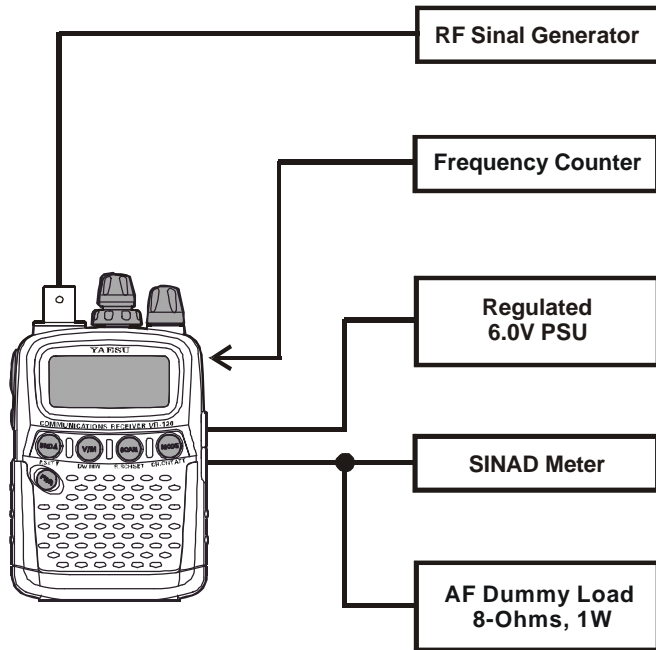

## PLL Reference Frequency Adjustment

- Disable the Battery Save;
  - Press the [SCN] key while press and holding the [FUNC] key.
  - Rotate the DIAL knob to select the display to "SAVE."
  - Rotate the DIAL knob while press and holding the [FUNC] key to change the display to "OFF."
  - Press the [V/M] key to disable the battery saver and exit to normal operation.
- Connect the Frequency Counter to **TP1**, and set the receiver to 100.050 MHz, NFM mode.
- Adjust **C305**, if necessary, so the counter frequency is within  $\pm 200$  Hz of 348.500 MHz.

## RF Voltage

- Connect the DC voltmeter to **TP2**, and confirm DC voltmeter reading 3.05~3.25V.

## VCO VCV

- Connect the DC voltmeter to **TP3**, and referring to table below, tune the VR-120D to each frequency listed.

Then confirm that the correct voltage is present.

Frequency	VCV Voltage
0.500 MHz	0.15V ~ 0.55V
116.455 MHz	6.30V ~ 8.60V
116.550 MHz	0.12V ~ 0.60V
1299.950 MHz	5.40V ~ 6.60V

## FM Discriminator Adjustment

- Connect the AF Milivoltmeter and 8-ohm resistor to the SP jack, and connect the RF Signal generator (SSG) to ANT jack.
- Set the receiver to 100.020 MHz, NFM mode.
- Tune the SSG to 100.200 MHz with  $\pm 3.5$  kHz deviation  $\pm 1$  kHz tone modulation, and set the output level to 60 dB $\mu$ .
- Adjust **L229** for maximum indication on the AF Milivoltmeter.

## SQL Level/S-Meter Adjustment

### Preparation

- Set the receiver to 1250.375 MHz, NFM mode, then disable the OFF-timer function and set the ATT to OFF.
- Press and hold the [SCAN] key for 2 seconds, the rotate the DIAL knob to select the display to "SL."
- Press and hold the [SCAN] key for 2 second while press and holding the [FUNC] key. "LOW W" will appears on the display. Sounds a beep.
- Tune the receiver to 123.125 MHz.
- Press and hold the [SCAN] key for 2 seconds, the rotate the **DIAL knob** to select the display to "SS."
- Press and hold the SCAN key for 2 second while press and holding the [FUNC] key. "ST W" will appears on the display. Sounds a beep.

## Alignment Points

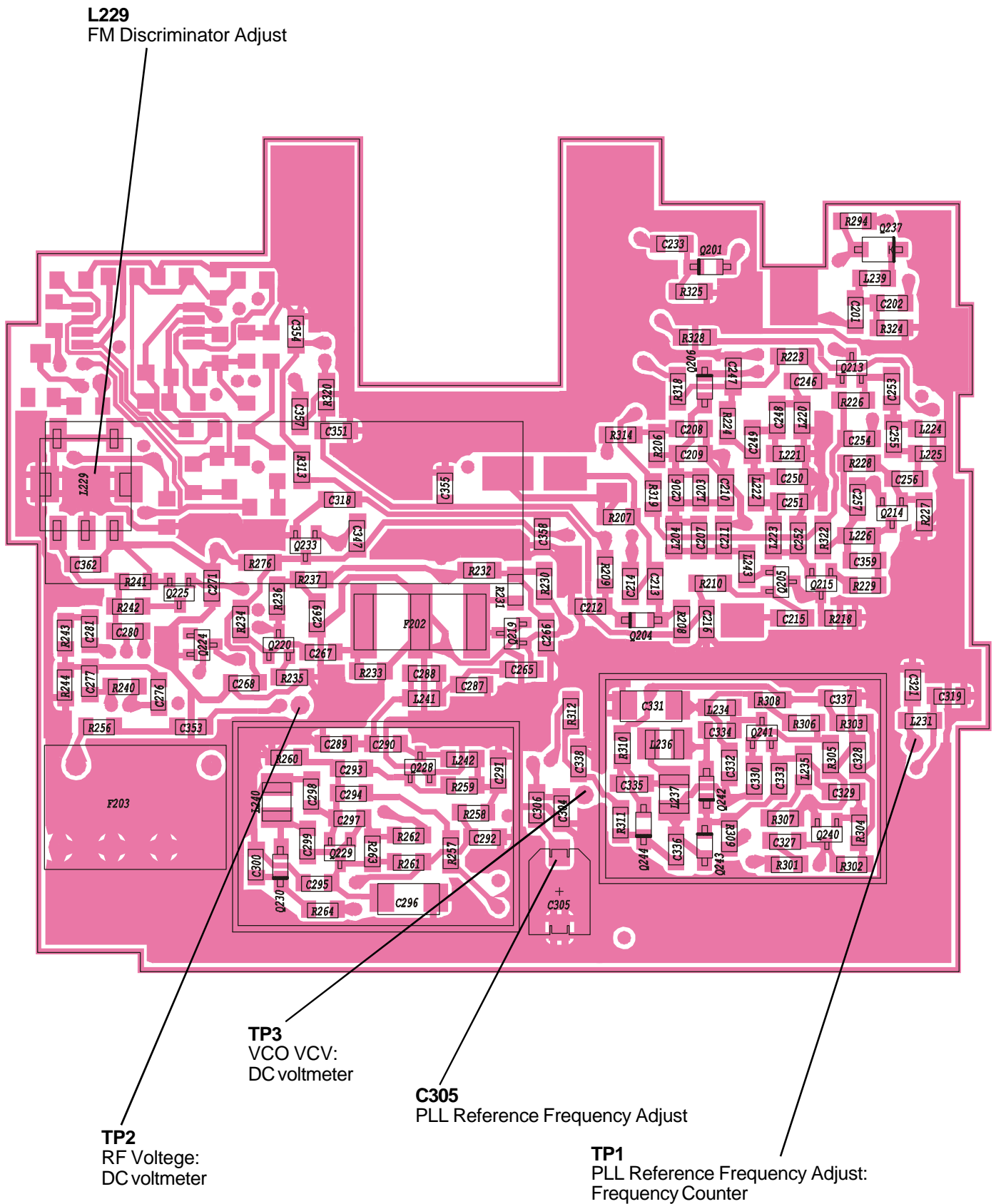

# Alignment

- Tune the receiver to 448.250 MHz.
- Press and hold the [SCAN] key for 2 seconds, then rotate the **DIAL knob** to select the display to "SU."
- Press and hold the [SCAN] key for 2 seconds while press and holding the [FUNC] key. "SQL SET" will appear on the display. Sounds a beep.

## SQL Level Adjustment

### NFM mode:

- Connect the RF Signal Generator to ANT jack.
- Set the receiver to 100.050 MHz, NFM mode.
- Press the [SCAN] key. "SQL" will appear on the display.
- Tune the SSG to 100.050 MHz with  $\pm 3.5$  kHz deviation @1 kHz tone modulation, and set the output level to -12 dB $\mu$ .
- Press the [BND( $\blacktriangle$ )] key while press and holding [FUNC] key. "SQL SL" will appear on the display.
- Press the [V/M] key while press and holding [FUNC] key. Sounds a beep.
- Increase the SSG output level to 2 dB $\mu$ .
- Press the [SCAN] key while press and holding [FUNC] key. "SQL TI" will appear on the display.
- Press the [V/M] key while press and holding [FUNC] key. Sounds a beep.
- Press the [MODE] key while press and holding [FUNC] key. "SQL CR" will appear on the display.
- Press the [V/M] key while press and holding [FUNC] key. Sounds a beep.

### WFM mode:

- Set the receiver to 100.050 MHz, WFM mode.
- Press the [SCAN] key. "SQL" will appear on the display.
- Tune the SSG to 100.050 MHz with  $\pm 75$  kHz deviation @1 kHz tone modulation, and set the output level to 2 dB $\mu$ .
- Press the [BND( $\blacktriangle$ )] key while press and holding [FUNC] key. "SQL SL" will appear on the display.
- Press the [V/M] key while press and holding [FUNC] key. Sounds a beep.

- Increase the SSG output level to 15 dB $\mu$ .
- Press the [SCAN] key while press and holding [FUNC] key. "SQL TI" will appear on the display.
- Press the [V/M] key while press and holding [FUNC] key. Sounds a beep.
- Press the [MODE] key while press and holding [FUNC] key. "SQL CR" will appear on the display.
- Press the [V/M] key while press and holding [FUNC] key. Sounds a beep.

### AM mode:

- Set the receiver to 1.050 MHz, AM mode.
- Press the [SCAN] key. "SQL" will appear on the display.
- Tune the SSG to 1.050 MHz with 30% modulation @1 kHz tone, and set the output level to -5 dB $\mu$ .
- Press the [BND( $\blacktriangle$ )] key while press and holding [FUNC] key. "SQL SL" will appear on the display.
- Press the [V/M] key while press and holding [FUNC] key. Sounds a beep.
- Increase the SSG output level to 8 dB $\mu$ .
- Press the [SCAN] key while press and holding [FUNC] key. "SQL TI" will appear on the display.
- Press the [V/M] key while press and holding [FUNC] key. Sounds a beep.
- Press the [MODE] key while press and holding [FUNC] key. "SQL CR" will appear on the display.
- Press the [V/M] key while press and holding [FUNC] key. Sounds a beep.

## S-Meter Adjustment

### NFM mode:

- Connect the RF Signal Generator to ANT jack.
- Set the receiver to 100.050 MHz, NFM mode.
- Press the [BND( $\blacktriangle$ )]. "S MET" will appear on the display.
- Tune the SSG to 100.050 MHz with  $\pm 3.5$  kHz deviation @1 kHz tone modulation, and set the output level to 20 dB $\mu$ .

- Press the **[BND(▲)]** key while press and holding **[FUNC]** key. "S MET+" will appear on the display.
- Press the **[V/M]** key while press and holding **[FUNC]** key. Sounds a beep.
- Reduce the SSG output level to -5 dB $\mu$ .
- Press the **[SCAN]** key while press and holding **[FUNC]** key. "S MET2" will appear on the display.
- Press the **[V/M]** key while press and holding **[FUNC]** key. Sounds a beep.

## WFM mode:

- Set the receiver to 100.050 MHz, WFM mode.
- Press the **[BND(▲)]**. "S MET" will appear on the display.
- Tune the SSG to 100.050 MHz with  $\pm 75$  kHz deviation @1 kHz tone modulation, and set the output level to 35 dB $\mu$ .
- Press the **[BND(▲)]** key while press and holding **[FUNC]** key. "S MET+" will appear on the display.
- Press the **[V/M]** key while press and holding **[FUNC]** key. Sounds a beep.
- Reduce the SSG output level to 5 dB $\mu$ .
- Press the **[SCAN]** key while press and holding **[FUNC]** key. "S MET2" will appear on the display.
- Press the **[V/M]** key while press and holding **[FUNC]** key. Sounds a beep.

## AM mode:

- Set the receiver to 1.050 MHz, AM mode.
- Press the **[BND(▲)]**. "S MET" will appear on the display.
- Tune the SSG to 1.050 MHz with 30% modulation @1 kHz tone, and set the output level to 20 dB $\mu$ .
- Press the **[BND(▲)]** key while press and holding **[FUNC]** key. "S MET+" will appear on the display.
- Press the **[V/M]** key while press and holding **[FUNC]** key. Sounds a beep.
- Reduce the SSG output level to 0 dB $\mu$ .
- Press the **[SCAN]** key while press and holding **[FUNC]** key. "S MET2" will appear on the display.
- Press the **[V/M]** key while press and holding **[FUNC]** key. Sounds a beep.

Press the **[V/M]** key to save the new setting and exit to the normal operation.

# Block Diagram

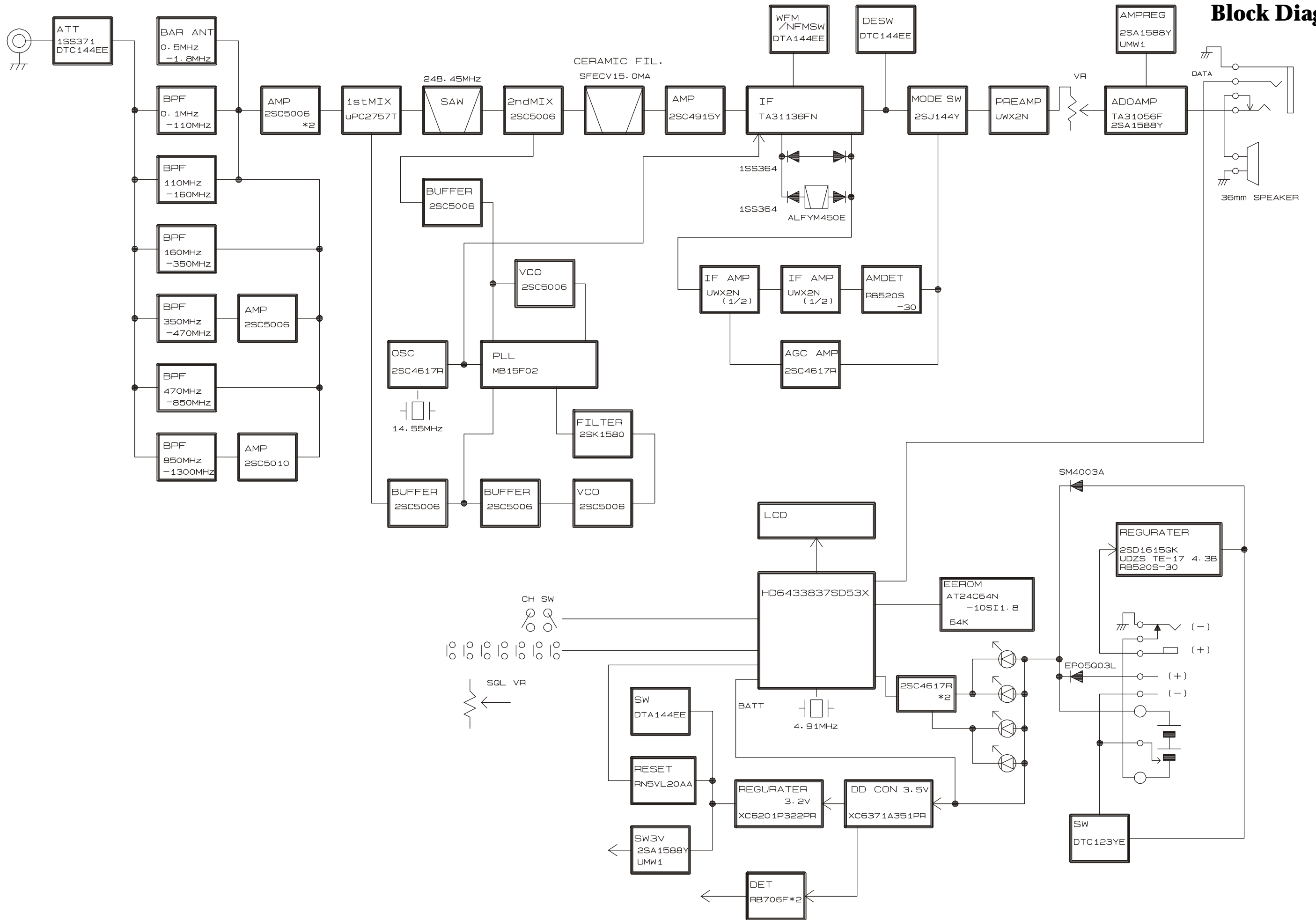

## **Block Diagram**

*Note:*



## **CNTL•AF Unit**

***Note:***



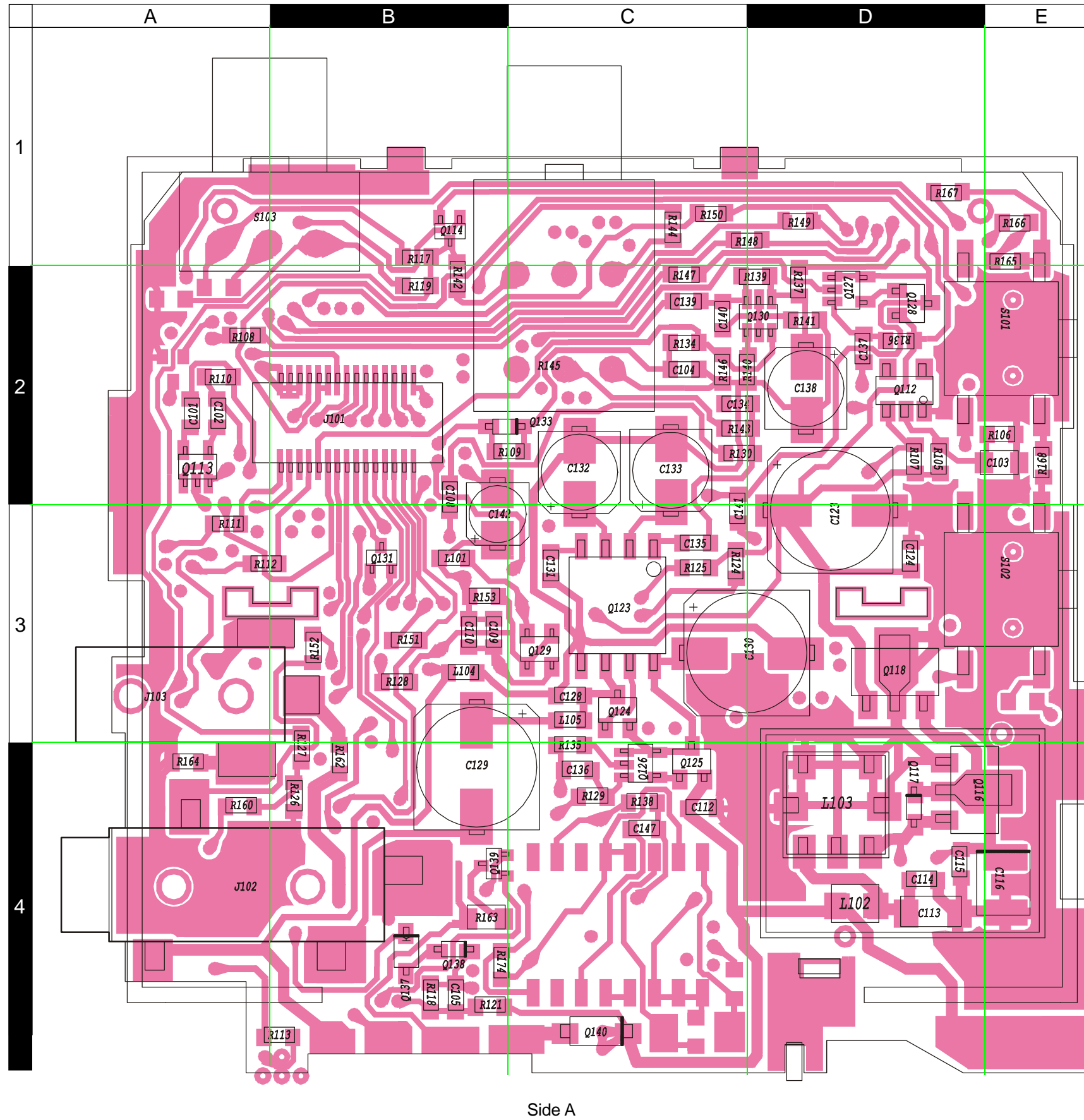

Side A

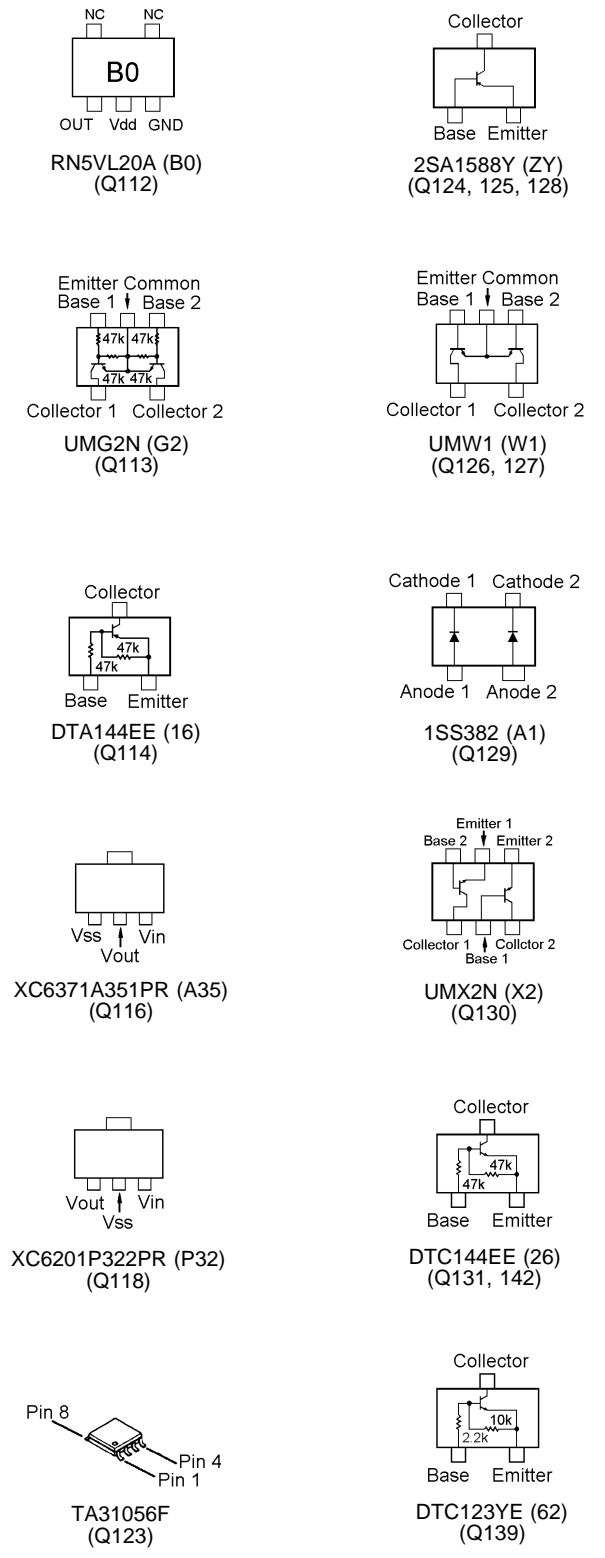



Parts List

REF.	DESCRIPTION	VALUE	V/W	TOL.	MFR'S DESIG	VXSTD P/N	VERS.	LOT.	LAY ADR
	PCB with Component (W/ LCD ASS'Y, SHIELD CASE, CUSHION, CONTACT C)					S8101164	USA		
	PCB with Component (W/ LCD ASS'Y, SHIELD CASE, CUSHION, CONTACT C)					S8101165	B1		
	PCB with Component (W/ LCD ASS'Y, SHIELD CASE, CUSHION, CONTACT C)					S8101166	B2		
C101	CHIP CAP.	47pF	50V	CH	GRM39CH470J50PT	K22174227		1-	
C102	CHIP CAP.	47pF	50V	CH	GRM39CH470J50PT	K22174227		1-	
C103	CHIP CAP.	0.22uF	16V	B	GRM40B224M16PT	K22120806		1-	
C104	CHIP CAP.	0.33uF	10V	B	GRM188B11A334KA01D	K22104802		1-	
C105	CHIP CAP.	0.1uF	16V	B	GRM39B104K16PT	K22124805		1-	
C108	CHIP CAP.	0.001uF	50V	B	GRM39B102K50PT	K22174821		1-	
C109	CHIP CAP.	0.001uF	50V	B	GRM39B102K50PT	K22174821		1-	
C110	CHIP CAP.	0.1uF	16V	B	GRM39B104K16PT	K22124805		1-	
C111	CHIP CAP.	0.001uF	50V	B	GRM39B102K50PT	K22174821		1-	
C112	CHIP CAP.	0.01uF	25V	B	GRM39B103K25PT	K22144803		1-	
C113	CHIP TA.CAP.	10uF	6.3V		TEMSVA0J106M-8R	K78080027		1-	
C114	CHIP CAP.	0.01uF	25V	B	GRM39B103K25PT	K22144803		1-	
C115	CHIP CAP.	0.01uF	25V	B	GRM39B103K25PT	K22144803		1-	
C116	CHIP TA.CAP.	33uF	10V		TEMSVB21A336M-8R	K78100047		1-	
C118	CHIP CAP.	0.1uF	16V	B	GRM39B104K16PT	K22124805		1-	
C119	CHIP CAP.	0.1uF	16V	B	GRM39B104K16PT	K22124805		1-	
C120	CHIP CAP.	0.1uF	16V	B	GRM39B104K16PT	K22124805		1-	
C121	CHIP CAP.	0.1uF	16V	B	GRM39B104K16PT	K22124805		1-	
C122	CHIP CAP.	0.1uF	16V	B	GRM39B104K16PT	K22124805		1-	
C123	CHIP TA.CAP.	220uF	4V		UZS0G221MCR1GB	K48060006		1-	
C124	CHIP CAP.	0.01uF	25V	B	GRM39B103K25PT	K22144803		1-	
C125	CHIP CAP.	0.1uF	16V	B	GRM39B104K16PT	K22124805		1-	
C127	CHIP CAP.	0.1uF	16V	B	GRM39B104K16PT	K22124805		1-	
C128	CHIP CAP.	0.1uF	16V	B	GRM39B104K16PT	K22124805		1-	
C129	CHIP TA.CAP.	220uF	4V		UZS0G221MCR1GB	K48060006		1-	
C130	CHIP TA.CAP.	100uF	6.3V		UZS0J101MCR1GB	K48080009		1-	
C131	CHIP CAP.	100pF	50V	CH	GRM39CH101J50PT	K22174235		1-	
C132	CHIP TA.CAP.	2.2uF	50V		UWX1H2R2MCR1GB	K48170010		1-	
C133	CHIP TA.CAP.	4.7uF	25V		UWX1E4R7MCR1GB	K48140012		1-	
C134	CHIP CAP.	0.027uF	16V	R	GRM39R273K16PT	K22124802		1-	
C135	CHIP CAP.	0.047uF	16V	B	GRM39B473K16PT	K22124804		1-	
C136	CHIP CAP.	0.1uF	16V	B	GRM39B104K16PT	K22124805		1-	
C137	CHIP CAP.	1uF	6.3V	B	GRM39B105K6.3PT	K22084801		1-	
C138	CHIP TA.CAP.	4.7uF	25V		UWX1E4R7MCR1GB	K48140012		1-	
C139	CHIP CAP.	0.1uF	16V	B	GRM39B104K16PT	K22124805		1-	
C140	CHIP CAP.	0.027uF	16V	R	GRM39R273K16PT	K22124802		1-	
C141	CHIP CAP.	1uF	6.3V	B	GRM39B105K6.3PT	K22084801		1-	
C142	AL.ELECTRO.CAP.	10uF	16V		UWX1C100MCR2GB	K48120016		1-	
C145	CHIP CAP.	0.1uF	16V	B	GRM39B104K16PT	K22124805		1-	
E101	SPEAKER				K036NA500-35	S8101000		1-	
J101	CONNECTOR				245047030400856	P1091121		1-	
J102	CONNECTOR				HSJ1501-010010	P1091068		1-	
J103	CONNECTOR				HEC3350-012110	P0091167		1-	
L101	M.RFC				MLF1608A1R0KT	L1690930		1-	
L102	M.RFC				LB2016T4R7M	L1691089		1-	
L103	RF TRANS.				S-167-3779	S8100775		1-	
L104	M.RFC				MLF1608A1R0KT	L1690930		1-	
L105	M.RFC				MLF1608A1R0KT	L1690930		1-	
Q101	IC				HD6433837SD53X	S8101016	USA	1-	b2
Q101	IC				HD6433837SD48X	S8101013	B1	1-	b2
Q101	IC				HD6433837SD48X	S8101013	B2	1-	b2
Q102	DIODE				1SS382(TE85R)	G2070732		1-	c3
Q103	DIODE				1SS382(TE85R)	G2070732		1-	c3
Q104	DIODE				1SS382(TE85R)	G2070732		1-	c3
Q105	LED				AA1111C-640-TR	S8101158		1-	b3
Q106	LED				AA1111C-640-TR	S8101158		1-	d3
Q107	TRANSISTOR				2SC4617 TL R	G3346178R		1-	c2
Q108	LED				CL-220Y-C	G2070830		1-	d1
Q109	LED				CL-220Y-C	G2070830		1-	d2
Q110	TRANSISTOR				2SC4617 TL R	G3346178R		1-	c2
Q112	IC				RN5VL20AA-TR	G1093071		1-	D2
Q113	TRANSISTOR				UMG2N TR	G3070088		1-	A2
Q114	TRANSISTOR				DTA144EE TL	G3070074		1-	B1
Q115	IC				AT24C64N-10SI1.8SL722A	G1093171		1-	b4

# CNTL•AF Unit

REF.	DESCRIPTION	VALUE	V/W	TOL.	MFR'S DESIG	VXSTD P/N	VERS.	LOT.	LAY ADR
Q116	IC				XC6371A351PR	G1093343		1-	D4
Q117	DIODE				RB520S-30TE61	G2070822		1-	D4
Q118	IC				XC6201P322PR	G1093624		1-	D3
Q120	DIODE				RB706F-40T106	G2070824		1-	c4
Q121	DIODE				RB706F-40T106	G2070824		1-	c4
Q123	IC				TA31056F(TP1)	G1093070		1-	C3
Q124	TRANSISTOR				2SA1588Y(TE85L)	G3115888Y		1-	C3
Q125	TRANSISTOR				2SA1588Y(TE85L)	G3115888Y		1-	C4
Q126	TRANSISTOR				UMW1N TR	G3070078		1-	C4
Q127	TRANSISTOR				UMW1N TR	G3070078		1-	D2
Q128	TRANSISTOR				2SA1588Y(TE85L)	G3115888Y		1-	D2
Q129	DIODE				1SS382(TE85R)	G2070732		1-	C3
Q130	TRANSISTOR				UMX2N TR	G3070254		1-	D2
Q131	TRANSISTOR				DTC144EE TL	G3070075		1-	B3
Q132	LCD				MS-6217	S8101005		1-	c2
Q134	DIODE				RB520S-30TE61	G2070822		1-	c4
Q135	DIODE				SM4003A-T	S8101159		1-	b4
Q136	TRANSISTOR				2SD1615-T1 GK	G3416158		1-	a4
Q137	DIODE				UDZS TE-17 4.3B	G2070874		1-	B4
Q138	DIODE				RB520S-30TE61	G2070822		1-	B4
Q139	DIODE				DTC123YE TL	G3070095		1-	B4
Q140	DIODE				EP05Q03L	G2070734		1-	C4
R101	CHIP RES.	4.7	1/16W	5%	RMC1/16 4R7JATP	J24185479		1-	
R102	CHIP RES.	4.7	1/16W	5%	RMC1/16 4R7JATP	J24185479		1-	
R103	CHIP RES.	10k	1/16W	5%	RMC1/16 103JATP	J24185103		1-	
R104	CHIP RES.	6.8k	1/16W	5%	RMC1/16 682JATP	J24185682		1-	
R105	CHIP RES.	47K	1/16W	5%	RMC1/16 473JATP	J24185473		1-	
R106	CHIP RES.	120k	1/16W	5%	RMC1/16 124JATP	J24185124		1-	
R107	CHIP RES.	470k	1/16W	5%	RMC1/16 474JATP	J24185474		1-	
R108	CHIP RES.	2.2k	1/16W	5%	RMC1/16 222JATP	J24185222		1-	
R109	CHIP RES.	47K	1/16W	5%	RMC1/16 473JATP	J24185473		1-	
R110	CHIP RES.	1M	1/16W	5%	RMC1/16 105JATP	J24185105		1-	
R111	CHIP RES.	1k	1/16W	5%	RMC1/16 102JATP	J24185102		1-	
R112	CHIP RES.	1k	1/16W	5%	RMC1/16 102JATP	J24185102		1-	
R113	CHIP RES.	0	1/16W		RMC1/16 000JATP	J24185000	B1	1-	
R114	CHIP RES.	220k	1/16W	5%	RMC1/16 224JATP	J24185224		1-	
R117	CHIP RES.	330k	1/16W	5%	RMC1/16 334JATP	J24185334		1-	
R118	CHIP RES.	470k	1/16W	5%	RMC1/16 474JATP	J24185474		1-	
R119	CHIP RES.	330k	1/16W	5%	RMC1/16 334JATP	J24185334		1-	
R121	CHIP RES.	470k	1/16W	5%	RMC1/16 474JATP	J24185474		1-	
R122	CHIP RES.	1k	1/16W	5%	RMC1/16 102JATP	J24185102		1-	
R123	CHIP RES.	220k	1/16W	5%	RMC1/16 224JATP	J24185224		1-	
R124	CHIP RES.	10k	1/16W	5%	RMC1/16 103JATP	J24185103		1-	
R125	CHIP RES.	10k	1/16W	5%	RMC1/16 103JATP	J24185103		1-	
R126	CHIP RES.	0	1/16W		RMC1/16 000JATP	J24185000		1-	
R128	CHIP RES.	1k	1/16W	5%	RMC1/16 102JATP	J24185102		1-	
R129	CHIP RES.	10k	1/16W	5%	RMC1/16 103JATP	J24185103		1-	
R130	CHIP RES.	1M	1/16W	5%	RMC1/16 105JATP	J24185105		1-	
R131	CHIP RES.	1k	1/16W	5%	RMC1/16 102JATP	J24185102		1-	
R132	CHIP RES.	10k	1/16W	5%	RMC1/16 103JATP	J24185103		1-	
R133	CHIP RES.	4.7k	1/16W	5%	RMC1/16 472JATP	J24185472		1-	
R134	CHIP RES.	150k	1/16W	5%	RMC1/16 154JATP	J24185154		1-	
R135	CHIP RES.	2.2k	1/16W	5%	RMC1/16 222JATP	J24185222		1-	
R136	CHIP RES.	10k	1/16W	5%	RMC1/16 103JATP	J24185103		1-	
R137	CHIP RES.	100	1/16W	5%	RMC1/16 101JATP	J24185101		1-	
R138	CHIP RES.	0	1/16W		RMC1/16 000JATP	J24185000		1-	
R139	CHIP RES.	2.2k	1/16W	5%	RMC1/16 222JATP	J24185222		1-	
R140	CHIP RES.	330	1/16W	5%	RMC1/16 331JATP	J24185331		1-	
R141	CHIP RES.	1.8k	1/16W	5%	RMC1/16 182JATP	J24185182		1-	
R142	CHIP RES.	10k	1/16W	5%	RMC1/16 103JATP	J24185103		1-	
R143	CHIP RES.	100	1/16W	5%	RMC1/16 101JATP	J24185101		1-	
R144	CHIP RES.	10k	1/16W	5%	RMC1/16 103JATP	J24185103		1-	
R145	POT.				TP96D255-19F-B104XA103	S8101004		1-	
R146	CHIP RES.	220k	1/16W	5%	RMC1/16 224JATP	J24185224		1-	
R147	CHIP RES.	1k	1/16W	5%	RMC1/16 102JATP	J24185102		1-	
R148	CHIP RES.	1k	1/16W	5%	RMC1/16 102JATP	J24185102		1-	
R149	CHIP RES.	1k	1/16W	5%	RMC1/16 102JATP	J24185102		1-	

# CNTL•AF Unit

REF.	DESCRIPTION	VALUE	V/W	TOL.	MFR'S DESIG	VXSTD P/N	VERS.	LOT.	LAY ADR
R150	CHIP RES.	1k	1/16W	5%	RMC1/16 102JATP	J24185102		1-	
R151	CHIP RES.	1k	1/16W	5%	RMC1/16 102JATP	J24185102		1-	
R152	CHIP RES.	1k	1/16W	5%	RMC1/16 102JATP	J24185102		1-	
R153	CHIP RES.	10k	1/16W	5%	RMC1/16 103JATP	J24185103		1-	
R154	CHIP RES.	22	1/16W	5%	RMC1/16 220JATP	J24185220		1-	
R155	CHIP RES.	22	1/16W	5%	RMC1/16 220JATP	J24185220		1-	
R156	CHIP RES.	22	1/16W	5%	RMC1/16 220JATP	J24185220		1-	
R157	CHIP RES.	22	1/16W	5%	RMC1/16 220JATP	J24185220		1-	
R160	CHIP RES.	0	1/16W		RMC1/16 000JATP	J24185000		1-	
R161	CHIP RES.	330	1/16W	5%	RMC1/16 331JATP	J24185331		1-	
R162	CHIP RES.	0	1/16W		RMC1/16 000JATP	J24185000		1-	
R163	CHIP RES.	10	1/10W	5%	RMC1/10T 100J	J24205100		1-	
R164	CHIP RES.	0	1/16W		RMC1/16 000JATP	J24185000		1-	
R165	CHIP RES.	1k	1/16W	5%	RMC1/16 102JATP	J24185102		1-	
R168	CHIP RES.	1k	1/16W	5%	RMC1/16 102JATP	J24185102		1-	
R170	CHIP RES.	1k	1/16W	5%	RMC1/16 102JATP	J24185102		1-	
R171	CHIP RES.	1k	1/16W	5%	RMC1/16 102JATP	J24185102		1-	
S101	TACT SWITCH				JPM1990-2311	N5090112		1-	
S102	TACT SWITCH				JPM1990-2311	N5090112		1-	
S103	ROTARY SWITCH				EC09P20-3000A0	S8101006		1-	
X101	CERAMIC OSC				CSTCR4M91G53-R0	S8101007		1-	

# **CNTL•AF Unit**

*Note:*

# Circuit Diagram

# RF Unit

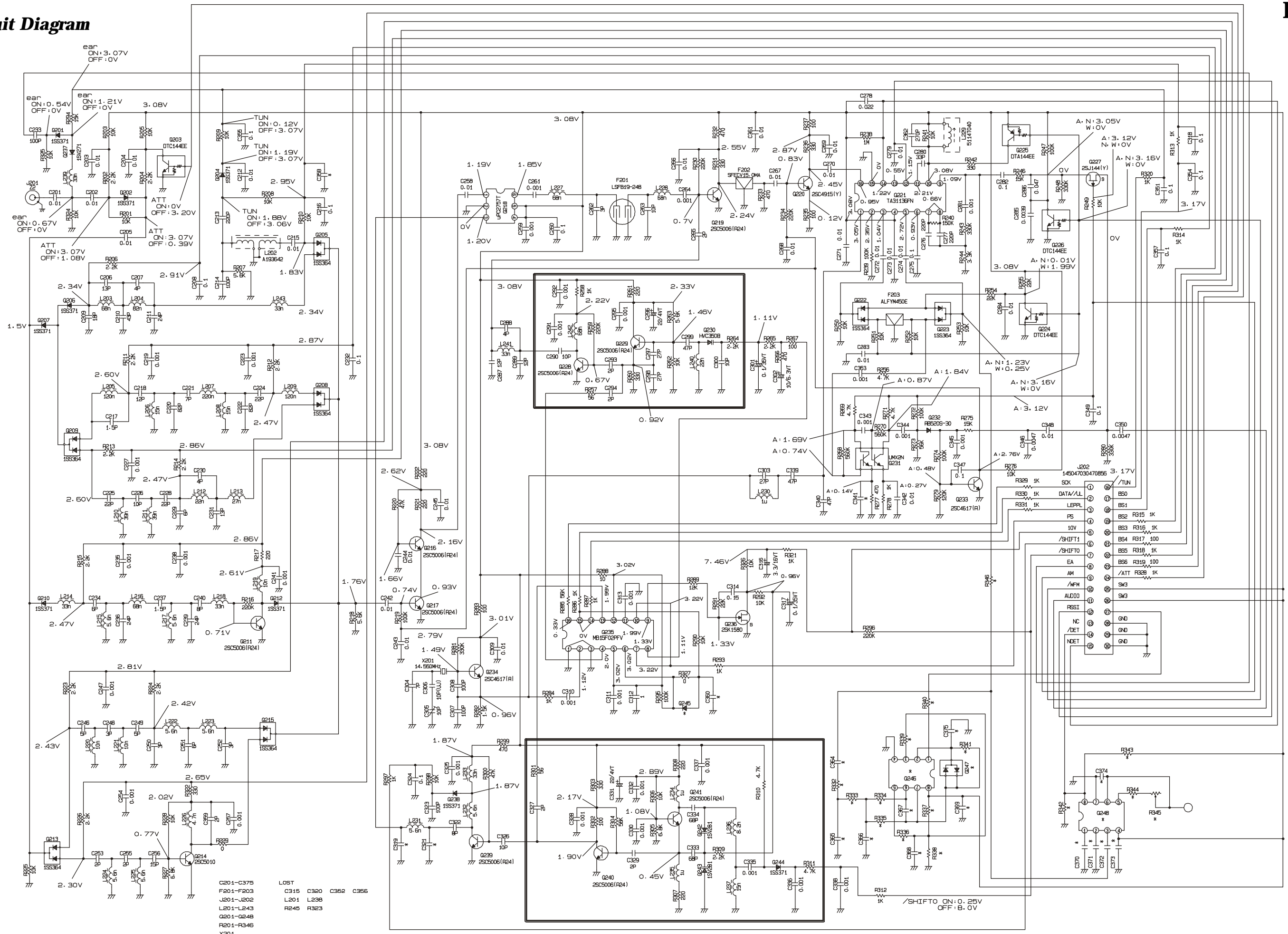

- C201-C375
  - F201-F203
  - J201-J202
  - L201-L243
  - Q201-Q248
  - R201-R346
  - X201
- LOST
  - C315 C320 C352 C356
  - L201 L238
  - R245 R323

## **RF Unit**

*Note:*



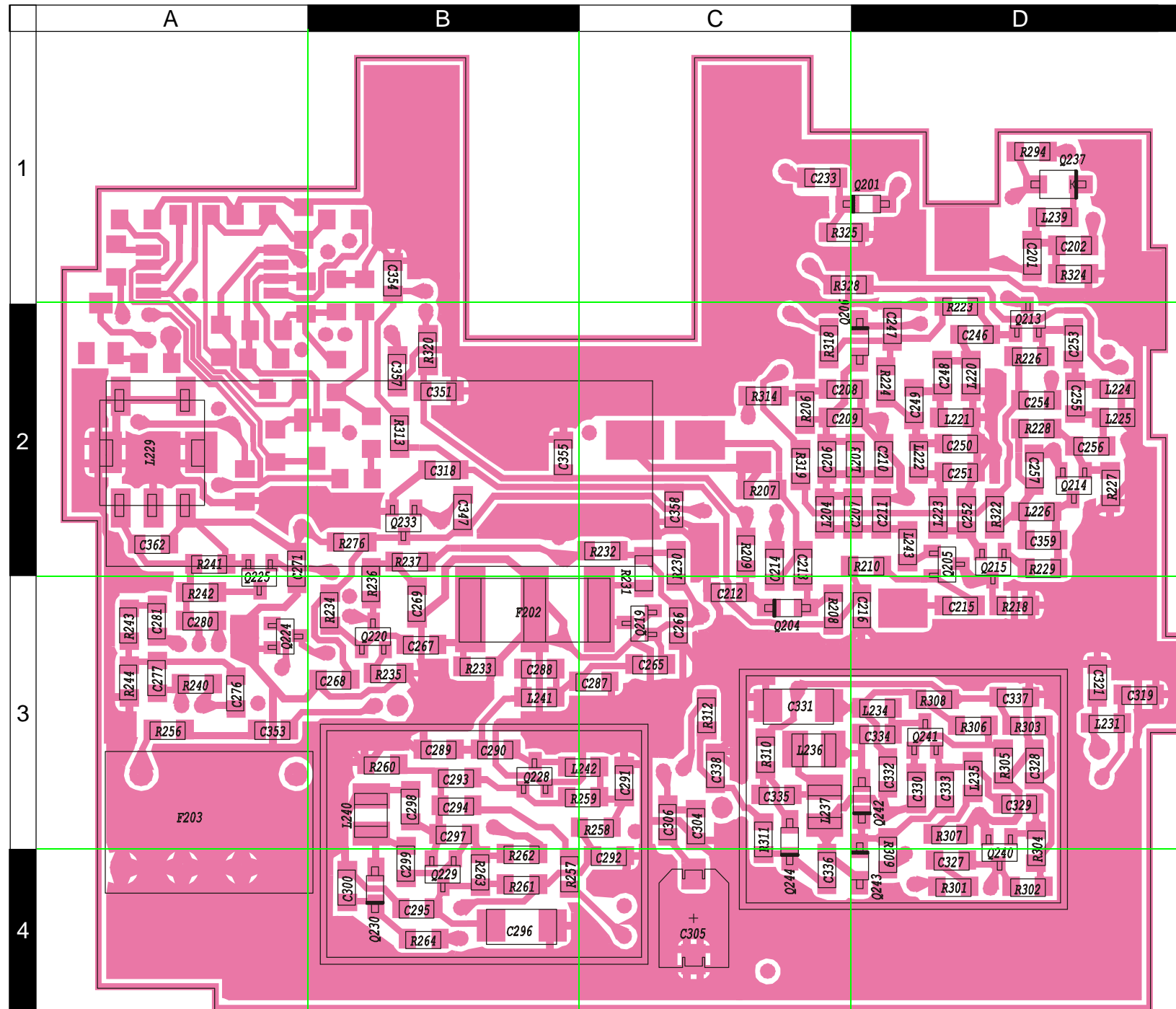

Side A

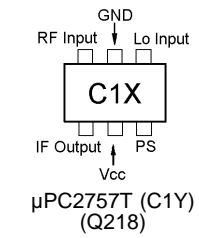
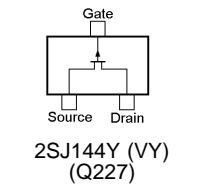
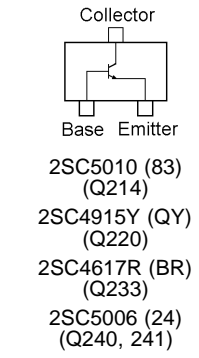
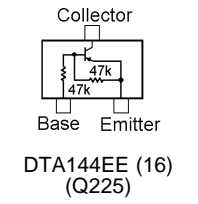
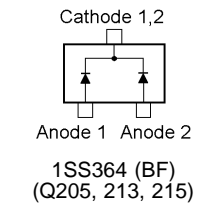

# RF Unit

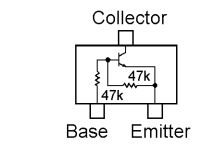

DTC144EE (26)  
(Q203, 224, 226)

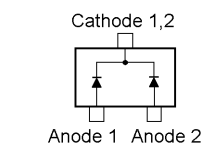

1SS364 (BF)  
(Q208, 209, 222, 223)

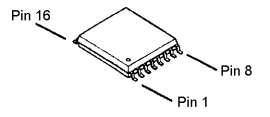

TA31136FN  
(Q221)

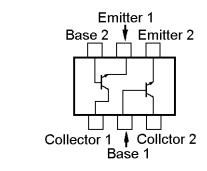

UMX2N (X2)  
(Q231)

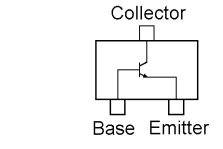

2SC5006 (24)  
(Q211, 216, 217, 219, 239)  
2SC4617R (BR)  
(Q234)

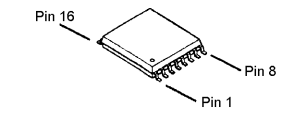

MB15F02PFV  
(Q235)

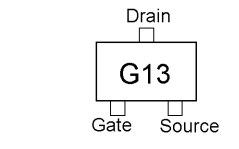

2SK1580 (G13)  
(Q236)

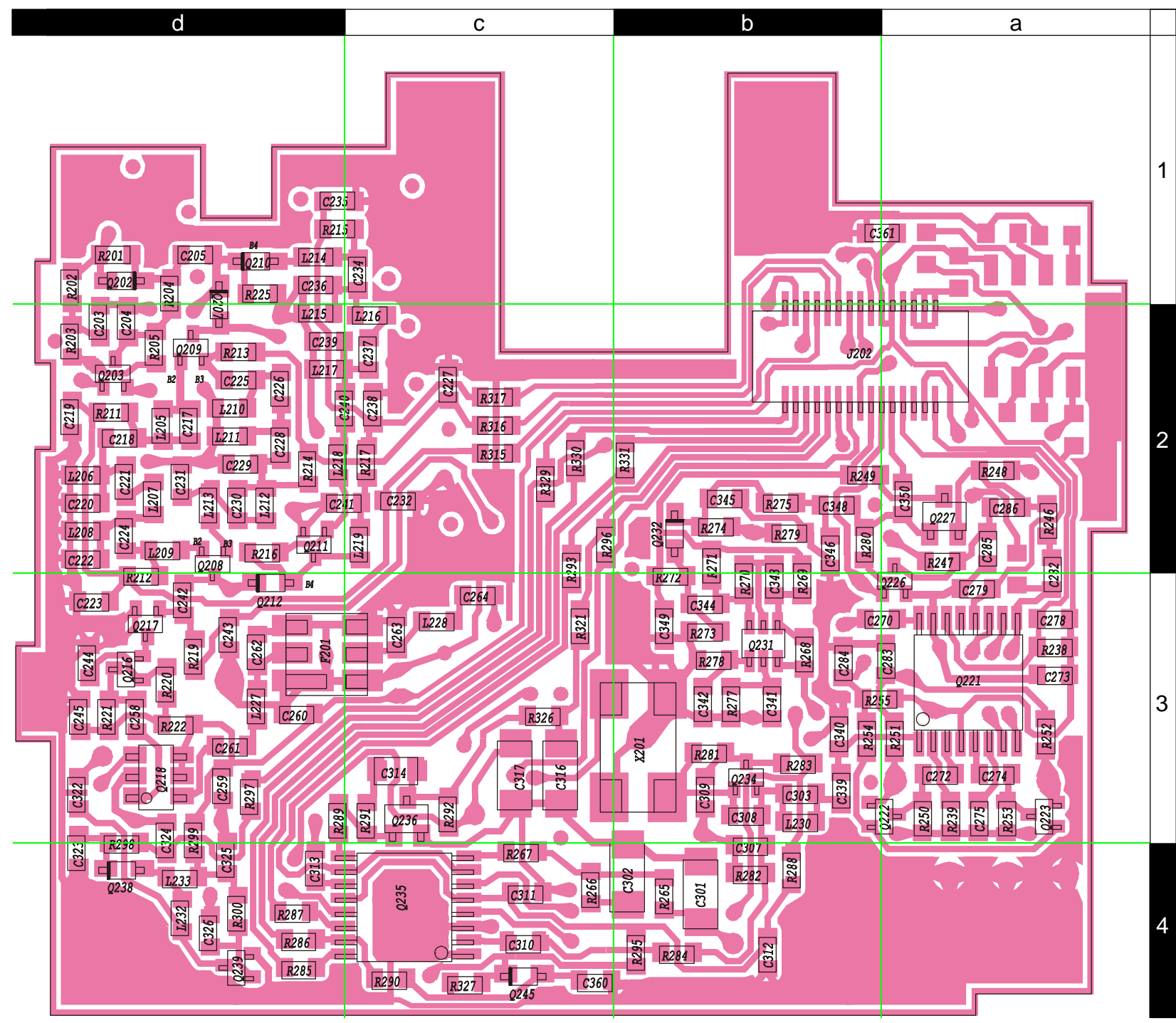

Side B

## Parts List

REF.	DESCRIPTION	VALUE	V/W	TOL.	MFR'S DESIG	VXSTD P/N	VERS.	LOT.	LAY ADR
PCB with Component (W/ BAR ANTENNA ASS'Y, SHIELD CASE)						S8101168			
C201	CHIP CAP.	0.01uF	25V	B	GRM39B103K25PT	K22144803		1-	
C202	CHIP CAP.	0.01uF	25V	B	GRM39B103K25PT	K22144803		1-	
C203	CHIP CAP.	0.01uF	25V	B	GRM39B103K25PT	K22144803		1-	
C204	CHIP CAP.	0.01uF	25V	B	GRM39B103K25PT	K22144803		1-	
C205	CHIP CAP.	0.01uF	25V	B	GRM39B103K25PT	K22144803		1-	
C206	CHIP CAP.	13pF	50V	CH	GRM39CH130J50PT	K22174214		1-	
C207	CHIP CAP.	4pF	50V	CH	GRM39CH040C50PT	K22174205		1-	
C208	CHIP CAP.	0.1uF	16V	B	GRM39B104K16PT	K22124805		1-	
C209	CHIP CAP.	18pF	50V	CH	GRM39CH180J50PT	K22174217		1-	
C210	CHIP CAP.	43pF	50V	CH	GRM39CH430J50PT	K22174226		1-	
C211	CHIP CAP.	25pF	50V	CH	GRM39CH240J50PT	K22174220		1-	
C212	CHIP CAP.	0.01uF	25V	B	GRM39B103K25PT	K22144803		1-	
C213	CHIP CAP.	220pF	50V	CH	GRM39CH221J50PT	K22174243		1-	
C214	CHIP CAP.	100pF	50V	CH	GRM39CH101J50PT	K22174235		1-	
C215	CHIP CAP.	0.01uF	25V	B	GRM39B103K25PT	K22144803		1-	
C216	CHIP CAP.	0.1uF	16V	B	GRM39B104K16PT	K22124805		1-	
C217	CHIP CAP.	1.5pF	50V	CK	GRM39CK1R5C50PT	K22174258		1-	
C218	CHIP CAP.	12pF	50V	CH	GRM39CH120J50PT	K22174213		1-	
C219	CHIP CAP.	0.001uF	50V	B	GRM39B102K50PT	K22174821		1-	
C220	CHIP CAP.	82pF	50V	CH	GRM39CH820J50PT	K22174233		1-	
C221	CHIP CAP.	7pF	50V	CH	GRM39CH070D50PT	K22174208		1-	
C222	CHIP CAP.	82pF	50V	CH	GRM39CH820J50PT	K22174233		1-	
C223	CHIP CAP.	0.001uF	50V	B	GRM39B102K50PT	K22174821		1-	
C224	CHIP CAP.	22pF	50V	B	GRM39CH220J50PT	K22174219		1-	
C225	CHIP CAP.	22pF	50V	B	GRM39CH220J50PT	K22174219		1-	
C226	CHIP CAP.	10pF	50V	CH	GRM39CH100D50PT	K22174211		1-	
C227	CHIP CAP.	0.001uF	50V	B	GRM39B102K50PT	K22174821		1-	
C228	CHIP CAP.	22pF	50V	B	GRM39CH220J50PT	K22174219		1-	
C229	CHIP CAP.	6pF	50V	CH	GRM39CH060D50PT	K22174207		1-	
C230	CHIP CAP.	4pF	50V	CH	GRM39CH040C50PT	K22174205		1-	
C231	CHIP CAP.	13pF	50V	CH	GRM39CH130J50PT	K22174214		1-	
C232	CHIP CAP.	0.1uF	16V	B	GRM39B104K16PT	K22124805		1-	
C233	CHIP CAP.	100pF	50V	CH	GRM39CH101J50PT	K22174235		1-	
C234	CHIP CAP.	6pF	50V	CH	GRM39CH060D50PT	K22174207		1-	
C235	CHIP CAP.	0.001uF	50V	B	GRM39B102K50PT	K22174821		1-	
C236	CHIP CAP.	25pF	50V	CH	GRM39CH240J50PT	K22174220		1-	
C237	CHIP CAP.	1.5pF	50V	CK	GRM39CK1R5C50PT	K22174258		1-	
C238	CHIP CAP.	0.001uF	50V	B	GRM39B102K50PT	K22174821		1-	
C239	CHIP CAP.	25pF	50V	CH	GRM39CH240J50PT	K22174220		1-	
C240	CHIP CAP.	8pF	50V	CH	GRM39CH080D50PT	K22174209		1-	
C241	CHIP CAP.	0.001uF	50V	B	GRM39B102K50PT	K22174821		1-	
C242	CHIP CAP.	0.01uF	25V	B	GRM39B103K25PT	K22144803		1-	
C243	CHIP CAP.	0.01uF	25V	B	GRM39B103K25PT	K22144803		1-	
C244	CHIP CAP.	0.01uF	25V	B	GRM39B103K25PT	K22144803		1-	
C245	CHIP CAP.	0.01uF	25V	B	GRM39B103K25PT	K22144803		1-	
C246	CHIP CAP.	5pF	50V	CH	GRM39CH050C50PT	K22174206		1-	
C247	CHIP CAP.	0.001uF	50V	B	GRM39B102K50PT	K22174821		1-	
C248	CHIP CAP.	3pF	50V	CJ	GRM39CJ030C50PT	K22174204		1-	
C249	CHIP CAP.	5pF	50V	CH	GRM39CH050C50PT	K22174206		1-	
C250	CHIP CAP.	3pF	50V	CJ	GRM39CJ030C50PT	K22174204		1-	
C251	CHIP CAP.	6pF	50V	CH	GRM39CH060D50PT	K22174207		1-	
C252	CHIP CAP.	3pF	50V	CJ	GRM39CJ030C50PT	K22174204		1-	
C253	CHIP CAP.	2pF	50V	CK	GRM39CK020C50PT	K22174203		1-	
C254	CHIP CAP.	0.001uF	50V	B	GRM39B102K50PT	K22174821		1-	
C255	CHIP CAP.	2pF	50V	CK	GRM39CK020C50PT	K22174203		1-	
C256	CHIP CAP.	15pF	50V	CH	GRM39CH150J50PT	K22174215		1-	
C257	CHIP CAP.	0.001uF	50V	B	GRM39B102K50PT	K22174821		1-	
C258	CHIP CAP.	0.01uF	25V	B	GRM39B103K25PT	K22144803		1-	
C259	CHIP CAP.	0.001uF	50V	B	GRM39B102K50PT	K22174821		1-	
C260	CHIP CAP.	0.1uF	16V	B	GRM39B104K16PT	K22124805		1-	
C261	CHIP CAP.	0.001uF	50V	B	GRM39B102K50PT	K22174821		1-	
C262	CHIP CAP.	3pF	50V	CJ	GRM39CJ030C50PT	K22174204		1-	
C263	CHIP CAP.	10pF	50V	CH	GRM39CH100D50PT	K22174211		1-	
C264	CHIP CAP.	0.001uF	50V	B	GRM39B102K50PT	K22174821		1-	
C265	CHIP CAP.	2pF	50V	CK	GRM39CK020C50PT	K22174203		1-	
C266	CHIP CAP.	0.01uF	25V	B	GRM39B103K25PT	K22144803		1-	

# RF Unit

REF.	DESCRIPTION	VALUE	V/W	TOL.	MFR'S DESIG	VXSTD P/N	VERS.	LOT.	LAY ADR
C267	CHIP CAP.	0.01uF	25V	B	GRM39B103K25PT	K22144803		1-	
C268	CHIP CAP.	0.01uF	25V	B	GRM39B103K25PT	K22144803		1-	
C269	CHIP CAP.	0.01uF	25V	B	GRM39B103K25PT	K22144803		1-	
C270	CHIP CAP.	0.01uF	25V	B	GRM39B103K25PT	K22144803		1-	
C271	CHIP CAP.	0.01uF	25V	B	GRM39B103K25PT	K22144803		1-	
C272	CHIP CAP.	0.01uF	25V	B	GRM39B103K25PT	K22144803		1-	
C273	CHIP CAP.	0.01uF	25V	B	GRM39B103K25PT	K22144803		1-	
C274	CHIP CAP.	0.01uF	25V	B	GRM39B103K25PT	K22144803		1-	
C275	CHIP CAP.	0.1uF	16V	B	GRM39B104K16PT	K22124805		1-	
C276	CHIP CAP.	220pF	50V	CH	GRM39CH221J50PT	K22174243		1-	
C277	CHIP CAP.	220pF	50V	CH	GRM39CH221J50PT	K22174243		1-	
C278	CHIP CAP.	0.022uF	16V	B	GRM39R223K16PT	K22124811		1-	
C279	CHIP CAP.	0.01uF	25V	B	GRM39B103K25PT	K22144803		1-	
C280	CHIP CAP.	33pF	50V	CH	GRM39CH330J50PT	K22174223		1-	
C281	CHIP CAP.	0.001uF	50V	B	GRM39B102K50PT	K22174821		1-	
C282	CHIP CAP.	0.1uF	16V	B	GRM39B104K16PT	K22124805		1-	
C283	CHIP CAP.	0.01uF	25V	B	GRM39B103K25PT	K22144803		1-	
C284	CHIP CAP.	0.01uF	25V	B	GRM39B103K25PT	K22144803		1-	
C285	CHIP CAP.	0.0039uF	50V	B	GRM39B392K50PT	K22174830		1-	
C286	CHIP CAP.	0.047uF	16V	B	GRM39B473K16PT	K22124804		1-	
C287	CHIP CAP.	12pF	50V	CH	GRM39CH120J50PT	K22174213		1-	
C288	CHIP CAP.	4pF	50V	CH	GRM39CH040C50PT	K22174205		1-	
C289	CHIP CAP.	12pF	50V	CH	GRM39CH120J50PT	K22174213		1-	
C290	CHIP CAP.	10pF	50V	CH	GRM39CH100D50PT	K22174211		1-	
C291	CHIP CAP.	0.001uF	50V	B	GRM39B102K50PT	K22174821		1-	
C292	CHIP CAP.	0.001uF	50V	B	GRM39B102K50PT	K22174821		1-	
C293	CHIP CAP.	2pF	50V	CK	GRM39CK020C50PT	K22174203		1-	
C294	CHIP CAP.	2pF	50V	CK	GRM39CK020C50PT	K22174203		1-	
C295	CHIP CAP.	0.001uF	50V	B	GRM39B102K50PT	K22174821		1-	
C296	CHIP TA.CAP.	22uF	6.3V		TEMSVA0J226M-8R	K78080047		1-	
C297	CHIP CAP.	27pF	50V	CH	GRM39CH270J50PT	K22174221		1-	
C298	CHIP CAP.	27pF	50V	CH	GRM39CH270J50PT	K22174221		1-	
C299	CHIP CAP.	47pF	50V	CH	GRM39CH470J50PT	K22174227		1-	
C300	CHIP CAP.	10pF	50V	CH	GRM39CH100D50PT	K22174211		1-	
C301	CHIP TA.CAP.	0.1uF	35V		TESVA1V104M1-8R	K78160025		1-	
C302	CHIP TA.CAP.	10uF	6.3V		TEMSVA0J106M-8R	K78080027		1-	
C303	CHIP CAP.	27pF	50V	CH	GRM39CH270J50PT	K22174221		1-	
C304	CHIP CAP.	7pF	50V	CH	GRM39CH070D50PT	K22174208		1-	
C305	TRIMMER CAP.	10pF			CTZ3S-10A-W1-P	K91000210		1-	
C306	CHIP CAP.	10pF	50V	UJ	GRM39UJ100D50PT	K22174301		1-	
C307	CHIP CAP.	100pF	50V	CH	GRM39CH101J50PT	K22174235		1-	
C308	CHIP CAP.	100pF	50V	CH	GRM39CH101J50PT	K22174235		1-	
C309	CHIP CAP.	0.01uF	25V	B	GRM39B103K25PT	K22144803		1-	
C310	CHIP CAP.	0.001uF	50V	B	GRM39B102K50PT	K22174821		1-	
C311	CHIP CAP.	0.001uF	50V	B	GRM39B102K50PT	K22174821		1-	
C312	CHIP CAP.	1uF	6.3V	B	GRM39B105K6.3PT	K22084801		1-	
C313	CHIP CAP.	0.001uF	50V	B	GRM39B102K50PT	K22174821		1-	
C314	CHIP CAP.	0.15uF	25V	B	GRM40B154K25PT	K22140823		1-	
C316	CHIP TA.CAP.	3.3uF	16V		TEMSVA1C335M-8R	K78120021		1-	
C317	CHIP TA.CAP.	0.1uF	35V		TESVA1V104M1-8R	K78160025		1-	
C318	CHIP CAP.	0.1uF	16V	B	GRM39B104K16PT	K22124805		1-	
C322	CHIP CAP.	8pF	50V	CH	GRM39CH080D50PT	K22174209		1-	
C323	CHIP CAP.	100pF	50V	CH	GRM39CH101J50PT	K22174235		1-	
C324	CHIP CAP.	0.1uF	16V	B	GRM39B104K16PT	K22124805		1-	
C325	CHIP CAP.	0.001uF	50V	B	GRM39B102K50PT	K22174821		1-	
C326	CHIP CAP.	10pF	50V	CH	GRM39CH100D50PT	K22174211		1-	
C327	CHIP CAP.	2pF	50V	CK	GRM39CK020C50PT	K22174203		1-	
C328	CHIP CAP.	0.001uF	50V	B	GRM39B102K50PT	K22174821		1-	
C329	CHIP CAP.	2pF	50V	CK	GRM39CK020C50PT	K22174203		1-	
C330	CHIP CAP.	0.001uF	50V	B	GRM39B102K50PT	K22174821		1-	
C331	CHIP TA.CAP.	22uF	6.3V		TEMSVA0J226M-8R	K78080047		1-	
C332	CHIP CAP.	0.001uF	50V	B	GRM39B102K50PT	K22174821		1-	
C333	CHIP CAP.	68pF	50V	CH	GRM39CH680J50PT	K22174231		1-	
C334	CHIP CAP.	68pF	50V	CH	GRM39CH680J50PT	K22174231		1-	
C335	CHIP CAP.	0.001uF	50V	B	GRM39B102K50PT	K22174821		1-	
C336	CHIP CAP.	0.001uF	50V	B	GRM39B102K50PT	K22174821		1-	
C337	CHIP CAP.	0.001uF	50V	B	GRM39B102K50PT	K22174821		1-	

REF.	DESCRIPTION	VALUE	V/W	TOL.	MFR'S DESIG	VXSTD P/N	VERS.	LOT.	LAY ADR
C338	CHIP CAP.	0.001uF	50V	B	GRM39B102K50PT	K22174821		1-	
C339	CHIP CAP.	47pF	50V	CH	GRM39CH470J50PT	K22174227		1-	
C340	CHIP CAP.	47pF	50V	CH	GRM39CH470J50PT	K22174227		1-	
C342	CHIP CAP.	0.01uF	25V	B	GRM39B103K25PT	K22144803		1-	
C343	CHIP CAP.	0.001uF	50V	B	GRM39B102K50PT	K22174821		1-	
C344	CHIP CAP.	0.001uF	50V	B	GRM39B102K50PT	K22174821		1-	
C345	CHIP CAP.	0.001uF	50V	B	GRM39B102K50PT	K22174821		1-	
C346	CHIP CAP.	0.0047uF	50V	B	GRM39B472K50PT	K22174833		1-	
C347	CHIP CAP.	0.1uF	16V	B	GRM39B104K16PT	K22124805		1-	
C348	CHIP CAP.	0.01uF	25V	B	GRM39B103K25PT	K22144803		1-	
C349	CHIP CAP.	0.1uF	16V	B	GRM39B104K16PT	K22124805		1-	
C350	CHIP CAP.	0.0047uF	50V	B	GRM39B472K50PT	K22174833		1-	
C351	CHIP CAP.	0.1uF	16V	B	GRM39B104K16PT	K22124805		1-	
C353	CHIP CAP.	0.001uF	50V	B	GRM39B102K50PT	K22174821		1-	
C354	CHIP CAP.	0.1uF	16V	B	GRM39B104K16PT	K22124805		1-	
C355	CHIP CAP.	0.1uF	16V	B	GRM39B104K16PT	K22124805		1-	
C357	CHIP CAP.	0.1uF	16V	B	GRM39B104K16PT	K22124805		1-	
C359	CHIP CAP.	2pF	50V	CK	GRM39CK020C50PT	K22174203		1-	
C361	CHIP CAP.	0.01uF	25V	B	GRM39B103K25PT	K22144803		1-	
C362	CHIP CAP.	270pF	50V	CH	GRM39CH271J50PT	K22174251		1-	
F201	SAW FILTER				LSFB19-248-220K0	S8100783		1-	
F202	CERAMIC FILTER				SFECV15.0MA	S8101002		1-	
F203	CERAMIC FILTER				ALFYM450E=K	H3900535		1-	
J201	CONNECTOR				Z2	S8100788		1-	
J202	CONNECTOR				145047030470856	P0091315		1-	
L203	M.RFC	0.068uH			LL1608-FH68NJ	L1690871		1-	
L204	M.RFC	0.082uH			LL1608-FH82NJ	L1690872		1-	
L205	M.RFC	0.12uH			LL1608-FSR12J	L1690922		1-	
L206	M.RFC	0.015uH			LL1608-FH15NJ	L1690863		1-	
L207	M.RFC	0.22uH			LL1608-FSR22J	L1691072		1-	
L208	M.RFC	0.015uH			LL1608-FH15NJ	L1690863		1-	
L209	M.RFC	0.12uH			LL1608-FSR12J	L1690922		1-	
L210	M.RFC	0.039uH			LL1608-FH39NJ	L1690868		1-	
L211	M.RFC	0.039uH			LL1608-FH39NJ	L1690868		1-	
L212	M.RFC	0.022uH			LL1608-FH22NJ	L1690865		1-	
L213	M.RFC	0.027uH			LL1608-FH27NJ	L1690866		1-	
L214	M.RFC	0.033uH			LL1608-FH33NJ	L1690867		1-	
L215	M.RFC	0.0056uH			LL1608-FH5N6S	L1690858		1-	
L216	M.RFC	0.068uH			LL1608-FH68NJ	L1690871		1-	
L217	M.RFC	0.0056uH			LL1608-FH5N6S	L1690858		1-	
L218	M.RFC	0.033uH			LL1608-FH33NJ	L1690867		1-	
L219	M.RFC	0.01uH			LL1608-FH10NJ	L1690861		1-	
L220	M.RFC	0.01uH			LL1608-FH10NJ	L1690861		1-	
L221	M.RFC	0.01uH			LL1608-FH10NJ	L1690861		1-	
L222	M.RFC	0.0056uH			LL1608-FH5N6S	L1690858		1-	
L223	M.RFC	0.0056uH			LL1608-FH5N6S	L1690858		1-	
L224	M.RFC	0.0056uH			LL1608-FH5N6S	L1690858		1-	
L225	M.RFC	0.0056uH			LL1608-FH5N6S	L1690858		1-	
L226	M.RFC	0.0047uH			LL1608-FH4N7S	L1690857		1-	
L227	M.RFC	0.068uH			LL1608-FH68NJ	L1690871		1-	
L228	M.RFC	0.068uH			LL1608-FH68NJ	L1690871		1-	
L229	RF TRANS.				5114T040	S8101155		1-	
L230	M.RFC				MLF1608A1R0KT	L1690930		1-	
L231	M.RFC	0.0056uH			LL1608-FH5N6S	L1690858		1-	
L232	M.RFC	0.0056uH			LL1608-FH5N6S	L1690858		1-	
L233	M.RFC	0.033uH			LL1608-FH33NJ	L1690867		1-	
L234	M.RFC				MLF1608A1R0KT	L1690930		1-	
L235	M.RFC				MLF1608A1R0KT	L1690930		1-	
L236	CHIP COIL	0.0082uH			LQN21A8N2D04	L1690608		1-	
L237	CHIP COIL	0.015uH			LQN21A15NJ04	L1690611		1-	
L239	M.RFC	0.033uH			LL1608-FH33NJ	L1690867		1-	
L240	CHIP COIL	0.022uH			LQN21A22NJ04	L1690613		1-	
L241	M.RFC	0.033uH			LL1608-FH33NJ	L1690867		1-	
L242	M.RFC	0.068uH			LL1608-FH68NJ	L1690871		1-	
L243	M.RFC	0.033uH			LL1608-FH33NJ	L1690867		1-	
Q201	DIODE				1SS371(TPH3)	G2070728		1-	D1
Q202	DIODE				1SS371(TPH3)	G2070728		1-	d1

# RF Unit

REF.	DESCRIPTION	VALUE	V/W	TOL.	MFR'S DESIG	VXSTD P/N	VERS.	LOT.	LAY ADR
Q203	TRANSISTOR				DTC144EE TL	G3070075		1-	d2
Q204	DIODE				1SS371(TPH3)	G2070728		1-	C3
Q205	DIODE				1SS364(TE85R)	G2070730		1-	D2
Q206	DIODE				1SS371(TPH3)	G2070728		1-	D2
Q207	DIODE				1SS371(TPH3)	G2070728		1-	d2
Q208	DIODE				1SS364(TE85R)	G2070730		1-	d3
Q209	DIODE				1SS364(TE85R)	G2070730		1-	d2
Q210	DIODE				1SS371(TPH3)	G2070728		1-	d1
Q211	TRANSISTOR				2SC5006-T1	G3350068		1-	d2
Q212	DIODE				1SS371(TPH3)	G2070728		1-	d3
Q213	DIODE				1SS364(TE85R)	G2070730		1-	D2
Q214	TRANSISTOR				2SC5010-T1	G3350108		1-	D2
Q215	DIODE				1SS364(TE85R)	G2070730		1-	D2
Q216	TRANSISTOR				2SC5006-T1	G3350068		1-	d3
Q217	TRANSISTOR				2SC5006-T1	G3350068		1-	d3
Q218	IC				UPC2757T-E3	G1093078		1-	d3
Q219	TRANSISTOR				2SC5006-T1	G3350068		1-	C3
Q220	TRANSISTOR				2SC4915Y(TE85R)	G3349157Y		1-	B3
Q221	IC				TA31136FN(EL)	G1091605		1-	a3
Q222	DIODE				1SS364(TE85R)	G2070730		1-	b3
Q223	DIODE				1SS364(TE85R)	G2070730		1-	a3
Q224	TRANSISTOR				DTC144EE TL	G3070075		1-	A3
Q225	TRANSISTOR				DTA144EE TL	G3070074		1-	A3
Q226	TRANSISTOR				DTC144EE TL	G3070075		1-	a3
Q227	FET				2SJ144Y TE85R	G3701447Y		1-	a2
Q228	TRANSISTOR				2SC5006-T1	G3350068		1-	B3
Q229	TRANSISTOR				2SC5006-T1	G3350068		1-	B4
Q230	DIODE				HVC350B-TRF	G2070596		1-	B4
Q231	TRANSISTOR				UMX2N TR	G3070254		1-	b3
Q232	DIODE				RB520S-30TE61	G2070822		1-	b2
Q233	TRANSISTOR				2SC4617 TL R	G3346178R		1-	B2
Q234	TRANSISTOR				2SC4617 TL R	G3346178R		1-	b3
Q235	IC				MB15F02PFV	G1093080		1-	c4
Q236	FET				2SK1580-T1	G3815808		1-	c3
Q237	DIODE				1SV271 TPH3	G2070476		1-	D1
Q238	DIODE				1SS371(TPH3)	G2070728		1-	d4
Q239	TRANSISTOR				2SC5006-T1	G3350068		1-	d4
Q240	TRANSISTOR				2SC5006-T1	G3350068		1-	D4
Q241	TRANSISTOR				2SC5006-T1	G3350068		1-	D3
Q242	DIODE				1SV281(TPH3)	G2070620		1-	D3
Q243	DIODE				1SV281(TPH3)	G2070620		1-	D4
Q244	DIODE				1SS371(TPH3)	G2070728		1-	C3
R201	CHIP RES.	10k	1/16W	5%	RMC1/16 103JATP	J24185103		1-	
R202	CHIP RES.	2.2k	1/16W	5%	RMC1/16 222JATP	J24185222		1-	
R203	CHIP RES.	10k	1/16W	5%	RMC1/16 103JATP	J24185103		1-	
R204	CHIP RES.	2.2k	1/16W	5%	RMC1/16 222JATP	J24185222		1-	
R205	CHIP RES.	10k	1/16W	5%	RMC1/16 103JATP	J24185103		1-	
R206	CHIP RES.	2.2k	1/16W	5%	RMC1/16 222JATP	J24185222		1-	
R207	CHIP RES.	5.6k	1/16W	5%	RMC1/16 562JATP	J24185562		1-	
R208	CHIP RES.	10k	1/16W	5%	RMC1/16 103JATP	J24185103		1-	
R209	CHIP RES.	10k	1/16W	5%	RMC1/16 103JATP	J24185103		1-	
R210	CHIP RES.	10k	1/16W	5%	RMC1/16 103JATP	J24185103		1-	
R211	CHIP RES.	2.2k	1/16W	5%	RMC1/16 222JATP	J24185222		1-	
R212	CHIP RES.	2.2k	1/16W	5%	RMC1/16 222JATP	J24185222		1-	
R213	CHIP RES.	2.2k	1/16W	5%	RMC1/16 222JATP	J24185222		1-	
R214	CHIP RES.	2.2k	1/16W	5%	RMC1/16 222JATP	J24185222		1-	
R215	CHIP RES.	2.2k	1/16W	5%	RMC1/16 222JATP	J24185222		1-	
R216	CHIP RES.	220k	1/16W	5%	RMC1/16 224JATP	J24185224		1-	
R217	CHIP RES.	220	1/16W	5%	RMC1/16 221JATP	J24185221		1-	
R218	CHIP RES.	5.6k	1/16W	5%	RMC1/16 562JATP	J24185562		1-	
R219	CHIP RES.	100k	1/16W	5%	RMC1/16 104JATP	J24185104		1-	
R220	CHIP RES.	47K	1/16W	5%	RMC1/16 473JATP	J24185473		1-	
R221	CHIP RES.	220	1/16W	5%	RMC1/16 221JATP	J24185221		1-	
R222	CHIP RES.	220	1/16W	5%	RMC1/16 221JATP	J24185221		1-	
R223	CHIP RES.	2.2k	1/16W	5%	RMC1/16 222JATP	J24185222		1-	
R224	CHIP RES.	2.2k	1/16W	5%	RMC1/16 222JATP	J24185222		1-	
R225	CHIP RES.	10k	1/16W	5%	RMC1/16 103JATP	J24185103		1-	

REF.	DESCRIPTION	VALUE	V/W	TOL.	MFR'S DESIG	VXSTD P/N	VERS.	LOT.	LAY ADR
R226	CHIP RES.	2.2k	1/16W	5%	RMC1/16 222JATP	J24185222		1-	
R227	CHIP RES.	6.8k	1/16W	5%	RMC1/16 682JATP	J24185682		1-	
R228	CHIP RES.	10k	1/16W	5%	RMC1/16 103JATP	J24185103		1-	
R229	CHIP RES.	0	1/16W		RMC1/16 000JATP	J24185000		1-	
R230	CHIP RES.	220k	1/16W	5%	RMC1/16 224JATP	J24185224		1-	
R231	CHIP RES.	330	1/16W	5%	RMC1/16 331JATP	J24185331		1-	
R232	CHIP RES.	470	1/16W	5%	RMC1/16 471JATP	J24185471		1-	
R233	CHIP RES.	470	1/16W	5%	RMC1/16 471JATP	J24185471		1-	
R234	CHIP RES.	220k	1/16W	5%	RMC1/16 224JATP	J24185224		1-	
R235	CHIP RES.	100	1/16W	5%	RMC1/16 101JATP	J24185101		1-	
R236	CHIP RES.	330	1/16W	5%	RMC1/16 331JATP	J24185331		1-	
R237	CHIP RES.	100	1/16W	5%	RMC1/16 101JATP	J24185101		1-	
R238	CHIP RES.	1M	1/16W	5%	RMC1/16 105JATP	J24185105		1-	
R239	CHIP RES.	100k	1/16W	5%	RMC1/16 104JATP	J24185104		1-	
R240	CHIP RES.	150k	1/16W	5%	RMC1/16 154JATP	J24185154		1-	
R241	CHIP RES.	10k	1/16W	5%	RMC1/16 103JATP	J24185103		1-	
R242	CHIP RES.	330	1/16W	5%	RMC1/16 331JATP	J24185331		1-	
R243	CHIP RES.	330k	1/16W	5%	RMC1/16 334JATP	J24185334		1-	
R244	CHIP RES.	3.3k	1/16W	5%	RMC1/16 332JATP	J24185332		1-	
R246	CHIP RES.	15k	1/16W	5%	RMC1/16 153JATP	J24185153		1-	
R247	CHIP RES.	100k	1/16W	5%	RMC1/16 104JATP	J24185104		1-	
R248	CHIP RES.	330k	1/16W	5%	RMC1/16 334JATP	J24185334		1-	
R249	CHIP RES.	10k	1/16W	5%	RMC1/16 103JATP	J24185103		1-	
R250	CHIP RES.	10k	1/16W	5%	RMC1/16 103JATP	J24185103		1-	
R251	CHIP RES.	10k	1/16W	5%	RMC1/16 103JATP	J24185103		1-	
R252	CHIP RES.	10k	1/16W	5%	RMC1/16 103JATP	J24185103		1-	
R253	CHIP RES.	10k	1/16W	5%	RMC1/16 103JATP	J24185103		1-	
R254	CHIP RES.	22k	1/16W	5%	RMC1/16 223JATP	J24185223		1-	
R255	CHIP RES.	22k	1/16W	5%	RMC1/16 223JATP	J24185223		1-	
R256	CHIP RES.	4.7k	1/16W	5%	RMC1/16 472JATP	J24185472		1-	
R257	CHIP RES.	56	1/16W	5%	RMC1/16 560JATP	J24185560		1-	
R258	CHIP RES.	1k	1/16W	5%	RMC1/16 102JATP	J24185102		1-	
R259	CHIP RES.	220k	1/16W	5%	RMC1/16 224JATP	J24185224		1-	
R260	CHIP RES.	330	1/16W	5%	RMC1/16 331JATP	J24185331		1-	
R261	CHIP RES.	220	1/16W	5%	RMC1/16 221JATP	J24185221		1-	
R262	CHIP RES.	10k	1/16W	5%	RMC1/16 103JATP	J24185103		1-	
R263	CHIP RES.	5.6k	1/16W	5%	RMC1/16 562JATP	J24185562		1-	
R264	CHIP RES.	2.2k	1/16W	5%	RMC1/16 222JATP	J24185222		1-	
R265	CHIP RES.	2.2k	1/16W	5%	RMC1/16 222JATP	J24185222		1-	
R266	CHIP RES.	470	1/16W	5%	RMC1/16 471JATP	J24185471		1-	
R267	CHIP RES.	100	1/16W	5%	RMC1/16 101JATP	J24185101		1-	
R268	CHIP RES.	560k	1/16W	5%	RMC1/16 564JATP	J24185564		1-	
R269	CHIP RES.	4.7k	1/16W	5%	RMC1/16 472JATP	J24185472		1-	
R270	CHIP RES.	560k	1/16W	5%	RMC1/16 564JATP	J24185564		1-	
R271	CHIP RES.	4.7k	1/16W	5%	RMC1/16 472JATP	J24185472		1-	
R272	CHIP RES.	100k	1/16W	5%	RMC1/16 104JATP	J24185104		1-	
R273	CHIP RES.	56k	1/16W	5%	RMC1/16 563JATP	J24185563		1-	
R274	CHIP RES.	100k	1/16W	5%	RMC1/16 104JATP	J24185104		1-	
R275	CHIP RES.	15k	1/16W	5%	RMC1/16 153JATP	J24185153		1-	
R276	CHIP RES.	10k	1/16W	5%	RMC1/16 103JATP	J24185103		1-	
R277	CHIP RES.	470	1/16W	5%	RMC1/16 471JATP	J24185471		1-	
R278	CHIP RES.	1k	1/16W	5%	RMC1/16 102JATP	J24185102		1-	
R279	CHIP RES.	120k	1/16W	5%	RMC1/16 124JATP	J24185124		1-	
R280	CHIP RES.	330k	1/16W	5%	RMC1/16 334JATP	J24185334		1-	
R281	CHIP RES.	330k	1/16W	5%	RMC1/16 334JATP	J24185334		1-	
R282	CHIP RES.	1.5k	1/16W	5%	RMC1/16 152JATP	J24185152		1-	
R283	CHIP RES.	100	1/16W	5%	RMC1/16 101JATP	J24185101		1-	
R284	CHIP RES.	1k	1/16W	5%	RMC1/16 102JATP	J24185102		1-	
R285	CHIP RES.	56k	1/16W	5%	RMC1/16 563JATP	J24185563		1-	
R286	CHIP RES.	1k	1/16W	5%	RMC1/16 102JATP	J24185102		1-	
R287	CHIP RES.	1k	1/16W	5%	RMC1/16 102JATP	J24185102		1-	
R288	CHIP RES.	10	1/16W	5%	RMC1/16 100JATP	J24185100		1-	
R289	CHIP RES.	12k	1/16W	5%	RMC1/16 123JATP	J24185123		1-	
R290	CHIP RES.	10k	1/16W	5%	RMC1/16 103JATP	J24185103		1-	
R291	CHIP RES.	22k	1/16W	5%	RMC1/16 223JATP	J24185223		1-	
R292	CHIP RES.	10k	1/16W	5%	RMC1/16 103JATP	J24185103		1-	
R293	CHIP RES.	1k	1/16W	5%	RMC1/16 102JATP	J24185102		1-	

# RF Unit

REF.	DESCRIPTION	VALUE	V/W	TOL.	MFR'S DESIG	VXSTD P/N	VERS.	LOT.	LAY ADR
R294	CHIP RES.	15k	1/16W	5%	RMC1/16 153JATP	J24185153		1-	
R295	CHIP RES.	100k	1/16W	5%	RMC1/16 104JATP	J24185104		1-	
R296	CHIP RES.	220k	1/16W	5%	RMC1/16 224JATP	J24185224		1-	
R297	CHIP RES.	1k	1/16W	5%	RMC1/16 102JATP	J24185102		1-	
R298	CHIP RES.	10k	1/16W	5%	RMC1/16 103JATP	J24185103		1-	
R299	CHIP RES.	470	1/16W	5%	RMC1/16 471JATP	J24185471		1-	
R300	CHIP RES.	47K	1/16W	5%	RMC1/16 473JATP	J24185473		1-	
R301	CHIP RES.	56	1/16W	5%	RMC1/16 560JATP	J24185560		1-	
R302	CHIP RES.	100	1/16W	5%	RMC1/16 101JATP	J24185101		1-	
R303	CHIP RES.	330	1/16W	5%	RMC1/16 331JATP	J24185331		1-	
R304	CHIP RES.	56k	1/16W	5%	RMC1/16 563JATP	J24185563		1-	
R305	CHIP RES.	6.8k	1/16W	5%	RK73AD1J682J	S8101156		1-	
R306	CHIP RES.	10k	1/16W	0.5%	RR0816P-103-D	J24189170		1-	
R307	CHIP RES.	220	1/16W	5%	RMC1/16 221JATP	J24185221		1-	
R308	CHIP RES.	220	1/16W	5%	RMC1/16 221JATP	J24185221		1-	
R309	CHIP RES.	2.2k	1/16W	5%	RMC1/16 222JATP	J24185222		1-	
R310	CHIP RES.	4.7k	1/16W	5%	RMC1/16 472JATP	J24185472		1-	
R311	CHIP RES.	4.7k	1/16W	5%	RMC1/16 472JATP	J24185472		1-	
R312	CHIP RES.	1k	1/16W	5%	RMC1/16 102JATP	J24185102		1-	
R313	CHIP RES.	1k	1/16W	5%	RMC1/16 102JATP	J24185102		1-	
R314	CHIP RES.	1k	1/16W	5%	RMC1/16 102JATP	J24185102		1-	
R315	CHIP RES.	1k	1/16W	5%	RMC1/16 102JATP	J24185102		1-	
R316	CHIP RES.	1k	1/16W	5%	RMC1/16 102JATP	J24185102		1-	
R317	CHIP RES.	100	1/16W	5%	RMC1/16 101JATP	J24185101		1-	
R318	CHIP RES.	1k	1/16W	5%	RMC1/16 102JATP	J24185102		1-	
R319	CHIP RES.	100	1/16W	5%	RMC1/16 101JATP	J24185101		1-	
R320	CHIP RES.	1k	1/16W	5%	RMC1/16 102JATP	J24185102		1-	
R321	CHIP RES.	1k	1/16W	5%	RMC1/16 102JATP	J24185102		1-	
R322	CHIP RES.	330	1/16W	5%	RMC1/16 331JATP	J24185331		1-	
R324	CHIP RES.	10k	1/16W	5%	RMC1/16 103JATP	J24185103		1-	
R325	CHIP RES.	10k	1/16W	5%	RMC1/16 103JATP	J24185103		1-	
R326	CHIP RES.	10k	1/16W	5%	RMC1/16 103JATP	J24185103		1-	
R327	CHIP RES.	0	1/16W		RMC1/16 000JATP	J24185000		1-	
R328	CHIP RES.	1k	1/16W	5%	RMC1/16 102JATP	J24185102		1-	
R329	CHIP RES.	1k	1/16W	5%	RMC1/16 102JATP	J24185102		1-	
R330	CHIP RES.	1k	1/16W	5%	RMC1/16 102JATP	J24185102		1-	
R331	CHIP RES.	1k	1/16W	5%	RMC1/16 102JATP	J24185102		1-	
X201	XTAL	14.550MHZ			SW-6035 14.550MHZ	S8101003		1-	







**Copyright © 2002**  
**VERTEX STANDARD CO., LTD.**  
**All rights reserved**

No portion of this manual may be  
reproduced without the permission  
of VERTEX STANDARD CO., LTD.

Printed in Japan.