

Apr. 2011



SERVICE MANUAL ADDENDUM

ID-1

CONTENTS

REPLACEMENT PAGE	5-3
PARTS LIST	1
VOLTAGE DIAGRAM	12

5-2 PLL AND CODEC ADJUSTMENT

ADJUSTMENT	ADJUSTMENT CONDITION	MEASUREMENT		VALUE	ADJUSTMENT	
		UNIT	LOCATION		UNIT	ADJUST
FPGA FREQUENCY [Set FPGA frequency]	1 • Operating freq. : 1240.00 MHz • Mode : DD mode • Receiving	LOGIC-1 unit	Connect a frequency counter to the check point "CP200".	16.3840 MHz	LOGIC-1 unit	C202
	2 • Operating freq. : 1240.00 MHz • Mode : DV mode • Receiving			9.8304 MHz		
PLL LOCK VOLTAGE	1 • Operating freq. : 1240.00 MHz • Mode : DV mode • Connect an RF power meter or 50 Ω dummy load to the antenna connector. • Receiving	MAIN unit	Connect a digital multimeter or an oscilloscope to the check point "LV1".	More than 0.9 V	Verify	
	2 • Operating freq. : 1300.00 MHz • Receiving			Less than 4.4 V		
	3 • Mode : FM mode • Receiving	MAIN unit	Connect a digital multimeter or an oscilloscope to the check point "LV2".	1.3–4.1 V		
	4 • Mode : DD mode • Receiving					
	5 • Mode : FM mode • Transmitting					
I/Q BALANCE [FPGA D.C. voltage adjustment /DV I]	1 • Preset "IQ Direct-current output" ON. • Operating freq. : 1270.00 MHz • Mode : DV mode • Connect an RF power meter or 50 Ω dummy load to the antenna connector. • Transmitting	MAIN unit	Connect a digital multimeter or an oscilloscope to the check point "CP.I".	The same voltage of the check point "CP.IR".	PC screen	[FPGA D.C. voltage adjustment /DV I]
[FPGA D.C. voltage adjustment /DV Q]	2 • Transmitting	MAIN unit	Connect a digital multimeter or an oscilloscope to the check point "CP.Q".	The same voltage of the check point "CP.QR".	PC screen	[FPGA D.C. voltage adjustment /DV Q]
[FPGA D.C. voltage adjustment /DV I]	3 • Transmitting	Rear panel	Connect a spectrum analyzer to the antenna connector through an attenuator.	Minimum output level	PC screen	[FPGA D.C. voltage adjustment /DV I], [FPGA D.C. voltage adjustment /DV Q]
[FPGA D.C. voltage adjustment /DV Q]						
• Repeat step 3 and step 4 several times.						

[LOGIC-1 UNIT]

REF NO.	PARTS NO.	DESCRIPTION	M.	H/V LOCATION
C561	4030007090	S.CER C1608 CH 1H 470J-T	T	85.7/51.4
C562	4030007090	S.CER C1608 CH 1H 470J-T	T	88.3/52.5
C563	4030007090	S.CER C1608 CH 1H 470J-T	T	103.0/42.0
C564	4030007090	S.CER C1608 CH 1H 470J-T	T	99.4/30.1
C565	4030007090	S.CER C1608 CH 1H 470J-T	B	96.3/34.6
C566	4030007090	S.CER C1608 CH 1H 470J-T	T	90.6/27.8
C567	4030007090	S.CER C1608 CH 1H 470J-T	T	85.4/27.8
C568	4030007090	S.CER C1608 CH 1H 470J-T	T	85.4/26.5
C569	4030007090	S.CER C1608 CH 1H 470J-T	T	78.9/28.4
C570	4030007090	S.CER C1608 CH 1H 470J-T	T	81.8/27.8
C571	4030007090	S.CER C1608 CH 1H 470J-T	B	93.2/44.5
C572	4030007090	S.CER C1608 CH 1H 470J-T	B	90.4/47.8
C573	4030007090	S.CER C1608 CH 1H 470J-T	T	89.0/47.8
C574	4030007090	S.CER C1608 CH 1H 470J-T	B	78.5/55.9
C575	4030007090	S.CER C1608 CH 1H 470J-T	T	78.5/53.1
C576	4030007090	S.CER C1608 CH 1H 470J-T	T	91.2/53.1
C577	4030007090	S.CER C1608 CH 1H 470J-T	T	91.2/55.9
C578	4030007090	S.CER C1608 CH 1H 470J-T	B	12.3/49.0
C579	4030007090	S.CER C1608 CH 1H 470J-T	B	10.7/47.0
J50	6510019271	S.CON 52365-0671	T	5.2/43.9
J100	6510021291	S.CON S10B-ZR-SM4A-TF(LF)(SN)	B	18.7/77.2
J101	6510022820	S.CON AXN430C530P	B	17.2/8.8
J300	6510018351	S.CON S3B-ZR-SM4A-TF(LF)(SN)	T	13.9/12.4
J400	6510022711	S.CON 30FLZ-SM2-TB(LF)(SN)	T	78.0/7.7
J401	6510022711	S.CON 30FLZ-SM2-TB(LF)(SN)	T	35.0/74.4
DS100	5040002050	LED SPR-39MVWF		
DS101	5040002050	LED SPR-39MVWF		
DS102	5040002050	LED SPR-39MVWF		
T100	5920000900	TRA ET001601 <HMT>		
EP2	6910012350	S.BEA MMZ1608Y 102BT	B	13.6/32.8
EP3	6910012350	S.BEA MMZ1608Y 102BT	T	7.2/38.3

[MAIN-1 UNIT]

REF NO.	PARTS NO.	DESCRIPTION	M.	H/V LOCATION
IC71	1110004470	S.IC UPC2721GV-E1	T	45.5/76.4
IC191	1110003491	S.IC TA31136FNG(DCL)	T	46.5/29.9
IC271	1110006750	S.IC TK14570LTL-G	T	81.8/33.3
IC341	1110001770	S.IC CD4066BPWVR	T	92.5/35.1
IC342	1110006221	S.IC TC4W53FU(TE12LF)	T	106.9/33.8
IC343	1110005290	S.IC NJM2115V-TE1-#ZZZB	T	98.2/28.2
IC345	1130004201	S.IC TC4S66F(TE85RF)	T	66.3/33.4
IC400	1130010100	S.IC LMX2352TMX/NOPB	B	25.6/64.8
IC550	1130007611	S.IC UPD3140GS-E1-A	B	12.7/35.0
IC551	1130006221	S.IC TC4W53FU(TE12LF)	B	21.0/43.6
IC830	1180003470	S.REG NJM2835DL1-05-TE1-#ZZZB	B	31.6/4.7
IC832	1110007510	S.IC NJM2717RB1-TE1-#ZZZB	B	57.8/33.0
IC890	1110007490	S.IC TRF3701IRHC	B	50.6/40.4
IC960	1110005150	S.IC UPC8163TB-E3	B	53.3/61.8
IC1021	1110006430	S.IC UPC1678GV-E1-A	T	68.2/53.9
IC1250	1110002751	S.IC TA75S01F(TE85RF)	B	78.9/124.3
IC1251	1110002751	S.IC TA75S01F(TE85RF)	B	80.1/116.0
IC1330	1180002080	S.REG BA09FP-E2	B	75.3/89.0
IC1331	1180001072	S.IC TA7805F(TE16L1NQ)	B	77.0/100.9
IC1332	1180002020	S.REG BA033FP-E2	B	36.4/96.1
IC1411	1130006221	S.IC TC4W53FU(TE12LF)	T	41.4/20.4
IC1460	1110003780	S.IC NJM2902V-TE1-#ZZZB	T	41.4/14.6
IC1461	1110003780	S.IC NJM2902V-TE1-#ZZZB	B	49.3/8.4
IC1462	1130006221	S.IC TC4W53FU(TE12LF)	B	42.1/14.6
IC1463	1130006221	S.IC TC4W53FU(TE12LF)	B	59.2/6.2
IC1550	1110003300	S.IC M5282FP 70CD	B	12.2/56.0
IC1551	1110003091	IC LA4425A-E		
IC1670	1130006221	S.IC TC4W53FU(TE12LF)	T	84.6/14.1
IC1671	1110004050	S.IC NJM3404AV-TE1-#FMZB	B	80.2/20.3
IC1672	1110005310	S.IC AN6123MS	T	74.7/12.9
IC1673	1130006221	S.IC TC4W53FU(TE12LF)	B	75.7/14.6
Q1	1590002970	S.FET NE34018-T1 64	T	57.3/105.2
Q2	1530003661	S.TRA 2SC5454-T1 YFB (R54)	T	52.2/90.4
Q131	1580000680	S.FET 3SK241-R(TX)	T	41.9/58.9
Q191	1530002601	S.TRA 2SC4215-O(TE85RF)	T	44.9/35.3
Q192	1530002280	S.TRA 2SC4081 T106 S	T	56.7/32.9
Q193	1530002280	S.TRA 2SC4081 T106 S	T	59.9/35.7
Q270	1530002601	S.TRA 2SC4215-O(TE85RF)	T	66.1/41.6
Q271	1530002601	S.TRA 2SC4215-O(TE85RF)	B	79.0/42.6
Q272	1590000720	S.TRA DTA144EUA T106	T	60.4/41.9
Q341	1590000720	S.TRA DTA144EUA T106	T	54.1/11.1
Q342	1590000430	S.TRA DTC144EUA T106	T	69.4/32.9
Q400	1530002921	S.TRA 2SC4226-T1 Y25 (R25)	T	23.2/52.5
Q470	1540000661	S.TRA 2SD2216GSL	T	14.6/74.6
Q471	1530003560	S.TRA 2SC5195-T1	T	25.7/73.1
Q472	1530003560	S.TRA 2SC5195-T1	T	23.5/73.3
Q473	1530002921	S.TRA 2SC4226-T1 Y25 (R25)	T	29.9/67.7
Q474	1530003311	S.TRA 2SC5107-O(TE85RF)	B	29.1/72.8
Q550	1530002280	S.TRA 2SC4081 T106 S	T	25.4/48.5
Q630	1590000430	S.TRA DTC144EUA T106	T	8.0/27.7
Q631	1530002921	S.TRA 2SC4226-T1 Y25 (R25)	T	23.7/32.8
Q632	1530002921	S.TRA 2SC4226-T1 Y25 (R25)	T	29.0/30.2
Q633	1530002921	S.TRA 2SC4226-T1 Y25 (R25)	B	26.3/29.8
Q634	1540000661	S.TRA 2SD2216GSL	T	30.3/35.0
Q710	1530003311	S.TRA 2SC5107-O(TE85RF)	B	38.6/73.3
Q770	1590001330	S.TRA DTA114EUA T106	B	34.1/58.9
Q771	1530002921	S.TRA 2SC4226-T1 Y25 (R25)	T	26.6/39.9
Q890	1530003311	S.TRA 2SC5107-O(TE85RF)	B	35.3/39.4
Q1080	1560001091	S.FET 2SK2854(T2LICOMF)	B	98.4/39.4
Q1081	1560001141	S.FET 2SK2855(TE12LF)	B	108.6/38.2
Q1082	1540000471	S.TRA 2SD1801S-TL-E	B	76.3/65.4
Q1250	1590000430	S.TRA DTC144EUA T106	B	64.8/127.1
Q1330	1590001320	S.TRA DTC143ZUA T106	B	63.8/108.7
Q1331	1510000890	S.TRA DTA143TU T106	B	63.8/105.3
Q1332	1530003910	S.TRA 2SC4684 (TE16L1 NQ)	B	63.4/98.7
Q1333	1520000730	S.TRA 2SB934P(DS)-(TX)	B	76.3/75.5
Q1334	1530002280	S.TRA 2SC4081 T106 S	B	63.1/74.7
Q1335	1590000430	S.TRA DTC144EUA T106	B	62.8/71.6
Q1336	1540000441	S.TRA 2SD1619T-TD-E	B	26.6/95.1
Q1337	1510000581	S.TRA 2SA1362-GR(TE85RF)	B	37.0/89.7
Q1338	1590000430	S.TRA DTC144EUA T106	T	27.5/95.2
Q1340	1590000430	S.TRA DTC144EUA T106	T	25.0/95.2
Q1341	1590000430	S.TRA DTC144EUA T106	T	35.4/96.8
Q1342	1510000581	S.TRA 2SA1362-GR(TE85RF)	B	40.2/87.8
Q1343	1510000581	S.TRA 2SA1362-GR(TE85RF)	B	42.9/93.8
Q1344	1590000430	S.TRA DTC144EUA T106	T	44.6/89.2
Q1345	1590000430	S.TRA DTC144EUA T106	B	63.4/57.8
Q1346	1590000430	S.TRA DTC144EUA T106	B	63.5/51.9
Q1347	1590000430	S.TRA DTC144EUA T106	B	66.6/52.8
Q1348	1510000581	S.TRA 2SA1362-GR(TE85RF)	B	55.2/55.7
Q1349	1510000581	S.TRA 2SA1362-GR(TE85RF)	B	60.9/55.4
Q1350	1510000581	S.TRA 2SA1362-GR(TE85RF)	B	39.9/34.2
Q1351	1590000430	S.TRA DTC144EUA T106	B	35.6/32.9
Q1352	1590000430	S.TRA DTC144EUA T106	B	48.2/89.4
Q1460	1530002280	S.TRA 2SC4081 T106 S	T	5.9/75.3
Q1550	1560000831	S.FET 2SK2036 (TE85LF)	B	10.4/70.1
Q1600	1540000251	S.TRA 2SD999-T2-AZ CK	B	11.0/19.2
Q1603	1530002280	S.TRA 2SC4081 T106 S	T	108.6/20.1
Q1670	1590001451	S.FET 2SJ144-GR (TE85RF)	T	98.1/16.1
Q1671	1590000430	S.TRA DTC144EUA T106	T	96.0/12.9
Q1673	1530002280	S.TRA 2SC4081 T106 S	T	92.8/16.4
Q1750	1520000201	S.TRA 2SB798-T2-AZ DK	B	23.2/114.9
Q1751	1530002280	S.TRA 2SC4081 T106 S	T	26.5/119.1
Q1800	1590000430	S.TRA DTC144EUA T106	T	11.0/24.8

M.=Mounted side (T: Mounted on the Top side, B: Mounted on the Bottom side)
S.=Surface mount

[MAIN-1 UNIT]

REF NO.	PARTS NO.	DESCRIPTION	M.	H/V LOCATION
C1695	4030008890	S.CER C1608 JB 1H 273K-T	B	89.8/3.0
C1696	4030011600	S.CER C1608 JB 1E 104K-T	T	1.7/11.4
C1697	4030007090	S.CER C1608 CH 1H 470J-T	T	40.2/2.5
C1698	4030007090	S.CER C1608 CH 1H 470J-T	T	1.7/12.6
C1699	4030007090	S.CER C1608 CH 1H 470J-T	T	25.0/1.7
C1700	4030007090	S.CER C1608 CH 1H 470J-T	B	5.4/91.6
C1750	4030006900	S.CER C1608 JB 1H 103K-T	T	26.9/12.2
C1751	4030006850	S.CER C1608 JB 1H 471K-T	T	54.6/123.8
C1752	4030006900	S.CER C1608 JB 1H 103K-T	T	28.6/119.3
C1753	4030006860	S.CER C1608 JB 1H 102K-T	T	24.2/120.5
C1754	4510008520	S.ELE EEE1CA470SP	T	31.8/127.5
C1755	4030007090	S.CER C1608 CH 1H 470J-T	T	25.8/113.2
C1800	4030007090	S.CER C1608 CH 1H 470J-T	B	24.0/20.5
C1801	4030006900	S.CER C1608 JB 1H 103K-T	T	42.0/103.6
C1802	4030006900	S.CER C1608 JB 1H 103K-T	T	42.5/112.3
C1803	4030006850	S.CER C1608 JB 1H 471K-T	T	28.6/104.1
C1804	4030006850	S.CER C1608 JB 1H 471K-T	T	32.4/103.3
C1805	4030006850	S.CER C1608 JB 1H 471K-T	T	27.8/101.5
C1806	4030006850	S.CER C1608 JB 1H 471K-T	T	32.4/99.7
C1807	4030006850	S.CER C1608 JB 1H 471K-T	T	42.0/101.4
C1808	4030007090	S.CER C1608 CH 1H 470J-T	T	38.8/112.0
J1550	6450001440	CON HSJ1403-01-010		
J1600	6510016481	CON 52018-8846(8845)		
J1602	6510021970	S.CON AXN330C130P	T	26.2/21.8
J1750	6510009351	CON B2B-ZR(LF)(SN)		
J1800	6510021722	S.CON 30FLT-SM2-TB(LF)(SN)(M)	T	44.0/107.5
J1801	6510021722	S.CON 30FLT-SM2-TB(LF)(SN)(M)	T	87.0/5.8
S1601	2260002590	SWI SKHHLU		
W1164	7030012280	JUM RD25T0R0		
W1330	8900011960	CAB OPC-1216		
EP5	6910000630	BEA FSRH070140RN000B (FSOH070RN)		
EP6	6910000630	BEA FSRH070140RN000B (FSOH070RN)		
EP401	6910012350	S.BEA MMZ1608Y 102BT	B	16.5/70.3
EP403	6910012350	S.BEA MMZ1608Y 102BT	B	20.8/63.0
EP404	6910012350	S.BEA MMZ1608Y 102BT	T	14.5/60.4
EP405	6910012350	S.BEA MMZ1608Y 102BT	T	21.3/66.3
EP470	6910012350	S.BEA MMZ1608Y 102BT	T	16.4/68.3
EP482	6910012350	S.BEA MMZ1608Y 102BT	B	12.9/82.9
EP550	6910012350	S.BEA MMZ1608Y 102BT	B	24.6/39.8
EP551	6910012350	S.BEA MMZ1608Y 102BT	B	35.1/26.6
EP552	6910012350	S.BEA MMZ1608Y 102BT	B	27.1/48.7
EP553	6910012350	S.BEA MMZ1608Y 102BT	B	18.0/48.1
EP721	6910012350	S.BEA MMZ1608Y 102BT	B	32.1/85.5
EP1601	6910014690	S.BEA MPZ1608S221A-T	T	114.3/16.5
EP1602	6910014690	S.BEA MPZ1608S221A-T	T	105.1/18.2
EP1603	6910014690	S.BEA MPZ1608S221A-T	T	104.4/14.1
EP1604	6910014690	S.BEA MPZ1608S221A-T	T	109.0/12.4
EP1606	6910014690	S.BEA MPZ1608S221A-T	B	114.4/12.3
EP1607	6910014690	S.BEA MPZ1608S221A-T	T	113.5/13.9
EP1608	6910014690	S.BEA MPZ1608S221A-T	T	102.7/11.9
EP1609	6910014690	S.BEA MPZ1608S221A-T	B	107.5/8.6
EP1750	6910012350	S.BEA MMZ1608Y 102BT	B	27.8/124.0
EP1751	6910012350	S.BEA MMZ1608Y 102BT	B	27.8/125.5

M.=Mounted side (T: Mounted on the Top side, B: Mounted on the Bottom side)
S.=Surface mount

VOLTAGE DIAGRAM

LOGIC-1 UNIT(1)

Explanatory notes

- TX Line
- RX Line
- Common Line
- Voltage Line

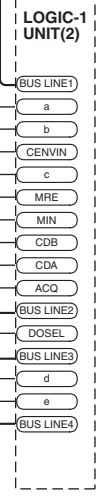
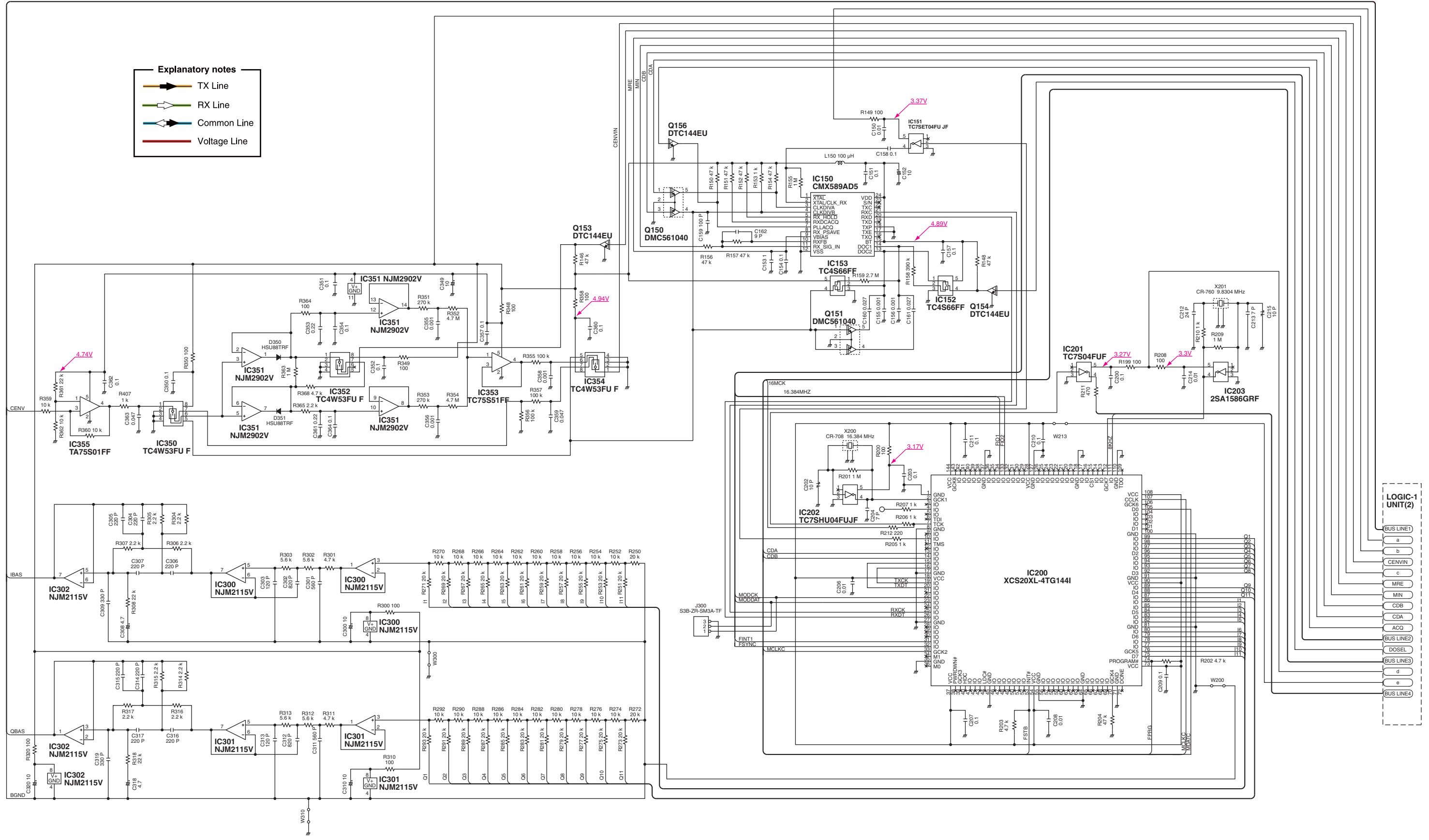

*; Refer to "PARTS LIST."

LOGIC-1 UNIT(2)

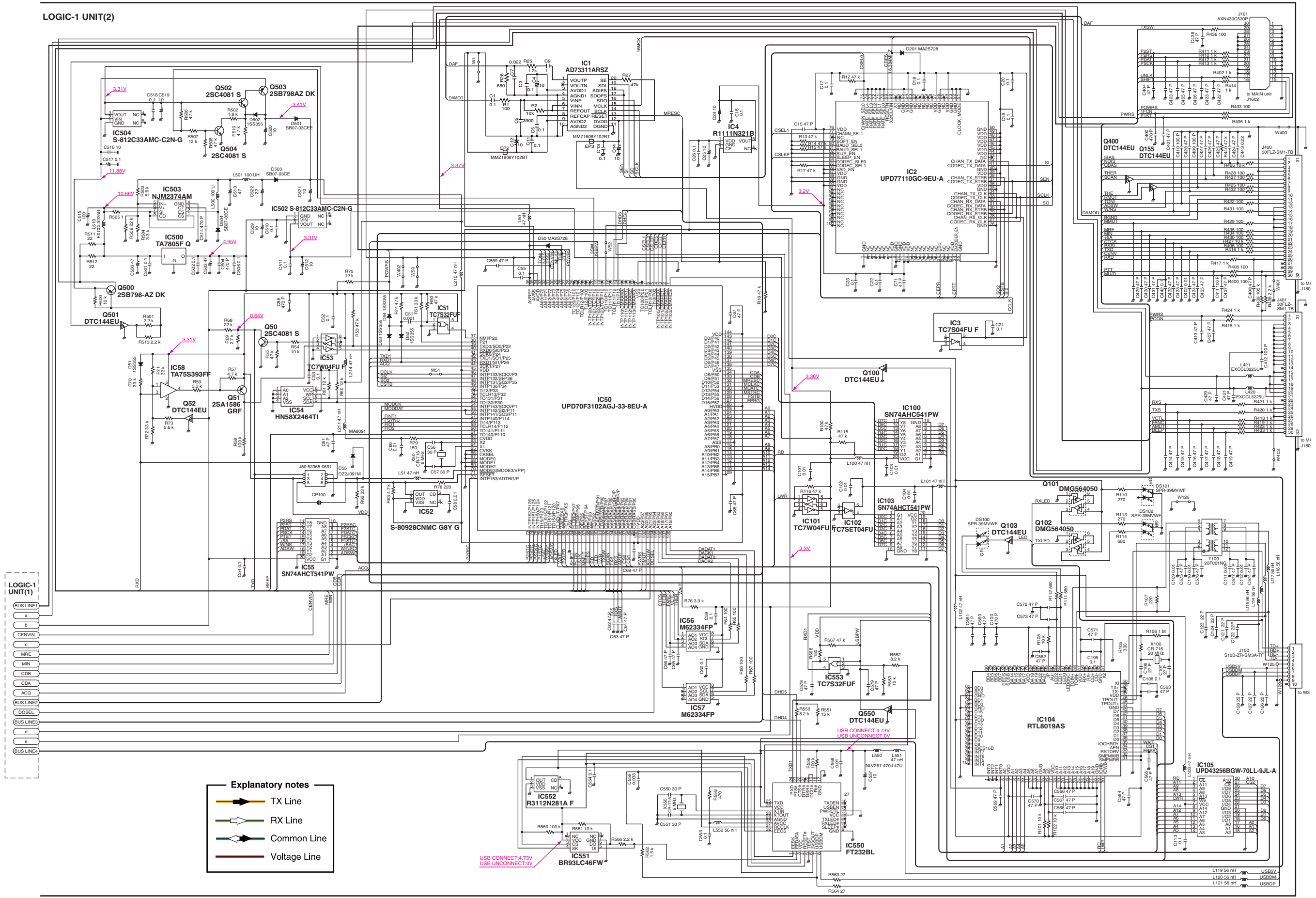

Explanatory notes

- TX Line
- RX Line
- Common Line
- Voltage Line

*; Refer to "PARTS LIST"

MAIN-1 UNIT (1)

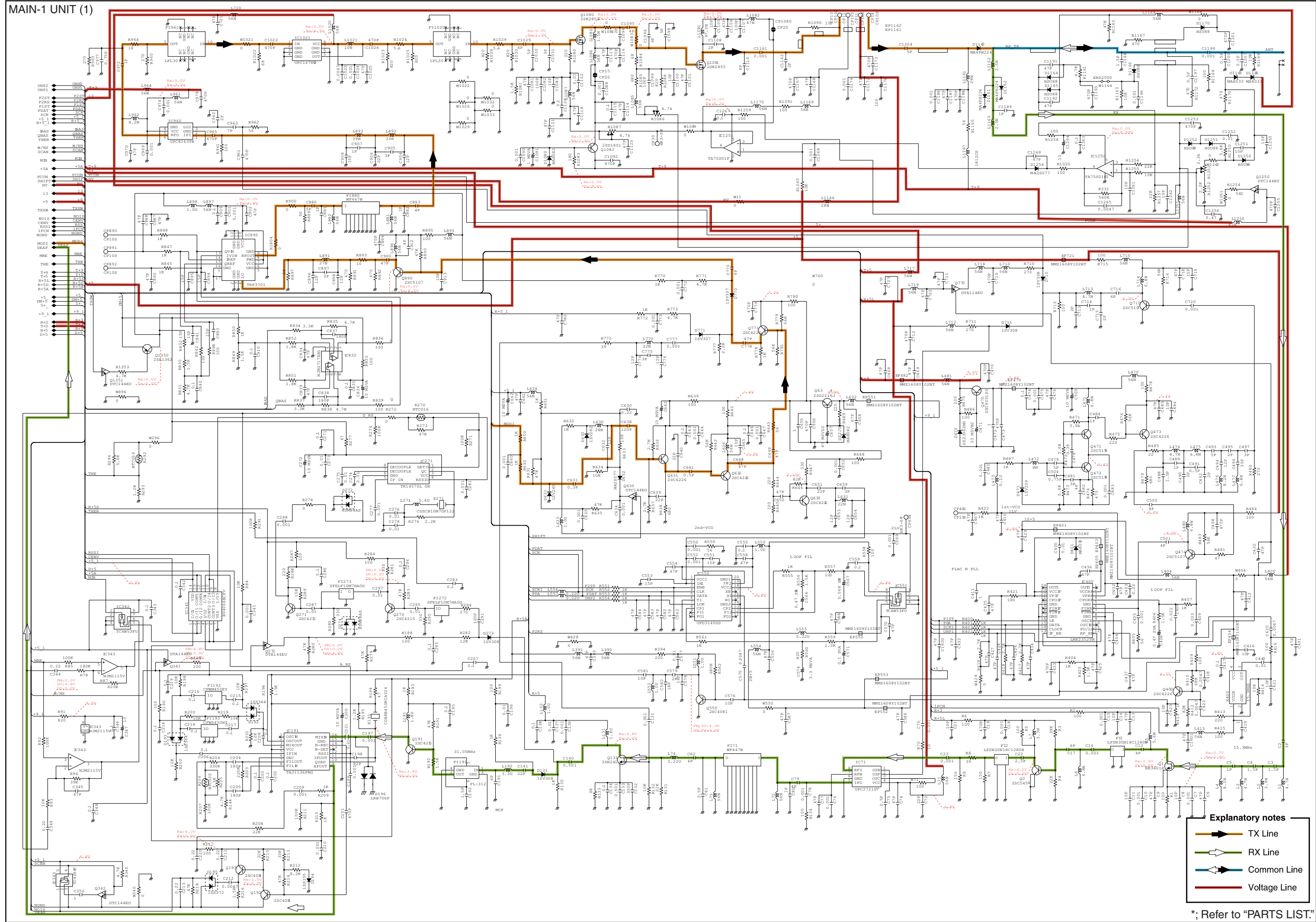

Explanatory notes

- TX Line
- RX Line
- Common Line
- Voltage Line

*; Refer to "PARTS LIST."

MAIN-1 UNIT (2)

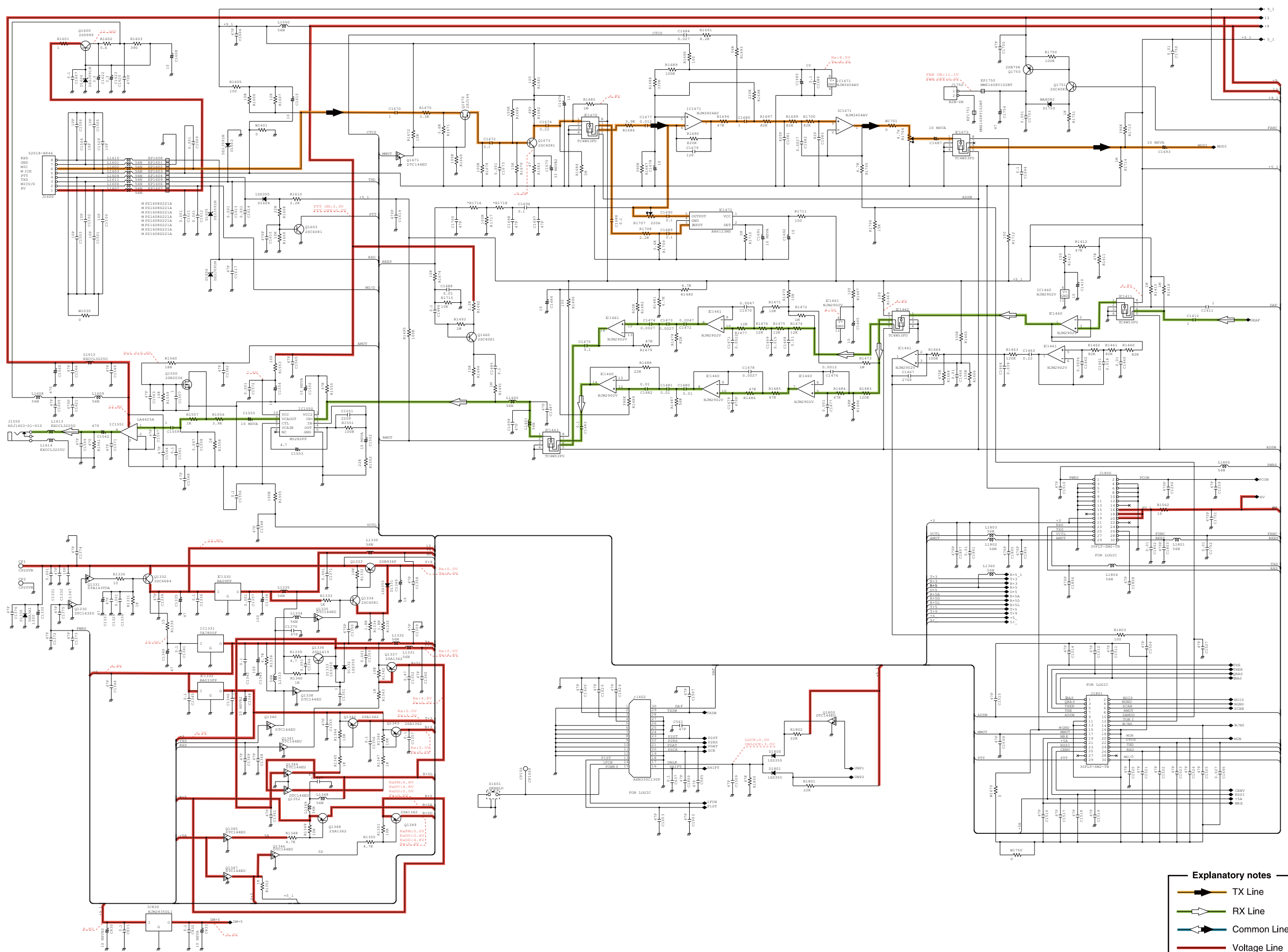

Explanatory notes

- TX Line
- RX Line
- Common Line
- Voltage Line

*; Refer to "PARTS LIST."

Nov. 2010



SERVICE MANUAL ADDENDUM

ID-1

CONTENTS

PARTS LIST	1
BOARD LAYOUTS	12
VOLTAGE DIAGRAM	14

[LOGIC-1 UNIT]

REF NO.	PARTS NO.	DESCRIPTION	M.	H/V LOCATION
C561	4030007090	S.CER C1608 CH 1H 470J-T	T	85.7/51.4
C562	4030007090	S.CER C1608 CH 1H 470J-T	T	88.3/52.5
C563	4030007090	S.CER C1608 CH 1H 470J-T	T	103.0/42.0
C564	4030007090	S.CER C1608 CH 1H 470J-T	T	99.4/30.1
C565	4030007090	S.CER C1608 CH 1H 470J-T	B	96.3/34.6
C566	4030007090	S.CER C1608 CH 1H 470J-T	T	90.6/27.8
C567	4030007090	S.CER C1608 CH 1H 470J-T	T	85.4/27.8
C568	4030007090	S.CER C1608 CH 1H 470J-T	T	85.4/26.5
C569	4030007090	S.CER C1608 CH 1H 470J-T	T	78.9/28.4
C570	4030007090	S.CER C1608 CH 1H 470J-T	T	81.8/27.8
C571	4030007090	S.CER C1608 CH 1H 470J-T	B	93.2/44.5
C572	4030007090	S.CER C1608 CH 1H 470J-T	B	90.4/47.8
C573	4030007090	S.CER C1608 CH 1H 470J-T	B	89.0/47.8
C574	4030007090	S.CER C1608 CH 1H 470J-T	T	78.5/55.9
C575	4030007090	S.CER C1608 CH 1H 470J-T	T	78.5/53.1
C576	4030007090	S.CER C1608 CH 1H 470J-T	T	91.2/53.1
C577	4030007090	S.CER C1608 CH 1H 470J-T	T	91.2/55.9
C578	4030007090	S.CER C1608 CH 1H 470J-T	B	12.3/49.0
C579	4030007090	S.CER C1608 CH 1H 470J-T	B	10.7/47.0
J50	6510019271	S.CON 52365-0671	T	5.2/43.9
J100	6510021291	S.CON S10B-ZR-SM4A-TF(LF)(SN)	B	18.7/77.2
J101	6510022820	S.CON AXN430C530P	B	17.2/8.8
J300	6510018351	S.CON S3B-ZR-SM4A-TF(LF)(SN)	T	13.9/12.4
J400	6510022711	S.CON 30FLZ-SM2-TB(LF)(SN)	T	78.0/7.7
J401	6510022711	S.CON 30FLZ-SM2-TB(LF)(SN)	T	35.0/74.4
DS100	5040002050	LED SPR-39MVVWF		
DS101	5040002050	LED SPR-39MVVWF		
DS102	5040002050	LED SPR-39MVVWF		
T100	5920000900	TRA ET001601 <HMT>		
EP2	6910012350	S.BEA MMZ1608Y 102BT	B	13.6/32.8
EP3	6910012350	S.BEA MMZ1608Y 102BT	T	7.2/38.3

[MAIN-1 UNIT]

REF NO.	PARTS NO.	DESCRIPTION	M.	H/V LOCATION
IC71	1110004470	S.IC UPC2721GV-E1	T	45.5/76.4
IC191	1110003491	S.IC TA31136FNG(DEL)	T	46.5/29.9
IC271	1110006750	S.IC TK14570LTL-D	T	81.8/33.3
IC341	1130011770	S.IC CD4066BPWR	T	92.5/35.1
IC342	1130006221	S.IC TC4W53FU(TE12LF)	T	106.9/33.8
IC343	1110005290	S.IC NJM2115V-TE1-#ZZZB	T	98.2/28.2
IC345	1130004201	S.IC TC4S66F(TE85RF)	T	66.3/33.4
IC400	1130010100	S.IC LMX2352TMX/NOPB	B	25.6/64.8
IC550	1130007611	S.IC UPD3140GS-E1-A	B	12.7/35.0
IC551	1130006221	S.IC TC4W53FU(TE12LF)	B	21.0/43.6
IC830	1180003470	S.REG NJM2835DL1-05-TE1-#ZZZB	B	31.6/4.7
IC832	1110007510	S.IC NJM2717RB1-TE1-#ZZZB	B	57.8/33.4
IC890	1110007490	S.IC TRF3701IRHC	B	50.6/40.4
IC960	1110005150	S.IC UPC8163TB-E3	B	53.3/61.8
IC1021	1110006430	S.IC UPC1678GV-E1-A	T	68.2/53.9
IC1250	1110002751	S.IC TA75S01F(TE85RF)	B	78.9/124.3
IC1251	1110002751	S.IC TA75S01F(TE85RF)	B	80.1/116.0
IC1330	1180002080	S.REG BA09FP-E2	B	75.3/89.0
IC1331	1180001072	S.IC TA7805F(TE16L1NQ)	B	77.0/100.9
IC1332	1180002020	S.REG BA033FP-E2	B	36.4/96.1
IC1411	1130006221	S.IC TC4W53FU(TE12LF)	T	41.4/20.4
IC1460	1110003780	S.IC NJM2902V-TE1-#ZZZB	T	41.4/14.6
IC1461	1110003780	S.IC NJM2902V-TE1-#ZZZB	B	49.3/8.4
IC1462	1130006221	S.IC TC4W53FU(TE12LF)	B	42.1/14.6
IC1463	1130006221	S.IC TC4W53FU(TE12LF)	B	59.2/6.2
IC1550	1110003300	S.IC M5282FP 70CD	B	12.2/56.0
IC1551	1110003091	IC LA4425A-E		
IC1670	1130006221	S.IC TC4W53FU(TE12LF)	T	84.6/14.1
IC1671	1110004050	S.IC NJM3404AV-TE1-#FMZB	B	80.2/20.3
IC1672	1110005310	S.IC AN6123MS	T	74.7/12.9
IC1673	1130006221	S.IC TC4W53FU(TE12LF)	B	75.7/14.6
Q1	1590002970	S.FET NE34018-T1 64	T	57.3/105.2
Q2	1530003660	S.TRA 2SC5454-T1 R54	T	52.2/90.4
Q131	1580000680	S.FET 3SK241-R(TX)	T	41.9/58.9
Q191	1530002601	S.TRA 2SC4215-O(TE85RF)	T	42.6/36.2
Q192	1530002280	S.TRA 2SC4081 T106 S	T	56.7/32.9
Q193	1530002280	S.TRA 2SC4081 T106 S	T	59.9/35.7
Q270	1530002601	S.TRA 2SC4215-O(TE85RF)	T	66.1/41.6
Q271	1530002601	S.TRA 2SC4215-O(TE85RF)	B	79.0/42.6
Q272	1590000720	S.TRA DTA144EUA T106	T	60.4/41.9
Q341	1590000720	S.TRA DTA144EUA T106	T	54.1/11.1
Q342	1590000430	S.TRA DTC144EUA T106	T	69.4/32.9
Q400	1530002920	S.TRA 2SC4226-T1 R25	T	23.2/52.5
Q470	1540000661	S.TRA 2SD2216GSL	T	14.6/74.6
Q471	1530003560	S.TRA 2SC5195-T1	T	25.7/73.1
Q472	1530003560	S.TRA 2SC5195-T1	T	23.5/73.3
Q473	1530002920	S.TRA 2SC4226-T1 R25	T	29.9/67.7
Q474	1530003311	S.TRA 2SC5107-O(TE85RF)	B	29.1/72.8
Q550	1530002280	S.TRA 2SC4081 T106 S	T	25.4/48.5
Q630	1590000430	S.TRA DTC144EUA T106	T	8.0/27.7
Q631	1530002920	S.TRA 2SC4226-T1 R25	T	23.7/32.8
Q632	1530002920	S.TRA 2SC4226-T1 R25	T	29.0/30.2
Q633	1530002920	S.TRA 2SC4226-T1 R25	B	26.3/29.8
Q634	1540000661	S.TRA 2SD2216GSL	T	30.3/35.0
Q710	1530003311	S.TRA 2SC5107-O(TE85RF)	B	38.6/73.3
Q770	1590001330	S.TRA DTA114EUA T106	B	34.1/58.9
Q771	1530002920	S.TRA 2SC4226-T1 R25	T	26.6/39.9
Q890	1530003311	S.TRA 2SC5107-O(TE85RF)	B	35.3/39.4
Q1080	1560001091	S.FET 2SK2854(T2LICOMF)	B	98.4/39.4
Q1081	1560001141	S.FET 2SK2855(TE12LF)	B	108.6/38.2
Q1082	1540000471	S.TRA 2SD1801S-TL-E	B	76.3/65.4
Q1250	1590000430	S.TRA DTC144EUA T106	B	64.8/127.1
Q1330	1590001320	S.TRA DTC143ZUA T106	B	63.8/108.7
Q1331	1510000890	S.TRA DTA143TU T106	B	63.8/105.3
Q1332	1530003910	S.TRA 2SC4684 (TE16L1 NQ)	B	63.4/98.7
Q1333	1520000730	S.TRA 2SB934P(DS)-(TX)	B	76.3/75.5
Q1334	1530002280	S.TRA 2SC4081 T106 S	B	63.1/74.7
Q1335	1590000430	S.TRA DTC144EUA T106	B	62.8/71.6
Q1336	1540000441	S.TRA 2SD1619T-TD-E	B	26.6/95.1
Q1337	1510000581	S.TRA 2SA1362-GR(TE85RF)	B	37.0/89.7
Q1338	1590000430	S.TRA DTC144EUA T106	T	27.5/95.2
Q1340	1590000430	S.TRA DTC144EUA T106	T	25.0/95.2
Q1341	1590000430	S.TRA DTC144EUA T106	T	35.4/96.8
Q1342	1510000581	S.TRA 2SA1362-GR(TE85RF)	B	40.2/87.8
Q1343	1510000581	S.TRA 2SA1362-GR(TE85RF)	B	42.9/93.8
Q1344	1590000430	S.TRA DTC144EUA T106	T	44.6/89.2
Q1345	1590000430	S.TRA DTC144EUA T106	B	63.4/57.8
Q1346	1590000430	S.TRA DTC144EUA T106	B	63.5/51.9
Q1347	1590000430	S.TRA DTC144EUA T106	B	66.6/52.8
Q1348	1510000581	S.TRA 2SA1362-GR(TE85RF)	B	55.2/55.7
Q1349	1510000581	S.TRA 2SA1362-GR(TE85RF)	B	60.9/55.4
Q1350	1510000581	S.TRA 2SA1362-GR(TE85RF)	B	39.9/34.2
Q1351	1590000430	S.TRA DTC144EUA T106	B	35.6/32.9
Q1352	1590000430	S.TRA DTC144EUA T106	B	48.2/89.4
Q1460	1530002280	S.TRA 2SC4081 T106 S	T	5.9/75.3
Q1550	1560000831	S.FET 2SK2036 (TE85LF)	B	10.4/70.1
Q1600	1540000251	S.TRA 2SD999-T2-AZ CK	B	110.1/19.2
Q1603	1530002280	S.TRA 2SC4081 T106 S	T	108.6/20.1
Q1670	1590001451	S.FET 2SJ144-GR (TE85RF)	T	98.1/16.1
Q1671	1590000430	S.TRA DTC144EUA T106	T	96.0/12.9
Q1673	1530002280	S.TRA 2SC4081 T106 S	T	92.8/16.4
Q1750	1520000201	S.TRA 2SB798-T2-AZ DK	B	23.2/114.9
Q1751	1530002280	S.TRA 2SC4081 T106 S	T	26.5/119.1
Q1800	1590000430	S.TRA DTC144EUA T106	T	11.0/24.8

M.=Mounted side (T: Mounted on the Top side, B: Mounted on the Bottom side)
S.=Surface mount

[MAIN-1 UNIT]

REF NO.	PARTS NO.	DESCRIPTION	M.	H/V LOCATION
C1750	4030006900	S.CER C1608 JB 1H 103K-T	T	26.9/12.2
C1751	4030006850	S.CER C1608 JB 1H 471K-T	T	54.6/123.8
C1752	4030006900	S.CER C1608 JB 1H 103K-T	T	28.6/119.3
C1753	4030006860	S.CER C1608 JB 1H 102K-T	T	24.2/120.5
C1754	4510008520	S.ELE EEE1CA470SP	T	31.8/127.5
C1755	4030007090	S.CER C1608 CH 1H 470J-T	T	25.8/113.2
C1800	4030007090	S.CER C1608 CH 1H 470J-T	B	24.0/20.5
C1801	4030006900	S.CER C1608 JB 1H 103K-T	T	42.0/103.6
C1802	4030006900	S.CER C1608 JB 1H 103K-T	T	42.5/112.3
C1803	4030006850	S.CER C1608 JB 1H 471K-T	T	28.6/104.1
C1804	4030006850	S.CER C1608 JB 1H 471K-T	T	32.4/103.3
C1805	4030006850	S.CER C1608 JB 1H 471K-T	T	27.8/101.5
C1806	4030006850	S.CER C1608 JB 1H 471K-T	T	32.4/99.7
C1807	4030006850	S.CER C1608 JB 1H 471K-T	T	42.0/101.4
C1808	4030007090	S.CER C1608 CH 1H 470J-T	T	38.8/112.0
J1550	6450001440	CON HSJ1403-01-010		
J1600	6510016481	CON 52018-8846(8845)		
J1602	6510021970	S.CON AXN330C130P	T	26.2/21.8
J1750	6510009351	CON B2B-ZR(LF)(SN)		
J1800	6510021722	S.CON 30FLT-SM2-TB(LF)(SN)(M)	T	44.0/107.5
J1801	6510021722	S.CON 30FLT-SM2-TB(LF)(SN)(M)	T	87.0/5.8
S1601	2260002590	SWI SKHHLU		
W1164	7030012280	JUM RD25T0R0		
W1330	8900011960	CAB OPC-1216		
EP5	6910000630	BEA FSRH070140RN000B (FSOH070RN)		
EP6	6910000630	BEA FSRH070140RN000B (FSOH070RN)		
EP401	6910012350	S.BEA MMZ1608Y 102BT	B	16.5/70.3
EP403	6910012350	S.BEA MMZ1608Y 102BT	B	20.8/63.0
EP404	6910012350	S.BEA MMZ1608Y 102BT	T	14.5/60.4
EP405	6910012350	S.BEA MMZ1608Y 102BT	T	21.3/66.3
EP470	6910012350	S.BEA MMZ1608Y 102BT	T	16.4/68.3
EP482	6910012350	S.BEA MMZ1608Y 102BT	B	12.9/82.9
EP550	6910012350	S.BEA MMZ1608Y 102BT	B	24.6/39.8
EP551	6910012350	S.BEA MMZ1608Y 102BT	B	35.1/26.6
EP552	6910012350	S.BEA MMZ1608Y 102BT	B	27.1/48.7
EP553	6910012350	S.BEA MMZ1608Y 102BT	B	18.0/48.1
EP721	6910012350	S.BEA MMZ1608Y 102BT	B	32.1/85.5
EP1601	6910014690	S.BEA MPZ1608S221A-T	T	114.3/16.5
EP1602	6910014690	S.BEA MPZ1608S221A-T	T	105.1/18.2
EP1603	6910014690	S.BEA MPZ1608S221A-T	T	104.4/14.1
EP1604	6910014690	S.BEA MPZ1608S221A-T	T	109.0/12.4
EP1606	6910014690	S.BEA MPZ1608S221A-T	B	114.4/12.3
EP1607	6910014690	S.BEA MPZ1608S221A-T	T	113.5/13.9
EP1608	6910014690	S.BEA MPZ1608S221A-T	T	102.7/11.9
EP1609	6910014690	S.BEA MPZ1608S221A-T	B	107.5/8.6
EP1750	6910012350	S.BEA MMZ1608Y 102BT	B	27.8/124.0
EP1751	6910012350	S.BEA MMZ1608Y 102BT	B	27.8/125.5

M.=Mounted side (T: Mounted on the Top side, B: Mounted on the Bottom side)
S.=Surface mount

BOARD LAYOUTS

The combination of this side and the bottom side shows the board layout in the same configuration as the actual P.C.Board.

• LOGIC-1 UNIT (TOP VIEW)

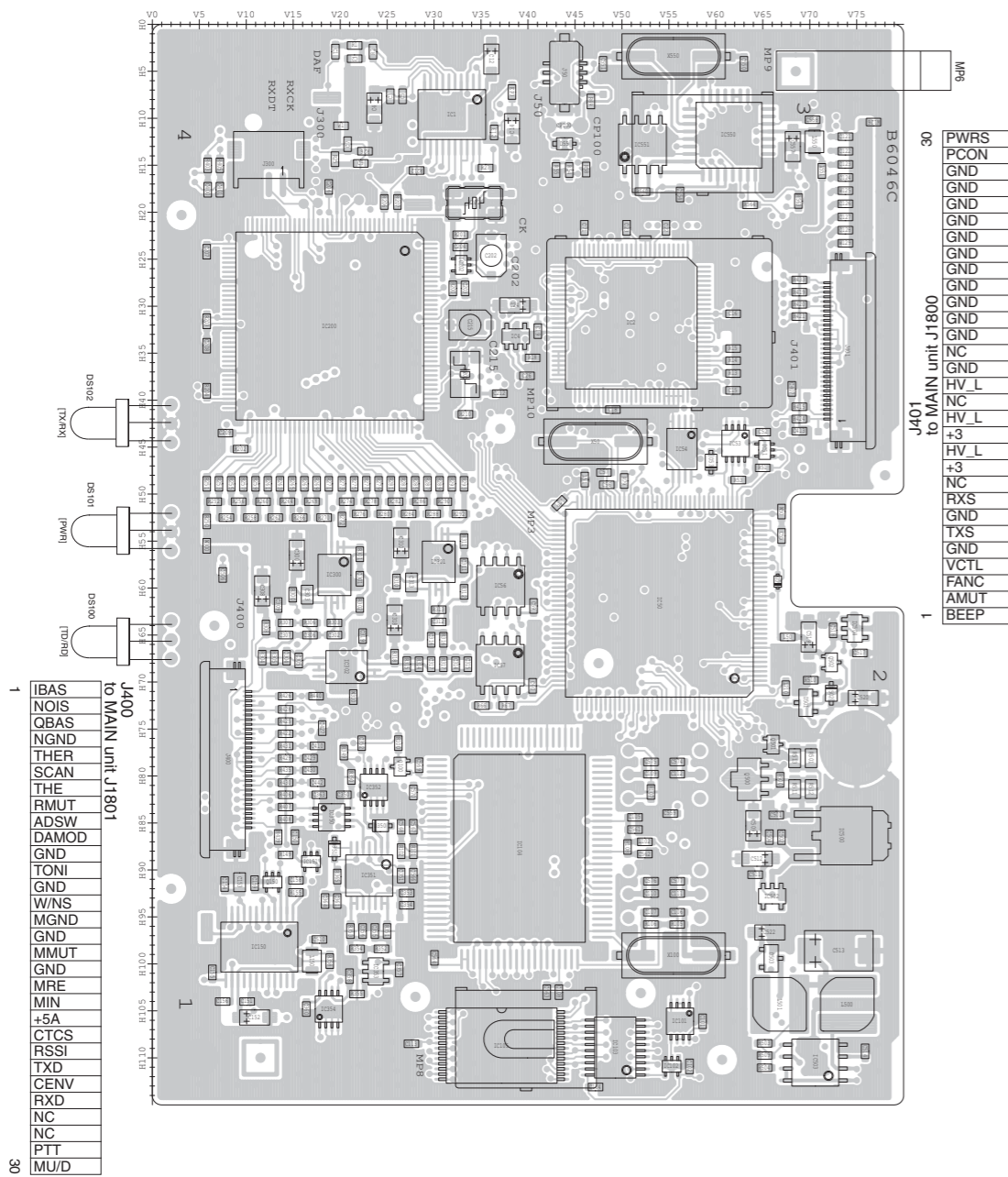

• MAIN-1 UNIT (TOP VIEW)

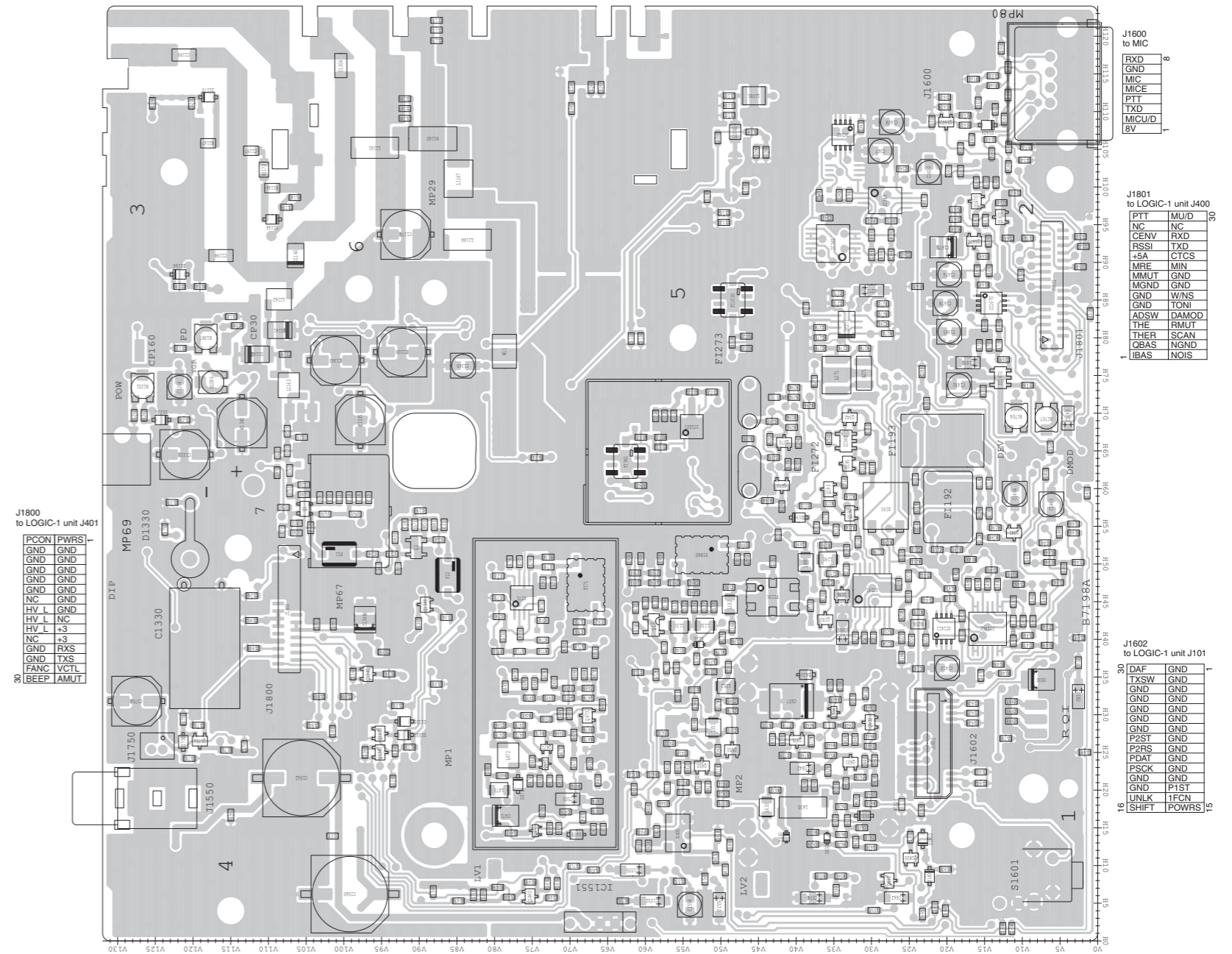

The combination of this side and the bottom side shows the board layout in the same configuration as the actual P.C.Board.

• MAIN-1 UNIT
(BOTTOM VIEW)

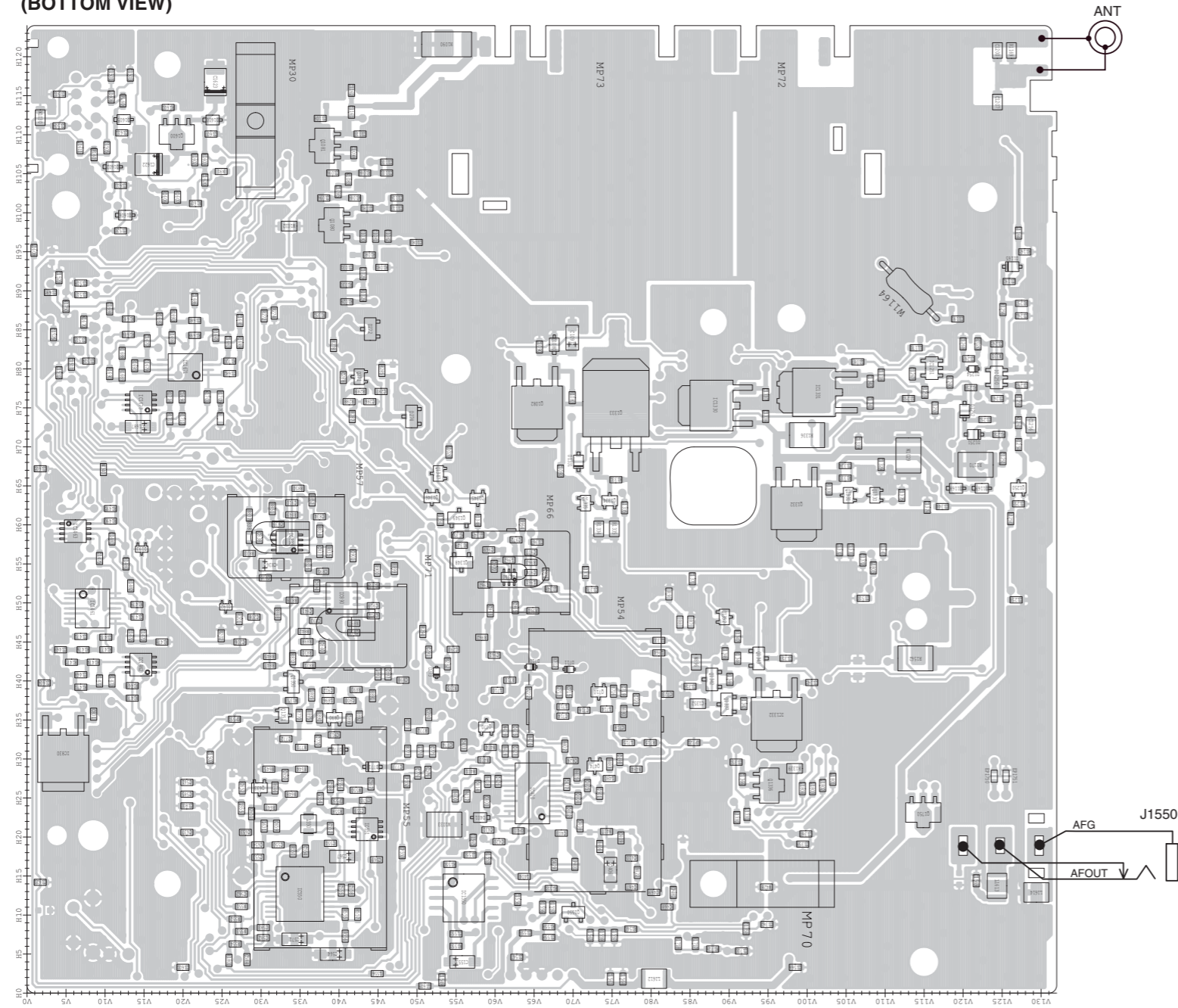

• LOGIC-1 UNIT
(BOTTOM VIEW)

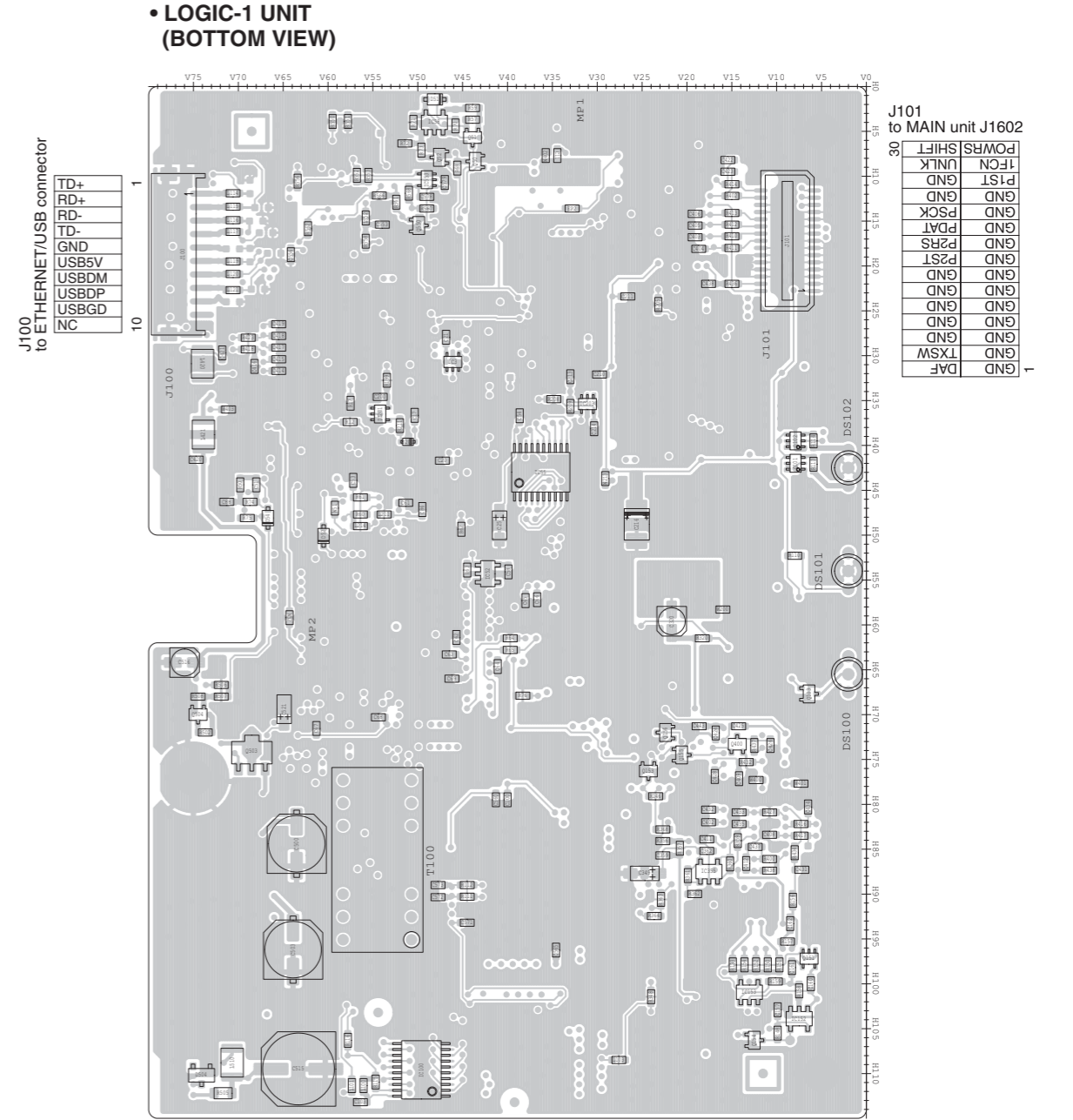

VOLTAGE DIAGRAM

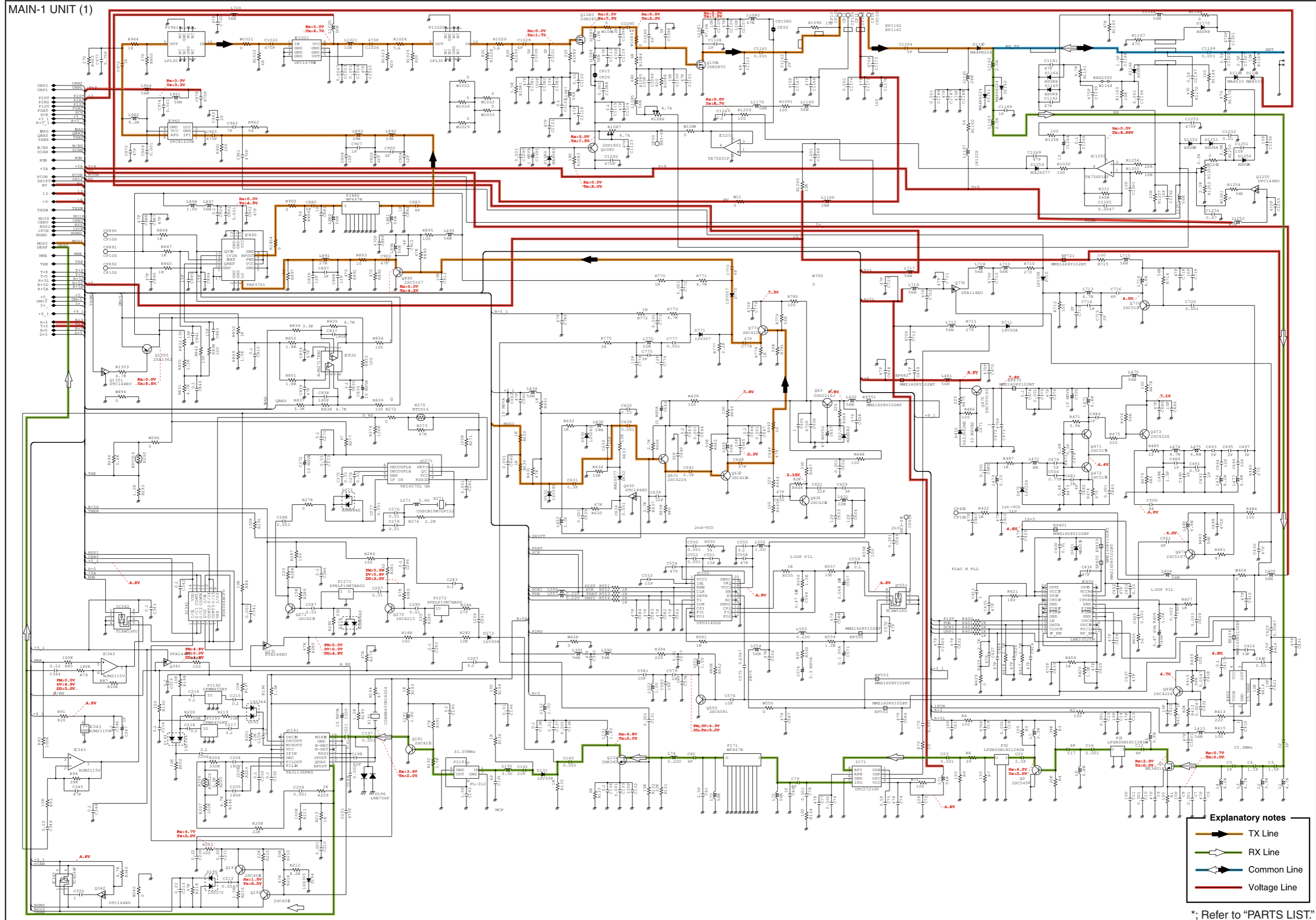

MAIN-1 UNIT (2)

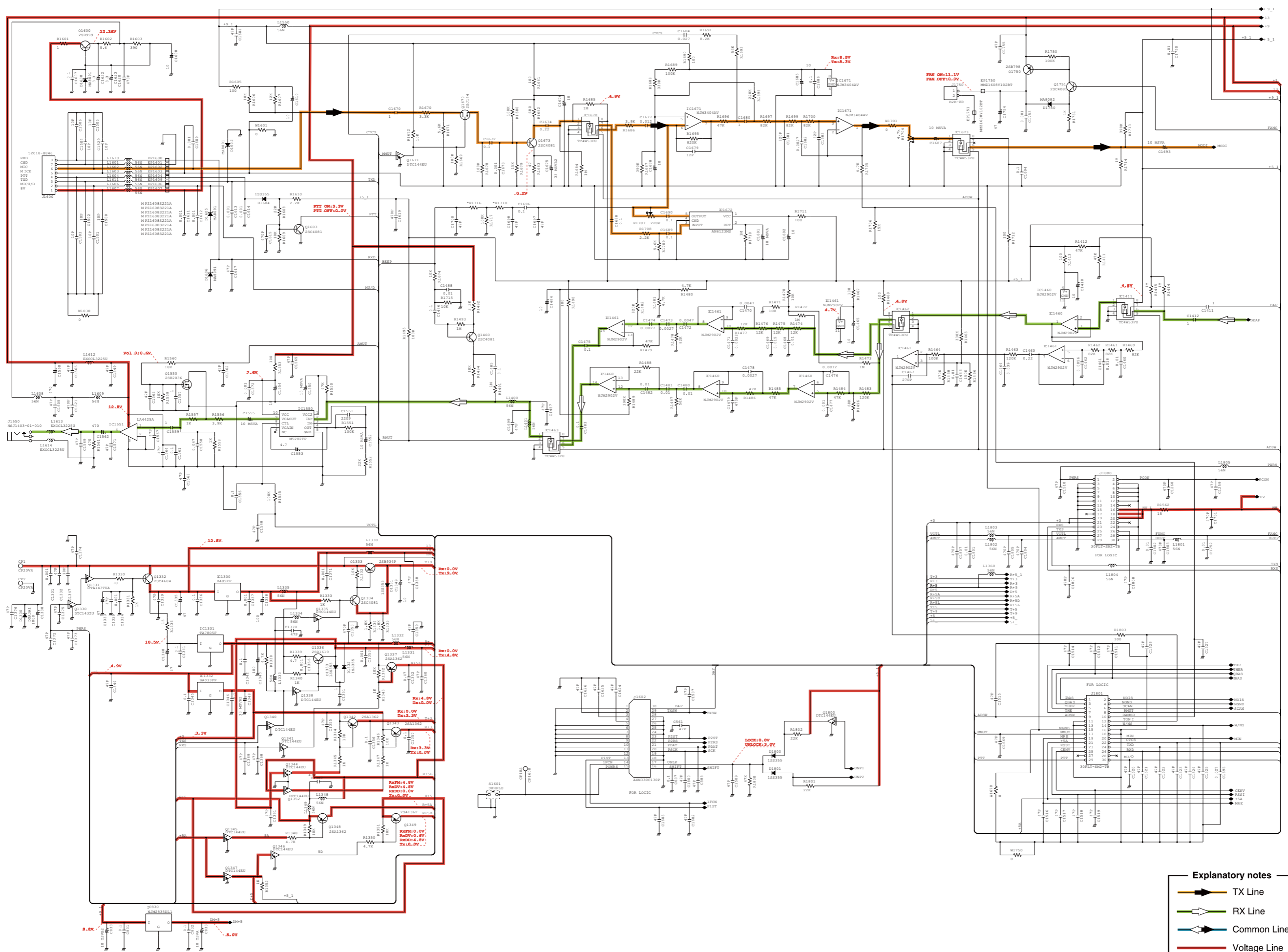

Explanatory notes

- TX Line
- RX Line
- Common Line
- Voltage Line

*; Refer to "PARTS LIST."

Jan. 2009



SERVICE MANUAL ADDENDUM

ID-1

CONTENTS

REPLACEMENT PAGE	5-5
PARTS LIST	1
BOARD LAYOUTS	11
VOLTAGE DIAGRAM	13

5-3 TRANSMITTER ADJUSTMENT

ADJUSTMENT	ADJUSTMENT CONDITION	MEASUREMENT		VALUE	ADJUSTMENT		
		UNIT	LOCATION		UNIT	ADJUST	
YGR CURRENT [FPGA D.C. voltage ad- justment /DV I]	1	<ul style="list-style-type: none"> • Preset R1086 and R1087 maximum counterclockwise. • Preset "IQ Direct-current output" ON. 	Rear panel	Connect an ammeter between the DC power supply and ID-1.	100 mA higher from the pre-set position.	MAIN unit	R1087
	2	<ul style="list-style-type: none"> • Operating freq. : 1300.00 MHz • Mode : DV mode • Connect an RF power meter or 50 Ω dummy load to the antenna connector. • Transmitting 			100 mA higher from step 1.	MAIN unit	R1086
REFERENCE FREQUENCY [REF Crystal adjustment]	1	<ul style="list-style-type: none"> • Operating freq. : 1300.00 MHz • Mode : FM mode • Connect an RF power meter or 50 Ω dummy load to the antenna connector. • Transmitting 	Rear panel	Loosely couple a frequency counter to the antenna connector.	1300.0000 MHz	PC screen	[REF Crystal adjustment]
FM CARRIER [FPGA D.C. voltage ad- justment /FM I]	1	<ul style="list-style-type: none"> • Operating freq. : 1300.00 MHz • Mode : FM mode • Connect an RF power meter or 50 Ω dummy load to the antenna connector. • Transmitting 	MAIN unit	Connect a digital multimeter or an oscilloscope to the check point "CP30".	The same voltage that during in DV mode (TX) at the check point "CP30".	PC screen	[FPGA D.C. voltage adjustment /FM I]
[FPGA D.C. voltage ad- justment /FM Q]	2	<ul style="list-style-type: none"> • Transmitting 			The same adjustment as step 1, if need.	PC screen	[FPGA D.C. voltage adjustment /FM Q]
OUTPUT POWER [TX output adjustment]	1	<ul style="list-style-type: none"> • Operating freq. : 1300.00 MHz • Mode : FM mode • TX power : High • Transmitting 	Rear panel	Connect an RF power meter to the antenna connector.	11 W	MAIN unit	R1251
FM DEVIATION [FM modulation adjustment]	1	<ul style="list-style-type: none"> • Operating freq. : 1270.00 MHz • Mode : FM mode • Connect an audio generator to the [MIC] connector and set as : 1.0 kHz/20 mVrms • Set a Modulation analyzer as: HPF : OFF LPF : 20 kHz De-emphasis : OFF Detector : (P-P)/2 • Transmitting 	Rear panel	Connect a modulation analyzer to the antenna connector through an attenuator.	±4.35 kHz	MAIN unit	R1704
DSP INPUT LEVEL [DSP input level adjustment]	1	<ul style="list-style-type: none"> • Operating freq. : 1270.00 MHz • Connect an audio generator to the [MIC] connector and set as : 1.0 kHz/20 mVrms • Connect an RF power meter or 50 Ω dummy load to the antenna connector. • Transmitting 	LOGIC-1 unit	Connect an oscilloscope to the check point "CP207".	IC1 (LOGIC-1) is; "uPD9930" ->750 mVp-p "AD73311" ->2.1 Vp-p	MAIN unit	R1707

[MAIN-1 UNIT]

REF NO.	PARTS NO.	DESCRIPTION	M.	H/V LOCATION
C1692	4510008490	S.ELE EEE1CS100SR	T	73.7/18.4
C1693	4550006250	S.TAN TEESVA 1A 106M8R	T	69.3/3.9
C1694	4030011600	S.CER C1608 JB 1E 104K-T	B	76.4/19.9
C1695	4030008890	S.CER C1608 JB 1H 273K-T	B	89.8/3
C1696	4030011600	S.CER C1608 JB 1E 104K-T	T	1.6/11.4
C1697	4030007090	S.CER C1608 CH 1H 470J-T	T	40.2/2.5
C1698	4030007090	S.CER C1608 CH 1H 470J-T	T	1.6/12.6
C1699	4030007090	S.CER C1608 CH 1H 470J-T	T	25/1.7
C1700	4030007090	S.CER C1608 CH 1H 470J-T	B	5.4/91.6
C1750	4030006900	S.CER C1608 JB 1H 103K-T	T	26.8/12.2
C1751	4030006850	S.CER C1608 JB 1H 471K-T	T	54.5/123.7
C1752	4030006900	S.CER C1608 JB 1H 103K-T	T	28.6/119.3
C1753	4030006860	S.CER C1608 JB 1H 102K-T	T	24.2/120.5
C1754	4510008520	S.ELE EEE1CA470SP	T	31.8/127.5
C1755	4030007090	S.CER C1608 CH 1H 470J-T	T	25.8/113.2
C1800	4030007090	S.CER C1608 CH 1H 470J-T	B	24/20.5
C1801	4030006900	S.CER C1608 JB 1H 103K-T	T	42/103.6
C1802	4030006900	S.CER C1608 JB 1H 103K-T	T	42.5/112.2
C1803	4030006850	S.CER C1608 JB 1H 471K-T	T	28.6/104.1
C1804	4030006850	S.CER C1608 JB 1H 471K-T	T	32.4/103.3
C1805	4030006850	S.CER C1608 JB 1H 471K-T	T	27.8/101.5
C1806	4030006850	S.CER C1608 JB 1H 471K-T	T	32.4/99.7
C1807	4030006850	S.CER C1608 JB 1H 471K-T	T	42/101.4
C1808	4030007090	S.CER C1608 CH 1H 470J-T	T	38.8/112
J1550	6450001440	CON HSJ1403-01-010		
J1600	6510016481	CON 52018-8846(8845)		
J1602	6510021970	S.CON AXN330C130P	T	26.2/21.8
J1750	6510009351	CON B2B-ZR(LF)(SN)		
J1800	6510021722	S.CON 30FLT-SM2-TB(LF)(SN)(M)	T	44/107.5
J1801	6510021722	S.CON 30FLT-SM2-TB(LF)(SN)(M)	T	87/5.8
W1164	7120000490	JUM ERD25T0		
W1330	8900011960	CAB OPC-1216		
EP5	6910000630	BEA FSRH070140RN000B (FSOH070RN)		
EP6	6910000630	BEA FSRH070140RN000B (FSOH070RN)		
EP401	6910012350	S.BEA MMZ1608Y 102BT	B	16.5/70.2
EP403	6910012350	S.BEA MMZ1608Y 102BT	B	20.8/63
EP404	6910012350	S.BEA MMZ1608Y 102BT	T	14.4/60.4
EP405	6910012350	S.BEA MMZ1608Y 102BT	T	21.3/66.3
EP470	6910012350	S.BEA MMZ1608Y 102BT	T	16.4/68.3
EP482	6910012350	S.BEA MMZ1608Y 102BT	B	12.9/82.8
EP550	6910012350	S.BEA MMZ1608Y 102BT	B	24.6/39.8
EP551	6910012350	S.BEA MMZ1608Y 102BT	B	35.1/26.6
EP552	6910012350	S.BEA MMZ1608Y 102BT	B	27.1/48.7
EP553	6910012350	S.BEA MMZ1608Y 102BT	B	18/48.1
EP721	6910012350	S.BEA MMZ1608Y 102BT	B	32.1/85.5
EP1601	6910014690	S.BEA MPZ1608S221A-T	T	114.3/16.5
EP1602	6910014690	S.BEA MPZ1608S221A-T	T	105.1/18.2
EP1603	6910014690	S.BEA MPZ1608S221A-T	T	104.4/14
EP1604	6910014690	S.BEA MPZ1608S221A-T	T	109/12.4
EP1606	6910014690	S.BEA MPZ1608S221A-T	B	114.3/12.3
EP1607	6910014690	S.BEA MPZ1608S221A-T	T	113.4/13.9
EP1608	6910014690	S.BEA MPZ1608S221A-T	T	102.7/11.8
EP1609	6910014690	S.BEA MPZ1608S221A-T	B	107.4/8.6
EP1750	6910012350	S.BEA MMZ1608Y 102BT	B	27.8/124
EP1751	6910012350	S.BEA MMZ1608Y 102BT	B	27.8/125.5

M.=Mounted side (T: Mounted on the Top side, B: Mounted on the Bottom side)

S.=Surface mount

BOARD LAYOUTS

The combination of this side and the bottom side shows the board layout in the same configuration as the actual P.C.Board.

• LOGIC-1 UNIT
(TOP VIEW)

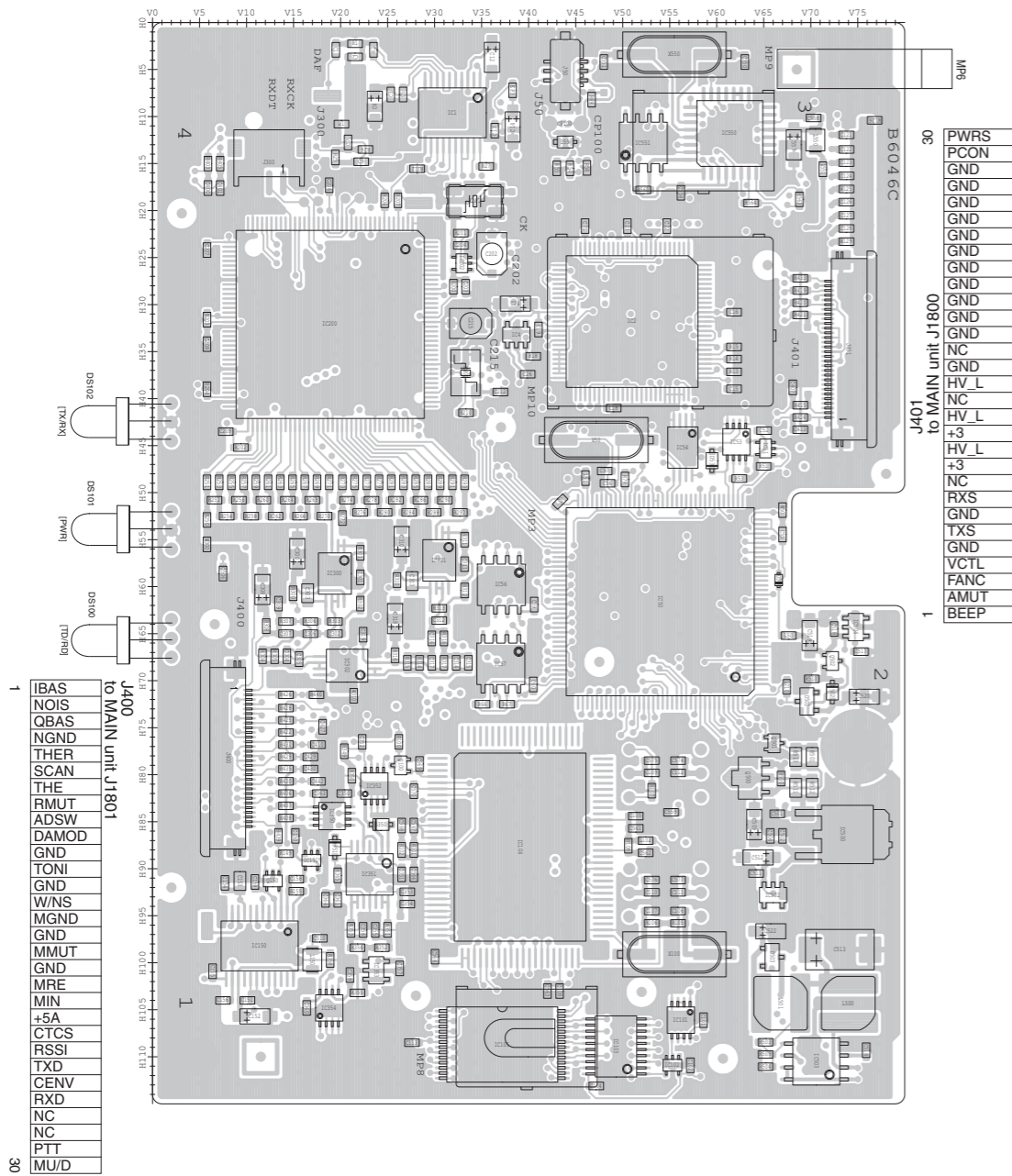

• MAIN-1 UNIT
(TOP VIEW)

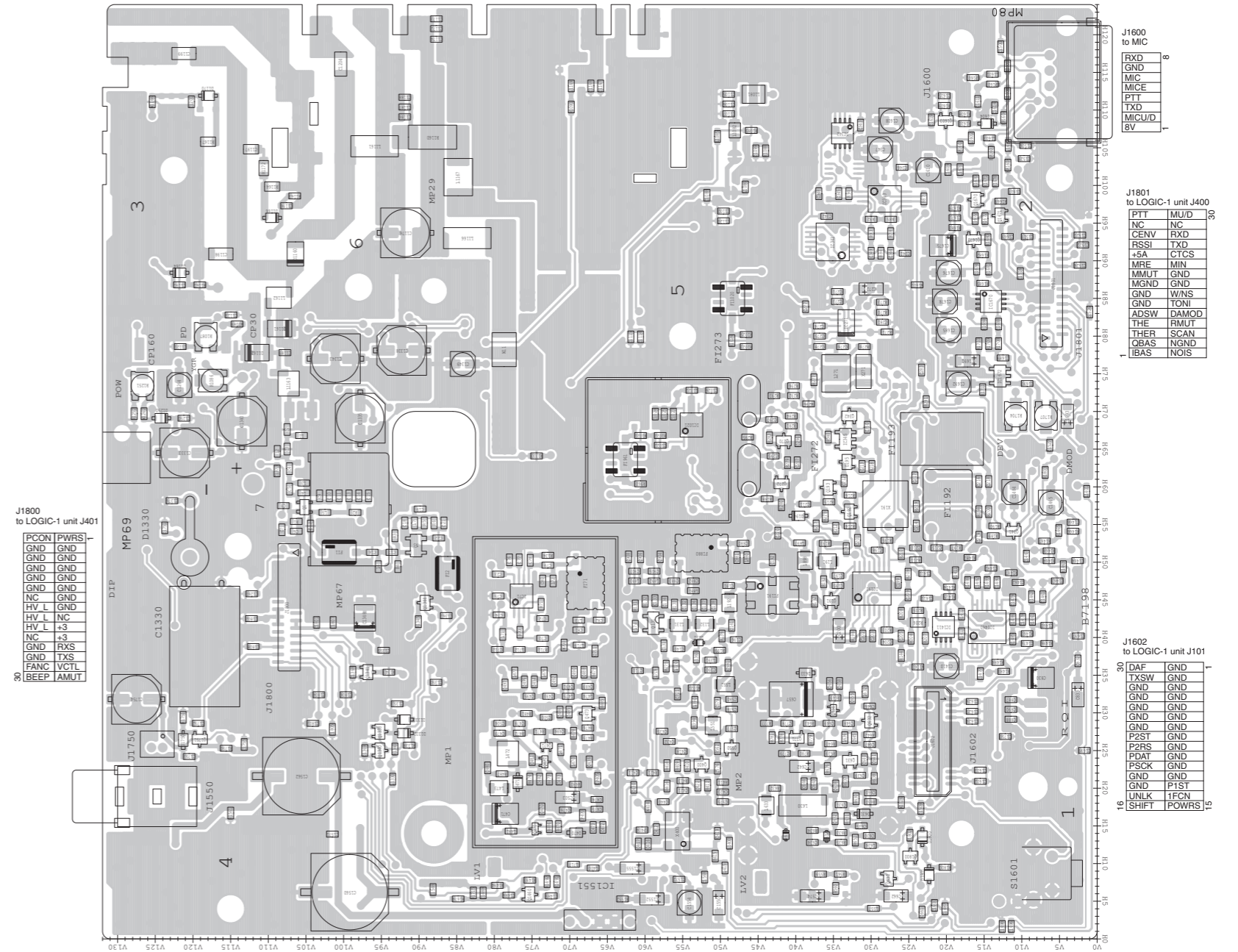

The combination of this side and the bottom side shows the board layout in the same configuration as the actual P.C.Board.

• MAIN-1 UNIT
(BOTTOM VIEW)

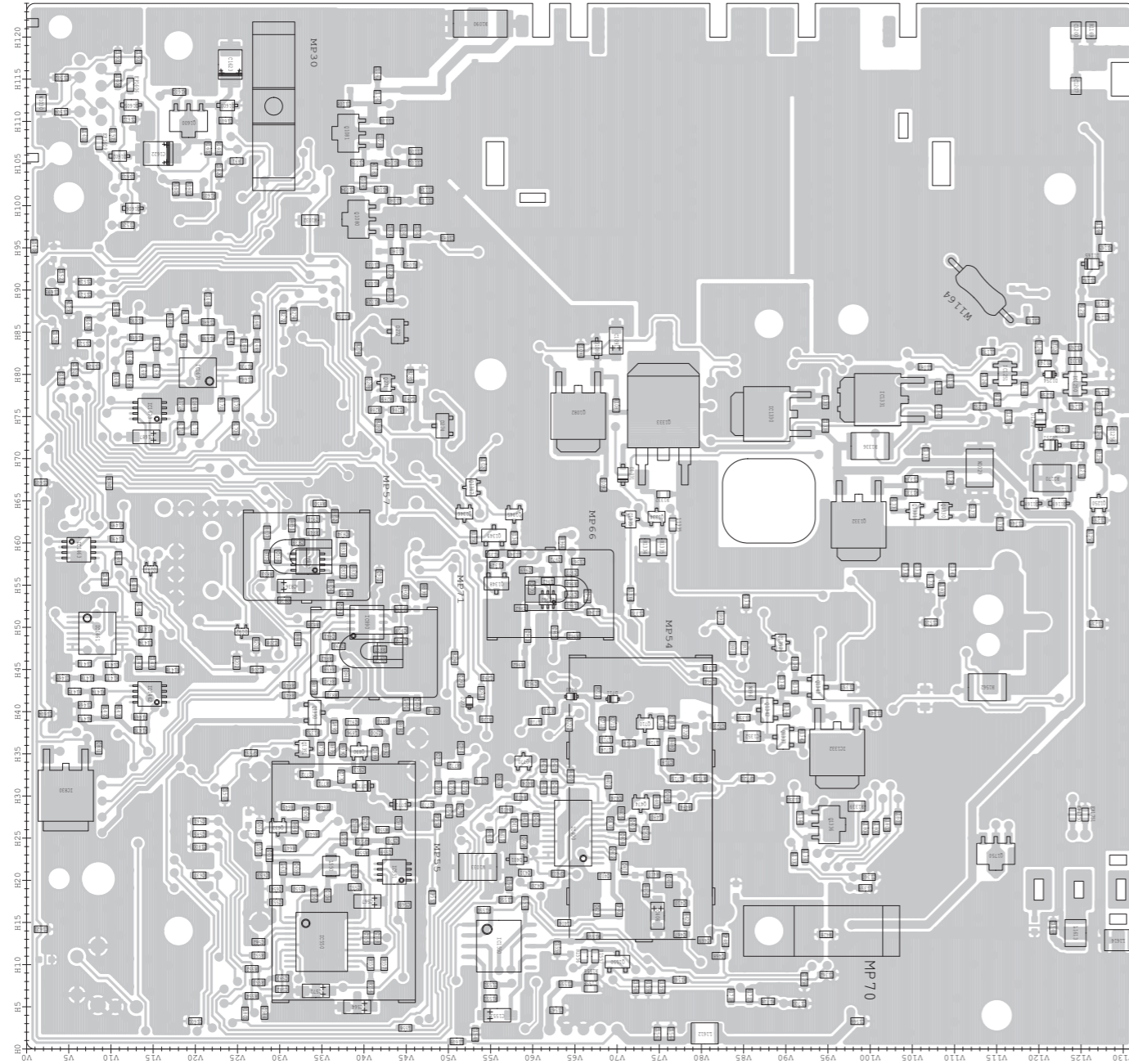

• LOGIC-1 UNIT
(BOTTOM VIEW)

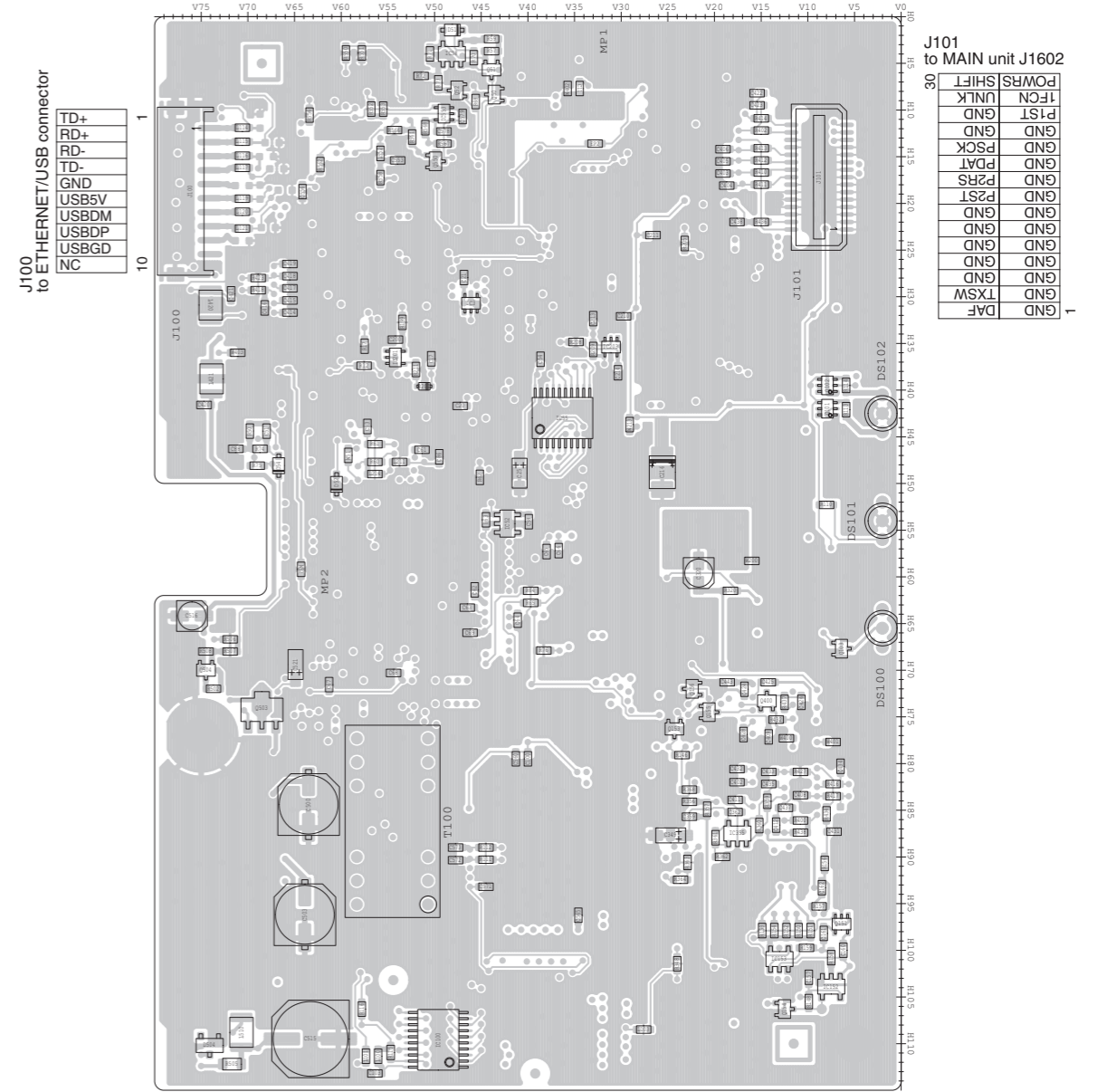

VOLTAGE DIAGRAM

LOGIC-1 UNIT(1)

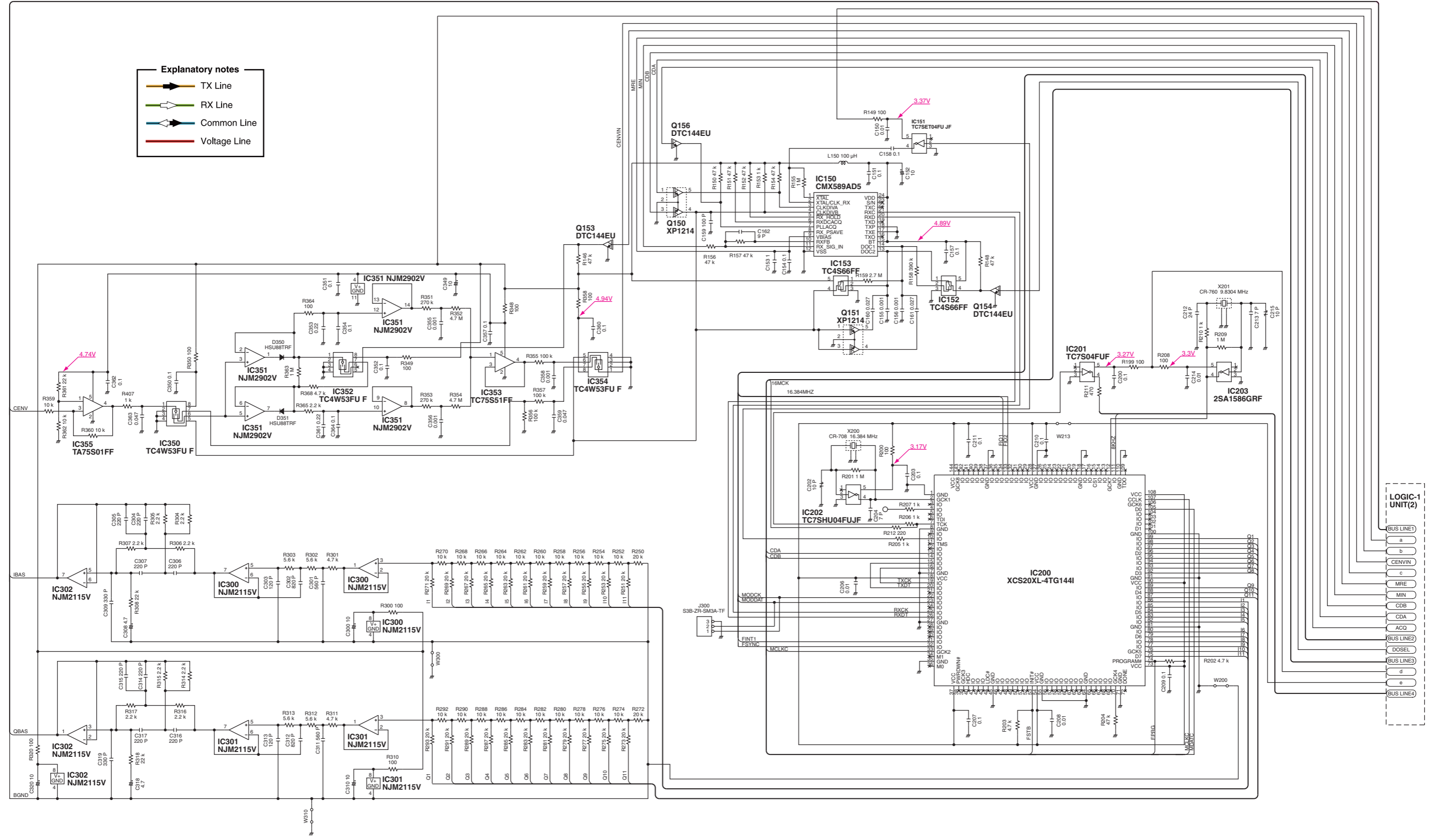

*; Refer to "PARTS LIST."

LOGIC-1 UNIT(2)

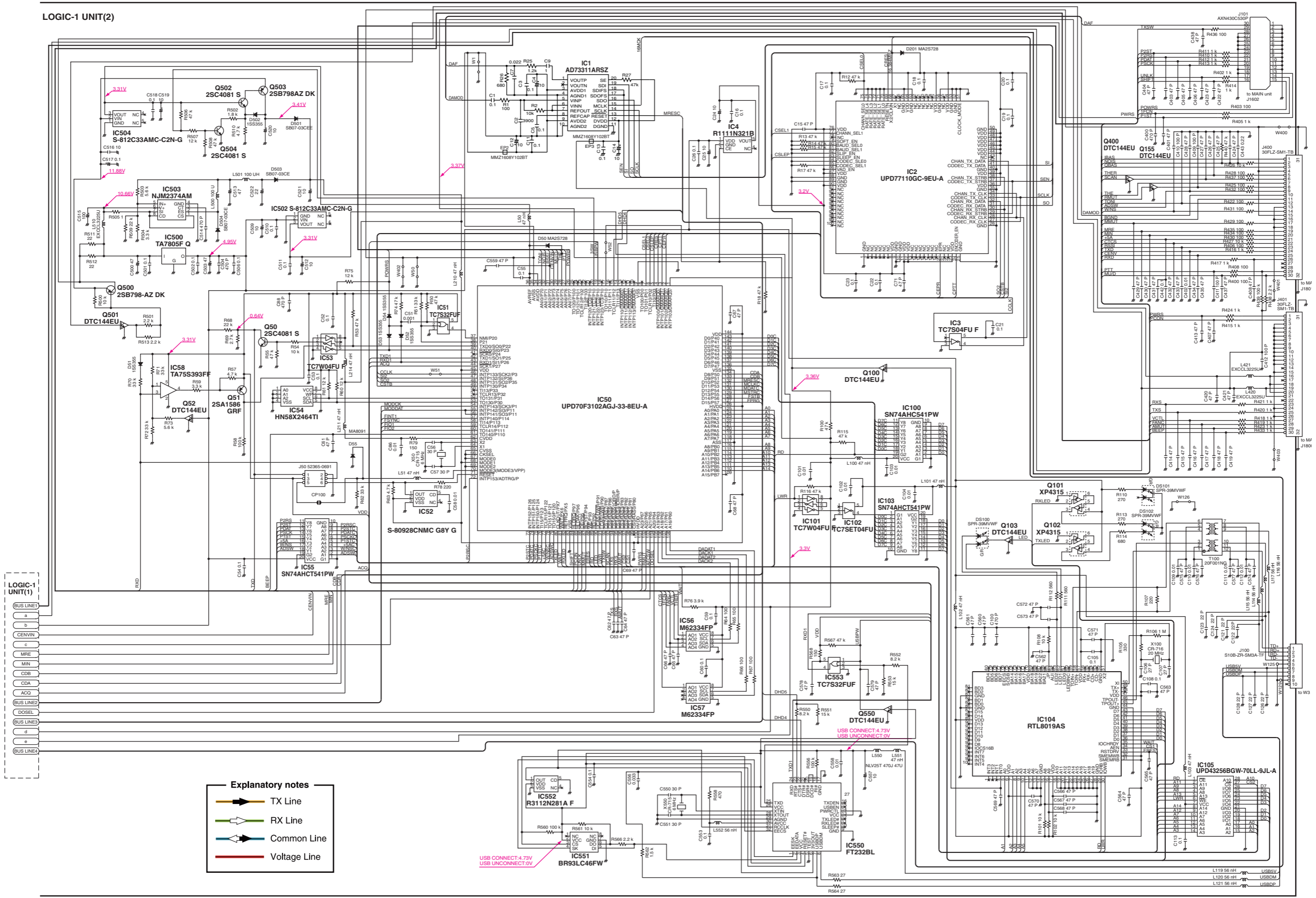

Explanatory notes

- TX Line
- RX Line
- Common Line
- Voltage Line

*; Refer to "PARTS LIST."

MAIN-1 UNIT (1)

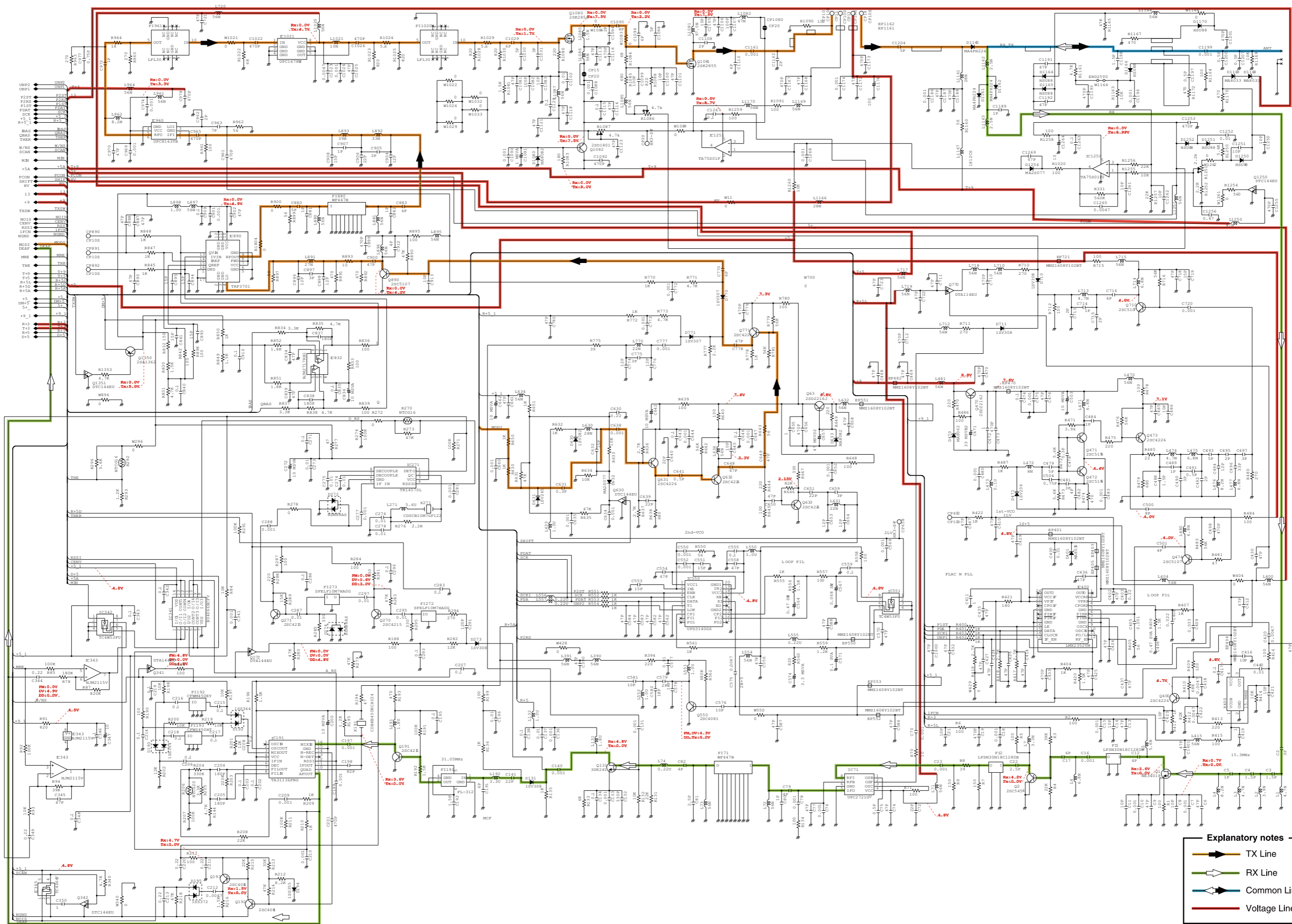

Explanatory notes

- TX Line
- RX Line
- Common Line
- Voltage Line

*; Refer to "PARTS LIST"

MAIN-1 UNIT (2)

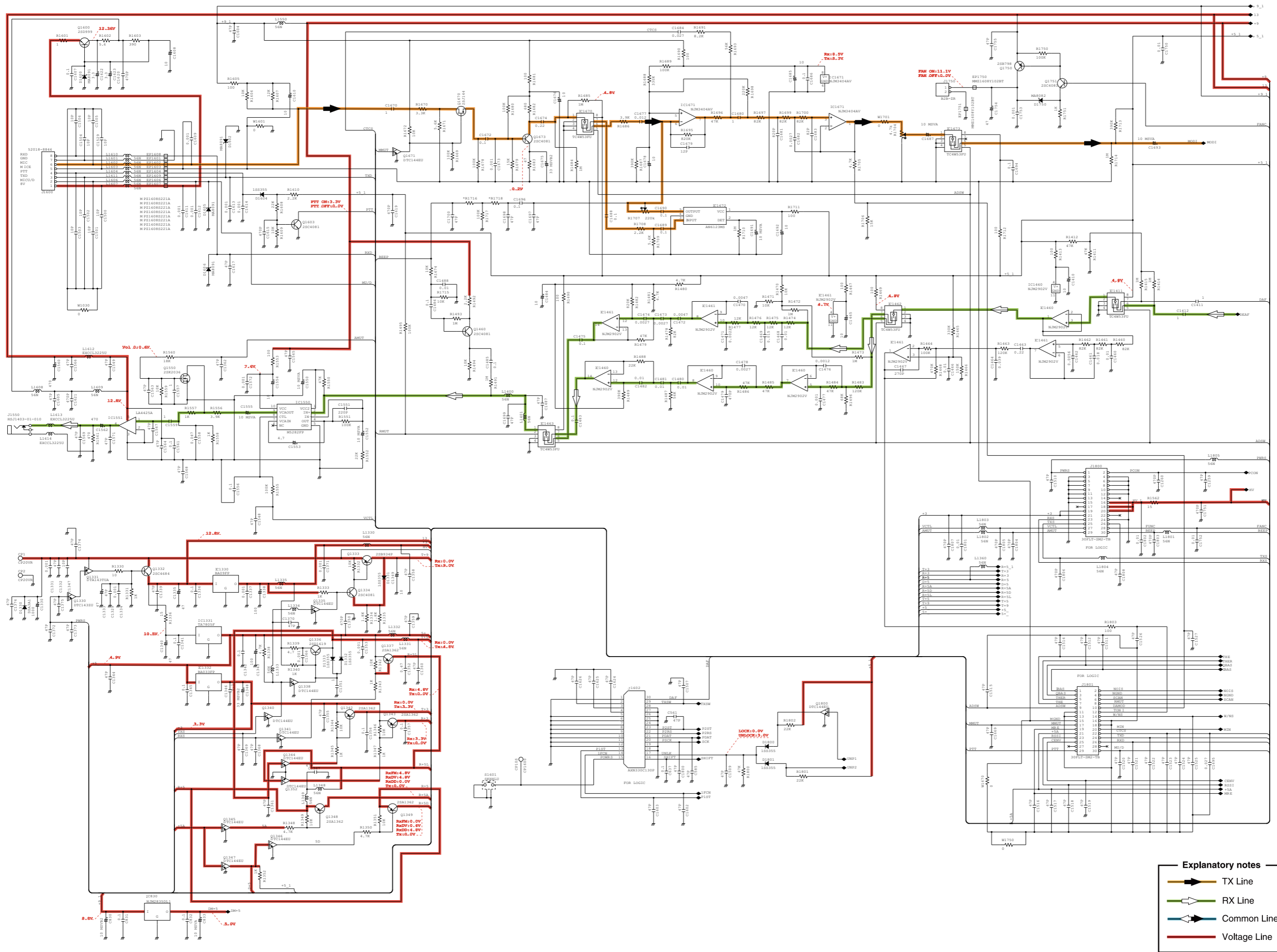

Explanatory notes

- TX Line
- RX Line
- Common Line
- Voltage Line

*; Refer to "PARTS LIST."



SERVICE MANUAL

DIGITAL TRANSCEIVER

ID-1

S-14120IZ-C1

May. 2005

Icom Inc.

INTRODUCTION

This service manual describes the latest service information for the **ID-1** DIGITAL TRANSCEIVER at the time of publication.

MODEL	VERSION	SYMBOL	RC-24
ID-1	U.S.A.	USA-2	Optional
		USA-3	Supplied
	Europe	EUR-2	Optional
		EUR-3	Supplied
	General	GEN-2	Optional
		GEN-3	Supplied

To upgrade quality, all electrical or mechanical parts and internal circuits are subject to change without notice or obligation.

DANGER

NEVER connect the transceiver to an AC outlet or to a DC power supply that uses more than 16 V. Such a connection could cause a fire or electric hazard.

DO NOT expose the transceiver to rain, snow or any liquids.

DO NOT reverse the polarities of the power supply when connecting the transceiver.

DO NOT apply an RF signal of more than 20 dBm (100 mW) to the antenna connector. This could damage the transceiver's front end.



ORDERING PARTS

Be sure to include the following four points when ordering replacement parts:

1. 10-digit order numbers
2. Component part number and name
3. Equipment model name and unit name
4. Quantity required

<SAMPLE ORDER>

2710000590 Fan MF40D-12H-001 ID-1 Chassis 2 pieces
8900010940 Cable OPC-1119 RC-24 Chassis 3 pieces

Addresses are provided on the inside back cover for your convenience.

REPAIR NOTES

1. Make sure a problem is internal before disassembling the transceiver.
2. **DO NOT** open the transceiver until the transceiver is disconnected from its power source.
3. **DO NOT** force any of the variable components. Turn them slowly and smoothly.
4. **DO NOT** short any circuits or electronic parts. An insulated turning tool **MUST** be used for all adjustments.
5. **DO NOT** keep power ON for a long time when the transceiver is defective.
6. **DO NOT** transmit power into a signal generator or a sweep generator.
7. **ALWAYS** connect a 30 dB to 40 dB attenuator between the transceiver and a deviation meter or spectrum analyzer when using such test equipment.
8. **READ** the instructions of test equipment thoroughly before connecting equipment to the transceiver.

Icom, Icom Inc. and ICOM logo are registered trademarks of Icom Incorporated (Japan) in the United States, the United Kingdom, Germany, France, Spain, Russia and/or other countries.

TABLE OF CONTENTS

SECTION 1 SPECIFICATIONS

SECTION 2 INSIDE VIEWS

2-1	ID-1	2-1
-----	------------	-----

SECTION 3 DISASSEMBLY INSTRUCTIONS

3-1	ID-1	3-1
3-2	RC-24.....	3-1

SECTION 4 CIRCUIT DESCRIPITON

4-1	RECEIVER CIRCUITS.....	4-1
4-2	TRNSMITTER CIRCUITS	4-3
4-3	PLL CIRCUITS	4-5
4-4	POWER SUPPLY CIRCUITS.....	4-6
4-5	PORT ALLOCATION	4-7

SECTION 5 ADJUSTMENT PROCEDURES

5-1	PREPARATION	5-1
5-2	PLL AND CODEC ADJUSTMENT.....	5-3
5-3	TRANSMITTER ADJUSTMENT	5-6
5-4	RECEIVER ADJUSTMENT	5-7

SECTION 6 PARTS LIST

SECTION 7 SEMI-CONDUCTOR INFORMATION

SECTION 8 MECHANICAL PARTS AND DISASSEMBLY

8-1	ID-1	8-1
8-2	RC-24.....	8-2

SECTION 9 BOARD LAYOUTS

9-1	MAIN UNIT	9-1
9-2	LOGIC-1 UNIT.....	9-3
9-3	RC-24.....	9-5

SECTION 10 BLOCK DIAGRAM

10-1	MAIN UNIT	10-1
10-2	LOGIC-1 UNIT.....	10-2
10-3	RC-24.....	10-2

SECTION 11 VOLTAGE DIAGRAM

11-1	MAIN UNIT	11-1
11-2	LOGIC-1 UNIT.....	11-4
11-3	RC-24.....	11-6

SECTION 1 SPECIFICATIONS

■ GENERAL

- Frequency coverage : 1240.000–1300.000 MHz
- Type of emission : FM, GMSK (Digital)
- Transmission speed (theoretical value) : Data 128 kbps
Digital voice 4.8 kbps
- Codec : AMBE (2.4 kbps)
- Number of memory channel : 105 (incl. 2 scan edges and 3 calls)
- Tuning steps : 5, 6.25, 10, 12.5, 20, 25, 50, 100 kHz
- Frequency stability : ± 2.5 ppm (-10°C to $+60^{\circ}\text{C}$)
- Operating temperature range : -10°C to $+60^{\circ}\text{C}$ (-22°F to $+140^{\circ}\text{F}$)
- Antenna connector : Type-N ($50\ \Omega$)
- Power supply requirement : 13.8 V DC $\pm 15\%$ (Negative ground)
- Current drain (at 13.8 V DC) : Transmit Less than 7 A (at 10 W)
Receive Less than 1.5 A (AF max.)
- Dimensions (projections not included) :
 - Main unit 141(W) \times 40(H) \times 165.8(D) mm; $5^{9/16}$ (W) \times $1^{9/16}$ (H) \times $6^{17/32}$ (D) in
 - Remote controller (RC-24) 150(W) \times 50(H) \times 49.5(D) mm; $5^{29/32}$ (W) \times $1^{31/32}$ (H) \times $6^{15/16}$ (D) in
- Weight (Approx.) :
 - Main unit 1.2 kg; 2 lb 10 oz
 - Remote controller (RC-24) 220 g; 7.7 oz

■ TRANSMITTER

- Output power (at 13.8 V DC) : 10/1 W
- Modulation : Variable reactance frequency modulation (FM)
Quadrature modulation (Digital)
- Maximum frequency deviation (FM) : ± 5.0 kHz
- Spurious emissions : Less than -50 dB
- Microphone connector : 8-pin modular jack ($600\ \Omega$)

■ RECEIVER

- Receive system : Triple conversion superheterodyne system (FM, DV)
Double conversion superheterodyne (DD)
- Intermediate frequencies : 1st IF: 243.95 MHz, 2nd IF: 31.05 kHz, 3rd IF: 450 kHz (FM, DV)
1st IF: 243.95 MHz, 2nd IF: 10.7 MHz (DD)
- Sensitivity : Less than $0.18\ \mu\text{V}$ (-122 dBm) at 12 dB SINAD (FM)
Less than $0.35\ \mu\text{V}$ (-116 dBm) at BER 1×10^{-2} (DV)
Less than $1.58\ \mu\text{V}$ (-103 dBm) at BER 1×10^{-2} (DD)
- Selectivity (typical) : More than 12 kHz/6dB, Less than 30 kHz/60 dB (FM)
More than 6 kHz/6dB, Less than 18 kHz/50 dB (DV)
More than 140 kHz/6dB, Less than 520 kHz/40 dB (DD)
- Spurious and image rejection : More than 50 dB
- Audio output power (at 13.8 V DC) : 2.0 W at 10% distortion with an $8\ \Omega$ load
- Squelch sensitivity (at threshold) : Less than $0.18\ \mu\text{V}$ (-122 dBm) (FM only)
- Ext. speaker connector : 2-conductor 3.5 (d) mm ($1/8$ ")/ $8\ \Omega$

All stated specifications are subject to change without notice or obligation.

SECTION 2 INSIDE VIEWS

● MAIN UNIT

Top view

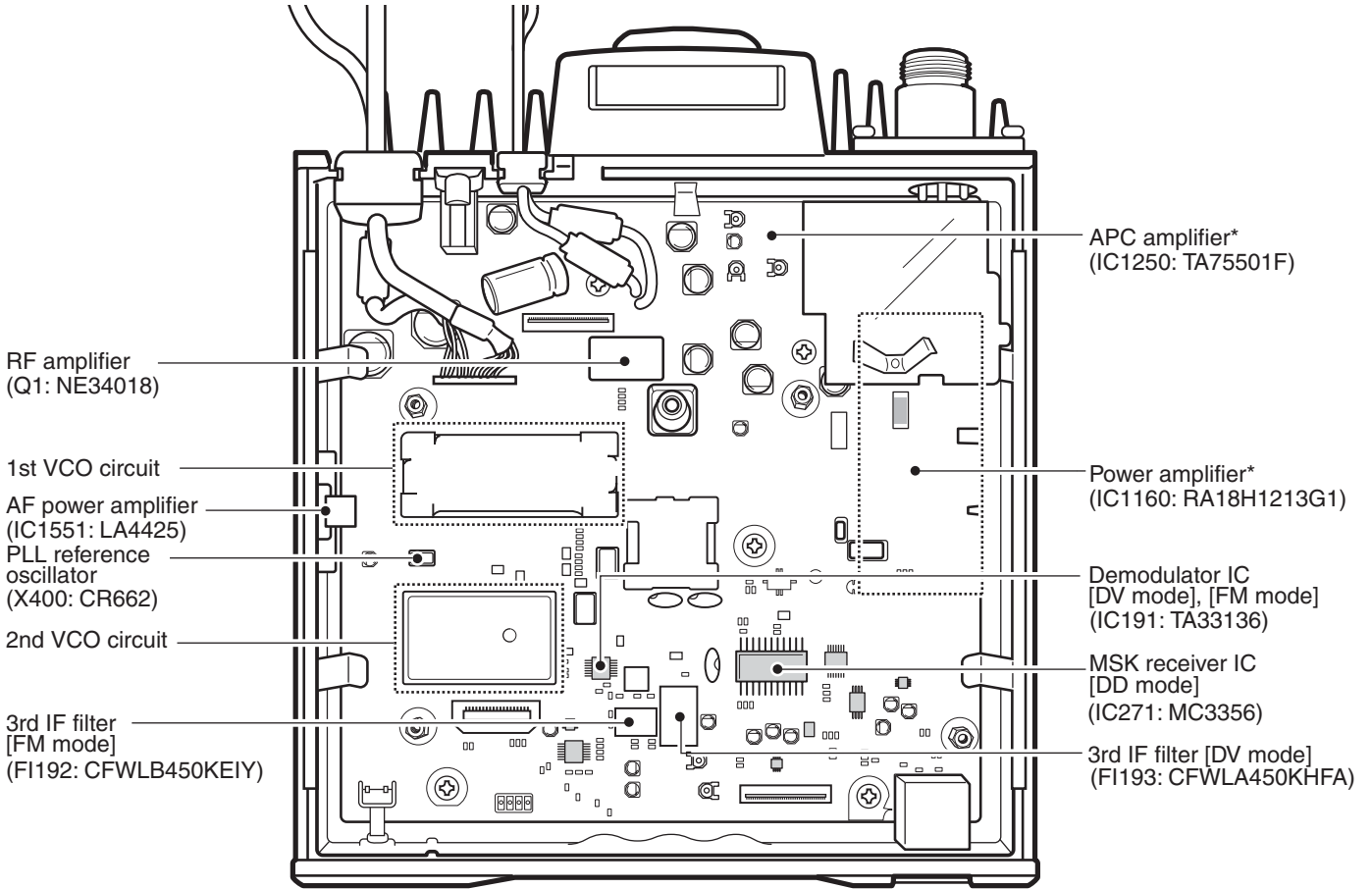

*: Located under side of this point

● LOGIC-1 UNIT

Top view

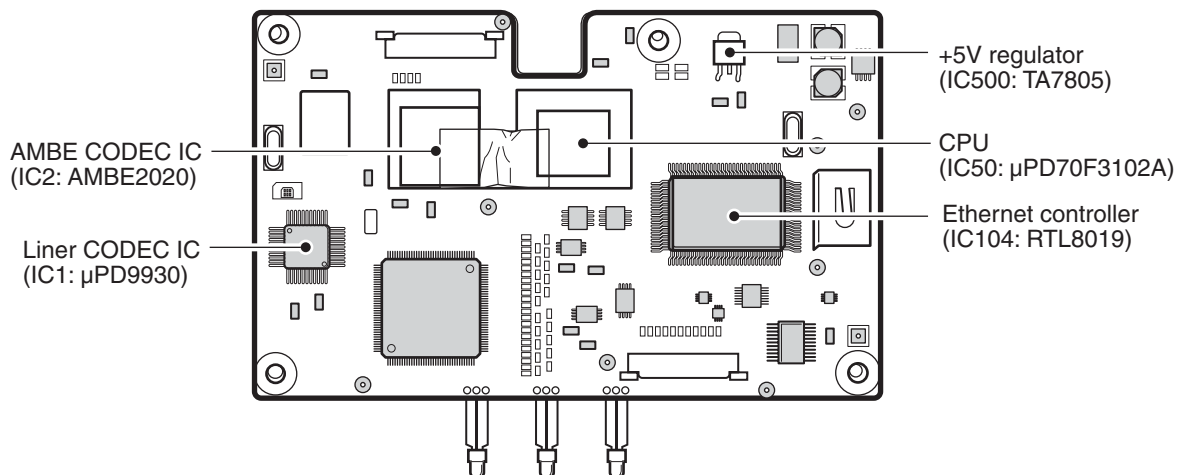

SECTION 3 DISASSEMBLY INSTRUCTIONS

3-1 ID-1

● REMOVING THE LOGIC-1 UNIT

- ① Unscrew 1 screw (A), and remove the cover (B).
- ② Remove 2 main shield plates (C).
- ③ Disconnect 2 cables (D), and unsolder 1 point (E).
- ④ Unscrew 4 screws (F), and remove the earth spring (G).
- ⑤ Take off the LOGIC-1 unit.

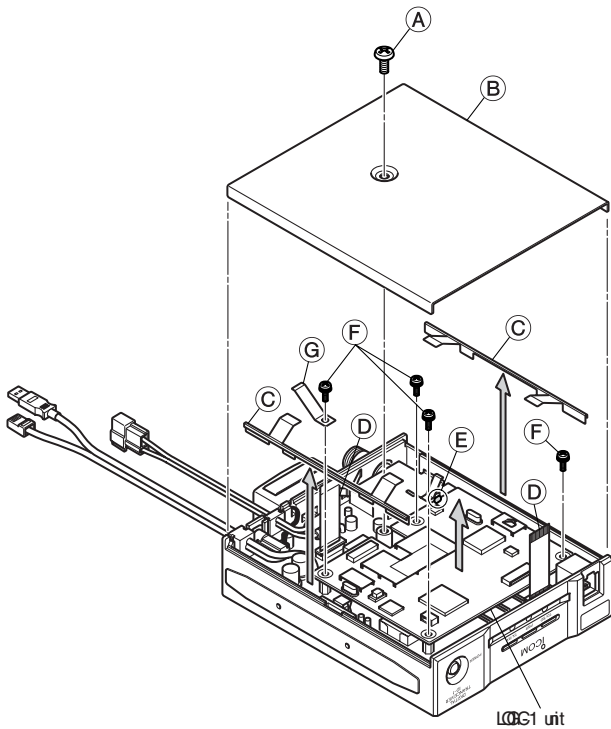

● REMOVING THE MAIN UNIT

- ① Unsolder 5 points (A), and remove the ANT plate (B).

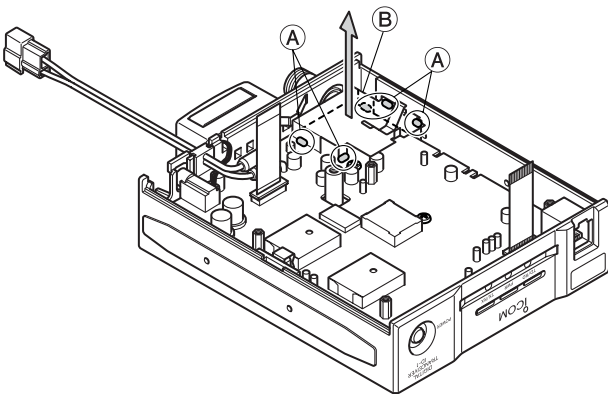

Continue to right above.

- ② Unsolder 11 points (C).
- ③ Unscrew 2 screws (D), and remove the ANT connector (E).
- ④ Take off the cable (F) from the chassis.
- ⑤ Disconnect the cable (G), and remove the TR-A clip (H).
- ⑥ Unscrew 7 screws (I), and take off the MAIN unit.

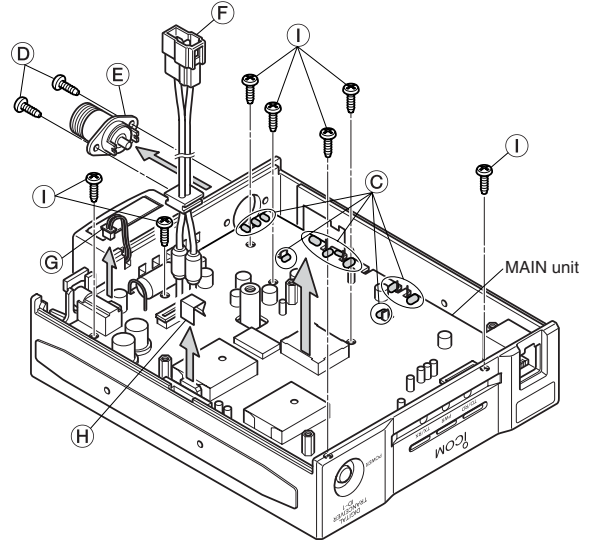

3-2 RC-24

● REMOVING THE FRONT UNIT

- ① Unscrew 4 screws (A), and remove the rear plate (B).
- ② Unscrew 3 screws (C), and remove the front panel (D).
- ③ Disconnect the cable (E), and remove the knob (F).
- ④ Unscrew 5 screws (G), and take off the FRONT unit.

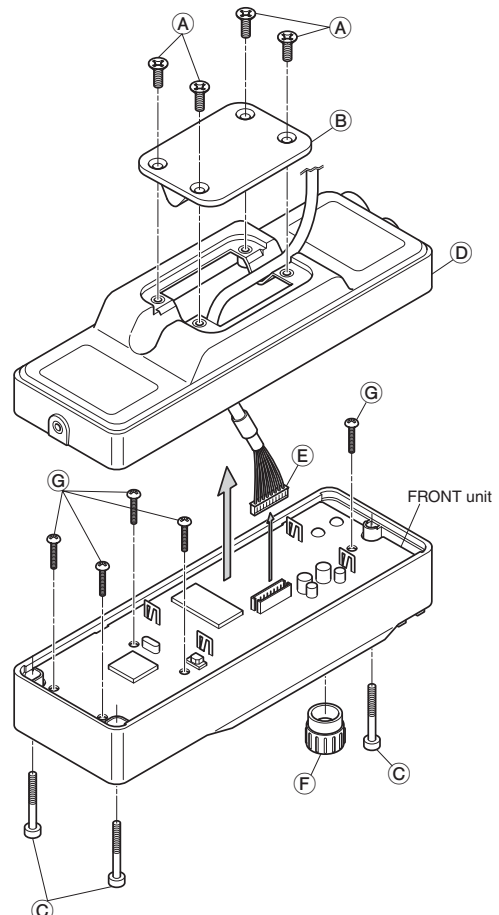

SECTION 4 CIRCUIT DESCRIPTION

4-1 RECEIVER CIRCUITS

4-1-1 ANTENNA SWITCHING CIRCUIT (MAIN UNIT)

The antenna switching circuit functions as a low-pass filter while receiving and a resonator circuit while transmitting. This circuit does not allow transmit signals to enter the receiver circuits.

Received signals from the antenna connector (CHASSIS; J1) are passed through the low-pass filter which contains strip-line and C1198, and are then applied to the $\lambda/4$ type antenna switching circuit (D1160–D1162, L1162).

While receiving, no voltage is applied to D1160–D1162. Thus, the receive line and ground are disconnected and received signals are applied to the RF circuit.

4-1-2 RF CIRCUIT (MAIN UNIT)

The RF circuit amplifies signals within the range of frequency coverage and filters out-of-band signals.

The signals from the antenna switching circuit pass through the high-pass filter (L1–L4, C2–C5) and then applied to the RF amplifier (Q1). The amplified signals are passed through the bandpass filter (F11) and then applied to the another RF amplifier (Q2). The amplified signals are passed through the another bandpass filter (F12) to suppress unwanted signals.

The filtered signal is applied to the 1st mixer circuit.

4-1-3 1ST MIXER AND 1ST IF CIRCUITS (MAIN UNIT)

The 1st mixer circuit converts the received signals into fixed frequency of the 1st IF signal with the 1st LO signal. By changing the 1st LO signal, only the desired frequency passes through the bandpass filter at the next stage of the 1st mixer circuit.

The RF signals from the bandpass filter (F12) are mixed with the 1st LO signal, where come from the 1st VCO circuit, at the 1st mixer circuit (IC71) to produce a 243.95 MHz 1st IF signal. The 1st IF signal is passed through the bandpass filter (F171) to suppress unwanted signals and pass only the desired signals.

The filtered signal is applied to the 2nd IF circuit.

4-1-4 2ND MIXER AND 2ND IF CIRCUITS (MAIN UNIT)

The 2nd mixer circuit converts the 1st IF signal into the 2nd IF signal with the 2nd LO signal.

• DV/FM MODE

The filtered 1st IF signal from the bandpass filter (F171) is mixed with the 2nd LO signal (275.00 MHz), where come from 2nd VCO circuit, at the 2nd mixer circuit (Q131) to produce the 2nd IF signal (31.05 MHz). The 2nd IF signal is passed through the MCF (F1191) via the DV/FM switch (D131). The filtered signal is applied to the IF amplifier (Q191) and then applied to the 3rd mixer circuit in the demodulator IC (IC191).

• DD MODE

The filtered 1st IF signal from the bandpass filter (F171) is mixed with the 2nd LO signal (233.25 MHz), where come from the 2nd VCO circuit, at the 2nd mixer circuit (Q131) to produce the 2nd IF signal (10.7 MHz). The 2nd IF signal is passed through the bandpass filter (F1272) to remove unwanted heterodyned frequencies via the DD switch (D273). The filtered signal is amplified at the IF amplifier (Q270) and then passed through the another bandpass filter (F1273). The filtered signal is applied to the another IF amplifier (Q271) and then applied to the MSK receiver IC (IC271).

• RF AND IF CIRCUITS

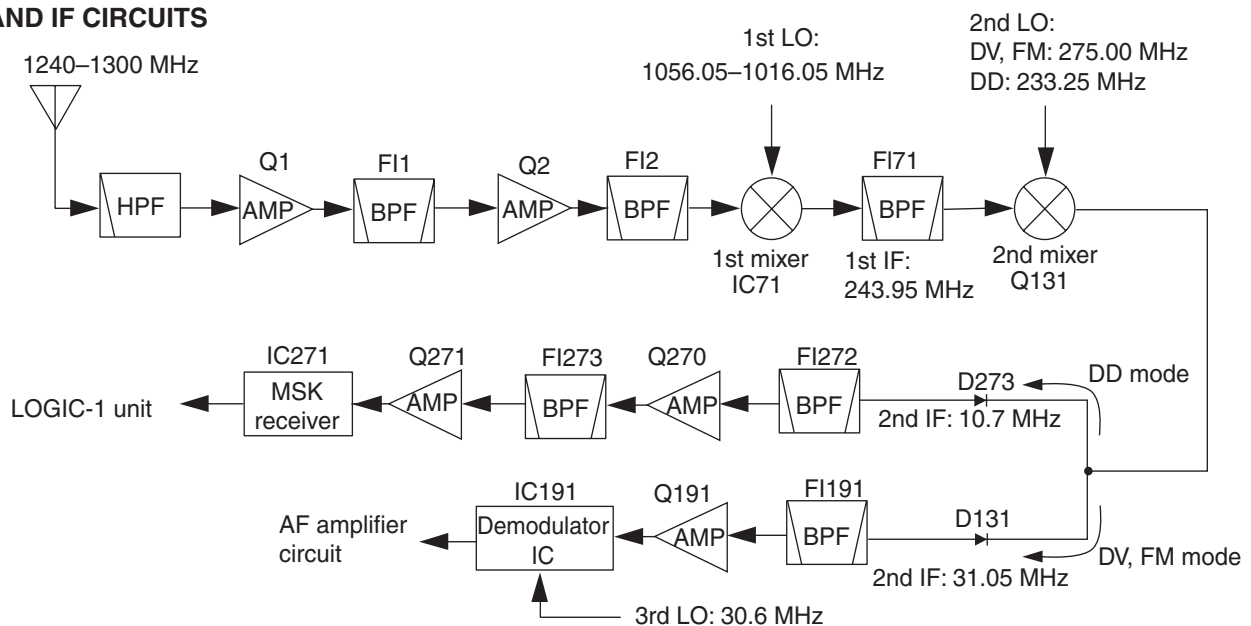

4-1-5 DEMODULATOR CIRCUITS (MAIN UNIT)

• DV MODE

The demodulator IC (IC191) contains the 3rd mixer, limiter amplifier, quadrature detector, active filter and noise amplifier, etc.

The amplified signal from the IF amplifier (Q191) is applied to the 3rd mixer section of the demodulator IC (IC191, pin 16) and is then mixed with the 3rd LO signal to be converted into the 450 kHz 3rd IF signal. The 3rd IF signal from the 3rd mixer section (IC191, pin 3) passes through the ceramic filter (F1193) via the mode switches (D192, D193) to remove unwanted heterodyned frequencies. The filtered signal is amplified at the limiter amplifier section (IC191, pin 5) and then applied to the quadrature detector section (IC191, pins 10, 11) to demodulate the digital audio signals.

The 3rd LO signal (30.6 MHz) is produced at the 1st PLL circuit by doubling it's reference frequency (X400: 15.3 MHz) at the doubler (Q550).

The digital audio signals from the demodulator IC (IC191, pin 9) are amplified at IC343 (pins 6, 7) and then applied to the mode switch (IC342, pins 1, 7).

The switched signals from the mode switch (IC342, pin 1) are applied to the LOGIC-1 unit via J1801 (pin 20).

• DD MODE

The MSK receiver IC (IC271) contains the limiter amplifier, quadrature detector, etc.

The amplified signal from the IF amplifier (Q271) is applied to the limiter amplifier section of the MSK receiver IC (IC271, pin 7) and then applied to the quadrature detector section (IC271, pin 11) to demodulate to the data signals.

The demodulated data signals from the MSK receiver IC (IC271, pin 13) are amplified at IC343 (pins 1, 2) and then applied to the mode switch (IC342, pins 1, 6).

The switched signals from the mode switch (IC342, pin 1) are applied to the LOGIC-1 unit via J1801 (pin 20).

• FM MODE

The same demodulator IC that is used for DV mode operation is used for FM demodulation.

The amplified signal from the IF amplifier (Q191) is applied to the 3rd mixer section of the demodulator IC (IC191, pin 16) and is then mixed with the 3rd LO signal to be converted into the 450 kHz 3rd IF signal. The 3rd IF signal from the 3rd mixer section (IC191, pin 3) passes through the ceramic filter (F1192) via the mode switches (D192, D193) to remove unwanted heterodyned frequencies. The filtered signal is amplified at the limiter amplifier section (IC191, pin 5) and then applied to the quadrature detector section (IC191, pins 10, 11) to demodulate the AF signals.

The AF signals are output from the demodulator IC (IC191, pin 9) and are then applied to the AF amplifier circuit.

4-1-6 DIGITAL CIRCUITS (LOGIC-1 UNIT)

The digital circuits convert the demodulated digital audio signals into the analog audio signals and convert the demodulated data signals format for PC communication via the USB controller (for DV mode: low speed data operation) or Ethernet controller (for DD mode).

The demodulated digital audio or data signals from the mode switch (MAIN unit: IC342, pin 1) are applied to the GMSK MODEM IC (IC150, pin 11). The applied signals are synchronized with the clock signal, then the synchronized

• 3RD IF AND DEMODULATOR CIRCUIT (DV/FM MODE)

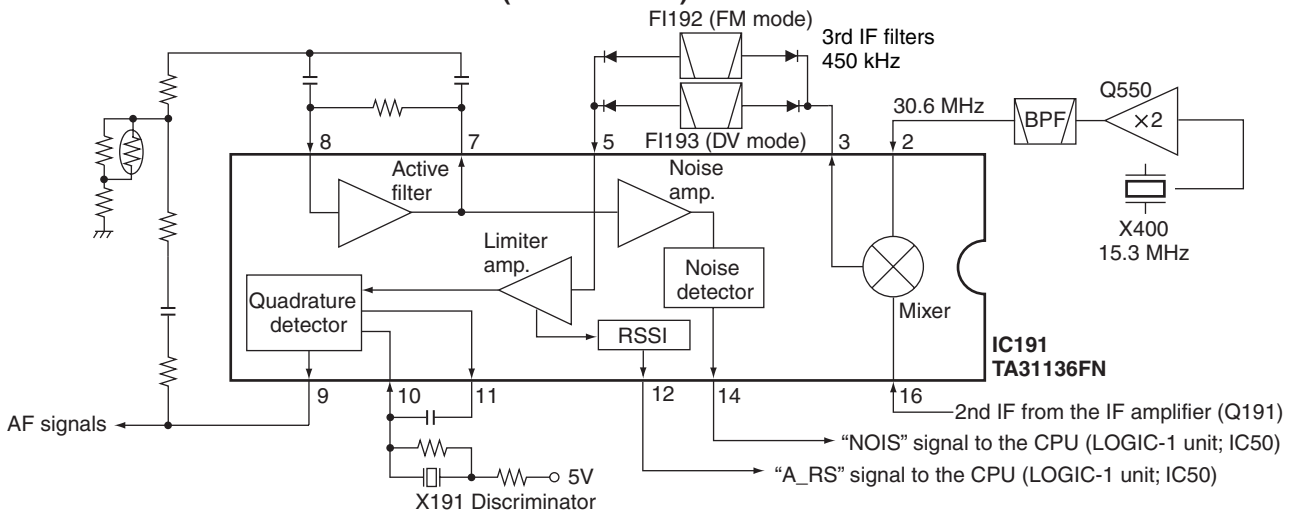

• DIGITAL CIRCUITS (LOGIC-1 UNIT)

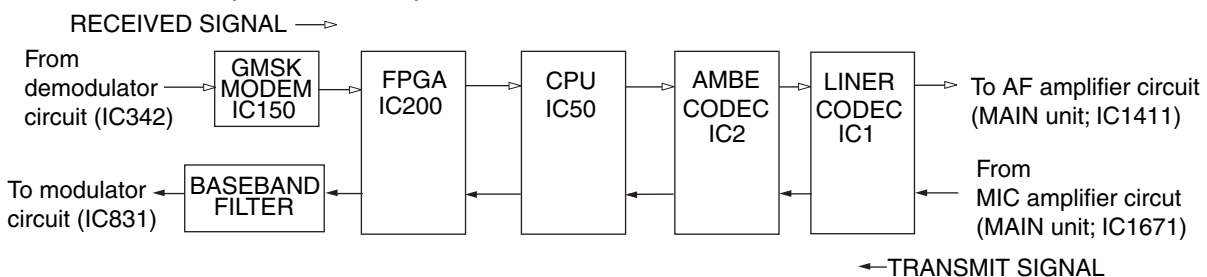

signals are applied to the CPU (IC50) via the FPGA IC (IC200).

• DV MODE (VOICE OPERATION)

The digital audio signals from the CPU (IC50) are applied to the AMBE CODEC IC (IC2) for code expansion, and are then applied to the linear CODEC IC (IC1). The digital audio signals are converted into analog audio signals at the D/A converter section and then output from pin 34 (IC1)

The analog audio signals are applied to the mode switch (MAIN unit; IC1411, pins 1, 7) via the J101 (pin 30) as "DAF" signal.

• DD MODE/DV MODE (LOW SPEED DATA OPERATION)

While operating in DD mode, the output signals from the CPU (IC50) are applied to the connected PC via the Ethernet controller (IC104).

While operating in DV mode (low speed data operation), the output signals from the CPU (IC50) are applied to the connected PC via the USB controller (IC550).

4-1-7 AF AMPLIFIER CIRCUIT (MAIN UNIT)

The AF amplifier circuit amplifies the demodulated AF signals to a level needed to drive a speaker.

• DV MODE

The AF signals from the LOGIC-1 unit are applied to the mode switch (IC1411, pins 1, 7) and then amplified at the buffer amplifier (IC1460, pins 1, 3). The buffer amplified signals are applied to the filter switch (IC1462, pins 1, 6) to select the appropriate AF filters for DV mode and then passed through the low-pass (IC1461, pins 8, 10) and high-pass (IC1461, pins 12, 14) filters. The filtered signals are passed through the filter switch (IC1463, pins 1, 6) and are then applied to the volume controller (IC1550, pins 2, 9).

• FM MODE

The AF signals from the demodulator IC (IC191, pin 9) are applied to the mode switch (IC1411, pins 1, 6) and then applied to the buffer amplifier (IC1460, pins 1, 3). The buffer amplified signals are applied to the filter switch (IC1462, pins 1, 7) to select the appropriate AF filters for FM mode and then passed through the low-pass (IC1460, pins 6, 7, 8, 9) and high-pass (IC1460, pins 13, 14) filters. The filtered signals are passed through the filter switch (IC1463, pins 1, 7) and are then applied to the volume controller (IC1550, pins 2, 9).

The switched AF signals from the filter switch (IC1463, pin 1) are applied to the volume controller (IC1550, pins 2, 9). The level adjusted AF signals (IC1550, pin 9) are applied to the AF power amplifier (IC1551, pins 1, 4) via the AF mute switch (Q1550).

The AF mute switch is mute the AF signals while digital squelch, call sign squelch, noise squelch, tone squelch are closed, the audio level is set to minimum position or transmitting.

The power amplified AF signals from the AF power amplifier (IC1551, pin 4) are applied to the speaker that is connected to [SP] jack (J1550).

4-1-8 SQUELCH CIRCUITS (MAIN UNIT)

• DIGITAL CODE/CALL SIGN SQUELCH (DV MODE ONLY)

The digital code/call sign squelch circuit detects matched digital code/call sign and opens the squelch only when receiving a signal containing a matching digital code/call sign. When digital code/call sign squelch is in use, and a signal with a unmatched digital code/call sign is received, the digital code/call sign squelch circuit mutes the AF signals.

The detected digital audio signals from IC191 (pin 9) are applied to the CPU (LOGIC-1 unit; IC50) via the mode switch (IC342, pins 1, 7), GMSK MODEM IC (LOGIC-1 unit; IC150) and FPGA IC (LOGIC-1 unit; IC200). Then the CPU analyzes the digital code/call sign and output the AF mute signal as "RMUT" from the pin 102 to the filter switch (IC1463, pin 2) via the mute switch (LOGIC-1 unit; Q155).

• NOISE SQUELCH (FM MODE ONLY)

The noise squelch circuit cuts out AF signals when no RF signals are received. By detecting noise components in the AF signals, the squelch circuit switches the filter switch (IC1463).

Portion of the AF signals from the demodulator IC (IC191, pin 9) are applied to the active filter section in the demodulator IC (IC191, pin 8). The active filter section filters and amplifies noise components only. The amplified noise signals are converted into the pulse-type signals at the noise detector section. The detected signals output from pin 14 (IC191).

The detected signals from the demodulator IC (IC191, pin 14) are amplified at the noise amplifiers (Q192, Q193) and then applied to the noise detector (D195). The detected signals are applied to the CPU (LOGIC-1 unit; IC50, pin 32) as "NOIS" signals. Then the CPU analyzes the noise condition and outputs the AF mute signal as "RMUT" from the pin 102 to the filter switch (IC1463, pin 2) via the mute switch (LOGIC-1 unit; Q155).

• TONE SQUELCH (FM MODE ONLY)

The tone squelch circuit detects tone signals and opens the squelch only when receiving a signal containing a matching subaudible tone (CTCSS). When tone squelch is in use, and a signal with a unmatched or no subaudible tone is received, the tone squelch circuit mutes the AF signals even when noise squelch is open.

A portion of "DEAF" signals from the buffer amplifier (IC1460, pin 1) are applied to the low-pass filters (IC1461, pins 1, 2, 5, 7) to remove AF (voice) signals. The filtered signals are applied to the CTCSS decoder in the CPU (LOGIC-1 unit, IC50, pin 33) as "TONI" signals. Then the CPU analyzes the decoded tone signals and output the AF mute signal as "RMUT" from the pin 102 to the filter switch (IC1463, pin 2) via the mute switch (LOGIC-1 unit; Q155).

4-1-9 S-METER CIRCUITS (MAIN UNIT)

Some of the amplified IF signal is applied to the S-meter detector section in the demodulator IC (IC191) to be converted into DC voltage. The output signal from the demodulator IC (IC191, pin 12) is applied to the mode switch (IC341, pins 10, 11) and then applied to the CPU (LOGIC-1 unit; IC50). The CPU then outputs S-meter control signal to the RC-24 or connected PC via the USB controller (LOGIC-1 unit; IC550).

4-2 TRANSMITTER CIRCUITS

4-2-1 MICROPHONE AMPLIFIER CIRCUIT (MAIN UNIT)

The microphone amplifier circuit amplifies audio signals from the microphone to a level needed for the modulation circuit.

While connecting the microphone to ID-1, the AF signals from the microphone (J1600, pin 6) are applied to the microphone amplifier (Q1673) via the microphone mute switch (Q1670). The amplified AF signals are applied to the mode switch (IC1670, pins 1, 6, 7).

While connecting the microphone to RC-24, the AF signals from the microphone (RC24; J1) are applied to the MAIN unit (J1600, pin 6) via the buffer amplifier (RC-24; Q13).

• DV MODE

The amplified AF signals from microphone amplifier (Q1673) are amplified at the ALC amplifier (IC1672, pins 3, 5) via the mode switch (IC1670, pins 1, 7). The amplified signals are applied to the IDC amplifier (IC1671, pins 6, 7) and then passed through the splatter filter (IC1671, pins 1, 3).

The filtered signals are applied to the LOGIC-1 unit via the J1801 (pin 10).

• FM MODE

The amplified AF signals from microphone amplifier (Q1673) are passed through the mode switch (IC1670, pins 1, 6) and then applied to the IDC amplifier (IC1671, pins 6, 7). The amplified signals are passed through the splatter filter (IC1671, pins 1, 3) and mode switch (IC1673, pins 1, 6).

The CTCSS signals (CTCS) from the CPU (LOGIC-1 unit; IC50) via (LOGIC-1 unit; IC57, pin 1) are mixed with the AF signals from the IDC amplifier (IC1671, pin 7). The mixed signals are passed through the splatter filter (IC1671, pins 1, 3) and mode switch (IC1673, pins 1, 6).

The switched AF signals (IC1673, pin 6) are applied to the modulation circuit.

4-2-2 DIGITAL CIRCUITS (LOGIC-1 UNIT)

• DV MODE (VOICE OPERATION)

The AF signals from the splatter filter (MAIN unit; IC1671, pin 1) are applied to the liner CODEC IC (IC1, pin 24) to convert into digital voice data at the A/D converter section as the "DAMOD" signal. The converted digital audio signals are applied to the AMBE CODEC IC (IC2) for code compression and are then applied to the CPU (IC50).

The digital audio signals are processed at the CPU (IC50) and then applied to the FPGA IC (IC200).

• DD MODE/DV MODE (LOW SPEED DATA OPERATION)

While operating in DD mode the data signal from connected PC are applied to the Ethernet controller (IC104) and then applied to the CPU (IC50)

While operating in DV mode (low speed data operation) the data signal from connected PC are applied to the USB controller (IC550) and then applied to the CPU (IC50)

The applied data signals to the CPU (IC50) are processed and then applied to the FPGA IC (IC200).

The output signals from the CPU (IC50) are applied to the FPGA IC (IC200) to convert to the I/Q baseband signals and then output from pins 75–80, 82–87, 92–99 (IC200). The I/Q baseband signals are mixed at the resistors (R250–R293) and then pass through the baseband filters (IC300, IC301, IC302).

The filtered signals (I/Q baseband signals) are applied to the MAIN unit via J400 (pins 1, 3).

4-2-3 MODULATION CIRCUIT (MAIN UNIT)

• DV/DD MODE

The modulation circuit modulates the 2nd LO signal at the quadrature modulation circuit (IC890) using the I/Q baseband signals from the LOGIC-1 unit.

The I/Q baseband signals from the LOGIC-1 unit are amplified at the I/Q baseband amplifiers (IC832, pins 1, 2, 6, 7) and then applied to amplifier section (pins 4, 7) of the quadrature modulator IC (IC890, pins 4, 7, 14). The 2nd LO signal is applied to the quadrature modulator IC (IC890, pin 8)

• MODULATION AND TRANSMIT CIRCUITS

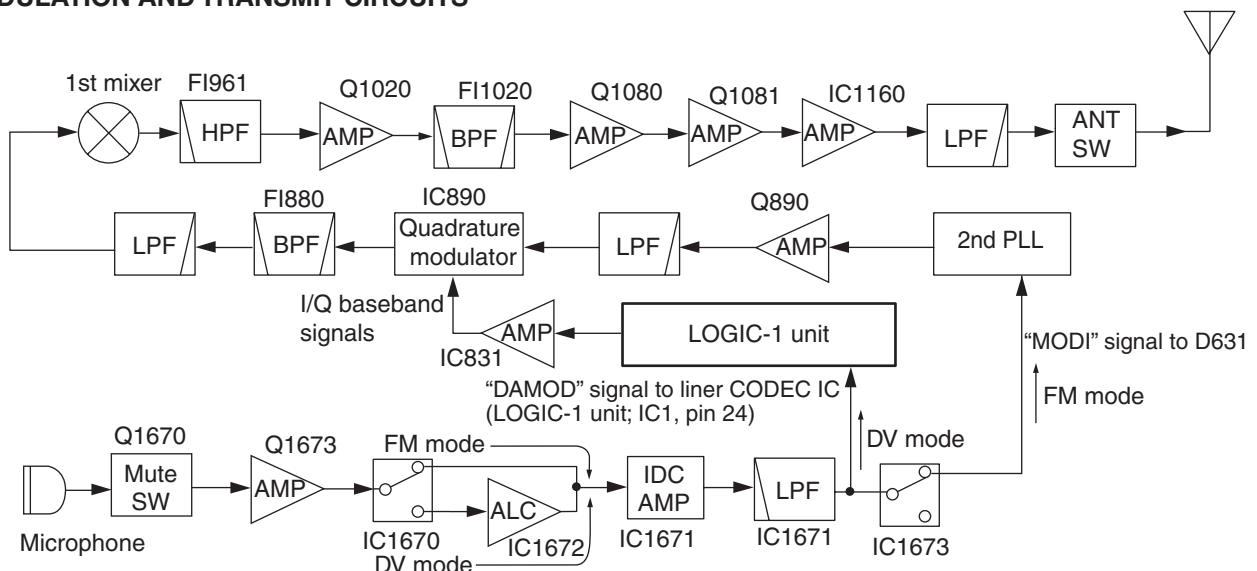

and then mixed with the amplified I/Q baseband signals. The modulated signal is output from pin 14.

The modulated signal (IC890, pin 14) is passed through the bandpass (F1880) and low-pass (L892, L893, C904–C908) filters and then applied to the 1st mixer circuit.

• FM MODE

The modulation circuit modulates the 2nd LO signal using the microphone audio signals.

The switched AF signals from the mode switch (IC1673, pin 6) change the reactance of varactor diode (D631) to modulate the 2nd LO signal at the 2nd VCO circuit (Q631, D630). The modulated signal from the 2nd VCO circuit is amplified at the buffer amplifiers (Q632, Q771) and is then applied to the T/R switch (D770). The switched signal is applied to the 2nd LO amplifier (Q890) and then passed through the low-pass filter (L891, C896–C898), quadrature modulator IC (IC890), bandpass filter (F1880) and low-pass filter (L892, L893, C904–C908).

The filtered signal is applied to the 1st mixer circuit.

4-2-4 1ST MIXER CIRCUITS (MAIN UNIT)

The filtered signal from the low-pass filter (L892, L893, C904–C908) is mixed with the 1st LO signal, generated at the 1st VCO circuit (Q471, Q472, D472) via the buffer amplifier (Q710), at the 1st mixer circuit (IC960, pin 1, 6) to convert into the RF signal. The RF signal from the 1st mixer circuit (IC960, pin 6) is passed through the bandpass filter (F1961) and then amplified at the RF amplifier (IC1021). The amplified signal is passed through the bandpass filter (F11020) to suppress spurious components.

4-2-5 DRIVE/POWER AMPLIFIER CIRCUITS (MAIN UNIT)

The filtered RF signal from the bandpass filter (F11020) is amplified at the drive (Q1080, Q1081) and power (IC1160) amplifiers to obtain a stable 10 W of output power.

• PLL CIRCUITS

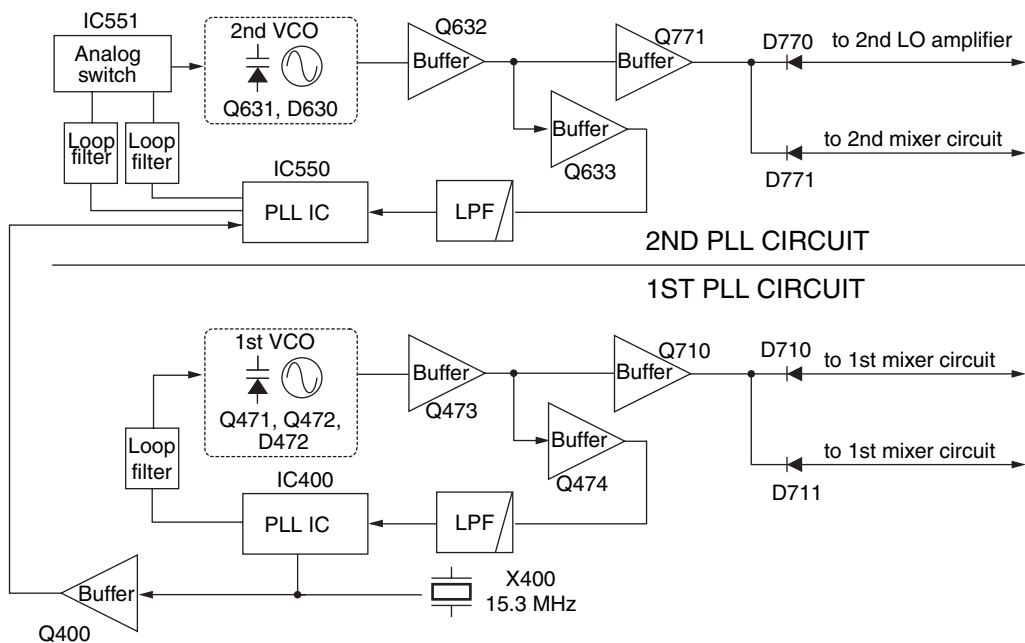

The power amplified signal from the power amplifier (IC1160, pin 4) is passed through the antenna switch (D1160), SWR detector circuit (D1166, D1170), low-pass filter which contains strip-line and C1198, and then applied to the antenna connector (CHASSIS unit: J1).

4-2-6 APC CIRCUIT (MAIN UNIT)

The APC circuit protects the driver and power amplifiers from a mismatched output load and stabilizes the output power.

The SWR detector circuit (D1166, D1170) detects the forward signals and reflection signals, and converts it into DC voltage. The output voltage is at a minimum level when the antenna impedance is matched with 50 Ω and is increased when it is mismatched.

The detected voltage is applied to the APC amplifier (IC1250, pins 3, 4) and is compared with the reference voltage which is supplied from the CPU (LOGIC-1 unit: IC50, pin 38) as "PCON" signal.

When antenna impedance is mismatched, the detected voltage exceeds the power setting voltage. The output voltage of the APC amplifiers (IC1250, IC1251) controls the bias voltage of the drive (Q1080) and power (IC1160) amplifiers to reduce the output power.

4-3 PLL CIRCUITS

4-3-1 PLL CIRCUITS (MAIN UNIT)

The PLL circuit provides stable oscillation of the 1st LO frequencies and 2nd LO frequency. The PLL output compares the phase of the divided VCO frequency to the reference frequency. The PLL output frequency is controlled by the divided ratio (N-data) of a programmable divider.

4-3-2 1ST PLL CIRCUIT (MAIN UNIT)

The 1st PLL circuit oscillates the 1st LO frequencies, and signals are applied to the 1st mixer circuit. The oscillated

signal from the 1st VCO (Q471, Q472, D471) is applied to the buffer amplifiers (Q473, Q474) and is then applied to the PLL IC (IC400, pin 6).

The PLL IC contains a prescaler, programmable counter, programmable divider and phase detector, etc.

The applied signal is divided at the prescaler and programmable counter section by the N-data ratio from the CPU (LOGIC-1 unit; IC50). The divided signal is detected on phase at the phase detector using the reference frequency and output from pin 4. The output signal is passed through the loop filter and is then applied to the 1st VCO circuit.

The oscillated signal at the 1st VCO is buffer amplified at Q473 and then passed through the low-pass (L474, L475, C488–C492) and high-pass (L47–L477, C493–C497) filters. The filtered signal is applied to the buffer amplifier (Q710) and then applied to the T/R switch (D710, D711).

The receive 1st LO signal from the T/R switch (D711) is applied to the 1st mixer circuit (IC71).

The transmit signal from the T/R switch (D710) is applied to the 1st mixer circuit (IC960).

A portion of the signal from the buffer amplifier (Q473) is fed back to the PLL IC (IC400, pin 6) via the buffer amplifier (Q474) as the comparison signal.

4-3-3 2ND PLL CIRCUIT (MAIN UNIT)

The 2nd PLL circuit oscillates the 2nd LO frequency, and the signal is applied to the 2nd mixer circuits.

The signal oscillated at the 2nd VCO circuit (Q631, D630) is amplified at the buffer amplifiers (Q632, Q633), then applied to the PLL IC (IC550, pins 2, 19). The applied signal is divided at the prescaler and programmable counter section by the N-data ratio from the CPU (LOGIC-1 unit; IC50). The divided signal is detected on phase at the phase detector using the reference frequency and output from pins 8, 13 (IC550).

While operating in DV/DD mode, the detected signal from pin 13 (IC550) is passed through the loop filter (R555–R557, C564, C567) and then applied to the 2nd VCO circuit via the mode switch (IC551, pins 1, 7).

While operating in FM mode, the detected signal from pin 8 (IC550) is passed through the loop filter (R559–R561, C571, C574) and then applied to the 2nd VCO circuit via the mode switch (IC551, pins 1, 6).

The oscillated signal at the 2nd VCO is amplified at the buffer amplifiers (Q632 Q771), and is then applied to the T/R switch (D770, D771).

The receive 2nd LO signal from the T/R switch (D771) is applied to the 2nd mixer circuit (Q131).

The transmit signal from the T/R switch (D770) is applied to the 2nd LO amplifier (Q890).

A portion of the signal from the buffer amplifier (Q632) is fed back to the PLL IC (IC550, pins 2, 19) via the buffer amplifier (Q633) and low-pass filter (L631, C653, C654) as the comparison signal.

4-4 POWER SUPPLY CIRCUITS

4-4-1 LOGIC-1 UNIT VOLTAGE LINE

Line	Description
5V	Common 5 V controlled by the +5 V regulator circuit (Q50 and Q51) using the "PWRS" signal from the CPU (IC50, pins 101).
3.3V	Common 3.3 V converted from the 5V line by the 3.3V regulator circuit (IC502).
3.2V	Common 3.2 V converted from the 5 V line by the 3.2V regulator circuit (IC4).

4-4-2 MAIN UNIT VOLTAGE LINE

Line	Description
HV	The voltage from a DC power supply.
VCC	The same voltage as the HV line which is controlled by the power switching circuit (Q23, Q24). When the power switch is pushed, the CPU outputs the "PWR" control signal to the power switching circuit to turn the circuit ON.
+9	Common 9 V converted from the HV line at the +9 CTRL circuit (IC1330). The output voltage is applied to the volume controller (IC1550), etc.
+5	Common 5 V converted from the +9V line at the 5 V regulator circuit (IC1331). The output voltage is applied to the mode switches (IC1462, IC1463), etc.
DM+5	Common 5 V converted from the +9V line at the 5 V regulator circuit (IC830). The output voltage is applied to the modulation amplifiers (IC831, IC832), etc.
T+9	Transmit 9 V controlled by the T+9 regulator circuit (Q1333, Q1334, D1331) using the "TXS" signal from the CPU (LOGIC-1 unit; IC50, pin 94). The output voltage is applied to the APC amplifier (IC1250), etc.
T+5	Transmit 5 V controlled by the T+5 regulator circuit (Q1336, D1332, D1333) using the "TXS" signal from the CPU (LOGIC-1 unit; IC50, pin 94). The output voltage is applied to the RF amplifier (IC1021), etc.
R+5	Receive 5 V controlled by the R+5 regulator circuit (Q1337) using the "RXS" signal from the CPU (LOGIC-1 unit; IC50, pin 95). The output voltage is applied to the RF amplifier (Q2) and 1st mixer (IC71), etc.
T+3	Transmit 3 V controlled by the T+3 regulator circuit (Q1342) using the "TXS" signal from the CPU (LOGIC-1 unit; IC50, pin 94). The output voltage is applied to the 1st mixer (IC960), etc.
R+3	Receive 3 V controlled by the R+3 regulator circuit (Q1343) using the "RXS" signal from the CPU (LOGIC-1 unit; IC50, pin 95). The output voltage is applied to the RF amplifier (Q1), etc.

4-5 PORT ALLOCATIONS

4-5-1 CPU (LOGIC-1 UNIT; IC50)

Pin number	Port name	Description
29	MU/D	Input port for up/down signal from the connected microphone.
32	NOIS	Input port for the noise signal from the noise detector (MAIN unit; D195).
31	RSSI	Input port for the S-meter signal from the demodulator IC (MAIN unit; IC191, pin 12).
33	TONI	Input port for CTCSS signal from the low-pass filter (MAIN unit, IC1461, pin 1).
42	TXD1	Output data signals to the USB controller (IC550, pin 24).
43	RXD1	Input port for data signals from the USB controller (IC550, pin 25) via the (IC553).
53	SDA	I/O port for data signals from/to the EEPROM (IC54, pin 5).
54	SCL	Outputs clock signal to the EEPROM (IC54, pin 6).
61	BEEP	Outputs beep audio signals.
71	RESET	Input port for reset signal from the reset IC (IC52, pin 1).
72	P2RSC	Outputs control signal to the mode switch (MAIN unit; IC551, pin 5) via the level converter (IC55).
73	P2STC	Outputs strobe signal to the 2nd PLL IC (MAIN unit; IC550, pin 3) via the level converter (IC55).
74	PDATC	Outputs the data signal to the 1st and 2nd PLL ICs (MAIN unit; IC400, pin 15, IC550, pin 5) via the level converter (IC55).
75	PSCKC	Outputs clock signal to the 1st and 2nd PLL ICs (MAIN unit; IC400, pin 14, IC550, pin 4) via the level converter (IC55).
76	P1STC	Outputs strobe signal to the 1st PLL IC (MAIN unit; IC400, pin 16) via the level converter (IC55).
77	+5AC	Outputs control signal to the 5A (Q1345) and D+5 (Q1347) regulators via the level converter (IC55). Low: While the +5 and D+5 regulators are activated.
78	W/NSC	Outputs control signal to the DV/FM filter switches (MAIN unit; D192, D193) via the level converter (IC55). High: While DV mode is selected.
79	ADSWC	Outputs control signal to the mode switches (MAIN unit; IC1411, IC1670, IC1673) via the level converter (IC55). Low: While DV mode is selected.
80	TXLED	Outputs TX LED control signal. High: During transmit.
82	RXLED	Outputs RX LED control signal. High: While receiving or squelch is opened.

Pin number	Port name	Description
85	PCON	Outputs control signal to the TX power controller (MAIN unit; Q1250).
86	ULCK	Input port for the PLL unlock signal. High: The PLL circuit is unlocked.
87	MMUT	Outputs the microphone mute signal to the mute switch (MAIN unit; Q1670). Low: While microphone audio is muted.
93	SCAN	Outputs scan control signal to the scan switch (Q400). High: While scanning.
94	TXS	Outputs the T+5, T+3 regulator circuits (MAIN unit; Q1336, Q1342) control signal. High: During transmit.
95	RXS	Outputs the R+5, R+3 regulator circuits (MAIN unit; Q1337, Q1343) control signal. High: During receive.
96	AMUT	Outputs the AF mute signal to the AF mute switch (MAIN unit; Q1550). Low: While digital code/call sign/noise/tone squelch are closed, the audio level is set to minimum position or transmitting.
102	RMUT	Outputs the SQL mute signal to the AF switch (MAIN unit; IC1463, pin 2). High: While noise or tone squelch is closed.
103	AFC5W	Outputs AFC switch (IC352, pin 5) control signal.
105	DACK2	Outputs clock signal to the D/A converter (IC57, pin 7).
106	DADAT2	Outputs the data signal to the D/A converter (IC57, pin 6).
107	DACK1	Outputs clock signal to the D/A converter (IC56, pin 7).
108	DADAT1	Outputs the data signal to the D/A converter (IC56, pin 6).
128	FSTB	Outputs strobe signal to the FPGA IC (IC200).
129	MSTRC	Outputs strobe signal to the liner CODEC IC (IC1) and FPGA IC (IC200).
130	MDATC	Outputs the data signal to the liner CODEC IC (IC1) and FPGA IC (IC200).
131	MCLKC	Outputs clock signal to the liner CODEC IC (IC1) and FPGA IC (IC200).
132	MRESC	Outputs reset signal to the liner CODEC IC (IC1) and FPGA IC (IC200).

SECTION 5 ADJUSTMENT PROCEDURES

5-1 PREPARATION

When adjusting ID-1, ADJUSTMENT SOFTWARE, JIG CABLE (see illustration on page 5-2) and OPC-1127 USB CABLE are required.

■ REQUIRED TEST EQUIPMENT

EQUIPMENT	GRADE AND RANGE	EQUIPMENT	GRADE AND RANGE
DC power supply	Output voltage : 13.8 V DC Current capacity : 10 A or more	Audio generator	Frequency range : 300–3000 Hz Measuring range : 1–500 mV
Modulation analyzer	Frequency range : DC–1500 MHz Measuring range : 0 to ±10 kHz	Attenuator	Power attenuation : 50 or 60 dB Capacity : 20 W
Frequency counter	Frequency range : 0.1–1500 MHz Frequency accuracy : ±1 ppm or better Sensitivity : 100 mV or better	Standard signal generator (SSG)	Frequency range : 0.1–1500 MHz Output level : 0.1 μV to 32 mV (–127 to –17 dBm)
Digital multimeter	Input impedance : 10 MΩ/V DC or more	AC millivoltmeter	Measuring range : 10 mV to 10 V
RF power meter	Measuring range : 1–20 W Frequency range : 1000–1500 MHz Impedance : 50 Ω SWR : Better than 1.2 : 1	Oscilloscope	Frequency rang : DC–20 MHz Measuring range : 0.01–20 V
		External speaker	Input impedance : 8 Ω Capacity : 10 W or more
Spectrum analyzer	Frequency range : At least 1500 MHz Spectrum bandwidth : 100 kHz or more	DC Ammeter	Measuring capacity : 3 A

■ SYSTEM REQUIREMENTS

- Microsoft® Windows® 98/98SE/Me/2000/XP
- USB port

■ ADJUSTMENT SOFTWARE INSTALLATION

- ① Quit all applications when Windows is running.
- ② Insert the CD into the appropriate CD drive.
- ③ Double-click the “Setup.exe” contained in the adjustment software folder in the CD drive.
- ④ The “Welcome to the InstallShield Wizard for adjustment software screen will appears.
Click [Next>].
- ⑤ The “Choose Destination Location” will appears.
Click [Next>] to install the software into the specified folder.
- ⑥ After the installation is completed, the “InstallShield Wizard Complete” will appears.
Click [Finish].
- ⑦ Eject the CD.
- ⑧ The adjustment software icon appears on the desktop screen.

■ STARTING SOFTWARE ADJUSTMENT

- ① Connect the transceiver and PC with the OPC-1127.
- ② Turn the transceiver power ON.
- ③ Boot up Windows, and double click the adjustment software icon on the desktop screen.
Then the control panel screen will appears.
- ④ Click [Adjustment (A)] in the menu bar and then click [Adjustment panel (F9)] in the pull down menu.
Then the adjustment screen will appears.
- ⑤ Set or modify adjustment data as desired.

■ OPERATING ON THE ADJUSTMENT MODE (CONNECTED COMPUTER KEYBOARD)

- Adjustment item selection* : [↑]/[↓]
- Specified value adjustment : [←]/[→]
- Mode selection : [M]
- PTT control : [T]
- RF power selection : [P]
- AF level control [UP] : [Q]
- AF level control [DOWN] : [W]
- Squelch level control [UP] : [A]
- Squelch level control [DOWN] : [S]
- Read the transceiver's data : [F5]
- All Default setting : [CTRL]+[D]

*When select the adjustment item, the adjustment frequency and operating mode are selected automatically.

• CONNECTION

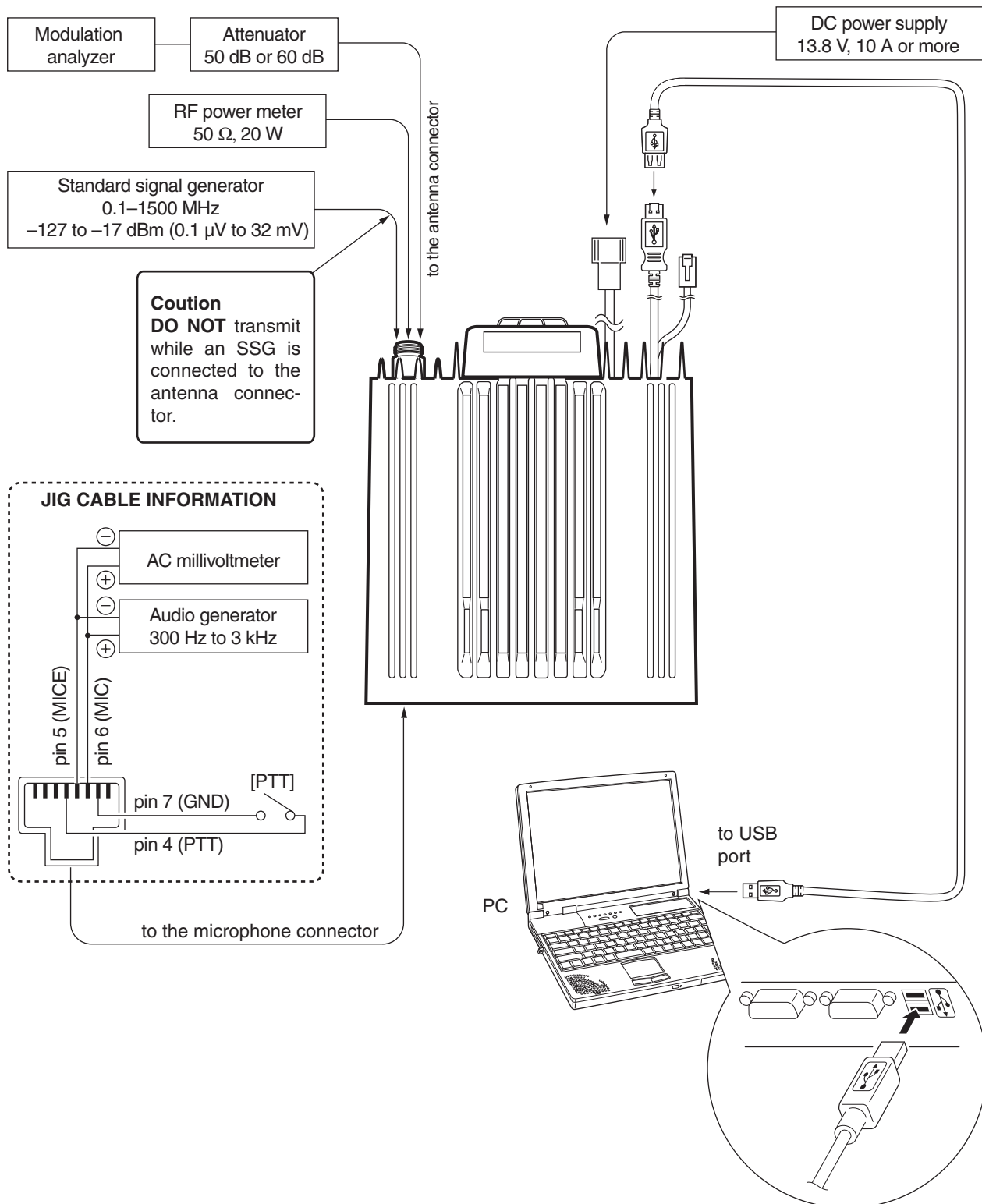

5-2 PLL AND CODEC ADJUSTMENT

ADJUSTMENT	ADJUSTMENT CONDITION	MEASUREMENT		VALUE	ADJUSTMENT		
		UNIT	LOCATION		UNIT	ADJUST	
FPGA FREQUENCY [Set FPGA frequency]	1	<ul style="list-style-type: none"> Operating freq. : 1240.00 MHz Mode : DD mode Receiving 	LOGIC-1 unit	Connect a frequency counter to the check point "CP200".	16.3840 MHz	LOGIC-1 unit	C202
	2	<ul style="list-style-type: none"> Operating freq. : 1240.00 MHz Mode : DV mode Receiving 			9.8304 MHz	LOGIC-1 unit	C215
PLL LOCK VOLTAGE	1	<ul style="list-style-type: none"> Operating freq. : 1240.00 MHz Mode : DV mode Connect an RF power meter or 50 Ω dummy load to the antenna connector. Receiving 	MAIN unit	Connect a digital multimeter or an oscilloscope to the check point "LV1".	More than 0.9 V	Verify	
	2	<ul style="list-style-type: none"> Operating freq. : 1300.00 MHz Receiving 			Less than 4.4 V		
	3	<ul style="list-style-type: none"> Mode : FM mode Receiving 	MAIN unit	Connect a digital multimeter or an oscilloscope to the check point "LV2".	3.1–4.0 V		
	4	<ul style="list-style-type: none"> Mode : DD mode Receiving 			2.6–3.3 V		
	5	<ul style="list-style-type: none"> Mode : FM mode Transmitting 			3.3–4.0 V		
I/Q BALANCE [FPGA D.C. voltage adjustment /DV I]	1	<ul style="list-style-type: none"> Preset "IQ Direct-current output" ON. Operating freq. : 1270.00 MHz Mode : DV mode Connect an RF power meter or 50 Ω dummy load to the antenna connector. Transmitting 	MAIN unit	Connect a digital multimeter or an oscilloscope to the check point "CP.I".	The same voltage of the check point "CP.IR".	PC screen	[FPGA D.C. voltage adjustment /DV I]
[FPGA D.C. voltage adjustment /DV Q]	2	<ul style="list-style-type: none"> Transmitting 	MAIN unit	Connect a digital multimeter or an oscilloscope to the check point "CP.Q".	The same voltage of the check point "CP.QR".	PC screen	[FPGA D.C. voltage adjustment /DV Q]
[FPGA D.C. voltage adjustment /DV I]	3	<ul style="list-style-type: none"> Transmitting 	Rear panel	Connect a spectrum analyzer to the antenna connector through an attenuator.	Minimum output level	PC screen	[FPGA D.C. voltage adjustment /DV I],
[FPGA D.C. voltage adjustment /DV Q]	4						[FPGA D.C. voltage adjustment /DV Q]
<ul style="list-style-type: none"> Repeat step 3 and step 4 several times. 							

• MAIN AND LOGIC-1 UNITS

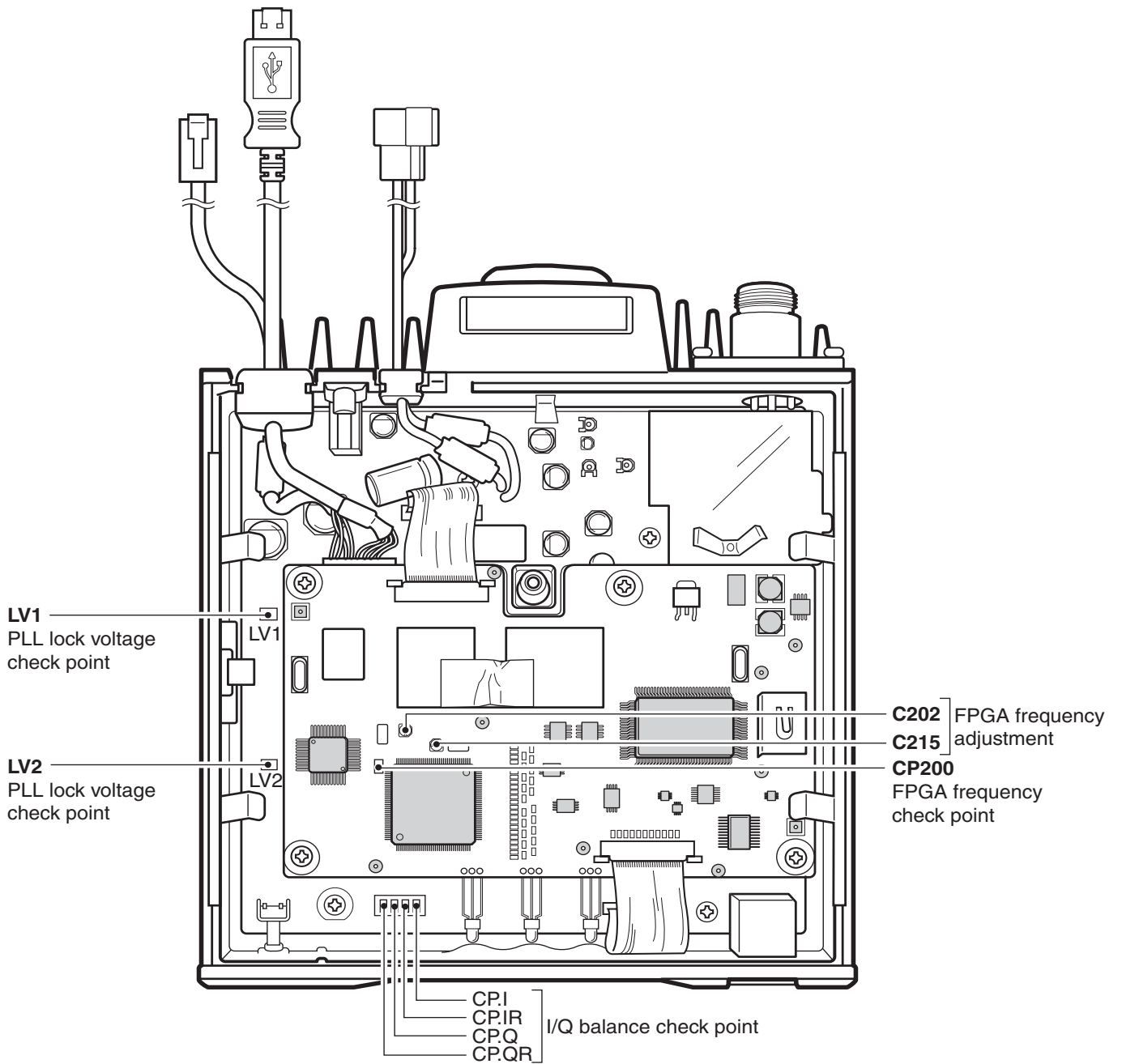

5-3 TRANSMITTER ADJUSTMENT

ADJUSTMENT	ADJUSTMENT CONDITION	MEASUREMENT		VALUE	ADJUSTMENT		
		UNIT	LOCATION		UNIT	ADJUST	
YGR CURRENT [FPGA D.C. voltage ad- justment /DV I]	1	<ul style="list-style-type: none"> • Preset R1086 and R1087 maximum counterclockwise. • Preset "IQ Direct-current output" ON. 	Rear panel	Connect an ammeter between the DC power supply and ID-1.	100 mA higher from the pre-set position.	MAIN unit	R1087
	2	<ul style="list-style-type: none"> • Operating freq. : 1300.00 MHz • Mode : DV mode • Connect an RF power meter or 50 Ω dummy load to the antenna connector. • Transmitting 			100 mA higher from step 1.	MAIN unit	R1086
REFERENCE FREQUENCY [REF Crystal adjustment]	1	<ul style="list-style-type: none"> • Operating freq. : 1300.00 MHz • Mode : FM mode • Connect an RF power meter or 50 Ω dummy load to the antenna connector. • Transmitting 	Rear panel	Loosely couple a frequency counter to the antenna connector.	1300.0000 MHz	PC screen	[REF Crystal adjustment]
FM CARRIER [FPGA D.C. voltage ad- justment /FM I]	1	<ul style="list-style-type: none"> • Operating freq. : 1300.00 MHz • Mode : FM mode • Connect an RF power meter or 50 Ω dummy load to the antenna connector. • Transmitting 	MAIN unit	Connect a digital multimeter or an oscilloscope to the check point "CP30".	The same voltage that during in DV mode (TX) at the check point "CP30".	PC screen	[FPGA D.C. voltage adjustment /FM I]
[FPGA D.C. voltage ad- justment /FM Q]	2	<ul style="list-style-type: none"> • Transmitting 			The same adjustment as step 1, if need.	PC screen	[FPGA D.C. voltage adjustment /FM Q]
OUTPUT POWER [TX output adjustment]	1	<ul style="list-style-type: none"> • Operating freq. : 1300.00 MHz • Mode : FM mode • TX power : High • Transmitting 	Rear panel	Connect an RF power meter to the antenna connector.	11 W	MAIN unit	R1251
FM DEVIATION [FM modulation adjustment]	1	<ul style="list-style-type: none"> • Operating freq. : 1270.00 MHz • Mode : FM mode • Connect an audio generator to the [MIC] connector and set as : 1.0 kHz/20 mVrms • Set a Modulation analyzer as: HPF : OFF LPF : 20 kHz De-emphasis : OFF Detector : (P-P)/2 • Transmitting 	Rear panel	Connect a modulation analyzer to the antenna connector through an attenuator.	±4.35 kHz	MAIN unit	R1704
DSP INPUT LEVEL [DSP input level adjustment]	1	<ul style="list-style-type: none"> • Operating freq. : 1270.00 MHz • Connect an audio generator to the [MIC] connector and set as : 1.0 kHz/20 mVrms • Connect an RF power meter or 50 Ω dummy load to the antenna connector. • Transmitting 	LOGIC-1 unit	Connect an oscilloscope to the check point "CP207".	750 mVp-p	MAIN unit	R1707

• MAIN AND LOGIC-1 UNITS

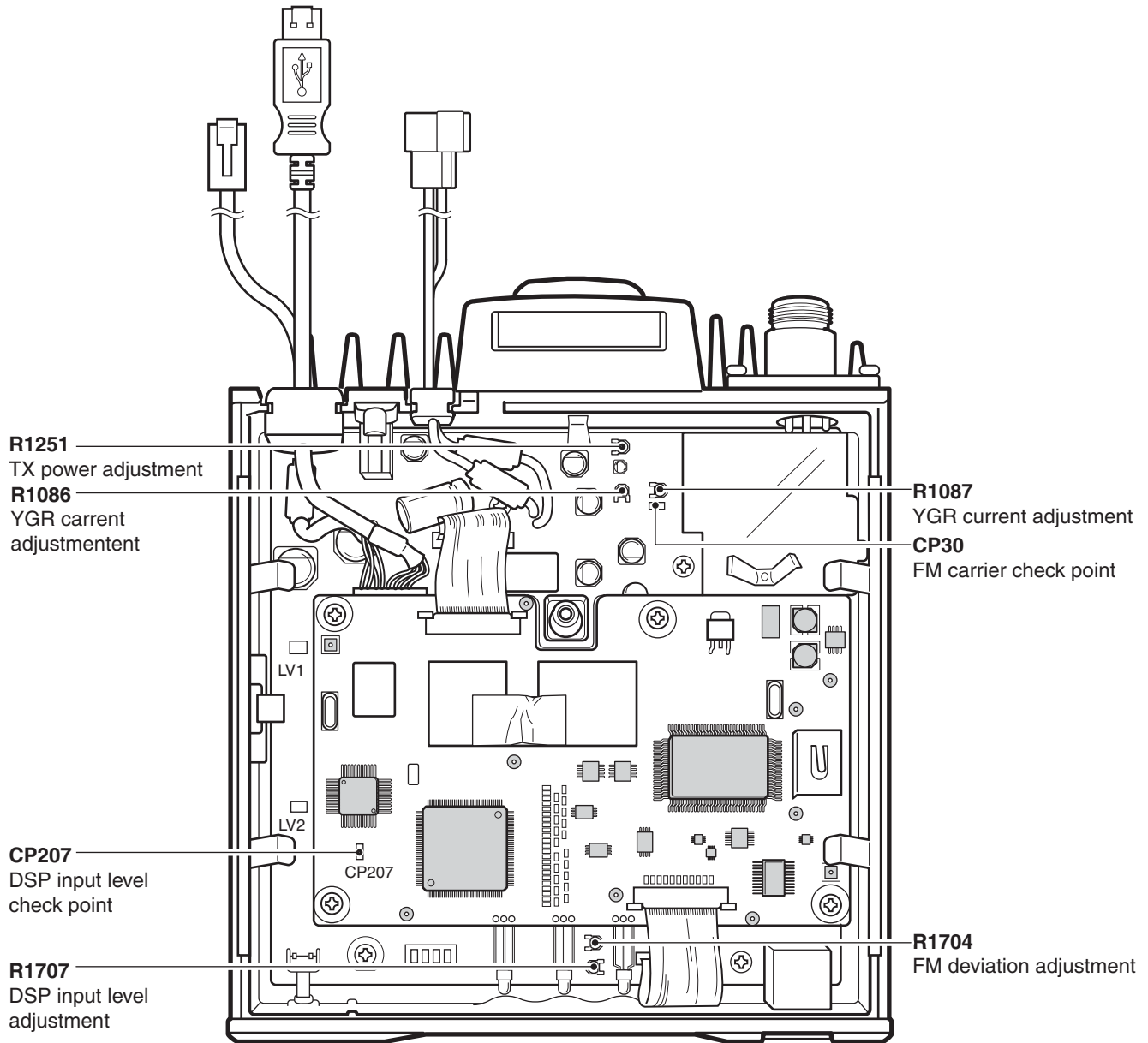

5-4 RECEIVER ADJUSTMENT

ADJUSTMENT ITEM	ADJUSTMENT CONDITION	OPERATION
SQUELCH LEVEL [SQL adjustment /FM thresh]	1 <ul style="list-style-type: none"> Operating freq. : 1270.00 MHz Mode : FM mode Connect an SSG to the antenna connector and set as: <ul style="list-style-type: none"> Level : 0.11 μV^* (-126 dBm) Modulation : 1 kHz Deviation : 3.5 kHz Receiving 	<ul style="list-style-type: none"> Push [ENTER] on the connected computer keyboard to set to "SQL adjustment/FM thresh" level.
[SQL adjustment /FM tight]	2 <ul style="list-style-type: none"> Set an SSG as: <ul style="list-style-type: none"> Level : 0.18 μV^* (-122 dBm) Receiving 	<ul style="list-style-type: none"> Push [ENTER] on the connected computer keyboard to set to "SQL adjustment/FM tight" level.
AFC CENTER [AFC center voltage adjustment/FM]	1 <ul style="list-style-type: none"> Operating freq. : 1270.00 MHz Mode : FM mode Connect an SSG to the antenna connector and set as: <ul style="list-style-type: none"> Level : 1 mV* (-47 dBm) Modulation : OFF Receiving 	<ul style="list-style-type: none"> Push [ENTER] on the connected computer's keyboard to set to "AFC center voltage adjustment/FM" level.
[AFC center voltage adjustment /DV]	2 <ul style="list-style-type: none"> Mode : DV mode Receiving 	<ul style="list-style-type: none"> Push [ENTER] on the connected computer keyboard to set to "AFC center voltage/DV" level.
S-METER (FM) [S-meter adjustment /FM min]	1 <ul style="list-style-type: none"> Operating freq. : 1270.00 MHz Mode : FM mode Connect an SSG to the antenna connector and set as: <ul style="list-style-type: none"> Level : 0.18 μV^* (-122 dBm) Modulation : OFF Receiving 	<ul style="list-style-type: none"> Push [ENTER] on the connected computer keyboard to set to "S-meter adjustment/FM min" level.
[S-meter adjustment /FM full]	2 <ul style="list-style-type: none"> Set an SSG as: <ul style="list-style-type: none"> Level : 5.6 μV^* (-92 dBm) Receiving 	<ul style="list-style-type: none"> Push [ENTER] on the connected computer keyboard to set to "S-meter adjustment/FM full" level.
S-METER (DV) [S-meter adjustment /DV min]	1 <ul style="list-style-type: none"> Operating freq. : 1270.00 MHz Mode : DV mode Set an SSG as: <ul style="list-style-type: none"> Level : 0.18 μV^* (-122 dBm) Modulation : OFF Receiving 	<ul style="list-style-type: none"> Push [ENTER] on the connected computer keyboard to set to "S-meter adjustment/DV min" level.
[S-meter adjustment /DV full]	2 <ul style="list-style-type: none"> Set an SSG as: <ul style="list-style-type: none"> Level : 5.6 μV^* (-92 dBm) Receiving 	<ul style="list-style-type: none"> Push [ENTER] on the connected computer keyboard to set to "S-meter adjustment/DV full" level.
S-METER (DD) [S-meter adjustment /DD min]	1 <ul style="list-style-type: none"> Operating freq. : 1270.00 MHz Mode : DD mode Set an SSG as: <ul style="list-style-type: none"> Level : 1.6 μV^* (-103 dBm) Modulation : OFF Receiving 	<ul style="list-style-type: none"> Push [ENTER] on the connected computer keyboard to set to "S-meter adjustment/DD min" level.
[S-meter adjustment /DD full]	2 <ul style="list-style-type: none"> Set an SSG as: <ul style="list-style-type: none"> Level : 5.6 μV^* (-92 dBm) Receiving 	<ul style="list-style-type: none"> Push [ENTER] on the connected computer keyboard to set to "S-meter adjustment/DD full" level.

*The output level of the standard signal generator (SSG) is indicated as the SSG's open circuit.

[MAIN UNIT]

Table with columns: REF NO., ORDER NO., DESCRIPTION, M., H/V LOCATION. Contains parts list for the main unit on the left side of the page.

[MAIN UNIT]

Table with columns: REF NO., ORDER NO., DESCRIPTION, M., H/V LOCATION. Contains parts list for the main unit on the right side of the page.

M.=Mounted side (T: Mounted on the Top side, B: Mounted on the Bottom side) S.=Surface mount

[MAIN UNIT]

Table with columns: REF NO., ORDER NO., DESCRIPTION, M., H/V LOCATION. Contains detailed specifications for various electronic components and their locations.

[MAIN UNIT]

Table with columns: REF NO., ORDER NO., DESCRIPTION, M., H/V LOCATION. Contains detailed specifications for various electronic components and their locations.







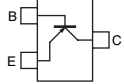
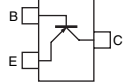
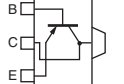
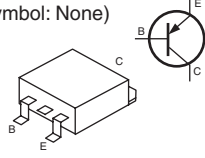
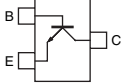
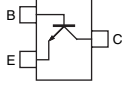
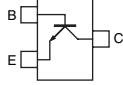
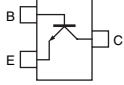
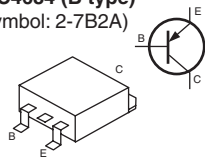
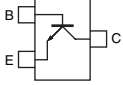
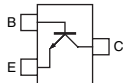
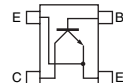
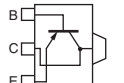
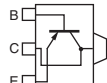
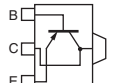
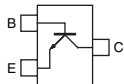
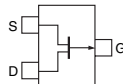
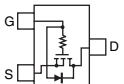
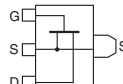
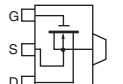
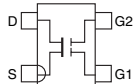
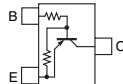
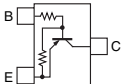
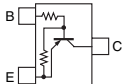
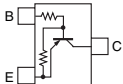
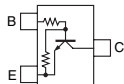
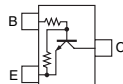
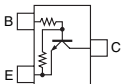
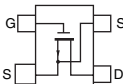
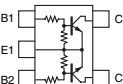
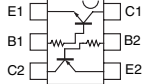



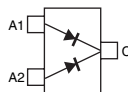
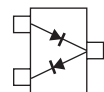

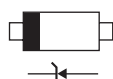

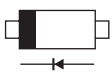

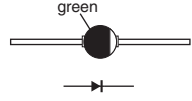
M.=Mounted side (T: Mounted on the Top side, B: Mounted on the Bottom side) S.=Surface mount

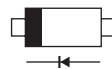
SECTION 7 SEMI-CONDUCTOR INFORMATION

• TRANSISTORS AND FET's

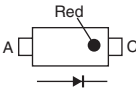
2SA1362 GR (Symbol: AEG) 	2SA1586 GR (Symbol: SG) 	2SB798 DK (Symbol: DK) 	2SB934 P (Symbol: None) 	2SC4081 R (Symbol: BR) 
2SC4081 S (Symbol: BS) 	2SC4215 O (Symbol: QO) 	2SC4226 R25 (Symbol: R25) 	2SC4684 (B type) (Symbol: 2-7B2A) 	2SC5107 O (Symbol: MFO) 
2SC5195 (Symbol: 88) 	2SC5454 R54 (Symbol: R54) 	2SD999 CK (Symbol: CK) 	2SD1619 T (Symbol: DB) 	2SD1801 S (Symbol: CE) 
2SD2216J S (Symbol: Y) 	2SJ144 GR (Symbol: VG) 	2SK2036 (Symbol: KJ) 	2SK2854 (Symbol: UP) 	2SK2855 (Symbol: UT) 
3SK241 R (Symbol: DU) 	DTA114 EU (Symbol: 16) 	DTA143 TUA (Symbol: 113) 	DTA143 ZU (Symbol: 113) 	DTA144 EU (Symbol: 16) 
DTC114 EU (Symbol: 14) 	DTC143 ZU (Symbol: 123) 	DTC144 EU (Symbol: 26) 	NE34018 (Symbol: V63) 	XP1214 (Symbol: 9H) 
XP4315 (Symbol: CB) 				

• DIODES

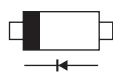
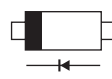
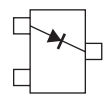
<p>1SS355 (Symbol: A)</p> 	<p>1SS364 (Symbol: BF)</p> 	<p>1SS372 (Symbol: N9)</p> 	<p>1SV239 (Symbol: TC)</p> 	<p>1SV245 (Symbol: T3)</p> 
<p>1SV282 (Symbol: TD)</p> 	<p>1SV307 (Symbol: TX)</p> 	<p>1SV308 (Symbol: TX)</p> 	<p>DA204 U (Symbol: K)</p> 	<p>DSA3A1 (Symbol: Green)</p> 
<p>HSM88AS (Symbol: C1)</p> 	<p>HSU88TRF (Symbol: 9)</p> 	<p>MA2S077 (Symbol: S)</p> 	<p>MA2S728 (Symbol: B)</p> 	<p>MA111 (Symbol: 1B)</p> 
<p>MA4PH224 (Symbol: Red)</p> 	<p>MA728 (Symbol: 2A)</p> 	<p>MA8030 H (Symbol: 3^0)</p> 	<p>MA8033 L (Symbol: 3_3)</p> 	<p>MA8062 M (Symbol: 6-2)</p> 
<p>MA8082 M (Symbol: 8-2)</p> 	<p>MA8091 M (Symbol: 9-1)</p> 	<p>SB07-03C (Symbol: J)</p> 		

SECTION 8 MECHANICAL PARTS AND DISASSEMBLY

8-1 ID-1

[CHASSIS PARTS]

REF.NO.	ODER NO.	DESCRIPTION	QTY.
EP1160	6910000970	DL-20P 2.6-3-1.2H	1
EP1162	6910000970	DL-20P 2.6-3-1.2H	1
IC1160	1150002190	RA18H1213G1-21	1
J1	6510004910	NR-DS-E 01	1
MF1	2710000590	MF40D-12H-001	1
MP1	8010018711	2506 Chassis-1	1
MP2	8810008660	Screw PH BT M3x8 NI-ZU	2
MP3	8810008660	Screw PH BT M3x8 NI-ZU	2
MP4	8810008660	Screw PH BT M3x8 NI-ZU	7
MP5	8110006640	2047 Cover	1
MP6	8810008450	Screw M4x8 ZK	1
MP9	8110005751	1729 Fan Cover-1	1
MP10	8810009110	Screw M2.6x16 ZK	4
MP13	8930035230	1546 TR-A Clip	1
MP14	8510012210	2047 Main Shield Y445	2
MP15	8930043710	1562 EMER Button (A)	1
MP17	8810007130	Screw H M3x6	4
MP19	8930048350	2146 Lens	3
MP21	8930039612	Thermally Sheet (C)-2 TC100HS (10X10)	1
MP22	8930049650	Thermally Sheet (H)	2
MP23	8930053472	Thermally Sheet (R)-2 TC200HS (10X10)	3
MP24	8930055051	Thermally Sheet (V)-1 TC400HS (10X15)	1
MP26	8510014251	2506 M-Plate-1	1
MP27	8930037120	1647 M-Holder	1
MP28	8930056781	2506 YGR Plate-1 Y938A	1
MP29	8510014241	2506 ANT Plate-1	1
MP36	8310053110	2506 NAME PLATE	1
W1	8900010890	OPC-1115	1
W2	8900010890	OPC-1115	1
W3	8900011950	OPC-1224	1

[ACCESSORIES]

REF.	ORDER. NO.	DESCRIPTION	QTY.
MC1	Optional product	Microphone HM-118N	1
SP1	Optional product	Speaker SP-22	1
P1	5610000270	Connector ALA651B	1
W1	Optional product	Cable OPC-345	1
W2	8900010930	Cable OPC-1127	1
W3	8900010550	Cable OPC-1069	1
MP1	8930055180	Self-adhesive rubber feet	1

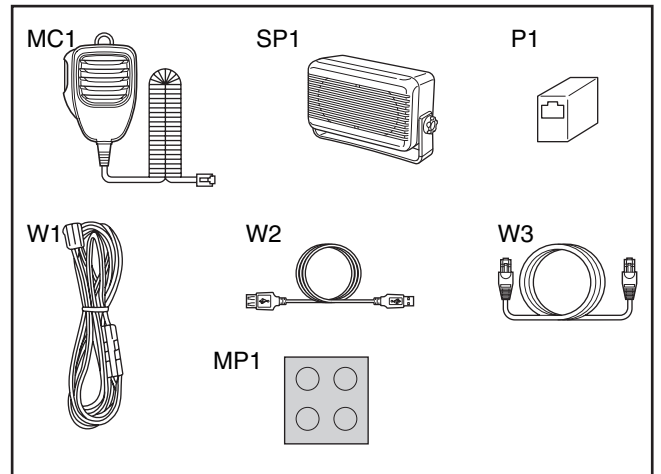

[MAIN UNIT]

REF.NO.	ODER NO.	DESCRIPTION	QTY.
MP30	8930014140	Earth Spring (D)	1
MP39	8930054521	Shield Sponge (E)-1	1
MP64	8930056580	Spacer (AD)	4
MP65	8810007130	Screw H M3x6	4
MP70	8930001170	Earth Spring (A) FX294	1
W1330	8900011960	OPC-1216	1

[LOGIC-1 UNIT]

REF.NO.	ORDER. NO.	DESCRIPTION	QTY.
MP6	8930001170	Earth Spring (A)	1

Screw abbreviations BT: Self-tapping
 NI-ZU: Nickel-zinc
 ZK : Black

8-2 RC-24

[CHASSIS PARTS]

REF.NO.	ODER NO.	DESCRIPTION	QTY.
DS1	5030002180	TSC0712-UFTDHW	1
EP2	8930048320	SRCN-2140-SP-N-W	2
MP1	8210015740	2140 Front Panel	1
MP2	8930047980	2140 LCD Holder	1
MP3	8930048290	2140 LCD Filter	1
MP4	8210015770	2140 Reflector	1
MP7	8610009840	Knob N234	1
MP9	8810008760	Screw PH BT M2x8 NI-ZU	5
MP10	8930038230	1765 Rear Seal	1
MP12	8810009060	Screw M3x6 ZK	4
MP13	8210013160	1765 Front Panel	1
MP16	8820000871	1705 Cap Screw-1	3
MP18	8310053110	2506 NAME PLATE	1
MP19	8930059370	2140 Front Key (C)	1
W1	8900010940	OPC-1119	1

[FRONT UNIT]

REF.NO.	ODER NO.	DESCRIPTION	QTY.
J1	6450001470	95003-2881	1
S21	2250000270	RH90N74E20-16F-1738	1

Screw abbreviations BT: Self-tapping
 NI-ZU: Nickel-zinc
 ZK : Black

[ACCESSORIES]

REF.	ORDER. NO.	DESCRIPTION	QTY.
W1	Optional product	Cable OPC-647	1
MP1	8010016470	1765 mounting braket	1
MP3	8810000470	Screw PH M5x12(+/-)	4
MP4	8810000950	Screw AO M5x16	4
MP5	8850000150	Flat washer M5 NI BS	4
MP6	8850000390	Spring washer M5	4
MP7	8830000120	Nut M5	4
MP9	8820000910	Screw 1765 SCREW	2

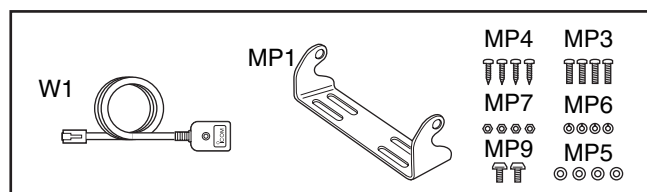

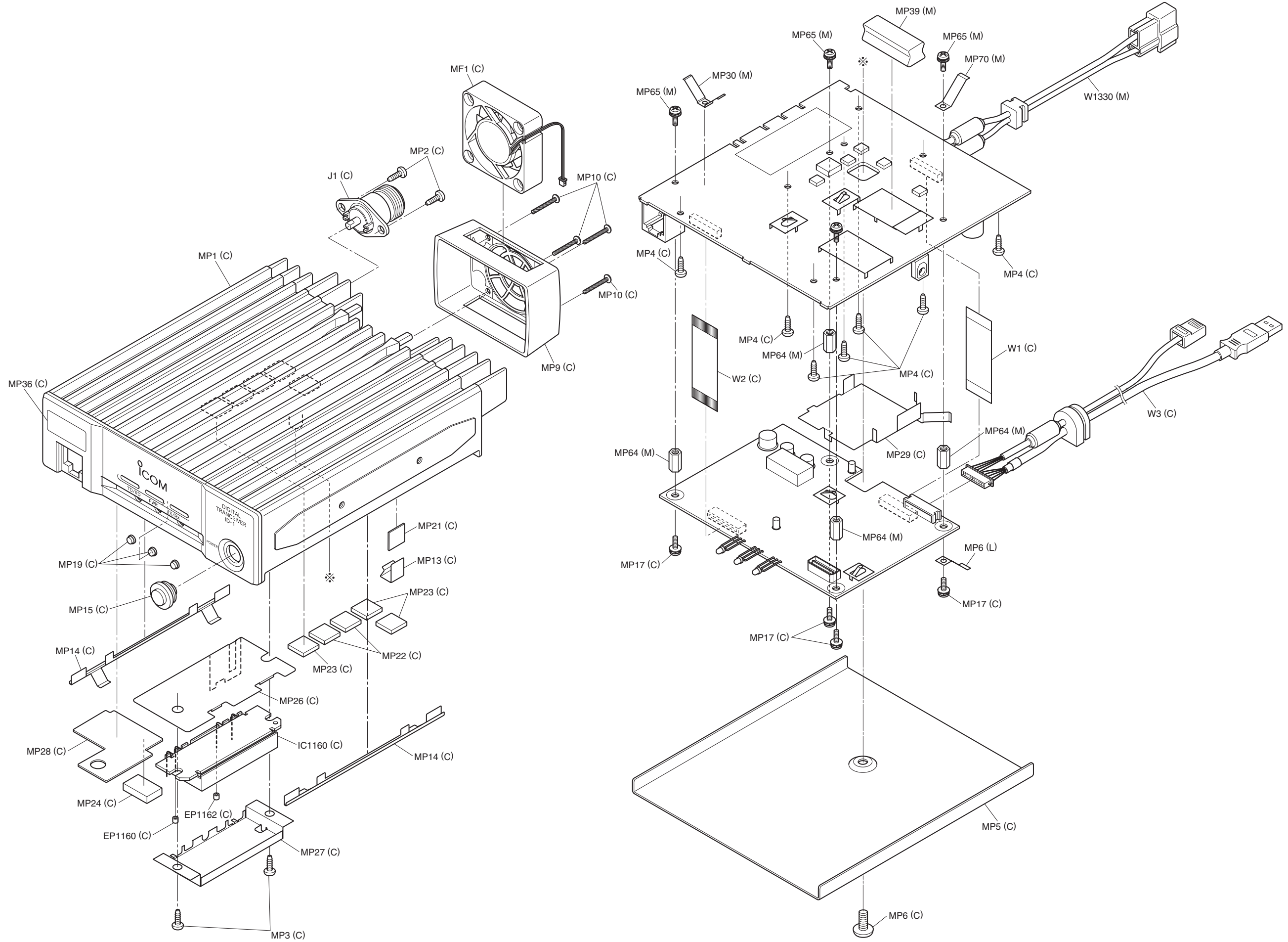

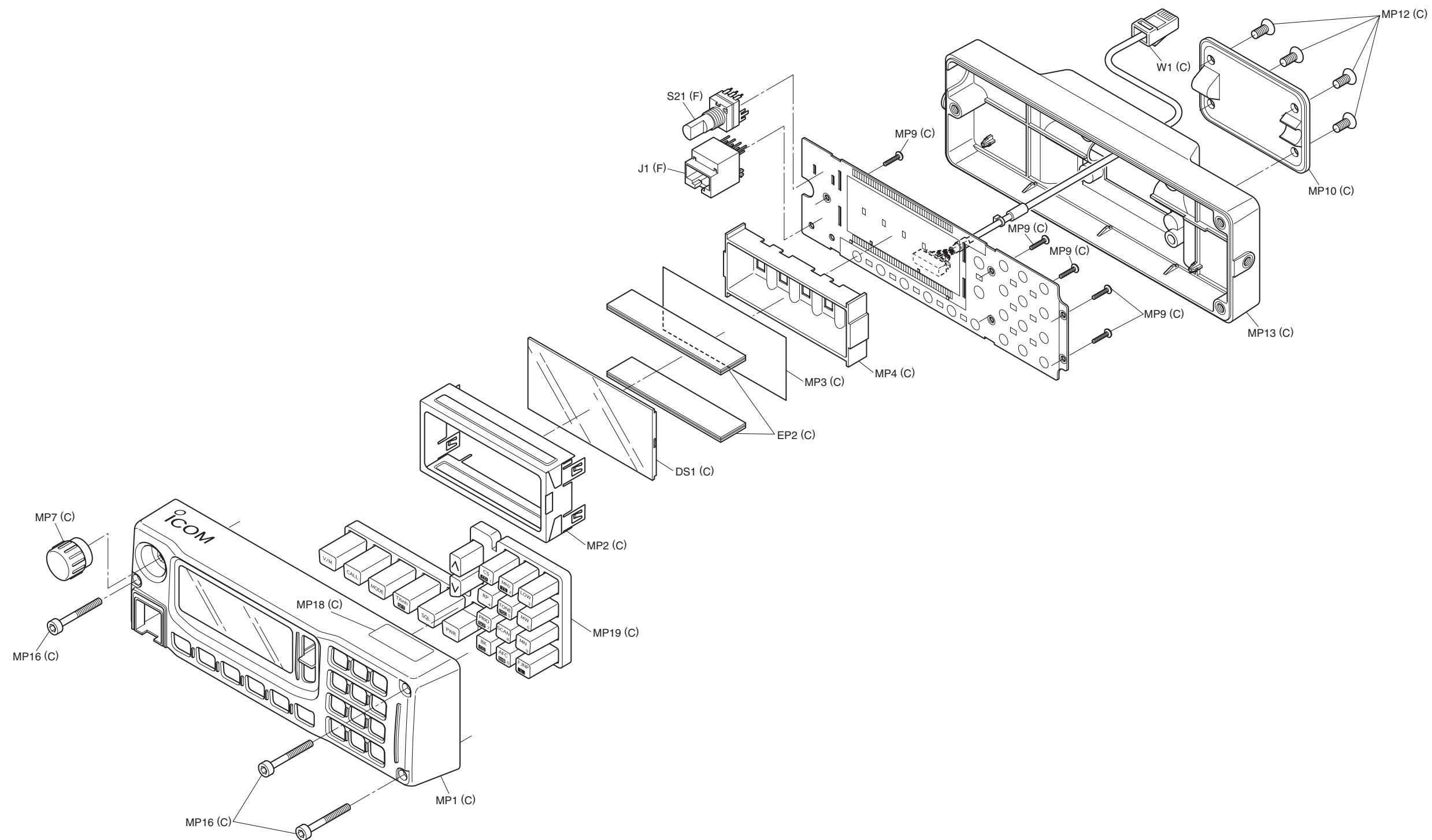

SECTION 9 BOARD LAYOUTS

9-1 MAIN UNIT

- TOP VIEW

J1800
to LOGIC-1 unit J401
30

PCON	PWR/S
GND	GND
GND	GND
GND	GND
GND	GND
GND	GND
GND	GND
GND	GND
GND	GND
GND	GND
NC	NC
HV L	+3
HV L	+3
GND	GND
GND	GND
FANG	TXS
BEEP	VCTL
AMULT	

J1602
to LOGIC-1 unit J101
16

DAF	GND
TXSW	GND
GND	GND
GND	GND
GND	GND
GND	GND
GND	GND
GND	GND
GND	GND
GND	GND
P2ST	GND
P2RS	GND
PDAT	GND
PSCK	GND
GND	GND
UNLK	1CON
SHIFT	PWRS

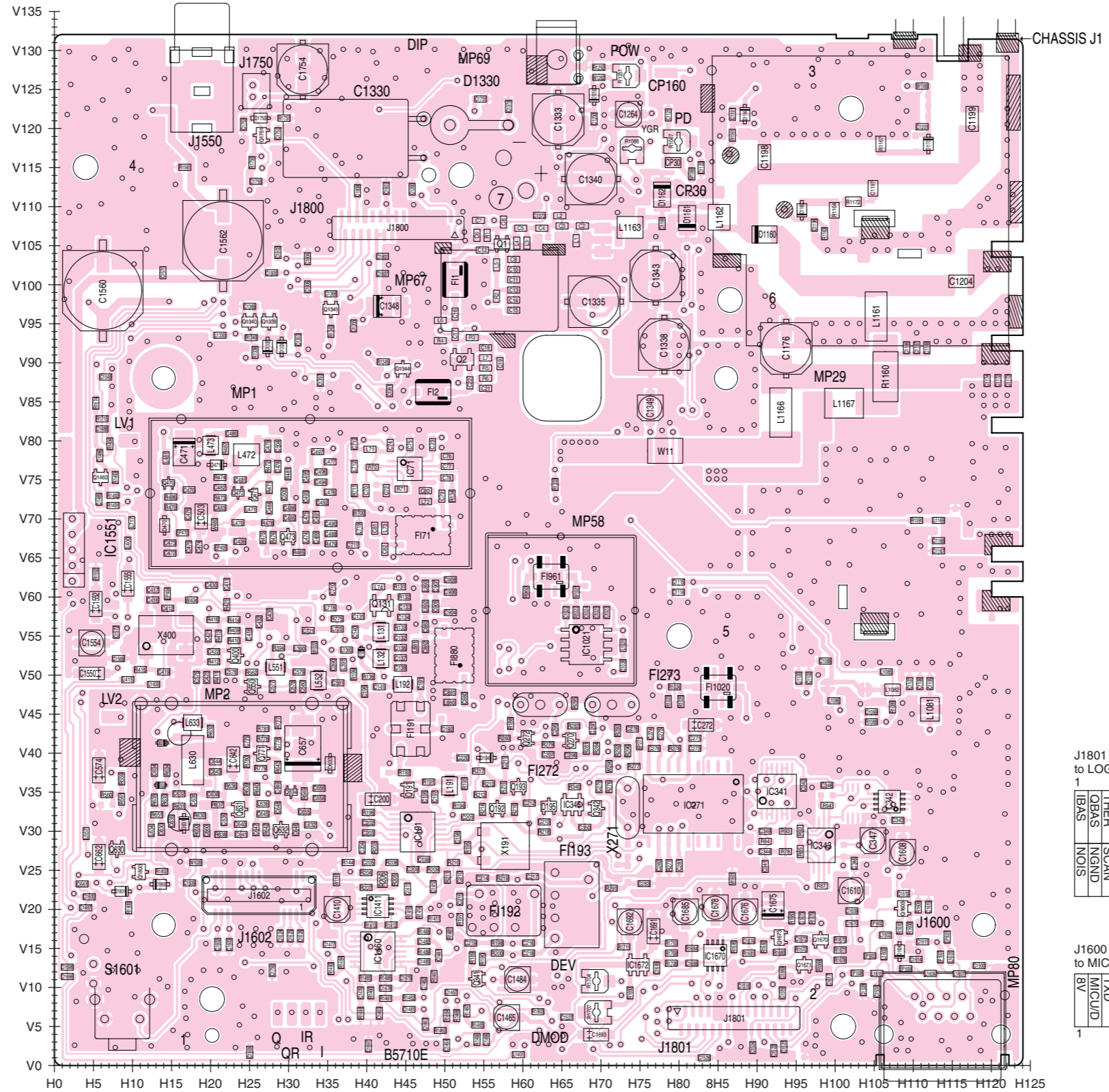

J1801
to LOGIC-1 unit J400
1

PTT	MUD
NC	NC
GENV	RXD
RSSI	TXD
+5A	CTOS
M/E	MIN
MMULT	GND
M/MULT	GND
GND	W/MS
ADSW	DAWOD
THE	R/WLT
THE	SCAN
OBAS	NGND
IBAS	NOIS

J1600
to MIC
8

RXD	
GND	
MIC	
MICE	
PTT	
TXD	
MIC/UD	
8V	

● BOTTOM VIEW

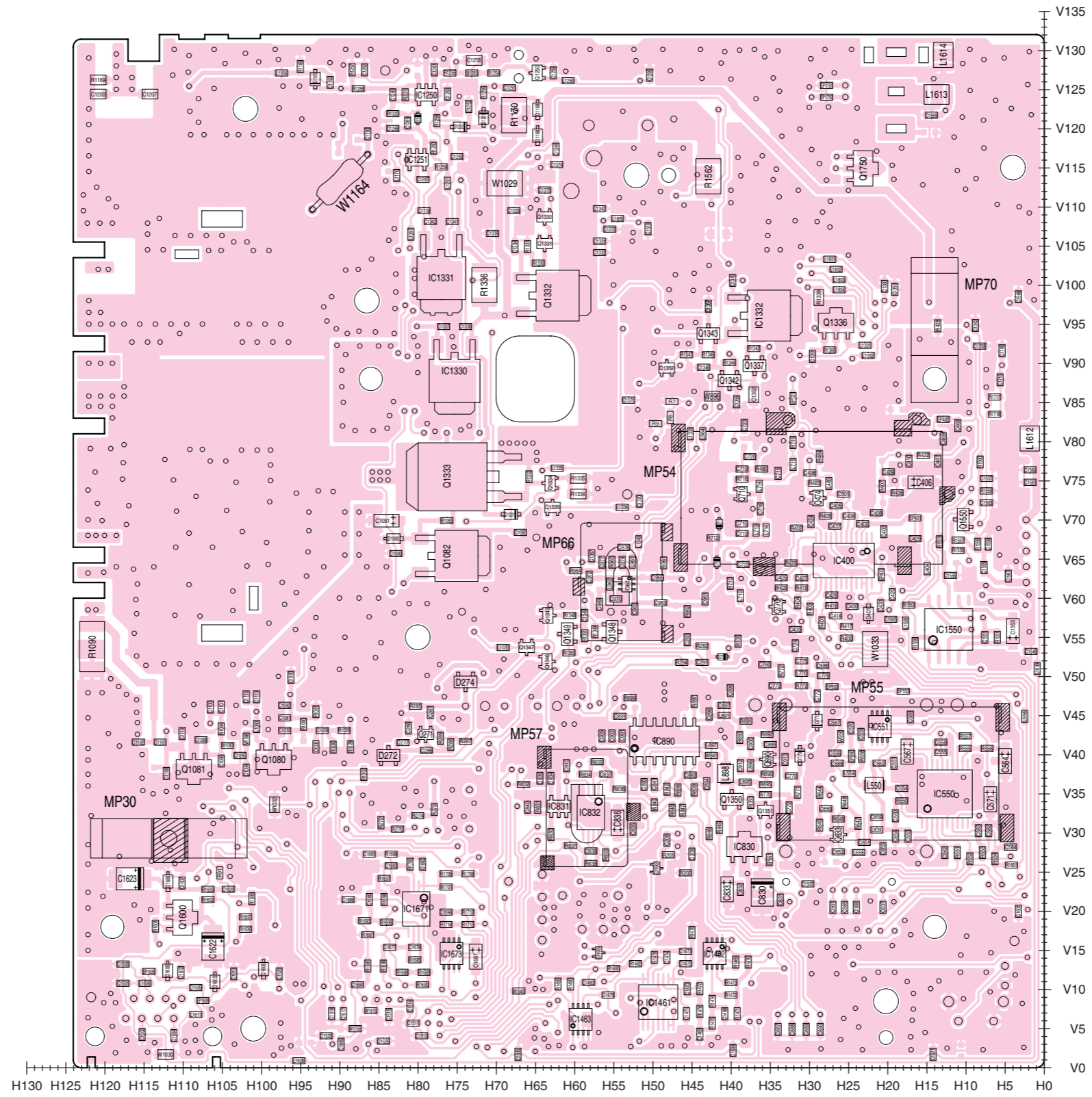

● BOTTOM VIEW

J100
to ETHERNET/USB connector

NC	10
USBGPD	
USBDP	
USBDM	
USBAV	
GND	
TD-	
RD-	
RD+	
TD+	1

10

1

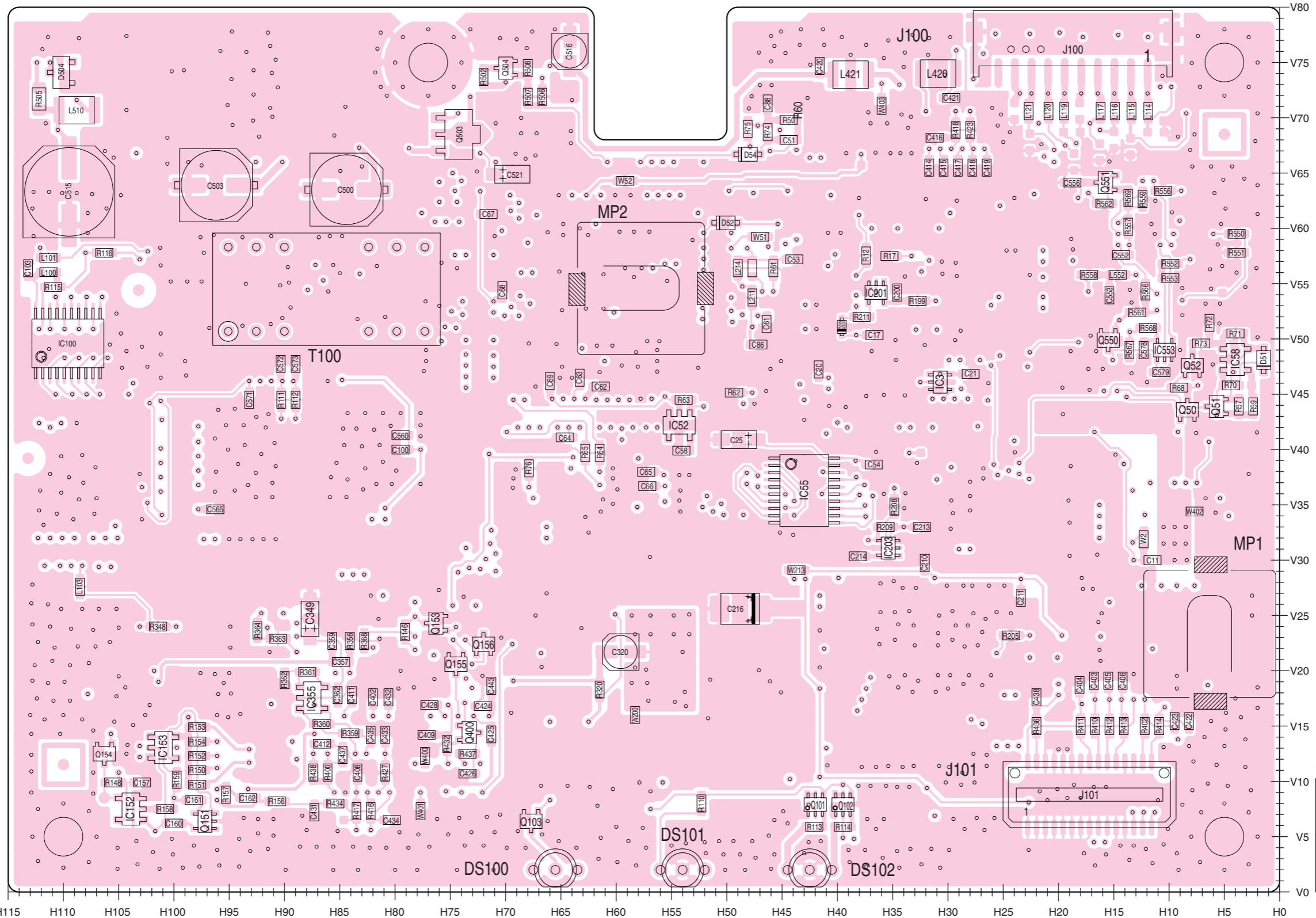

J101
to MAIN unit J1602

GND	DAF	30
GND	TXSW	
GND	GND	
GND	GND	
GND	GND	
GND	GND	
GND	P2ST	
GND	P2RS	
GND	PDAT	
GND	PCK	
GND	GND	
GND	GND	
P1ST	GND	
UNLK	GND	
POWRS	SHIFT	

1

9-3 RC-24

• TOP VIEW

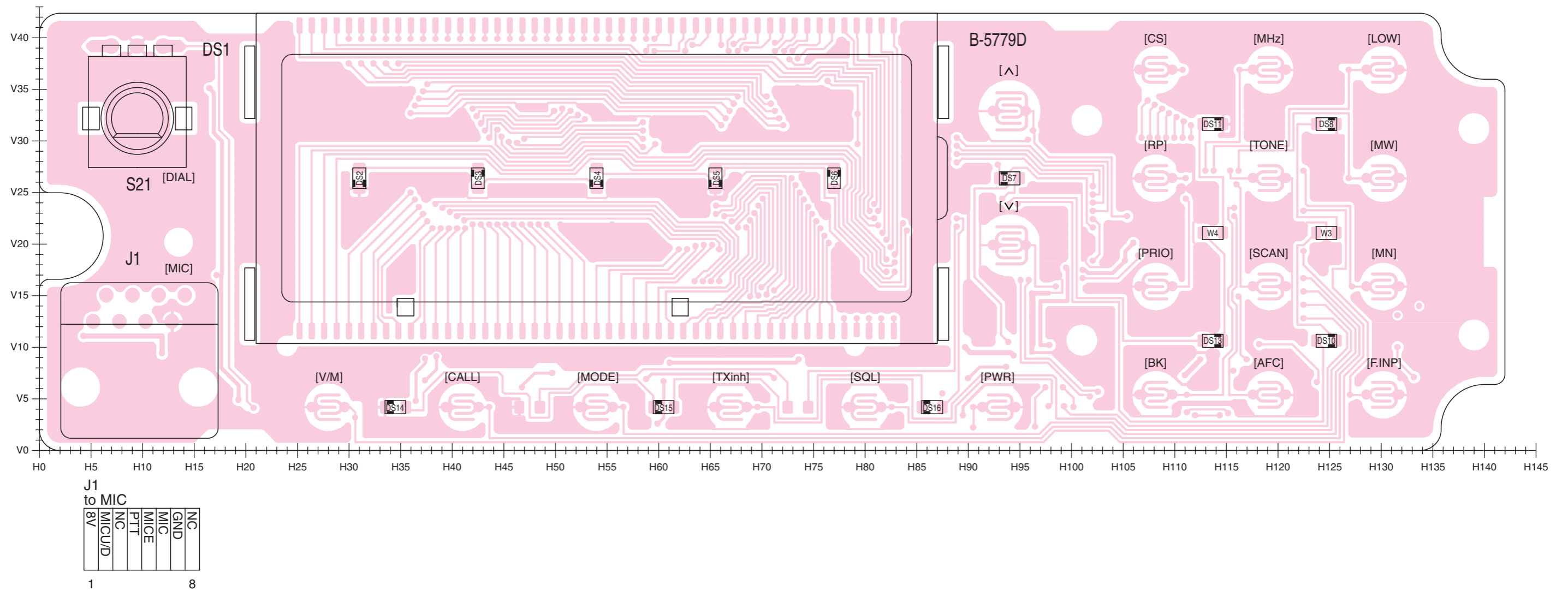

● BOTTOM VIEW

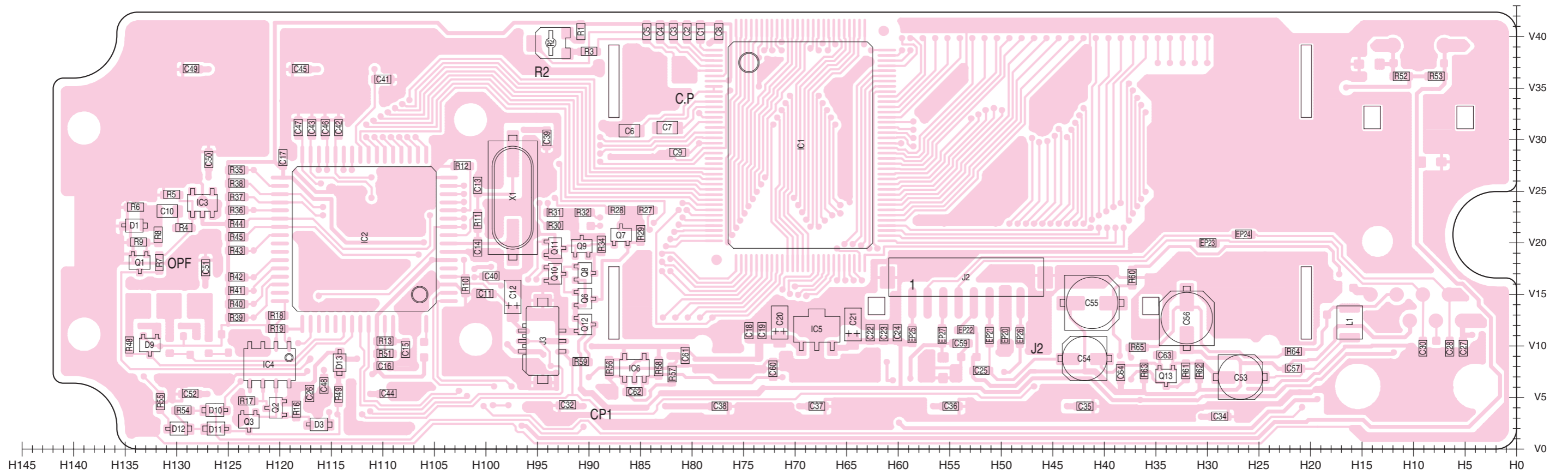

J2
to ID-1 MP80

1	RXD
	GND
	MIC
	MICE
	PTT
	TXD
	MIC/D
	8V
8	

SECTION 10 BLOCK DIAGRAM

10-1 MAIN UNIT

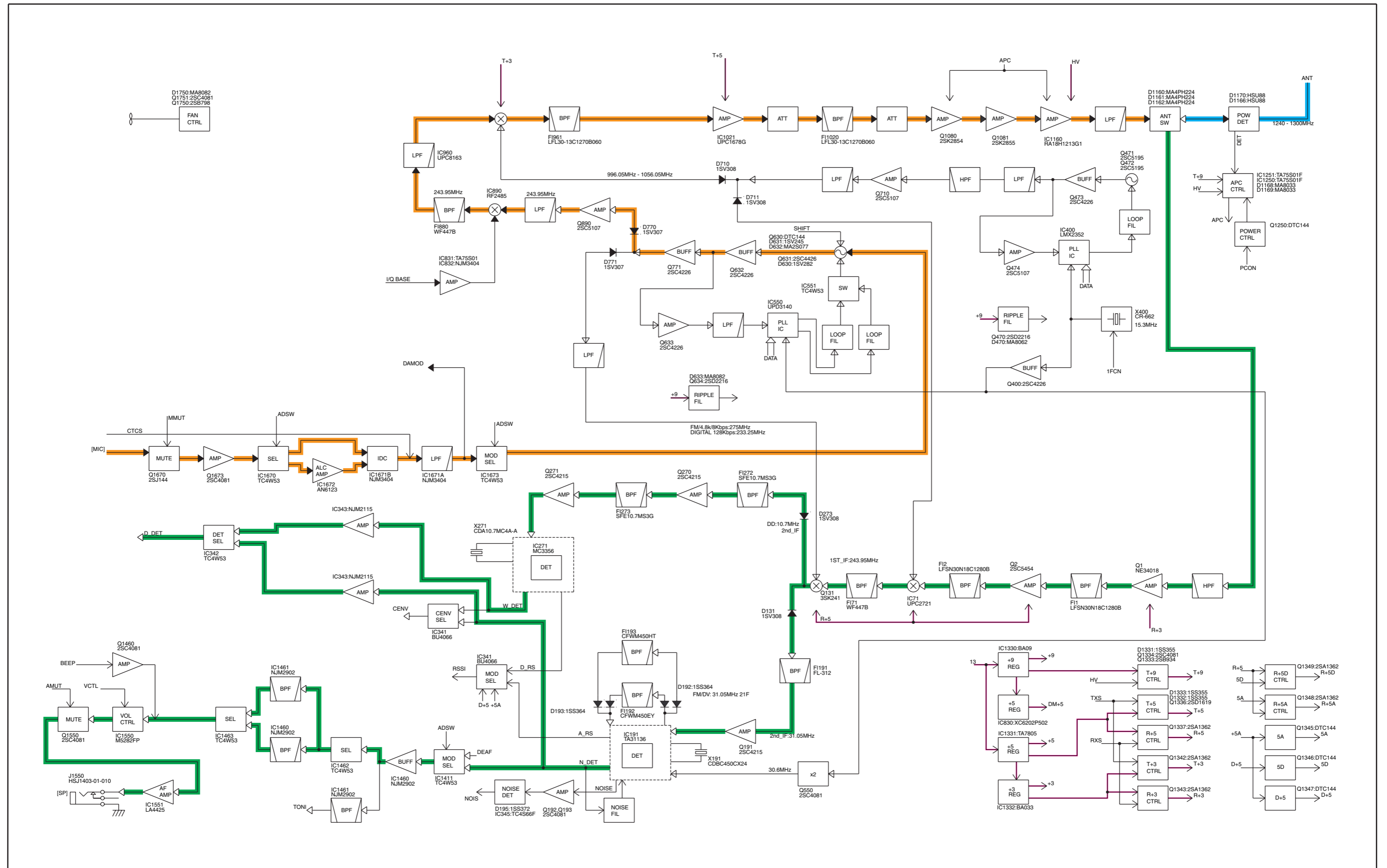

10-2 LOGIC-1 UNIT

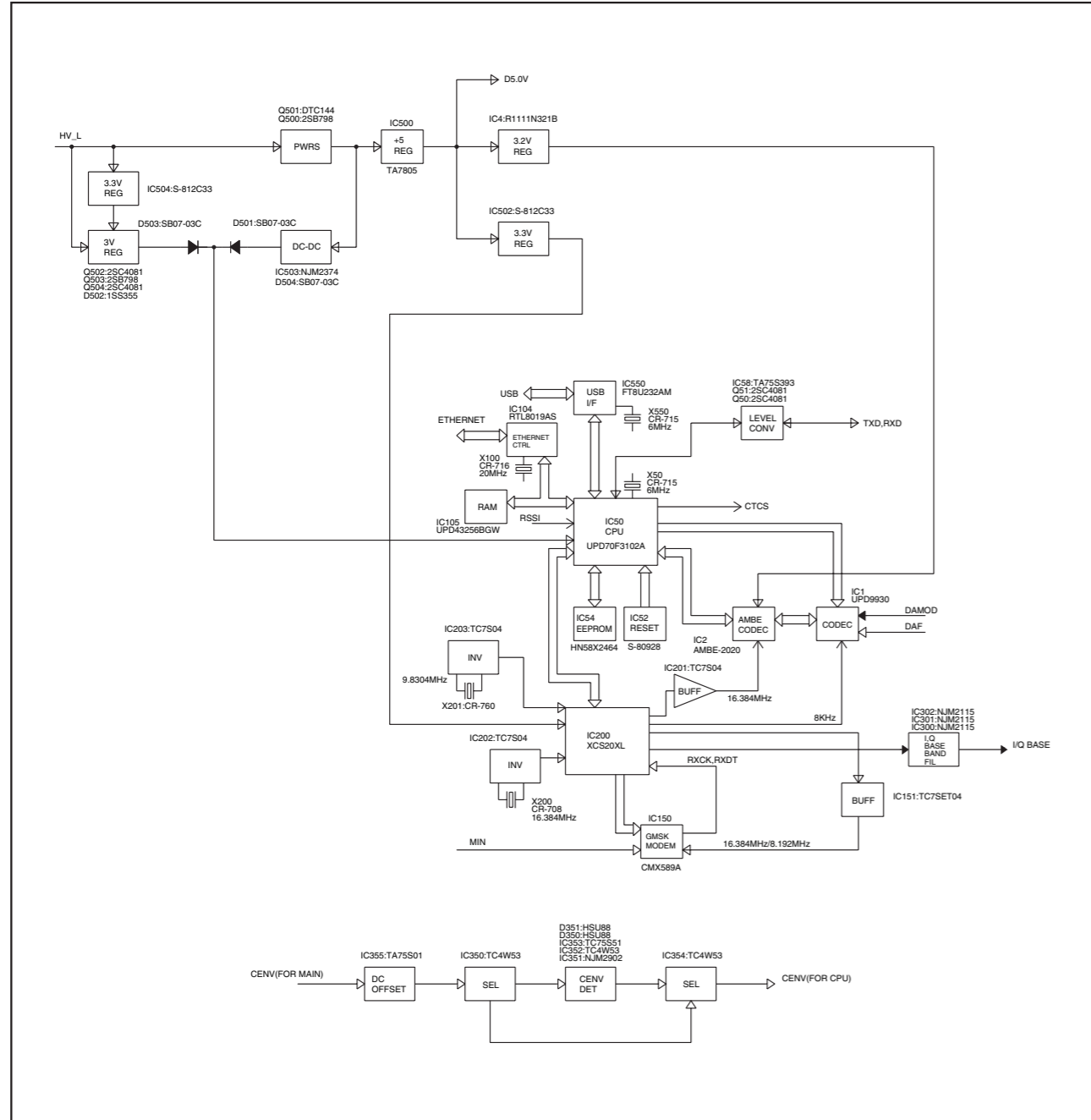

10-3 RC-24

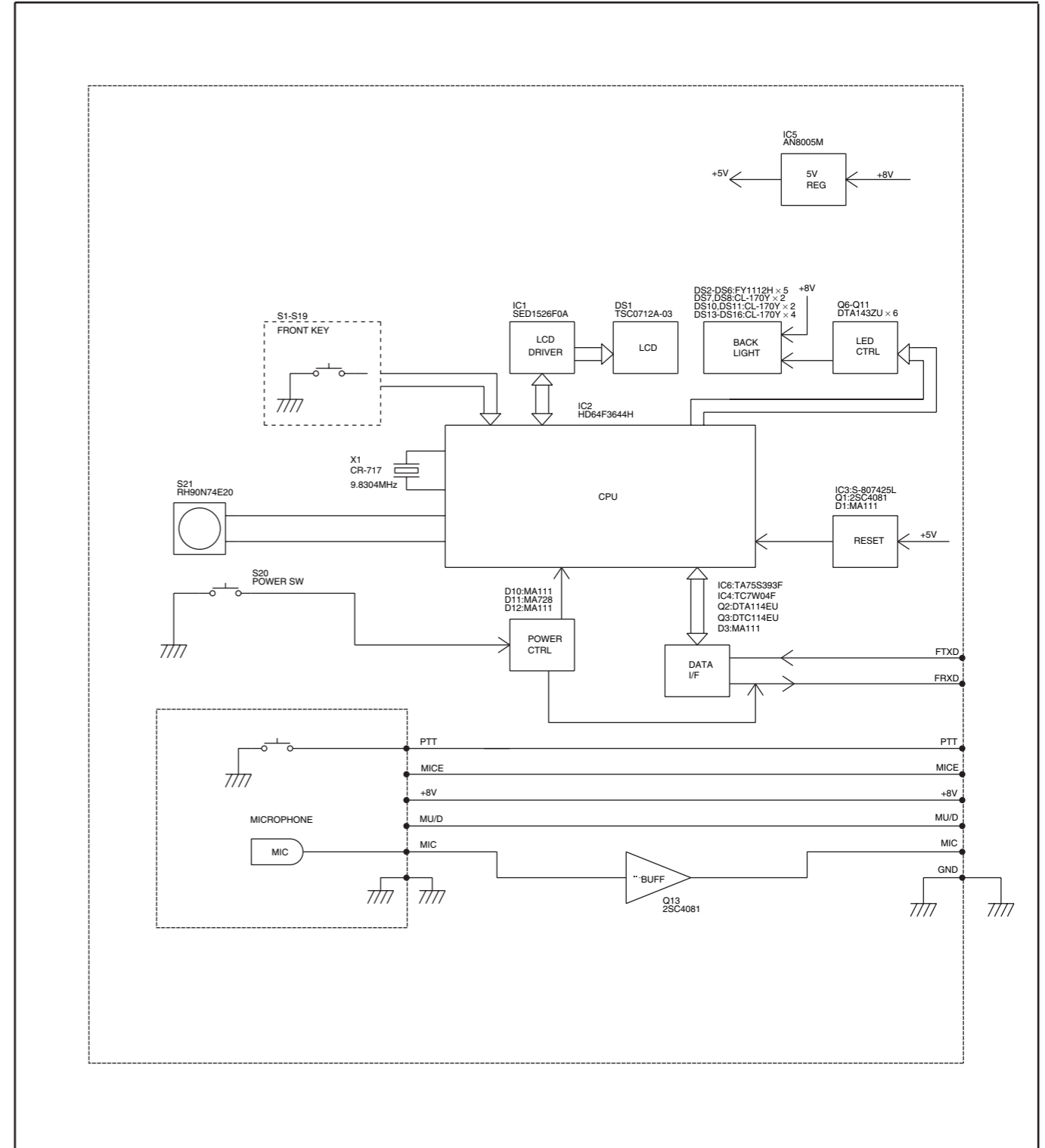

MAIN UNIT(2)

MAIN UNIT (3)

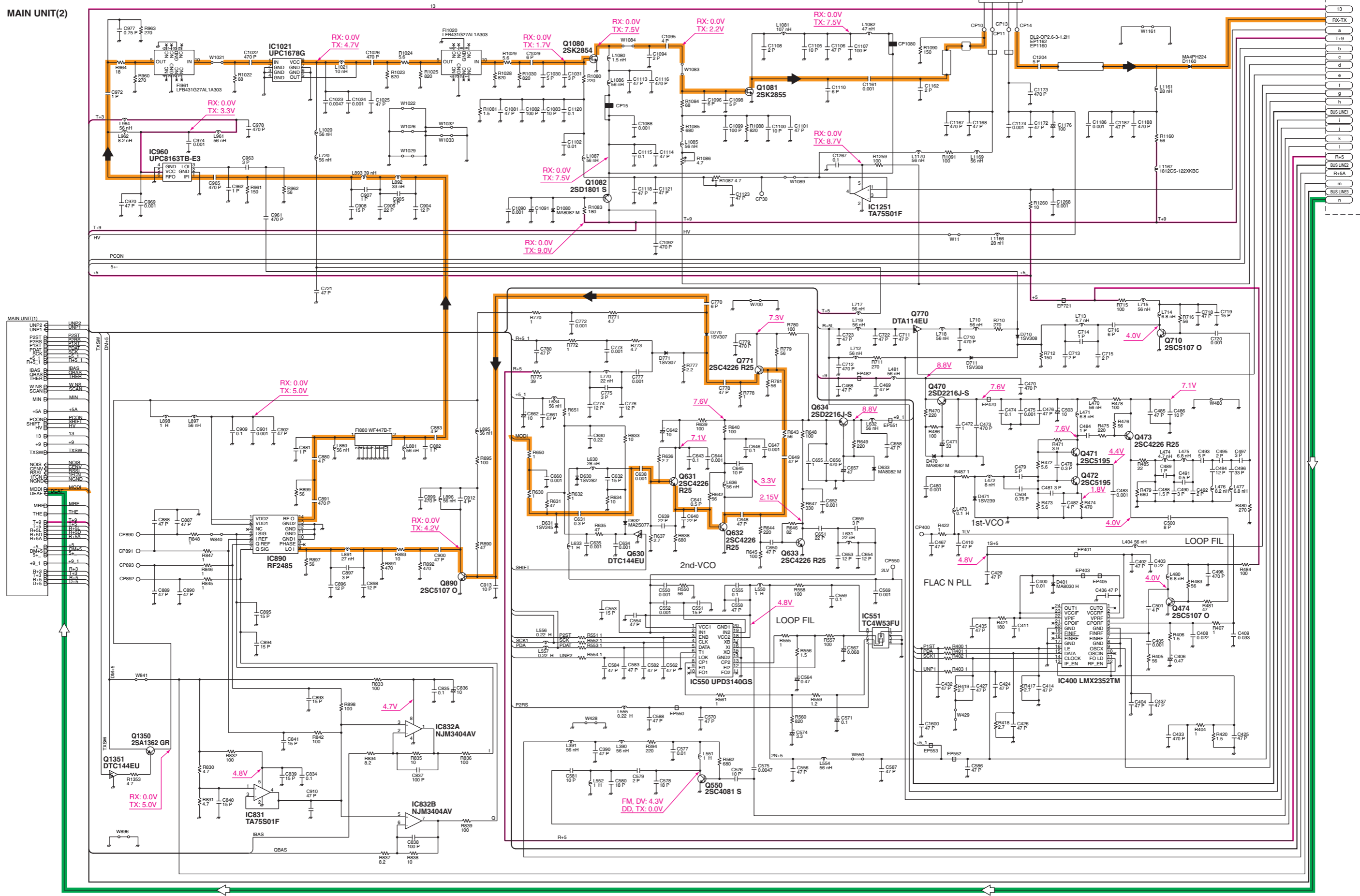

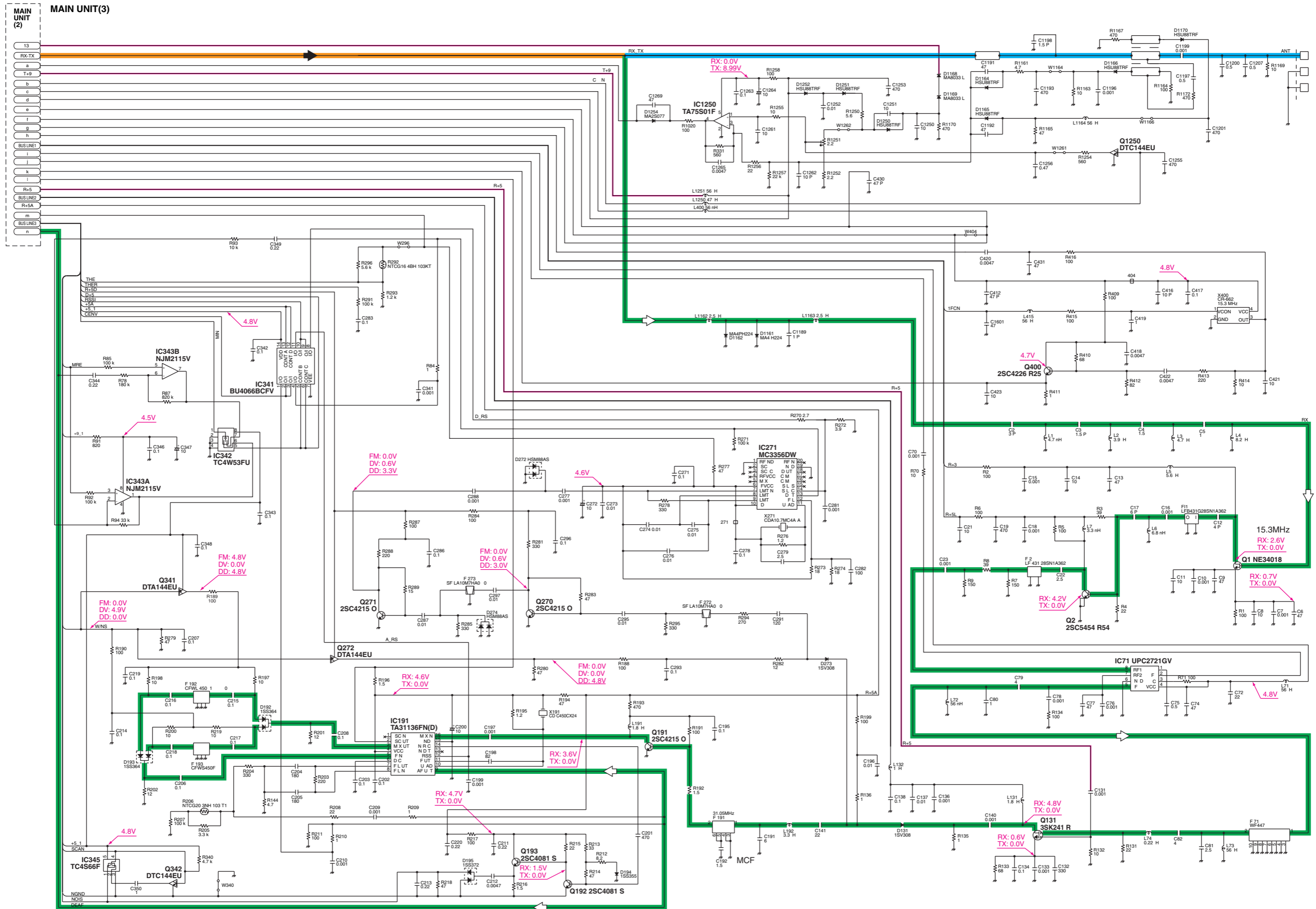

11-2 LOGIC-1 UNIT

LOGIC-1 UNIT(1)

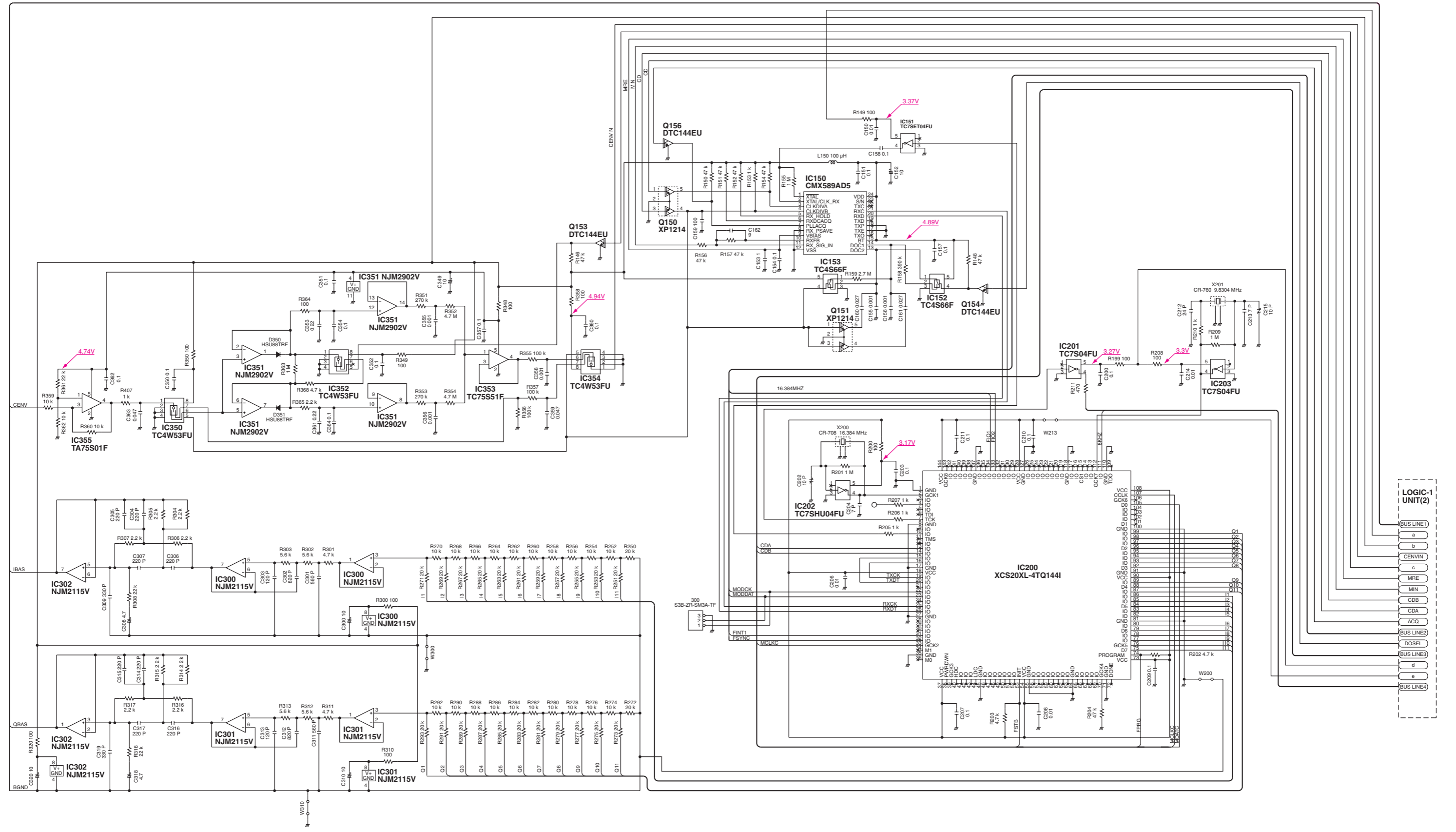

LOGIC-1 UNIT(2)

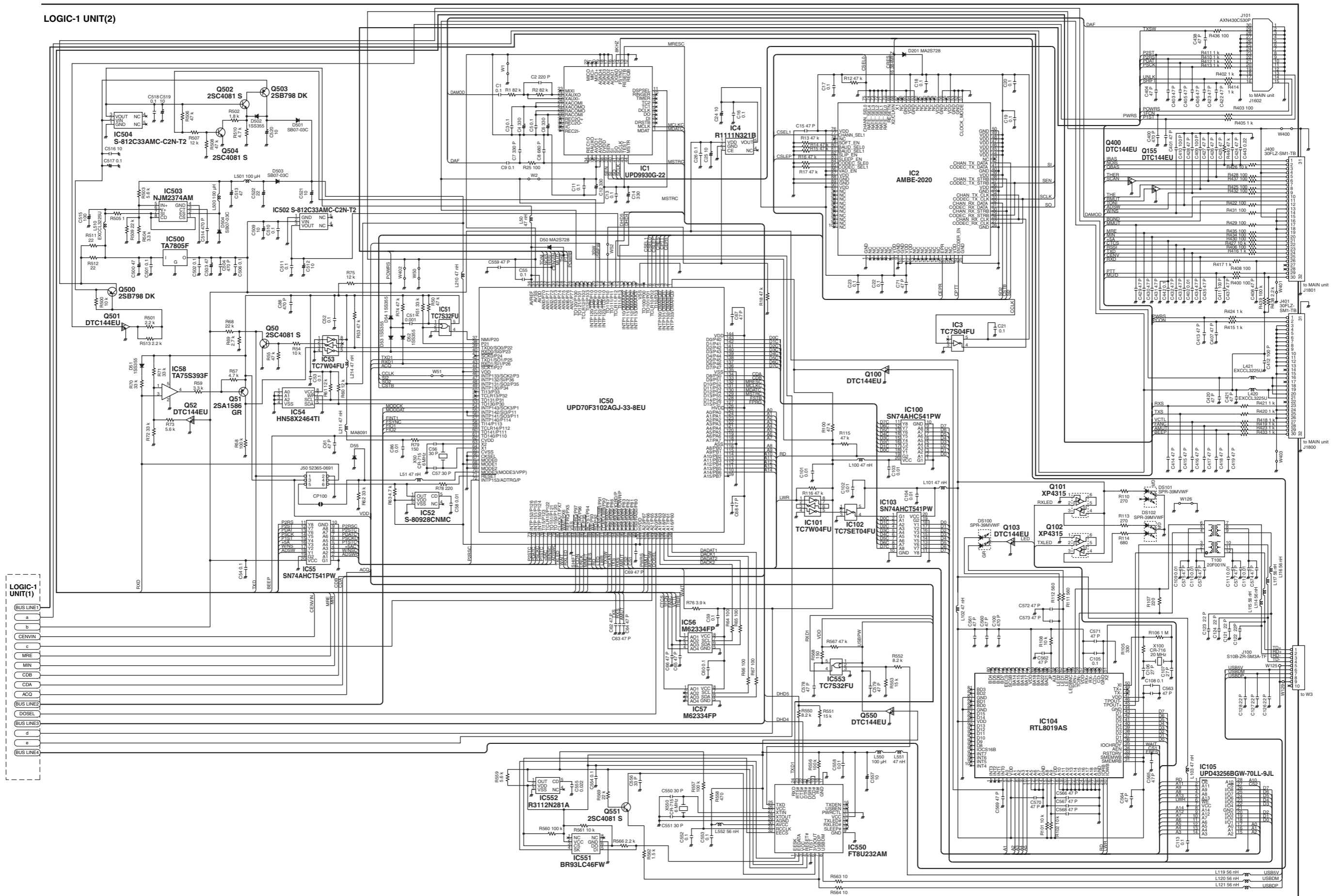

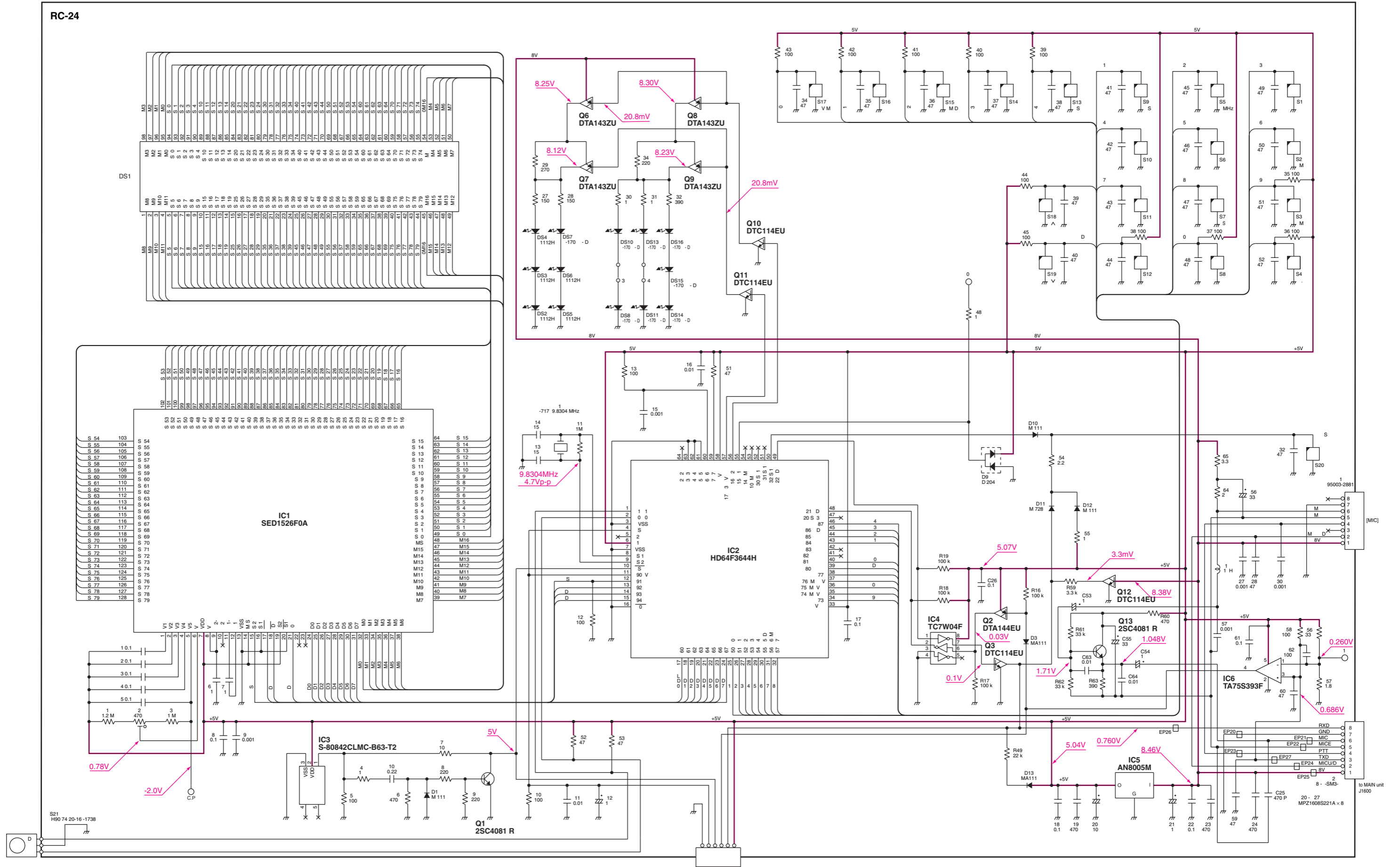

Icom Inc.

1-1-32, Kamiminami, Hirano-ku, Osaka 547-0003, Japan
Phone : +81 (06) 6793 5302
Fax : +81 (06) 6793 0013
URL : <http://www.icom.co.jp/world/index.html>

Icom America Inc.

<Corporate Headquarters>
2380 116th Avenue N.E., Bellevue, WA 98004, U.S.A.
Phone : +1 (425) 454-8155 Fax : +1 (425) 454-1509
URL : <http://www.icomamerica.com>
E-mail : sales@icomamerica.com
<Customer Service>
Phone : +1 (425) 454-7619

Icom Canada

Glenwood Centre #150-6165
Highway 17 Delta, B.C., V4K 5B8, Canada
Phone : +1 (604) 952-4266 Fax : +1 (604) 952-0090
URL : <http://www.icomcanada.com>
E-mail : info@icomcanada.com

Icom (Australia) Pty. Ltd.

Unit 1 / 103 Garden Road, Clayton VIC 3168 Australia
Phone : +61 (03) 9549-7500 Fax : +61 (03) 9549-7505
URL : <http://www.icom.net.au>
E-mail : sales@icom.net.au

Icom New Zealand

146A Harris Road, East Tamaki,
Auckland, New Zealand
Phone : +64 (09) 274 4062 Fax : +64 (09) 274 4708
URL : <http://www.icom.co.nz>
E-mail : inquiries@icom.co.nz

Beijing Icom Ltd.

10C07, Long silver Mansion, No.88, Yong Ding
Road, Haidian District, Beijing, 100039, China
Phone : +86 (010) 5889 5391/5392/5393
Fax : +86 (010) 5889 5395
E-mail : bjicom@bjicom.com
URL : <http://www.bjicom.com>

Icom (Europe) GmbH

Communication Equipment
Auf der Krautweide 24
65812 Bad Soden am Taunus, Germany
Phone : +49 (6196) 76685-0 Fax : +49 (6196) 76685-50
URL : <http://www.icomeurope.com>
E-mail : info@icomeurope.com

Icom Spain S.L

Ctra. Rubi, No. 88 Bajos A 08174, Sant Cugat del Valles, Barcelona, Spain
Phone : +34 (93) 590 26 70 Fax : +34 (93) 589 04 46
URL : <http://www.icomspain.com>
E-mail : icom@icomspain.com

Icom (UK) Ltd.

Blacksole House, The Boulevard, Altira Business Park, Herne Bay, CT6 6GZ, UK
Phone : +44 (01227) 741741 Fax : +44 (01227) 741742
URL : <http://www.icomuk.co.uk>
E-mail : info@icomuk.co.uk

Icom France s.a.s.

Zac de la Plaine
1 Rue Brindejone des Moulinais BP 5804
31505 Toulouse Cedex, France
Phone : +33 (5) 61 36 03 03 Fax : +33 (5) 61 36 03 00
URL : <http://www.icom-france.com>
E-mail : icom@icom-france.com

Asia Icom Inc.

6F No.68, Sec. 1 Cheng-Teh Road, Taipei, Taiwan, R.O.C.
Phone : +886 (02) 2559 1899 Fax : +886 (02) 2559 1874
URL : <http://www.asia-icom.com>
E-mail : sales@asia-icom.com

Icom Polska

81-850 Sopot, ul. 3 Maja 54, Poland
Phone : +48 (58) 550 7135 Fax : +48 (58) 551 0484
E-mail : icompolska@icompolska.com.pl

Count on us!

