



HF/VHF/UHF

ULTRA-COMPACT TRANSCEIVER

FT-857/-857D

Technical Supplement

©2008 VERTEX STANDARD CO., LTD. EH007M90D

VERTEX STANDARD CO., LTD.
4-8-8 Nakameguro, Meguro-Ku, Tokyo 153-8644, Japan

**VERTEX STANDARD
US Headquarters**
10900 Walker Street, Cypress, CA 90630, U.S.A.

YAESU EUROPE B.V.
P.O. Box 75525, 1118 ZN Schiphol, The Netherlands

YAESU UK LTD.
Unit 12, Sun Valley Business Park, Winnall Close
Winchester, Hampshire, SO23 0LB, U.K.

VERTEX STANDARD HK LTD.
Unit 5, 20/F., Seaview Centre, 139-141 Hoi Bun Road,
Kwun Tong, Kowloon, Hong Kong

VERTEX STANDARD (AUSTRALIA) PTY., LTD.
Normanby Business Park, Unit 14/45 Normanby Road
Notting Hill 3168, Victoria, Australia

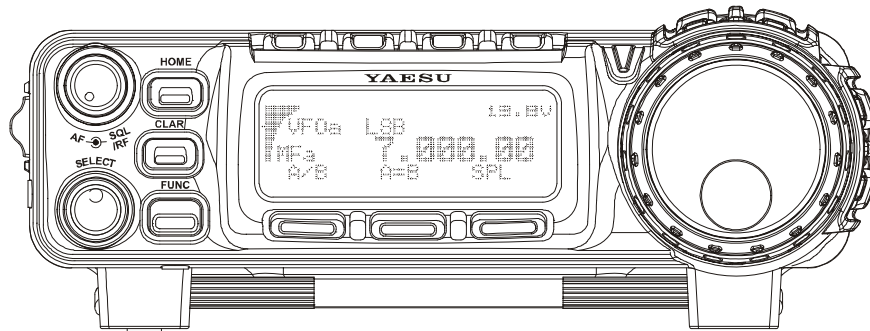

Introduction

This manual provides technical information necessary for servicing the FT-857/-857D HF/VHF/UHF Ultra-Compact Transceiver.

Servicing this equipment requires expertise in handling surface-mount chip components. Attempts by non-qualified persons to service this equipment may result in permanent damage not covered by the warranty, and may be illegal in some countries.

Two PCB layout diagrams are provided for each double-sided circuit board in the Transceiver. Each side of is referred to by the type of the majority of components installed on that side (“leaded” or “chip-only”). In most cases one side has only chip components, and the other has either a mixture of both chip and leaded components (trimmers, coils, electrolytic capacitors, ICs, etc.), or leaded components only.

While we believe the technical information in this manual to be correct, VERTEX STANDARD assumes no liability for damage that may occur as a result of typographical or other errors that may be present. Your cooperation in pointing out any inconsistencies in the technical information would be appreciated.

Contents

Specifications	2	Board Unit (Schematics, Layouts & Parts)	
Exploded View & Miscellaneous Parts	5	MAIN Unit	27
Connection Diagram	7	PLL Unit	67
Block Diagram	8	PA Unit	81
Circuit Description	11	PANEL Unit	103
Alignment	14	REF Unit	109
		PHONE-JACK Unit	110
		VR Unit	111
		CONNECTOR Unit	112
		DSP-2 Unit (FT-857 Option)	113
		TCXO-9 Unit (Option)	116

Specifications

General

Frequency Range:	Receive: 0.1-56 MHz, 76-108 MHz, 118-164 MHz, 420-470 MHz Transmit: 160 - 6 Meters, 2 Meters, 70 Centimeters (Amateur bands only)
Emission Modes:	A1 (CW), A3 (AM), A3J (LSB/USB), F3 (FM), F1 (9600 bps packet), F2 (1200 bps packet)
Synthesizer Steps (Min.):	10 Hz (CW/SSB), 100 Hz (AM/FM/WFM)
Antenna Impedance:	50 Ohms, Unbalanced
Operating Temp. Range:	14 °F to 140 °F (-10 °C to +60 °C)
Frequency Stability:	±4 ppm from 1 min. to 60 min after power on. @25 °C: 1 ppm/hour ±0.5 ppm/1 hour @25 °C, after warmup (with optional TCXO-9)
Supply Voltage:	Normal: 13.8 VDC ±15 %, Negative Ground
Current Consumption:	Squelched: 550 mA (Approx.) Receive: 1 A Transmit: 22 A
Case Size (W x H x D):	6.1" x 2.0" x 9.2" (155 x 52 x 233 mm)
Weight (Approx.):	4.6 lb. (2.1 kg)

Transmitter

RF Power Output: (@13.8 V DC)		SSB/CW/FM	AM Carrier
	160- 6 M:	100 W	25 W
	2 M:	50 W	12.5 W
	70 CM:	20 W	5 W
Modulation Types:	SSB: Balanced Modulator, AM: Early Stage (Low Level), FM: Variable Reactance		
FM Maximum Deviation:	±5 kHz (FM-N: ±2.5 kHz)		
Spurious Radiation:	-50 dB (1.8-29.7 MHz) -60 dB (50/144/430 MHz)		
Carrier Suppression:	>40 dB		
Opp. Sideband Suppression:	>50 dB		
SSB Frequency Response:	400 Hz-2600 Hz (-6 dB)		
Microphone Impedance:	200-10k Ohms (Nominal: 600 Ohms)		

Specifications

Receiver

Circuit Type:	Double-Conversion Superheterodyne (SSB/CW/AM/FM) Superheterodyne (WFM)		
Intermediate Frequencies:	1st: 68.33 MHz (SSB/CW/AM/FM); 10.7 MHz (WFM) 2nd: 455 kHz		
Sensitivity:	SSB/CW	AM	FM
100 kHz-1.8 MHz	–	32 μ V	–
1.8 MHz-28 MHz	0.2 μ V	2 μ V	–
28 MHz-30 MHz	0.2 μ V	2 μ V	0.5 μ V
50 MHz-54 MHz	0.125 μ V	1 μ V	0.2 μ V
144/430 MHz	0.125 μ V	–	0.2 μ V
	(SSB/CW/AM = 10 dB S/N, FM = 12 dB SINAD)		
Squelch Sensitivity:	SSB/CW/AM	FM	
100 kHz-1.8 MHz	–	–	
1.8 MHz-28 MHz	2.5 μ V	–	
28 MHz-30 MHz	2.5 μ V	0.32 μ V	
50 MHz-54 MHz	1 μ V	0.16 μ V	
144/430 MHz	0.5 μ V	0.16 μ V	
Image Rejection:	HF/50 MHz: 70 dB, 144/430 MHz: 60 dB		
IF Rejection:	60 dB		
Selectivity (–6/–60 dB):	SSB/CW: 2.2 kHz/4.5 kHz AM: 6 kHz/20 kHz FM: 15 kHz/30 kHz FM-N: 9 kHz/25 kHz SSB (optional YF-122S installed): 2.3 kHz/4.7 kHz (–66 dB) CW (option YF-122C installed): 500 Hz/2.0 kHz CW (option YF-122CN installed): 300 Hz/1.0 kHz		
AF Output:	2.5 W (@4 Ohms, 10% THD or less)		
AF Output Impedance:	4-16 Ohms		

Specifications are subject to change without notice, and are guaranteed within the amateur bands only.

Note

Exploded View & Miscellaneous Parts

Non-designated parts are available only as part of a designated assembly.

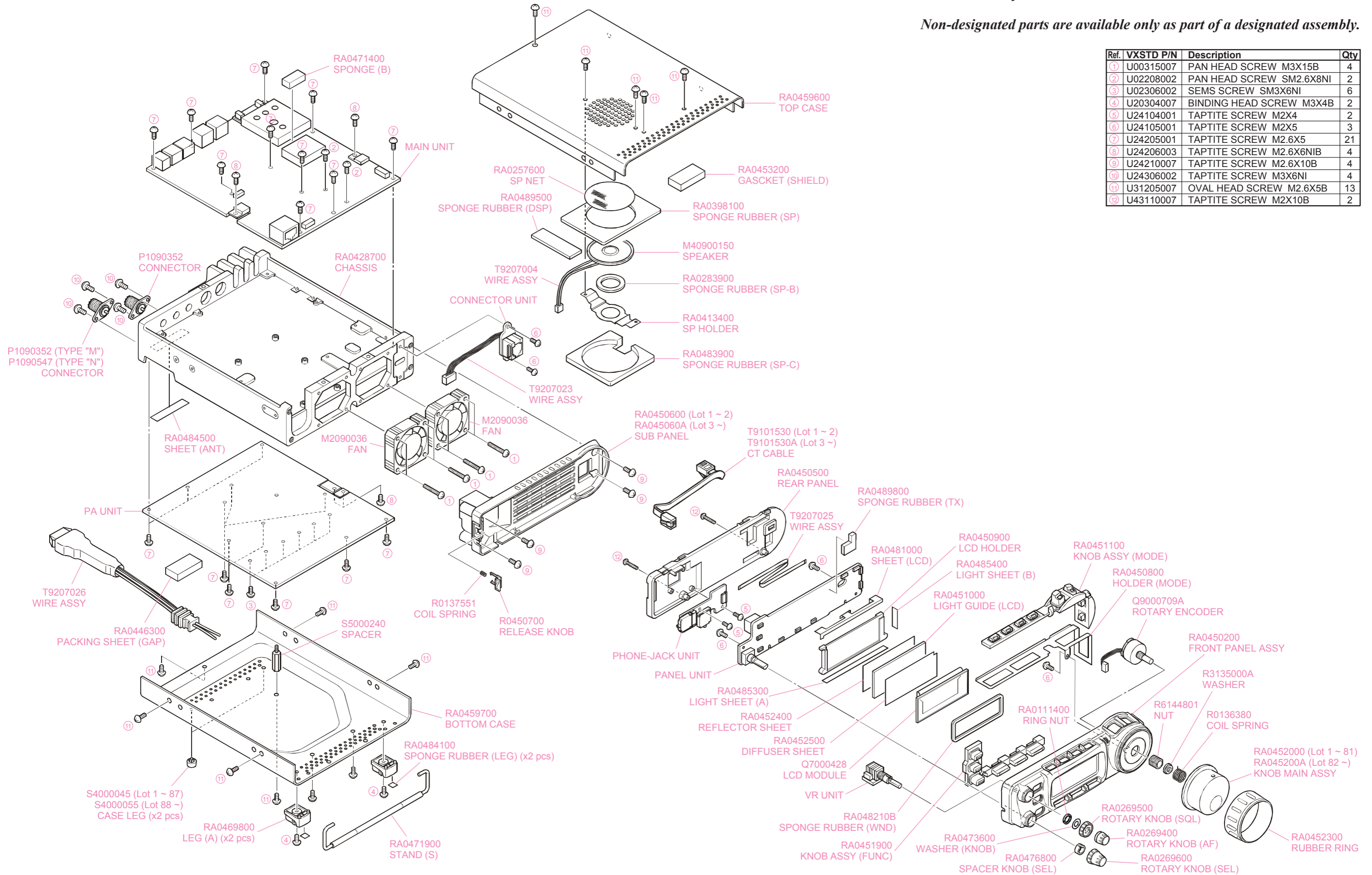

Ref.	VXSTD P/N	Description	Qty
①	U00315007	PAN HEAD SCREW M3X15B	4
②	U02208002	PAN HEAD SCREW SM2.6X8NI	2
③	U02306002	SEMS SCREW SM3X6NI	6
④	U20304007	BINDING HEAD SCREW M3X4B	2
⑤	U24104001	TAPTITE SCREW M2X4	2
⑥	U24105001	TAPTITE SCREW M2X5	3
⑦	U24205001	TAPTITE SCREW M2.6X5	21
⑧	U24206003	TAPTITE SCREW M2.6X6NIB	4
⑨	U24210007	TAPTITE SCREW M2.6X10B	4
⑩	U24306002	TAPTITE SCREW M3X6NI	4
⑪	U31205007	OVAL HEAD SCREW M2.6X5B	13
⑫	U43110007	TAPTITE SCREW M2X10B	2

Note

Connection Diagram

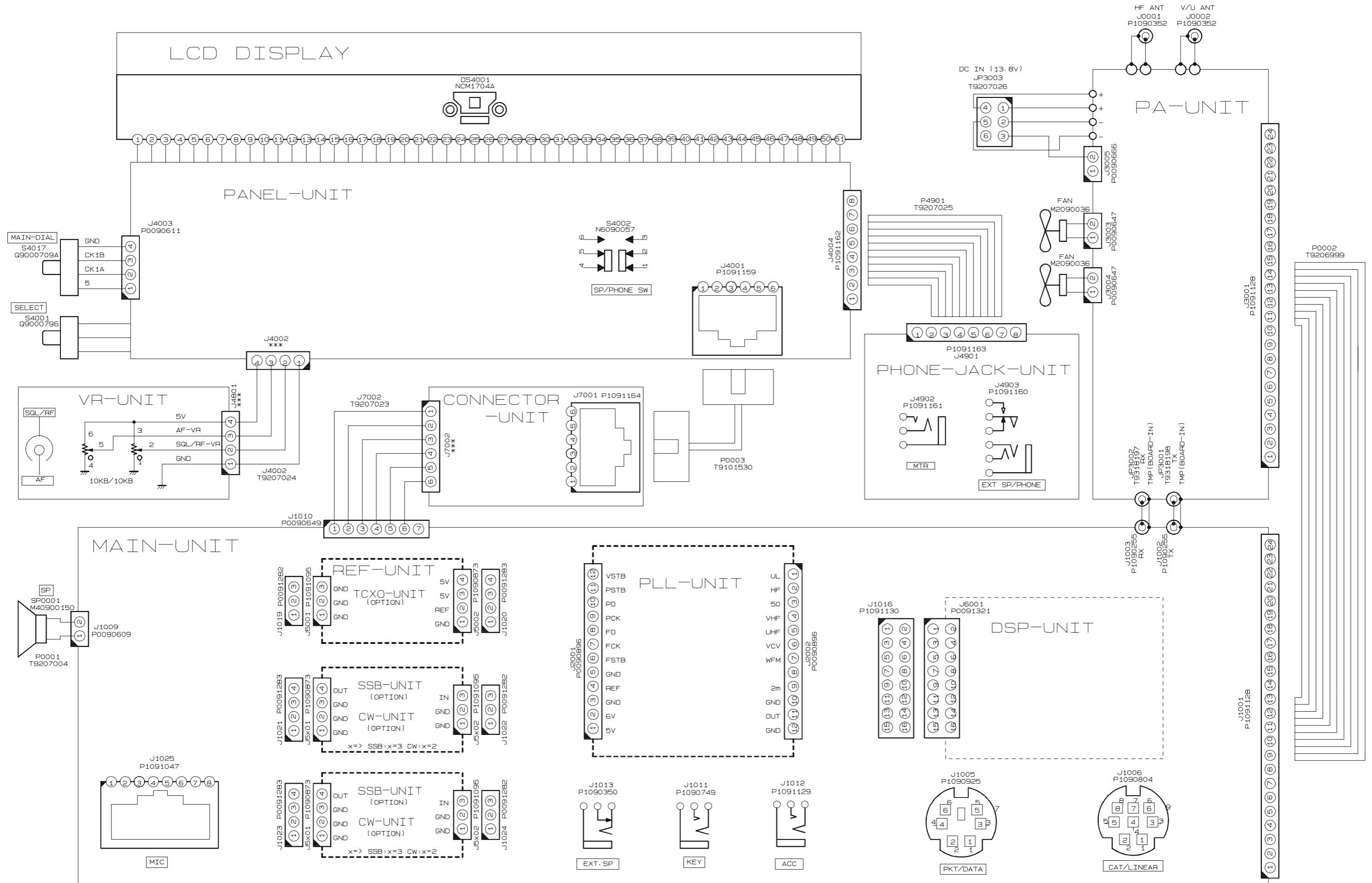

Block Diagram (Lot 1 ~ 17)

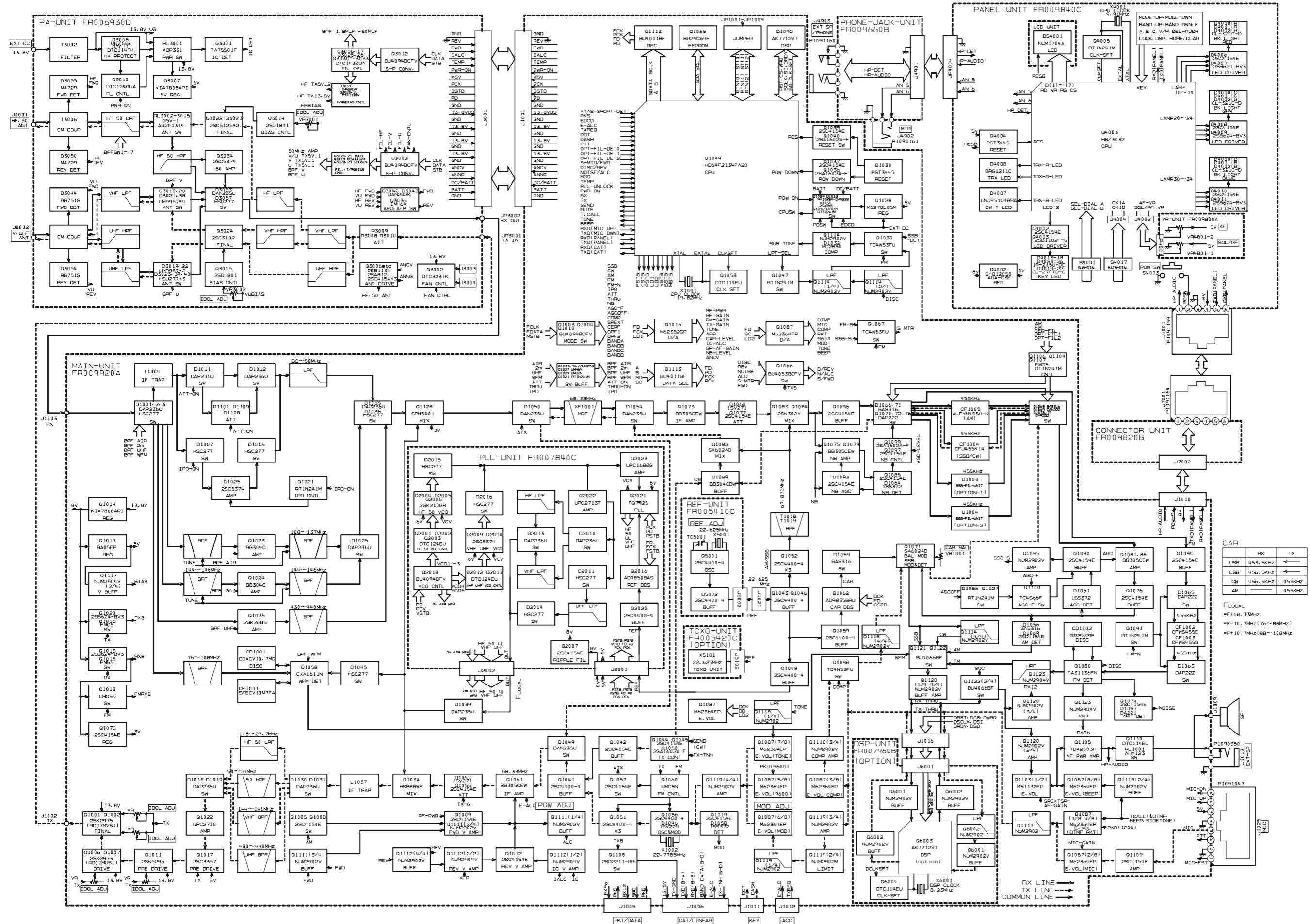

Block Diagram (Lot 18 ~ 59)

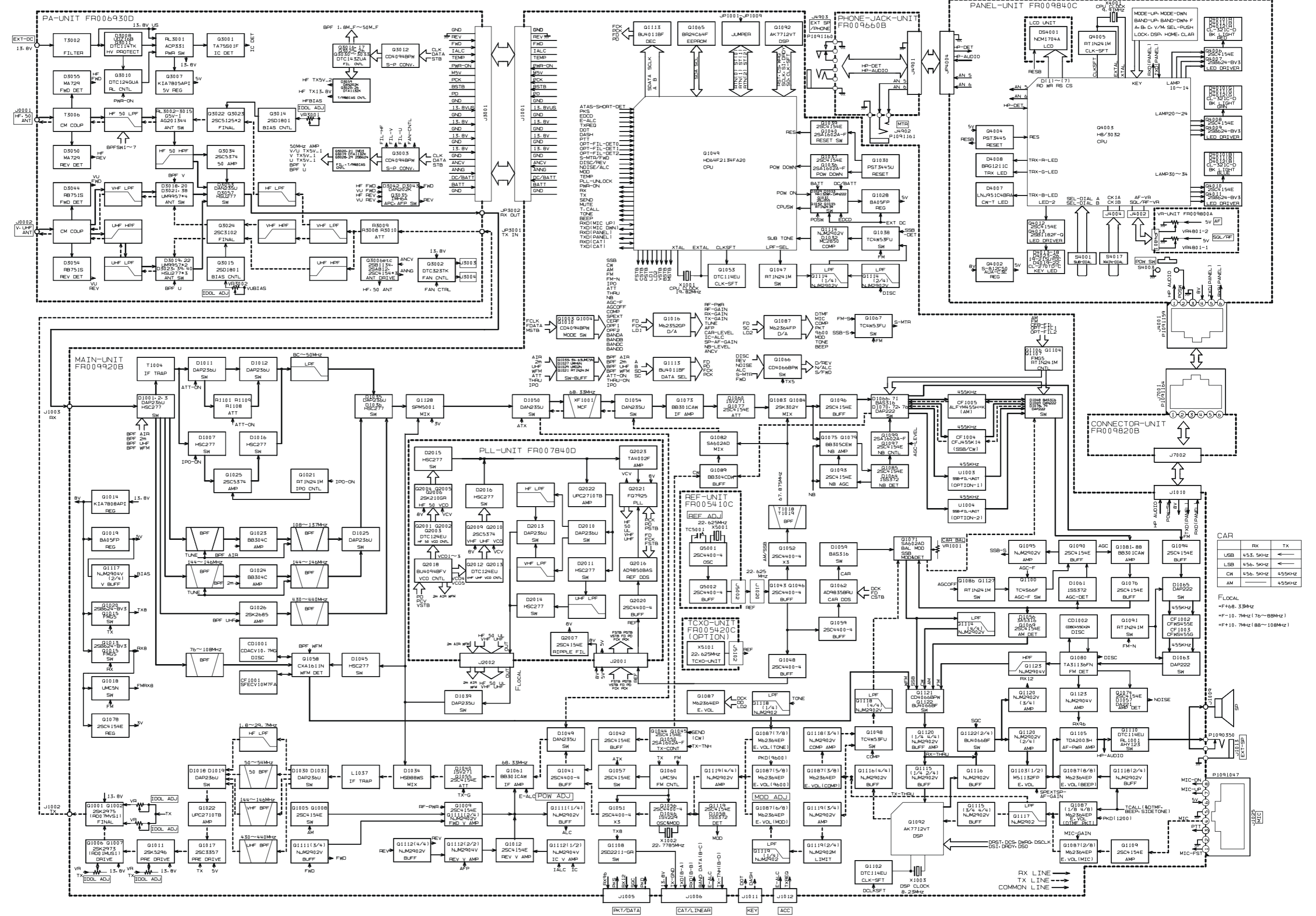

Block Diagram (Lot 60 ~)

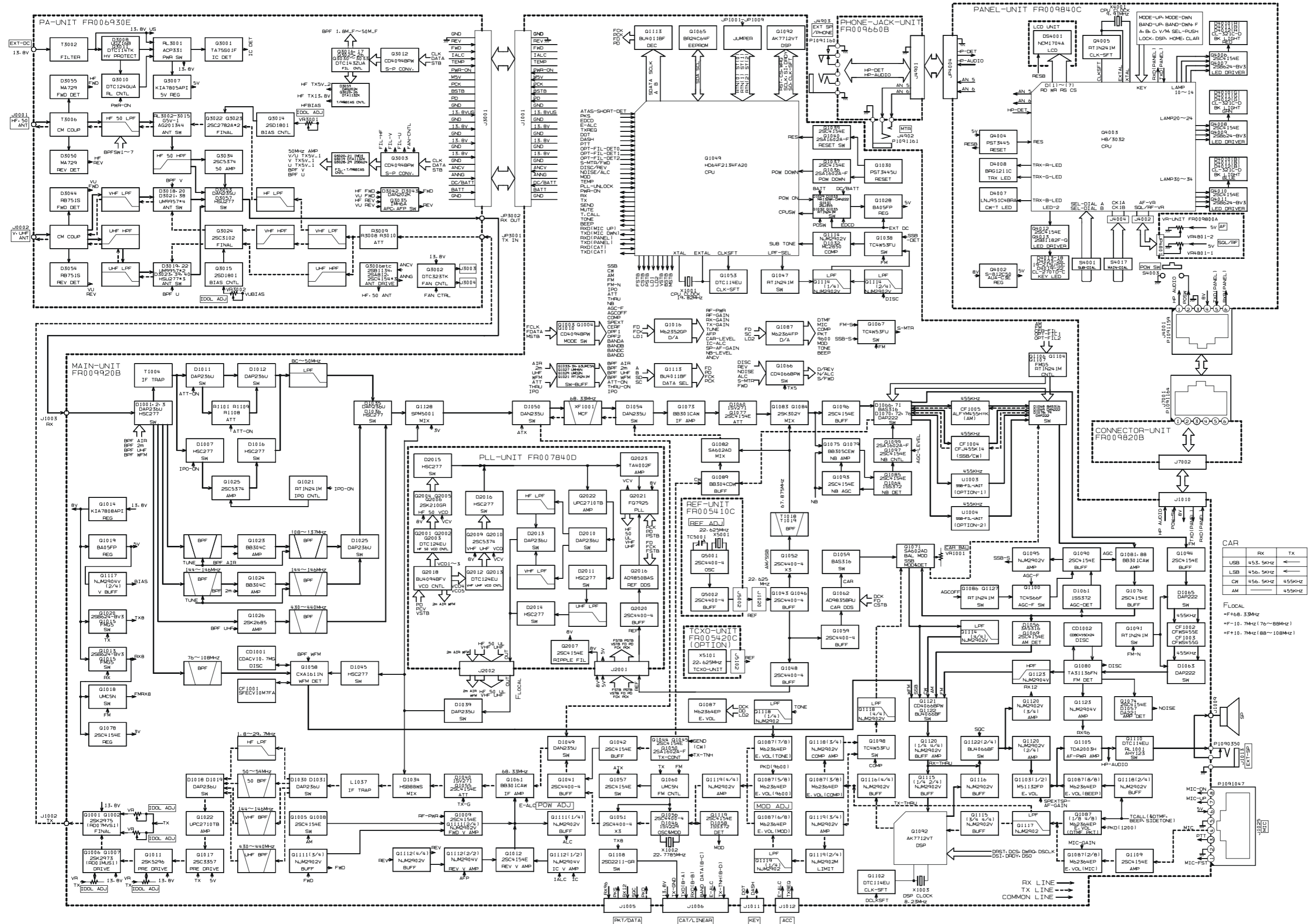

Receive Signal Circuitry

RF Stages

Signals between 0.1 and 56 MHz received at the antenna terminal pass through a low-pass filter, selected according to the receiving frequency, then pass to another low-pass filter, to remove unwanted out-of-band signals. The filtered receiving signal passes, through one of the following circuits, to the 1st Mixer **Q1128** (SPM5001): (1) an attenuator network (−10dB) which consists of resistors R1101, R1108, R1109; (2) a “through” circuit enabled via diodes **D1011** and **D1012** (both **DAP236U**); or (3) RF amplifier **Q1025** (**2SC5374**).

Received 430 MHz signals, after passing through a high-pass filter composed of L3058, L3069, C3250, C3251, C3253, C3258, and C3298, are passed through low-pass filter composed of L3043, L3044, C3209, C3211, C3214, C3215, C3246, and C3255, and through a directional coupler, to the UHF T/R switch circuit composed of diode switch **D3019/D3022** (both **UM9957F**), **D3023**, and **D3039** (both **HSU277**). Then the signals are fed to the 1st Mixer **Q1128** via the RF-AMP **Q1026** (**2SK2685**).

Received 145 MHz signals, after passing through a high-pass filter composed of L3055, L3056, L3067, C3248, C3249, C3252, and C3254, are passed through a low-pass filter composed of L3040, L3041, C3204, C3205, C3210, C3213, and C3216, and a directional coupler, to the VHF T/R switch circuit, composed of diode switch **D3018/D3021** (both **UM9957F**). Then the signals are fed to 1st Mixer **Q1128** via the RF-AMP, **Q1024** (**BB304CDW**).

Received 76-108 MHz signals, after passing through a high-pass filter composed of L3055, L3056, L3067, C3248, C3249, C3252, and C3254, are passed through low-pass filter composed of L3040, L3041, C3204, C3205, C3210, C3213, and C3216, and a directional coupler, to the T/R switch circuit, composed of diode switch **D3018/D3021** (both **UM9957F**). Then it is fed to the Wide-FM IF IC **Q1058** (**CXA1611N**) on the MAIN Unit.

1st Mixer Circuit/1st IF Circuit

The 1st mixer on the MAIN Unit consists of quad MOS FET **Q1128** (**SPN5001**), where the receiving signal is mixed with the 1st local signal (68.430-538.330 MHz) from the PLL Unit. The resulting output signal (68.33 MHz) passes through monolithic crystal filter (MCF) **XF1001** (**MF68Q**, BW: ±6.0 kHz) to obtain the 1st IF signal with a center frequency of 68.33 MHz. The IF signal passes through the 1st IF amplifier **Q1073** (**BB305CEW**) to the 2nd Mixer, **Q1083** and **Q1084** (both **2SK302Y**).

2nd Mixer Circuit/2nd IF Circuit

The 2nd Mixer consists of FETs **Q1083** and **Q1084** (both **2SK302Y**) on the MAIN Unit, where the 1st IF signal is mixed with the 2nd local signal (67.875 MHz). The resulting output signal (455 kHz) is applied to the 2nd IF

filter which is matched to the receiving mode: either CF1004, CF1005 or an optional mechanical filter.

Noise Blanker Circuit

A portion of the 2nd IF signal is amplified by Noise Blanker Amplifiers **Q1075** and **Q1079** (both **BB305CEW**) on the MAIN Unit, and then rectified by **D1064** (**1SS372**). This output is applied to the Noise Blanker Controllers, **Q1093** (**2SC4154E**) and **Q1099** (**2SA1602A**), which yield Blanking signal according to the timing of the incoming noise pulses. Then Blanking signal controls the Noise Blanker Gate **D1066** (**BAS316**), to slice out the impulse noise from the signal.

AGC Circuit

The AGC circuit consists of **D1061** (**1SS372**), transistor **Q1090** (**2SC4154E**), and associated parts on the MAIN Unit. Output from the AGC circuit is fed back to the IF AGC circuit that controls the gain of the IF amplifier FETs.

FM IF Circuit/FM Demodulator Circuit

On FM, the 2nd IF signal passes through the buffer amplifier **Q1094** (**2SC4154E**) and 2nd IF filters (**CF1002** and **CF1003**) to the FM IF IC **Q1080** (**TA31135FN**) which contains a mixer, limiter amplifier, filter amplifier, squelch trigger, and demodulator. The demodulated audio signal at **Q1080** passes through a low-pass filter (R1339 and C1282) and a de-emphasis circuit (R1303 and C1345), then proceeds to the Audio Amplifier Circuit.

The squelch circuit selectively amplifies the noise component of the demodulator output using the filter amplifier inside the FM IF IC and an active band-pass filter consisting of an externally attached resistor and capacitor. Signal detection is performed by **D1057** (**DA221**).

SSB/CW Demodulator Circuit

The 2nd IF SSB/CW signal passes through buffer amplifiers **Q1088** and **Q1081** (both **BB305CEW**) to the SSB balanced demodulator **Q1071** (**SA602AD**) which produces audio by applying the carrier signal from the CAR-DDS IC **Q1062** (**AD9835BRU**). The demodulated audio signal is stripped of high-frequency components by an active low-pass filter, op-amp IC **Q1120** (**NJM2902V**), then is applied to the Audio Amplifier Circuit.

AM Demodulator Circuit

The 2nd IF AM signal passes through buffer amplifiers **Q1088** and **Q1081** (both **BB305CEW**) to the AM demodulator **D1055** (**BAS316**), yielding demodulated audio signal which is applied to the Audio Amplifier Circuit.

Audio Amplifier Circuit

The demodulated audio signal is passed through AF pre-amplifier **Q1119** (**NJM2902V**) and electronic volume control IC **Q1087** (**M62364EP**) to the AF Amplifier IC **Q1105** (**TDA2003H**) which drives the internal or external speaker to a maximum output of approximately 2.5 Watts.

Circuit Description

Transmit Signal Circuitry

Microphone Amplifier Circuit

The audio signal from microphone jack is amplified by audio amplifier **Q1109 (2SC4154E)** on the MAIN Unit, and then is applied to electronic volume control IC **Q1087 (M62364EP)**, the level of which is set via the User Menu.

SSB Modulator Circuit

The output (audio signal) from the electronic volume control IC is passed through audio amplifier **Q1118 (NJM2902V)** to the balanced modulator IC **Q1071 (SA602AD)** which produces a Double Sideband (DSB) signal by applying the carrier signal from the CAR-DDS IC **Q1062 (AD9835BRU)**. The DSB modulated signal (455 kHz) is fed to ceramic filter **CF1004** (or the optional mechanical filter) which strips residual carrier and the undesired sideband, resulting in a Single Sideband (SSB) signal.

AM Modulator Circuit

As in the SSB modulator circuit, a carrier signal appropriate to the transmitting mode (AM) from the CAR-DDS Unit and an audio signal from the microphone are applied to balanced modulator IC **Q1071 (SA602AD)**. The control signal from Mode Switch IC **Q1003 (BU4094BCFV)** causes a voltage (“AM 5V”) to be sent from transistor **Q1058 (2SC4154E)**. This voltage is applied to IC **Q1071** via **D1059 (BAS316)**, causing the balanced modulator to lose balance. The restored carrier signal and modulated signal are then fed to the TX mixer via ceramic filter **CF1004**.

FM Modulator Circuit

The output (audio signal) from the electronic volume control IC is passed through the pre-emphasis circuit which consists capacitor C1492 and resistors R1493 and R1477, and Instantaneous Deviation Control **Q1119 (NJM2902V)**, to the splatter filter which consists **Q1119**, capacitor C1430, and resistors R1358 and R1384. The filtered audio signal is applied to the FM modulator circuit, which produces the FM signal. The FM modulator circuit uses a voltage controlled crystal oscillator (VCXO) which consists **Q1055 (2SC4400)**, **D1046 (1SV229)**, and **X1002 (22.7767 MHz)**.

1st IF Circuit/1st Mixer Circuit

The modulated SSB/AM signal is applied to the 2nd Mixer **Q1082 (SA602AD)**, which produces the 68.33 MHz 2nd IF signal utilizing the 2nd local signal (68.875 MHz). The 2nd IF signal is fed through the 2nd IF filter **XF1004** which strips away unwanted mixer products, then passes through the 2nd IF amplifier **Q1061 (BB304CDW)** to the double balanced mixer **D1034 (HSB88WS)** which produces the transmit frequency by applying the local signal (68.430-538.330 MHz) from the PLL Unit. The transmit signal is passed through a low-pass filter (1.8-29.7 MHz), a high-pass filter (50-54 MHz), a band-pass filter (144-146 MHz), or a band-pass filter (430-450 MHz) which consists of various inductors and capacitors. The filtered transmit signal is amplified by **Q1017 (2SC3357)**, **Q1011 (2SK2596)**, **Q1006/Q1007 (2SK2973)**, and **Q1001/Q1002 (2SK2975)**, and is applied to the Power Amplifier: **Q3022/Q3023 (2SC5125: HF/50 MHz)** or **Q3024 (2SC3102: 144/430 MHz)**.

ALC Circuit

The output from the directional coupler is routed from connector J3001 and applied to the ALC circuit via connector J1001 on the MAIN Unit.

The ALC circuit consists of an op-amp circuit for amplifying the forward and reflected voltage, a time-constant ALC amplifier, and a transmit signal control circuit on the MAIN Unit. The forward voltage from connector J1001 on the MAIN Unit is added with a DC control voltage and is then applied to op-amp IC **Q1111 (NJM2902V)**. The reflected voltage is added with a DC control voltage and is then applied to op-amp IC **Q1112 (NJM2904V)**. In the event of high SWR conditions (SWR 3:1 or more), transmitter output is reduced, thus protecting the PA Unit from potential damage; a “HI SWR” indication also appears on the LCD, alerting the user to an antenna problem.

The ALC amplifier magnifies the forward wave output via transistor **Q1009 (2SC4154)**. This output then passes through a fast-attack, slow-delay RC time-constant circuit, which consists of R1051 and C1051, for input to the TX signal control circuit on the MAIN Unit. The TX control circuit adjusts the IF amplifier gain via gate 2 of FET **Q1061 (BB304CDW)** of the 2nd IF amplifier circuit, to prevent the TX output from exceeding the preset level.

PLL Frequency Synthesizer

The PLL Frequency Synthesizer consists mainly of the master reference oscillator circuit, 2nd local oscillator circuit, PLL IC, and CAR-DDS and REF-DDS units, which digitally synthesize carrier outputs, plus a PLL circuit which contains a voltage controlled oscillator (VCO).

Master Reference Oscillator Circuit

The master reference oscillator uses a Crystal Oscillator (oscillation frequency: 22.625 MHz) composed of **Q5001 (2SC4400-4)**, **X5001**, TC5001, C5001, and R5005. The reference oscillator signal passes through a buffer amplifier **Q5002 (2SC4400-4)**, and is then fed to the MAIN Unit via J5002.

CAR-DDS Circuit REF-DDS Circuit

DDS ICs **Q1062 (AD9835BRU)**, and **Q2016 (AD9850BAS)** each contain a shift register, selector, phase accumulator, and ROM. The reference oscillation frequency (22.625 MHz) that is delivered to each of the DDS Units is applied to each DDS IC after amplification by transistors **Q1043**, **Q1046**, **Q1048**, and **Q1059** (all **2SC4400-3**).

The DDS outputs contain digital amplitude data corresponding to serial frequency data from CPU IC **Q1049**. The DDS frequency range is 453.5 ~ 466.5 kHz (center frequency = 455.0 kHz) for the CAR-DDS, and 7.2-8.0 MHz for the REF DDS.

1st Local Oscillator Circuit

VCO output is buffer-amplified by **Q2011 (2SC5374)** and **Q2022 (UPC2713T)**, and passes through a low-pass filter. It is then fed to the TX/RX frequency mixer circuitry of the MAIN Unit.

2nd Local Oscillator Circuit

The 2nd LO circuit is a Hartley-type overtone oscillator circuit (frequency: 67.875 MHz) composed of **Q1052 (2SC4400-3)** on the MAIN Unit.

PLL Circuit

The PLL circuit is a frequency mixing type composed of a VCO, mixer, PLL IC, and loop filter. The VCO consists of five circuits (VCO1, VCO2, VCO3, VCO4 and VCO5), with a frequency range of 68.430-538.330 MHz divided into five bands, allocated to the five VCO circuits. VCO1-VCO5 consist mainly of FETs **Q2004**, **Q2005**, and **Q2006** (all **2SK210GR**); transistors **Q2009** and **Q2010** (both **2SC5374**); diodes **D2001-D2006** (all **HVC362**), **D2007 (1SV282)**, **D2008 (1SV281)**, and **D2009 (1SV286)**; and coils T2001-T2003, L2010, and L2011.

The VCO switching signal from the connector J2002 is used to drive switching transistors **Q2001**, **Q2002**, **Q2003**, **Q2012**, and **Q2013** (all **DTC124EU**) to switch the source terminal of the oscillator FET.

The 68.430-538.330 MHz VCO signal is buffer-amplified by **Q2023 (UPC1688G)**, and fed to PLL IC **Q2021 (FQ7925)**.

The REF-DDS signal (7.2-8.0 MHz) is fed to PLL IC **Q2021** after it passes through a low-pass filter composed of C2064, C2067, C2069, C2071, C2075, L2014, L2015, and L2016, and is fed to PLL IC **Q2021 (FQ7925)**. The phase of the reference frequency and that of the signal input to the PLL IC are compared, and a signal whose pulse corresponds to the phase difference is produced.

Alignment

Introduction and Precautions

The following procedures cover adjustments that are not normally required once the transceiver has left the factory. However, if damage occurs and some parts subsequently be replaced, realignment may be required. If a sudden problem occurs during normal operation, it is likely due to component failure; realignment should not be done until after the faulty component has been replaced.

We recommend that servicing be performed by authorized Vertex Standard service technicians, experienced with the circuitry and fully equipped for repair and alignment. If a fault is suspected, contact the selling dealer for instructions regarding repair. Authorized Vertex Standard service technicians have the latest configuration information, and realign all circuits and make complete performance checks to ensure compliance with factory specifications after repairs.

Those who do undertake any of the following alignments are cautioned to proceed at their own risk. Problems caused by unauthorized attempts at realignment are not covered by the warranty policy. Also, Vertex Standard must reserve the right to change circuits and alignment procedures in the interest of improved performance, without notifying owners.

Under no circumstances should any alignment be attempted unless the normal function and operation of the transceiver are clearly understood, the cause of the malfunction has been clearly pinpointed and any faulty components replaced, and the need for realignment determined to be absolutely necessary.

The following test equipment (and thorough familiarity with its correct use) is necessary for complete realignment. Most steps do not require all of the equipment listed, but the interactions of some adjustments may require that more complex adjustments be performed in a sequence. Do not attempt to perform only a single step unless it is clearly isolated electrically from all other steps. Rather, have all test equipment ready before beginning, and follow all of the steps in a section in the order they are presented.

Required Test Equipment

- Digital DC Voltmeter (high-Z, 1 M-Ohm/V)
- DC Ammeter
- RF Millivoltmeter
- AC Voltmeter
- RF Standard Signal Generator w/calibrated output and dB scale, $0 \text{ dB}\mu = 0.5\mu\text{V}$
- Signal Generator with calibrated output
- Spectrum Analyzer good to at least 1 GHz.
- Frequency Counter
- 50-Ohm Dummy Load (200 watts)
- 100-Ohm Dummy Load (200 watts)
- 150-Ohm Dummy Load (200 watts)
- In-Line Wattmeter (200 watts, 50-Ohm)
- Linear Detector
- RF Coupler

Alignment Preparation & Precautions

A 50-ohm RF Dummy load and in-line wattmeter must be connected to the main antenna jack in all procedures that call for transmission, except where specified otherwise. Correct alignment is not possible with an antenna.

After completing one step, read the following step to determine whether the same test equipment will be required. If not, remove the test equipment (except dummy load and wattmeter, if connected) before proceeding.

Correct alignment requires that the ambient temperature be the same as that of the transceiver and test equipment, and that this temperature be held constant between $68^\circ\text{F} \sim 86^\circ\text{F}$ ($20^\circ\text{C} \sim 30^\circ\text{C}$). When the transceiver is brought into the shop from hot or cold air, it should be allowed time to come to room temperature before alignment.

Whenever possible, alignments should be made with oscillator shields and circuit boards firmly affixed in place. Also, the test equipment must be thoroughly warmed up before beginning.

Note: Signal levels in dB referred to in this procedure are based on $0 \text{ dB}\mu = 0.5 \mu\text{V}$ (closed circuit).

Local Oscillator Adjustment

Reference Frequency Adjustment

1. Connect an RF millivoltmeter or an oscilloscope to pin 2 of **J5002** on the REF Unit.
2. Confirm that the RF millivoltmeter reading is 115 mV (± 30 mV) rms or 320 mV (± 90 mV) p-p.
3. Connect the frequency counter to pin 2 of **J5002** on the REF Unit.
4. Adjust the **TC5001** for 67.875000 MHz (± 10 Hz) on the frequency counter.

3rd Local Adjustment

1. Connect an RF millivoltmeter or an oscilloscope to **TP1037** on the MAIN Unit.
2. Key the transceiver on CW mode, and adjust **T1025** for maximum indication on the RF millivoltmeter.
3. Confirm that the indicated voltage is 100 mV (± 30 mV) rms or 280 mV (± 80 mV) p-p.

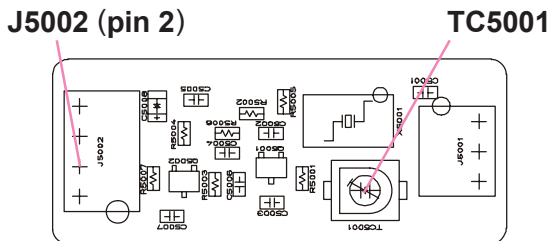

REF Unit Alignment Points

PLL Adjustment

VCO VCV Adjustment

1. Connect the DC voltmeter to **TP1028** on the MAIN Unit (or pin 6 of **J2002** on the PLL Unit), and referring to the table below, tune the transformer/inductor on the PLL Unit on each frequency listed. Then confirm that the correct voltage is present, or adjust the listed component for the required voltage.

TUNE TO	ADJUST/ CONFIRM	FOR	
		LOT 1 ~ 65	LOT 66 ~
13.895 MHz	Adjust T2001	6.0 V ± 0.1 V	5.1 V ± 0.1 V
76.000 MHz	Confirm	At least 0.9 V	At least 0.8 V
32.995 MHz	Adjust T2002	6.0 V ± 0.1 V	5.1 V ± 0.1 V
13.900 MHz	Confirm	At least 0.9 V	At least 0.8 V
55.995 MHz	Adjust T2003	6.0 V ± 0.1 V	5.1 V ± 0.1 V
88.000 MHz	Confirm	At least 0.9 V	At least 0.8 V
163.995 MHz	Adjust L2010	5.5 V ± 0.5 V	5.1 V ± 0.2 V
118.000 MHz	Confirm	At least 0.8 V	At least 0.7 V
469.995 MHz	Adjust L2011	5.5 V ± 0.5 V	5.0 V ± 0.2 V
420.000 MHz	Confirm	At least 0.8 V	At least 0.8 V

1st Local Output Level

1. Connect the RF millivoltmeter to **TP1029** on the MAIN Unit (or pin 11 of **J2002** on the PLL Unit), and set the transceiver to 28.000 MHz.
2. Confirm that the RF level is at least 0 dBm or 200 mV rms.

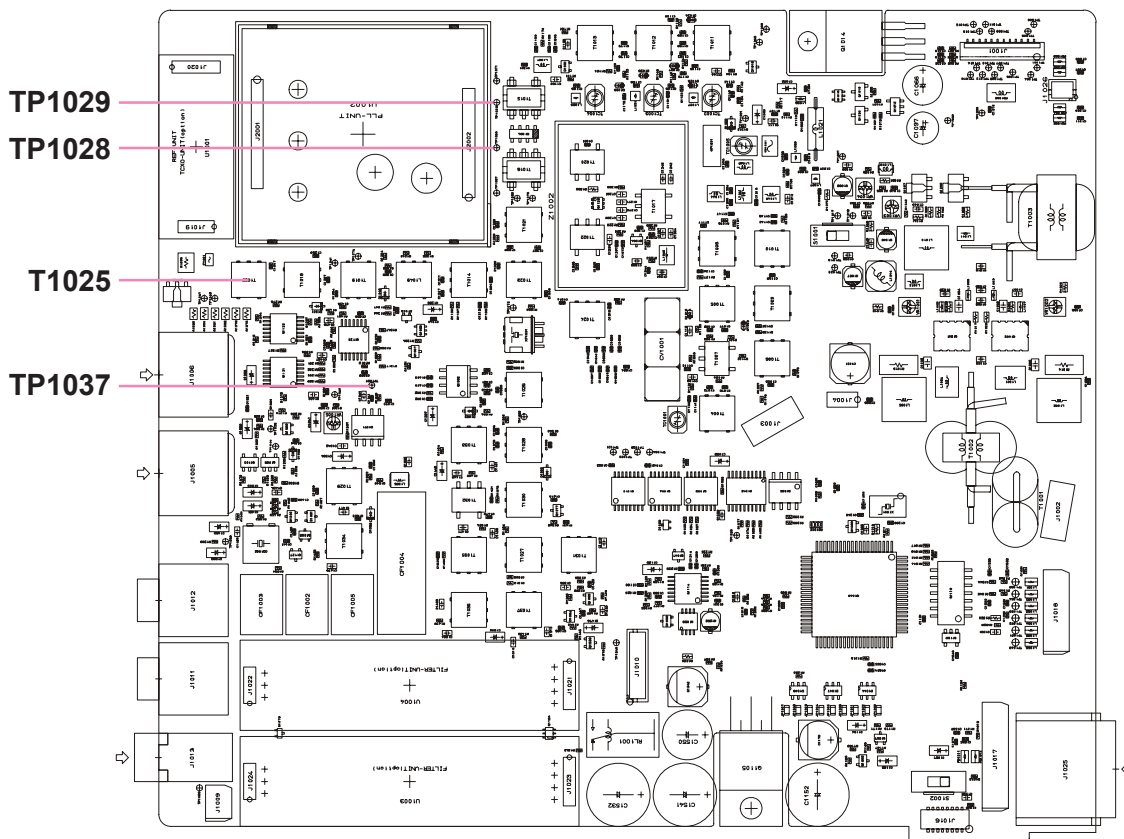

MAIN Unit Alignment Points I

Alignment

PLL Unlock

1. Connect the DC voltmeter to **TP1029** on the MAIN Unit (or pin 11 of **J2002** on the PLL Unit).
2. Disconnect the REF Unit from the MAIN Unit; confirm that the DC voltmeter shows less than 0.5 V and that “UNLOCK” is displayed on the LCD.
3. Re-connect the REF Unit to the MAIN Unit, and confirm that the DC voltmeter shows at least 3.5 V and that the LCD returns to its normal display.

Idling Current Adjustment

Before alignment, set the mode to CW and tune the transceiver to 1.800 MHz. Nothing should be connected to the CW Key Jack, and switch off **S1001** on the MAIN Unit.

Pre-Driver Stage Idling Current

1. Connect the ammeter between **TP1019** (+) and **TP1020** (-) on the MAIN Unit.
2. Press the PTT, and adjust **VR1004** for an indication of 30 mA (± 5 mA) on the ammeter.

Driver Stage Idling Current

1. Connect the ammeter between **TP1017** (+) and **TP1018** (-) on the MAIN Unit.
2. Press the PTT and adjust **VR1003** for an indication of 60 mA (± 5 mA) on the ammeter.

Exciter Stage Idling Current

1. Disconnect the Jumper Plug from **J1004** on the MAIN Unit, then connect the ammeter to **J1004** (pin 1: -, pin 1: +).
2. Turn both **VR1001** and **VR1002** fully counterclockwise.
3. Press the PTT and adjust **VR1002** for an indication of 50 mA (± 10 mA) on the ammeter.
4. Press the PTT and adjust **VR1001** for an indication of 100 mA (± 10 mA) on the ammeter.
5. Re-connect the Jumper Plug to **J1004** and switch on **S1001**.

TX IF Adjustment

SSB/CW TX IF Adjustment

1. Tune the frequency to the 14 MHz band.
2. Disconnect the Coaxial Cable from **J1002** and connect the In-Line Wattmeter and the 50-Ohm dummy load to **J1002**.
3. Inject a 1 kHz tone at 1 mV level to the **MIC** jack.
4. Key the transmitter, and adjust **T1033**, **T1023** and **T1021** for maximum indication on the RF wattmeter.
5. Disconnect the In-Line Wattmeter and the 50-Ohm dummy load, then re-connect the Coaxial Cable to **J1002**.

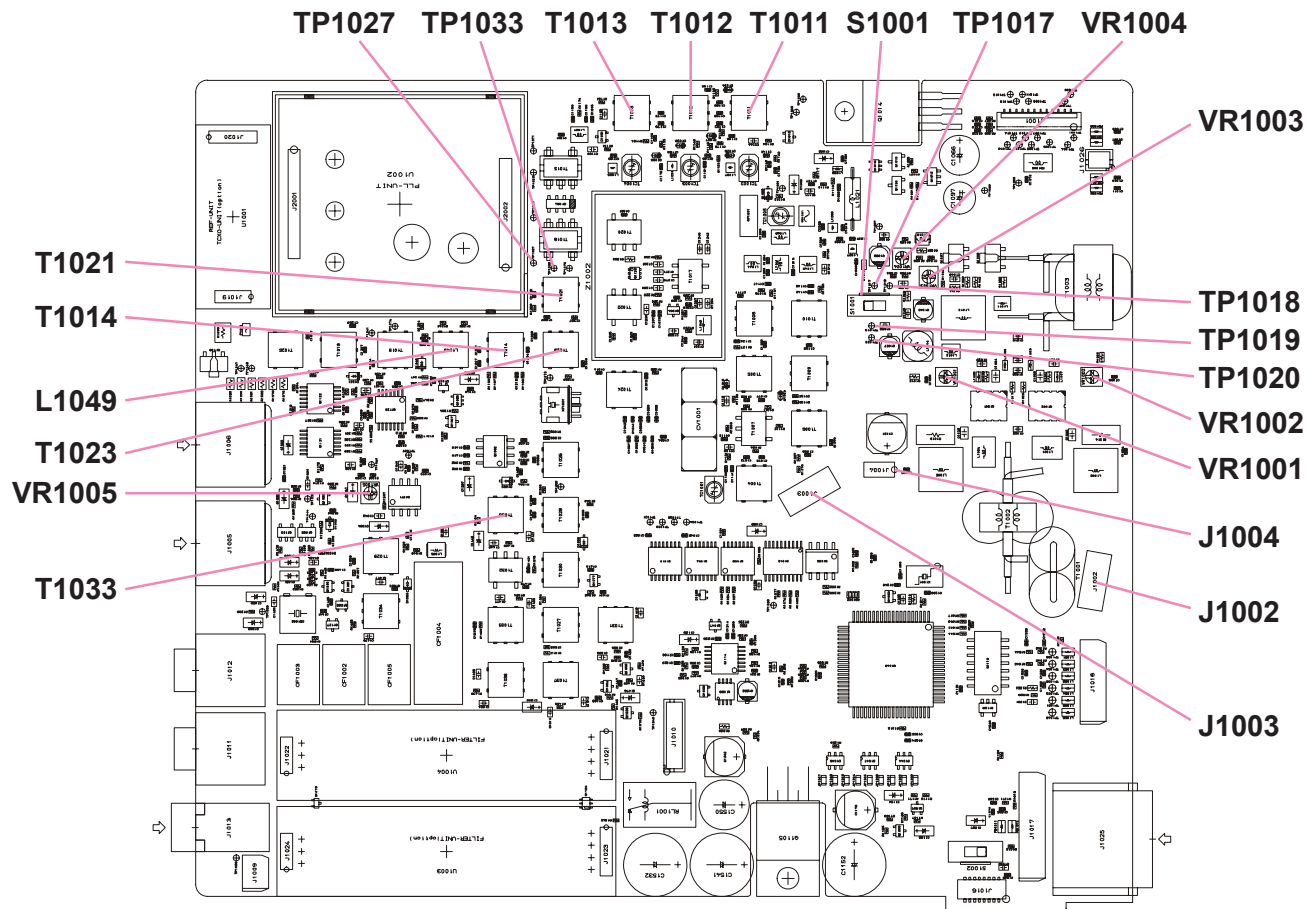
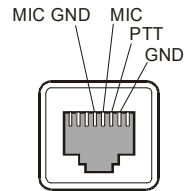

MAIN Unit Alignment Points II

FM TX IF Adjustment

1. Tune the frequency to the 28 MHz band. Connect the RF millivoltmeter to **TP1033** on the MAIN Unit.
2. Disconnect the Coaxial Cable from **J1002** and terminate **J1002** into a 50-Ohm dummy load.
3. Key the transmitter in the FM mode, and adjust **T1014** for maximum indication on the RF millivoltmeter.
4. Connect the frequency counter to **TP1033**.
5. Key the transmitter in the FM mode without microphone input. Adjust **L1049** for a reading of 68.3300 MHz (± 100 Hz).
6. Disconnect the 50-Ohm dummy load and re-connect the Coaxial Cable to **J1002**.

Carrier Balance Adjustment

1. Tune the frequency to the 14 MHz band. Disconnect the Coaxial Cable from **J1002** on the MAIN Unit.
2. Terminate **J1002** into a 50-Ohm dummy load and connect a spectrum analyzer or a RF millivoltmeter at this point.
3. Key the transmitter in the USB mode without microphone input. Adjust **VR1005** for maximum carrier suppression on the spectrum analyzer or for minimum indication on the RF millivoltmeter.
4. Disconnect the 50-Ohm dummy load and the spectrum analyzer or the RF millivoltmeter, and re-connect the Coaxial Cable to **J1002**.

TX BPF Adjustment

VHF TX BPF Adjustment

1. Set the frequency to 145.995 MHz. Disconnect the Coaxial Cable from **J1002** on the MAIN Unit.
2. Connect the spectrum analyzer to **J1002**, which should be terminated into a 50-Ohm dummy load.
3. Inject a 1 kHz tone at 1 mV level to the **MIC** jack.
4. Key the transceiver in the USB mode, and adjust **T1013**, **T1012**, and **T1011** alternately for maximum indication on the spectrum analyzer.
5. Disconnect the 50-Ohm dummy load and the spectrum analyzer, and re-connect the Coaxial Cable to **J1002**.

UHF TX BPF Adjustment

1. Set the frequency to 440.000 MHz. Disconnect the Coaxial Cable from **J1002** on the MAIN Unit.
2. Connect the spectrum analyzer to **J1002**, which should be terminated into a 50-Ohm dummy load.
3. Inject a 1 kHz tone at 1 mV level to the **MIC** jack.
4. Key the transceiver in the USB mode, and adjust **TC1004**, **TC1003** and **TC1002** alternately for maximum indication on the spectrum analyzer.
5. Disconnect the 50-Ohm dummy load and the spectrum analyzer, and re-connect the Coaxial Cable to **J1002**.

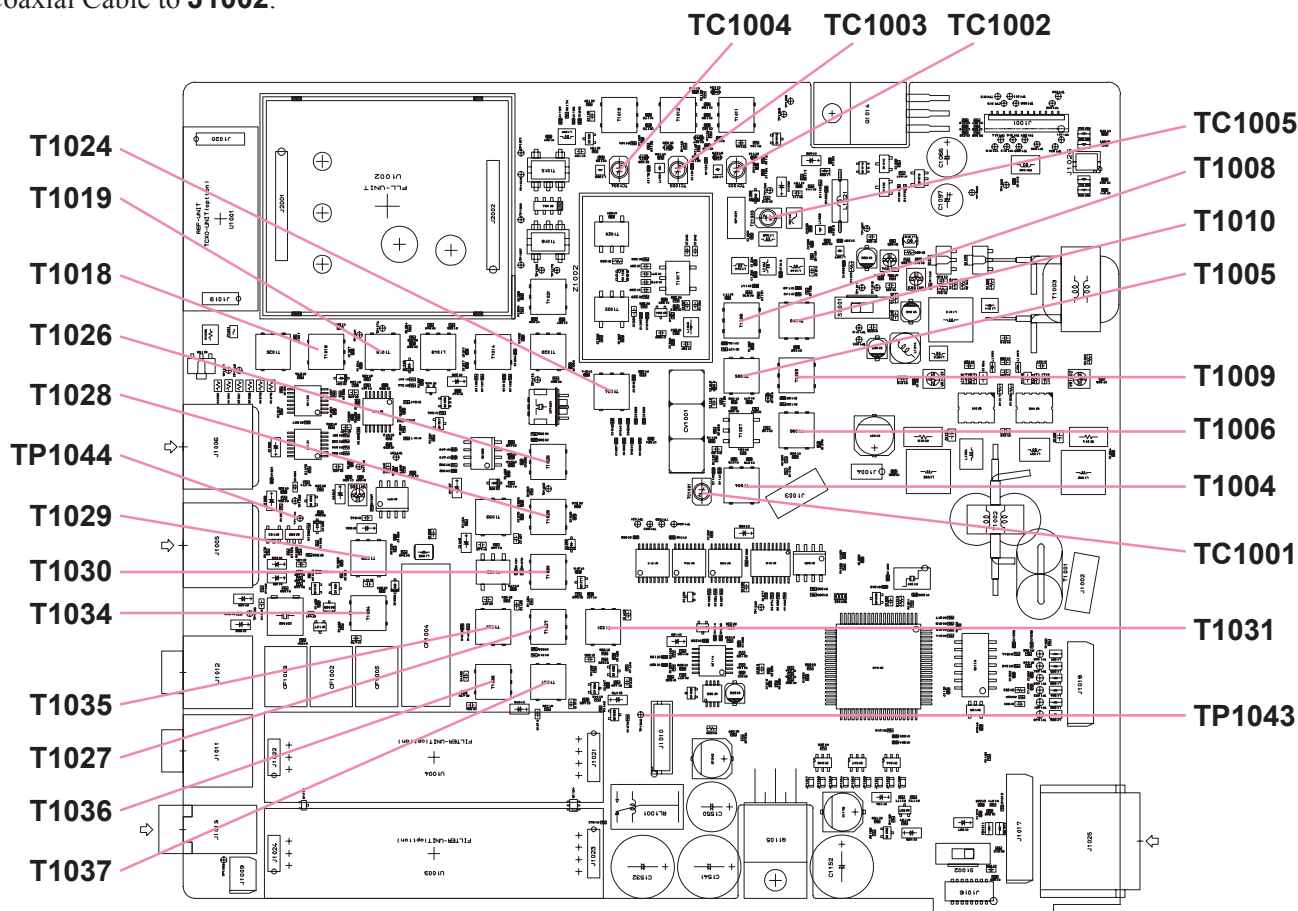

MAIN Unit Alignment Points III

Alignment

RX Adjustment

SSB IF Adjustment

1. Connect the signal generator to the HF/50 MHz antenna jack, and the AF millivoltmeter and the SINAD meter to the speaker jack.
2. Tune the transceiver to 51.995 MHz, and switch off the ATT and IPO feature. Inject a 51.995 MHz signal from a signal generator at 0 dB μ output.
3. Adjust **T1018**, **T1019**, **T1024**, **T1026**, **T1028**, **T1030**, **T1035**, **T1036**, **T1037**, **T1034** and **T1029** on the MAIN UNIT alternately for maximum indication on the AF millivoltmeter. Several passes may be necessary, as the adjustments inter-react to some degree.

FM IF Adjustment

1. Connect the signal generator to the HF/50 MHz antenna jack.
2. Tune the transceiver to 51.995 MHz. Inject a 51.995 MHz signal from a signal generator at 5 dB μ output, with 1 kHz AF FM modulation at ± 3.5 kHz deviation.
3. Adjust **T1024**, **T1026**, and **T1028** on the MAIN Unit alternately for maximum level on the S-meter.

Air-Band Reception Adjustment

1. Connect the signal generator to the HF/50 MHz antenna jack, and the DC voltmeter to **TP1044** on the MAIN Unit.
2. Tune the transceiver to 128.000 MHz in the AM mode. Inject a 128.000 MHz signal from the signal generator at 20 dB μ output, with 30% AM modulation at 400 Hz audio frequency.
3. Adjust **T1005** and **T1008** for minimum indication on the DC voltmeter.

VHF Band Alignment

1. Connect the signal generator to the 144/430 MHz antenna jack, and the DC voltmeter to **TP1044** on the MAIN Unit.
2. Tune the transceiver to 145.995 MHz in the CW mode. Inject a 145.995 MHz signal from a signal generator at 20 dB μ output.
3. Adjust **T1006**, **T1009**, and **T1010** alternately for minimum indication on the DC voltmeter.

UHF Band Alignment

1. Connect the signal generator to the 144/430 MHz antenna jack, and the DC voltmeter to **TP1044** on the MAIN Unit.
2. Tune the transceiver to 439.995 MHz in the CW mode. Inject a 439.995 MHz signal from the signal generator at 20 dB μ output.
3. Adjust **TC1001** for minimum indication on the DC voltmeter.

W-FM Reception Adjustment

1. Connect the signal generator to the 144/430 MHz antenna jack, and the SINAD meter to the speaker jack.
2. Tune the transceiver to 88.000 MHz. Inject an 88.000 MHz signal from the signal generator at 30dB μ output, with ± 22.5 kHz deviation FM modulation of a 1 kHz audio signal.
3. Adjust **TC1005** for the best SINAD sensitivity. Then reduce the output level of the signal generator to where the signal just begins to sound slightly “noisy,” and adjust **TC1005** again for best SINAD.

Image Rejection Trap Adjustment

1. Connect the signal generator to the HF/50 MHz antenna jack, the AF millivoltmeter to the speaker jack.
2. Tune the transceiver to 51.995 MHz in the FM mode. Inject a 68.330 MHz signal from a signal generator at 70 dB μ output, with 1 kHz AF FM modulation at ± 3.5 kHz deviation.
3. Adjust **T1004** for minimum indication on the AF millivoltmeter. Then increase the output level of the signal generator slightly and adjust **T1004** again, so as to ensure maximum notching of the image.

Noise Blanker Adjustment

1. Connect the signal generator to the HF/50 MHz antenna jack, and the DC voltmeter to **TP1043** on the MAIN Unit.
2. Tune the transceiver to 51.995 MHz and inject a 51.995 MHz signal from the signal generator at 20 dB μ output.
3. Activate the noise blanker, and adjust **T1027** and **T1031** for minimum indication on the DC voltmeter.

Power Amplifier Adjustment (Lot 1 ~ 59)

HF/50 MHz Idling Current Adjustment

1. Connect the 50-Ohm dummy load to the HF/50 MHz antenna jack.
2. Tune the transceiver to any HF band, or to the 50 MHz band.
3. Disconnect the wire jumper from **TP3025** and **TP3026** on the PA Unit, then connect the ammeter between **TP3025 (+)** and **TP3026 (-)**.
4. Turn **VR3001** fully counterclockwise.
5. Press the PTT, and adjust **VR3001** for an indication of 100 mA (± 10 mA) on the ammeter.
6. Disconnect the ammeter, and re-connect **TP3025** and **TP3026** using the wire jumper.

V/UHF Idling Current Adjustment

1. Connect the 50-Ohm dummy load to the 144/430 MHz antenna jack.
2. Tune the transceiver to the 430 MHz band.
3. Disconnect the wire jumper from **TP3025** and **TP3026** on the PA Unit, then connect the ammeter between **TP3025 (+)** and **TP3026 (-)**.
4. Turn **VR3002** fully counterclockwise.
5. Press the PTT, and adjust **VR3002** for an indication of 300 mA (± 10 mA) on the ammeter.
6. Disconnect the ammeter, and re-connect **TP3025** and **TP3026** using the wire jumper.

Directional Coupler Balance Adjustment

1. Connect the 50-Ohm dummy load to the HF/50 MHz antenna jack.
2. Tune the transceiver to 28 MHz band in the CW mode, and connect the DC voltmeter to **TP3003** on the PA Unit.
3. Press the PTT, and adjust **TC3002** for minimum indication on the DC voltmeter.
4. Connect the 50-Ohm dummy load and wattmeter to the 144/430 MHz antenna jack
5. Tune the transceiver to 439.995 MHz in the CW mode.
6. Press the PTT, and adjust **VR3003** for minimum indication on the DC voltmeter.
7. Leave the transceiver on 439.995 MHz band and key the transceiver.
8. Adjust **TC3001** for maximum indication on the wattmeter.

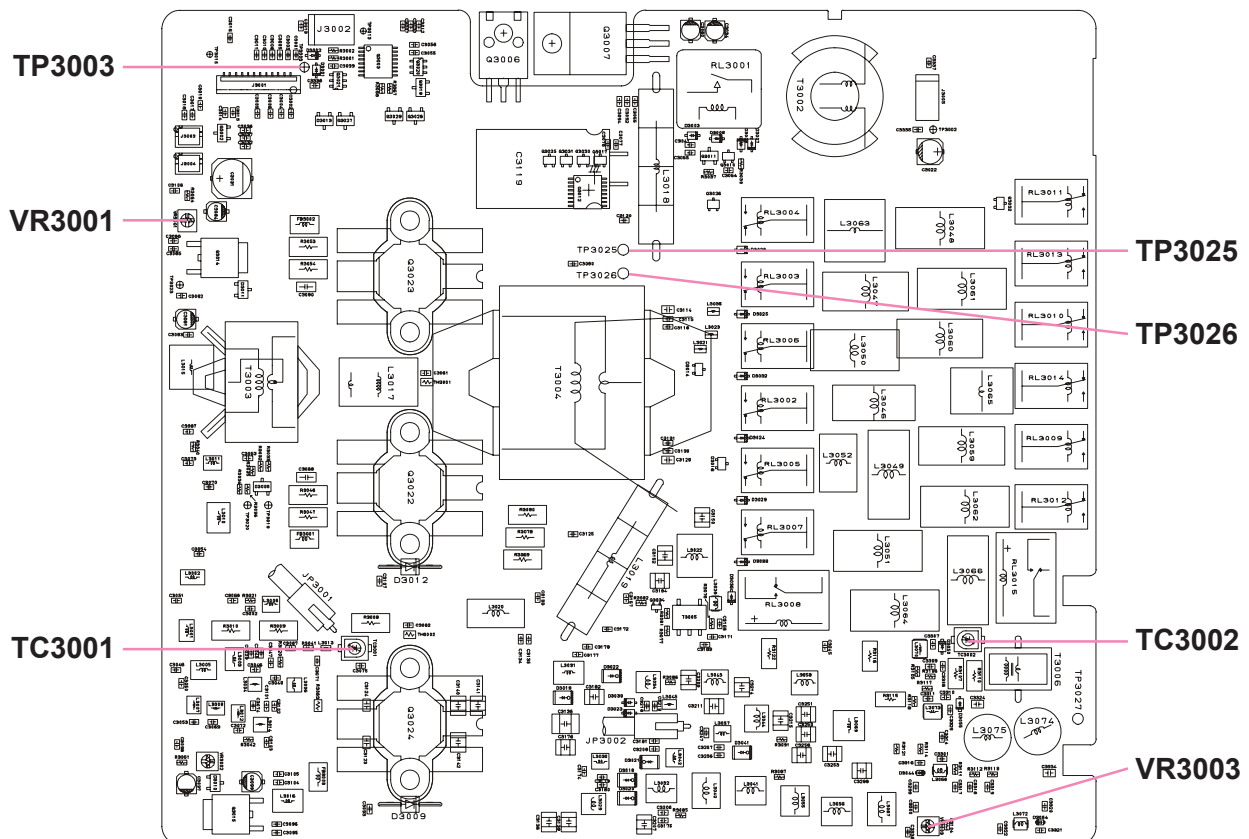

PA Unit (Lot 1 ~ 59) Alignment Points

Alignment

Power Amplifier Adjustment (Lot 60 ~)

HF/50 MHz Idling Current Adjustment

1. Connect the 50-Ohm dummy load to the HF/50 MHz antenna jack.
2. Tune the transceiver to any HF band, or to the 50 MHz band.
3. Disconnect the wire jumper from **TP3025** and **TP3026** on the PA Unit, then connect the ammeter between **TP3025** (+) and **TP3026** (-).
4. Turn **VR3001** fully counterclockwise.
5. Press the PTT, and adjust **VR3001** for an indication of 600 mA (± 10 mA) on the ammeter.
6. Disconnect the ammeter, and re-connect **TP3025** and **TP3026** using the wire jumper.

V/UHF Idling Current Adjustment

1. Connect the 50-Ohm dummy load to the 144/430 MHz antenna jack.
2. Tune the transceiver to the 430 MHz band.
3. Disconnect the wire jumper from **TP3025** and **TP3026** on the PA Unit, then connect the ammeter between **TP3025** (+) and **TP3026** (-).
4. Turn **VR3002** fully counterclockwise.
5. Press the PTT, and adjust **VR3002** for an indication of 1000 mA (± 50 mA) on the ammeter.
6. Disconnect the ammeter, and re-connect **TP3025** and **TP3026** using the wire jumper.

Directional Coupler Balance Adjustment

1. Connect the 50-Ohm dummy load to the HF/50 MHz antenna jack.
2. Tune the transceiver to 28 MHz band in the CW mode, and connect the DC voltmeter to **TP3003** on the PA Unit.
3. Press the PTT, and adjust **TC3002** for minimum indication on the DC voltmeter.
4. Connect the 50-Ohm dummy load and wattmeter to the 144/430 MHz antenna jack
5. Tune the transceiver to 439.995 MHz in the CW mode.
6. Press the PTT, and adjust **VR3003** for minimum indication on the DC voltmeter.
7. Leave the transceiver on 439.995 MHz band and key the transceiver.
8. Adjust **TC3001** for maximum indication on the wattmeter.

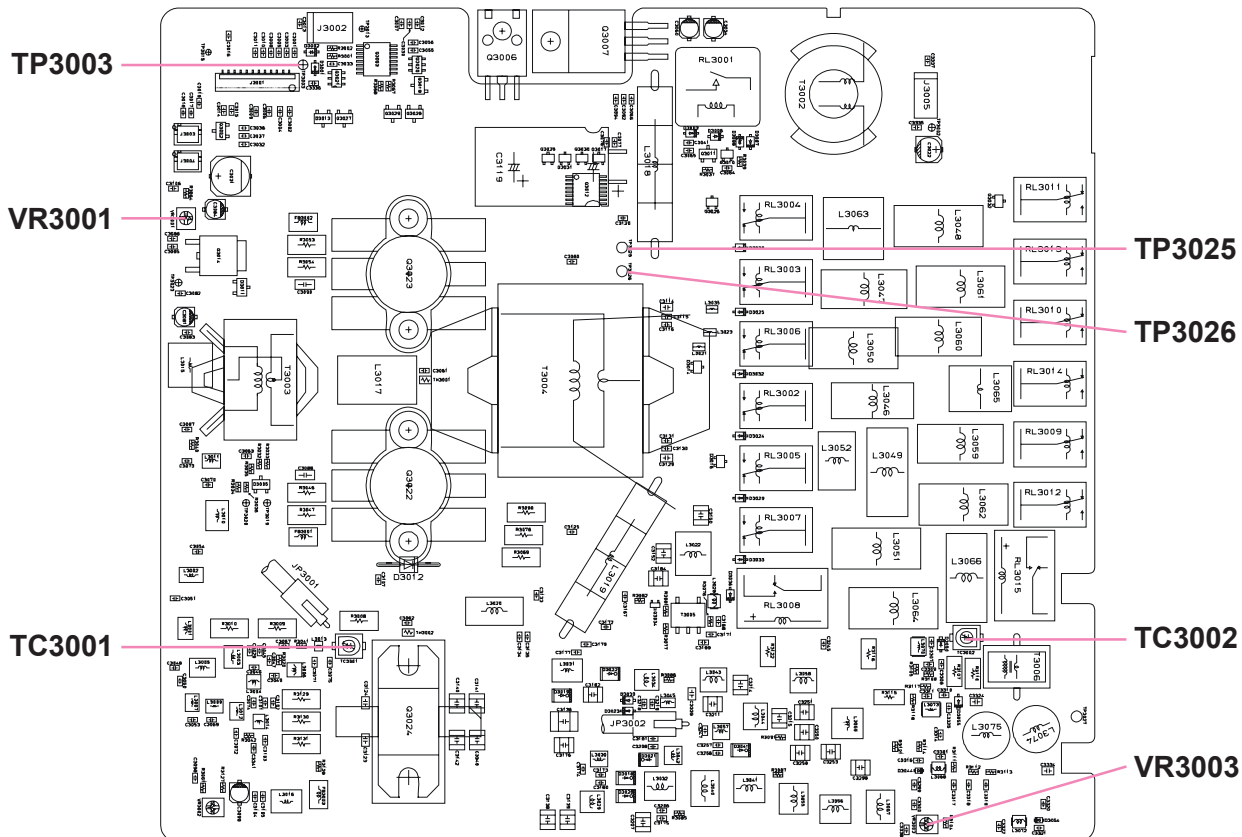

PA Unit (Lot 60 ~) Alignment Points

Alignment

LCD Contrast Alignment

1. Connect a DC voltmeter (High Impedance) to **TP4027** on the PANEL Unit.
2. Adjust **VR4001** for an indication of $-2.54\text{ V} (\pm 0.02\text{ V})$ on the voltmeter.

Software Menu Alignment

The antenna jacks should be connected to a dummy load (in cases where transmission is involved) or the signal generator (in the case of reception). General alignment conditions are as follows unless otherwise noted.

- AF-gain knob:** Center
- RF-gain knob:** Fully clockwise
- SQL:** Fully counterclockwise
- ATT/IPO/CTCSS/DCS:** Off
- AGC:** Auto
- Output power:** Max
- Break-in:** On,
- CW Keyer:** Off
- VOX:** Off

Press and hold in three Multi Function Keys ([**A**], [**B**], [**C**]) simultaneously and turn on the transceiver while holding them in; the alignment menu will then be activated (you will hear a “diddle-diddle-diddle” opening tone sequence to confirm that the alignment menu has been activated).

In the alignment procedures, each alignment parameter is selected by rotating the main **DIAL** knob. Each Alignment item is then selected by rotating the **SELECT** knob.

To store the alignment parameters when you are satisfied with the adjustment, press the [**FUNC**] key for longer than a one second.

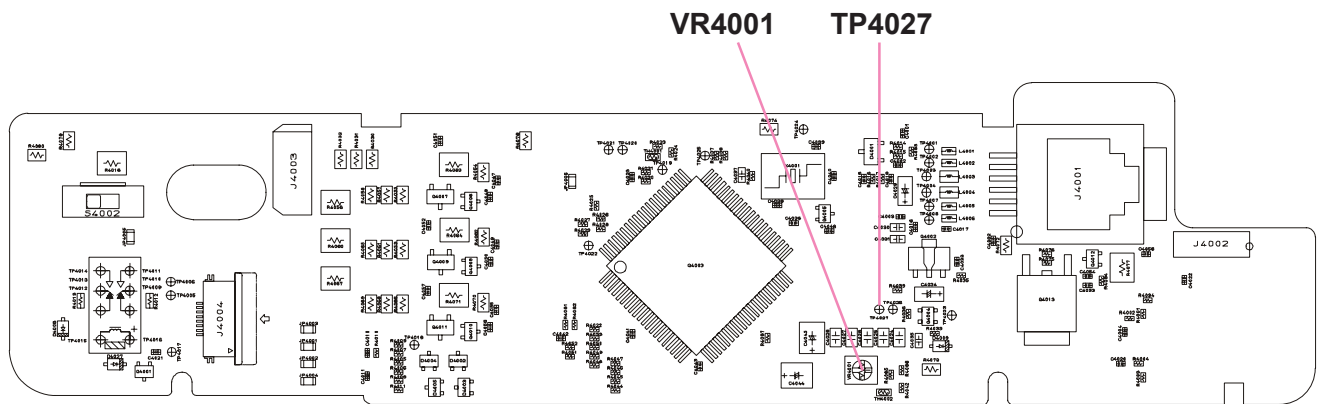

PANEL Unit Alignment Points

Alignment

RX Gain Adjustment

1. Tune the transceiver to the 1.8 MHz band in the CW mode.
2. Select “**HF1RXG**” in the menu by rotating the **SELECT** knob, if necessary.
3. Inject an RF signal from the signal generator at 9 dB μ output.
4. Adjust the “**HF1RXG**” parameter by rotating the main **DIAL** knob to the point where the S-meter indicates “S1.”
5. The other RX gain adjustments (see the chart below) should be performed in the same way. The output levels of the signal generator at each frequency are shown below.

Menu	Frequency	Output Level of SG
01: HF1RXG	1.8 MHz Band	9 dB μ
02: HF2RXG	7 MHz Band	9 dB μ
03: HF3RXG	21 MHz Band	6 dB μ
04: 50MRXG	50 MHz Band	3 dB μ
05: VHFRXG	144 MHz Band	0 dB μ
06: UHFRXG	430 MHz Band	0 dB μ

SSB S-Meter Adjustment

1. Tune the transceiver to the 21 MHz band in the CW mode.
2. Inject an RF signal from the signal generator at 36 dB μ output.
3. Select menu item “**07: SSB-SS**” and press the **[A]** key to set this parameter.
4. Increase the signal generator output level to 86 dB μ .
5. Select menu item “**08: SSB-FS**” and press the **[A]** key to set this parameter.

FM S-Meter Adjustment

1. Tune the transceiver to the 144 MHz band in the FM mode.
2. Inject an RF signal from the signal generator at 0 dB μ output, with ± 3.5 kHz deviation FM Modulation of a 1 kHz tone.
3. Select menu item “**09: FM-S1**” and press the **[A]** key to set this parameter.
4. Increase the signal generator output level to 25 dB μ .
5. Select menu item “**10: FM-FS**” and press the **[A]** key to set this parameter.

FM Center Meter Adjustment

1. Tune the transceiver to the 144 MHz band in the FM mode.
2. Inject an RF signal from the signal generator at 10 dB μ output, with ± 3.5 kHz deviation FM Modulation of a 1 kHz tone.
3. Set the frequency of the signal generator 3 kHz below the receiving frequency of the transceiver.
4. Select menu item “**11: DISC-L**” and press the **[A]** key to set this parameter.
5. Set the frequency of the signal generator 3 kHz above the receiving frequency of the transceiver.
6. Select menu item “**12: DISC-H**” and press the **[A]** key to set this parameter.

FM Squelch Adjustment

1. Tune the transceiver to the 144 MHz band in the FM mode. Confirm that the squelch knob is turned fully counterclockwise.
2. Inject an RF signal from the signal generator at -15 dB μ output, with ± 3.5 kHz deviation FM Modulation of a 1 kHz tone.
3. Select menu item “**13: FM-TH1**” and press the **[A]** key to set this parameter.
4. Select menu item “**14: FM-TH2**” and press the **[A]** key again.
5. Increase the signal generator output level to 0 dB μ .
6. Select menu item “**15: FM-TI1**” and press the **[A]** key to set this parameter.
7. Select menu item “**16: FM-TI2**” and press the **[A]** key again.

Power Supply Voltage Display Adjustment

1. Tune the transceiver to the 144 MHz band in the FM mode. Confirm that the power supply voltage is 13.8 V (± 0.1 V).
2. Select menu item “**17: VCC**” and adjust this parameter such that “**138**” is displayed on the LCD.

Over-current Protection Adjustment

1. Set the transceiver to the CW mode.
2. Select menu item “**18: HF1-IC.**” Tune the transceiver to the 1.8 MHz band and key the transceiver. Adjust this parameter for 140 Watts of transmission power.
3. Select menu item “**19: HF2-IC.**” Tune the transceiver to the 7 MHz band and key the transceiver. Adjust this parameter for 130 Watts of transmission power.
4. Select menu item “**20: HF3-IC.**” Tune the transceiver to the 21 MHz band and key the transceiver. Adjust this parameter for 130 Watts of transmission power.
5. Select menu item “**21: 50M-IC.**” Tune the transceiver to the 50 MHz band and key the transceiver. Adjust this parameter for 120 Watts of transmission power.
6. Select menu item “**22: VHF-IC.**” Tune the transceiver to the 144 MHz band and key the transceiver. Adjust this parameter for 60 Watts of transmission power.
7. Select menu item “**23: UHF-IC.**” Tune the transceiver to 430.000 MHz and key the transceiver. Adjust this parameter for 25 Watts of transmission power.

RF Power Adjustment

1. Tune the transceiver to the 1.8 MHz band in the CW mode.
2. Select menu item “**24: HF1-MAX.**” Key the transmitter, and adjust this parameter for 100 Watts (± 5 W) of transmission power.
3. Select menu item “**25: HF1-MID2.**” Key the transmitter, and confirm that the output power is 50 W (± 5 W). In case the transmission power is not within the specified tolerance, adjust this parameter for 50 W (± 5 W) of transmission power.
4. Select menu item “**26: HF1-MID1.**” Key the transmitter, and confirm that the output power is 10 W (± 1 W). In case the power is not within the specified tolerance, adjust this parameter for 10 W (± 1 W) of transmission power.
5. Select menu item “**27: HF1-MIN.**” Key the transmitter, and confirm that the output power is 5 W (± 1 W). In case the power is not within the specified tolerance, adjust this parameter for 5 W (± 1 W) of transmission power.
6. The other RF power adjustment menus, [**HF2-****] and [**HF3-****], should be adjusted in the same manner as shown above for the 7 MHz and 21 MHz bands respectively.
7. Tune the transceiver to the 50 MHz band in the CW mode.
8. Select menu item “**36: 50M-MAX.**” Key the transmitter, and adjust this parameter for 100 W (± 5 W) of transmission power.
9. Select menu item “**37: 50M-MID2.**” Key the transmitter, and confirm that the output power is 50 W (± 5 W). In case the transmission power is not within the specified tolerance, adjust this parameter for 50 W (± 5 W) of transmission power.
10. Select menu item “**38: 50M-MID1.**” Key the transmitter, and confirm that the output power is 20 W (± 2 W). In case the power is not within the specified tolerance, adjust this parameter for 20 W (± 2 W) of transmission power.
11. Select menu item “**39: 50M-MIN.**” Key the transmitter, and confirm that the output power is 5 W ($+0/-1$ W). In case the power is not within the specified tolerance, adjust this parameter for 5 W ($+0/-1$ W) of transmission power.
12. Tune the transceiver to the 144 MHz band in the CW mode.
13. Select menu item “**40: VHF-MAX.**” Key the transmitter, and adjust this parameter for 50 W (± 2.5 W) of transmission power.

Alignment

14. Select menu item “**41: VHF-MID.**” Key the transmitter, and confirm that the output power is 20 W (± 2 W). In case the transmission power is not within the specified tolerance, adjust this parameter for 20 W (± 2 W) of transmission power.
15. Select menu item “**42: VHF-MIN.**” Key the transmitter, and confirm that the output power is 5 W (+0/–1 W). In case the power is not within the specified tolerance, adjust this parameter for 5 W (+0/–1 W) of transmission power.
16. Tune the transceiver to the 430 MHz band in the CW mode.
17. Select menu item “**43: UHF-MAX.**” Key the transmitter, and adjust this parameter for 20 W (± 1 W) of transmission power.
18. Select menu item “**44: UHF-MID.**” Key the transmitter, and confirm that the output power is 2 W (± 0.3 W). In case the transmission power is not within the specified tolerance, adjust this parameter for 2 W (± 0.3 W) of transmission power.

TX Gain Adjustment (Lot 1 ~ 78)

1. Set the transceiver to the USB mode.
2. Inject a 1 kHz tone at 0.7 mV level to the MIC jack.
3. Tune the transceiver to the 1.8 MHz band.
4. Select menu item “**45: HF1TXG.**” Key the transmitter, and adjust this parameter for 70 W (± 10 W) of transmission power.
5. The other TX gain adjustment menus, “**46: HF2TXG,**” “**47: HF3TXG,**” and “**48: 50MTXG,**” should be adjusted in the same manner as detailed above on the 7 MHz, 21 MHz, and 50 MHz bands, respectively.
6. Tune the transceiver to the 144 MHz band.
7. Increase the audio signal level to 1.0 mV.
8. Select menu item “**49: VHFTXG.**” Key the transmitter and adjust this parameter for 35 W (± 5 W) of transmission power.
9. Tune the transceiver to the 430 MHz band.
10. Select menu item “**50: UHFTXG.**” Key the transmitter and adjust this parameter for 14 W (± 2 W) of transmission power.

TX Gain Adjustment (Lot 79 ~)

1. Set the transceiver to the USB mode.
2. Inject a 1 kHz tone at 0.7 mV level to the MIC jack.
3. Tune the transceiver to the 1.8 MHz band.
4. Select menu item “**45: HF1TXG.**” Key the transmitter, and adjust this parameter for 50 W of transmission power.
5. The other TX gain adjustment menus, “**46: HF2TXG,**” “**47: HF3TXG,**” and “**48: 50MTXG,**” should be adjusted for 70 W (± 10 W) of transmission power on the 7 MHz, 21 MHz, and 50 MHz bands, respectively.
6. Tune the transceiver to the 144 MHz band.
7. Increase the audio signal level to 1.0 mV.
8. Select menu item “**49: VHFTXG.**” Key the transmitter and adjust this parameter for 35 W (± 5 W) of transmission power.
9. Tune the transceiver to the 430 MHz band.
10. Select menu item “**50: UHFTXG.**” Key the transmitter and adjust this parameter for 14 W (± 2 W) of transmission power.

ALC (Automatic Level Control) Meter Adjustment

1. Tune the transceiver to the 21 MHz band in the USB mode.
2. Select menu item “**51: ALC-1.**” Key the transceiver without microphone input and press the [A] key. Now, a value which the microprocessor computes will be displayed on the LCD.
3. Rotate the main **DIAL** knob to adjust this parameter to a reading four digits lower than the parameter value displayed in the previous step.
4. After setting the parameter, confirm that all the dots of the ALC meter have gone out.
5. Select menu item “**52: ALC-M.**” 1 kHz tone at 4 mV level to the **MIC** jack.
6. Press the [A] key and confirm that the ALC meter shows an “S-8” S-meter reading on the LCD.

AFP (Automatic Final Protection) Adjustment

1. Tune the transceiver to the 1.8 MHz band in the CW mode, and connect a 150-Ohm dummy load to the antenna jack.
2. Select menu item “**53: HF1-RV.**” Key the transmitter, and adjust this parameter for an “S-8” S-meter reading on the LCD.
3. The other AFP adjustment menus, “**54: HF2-RV.**” “**55: HF3-RV.**” and “**56: 50M-RV.**” should be adjusted in the same manner as shown above on the 7 MHz, 21 MHz, and 50 MHz bands, respectively.
4. Tune the transceiver to the 144 MHz band.
5. Select menu item “**57: VHF-RV.**” Key the transmitter, and adjust this parameter for an “S-6” S-meter reading on the LCD.
6. Tune the transceiver to the 430 MHz band.
7. Select menu item “**58: UHF-RV.**” Key the transmitter, and adjust this parameter for an “S-3” S-meter reading on the LCD.

Carrier Level Adjustment

1. Tune the transceiver to the 21 MHz band in the CW mode.
2. Connect a 50-Ohm dummy load to the HF/50MHz antenna jack.
8. Select menu item “**59: CW-CAR.**” Key the transmitter, and adjust this parameter for an “S-9” S-meter reading on the LCD.
3. Connect the oscilloscope to the HF/50MHz antenna jack via an appropriate attenuator.
4. Set the transceiver to the AM mode.
5. Inject a 1 kHz tone at 1 mV level to the **MIC** jack.
6. Select menu item “**60: AM-CAR.**” Key the transmitter, and adjust this parameter for 33% AM modulation on the oscilloscope.

FM Modulation Adjustment

1. Tune the transceiver to the 144 MHz band in the FM mode. Connect the FM linear detector to the 144/430 MHz antenna jack via an appropriate attenuator.
2. Inject a 1 kHz tone at 15 mV level to the **MIC** jack.
3. Select menu item “**61: DEV-W.**” Key the transmitter, and adjust this parameter for a maximum deviation of ± 4.5 kHz (± 0.2 kHz) on the FM linear detector.
4. Select menu item to “**62: DEV-N.**” Key the transmitter, and adjust this parameter for maximum deviation of ± 2.25 kHz (± 0.1 kHz) on the FM linear detector.
5. Select menu item to “**63: M-MTR.**” Key the transmitter, and set this parameter for an “S-9” indication on the S-meter on the LCD.
6. Select menu item to “**64: DTMF.**” Key the transmitter, and adjust this parameter for a maximum deviation of ± 3.5 kHz (± 0.3 kHz) on the FM linear detector (the transceiver generates the DTMF “D” tone automatically while the menu item selected is “**64: DTMF.**”).
7. Select menu item to “**65: CTCSS.**” Key the transmitter without microphone input, and adjust this parameter for a maximum deviation of ± 0.7 kHz (± 0.1 kHz) on the FM linear detector (the transceiver generates a CTCSS tone automatically while the menu item selected is “**65: CTCSS.**”).
8. Select menu item to “**66: DCS.**” Key the transmitter without microphone input, and adjust this parameter for a maximum deviation of ± 0.7 kHz (± 0.2 kHz) on the FM linear detector (the transceiver generates a DCS tone automatically while the menu item selected is “**66: DCS.**”).

SSB Carrier Point Adjustment

1. Tune the transceiver to the 21 MHz band in the LSB mode.
2. Connect a 50-Ohm dummy load and wattmeter to the HF/50MHz antenna jack.
3. Inject a 400 Hz tone at 1 mV level to the **MIC** jack.
4. Select menu item “**67: LSB-CP.**” Key the transmitter, and adjust the audio generator output so that the transmission power is 20 Watts.
5. Change the audio frequency to 2600 Hz. Key the transmitter, and adjust this parameter so that the transmission power is 20 W (± 2 W).
6. The adjustment for the USB carrier point is performed in the same manner as done for LSB by changing the transmission mode to USB and the menu item to “**68: USB-CP.**”

Alignment

VSWR Adjustment

1. Connect a 100-Ohm dummy load to the HF/50 MHz antenna jack.
2. Tune the transceiver to the 14 MHz band in the CW mode, and set the output power to 10 Watts.
3. Select menu item “**69: SWR2.**” Key the transceiver and press the [**A**] key to set this parameter.
4. Connect a 150-Ohm dummy load to the HF/50 MHz antenna jack, and set the output power to 10 Watts.
5. Select menu item “**70: SWR3.**” Key the transceiver and press the [**A**] key to set this parameter.

ATAS control voltage confirmation

1. Connect the DC voltmeter to the HF/50 MHz antenna jack.
2. Select menu item “**71: ATAS.**”
3. Press the [**A**] key, and confirm that the voltage is 9.0 to 10.1 Volts.
4. Press the [**B**] key, and confirm that the voltage is 7.5 to 8.5 Volts.
5. Press the [**C**] key, and confirm that the voltage is more than 10.5 Volts.

This completes the internal alignment routine for all bands. To save all settings and exit, press and hold in the [**FUNC**] key for at least one second.

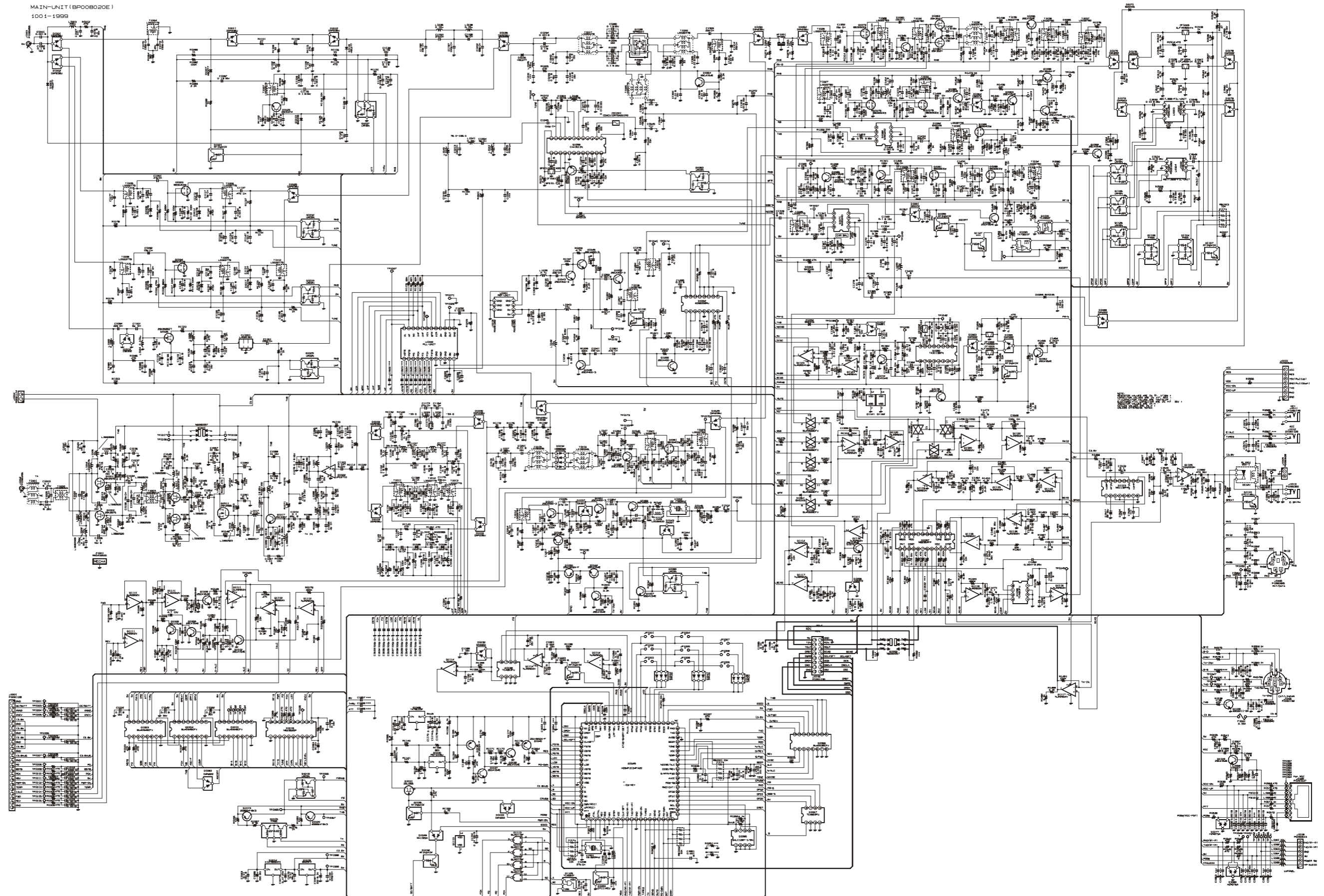

MAIN Unit (Lot 1 ~ 17)

Note:

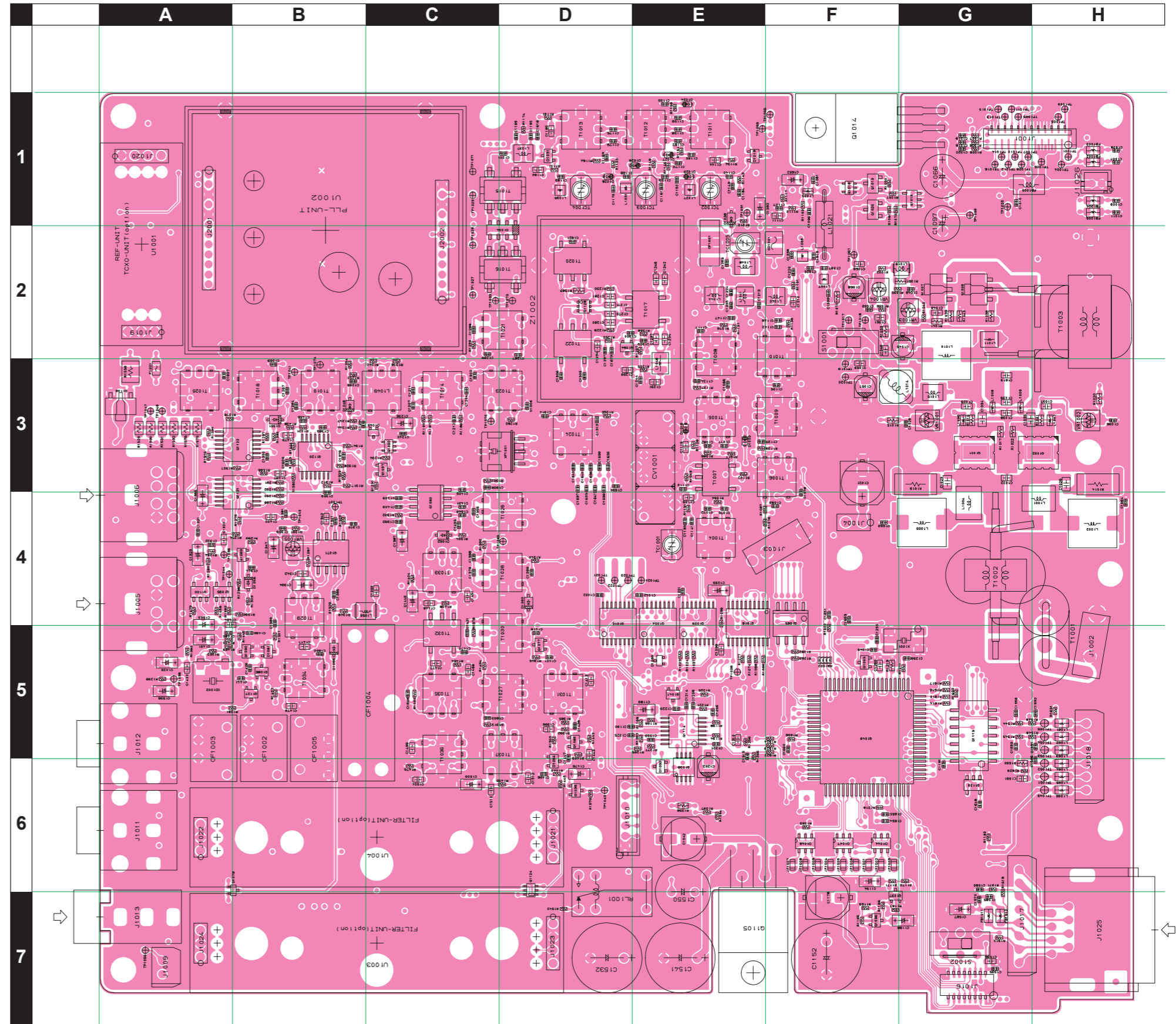
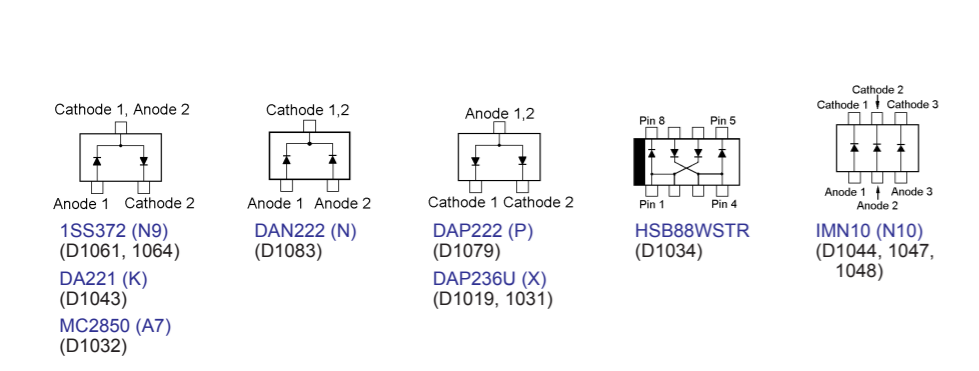
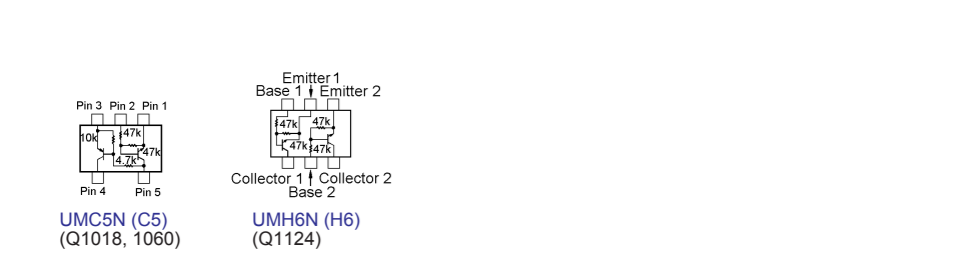
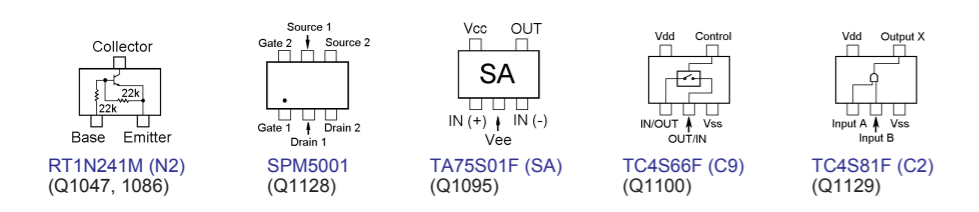
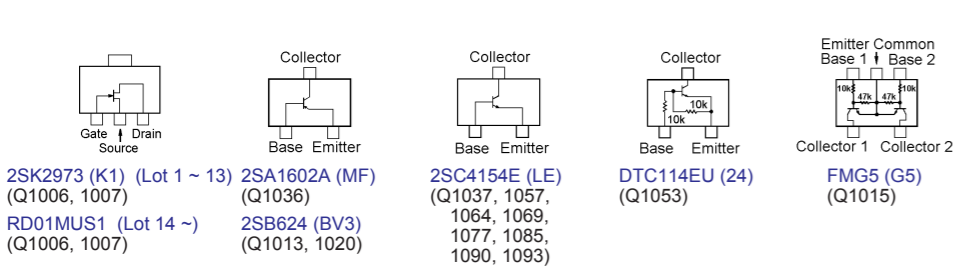
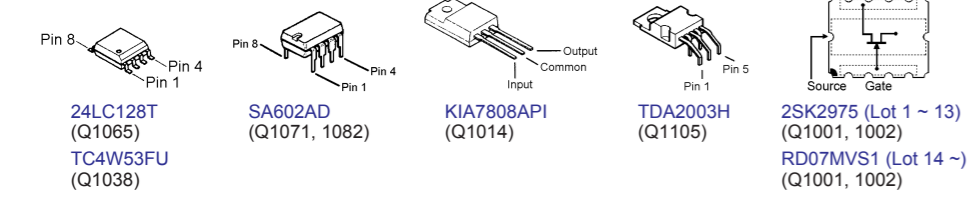
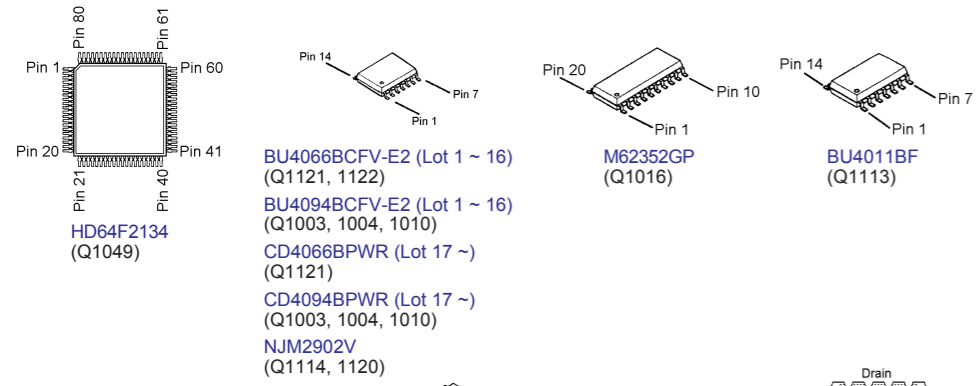

MAIN Unit (Lot 1 ~ 17)

Parts Layout (Side B)

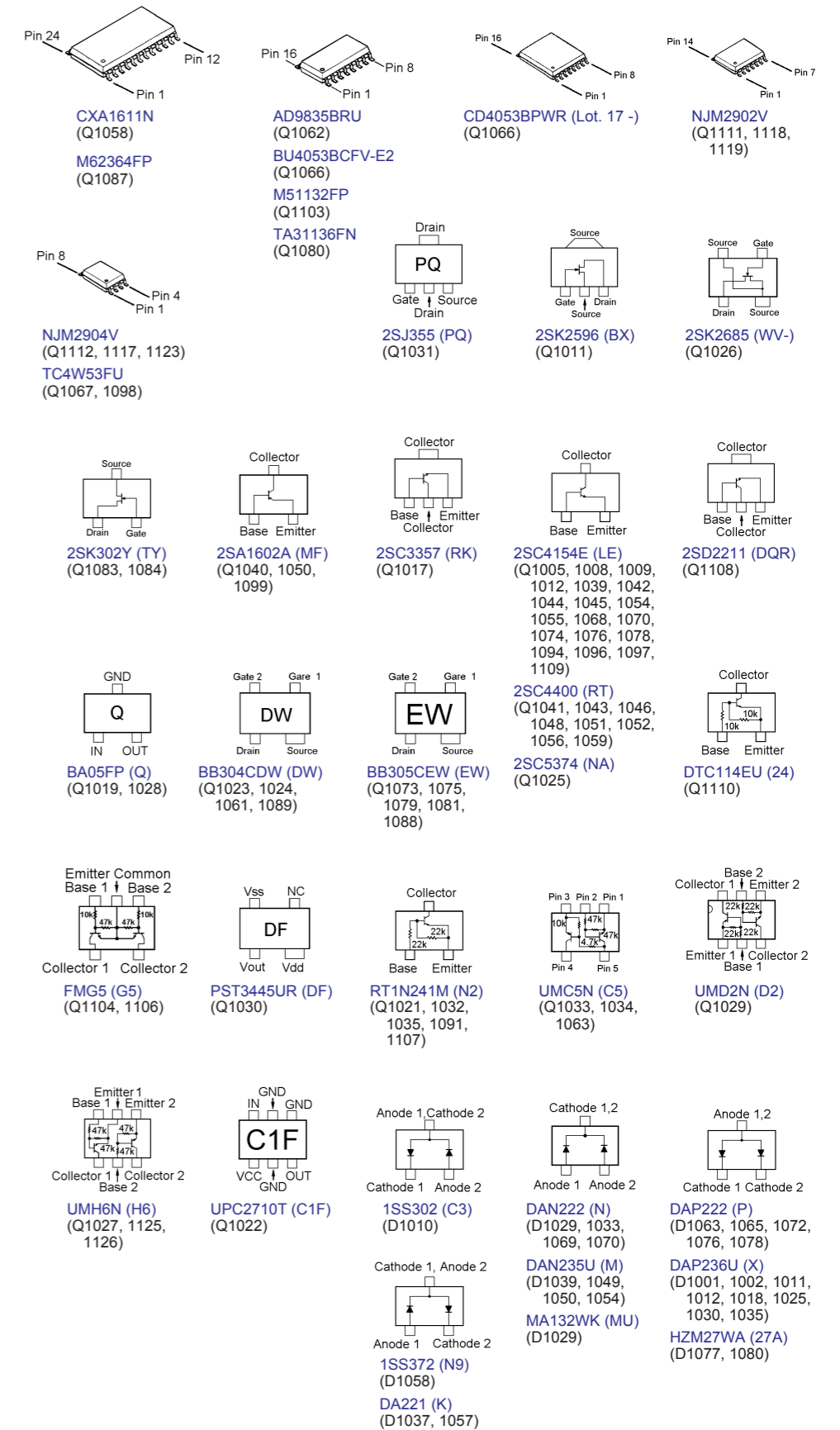
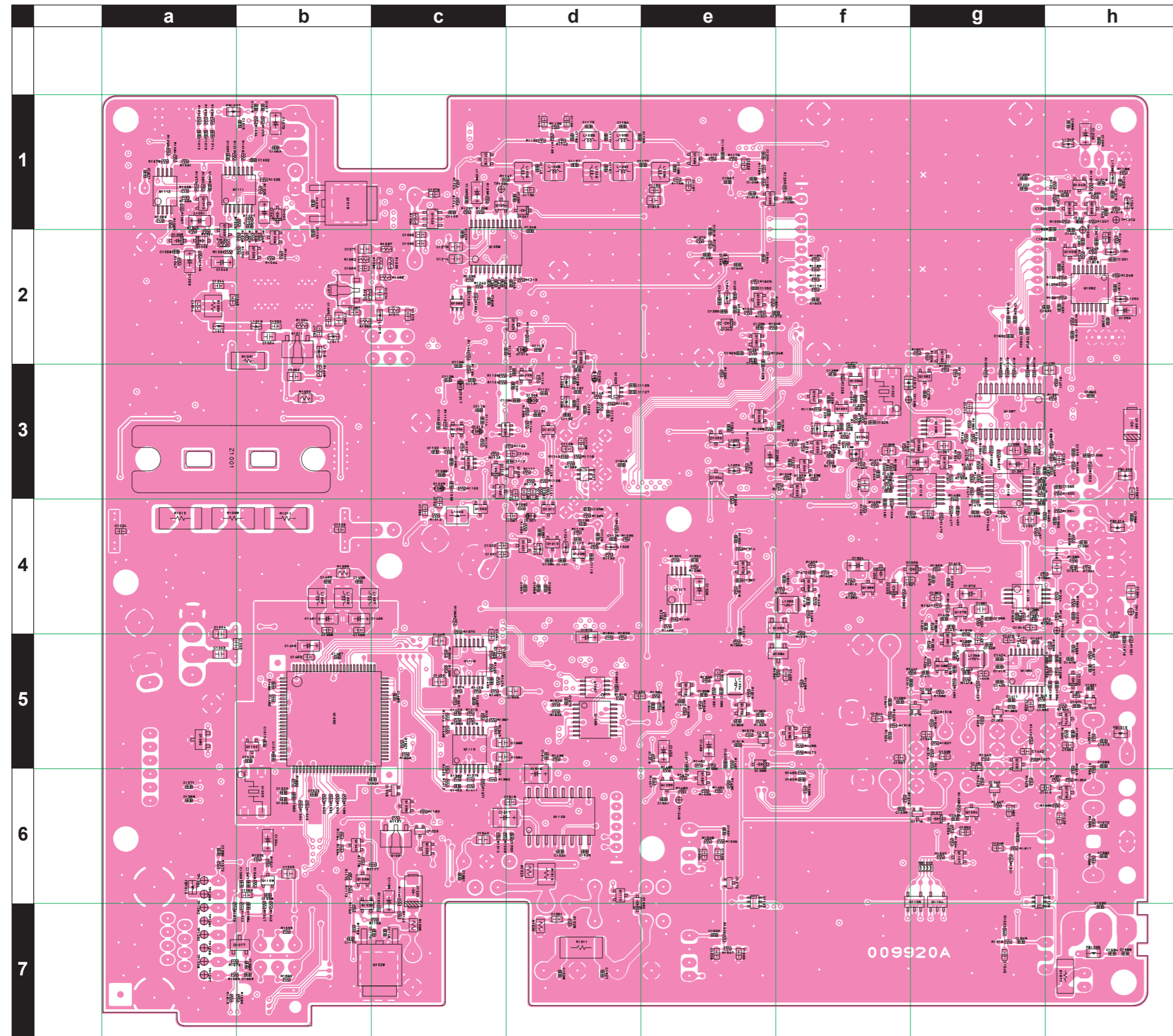

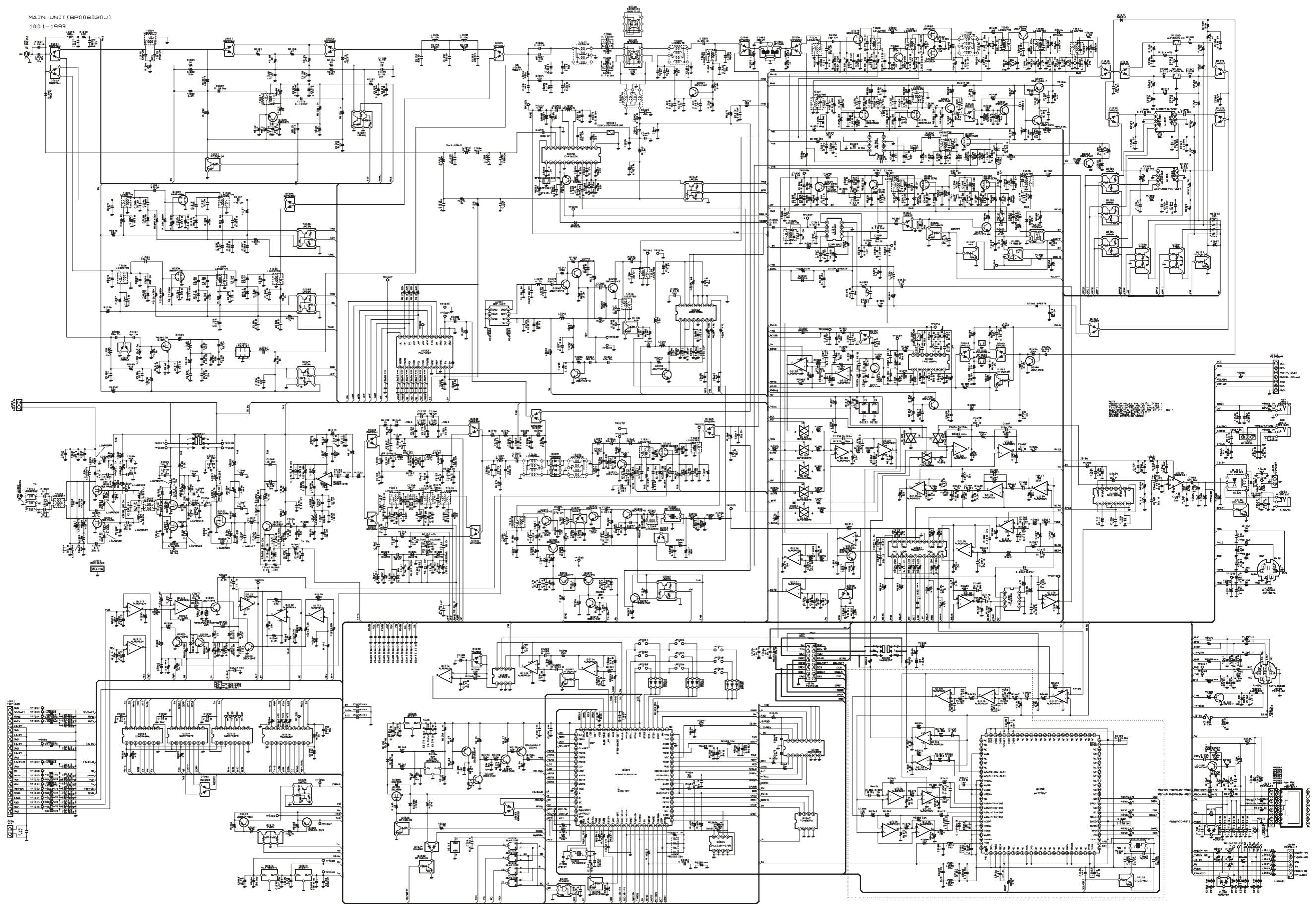

MAIN Unit (Lot 18 ~ 39)

Note:

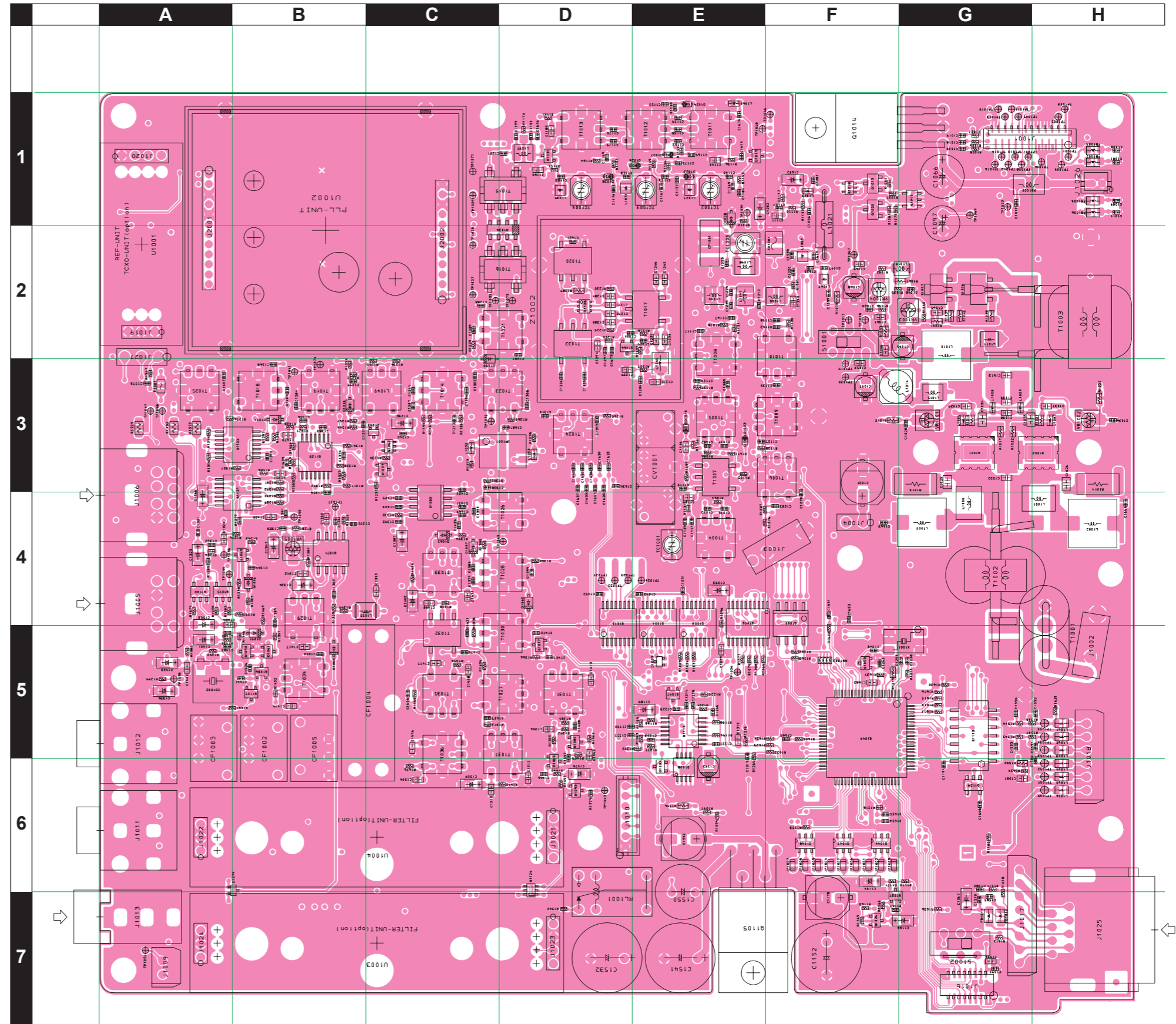
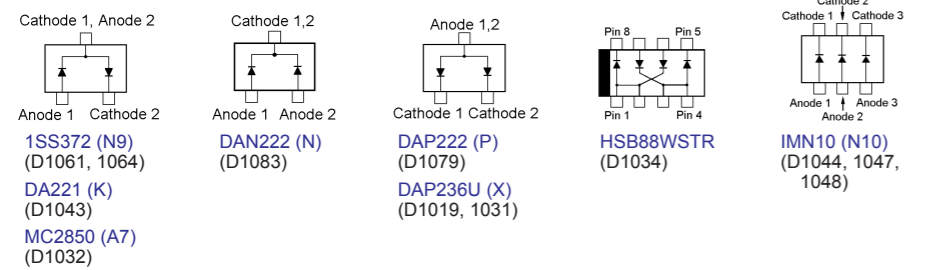
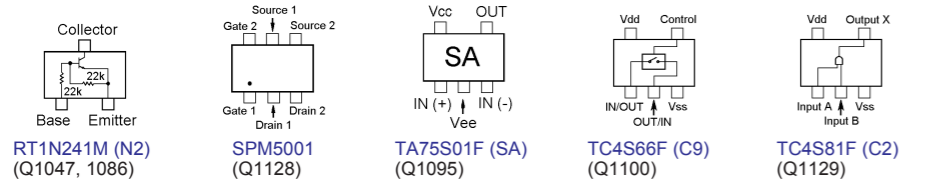
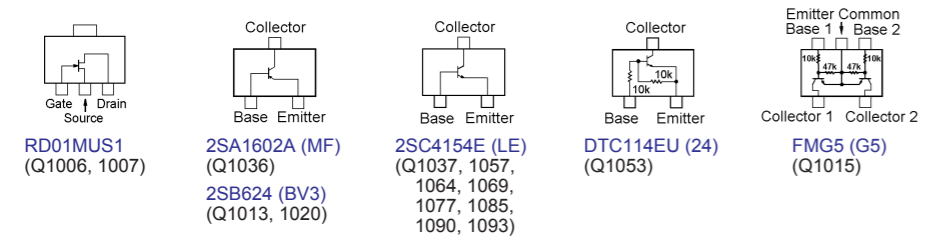
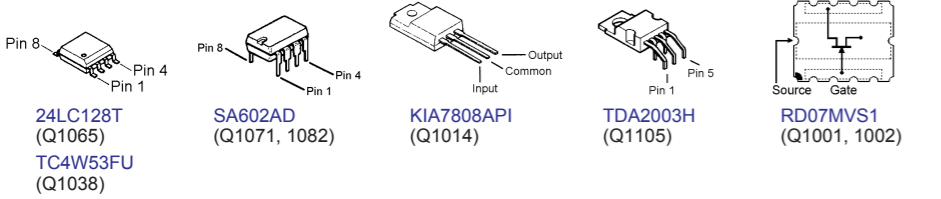
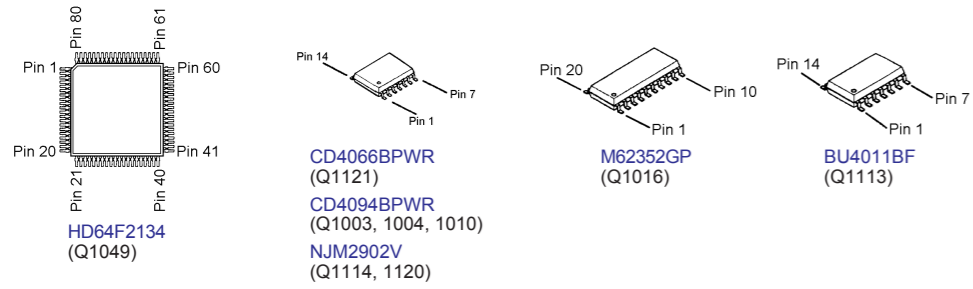

MAIN Unit (Lot 18 ~ 39)

Parts Layout (Side B)

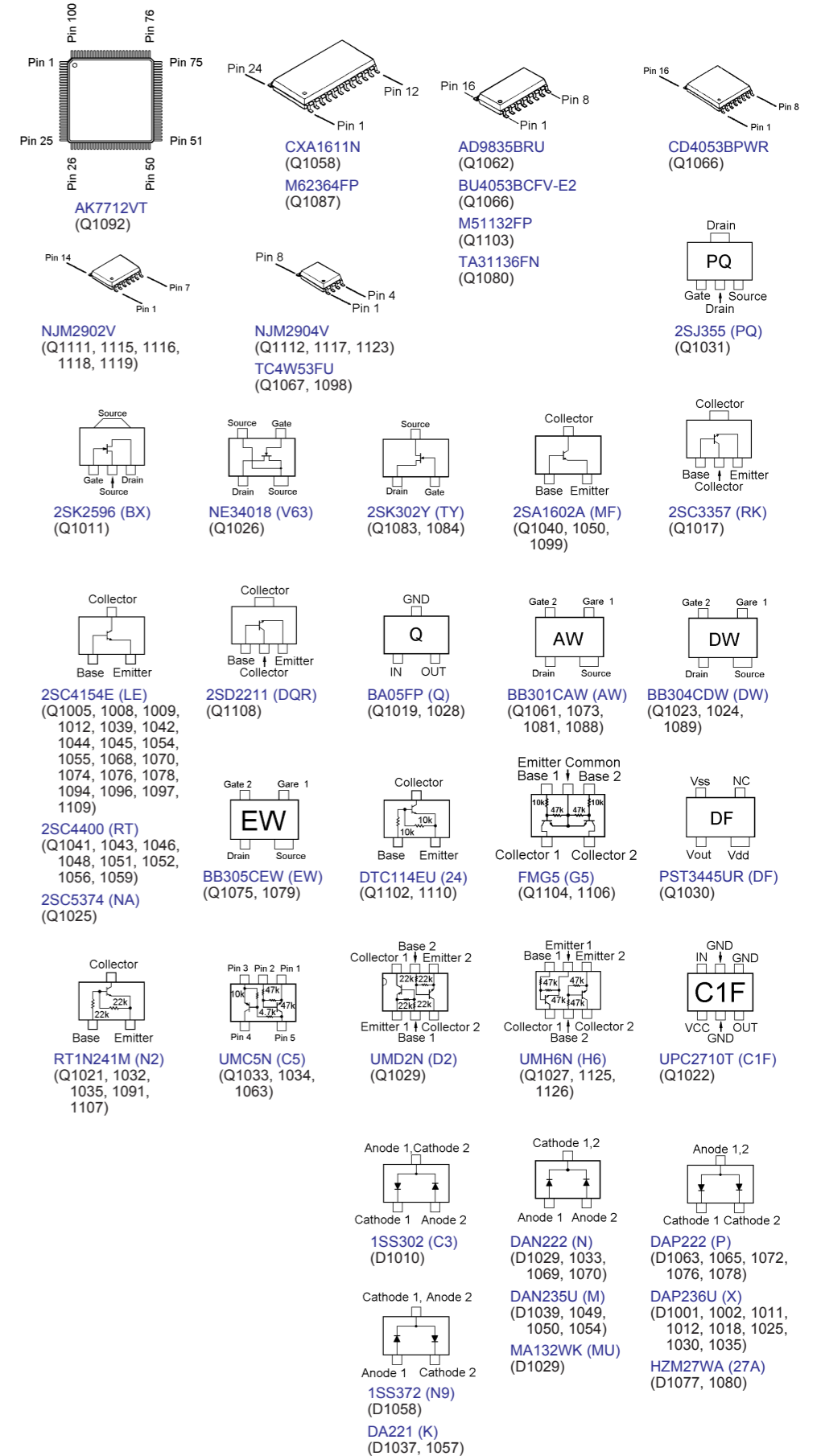
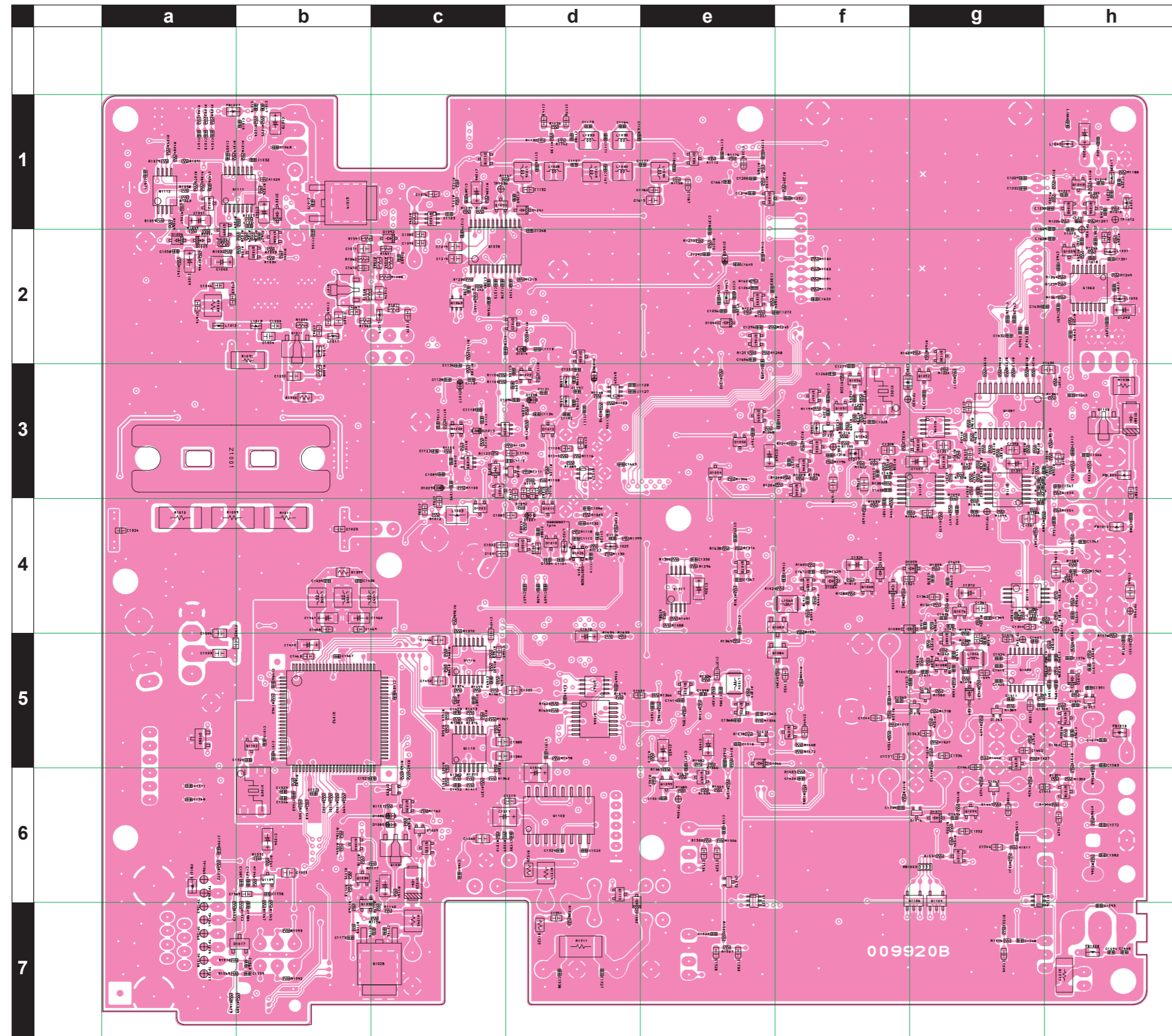

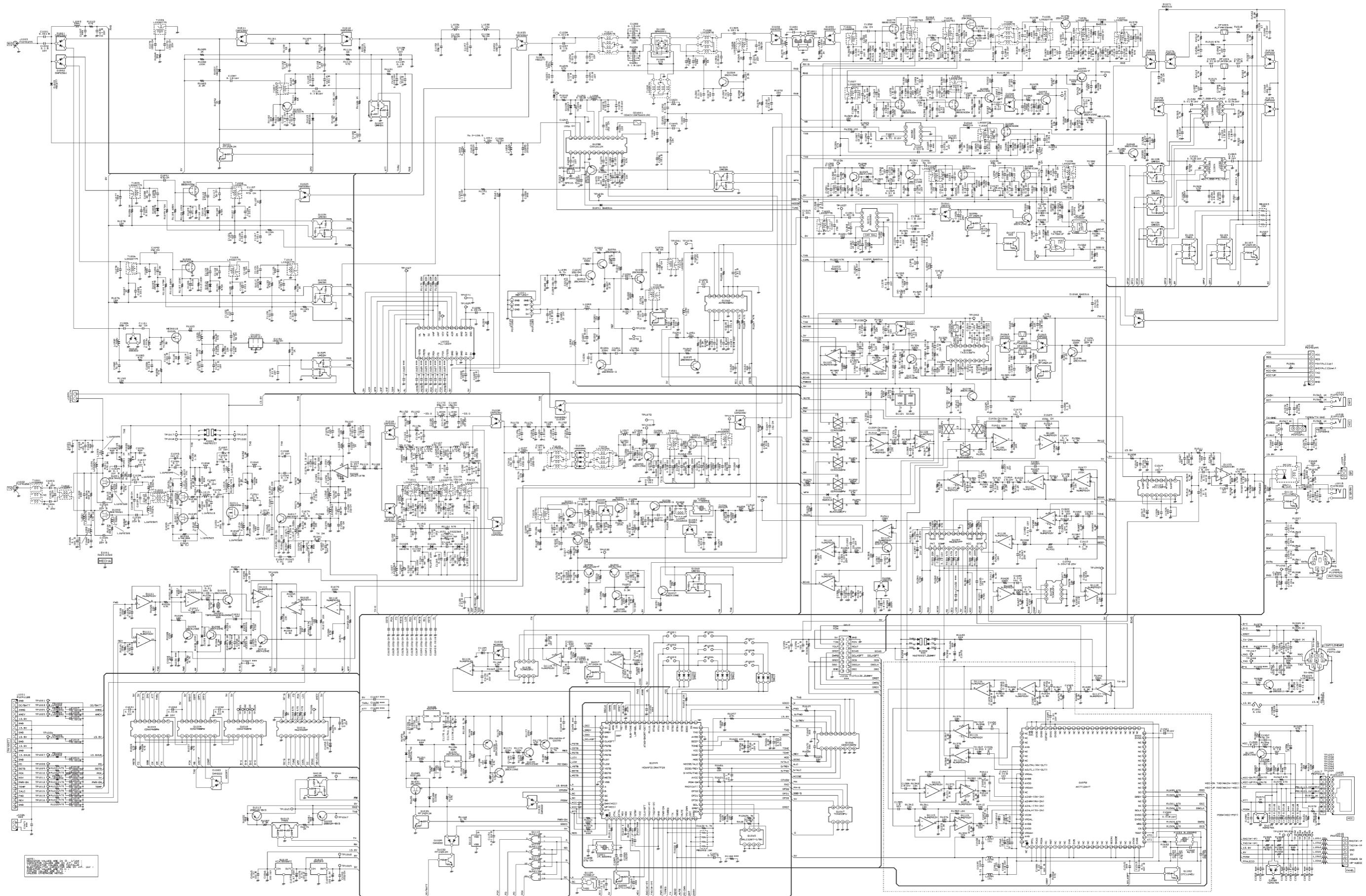

MAIN Unit (Lot 40 ~)

Note:

MAIN Unit (Lot 40 ~)

Parts Layout (Side A)

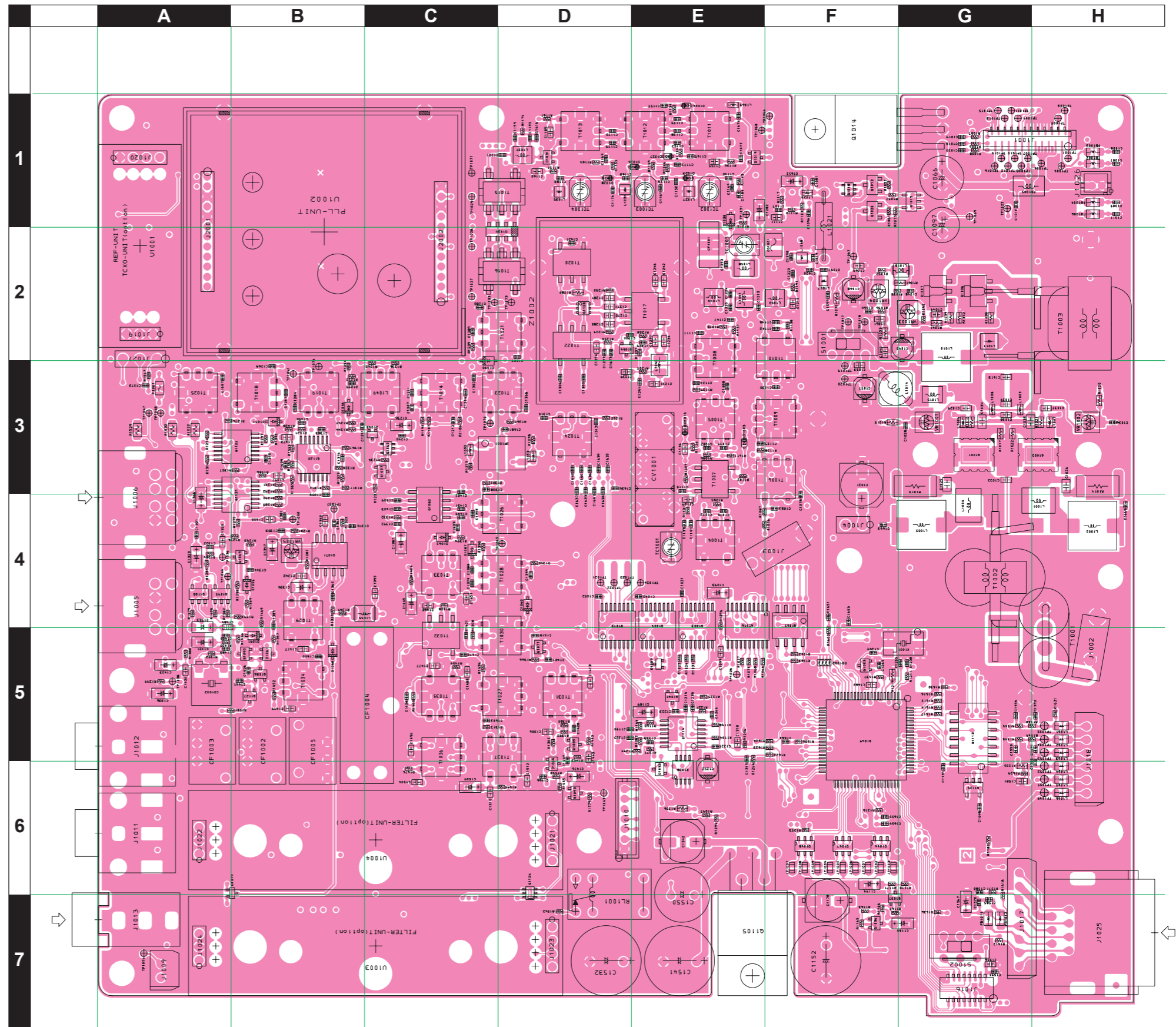
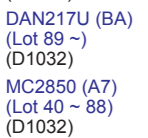
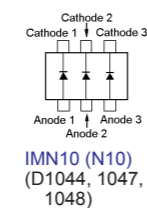
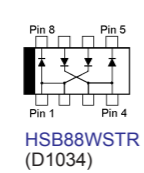
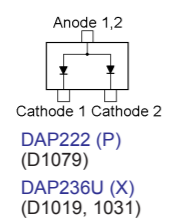
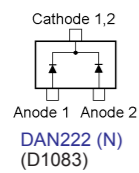
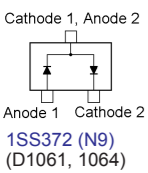
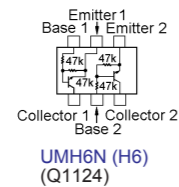
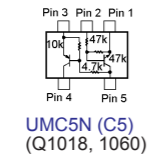
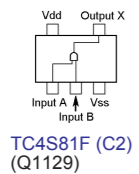
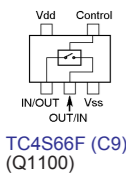
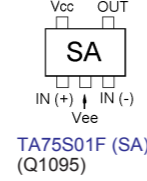
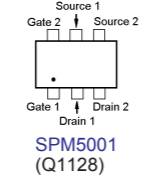
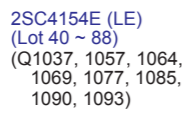
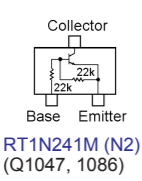
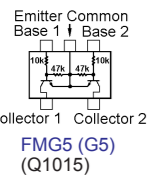
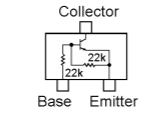
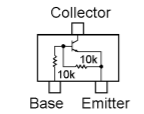
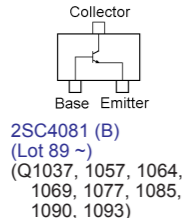
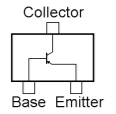
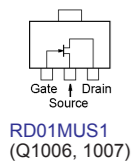
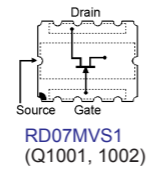
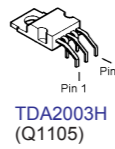
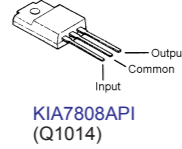
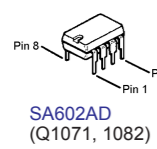
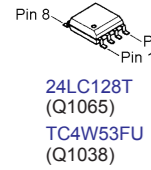
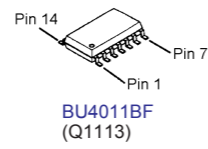
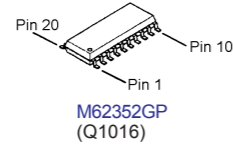
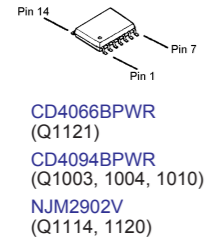
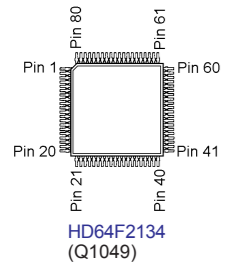

MAIN Unit (Lot 40 ~)

Parts Layout (Side B)

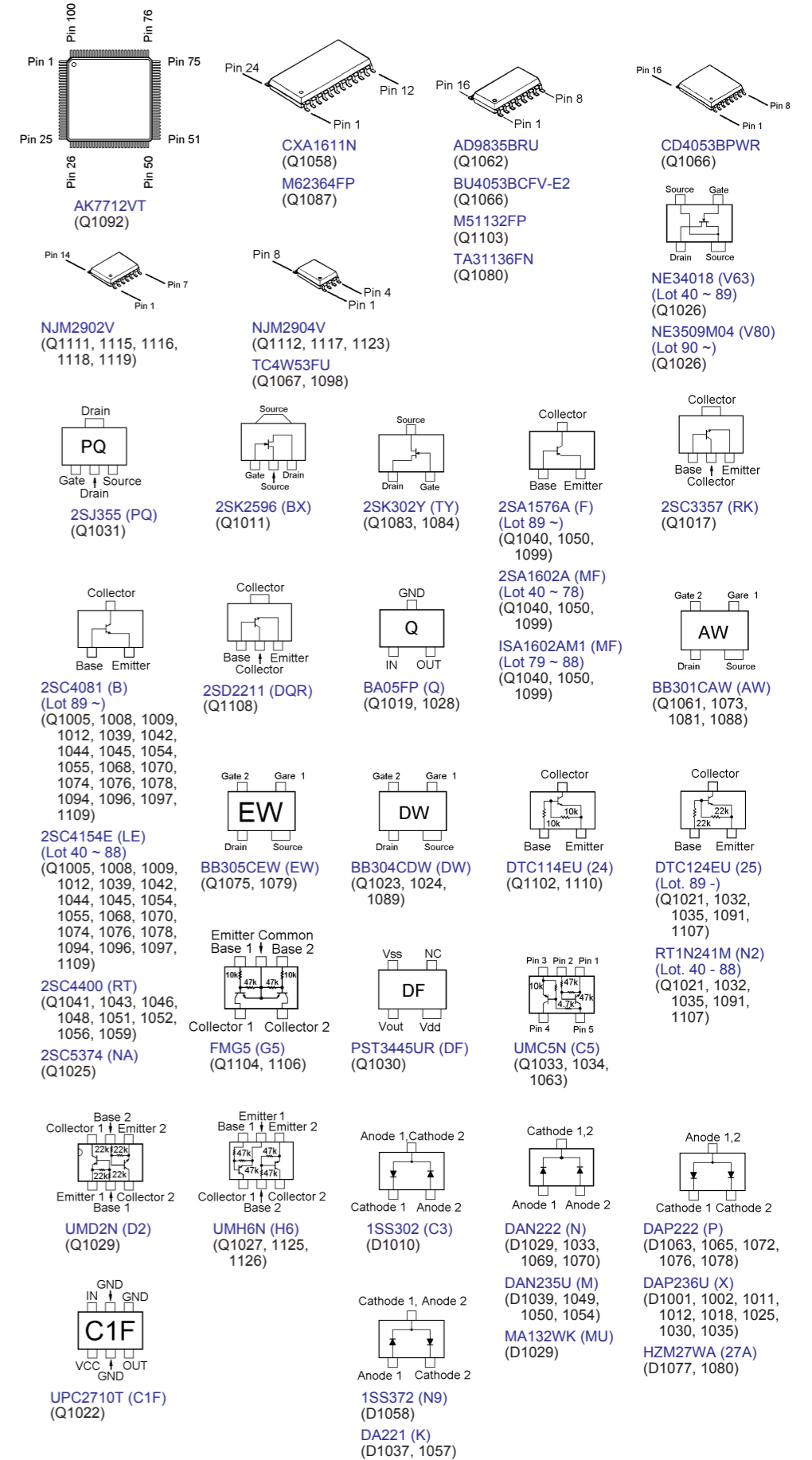
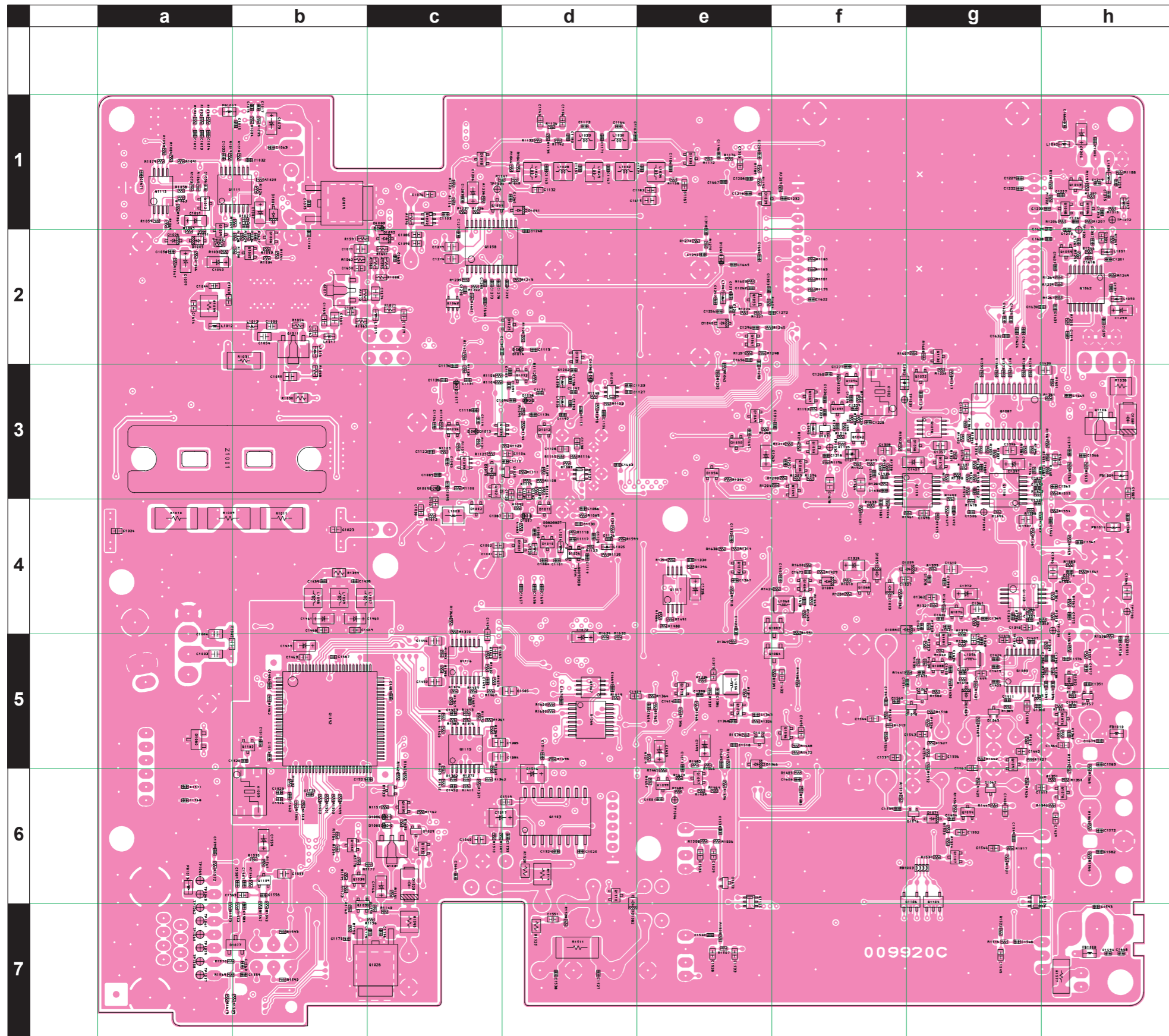

REF	DESCRIPTION	VALUE	V/W	TOL.	MFR'S DESIG	VXSTD P/N	VERS.	LOT	SIDE	LAY ADR
	PCB with Components (w/PLL-UNIT, REF-UNIT)				FT-857	CS1823004	VER. A2			
					FT-857	CS1823005	VER. A1			
					FT-857	CS1823006	VER. A2EX			
					FT-857	CS1823007	VER. A3			
					FT-857	CS1823008	VER. B1			
					FT-857	CS1823009	VER. B2			
					FT-857	CS1823010	VER. B3			
					FT-857	CS1823011	VER. C1			
					FT-857	CS1823012	VER. C2			
					FT-857	CS1823013	VER. C3			
					FT-857	CS1823014	VER. D1			
					FT-857	CS1823015	VER. D2			
					FT-857	CS1823016	VER. H1			
					FT-857	CS1823017	VER. H1			
					FT-857	CS1823018	VER. E1			
					FT-857	CS1823019	VER. E2			
					FT-857	CS1823020	VER. E3			
	PCB with Components (w/PLL-UNIT)				FT-857D	CS1833004	VER. A2			
					FT-857D	CS1833005	VER. A1			
					FT-857D	CS1833006	VER. A2EX			
					FT-857D	CS1833007	VER. A3			
					FT-857D	CS1833008	VER. B1			
					FT-857D	CS1833009	VER. B2			
					FT-857D	CS1833010	VER. B3			
					FT-857D	CS1833011	VER. C1			
					FT-857D	CS1833012	VER. C2			
					FT-857D	CS1833013	VER. C3			
					FT-857D	CS1833014	VER. D1			
					FT-857D	CS1833015	VER. D2			
					FT-857D	CS1833016	VER. H1			
					FT-857D	CS1833017	VER. H1			
					FT-857D	CS1833018	VER. E1			
					FT-857D	CS1833019	VER. E2			
					FT-857D	CS1833020	VER. E3			
	Printed Circuit Board				AH007M000	FR009920A		1-17		
					AH007M000	FR009920B		18-39		
					AH007M000	FR009920C		40-		
C 1001	CHIP CAP.	0.001uF	50V	B	GRM188B11H102KA01D	K22174821		1-	B	c4
C 1002	CHIP CAP.	0.1uF	16V	B	GRM188B11C104KA01D	K22124805		1-	B	c4
C 1003	CHIP CAP.	0.1uF	25V	B	GRM21BB11E104KA01L	K22140811		1-	B	a5
C 1004	CHIP CAP.	0.1uF	25V	B	GRM21BB11E104KA01L	K22140811		1-	B	a4
C 1005	CHIP CAP.	6pF	50V	CH	GRM1882C1H6R0DZ01D	K22174207		1-	B	a5
C 1007	CHIP CAP.	0.001uF	50V	B	UMK105B102KW-F	K22178829		1-	A	H1
C 1008	CHIP CAP.	0.001uF	50V	B	UMK105B102KW-F	K22178829		1-	A	H1
C 1009	CHIP CAP.	0.001uF	50V	B	UMK105B102KW-F	K22178829		1-	A	H1
C 1010	CHIP CAP.	0.001uF	50V	B	UMK105B102KW-F	K22178829		1-	A	G1
C 1011	CHIP CAP.	0.001uF	50V	B	UMK105B102KW-F	K22178829		1-	A	H1
C 1012	CHIP CAP.	100pF	50V	CH	UMK105CH101JV-F	K22178282		1-	B	a1
C 1013	CHIP CAP.	220pF	25V	CH	TMK105CH221JV-F	K22148246		1-	B	a1
C 1014	CHIP CAP.	100pF	50V	CH	UMK105CH101JV-F	K22178282		1-	B	a1
C 1015	CHIP CAP.	0.001uF	50V	B	UMK105B102KW-F	K22178829		1-	B	b1
C 1016	CHIP CAP.	0.001uF	50V	B	UMK105B102KW-F	K22178829		1-	B	b1
C 1017	CHIP CAP.	0.001uF	50V	B	UMK105B102KW-F	K22178829		1-	B	b1
C 1018	CHIP CAP.	0.001uF	50V	B	UMK105B102KW-F	K22178829		1-	A	G1
C 1019	CHIP CAP.	0.001uF	50V	B	UMK105B102KW-F	K22178829		1-	A	G1
C 1020	CHIP CAP.	0.001uF	50V	B	UMK105B102KW-F	K22178829		1-	A	G1
C 1021	AL.ELECTRO.CAP.	47uF	16V		EEE1CA470SP	K48120005		1-	A	F3
C 1023	CHIP CAP.	0.1uF	16V	B	GRM188B11C104KA01D	K22124805		1-	B	b4
C 1024	CHIP CAP.	0.1uF	16V	B	GRM188B11C104KA01D	K22124805		1-	B	a4
C 1025	CHIP CAP.	0.1uF	25V	B	GRM21BB11E104KA01L	K22140811		1-	A	G3
C 1026	CHIP CAP.	0.1uF	25V	B	GRM21BB11E104KA01L	K22140811		1-	A	H3
C 1029	CHIP CAP.	0.1uF	16V	B	GRM188B11C104KA01D	K22124805		1-	A	G3
C 1030	CHIP CAP.	0.1uF	16V	B	GRM188B11C104KA01D	K22124805		1-	B	c4
C 1031	CHIP CAP.	0.01uF	16V	B	GRM36B103K16PT	K22128804		1-82	A	E4
C 1031	CHIP CAP.	0.01uF	25V	B	GRM155B11E103KA01D	K22148834		83-	A	E4
C 1032	CHIP CAP.	0.001uF	50V	B	UMK105B102KW-F	K22178829		1-	B	b1
C 1033	CHIP CAP.	0.001uF	50V	B	UMK105B102KW-F	K22178829		1-	B	a1
C 1034	CHIP CAP.	0.1uF	25V	B	GRM21BB11E104KA01L	K22140811		1-	A	G3
C 1035	CHIP CAP.	0.1uF	25V	B	GRM21BB11E104KA01L	K22140811		1-	A	G3
C 1037	CHIP CAP.	0.1uF	16V	B	GRM188B11C104KA01D	K22124805		1-	A	H3
C 1038	CHIP CAP.	12pF	50V	CH	GRM1882C1H120JA01D	K22174213		1-	A	G3
C 1039	CHIP CAP.	22pF	50V	CH	GRM1882C1H220JA01D	K22174219		1-13	A	G3
C 1039	CHIP CAP.	1pF	50V	CK	GRM1884C1H1R0CZ01D	K22174202		43-	A	G3

MAIN Unit

Parts List

REF	DESCRIPTION	VALUE	V/W	TOL.	MFR'S DESIG	VXSTD P/N	VERS.	LOT	SIDE	LAY ADR
C 1040	CHIP TA.CAP.	1uF	16V		TEESVA1C105M8R	K78120009		1-	B	a2
C 1042	CHIP CAP.	0.01uF	16V	B	GRM36B103K16PT	K22128804		1-82	A	E4
C 1042	CHIP CAP.	0.01uF	25V	B	GRM155B11E103KA01D	K22148834		83-	A	E4
C 1043	CHIP CAP.	10pF	50V	CH	GRM1882C1H100JA01D	K22174211		1-	B	a2
C 1044	CHIP CAP.	0.01uF	50V	B	GRM188B11H103KA01D	K22174823		1-	B	a2
C 1045	AL.ELECTRO.CAP.	10uF	16V		RV2-16V100MB55U-R	K48120014		1-	A	G2
C 1046	CHIP CAP.	0.1uF	16V	B	GRM188B11C104KA01D	K22124805		1-	A	F2
C 1047	CHIP TA.CAP.	4.7uF	10V		TEESVA1A475M8R	K78100022		1-78	B	b1
C 1047	CHIP TA.CAP.	0.22uF	35V		TEESVA1V224M8R	K78160027		79-	B	b1
C 1049	CHIP CAP.	0.1uF	16V	B	GRM188B11C104KA01D	K22124805		1-	A	G2
C 1050	CHIP CAP.	8pF	50V	CH	GRM1882C1H8R0DZ01D	K22174209		1-	B	b2
C 1051	CHIP TA.CAP.	1uF	16V		TEESVA1C105M8R	K78120009		1-	B	a1
C 1052	CHIP CAP.	0.01uF	16V	B	GRM36B103K16PT	K22128804		1-82	A	D4
C 1052	CHIP CAP.	0.01uF	25V	B	GRM155B11E103KA01D	K22148834		83-	A	D4
C 1053	CHIP CAP.	0.1uF	16V	B	GRM188B11C104KA01D	K22124805		1-	A	F3
C 1054	CHIP CAP.	0.1uF	25V	B	GRM21BB11E104KA01L	K22140811		1-	B	b2
C 1055	CHIP CAP.	0.1uF	25V	B	GRM21BB11E104KA01L	K22140811		1-	B	b3
C 1056	CHIP CAP.	0.1uF	10V	B	GRM155B11A104KA01D	K22108802		1-	B	a1
C 1057	AL.ELECTRO.CAP.	10uF	16V		RV2-16V100MB55U-R	K48120014		1-	A	F3
C 1058	CHIP CAP.	0.01uF	16V	B	GRM36B103K16PT	K22128804		1-82	B	a2
C 1058	CHIP CAP.	0.01uF	25V	B	GRM155B11E103KA01D	K22148834		83-	B	a2
C 1059	CHIP TA.CAP.	10uF	10V		TEESVA1A106M8R	K78100028		1-	B	a2
C 1061	CHIP CAP.	0.1uF	16V	B	GRM188B11C104KA01D	K22124805		1-	A	F2
C 1063	CHIP CAP.	0.01uF	16V	B	GRM36B103K16PT	K22128804		1-82	B	b1
C 1063	CHIP CAP.	0.01uF	25V	B	GRM155B11E103KA01D	K22148834		83-	B	b1
C 1064	CHIP CAP.	0.1uF	25V	B	GRM21BB11E104KA01L	K22140811		1-	B	b2
C 1065	CHIP CAP.	10pF	50V	CH	GRM1882C1H100JA01D	K22174211		1-	B	b2
C 1066	AL.ELECTRO.CAP.	100uF	16V		RC2-16V101MF1#	K40129038		1-	A	G1
C 1067	CHIP CAP.	0.01uF	50V	B	GRM188B11H103KA01D	K22174823		1-	B	b2
C 1068	AL.ELECTRO.CAP.	10uF	16V		RV2-16V100MB55U-R	K48120014		1-	A	F2
C 1069	CHIP CAP.	0.1uF	16V	B	GRM188B11C104KA01D	K22124805		1-	A	F2
C 1070	CHIP CAP.	120pF	50V	CH	UMK105CH121JV-F	K22178284		1-	A	E4
C 1071	CHIP CAP.	0.1uF	25V	B	GRM21BB11E104KA01L	K22140811		1-	B	b2
C 1072	CHIP CAP.	150pF	25V	CH	TMK105CH151JV-F	K22148242		1-	A	E4
C 1073	CHIP TA.CAP.	0.47uF	25V		TEESVA1E474M8R	K78140009		1-	B	b1
C 1074	CHIP CAP.	0.1uF	25V	B	GRM21BB11E104KA01L	K22140811		1-	B	c2
C 1075	CHIP CAP.	0.01uF	16V	B	GRM36B103K16PT	K22128804		1-82	B	b1
C 1075	CHIP CAP.	0.01uF	25V	B	GRM155B11E103KA01D	K22148834		83-	B	b1
C 1076	CHIP CAP.	0.1uF	16V	B	GRM188B11C104KA01D	K22124805		1-	B	c1
C 1079	CHIP CAP.	0.1uF	16V	B	GRM188B11C104KA01D	K22124805		1-	B	c2
C 1080	CHIP CAP.	7pF	50V	CH	UMK105CH070DV-F	K22178255		1-	B	d4
C 1081	CHIP CAP.	0.001uF	50V	B	UMK105B102KW-F	K22178829		1-	A	F1
C 1082	CHIP CAP.	0.001uF	50V	B	UMK105B102KW-F	K22178829		1-	A	E3
C 1083	CHIP CAP.	0.001uF	50V	B	UMK105B102KW-F	K22178829		1-	A	F4
C 1084	CHIP CAP.	22pF	50V	CH	UMK105CH220JV-F	K22178266		1-	B	d4
C 1085	CHIP CAP.	0.001uF	50V	B	GRM188B11H102KA01D	K22174821		1-	B	c2
C 1086	CHIP CAP.	0.001uF	50V	B	UMK105B102KW-F	K22178829		1-	B	d4
C 1087	CHIP CAP.	0.1uF	16V	B	GRM188B11C104KA01D	K22124805		1-	B	d4
C 1088	CHIP CAP.	2pF	50V	CK	UMK105CK020CV-F	K22178250		1-	A	E3
C 1090	CHIP CAP.	0.1uF	16V	B	GRM188B11C104KA01D	K22124805		1-78	B	c2
C 1090	CHIP CAP.	0.001uF	50V	B	GRM188B11H102KA01D	K22174821		79-	B	c2
C 1091	CHIP CAP.	47pF	50V	CH	UMK105CH470JV-F	K22178274		1-	B	d3
C 1092	CHIP CAP.	15pF	50V	CH	UMK105CH150JV-F	K22178262		1-	B	c3
C 1093	CHIP TA.CAP.	10uF	10V		TEESVA1A106M8R	K78100028		1-	A	E4
C 1094	CHIP CAP.	470pF	50V	B	UMK105B471KW-F	K22178825		1-	B	d3
C 1095	CHIP CAP.	33pF	50V	CH	UMK105CH330JV-F	K22178270		1-	B	c3
C 1096	CHIP CAP.	0.01uF	16V	B	GRM36B103K16PT	K22128804		1-82	A	F1
C 1096	CHIP CAP.	0.01uF	25V	B	GRM155B11E103KA01D	K22148834		83-	A	F1
C 1097	AL.ELECTRO.CAP.	100uF	6.3V		RC2-6V101ME1#-T58	K46080006		1-	A	G2
C 1099	CHIP CAP.	0.1uF	16V	B	GRM188B11C104KA01D	K22124805		1-	A	E5
C 1100	CHIP CAP.	100pF	50V	CH	UMK105CH101JV-F	K22178282		1-	B	b2
C 1101	CHIP CAP.	6pF	50V	CH	UMK105CH060DV-F	K22178254		1-56	B	d4
C 1101	CHIP CAP.	7pF	50V	CH	UMK105CH070DV-F	K22178255		57-	B	d4
C 1102	CHIP CAP.	0.1uF	16V	B	GRM188B11C104KA01D	K22124805		1-	B	d3
C 1103	CHIP CAP.	0.047uF	10V	BJ	LMK105BJ473KV-F	K22108805		1-78	B	c1
C 1103	CHIP CAP.	0.01uF	25V	B	GRM155B11E103KA01D	K22148834		79-	B	c1
C 1104	CHIP CAP.	0.1uF	16V	B	GRM188B11C104KA01D	K22124805		1-	B	d3
C 1105	CHIP CAP.	0.001uF	50V	B	UMK105B102KW-F	K22178829		1-	B	d3
C 1106	CHIP CAP.	0.001uF	50V	B	UMK105B102KW-F	K22178829		1-	B	c3
C 1107	CHIP CAP.	0.001uF	50V	B	UMK105B102KW-F	K22178829		1-	A	F1
C 1108	CHIP CAP.	0.1uF	16V	B	GRM188B11C104KA01D	K22124805		1-	B	d3
C 1109	CHIP CAP.	0.1uF	16V	B	GRM188B11C104KA01D	K22124805		1-	A	E4
C 1110	CHIP CAP.	0.001uF	50V	B	UMK105B102KW-F	K22178829		1-	B	d3

MAIN Unit

Parts List

REF	DESCRIPTION	VALUE	V/W	TOL.	MFR'S DESIG	VXSTD P/N		LOT	SIDE	LAY ADR
C 1111	CHIP CAP.	0.1uF	16V	B	GRM188B11C104KA01D	K22124805		1-	A	F1
C 1112	CHIP CAP.	0.001uF	50V	B	UMK105B102KW-F	K22178829		1-	B	d4
C 1113	CHIP CAP.	470pF	50V	B	UMK105B471KW-F	K22178825		1-	B	d2
C 1114	CHIP CAP.	33pF	50V	CH	UMK105CH330JV-F	K22178270		1-	B	c3
C 1115	CHIP CAP.	0.001uF	50V	B	UMK105B102KW-F	K22178829		1-	A	E3
C 1116	CHIP CAP.	0.1uF	16V	B	GRM188B11C104KA01D	K22124805		1-	A	E3
C 1117	CHIP CAP.	5pF	50V	CH	UMK105CH050CV-F	K22178253		1-	A	E2
C 1118	CHIP CAP.	2pF	50V	CK	UMK105CK020CV-F	K22178250		1-	B	c3
C 1119	CHIP CAP.	0.001uF	50V	B	UMK105B102KW-F	K22178829		1-	B	d4
C 1120	CHIP CAP.	0.1uF	16V	B	GRM188B11C104KA01D	K22124805		1-	B	d3
C 1121	CHIP CAP.	0.01uF	16V	B	GRM36B103K16PT	K22128804		1-82	B	d3
C 1121	CHIP CAP.	0.01uF	25V	B	GRM155B11E103KA01D	K22148834		83-	B	d3
C 1122	CHIP CAP.	0.01uF	16V	B	GRM36B103K16PT	K22128804		1-82	B	c3
C 1122	CHIP CAP.	0.01uF	25V	B	GRM155B11E103KA01D	K22148834		83-	B	c3
C 1123	CHIP CAP.	0.001uF	50V	B	UMK105B102KW-F	K22178829		1-	B	d3
C 1124	CHIP CAP.	0.001uF	50V	B	UMK105B102KW-F	K22178829		1-	A	E3
C 1125	CHIP CAP.	0.001uF	50V	B	UMK105B102KW-F	K22178829		1-	A	E3
C 1126	CHIP CAP.	0.001uF	50V	B	UMK105B102KW-F	K22178829		1-	B	d4
C 1127	CHIP CAP.	0.01uF	16V	B	GRM36B103K16PT	K22128804		1-82	B	d3
C 1127	CHIP CAP.	0.01uF	25V	B	GRM155B11E103KA01D	K22148834		83-	B	d3
C 1128	CHIP CAP.	7pF	50V	CH	UMK105CH070DV-F	K22178255		1-	B	c3
C 1129	CHIP CAP.	4pF	50V	CH	UMK105CH040CV-F	K22178252		1-	B	d4
C 1131	CHIP CAP.	33pF	50V	CH	UMK105CH330JV-F	K22178270		1-	B	c3
C 1132	CHIP CAP.	0.1uF	16V	B	GRM188B11C104KA01D	K22124805		1-	B	d1
C 1133	CHIP CAP.	0.01uF	16V	B	GRM36B103K16PT	K22128804		1-82	A	E4
C 1133	CHIP CAP.	0.01uF	25V	B	GRM155B11E103KA01D	K22148834		83-	A	E4
C 1134	CHIP CAP.	0.001uF	50V	B	UMK105B102KW-F	K22178829		1-	B	d3
C 1136	CHIP CAP.	0.001uF	50V	B	UMK105B102KW-F	K22178829		1-	B	c3
C 1137	CHIP CAP.	47pF	50V	CH	UMK105CH470JV-F	K22178274		1-	B	c2
C 1138	CHIP CAP.	0.1uF	16V	B	GRM188B11C104KA01D	K22124805		1-	B	d3
C 1139	CHIP CAP.	0.1uF	16V	B	GRM188B11C104KA01D	K22124805		1-	B	d3
C 1140	CHIP CAP.	2pF	50V	CK	UMK105CK020CV-F	K22178250		1-	A	E1
C 1141	CHIP CAP.	0.001uF	50V	B	UMK105B102KW-F	K22178829		1-	A	E4
C 1142	CHIP CAP.	0.001uF	50V	B	UMK105B102KW-F	K22178829		1-	A	F2
C 1143	CHIP CAP.	0.1uF	16V	B	GRM188B11C104KA01D	K22124805		1-	B	d1
C 1144	CHIP CAP.	0.1uF	16V	B	GRM188B11C104KA01D	K22124805		1-	A	E1
C 1145	CHIP CAP.	100pF	50V	CH	UMK105CH101JV-F	K22178282		1-	B	d1
C 1146	CHIP CAP.	0.01uF	16V	B	GRM36B103K16PT	K22128804		1-82	B	c7
C 1146	CHIP CAP.	0.01uF	25V	B	GRM155B11E103KA01D	K22148834		83-	B	c7
C 1147	CHIP CAP.	0.001uF	50V	B	UMK105B102KW-F	K22178829		1-	A	E2
C 1148	CHIP CAP.	0.001uF	50V	B	UMK105B102KW-F	K22178829		1-	A	F2
C 1150	CHIP CAP.	6pF	50V	CH	UMK105CH060DV-F	K22178254		1-	A	E1
C 1151	CHIP CAP.	100pF	50V	CH	UMK105CH101JV-F	K22178282		1-	B	d3
C 1152	AL.ELECTRO.CAP.	1000uF	16V		RE3-16V102MH3#	K40129096		1-	A	F7
C 1153	CHIP CAP.	1pF	50V	CK	UMK105CK010CV-F	K22178248		1-	A	E1
C 1154	CHIP CAP.	0.01uF	16V	B	GRM36B103K16PT	K22128804		1-82	B	d3
C 1154	CHIP CAP.	0.01uF	25V	B	GRM155B11E103KA01D	K22148834		83-	B	d3
C 1155	CHIP CAP.	33pF	50V	CH	UMK105CH330JV-F	K22178270		1-	A	E1
C 1156	CHIP CAP.	0.1uF	16V	B	GRM188B11C104KA01D	K22124805		1-	B	d1
C 1157	CHIP CAP.	27pF	50V	CH	UMK105CH270JV-F	K22178268		1-	B	d1
C 1158	CHIP CAP.	2pF	50V	CK	UMK105CK020CV-F	K22178250		1-	A	E1
C 1159	CHIP CAP.	3pF	50V	CJ	UMK105CJ030CV-F	K22178251		1-2	A	E1
C 1159	CHIP CAP.	1pF	50V	CK	UMK105CK010CV-F	K22178248	W/ CE	3-17	A	E1
C 1159	CHIP CAP.	3pF	50V	CJ	UMK105CJ030CV-F	K22178251	W/O CE	3-17	A	E1
C 1159	CHIP CAP.	1pF	50V	CK	UMK105CK010CV-F	K22178248		18-	A	E1
C 1160	CHIP CAP.	0.1uF	16V	B	GRM188B11C104KA01D	K22124805		1-	A	D1
C 1161	CHIP CAP.	5pF	50V	CH	UMK105CH050CV-F	K22178253		1-28	A	E1
C 1161	CHIP CAP.	6pF	50V	CH	UMK105CH060DV-F	K22178254		29-	A	E1
C 1162	CHIP CAP.	3pF	50V	CJ	UMK105CJ030CV-F	K22178251		1-	A	E1
C 1163	CHIP CAP.	100pF	50V	CH	UMK105CH101JV-F	K22178282		1-6	B	d1
C 1163	CHIP CAP.	180pF	25V	CH	TMK105CH181JV-F	K22148244		7-78	B	d1
C 1163	CHIP CAP.	100pF	50V	CH	UMK105CH101JV-F	K22178282		79-	B	d1
C 1164	CHIP CAP.	9pF	50V	CH	UMK105CH090DV-F	K22178257		1-6	B	d1
C 1164	CHIP CAP.	15pF	50V	CH	UMK105CH150JV-F	K22178262		7-78	B	d1
C 1164	CHIP CAP.	7pF	50V	CH	UMK105CH070DV-F	K22178255		79-	B	d1
C 1165	CHIP CAP.	33pF	50V	CH	UMK105CH330JV-F	K22178270		1-	A	E1
C 1166	CHIP TA.CAP.	1uF	16V		TEESVA1C105M8R	K78120009		1-	B	c6
C 1167	CHIP CAP.	220pF	25V	CH	TMK105CH221JV-F	K22148246		1-	B	d1
C 1168	CHIP CAP.	0.5pF	50V	CK	UMK105CK0R5CV-F	K22178247		1-	A	D1
C 1169	CHIP CAP.	0.001uF	50V	B	UMK105B102KW-F	K22178829		1-	A	D1
C 1170	CHIP CAP.	0.001uF	50V	B	UMK105B102KW-F	K22178829		1-	B	b7
C 1171	CHIP CAP.	150pF	25V	CH	TMK105CH151JV-F	K22148242		1-6	B	d1
C 1171	CHIP CAP.	270pF	25V	CH	GRM36CH271J25PT	K22148248		7-17	B	d1

MAIN Unit

Parts List

REF	DESCRIPTION	VALUE	V/W	TOL.	MFR'S DESIG	VXSTD P/N	VERS.	LOT	SIDE	LAY ADR
C 1171	CHIP CAP.	270pF	50V	B	UMK105B271KW-F	K22178822		18-78	B	d1
C 1171	CHIP CAP.	220pF	25V	CH	TMK105CH221JV-F	K22148246		79-	B	d1
C 1172	CHIP CAP.	0.001uF	50V	B	UMK105B102KW-F	K22178829		1-	A	E1
C 1173	CHIP CAP.	27pF	50V	CH	UMK105CH270JV-F	K22178268		1-6	B	d1
C 1173	CHIP CAP.	39pF	50V	CH	UMK105CH390JV-F	K22178272		7-78	B	d1
C 1173	CHIP CAP.	15pF	50V	CH	UMK105CH150JV-F	K22178262		79-	B	d1
C 1174	CHIP CAP.	0.01uF	16V	B	GRM36B103K16PT	K22128804		1-82	B	c7
C 1174	CHIP CAP.	0.01uF	25V	B	GRM155B11E103KA01D	K22148834		83-	B	c7
C 1175	CHIP CAP.	10pF	50V	CH	UMK105CH100DV-F	K22178258		1-	A	D1
C 1176	CHIP CAP.	4pF	50V	CH	UMK105CH040CV-F	K22178252		1-28	A	D1
C 1176	CHIP CAP.	6pF	50V	CH	UMK105CH060DV-F	K22178254		29-	A	D1
C 1177	CHIP CAP.	27pF	50V	CH	UMK105CH270JV-F	K22178268		1-	B	e1
C 1178	AL.ELECTRO.CAP.	100uF	6.3V		RV2-6V101MU-R	K48080005		1-	A	F7
C 1179	CHIP CAP.	10pF	50V	CH	UMK105CH100DV-F	K22178258		1-	A	D1
C 1180	CHIP CAP.	68pF	50V	CH	UMK105CH680JV-F	K22178278		1-6	B	d1
C 1180	CHIP CAP.	120pF	50V	CH	UMK105CH121JV-F	K22178284		7-	B	d1
C 1182	CHIP CAP.	0.1uF	16V	B	GRM188B11C104KA01D	K22124805		1-	B	e1
C 1183	CHIP CAP.	2pF	50V	CK	UMK105CK020CV-F	K22178250		1-	A	D1
C 1184	CHIP CAP.	0.001uF	50V	B	UMK105B102KW-F	K22178829		1-3	A	E1
C 1184	CHIP CAP.	0.01uF	16V	B	GRM36B103K16PT	K22128804		4-82	A	E1
C 1184	CHIP CAP.	0.01uF	25V	B	GRM155B11E103KA01D	K22148834		83-	A	E1
C 1185	CHIP CAP.	0.1uF	16V	B	GRM188B11C104KA01D	K22124805		1-	A	D1
C 1186	CHIP CAP.	120pF	50V	CH	UMK105CH121JV-F	K22178284		1-	B	e1
C 1187	CHIP CAP.	0.1uF	16V	B	GRM188B11C104KA01D	K22124805		1-	B	e1
C 1188	CHIP TA.CAP.	1uF	16V		TEESVA1C105M8R	K78120009		1-	A	G7
C 1189	CHIP TA.CAP.	1uF	16V		TEESVA1C105M8R	K78120009		1-	A	E5
C 1190	CHIP CAP.	0.01uF	16V	B	GRM36B103K16PT	K22128804		1-82	A	D5
C 1190	CHIP CAP.	0.01uF	25V	B	GRM155B11E103KA01D	K22148834		83-	A	D5
C 1191	CHIP CAP.	0.01uF	16V	B	GRM36B103K16PT	K22128804		1-82	A	G6
C 1191	CHIP CAP.	0.01uF	25V	B	GRM155B11E103KA01D	K22148834		83-	A	G6
C 1192	CHIP CAP.	33pF	50V	CH	UMK105CH330JV-F	K22178270		1-	B	d3
C 1193	CHIP CAP.	27pF	50V	CH	UMK105CH270JV-F	K22178268		1-	B	d3
C 1194	CHIP TA.CAP.	1uF	16V		TEESVA1C105M8R	K78120009		1-	A	F6
C 1195	CHIP CAP.	120pF	50V	CH	UMK105CH121JV-F	K22178284		1-	A	D1
C 1196	CHIP CAP.	0.001uF	50V	B	UMK105B102KW-F	K22178829		1-	B	e1
C 1197	CHIP CAP.	100pF	50V	CH	UMK105CH101JV-F	K22178282		1-	B	d3
C 1198	CHIP CAP.	9pF	50V	CH	UMK105CH090DV-F	K22178257		1-	B	d3
C 1199	CHIP CAP.	120pF	50V	CH	UMK105CH121JV-F	K22178284		1-	A	D1
C 1200	CHIP CAP.	0.001uF	50V	B	UMK105B102KW-F	K22178829		1-	B	e1
C 1201	CHIP CAP.	0.01uF	16V	B	GRM36B103K16PT	K22128804		1-78	A	D1
C 1201	CHIP CAP.	0.0022uF	50V	B	UMK105B222KW-F	K22178833		79-	A	D1
C 1202	CHIP CAP.	68pF	50V	CH	UMK105CH680JV-F	K22178278		1-	B	d3
C 1203	CHIP CAP.	0.1uF	16V	B	GRM188B11C104KA01D	K22124805		1-	B	e1
C 1204	CHIP CAP.	12pF	50V	CH	UMK105CH120JV-F	K22178260		1-78	A	C3
C 1204	CHIP CAP.	5pF	50V	CH	UMK105CH050CV-F	K22178253		79-	A	C3
C 1205	CHIP CAP.	0.01uF	16V	B	GRM36B103K16PT	K22128804		1-82	B	h1
C 1205	CHIP CAP.	0.01uF	25V	B	GRM155B11E103KA01D	K22148834		83-	B	h1
C 1206	CHIP TA.CAP.	10uF	10V		TEESVA1A106M8R	K78100028		1-	B	h1
C 1207	CHIP CAP.	0.01uF	16V	B	GRM36B103K16PT	K22128804		1-82	A	C3
C 1207	CHIP CAP.	0.01uF	25V	B	GRM155B11E103KA01D	K22148834		83-	A	C3
C 1208	CHIP CAP.	0.001uF	50V	B	UMK105B102KW-F	K22178829		1-	B	e1
C 1209	CHIP CAP.	18pF	50V	CH	UMK105CH180JV-F	K22178264		1-	B	h1
C 1210	CHIP CAP.	0.1uF	16V	B	GRM188B11C104KA01D	K22124805		1-	A	F2
C 1211	CHIP CAP.	18pF	50V	CH	UMK105CH180JV-F	K22178264		1-	A	C3
C 1212	CHIP CAP.	0.01uF	16V	B	GRM36B103K16PT	K22128804		1-82	A	C3
C 1212	CHIP CAP.	0.01uF	25V	B	GRM155B11E103KA01D	K22148834		83-	A	C3
C 1213	CHIP CAP.	100pF	50V	CH	UMK105CH101JV-F	K22178282		1-	A	E2
C 1214	CHIP CAP.	0.001uF	50V	B	UMK105B102KW-F	K22178829		1-	A	E5
C 1215	CHIP CAP.	15pF	50V	CH	UMK105CH150JV-F	K22178262		1-	B	h1
C 1216	CHIP CAP.	0.001uF	50V	B	UMK105B102KW-F	K22178829		1-	B	e1
C 1217	CHIP TA.CAP.	1uF	10V		TEESVP1A105M8R	K78100032		1-	B	f3
C 1218	CHIP CAP.	0.01uF	16V	B	GRM36B103K16PT	K22128804		1-82	B	f3
C 1218	CHIP CAP.	0.01uF	25V	B	GRM155B11E103KA01D	K22148834		83-	B	f3
C 1219	CHIP CAP.	22pF	50V	CH	UMK105CH220JV-F	K22178266		1-	B	h1
C 1221	CHIP CAP.	0.022uF	16V	B	EMK105B223KW-F	K22128813		1-	A	E5
C 1222	CHIP CAP.	0.001uF	50V	B	UMK105B102KW-F	K22178829		1-	B	g1
C 1223	CHIP CAP.	0.0033uF	50V	B	UMK105B332KW-F	K22178835		1-	A	E5
C 1224	CHIP CAP.	9pF	50V	CH	UMK105CH090DV-F	K22178257		1-	A	E2
C 1225	CHIP CAP.	27pF	50V	CH	UMK105CH270JV-F	K22178268		1-	B	f3
C 1226	CHIP CAP.	100pF	50V	CH	UMK105CH101JV-F	K22178282		1-	B	f3
C 1227	CHIP CAP.	0.01uF	16V	B	GRM36B103K16PT	K22128804		1-82	B	h1
C 1227	CHIP CAP.	0.01uF	25V	B	GRM155B11E103KA01D	K22148834		83-	B	h1
C 1228	CHIP CAP.	0.01uF	16V	B	GRM36B103K16PT	K22128804		1-82	B	f3

REF	DESCRIPTION	VALUE	V/W	TOL.	MFR'S DESIG	VXSTD P/N	VERS.	LOT	SIDE	LAY ADR
C 1228	CHIP CAP.	0.01uF	25V	B	GRM155B11E103KA01D	K22148834		83-	B	f3
C 1229	CHIP CAP.	0.001uF	50V	B	UMK105B102KW-F	K22178829		1-	B	g1
C 1230	CHIP CAP.	0.001uF	50V	B	UMK105B102KW-F	K22178829		1-	B	h1
C 1232	CHIP CAP.	0.001uF	50V	B	UMK105B102KW-F	K22178829		1-	B	f1
C 1234	CHIP CAP.	0.001uF	50V	B	GRM188B11H102KA01D	K22174821		1-	A	E2
C 1235	CHIP CAP.	100pF	50V	CH	UMK105CH101JV-F	K22178282		1-	A	E2
C 1236	CHIP TA.CAP.	10uF	10V		TEESVA1A106M8R	K78100028		1-	A	C3
C 1237	CHIP CAP.	0.1uF	16V	B	GRM188B11C104KA01D	K22124805		1-	A	E2
C 1238	CHIP CAP.	27pF	50V	CH	UMK105CH270JV-F	K22178268		1-49	A	G5
C 1238	CHIP CAP.	10pF	50V	CH	UMK105CH100DV-F	K22178258		50-	A	G5
C 1239	CHIP CAP.	0.1uF	16V	B	GRM188B11C104KA01D	K22124805		1-	A	D3
C 1240	CHIP CAP.	0.01uF	16V	B	GRM36B103K16PT	K22128804		1-82	A	C3
C 1240	CHIP CAP.	0.01uF	25V	B	GRM155B11E103KA01D	K22148834		83-	A	C3
C 1241	CHIP CAP.	10pF	50V	CH	UMK105CH100DV-F	K22178258		1-	B	h1
C 1242	CHIP CAP.	0.001uF	50V	B	GRM188B11H102KA01D	K22174821		1-	A	E2
C 1243	CHIP CAP.	0.01uF	16V	B	GRM36B103K16PT	K22128804		1-82	B	h1
C 1243	CHIP CAP.	0.01uF	25V	B	GRM155B11E103KA01D	K22148834		83-	B	h1
C 1244	CHIP CAP.	0.01uF	16V	B	GRM36B103K16PT	K22128804		1-82	A	E3
C 1244	CHIP CAP.	0.01uF	25V	B	GRM155B11E103KA01D	K22148834		83-	A	E3
C 1245	CHIP CAP.	100pF	50V	CH	UMK105CH101JV-F	K22178282		1-	B	d2
C 1246	CHIP CAP.	0.1uF	16V	B	GRM188B11C104KA01D	K22124805		1-	A	E2
C 1247	CHIP CAP.	4pF	50V	CH	UMK105CH040CV-F	K22178252		1-	B	e2
C 1248	CHIP CAP.	0.01uF	16V	B	GRM36B103K16PT	K22128804		1-82	B	d2
C 1248	CHIP CAP.	0.01uF	25V	B	GRM155B11E103KA01D	K22148834		83-	B	d2
C 1249	CHIP CAP.	47pF	50V	CH	UMK105CH470JV-F	K22178274		1-49	A	F5
C 1249	CHIP CAP.	12pF	50V	CH	UMK105CH120JV-F	K22178260		50-	A	F5
C 1250	CHIP CAP.	0.001uF	50V	B	UMK105B102KW-F	K22178829		1-	B	h1
C 1251	CHIP CAP.	9pF	50V	CH	UMK105CH090DV-F	K22178257		1-	B	e2
C 1252	AL.ELECTRO.CAP.	10uF	16V		RV2-16V100MB55U-R	K48120014		1-	A	E6
C 1253	CHIP CAP.	0.001uF	50V	B	UMK105B102KW-F	K22178829		1-	A	E2
C 1254	CHIP CAP.	0.001uF	50V	B	UMK105B102KW-F	K22178829		1-	B	f3
C 1255	CHIP CAP.	10pF	50V	CH	UMK105CH100DV-F	K22178258		1-49	A	G5
C 1255	CHIP CAP.	8pF	50V	CH	UMK105CH080DV-F	K22178256		50-	A	G5
C 1256	CHIP CAP.	7pF	50V	CH	UMK105CH070DV-F	K22178255		1-	B	e2
C 1257	CHIP CAP.	0.001uF	50V	B	UMK105B102KW-F	K22178829		1-	B	f3
C 1258	CHIP CAP.	0.0047uF	25V	B	TMK105B472KW-F	K22148831		1-	A	E5
C 1259	CHIP CAP.	0.01uF	16V	B	GRM36B103K16PT	K22128804		1-82	B	f3
C 1259	CHIP CAP.	0.01uF	25V	B	GRM155B11E103KA01D	K22148834		83-	B	f3
C 1260	CHIP CAP.	0.01uF	16V	B	GRM36B103K16PT	K22128804		1-82	B	d1
C 1260	CHIP CAP.	0.01uF	25V	B	GRM155B11E103KA01D	K22148834		83-	B	d1
C 1261	CHIP CAP.	47pF	50V	CH	UMK105CH470JV-F	K22178274		1-	B	h2
C 1262	CHIP CAP.	0.001uF	50V	B	UMK105B102KW-F	K22178829		1-	B	e2
C 1263	CHIP TA.CAP.	10uF	10V		TEESVA1A106M8R	K78100028		1-	B	e3
C 1264	CHIP CAP.	0.001uF	50V	B	UMK105B102KW-F	K22178829		1-	B	e2
C 1266	CHIP CAP.	0.01uF	16V	B	GRM36B103K16PT	K22128804		1-82	A	E5
C 1266	CHIP CAP.	0.01uF	25V	B	GRM155B11E103KA01D	K22148834		83-	A	E5
C 1267	CHIP CAP.	18pF	50V	CH	UMK105CH180JV-F	K22178264		1-	A	B3
C 1268	CHIP CAP.	82pF	50V	UJ	GRM1553U1H820JZ01D	K22178322		1-	B	f3
C 1269	CHIP CAP.	0.01uF	16V	B	GRM36B103K16PT	K22128804		1-82	A	B3
C 1269	CHIP CAP.	0.01uF	25V	B	GRM155B11E103KA01D	K22148834		83-	A	B3
C 1270	CHIP CAP.	0.001uF	50V	B	GRM188B11H102KA01D	K22174821		1-	A	D2
C 1271	CHIP CAP.	0.001uF	50V	B	GRM188B11H102KA01D	K22174821		1-	A	D2
C 1272	CHIP CAP.	0.001uF	50V	B	UMK105B102KW-F	K22178829		1-	B	e2
C 1273	CHIP CAP.	0.001uF	50V	B	UMK105B102KW-F	K22178829		1-	B	c2
C 1274	CHIP CAP.	1uF	10V	B	GRM21BB11A105KA01L	K22100802		1-	B	c2
C 1275	CHIP CAP.	0.022uF	16V	B	EMK105B223KW-F	K22128813		1-	B	c2
C 1276	CHIP CAP.	2pF	50V	CK	UMK105CK020CV-F	K22178250		1-	B	g3
C 1277	CHIP CAP.	82pF	50V	UJ	GRM1553U1H820JZ01D	K22178322		1-	B	f3
C 1278	CHIP CAP.	0.01uF	16V	B	GRM36B103K16PT	K22128804		1-82	B	c2
C 1278	CHIP CAP.	0.01uF	25V	B	GRM155B11E103KA01D	K22148834		83-	B	c2
C 1279	CHIP CAP.	1uF	10V	B	GRM21BB11A105KA01L	K22100802		1-	B	c2
C 1280	CHIP CAP.	0.1uF	16V	B	GRM188B11C104KA01D	K22124805		1-	A	D2
C 1281	CHIP CAP.	0.1uF	16V	B	GRM188B11C104KA01D	K22124805		1-	A	D2
C 1282	CHIP TA.CAP.	10uF	10V		TEESVA1A106M8R	K78100028		1-	A	E1
C 1283	CHIP CAP.	0.01uF	16V	B	GRM36B103K16PT	K22128804		1-82	B	c1
C 1283	CHIP CAP.	0.01uF	25V	B	GRM155B11E103KA01D	K22148834		83-	B	c1
C 1284	CHIP CAP.	15pF	50V	CH	UMK105CH150JV-F	K22178262		1-	A	B3
C 1285	CHIP CAP.	10pF	50V	CH	UMK105CH100DV-F	K22178258		1-	B	c2
C 1286	CHIP TA.CAP.	1uF	16V		TEESVA1C105M8R	K78120009		1-	B	c1
C 1287	CHIP CAP.	0.01uF	16V	B	GRM36B103K16PT	K22128804		1-82	A	D2
C 1287	CHIP CAP.	0.01uF	25V	B	GRM155B11E103KA01D	K22148834		83-	A	D2
C 1288	CHIP CAP.	18pF	50V	CH	UMK105CH180JV-F	K22178264		1-	A	C2
C 1289	CHIP CAP.	0.01uF	16V	B	GRM36B103K16PT	K22128804		1-82	A	C2

MAIN Unit

Parts List

REF	DESCRIPTION	VALUE	V/W	TOL.	MFR'S DESIG	VXSTD P/N	VERS.	LOT	SIDE	LAY ADR
C 1289	CHIP CAP.	0.01uF	25V	B	GRM155B11E103KA01D	K22148834		83-	A	C2
C 1290	CHIP CAP.	0.001uF	50V	B	UMK105B102KW-F	K22178829		1-	B	c2
C 1291	CHIP CAP.	0.001uF	50V	B	UMK105B102KW-F	K22178829		1-	A	B3
C 1292	CHIP CAP.	0.001uF	50V	B	UMK105B102KW-F	K22178829		1-	B	e2
C 1293	CHIP TA.CAP.	4.7uF	10V		TEESVA21A475M8R	K78100045		1-	B	h2
C 1295	CHIP CAP.	0.01uF	16V	B	GRM36B103K16PT	K22128804		1-82	B	h2
C 1295	CHIP CAP.	0.01uF	25V	B	GRM155B11E103KA01D	K22148834		83-	B	h2
C 1296	CHIP CAP.	0.001uF	50V	B	UMK105B102KW-F	K22178829		1-	B	e2
C 1298	CHIP CAP.	15pF	50V	CH	UMK105CH150JV-F	K22178262		1-66	B	e2
C 1298	CHIP CAP.	47pF	50V	CH	UMK105CH470JV-F	K22178274		67-	B	e2
C 1299	CHIP CAP.	0.001uF	50V	B	UMK105B102KW-F	K22178829		1-	A	B3
C 1300	CHIP CAP.	0.01uF	16V	B	GRM36B103K16PT	K22128804		1-82	A	D2
C 1300	CHIP CAP.	0.01uF	25V	B	GRM155B11E103KA01D	K22148834		83-	A	D2
C 1301	CHIP CAP.	0.01uF	16V	B	GRM36B103K16PT	K22128804		1-82	B	h2
C 1301	CHIP CAP.	0.01uF	25V	B	GRM155B11E103KA01D	K22148834		83-	B	h2
C 1302	CHIP CAP.	8pF	50V	CH	UMK105CH080DV-F	K22178256		1-17	A	C3
C 1302	CHIP CAP.	15pF	50V	CH	UMK105CH150JV-F	K22178262		18-	A	C3
C 1303	CHIP CAP.	0.001uF	50V	B	UMK105B102KW-F	K22178829		1-	B	e2
C 1304	CHIP CAP.	0.1uF	16V	B	GRM188B11C104KA01D	K22124805		1-	B	h2
C 1305	CHIP CAP.	22pF	50V	CH	UMK105CH220JV-F	K22178266		1-17	A	D3
C 1305	CHIP CAP.	0.001uF	50V	B	UMK105B102KW-F	K22178829		18-	A	D3
C 1306	CHIP CAP.	0.01uF	16V	B	GRM36B103K16PT	K22128804		1-82	A	D3
C 1306	CHIP CAP.	0.01uF	25V	B	GRM155B11E103KA01D	K22148834		83-	A	D3
C 1307	CHIP CAP.	0.01uF	16V	B	GRM36B103K16PT	K22128804		1-82	B	h2
C 1307	CHIP CAP.	0.01uF	25V	B	GRM155B11E103KA01D	K22148834		83-	B	h2
C 1308	CHIP CAP.	0.001uF	50V	B	UMK105B102KW-F	K22178829		1-17	A	D3
C 1308	CHIP CAP.	33pF	50V	CH	UMK105CH330JV-F	K22178270		18-	A	D3
C 1309	CHIP CAP.	0.01uF	16V	B	GRM36B103K16PT	K22128804		1-82	A	E2
C 1309	CHIP CAP.	0.01uF	25V	B	GRM155B11E103KA01D	K22148834		83-	A	E2
C 1310	CHIP CAP.	0.1uF	16V	B	GRM188B11C104KA01D	K22124805		1-	A	E5
C 1311	CHIP CAP.	0.01uF	16V	B	GRM36B103K16PT	K22128804		1-82	B	h2
C 1311	CHIP CAP.	0.01uF	25V	B	GRM155B11E103KA01D	K22148834		83-	B	h2
C 1312	CHIP TA.CAP.	4.7uF	6.3V		TEESVPOJ475M8R	K78080053		1-	B	f3
C 1313	CHIP CAP.	0.01uF	16V	B	GRM36B103K16PT	K22128804		1-82	A	D3
C 1313	CHIP CAP.	0.01uF	25V	B	GRM155B11E103KA01D	K22148834		83-	A	D3
C 1314	CHIP CAP.	15pF	50V	CH	UMK105CH150JV-F	K22178262		1-17	A	D3
C 1314	CHIP CAP.	18pF	50V	CH	UMK105CH180JV-F	K22178264		18-	A	D3
C 1315	CHIP CAP.	0.033uF	10V	BJ	LMK105BJ333KV-F	K22108804		1-	A	E5
C 1316	CHIP CAP.	0.01uF	16V	B	GRM36B103K16PT	K22128804		1-82	B	f3
C 1316	CHIP CAP.	0.01uF	25V	B	GRM155B11E103KA01D	K22148834		83-	B	f3
C 1318	CHIP CAP.	0.01uF	16V	B	GRM36B103K16PT	K22128804		1-82	B	e2
C 1318	CHIP CAP.	0.01uF	25V	B	GRM155B11E103KA01D	K22148834		83-	B	e2
C 1319	CHIP CAP.	0.001uF	50V	B	UMK105B102KW-F	K22178829		1-	B	h2
C 1320	CHIP CAP.	0.01uF	50V	B	GRM188B11H103KA01D	K22174823		1-	A	A4
C 1321	CHIP CAP.	0.01uF	16V	B	GRM36B103K16PT	K22128804		1-82	A	A4
C 1321	CHIP CAP.	0.01uF	25V	B	GRM155B11E103KA01D	K22148834		83-	A	A4
C 1322	CHIP CAP.	0.01uF	16V	B	GRM36B103K16PT	K22128804		1-82	A	A4
C 1322	CHIP CAP.	0.01uF	25V	B	GRM155B11E103KA01D	K22148834		83-	A	A4
C 1323	CHIP TA.CAP.	10uF	10V		TEESVA1A106M8R	K78100028		1-	A	A4
C 1324	CHIP TA.CAP.	2.2uF	10V		TEESVA1A225M8R	K78100021		1-	B	f4
C 1325	CHIP CAP.	0.0047uF	25V	B	TMK105B472KW-F	K22148831		1-	A	D5
C 1326	CHIP TA.CAP.	1uF	16V		TEESVA1C105M8R	K78120009		1-	B	e4
C 1327	CHIP CAP.	0.1uF	16V	B	GRM188B11C104KA01D	K22124805		1-	B	f4
C 1328	CHIP CAP.	0.01uF	16V	B	GRM36B103K16PT	K22128804		1-82	B	g5
C 1328	CHIP CAP.	0.01uF	25V	B	GRM155B11E103KA01D	K22148834		83-	B	g5
C 1329	CHIP CAP.	0.01uF	16V	B	GRM36B103K16PT	K22128804		1-82	B	g4
C 1329	CHIP CAP.	0.01uF	25V	B	GRM155B11E103KA01D	K22148834		83-	B	g4
C 1330	CHIP CAP.	0.01uF	16V	B	GRM36B103K16PT	K22128804		1-82	B	e4
C 1330	CHIP CAP.	0.01uF	25V	B	GRM155B11E103KA01D	K22148834		83-	B	e4
C 1333	CHIP CAP.	0.01uF	16V	B	GRM36B103K16PT	K22128804		1-82	A	E5
C 1333	CHIP CAP.	0.01uF	25V	B	GRM155B11E103KA01D	K22148834		83-	A	E5
C 1334	CHIP TA.CAP.	10uF	10V		TEESVA1A106M8R	K78100028		1-	A	B4
C 1336	CHIP TA.CAP.	0.47uF	25V		TEESVA1E474M8R	K78140009		1-	A	A5
C 1337	CHIP CAP.	0.01uF	16V	B	GRM36B103K16PT	K22128804		1-82	B	g4
C 1337	CHIP CAP.	0.01uF	25V	B	GRM155B11E103KA01D	K22148834		83-	B	g4
C 1338	CHIP CAP.	0.01uF	16V	B	GRM36B103K16PT	K22128804		1-82	A	C3
C 1338	CHIP CAP.	0.01uF	25V	B	GRM155B11E103KA01D	K22148834		83-	A	C3
C 1340	CHIP CAP.	0.1uF	16V	B	GRM188B11C104KA01D	K22124805		1-	A	B4
C 1341	CHIP CAP.	0.001uF	50V	B	UMK105B102KW-F	K22178829		1-	A	B4
C 1342	CHIP CAP.	0.1uF	16V	B	GRM188B11C104KA01D	K22124805		1-	A	B4
C 1344	CHIP CAP.	0.001uF	50V	B	UMK105B102KW-F	K22178829		1-	A	B4
C 1345	CHIP CAP.	0.1uF	16V	B	GRM188B11C104KA01D	K22124805		1-	B	g4
C 1346	CHIP CAP.	1uF	10V	B	GRM21BB11A105KA01L	K22100802		1-	B	h4

REF	DESCRIPTION	VALUE	V/W	TOL.	MFR'S DESIG	VXSTD P/N	VERS.	LOT	SIDE	LAY ADR
C 1347	CHIP TA.CAP.	10uF	10V		TEESVA1A106M8R	K78100028		1-	A	B4
C 1350	CHIP CAP.	0.01uF	16V	B	GRM36B103K16PT	K22128804		1-82	A	B3
C 1350	CHIP CAP.	0.01uF	25V	B	GRM155B11E103KA01D	K22148834		83-	A	B3
C 1351	CHIP CAP.	0.047uF	10V	BJ	LMK105BJ473KV-F	K22108805		1-	B	h5
C 1352	CHIP CAP.	15pF	50V	CH	UMK105CH150JV-F	K22178262		1-56	B	e4
C 1352	CHIP CAP.	33pF	50V	CH	UMK105CH330JV-F	K22178270		57-	B	e4
C 1353	CHIP CAP.	0.1uF	10V	B	GRM155B11A104KA01D	K22108802		1-	A	B4
C 1355	CHIP CAP.	15pF	50V	CH	UMK105CH150JV-F	K22178262		1-	A	C4
C 1356	CHIP CAP.	0.1uF	16V	B	GRM188B11C104KA01D	K22124805		1-	A	D5
C 1357	CHIP CAP.	1uF	10V	B	GRM21BB11A105KA01L	K22100802		1-	B	g3
C 1358	CHIP CAP.	1uF	10V	B	GRM21BB11A105KA01L	K22100802		1-	B	f3
C 1359	CHIP CAP.	100pF	50V	CH	UMK105CH101JV-F	K22178282		1-	A	B3
C 1360	CHIP CAP.	0.001uF	50V	B	UMK105B102KW-F	K22178829		1-	B	h5
C 1361	CHIP CAP.	1uF	10V	B	GRM21BB11A105KA01L	K22100802		1-	B	g4
C 1362	CHIP CAP.	0.1uF	16V	B	GRM188B11C104KA01D	K22124805		1-	B	g4
C 1363	CHIP CAP.	33pF	50V	CH	UMK105CH330JV-F	K22178270		1-	B	e5
C 1364	CHIP CAP.	0.1uF	16V	B	GRM188B11C104KA01D	K22124805		1-	B	h5
C 1365	CHIP CAP.	0.001uF	50V	B	UMK105B102KW-F	K22178829		1-	A	B4
C 1366	CHIP TA.CAP.	10uF	10V		TEESVA1A106M8R	K78100028		1-	A	A4
C 1367	CHIP CAP.	0.01uF	16V	B	GRM36B103K16PT	K22128804		1-82	B	e4
C 1367	CHIP CAP.	0.01uF	25V	B	GRM155B11E103KA01D	K22148834		83-	B	e4
C 1368	CHIP CAP.	0.01uF	16V	B	GRM36B103K16PT	K22128804		1-82	B	e5
C 1368	CHIP CAP.	0.01uF	25V	B	GRM155B11E103KA01D	K22148834		83-	B	e5
C 1369	CHIP CAP.	0.01uF	16V	B	GRM36B103K16PT	K22128804		1-82	B	g4
C 1369	CHIP CAP.	0.01uF	25V	B	GRM155B11E103KA01D	K22148834		83-	B	g4
C 1370	CHIP CAP.	0.01uF	16V	B	GRM36B103K16PT	K22128804		1-82	A	B4
C 1370	CHIP CAP.	0.01uF	25V	B	GRM155B11E103KA01D	K22148834		83-	A	B4
C 1371	CHIP CAP.	0.01uF	16V	B	GRM36B103K16PT	K22128804		1-82	B	h5
C 1371	CHIP CAP.	0.01uF	25V	B	GRM155B11E103KA01D	K22148834		83-	B	h5
C 1372	CHIP TA.CAP.	10uF	10V		TEESVA1A106M8R	K78100028		1-	B	g4
C 1375	CHIP CAP.	0.1uF	16V	B	GRM188B11C104KA01D	K22124805		1-	B	e5
C 1376	CHIP CAP.	0.0033uF	50V	B	UMK105B332KW-F	K22178835		1-	A	B3
C 1378	CHIP CAP.	0.01uF	16V	B	GRM36B103K16PT	K22128804		1-82	B	g4
C 1378	CHIP CAP.	0.01uF	25V	B	GRM155B11E103KA01D	K22148834		83-	B	g4
C 1379	CHIP CAP.	7pF	50V	CH	UMK105CH070DV-F	K22178255		1-	A	C4
C 1380	CHIP CAP.	270pF	25V	CH	GRM36CH271J25PT	K22148248		1-82	B	g5
C 1380	CHIP CAP.	270pF	50V	CH	GRM155C1H271JA01D	K22179715		83-	B	g5
C 1381	CHIP CAP.	0.01uF	16V	B	GRM36B103K16PT	K22128804		1-82	A	B4
C 1381	CHIP CAP.	0.01uF	25V	B	GRM155B11E103KA01D	K22148834		83-	A	B4
C 1382	CHIP CAP.	0.001uF	50V	B	UMK105B102KW-F	K22178829		1-	B	h5
C 1383	CHIP CAP.	0.0015uF	50V	B	UMK105B152KW-F	K22178831		1-	A	B3
C 1384	CHIP CAP.	1uF	10V	B	GRM21BB11A105KA01L	K22100802		18-	B	c5
C 1385	CHIP CAP.	1uF	10V	B	GRM21BB11A105KA01L	K22100802		18-	B	c5
C 1386	CHIP CAP.	220pF	25V	CH	TMK105CH221JV-F	K22148246		1-	B	e5
C 1387	CHIP TA.CAP.	10uF	10V		TEESVA1A106M8R	K78100028		1-	A	C4
C 1388	CHIP CAP.	0.01uF	16V	B	GRM36B103K16PT	K22128804		1-82	A	C4
C 1388	CHIP CAP.	0.01uF	25V	B	GRM155B11E103KA01D	K22148834		83-	A	C4
C 1389	CHIP CAP.	0.01uF	16V	B	GRM36B103K16PT	K22128804		1-82	A	B4
C 1389	CHIP CAP.	0.01uF	25V	B	GRM155B11E103KA01D	K22148834		83-	A	B4
C 1390	CHIP CAP.	0.01uF	16V	B	GRM36B103K16PT	K22128804		1-82	B	h5
C 1390	CHIP CAP.	0.01uF	25V	B	GRM155B11E103KA01D	K22148834		83-	B	h5
C 1391	CHIP CAP.	100pF	50V	CH	UMK105CH101JV-F	K22178282		1-	B	h5
C 1392	CHIP CAP.	0.1uF	10V	B	GRM155B11A104KA01D	K22108802		1-	A	C4
C 1394	CHIP CAP.	100pF	50V	CH	UMK105CH101JV-F	K22178282		1-	B	h5
C 1395	CHIP CAP.	0.1uF	16V	B	GRM188B11C104KA01D	K22124805		1-	A	C4
C 1396	CHIP CAP.	1uF	10V	B	GRM21BB11A105KA01L	K22100802		1-	B	g3
C 1397	CHIP TA.CAP.	10uF	10V		TEESVA1A106M8R	K78100028		1-	B	g3
C 1398	CHIP CAP.	33pF	50V	CH	UMK105CH330JV-F	K22178270		1-	B	e5
C 1399	CHIP CAP.	0.01uF	16V	B	GRM36B103K16PT	K22128804		1-82	A	D4
C 1399	CHIP CAP.	0.01uF	25V	B	GRM155B11E103KA01D	K22148834		83-	A	D4
C 1400	CHIP CAP.	0.01uF	50V	B	GRM188B11H103KA01D	K22174823		1-	A	B4
C 1401	CHIP CAP.	0.01uF	16V	B	GRM36B103K16PT	K22128804		1-82	A	D5
C 1401	CHIP CAP.	0.01uF	25V	B	GRM155B11E103KA01D	K22148834		83-	A	D5
C 1403	CHIP CAP.	0.01uF	16V	B	GRM36B103K16PT	K22128804		1-82	A	C4
C 1403	CHIP CAP.	0.01uF	25V	B	GRM155B11E103KA01D	K22148834		83-	A	C4
C 1404	CHIP CAP.	0.1uF	16V	B	GRM188B11C104KA01D	K22124805		1-	B	d5
C 1405	CHIP CAP.	0.001uF	50V	B	UMK105B102KW-F	K22178829		1-	A	C3
C 1406	CHIP CAP.	33pF	50V	CH	UMK105CH330JV-F	K22178270		1-17	B	g4
C 1406	CHIP CAP.	5pF	50V	CH	UMK105CH050CV-F	K22178253		18-	B	g4
C 1407	CHIP CAP.	56pF	50V	CH	UMK105CH560JV-F	K22178276		1-	B	g5
C 1408	CHIP CAP.	0.1uF	16V	B	GRM188B11C104KA01D	K22124805		1-	B	g5
C 1409	CHIP CAP.	2pF	50V	CK	UMK105CK020CV-F	K22178250		1-	A	C4
C 1410	CHIP CAP.	1uF	10V	B	GRM21BB11A105KA01L	K22100802		1-	B	g4

MAIN Unit

Parts List

REF	DESCRIPTION	VALUE	V/W	TOL.	MFR'S DESIG	VXSTD P/N	VERS.	LOT	SIDE	LAY ADR
C 1411	CHIP CAP.	0.01uF	16V	B	GRM36B103K16PT	K22128804		1-82	B	g5
C 1411	CHIP CAP.	0.01uF	25V	B	GRM155B11E103KA01D	K22148834		83-	B	g5
C 1412	CHIP CAP.	0.1uF	16V	B	GRM188B11C104KA01D	K22124805		1-	B	g3
C 1413	CHIP CAP.	0.1uF	16V	B	GRM188B11C104KA01D	K22124805		1-	A	D5
C 1414	CHIP CAP.	0.01uF	16V	B	GRM36B103K16PT	K22128804		1-82	B	e5
C 1414	CHIP CAP.	0.01uF	25V	B	GRM155B11E103KA01D	K22148834		83-	B	e5
C 1415	CHIP CAP.	0.1uF	16V	B	GRM188B11C104KA01D	K22124805		1-	B	g6
C 1416	CHIP CAP.	0.1uF	16V	B	GRM188B11C104KA01D	K22124805		1-	B	g5
C 1417	CHIP CAP.	0.1uF	16V	B	GRM188B11C104KA01D	K22124805		1-	A	B5
C 1418	CHIP CAP.	0.01uF	16V	B	GRM36B103K16PT	K22128804		1-82	A	D5
C 1418	CHIP CAP.	0.01uF	25V	B	GRM155B11E103KA01D	K22148834		83-	A	D5
C 1419	CHIP CAP.	0.01uF	16V	B	GRM36B103K16PT	K22128804		1-82	B	g5
C 1419	CHIP CAP.	0.01uF	25V	B	GRM155B11E103KA01D	K22148834		83-	B	g5
C 1420	CHIP CAP.	0.1uF	16V	B	GRM188B11C104KA01D	K22124805		1-	A	A5
C 1421	CHIP CAP.	18pF	50V	CH	UMK105CH180JV-F	K22178264		1-	A	C5
C 1422	CHIP CAP.	10pF	50V	CH	UMK105CH100DV-F	K22178258		1-75	B	e4
C 1422	CHIP CAP.	3pF	50V	CJ	UMK105CJ030CV-F	K22178251		76-	B	e4
C 1423	CHIP TA.CAP.	10uF	10V		TEESVA1A106M8R	K78100028		1-	A	A5
C 1424	CHIP CAP.	0.01uF	16V	B	GRM36B103K16PT	K22128804		1-82	B	g5
C 1424	CHIP CAP.	0.01uF	25V	B	GRM155B11E103KA01D	K22148834		83-	B	g5
C 1425	CHIP CAP.	0.01uF	16V	B	GRM36B103K16PT	K22128804		1-82	B	g5
C 1425	CHIP CAP.	0.01uF	25V	B	GRM155B11E103KA01D	K22148834		83-	B	g5
C 1426	CHIP CAP.	270pF	25V	CH	GRM36CH271J25PT	K22148248		1-82	A	B5
C 1426	CHIP CAP.	270pF	50V	CH	GRM1552C1H271JA01D	K22179715		83-	A	B5
C 1427	CHIP CAP.	0.01uF	16V	B	GRM36B103K16PT	K22128804		1-82	B	g4
C 1427	CHIP CAP.	0.01uF	25V	B	GRM155B11E103KA01D	K22148834		83-	B	g4
C 1428	CHIP CAP.	33pF	50V	CH	UMK105CH330JV-F	K22178270		1-	A	D5
C 1429	CHIP CAP.	0.1uF	16V	B	GRM188B11C104KA01D	K22124805		1-	B	h6
C 1430	CHIP CAP.	0.001uF	50V	B	UMK105B102KW-F	K22178829		1-	B	f3
C 1431	CHIP CAP.	0.1uF	10V	B	GRM155B11A104KA01D	K22108802		1-	A	C4
C 1432	CHIP CAP.	0.1uF	16V	B	GRM188B11C104KA01D	K22124805		1-	B	f5
C 1433	CHIP CAP.	22pF	50V	CH	UMK105CH220JV-F	K22178266		1-17	A	C4
C 1433	CHIP CAP.	39pF	50V	CH	UMK105CH390JV-F	K22178272		18-66	A	C4
C 1433	CHIP CAP.	68pF	50V	CH	UMK105CH680JV-F	K22178278		67-78	A	C4
C 1433	CHIP CAP.	0.01uF	25V	B	GRM155B11E103KA01D	K22148834		79-	A	C4
C 1434	CHIP CAP.	33pF	50V	CH	UMK105CH330JV-F	K22178270		1-	B	g5
C 1435	CHIP CAP.	1uF	10V	B	GRM21BB11A105KA01L	K22100802		1-	B	h3
C 1436	CHIP CAP.	0.01uF	16V	B	GRM36B103K16PT	K22128804		1-82	B	f3
C 1436	CHIP CAP.	0.01uF	25V	B	GRM155B11E103KA01D	K22148834		83-	B	f3
C 1437	CHIP CAP.	0.1uF	16V	B	GRM188B11C104KA01D	K22124805		1-	B	g5
C 1439	CHIP CAP.	0.01uF	16V	B	GRM36B103K16PT	K22128804		18-82	B	b4
C 1439	CHIP CAP.	0.01uF	25V	B	GRM155B11E103KA01D	K22148834		83-	B	b4
C 1440	CHIP CAP.	220pF	25V	CH	TMK105CH221JV-F	K22148246		1-	B	g5
C 1441	CHIP CAP.	0.01uF	16V	B	GRM36B103K16PT	K22128804		1-82	A	B5
C 1441	CHIP CAP.	0.01uF	25V	B	GRM155B11E103KA01D	K22148834		83-	A	B5
C 1442	CHIP CAP.	0.1uF	16V	B	GRM188B11C104KA01D	K22124805		1-	B	g5
C 1443	CHIP CAP.	0.1uF	16V	B	GRM188B11C104KA01D	K22124805		1-	A	D5
C 1444	CHIP CAP.	0.01uF	16V	B	GRM36B103K16PT	K22128804		1-82	B	f3
C 1444	CHIP CAP.	0.01uF	25V	B	GRM155B11E103KA01D	K22148834		83-	B	f3
C 1445	CHIP TA.CAP.	10uF	10V		TEESVA1A106M8R	K78100028		1-	A	C4
C 1446	CHIP CAP.	1uF	10V	B	GRM21BB11A105KA01L	K22100802		18-	B	c5
C 1447	CHIP CAP.	0.01uF	16V	B	GRM36B103K16PT	K22128804		1-82	A	D5
C 1447	CHIP CAP.	0.01uF	25V	B	GRM155B11E103KA01D	K22148834		83-	A	D5
C 1448	CHIP CAP.	0.1uF	16V	B	GRM188B11C104KA01D	K22124805		1-	A	C4
C 1449	CHIP CAP.	0.1uF	16V	B	GRM188B11C104KA01D	K22124805		1-	B	g5
C 1450	CHIP CAP.	1uF	10V	B	GRM21BB11A105KA01L	K22100802		18-	B	c5
C 1451	CHIP CAP.	0.1uF	16V	B	GRM188B11C104KA01D	K22124805		1-	A	C4
C 1452	CHIP CAP.	0.0015uF	50V	B	UMK105B152KW-F	K22178831		18-	B	c6
C 1453	CHIP CAP.	0.0015uF	50V	B	UMK105B152KW-F	K22178831		18-	B	c5
C 1454	CHIP CAP.	0.0018uF	50V	B	GRM188B11H182KA01D	K22174812		18-	B	c5
C 1455	CHIP TA.CAP.	10uF	10V		TEESVA1A106M8R	K78100028		1-	B	e5
C 1456	CHIP CAP.	100pF	50V	CH	UMK105CH101JV-F	K22178282		1-	A	B3
C 1457	CHIP TA.CAP.	10uF	10V		TEESVA1A106M8R	K78100028		1-	B	g3
C 1458	CHIP CAP.	0.01uF	16V	B	GRM36B103K16PT	K22128804		1-82	B	g5
C 1458	CHIP CAP.	0.01uF	25V	B	GRM155B11E103KA01D	K22148834		83-	B	g5
C 1459	CHIP TA.CAP.	10uF	10V		TEESVA1A106M8R	K78100028		18-	B	b5
C 1460	CHIP TA.CAP.	10uF	10V		TEESVA1A106M8R	K78100028		18-	B	b4
C 1461	CHIP TA.CAP.	10uF	10V		TEESVA1A106M8R	K78100028		18-	B	b4
C 1462	CHIP CAP.	0.1uF	16V	B	GRM188B11C104KA01D	K22124805		1-	B	g5
C 1463	CHIP CAP.	0.1uF	16V	B	GRM188B11C104KA01D	K22124805		18-	B	b5
C 1464	CHIP CAP.	1uF	10V	B	GRM21BB11A105KA01L	K22100802		1-	B	f3
C 1465	CHIP CAP.	0.012uF	50V	B	GRM188B11H123KA01D	K22174825		18-	B	c5
C 1466	CHIP CAP.	220pF	25V	CH	TMK105CH221JV-F	K22148246		1-	A	D6

REF	DESCRIPTION	VALUE	V/W	TOL.	MFR'S DESIG	VXSTD P/N	VERS.	LOT	SIDE	LAY ADR
C 1467	CHIP CAP.	0.01uF	16V	B	GRM36B103K16PT	K22128804		18-82	B	b5
C 1467	CHIP CAP.	0.01uF	25V	B	GRM155B11E103KA01D	K22148834		83-	B	b5
C 1468	CHIP CAP.	0.1uF	16V	B	GRM188B11C104KA01D	K22124805		18-	B	b4
C 1469	CHIP CAP.	0.1uF	16V	B	GRM188B11C104KA01D	K22124805		18-	B	b4
C 1470	CHIP CAP.	0.01uF	16V	B	GRM36B103K16PT	K22128804		1-82	A	C5
C 1470	CHIP CAP.	0.01uF	25V	B	GRM155B11E103KA01D	K22148834		83-	A	C5
C 1471	CHIP CAP.	33pF	50V	CH	UMK105CH330JV-F	K22178270		1-	B	g5
C 1472	CHIP CAP.	0.01uF	16V	B	GRM36B103K16PT	K22128804		1-6	B	f4
C 1472	CHIP CAP.	0.1uF	10V	B	GRM155B11A104KA01D	K22108802		7-	B	f4
C 1473	CHIP CAP.	0.1uF	16V	B	GRM188B11C104KA01D	K22124805		1-	A	B3
C 1474	CHIP CAP.	0.0047uF	25V	B	TMK105B472KW-F	K22148831		1-	B	g3
C 1475	CHIP CAP.	0.1uF	16V	B	GRM188B11C104KA01D	K22124805		1-	B	g3
C 1476	CHIP TA.CAP.	2.2uF	10V		TEESVA1A225M8R	K78100021		1-	A	D6
C 1477	CHIP CAP.	0.1uF	16V	B	GRM188B11C104KA01D	K22124805		1-	A	C5
C 1478	CHIP CAP.	0.001uF	50V	B	UMK105B102KW-F	K22178829		1-	B	f4
C 1479	CHIP CAP.	0.1uF	16V	B	GRM188B11C104KA01D	K22124805		1-	A	B5
C 1480	CHIP CAP.	0.1uF	16V	B	GRM188B11C104KA01D	K22124805		1-	B	g6
C 1481	CHIP CAP.	100pF	50V	CH	UMK105CH101JV-F	K22178282		1-	B	f4
C 1482	CHIP CAP.	0.01uF	16V	B	GRM36B103K16PT	K22128804		1-82	B	g3
C 1482	CHIP CAP.	0.01uF	25V	B	GRM155B11E103KA01D	K22148834		83-	B	g3
C 1483	CHIP CAP.	0.047uF	10V	BJ	LMK105BJ473KV-F	K22108805		1-17	A	A5
C 1483	CHIP CAP.	0.1uF	10V	B	GRM155B11A104KA01D	K22108802		18-	A	A5
C 1484	CHIP CAP.	0.1uF	16V	B	GRM188B11C104KA01D	K22124805		1-	A	A4
C 1486	CHIP CAP.	0.01uF	16V	B	GRM36B103K16PT	K22128804		18-82	B	b5
C 1486	CHIP CAP.	0.01uF	25V	B	GRM155B11E103KA01D	K22148834		83-	B	b5
C 1487	CHIP CAP.	0.0047uF	25V	B	TMK105B472KW-F	K22148831		18-	B	c5
C 1488	CHIP CAP.	0.1uF	16V	B	GRM188B11C104KA01D	K22124805		1-	A	C5
C 1489	CHIP CAP.	0.01uF	16V	B	GRM36B103K16PT	K22128804		18-82	B	c5
C 1489	CHIP CAP.	0.01uF	25V	B	GRM155B11E103KA01D	K22148834		83-	B	c5
C 1490	CHIP CAP.	0.1uF	16V	B	GRM188B11C104KA01D	K22124805		1-	B	f5
C 1491	CHIP TA.CAP.	10uF	10V		TEESVA1A106M8R	K78100028		1-	A	A5
C 1492	CHIP CAP.	0.0047uF	25V	B	TMK105B472KW-F	K22148831		1-	B	g4
C 1493	CHIP CAP.	0.0056uF	25V	B	GRM155B11E562KA01D	K22148802		18-	B	c5
C 1494	CHIP CAP.	0.0047uF	25V	B	TMK105B472KW-F	K22148831		1-	B	g6
C 1495	CHIP CAP.	0.01uF	16V	B	GRM36B103K16PT	K22128804		1-82	B	g3
C 1495	CHIP CAP.	0.01uF	25V	B	GRM155B11E103KA01D	K22148834		83-	B	g3
C 1496	CHIP CAP.	0.1uF	16V	B	GRM188B11C104KA01D	K22124805		1-	A	C5
C 1497	CHIP CAP.	0.1uF	16V	B	GRM188B11C104KA01D	K22124805		1-	A	B3
C 1498	CHIP CAP.	0.1uF	16V	B	GRM188B11C104KA01D	K22124805		1-	B	g4
C 1499	CHIP TA.CAP.	10uF	10V		TEESVA1A106M8R	K78100028		1-	B	e5
C 1500	CHIP CAP.	0.022uF	16V	B	EMK105B223KW-F	K22128813		1-	B	g4
C 1502	CHIP CAP.	0.001uF	50V	B	UMK105B102KW-F	K22178829		1-	B	g3
C 1503	CHIP TA.CAP.	1uF	16V		TEESVA1C105M8R	K78120009		1-17	A	A4
C 1503	CHIP TA.CAP.	2.2uF	10V		TEESVA1A225M8R	K78100021		18-	A	A4
C 1504	CHIP CAP.	0.1uF	16V	B	GRM188B11C104KA01D	K22124805		1-	A	C6
C 1505	CHIP CAP.	1uF	10V	B	GRM21BB11A105KA01L	K22100802		18-	B	d5
C 1506	CHIP CAP.	0.0033uF	50V	B	UMK105B332KW-F	K22178835		1-	B	g4
C 1507	CHIP CAP.	1uF	10V	B	GRM21BB11A105KA01L	K22100802		1-	B	g4
C 1509	CHIP TA.CAP.	10uF	10V		TEESVA1A106M8R	K78100028		1-	A	C6
C 1510	CHIP CAP.	0.1uF	16V	B	GRM188B11C104KA01D	K22124805		1-	A	C6
C 1511	CHIP CAP.	10pF	50V	CH	UMK105CH100DV-F	K22178258		1-	B	f5
C 1512	CHIP CAP.	0.1uF	16V	B	GRM188B11C104KA01D	K22124805		1-	A	D6
C 1513	CHIP CAP.	0.01uF	16V	B	GRM36B103K16PT	K22128804		18-82	B	b5
C 1513	CHIP CAP.	0.01uF	25V	B	GRM155B11E103KA01D	K22148834		83-	B	b5
C 1516	CHIP TA.CAP.	10uF	16V		TEESVB21C106M8R	K78120025		1-	B	d6
C 1517	CHIP TA.CAP.	22uF	16V		TEESVB21C226M8R	K78120028		1-	B	c6
C 1518	CHIP CAP.	10pF	50V	CH	UMK105CH100DV-F	K22178258		1-	B	e5
C 1519	CHIP CAP.	0.1uF	16V	B	GRM188B11C104KA01D	K22124805		1	B	d6
C 1519	CHIP CAP.	1uF	10V	F	GRM188F11A105ZA01D	K22105001		2-	B	d6
C 1520	CHIP CAP.	47pF	50V	CH	UMK105CH470JV-F	K22178274		18-	B	b5
C 1521	CHIP CAP.	0.01uF	16V	B	GRM36B103K16PT	K22128804		18-82	B	c6
C 1521	CHIP CAP.	0.01uF	25V	B	GRM155B11E103KA01D	K22148834		83-	B	c6
C 1522	CHIP CAP.	0.01uF	16V	B	GRM36B103K16PT	K22128804		18-82	B	b6
C 1522	CHIP CAP.	0.01uF	25V	B	GRM155B11E103KA01D	K22148834		83-	B	b6
C 1523	CHIP CAP.	10pF	50V	CH	UMK105CH100DV-F	K22178258		18-	B	b6
C 1526	CHIP CAP.	33pF	50V	CH	UMK105CH330JV-F	K22178270		18-	B	b6
C 1528	CHIP CAP.	0.1uF	16V	B	GRM188B11C104KA01D	K22124805		1-	B	e7
C 1529	CHIP CAP.	0.1uF	16V	B	GRM188B11C104KA01D	K22124805		1-	B	e6
C 1530	CHIP CAP.	0.01uF	16V	B	GRM36B103K16PT	K22128804		1-82	B	e7
C 1530	CHIP CAP.	0.01uF	25V	B	GRM155B11E103KA01D	K22148834		83-	B	e7
C 1531	CHIP CAP.	0.01uF	16V	B	GRM36B103K16PT	K22128804		1-82	B	e6
C 1531	CHIP CAP.	0.01uF	25V	B	GRM155B11E103KA01D	K22148834		83-	B	e6
C 1532	AL.ELECTRO.CAP.	1000uF	16V		RE3-16V102MH3#	K40129096		1-	A	D7

MAIN Unit

Parts List

REF	DESCRIPTION	VALUE	V/W	TOL.	MFR'S DESIG	VXSTD P/N	VERS.	LOT	SIDE	LAY ADR
C 1533	CHIP CAP.	0.1uF	16V	B	GRM188B11C104KA01D	K22124805		1-	B	e7
C 1534	CHIP CAP.	0.1uF	16V	B	GRM188B11C104KA01D	K22124805		1-	B	e6
C 1535	CHIP CAP.	0.01uF	16V	B	GRM36B103K16PT	K22128804		1	B	d6
C 1535	CHIP CAP.	0.1uF	10V	B	GRM155B11A104KA01D	K22108802		2-	B	d6
C 1536	CHIP CAP.	0.1uF	16V	B	GRM188B11C104KA01D	K22124805		1-	B	g5
C 1537	CHIP CAP.	0.1uF	16V	B	GRM188B11C104KA01D	K22124805		1-	B	f5
C 1539	CHIP CAP.	0.01uF	16V	B	GRM36B103K16PT	K22128804		1-82	B	f6
C 1539	CHIP CAP.	0.01uF	25V	B	GRM155B11E103KA01D	K22148834		83-	B	f6
C 1540	CHIP CAP.	1uF	10V	B	GRM21BB11A105KA01L	K22100802		1-	B	c6
C 1541	AL.ELECTRO.CAP.	1000uF	16V		RE3-16V102MH3#	K40129096		1-	A	E7
C 1542	AL.ELECTRO.CAP.	47uF	16V		EEE1CA470SP	K48120005		1-	A	E6
C 1543	CHIP CAP.	0.1uF	16V	B	GRM188B11C104KA01D	K22124805		1-	B	g5
C 1544	CHIP CAP.	0.1uF	16V	B	GRM188B11C104KA01D	K22124805		1-	B	f5
C 1545	CHIP CAP.	0.1uF	16V	B	GRM188B11C104KA01D	K22124805		1-	B	g7
C 1546	CHIP CAP.	0.1uF	16V	B	GRM188B11C104KA01D	K22124805		1-	B	g6
C 1547	CHIP CAP.	0.01uF	16V	B	GRM36B103K16PT	K22128804		1-82	B	f5
C 1547	CHIP CAP.	0.01uF	25V	B	GRM155B11E103KA01D	K22148834		83-	B	f5
C 1548	CHIP CAP.	0.01uF	16V	B	GRM36B103K16PT	K22128804		1-82	B	g7
C 1548	CHIP CAP.	0.01uF	25V	B	GRM155B11E103KA01D	K22148834		83-	B	g7
C 1549	CHIP CAP.	0.01uF	16V	B	GRM36B103K16PT	K22128804		1-82	B	g6
C 1549	CHIP CAP.	0.01uF	25V	B	GRM155B11E103KA01D	K22148834		83-	B	g6
C 1550	AL.ELECTRO.CAP.	470uF	16V		RE3-16V471MG3#	K40129066		1-	A	E6
C 1551	CHIP CAP.	0.1uF	16V	B	GRM188B11C104KA01D	K22124805		1-	B	d7
C 1552	CHIP CAP.	0.1uF	16V	B	GRM188B11C104KA01D	K22124805		1-	B	g6
C 1554	CHIP TA.CAP.	10uF	10V		TEESVA1A106M8R	K78100028		1-	B	b6
C 1555	CHIP CAP.	1uF	10V	B	GRM21BB11A105KA01L	K22100802		1-	B	b6
C 1557	CHIP CAP.	47pF	50V	CH	UMK105CH470JV-F	K22178274		1-	B	b6
C 1558	CHIP CAP.	100pF	50V	CH	UMK105CH101JV-F	K22178282		1-	B	b6
C 1559	CHIP CAP.	0.001uF	50V	B	UMK105B102KW-F	K22178829		1-	B	b7
C 1560	CHIP CAP.	10pF	50V	CH	UMK105CH100DV-F	K22178258		1-	B	f5
C 1562	CHIP CAP.	100pF	50V	CH	UMK105CH101JV-F	K22178282		1-	B	h4
C 1563	CHIP CAP.	0.001uF	50V	B	UMK105B102KW-F	K22178829		1-	B	b7
C 1564	CHIP CAP.	1uF	10V	B	GRM21BB11A105KA01L	K22100802		1-	B	h4
C 1565	CHIP CAP.	0.001uF	50V	B	UMK105B102KW-F	K22178829		1-	B	h3
C 1566	CHIP CAP.	100pF	50V	CH	UMK105CH101JV-F	K22178282		1-	B	h3
C 1567	CHIP TA.CAP.	10uF	10V		TEESVA1A106M8R	K78100028		1-	A	G7
C 1568	CHIP CAP.	470pF	50V	B	UMK105B471KW-F	K22178825		1-	B	a6
C 1569	CHIP CAP.	0.1uF	16V	B	GRM188B11C104KA01D	K22124805		1-	B	b6
C 1570	CHIP CAP.	0.001uF	50V	B	UMK105B102KW-F	K22178829		1-	A	G7
C 1571	CHIP CAP.	470pF	50V	B	UMK105B471KW-F	K22178825		1-	B	a6
C 1572	CHIP CAP.	0.001uF	50V	B	UMK105B102KW-F	K22178829		1-	B	h6
C 1573	CHIP CAP.	0.001uF	50V	B	UMK105B102KW-F	K22178829		1-	A	A3
C 1574	CHIP CAP.	0.001uF	50V	B	UMK105B102KW-F	K22178829		1-	B	h4
C 1575	CHIP CAP.	0.001uF	50V	B	UMK105B102KW-F	K22178829		1-	B	h4
C 1576	CHIP CAP.	0.001uF	50V	B	UMK105B102KW-F	K22178829		1-	B	h5
C 1577	CHIP CAP.	0.001uF	50V	B	UMK105B102KW-F	K22178829		1-	B	h5
C 1578	CHIP CAP.	0.001uF	50V	B	UMK105B102KW-F	K22178829		1-	B	h5
C 1579	CHIP CAP.	0.001uF	50V	B	UMK105B102KW-F	K22178829		1-	B	h3
C 1580	CHIP CAP.	0.001uF	50V	B	UMK105B102KW-F	K22178829		1-	A	G6
C 1581	CHIP CAP.	1uF	10V	F	GRM188F11A105ZA01D	K22105001		1-	A	G6
C 1582	CHIP CAP.	0.001uF	50V	B	UMK105B102KW-F	K22178829		1-	B	h6
C 1583	CHIP CAP.	0.001uF	50V	B	UMK105B102KW-F	K22178829		1-	B	h5
C 1586	CHIP CAP.	470pF	50V	B	UMK105B471KW-F	K22178825		1-	A	H6
C 1587	CHIP CAP.	0.01uF	50V	B	GRM188B11H103KA01D	K22174823		1-	B	h3
C 1588	CHIP CAP.	0.001uF	50V	B	UMK105B102KW-F	K22178829		1-	B	h4
C 1589	CHIP CAP.	0.001uF	50V	B	UMK105B102KW-F	K22178829		1-	B	b6
C 1590	CHIP CAP.	0.001uF	50V	B	UMK105B102KW-F	K22178829		1-	B	a6
C 1591	CHIP CAP.	470pF	50V	B	UMK105B471KW-F	K22178825		1-	A	H5
C 1592	CHIP CAP.	470pF	50V	B	UMK105B471KW-F	K22178825		1-	A	H5
C 1593	CHIP CAP.	0.001uF	50V	B	UMK105B102KW-F	K22178829		1-	B	h7
C 1594	CHIP CAP.	0.001uF	50V	B	UMK105B102KW-F	K22178829		1-	B	h7
C 1595	CHIP CAP.	0.01uF	16V	B	GRM36B103K16PT	K22128804		1-82	A	G7
C 1595	CHIP CAP.	0.01uF	25V	B	GRM155B11E103KA01D	K22148834		83-	A	G7
C 1596	CHIP CAP.	0.1uF	16V	B	GRM188B11C104KA01D	K22124805		1-	A	G7
C 1597	CHIP CAP.	12pF	50V	CH	UMK105CH120JV-F	K22178260		1-	A	F2
C 1598	CHIP CAP.	5pF	50V	CH	UMK105CH050CV-F	K22178253		1-	A	F2
C 1599	CHIP CAP.	4pF	50V	CH	UMK105CH040CV-F	K22178252		1-	A	F2
C 1600	CHIP CAP.	68pF	50V	CH	UMK105CH680JV-F	K22178278		1-	A	B5
C 1601	CHIP CAP.	22pF	50V	CH	UMK105CH220JV-F	K22178266		1-17	B	g4
C 1601	CHIP CAP.	15pF	50V	CH	UMK105CH150JV-F	K22178262		18-	B	g4
C 1602	CHIP CAP.	15pF	50V	CH	UMK105CH150JV-F	K22178262		1-	B	f4
C 1603	CHIP CAP.	47pF	50V	CH	UMK105CH470JV-F	K22178274		1-	A	C5
C 1604	CHIP CAP.	47pF	50V	CH	UMK105CH470JV-F	K22178274		1-	B	e5

REF	DESCRIPTION	VALUE	V/W	TOL.	MFR'S DESIG	VXSTD P/N	VERS.	LOT	SIDE	LAY ADR
C 1605	CHIP CAP.	68pF	50V	CH	UMK105CH680JV-F	K22178278		1-	B	e5
C 1606	CHIP CAP.	100pF	50V	CH	UMK105CH101JV-F	K22178282		1-	B	f6
C 1607	CHIP CAP.	15pF	50V	CH	UMK105CH150JV-F	K22178262		1-	A	A3
C 1608	CHIP CAP.	33pF	50V	CH	UMK105CH330JV-F	K22178270		1-75	A	C5
C 1608	CHIP CAP.	100pF	50V	CH	UMK105CH101JV-F	K22178282		76-	A	C5
C 1609	CHIP CAP.	100pF	50V	CH	UMK105CH101JV-F	K22178282		1-	A	B3
C 1610	CHIP CAP.	0.1uF	16V	B	GRM188B11C104KA01D	K22124805		1-	B	h3
C 1613	CHIP CAP.	15pF	50V	CH	GRM1882C1H150JA01D	K22174215		1-41	A	G3
C 1613	CHIP CAP.	12pF	50V	CH	GRM1882C1H120JA01D	K22174213		42-	A	G3
C 1614	CHIP CAP.	3pF	50V	CJ	GRM1883C1H3R0CZ01D	K22174204		1-	B	a2
C 1615	CHIP CAP.	1uF	10V	B	GRM21BB11A105KA01L	K22100802		1-	B	e1
C 1616	CHIP CAP.	15pF	50V	CH	UMK105CH150JV-F	K22178262		1-	A	D1
C 1617	CHIP CAP.	0.001uF	50V	B	UMK105B102KW-F	K22178829		1-	B	e5
C 1618	CHIP CAP.	0.001uF	50V	B	UMK105B102KW-F	K22178829		1-	B	h2
C 1619	CHIP CAP.	7pF	50V	CH	UMK105CH070DV-F	K22178255		1-41	A	F2
C 1619	CHIP CAP.	5pF	50V	CH	UMK105CH050CV-F	K22178253		42-	A	F2
C 1620	CHIP CAP.	10pF	50V	CH	UMK105CH100DV-F	K22178258		1-	A	F2
C 1633	CHIP CAP.	100pF	50V	CH	UMK105CH101JV-F	K22178282		1-	A	D3
C 1634	CHIP CAP.	100pF	50V	CH	UMK105CH101JV-F	K22178282		1-	A	D3
C 1635	CHIP CAP.	100pF	50V	CH	UMK105CH101JV-F	K22178282		1-	A	D3
C 1636	CHIP CAP.	100pF	50V	CH	UMK105CH101JV-F	K22178282		1-	A	D3
C 1637	CHIP CAP.	100pF	50V	CH	UMK105CH101JV-F	K22178282		1-	A	D3
C 1638	CHIP CAP.	100pF	50V	CH	UMK105CH101JV-F	K22178282		1-	A	D3
C 1639	CHIP CAP.	100pF	50V	CH	UMK105CH101JV-F	K22178282		1-	A	D3
C 1640	CHIP CAP.	100pF	50V	CH	UMK105CH101JV-F	K22178282		1-	A	D3
C 1641	CHIP CAP.	100pF	50V	CH	UMK105CH101JV-F	K22178282		1-	A	D3
C 1642	CHIP CAP.	100pF	50V	CH	UMK105CH101JV-F	K22178282		1-	A	D3
C 1643	CHIP CAP.	0.001uF	50V	B	UMK105B102KW-F	K22178829		1-	B	d3
C 1647	CHIP CAP.	10pF	50V	CH	UMK105CH100DV-F	K22178258		1-	B	e3
C 1648	CHIP CAP.	0.01uF	16V	B	GRM36B103K16PT	K22128804		1-82	A	G6
C 1648	CHIP CAP.	0.01uF	25V	B	GRM155B11E103KA01D	K22148834		83-	A	G6
C 1650	CHIP CAP.	0.001uF	50V	B	GRM188B11H102KA01D	K22174821		1-3	B	b2
C 1650	CHIP CAP.	220pF	50V	CH	GRM1882C1H221JA01D	K22174243		4-13	B	b2
C 1650	CHIP CAP.	150pF	50V	CH	GRM1882C1H151JA01D	K22174239		14-17	B	b2
C 1650	CHIP CAP.	100pF	50V	CH	GRM1882C1H101JA01D	K22174235		18-28	B	b2
C 1650	CHIP CAP.	100pF	50V	CH	GRM1882C1H101JA01D	K22174235		29-39	B	b2
C 1651	CHIP CAP.	0.001uF	50V	B	UMK105B102KW-F	K22178829		1-	A	F4
C 1652	CHIP TA.CAP.	10uF	10V		TEESVA1A106M8R	K78100028		1-	A	F1
C 1656	CHIP CAP.	10pF	50V	CH	UMK105CH100DV-F	K22178258		1-17	B	e2
C 1660	CHIP CAP.	0.1uF	10V	B	GRM155B11A104KA01D	K22108802		1-	A	F5
C 1661	CHIP CAP.	0.0033uF	50V	B	UMK105B332KW-F	K22178835		1	B	c6
C 1661	CHIP CAP.	0.01uF	16V	B	GRM36B103K16PT	K22128804		2-82	B	c6
C 1661	CHIP CAP.	0.01uF	25V	B	GRM155B11E103KA01D	K22148834		83-	B	c6
C 1662	CHIP CAP.	4pF	50V	CH	UMK105CH040CV-F	K22178252		18-	B	b6
C 1663	CHIP CAP.	100pF	50V	CH	GRM1552C1H101JD01D	K22178236	W/ CE	1-2	A	F4
C 1663	CHIP CAP.	100pF	50V	CH	GRM1552C1H101JD01D	K22178236	W/ CE	3-	A	F4
C 1664	CHIP CAP.	100pF	50V	CH	GRM1552C1H101JD01D	K22178236	W/ CE	1-2	A	H4
C 1664	CHIP CAP.	100pF	50V	CH	GRM1552C1H101JD01D	K22178236	W/ CE	3-	A	H4
C 1668	CHIP CAP.	0.001uF	50V	B	UMK105B102KW-F	K22178829	W/ CE	3-	B	h7
C 1672	CHIP TA.CAP.	1uF	16V		TEESVA1C105M8R	K78120009		1-17	B	d5
C 1674	CHIP CAP.	22pF	50V	CH	GRM1882C1H220JA01D	K22174219	W/ CE	3	A	E1
C 1674	CHIP CAP.	22pF	50V	CH	GRM1882C1H220JA01D	K22174219	W/ CE	4-17	A	E1
C 1674	CHIP CAP.	22pF	50V	CH	UMK105CH220JV-F	K22178266		18-	A	E1
C 1675	CHIP CAP.	0.01uF	16V	B	GRM36B103K16PT	K22128804		4-	A	E1
C 1675	CHIP CAP.	0.01uF	25V	B	GRM155B11E103KA01D	K22148834		83-	A	E1
C 1677	CHIP CAP.	0.01uF	16V	B	GRM36B103K16PT	K22128804		4-82	B	b2
C 1677	CHIP CAP.	0.01uF	25V	B	GRM155B11E103KA01D	K22148834		83-	B	b2
C 1678	CHIP CAP.	0.33uF	16V	B	GRM40B334K16PT	K22120807		5-	B	f3
C 1679	CHIP CAP.	0.001uF	50V	B	UMK105B102KW-F	K22178829		18-	B	h5
C 1680	CHIP CAP.	0.015uF	16V	B	GRM155B11C153KA01D	K22128807		8-	B	g3
C 1680	CHIP CAP.	0.0047uF	50V	B	GRM155B11H472KA01D	K22178838		79-	B	g3
C 1681	CHIP CAP.	18pF	50V	CH	UMK105CH180JV-F	K22178264		18-	A	D3
C 1682	CHIP CAP.	1uF	10V	F	GRM188F11A105ZA01D	K22105001		18-	A	F5
C 1683	CHIP CAP.	0.01uF	16V	B	GRM36B103K16PT	K22128804		18-	B	c2
C 1683	CHIP CAP.	0.01uF	25V	B	GRM155B11E103KA01D	K22148834		83-	B	c2
C 1684	CHIP CAP.	4pF	50V	CH	GRM1882C1H4R0CZ01D	K22174205		40-78		
C 1684	CHIP CAP.	4pF	50V	CH	GRM1882C1H4R0CZ01D	K22174205		79-80		
C 1685	CHIP CAP.	0.001uF	50V	B	UMK105B102KW-F	K22178829		73-		
CD1001	CERAMIC DISC				CDACV10M7GA001-R0-TC	H7901420		1-	A	F2
CD1002	CERAMIC DISC				CDBC455KCAY24-R0	H7900980		1-	A	A5
CF1001	CERAMIC FILTER				SFECV10M7FA00-R0-TC	H3900537		1-	A	E2
CF1002	CERAMIC FILTER				ALFYM455E=K	H3900543		1-	A	B6
CF1003	CERAMIC FILTER				ALFYM455G=K	H3900545		1-	A	A6

MAIN Unit

Parts List

REF	DESCRIPTION	VALUE	V/W	TOL.	MFR'S DESIG	VXSTD P/N	VERS.	LOT	SIDE	LAY ADR
CF1004	CERAMIC FILTER				CFJ455K14	H3900386		1-	A	B5
CF1005	CERAMIC FILTER				ALFYM455H=K	H3900542		1-	A	B5
CV1001	HELICAL RESONATOR	440MHZ			H5T-440 440M	L4020161		1-	A	E3
D 1001	DIODE				DAP236U T106	G2070592		1-	B	d4
D 1002	DIODE				DAP236U T106	G2070592		1-	B	c4
D 1003	DIODE				HSC277TRF-E	G2070584		1-	A	E3
D 1004	DIODE				BAS316	G2070716		1-	B	b1
D 1005	DIODE				BAS316	G2070716		1-	B	a2
D 1006	DIODE				UDZS TE-17 5.6B	G2070910		1-	B	a2
D 1007	DIODE				HSC277TRF-E	G2070584		1-	B	d4
D 1008	DIODE				1SV278(TPH2.F)	G2070616		1-	B	d3
D 1009	DIODE				1SV278(TPH2.F)	G2070616		1-	B	c3
D 1010	DIODE				1SS302(TE85R.F)	G2070088		1-	B	d4
D 1011	DIODE				DAP236U T106	G2070592		1-	B	d4
D 1012	DIODE				DAP236U T106	G2070592		1-	B	d3
D 1013	DIODE				BAS316	G2070716		1-	B	c3
D 1014	DIODE				1SV278(TPH2.F)	G2070616		1-	B	d2
D 1015	DIODE				1SV278(TPH2.F)	G2070616		1-	B	c3
D 1016	DIODE				HSC277TRF-E	G2070584		1-	A	E3
D 1017	DIODE				1SV278(TPH2.F)	G2070616		1-	B	c3
D 1018	DIODE				DAP236U T106	G2070592		1-	B	c1
D 1019	DIODE				DAP236U T106	G2070592		1-	A	E1
D 1020	DIODE				RB051L-40TE25	G2070718		1-	B	c6
D 1023	DIODE				1SV278(TPH2.F)	G2070616		1-	A	E1
D 1024	DIODE				1SV278(TPH2.F)	G2070616		1-	A	E1
D 1025	DIODE				DAP236U T106	G2070592		1-	B	d2
D 1026	DIODE				1SV278(TPH2.F)	G2070616		1-	A	E1
D 1027	DIODE				1SV278(TPH2.F)	G2070616		1-	A	E1
D 1028	DIODE				1SV278(TPH2.F)	G2070616		1-	A	D1
D 1029	DIODE				MA132WK-(TX)	G2070776		1-13	B	c6
D 1029	DIODE				DAN222 TL	G2070174		14-	B	c6
D 1030	DIODE				DAP236U T106	G2070592		1-	B	e1
D 1031	DIODE				DAP236U T106	G2070592		1-	A	D1
D 1032	DIODE				MC2850-T111-1	G2070704		1-88	A	E6
D 1032	DIODE				DAN217U T106	G2071236		89-	A	E6
D 1033	DIODE				DAN222 TL	G2070174		1-	B	c6
D 1034	DIODE				HSB88WS TR-E	G2070290		1-	A	D2
D 1035	DIODE				DAP236U T106	G2070592		1-	B	d2
D 1036	DIODE				HSC277TRF-E	G2070584		1-	B	d3
D 1037	DIODE				DA221 TL	G2070178		1-	B	f3
D 1038	DIODE				1SV217(TPH3)	G2070568		1-54	A	E1
D 1038	DIODE				1SV262(TPH3)	G2071106		55-	A	E1
D 1039	DIODE				DAN235U TL	G2070176		1-	B	e1
D 1040	DIODE				1SV271(TPH3.F)	G2070476		1-	B	e2
D 1041	DIODE				BAS316	G2070716		1-	B	d1
D 1043	DIODE				DA221 TL	G2070178		1-	A	C3
D 1044	DIODE				IMN10 T108	G2070078		1-	A	F6
D 1045	DIODE				HSC277TRF-E	G2070584		1-	B	e2
D 1046	DIODE				1SV229(TPH3.F)	G2070256		1-	A	B3
D 1047	DIODE				IMN10 T108	G2070078		1-	A	F6
D 1048	DIODE				IMN10 T108	G2070078		1-	A	F6
D 1049	DIODE				DAN235U TL	G2070176		1-	B	e3
D 1050	DIODE				DAN235U TL	G2070176		1-	B	e3
D 1051	DIODE				BAS316	G2070716		1-	A	B3
D 1052	DIODE				BAS316	G2070716		1-	B	h5
D 1053	DIODE				BAS316	G2070716		1-	B	f4
D 1054	DIODE				DAN235U TL	G2070176		1-	B	e3
D 1055	DIODE				BAS316	G2070716		1-	B	f4
D 1056	DIODE				BAS316	G2070716		1-	A	B4
D 1057	DIODE				DA221 TL	G2070178		1-	B	h5
D 1058	DIODE				1SS372(TE85R.F)	G2070632		1-	B	g3
D 1059	DIODE				BAS316	G2070716		1-	B	g4
D 1060	DIODE				1SV271(TPH3.F)	G2070476		1-	A	D4
D 1061	DIODE				1SS372(TE85R.F)	G2070632		1-	A	B5
D 1062	DIODE				BAS316	G2070716		1-	A	C4
D 1063	DIODE				DAP222-TL	G2070432		1-	B	g5
D 1064	DIODE				1SS372(TE85R.F)	G2070632		1-	A	D6
D 1065	DIODE				DAP222-TL	G2070432		1-	B	g6
D 1066	DIODE				BAS316	G2070716		1-	B	e5
D 1068	DIODE				BAS316	G2070716		1-	A	B5
D 1069	DIODE				DAN222 TL	G2070174		1-	B	g5
D 1070	DIODE				DAN222 TL	G2070174		1-	B	e5
D 1071	DIODE				BAS316	G2070716		1-	B	g6

MAIN Unit

Parts List

REF	DESCRIPTION	VALUE	V/W	TOL.	MFR'S DESIG	VXSTD P/N	VERS.	LOT	SIDE	LAY ADR
D 1072	DIODE				DAP222-TL	G2070432		1-	B	e6
D 1076	DIODE				DAP222-TL	G2070432		1-	B	g6
D 1077	DIODE				HZM27WA TR-E	G2070530		1-	B	b7
D 1078	DIODE				DAP222-TL	G2070432		1-	B	g5
D 1079	DIODE				DAP222-TL	G2070432		1-	A	B6
D 1080	DIODE				HZM27WA TR-E	G2070530		1-	B	a5
D 1081	DIODE				D1F20-5063	G2070474		1-	B	h3
D 1082	DIODE				BAS316	G2070716		1-	B	d6
D 1083	DIODE				DAN222 TL	G2070174		1-	A	E5
D 1084	DIODE				1SS270TJ	G2060004		7-17	B	f4
D 1084	DIODE				BAS316	G2070716		18-	B	f4
D 1085	DIODE				EDZ TE61 18B	G2070968		18-	B	c6
D 1086	DIODE				EDZ TE61 18B	G2070968		18-	B	c6
D 1087	DIODE				UDZS TE-17 5.1B	G2070908		18-	A	C4
D 1088	DIODE				UDZS TE-17 5.1B	G2070908		18-	B	f4
D 1089	DIODE				UDZS TE-17 5.1B	G2070908		18-	B	g5
D 1090	DIODE				UDZS TE-17 5.1B	G2070908		18-	A	C2
D 1091	DIODE				BAS316	G2070716		18-	A	B5
D 1092	DIODE				1SV271(TPH3.F)	G2070476		18-39	B	c2
D 1093	DIODE				HVC132TRF-E	G2071064		40-	B	c1
F 1001	CHIP FUSE	3.15A			KAB2402-322NA31010	Q0000087		1-	A	A3
FB1002	CHIP COIL				BLM21PG300SN1D	L1690840		1-	A	H1
FB1003	CHIP COIL				BLM21PG300SN1D	L1690840		1-	A	H1
FB1004	CHIP COIL				BLM21PG300SN1D	L1690840		1-	A	H1
FB1005	FERRITE BEADS				SMB304729	L9190094		1-	A	G1
FB1006	CHIP COIL				BLM21PG300SN1D	L1690840		1-	A	H1
FB1007	CHIP COIL				BLM21PG300SN1D	L1690840		1-	B	a1
FB1008	CHIP COIL				BLM21PG300SN1D	L1690840		1-	B	h7
FB1009	CHIP COIL				BLM21PG300SN1D	L1690840		1-	B	h3
FB1010	CHIP COIL				BLM21PG300SN1D	L1690840		1-	B	h5
FB1011	CHIP COIL				BLM21PG300SN1D	L1690840		1-	A	G7
FB1012	CHIP COIL				BLM21PG300SN1D	L1690840		1-	A	G7
FB1013	CHIP COIL				BLM21PG300SN1D	L1690840		1-	B	a6
FB1014	CHIP COIL				BLM21PG300SN1D	L1690840		1-	B	h4
J 1001	CONNECTOR				24FLT-SM2-TB(LF)(SN)	P1091128		1-	A	G1
J 1002	CONNECTOR				TMP-J01X-A2	P1090255		1-46	A	H5
J 1002	CONNECTOR				TMP-S01X-C1	P1091254		47-	A	H5
J 1003	CONNECTOR				TMP-J01X-A2	P1090255		1-46	A	F4
J 1003	CONNECTOR				TMP-S01X-C1	P1091254		47-	A	F4
J 1004	CONNECTOR				IMSA-9202B-1-02-T	P0091174		1-	A	F4
J 1005	CONNECTOR				M50006020-IIBA R41-9553D	P1090925		1-	A	A4
J 1006	CONNECTOR				M50-008-020 R41-9553F	P1091132		1-	A	A4
J 1009	CONNECTOR				SB20-02WS	P0090609		1-	A	A7
J 1010	CONNECTOR				B7B-ZR(LF)(SN)	P0090649		1-	A	D6
J 1011	CONNECTOR				HSJ0912-01-041	P1090749		1-	A	A6
J 1012	CONNECTOR				HSJ0912-01-040	P1091129		1-	A	A5
J 1013	CONNECTOR				SG8035#01	P1090350		1-	A	A7
J 1016	CONNECTOR				IL-WX-16SB-VF-B-E1000E	P1091130		1-17	A	G7
J 1018	CONNECTOR				SB20-06WS	P0090613		1-	A	H6
J 1019	CONNECTOR				9210B-1-03Z172-T	P0091282		1-		
J 1020	CONNECTOR				9210B-1-04Z172-T	P0091283		1-		
J 1021	CONNECTOR				9210B-1-03Z172-T	P0091282		1-17		
J 1021	CONNECTOR				9210B-1-04Z172-T	P0091283		18-		
J 1022	CONNECTOR				9210B-1-03Z172-T	P0091282		1-		
J 1023	CONNECTOR				9210B-1-04Z172-T	P0091283		1-		
J 1024	CONNECTOR				9210B-1-04Z172-T	P0091283		1-17		
J 1024	CONNECTOR				9210B-1-03Z172-T	P0091282		18-		
J 1025	CONNECTOR				290A-88-30-335-F	P1091047		1-	A	H7
J 1027	CONNECTOR				IMSA-9202B-1-03-T	P0091291		18-	A	A2
L 1001	COIL				E2 0.4-3.0-9.5T-L	L0022575		1-	A	H4
L 1002	M.RFC	10uH			CDRH74-100MC	L1690599		1-	A	H4
L 1003	CHIP COIL	330uH			LQH32MN331K23L	L1690105		1-	B	c4
L 1004	COIL				E2 0.4-3.0-9.5T-L	L0022575		1-	A	G4
L 1005	M.RFC	10uH			CDRH74-100MC	L1690599		1-	A	G4
L 1006	M.RFC	0.022uH			HK1608 22NJ-T	L1690520		1-	A	G3
L 1007	M.RFC	0.022uH			HK1608 22NJ-T	L1690520		1-	A	H3
L 1008	M.RFC	0.0027uH			HK1608 2N7S-T	L1690509		1-	A	G3
L 1009	M.RFC	0.0027uH			HK1608 2N7S-T	L1690509		1-	A	G3
L 1010	M.RFC	10uH			CDRH74-100MC	L1690599		1-	A	G2
L 1011	COIL				E2 0.3-1.7-7T-R	L0022372		1-	A	G2
L 1012	M.RFC	0.039uH			HK1608 39NJ-T	L1690523		1-	B	a2
L 1013	M.RFC	0.0056uH			HK1608 5N6S-T	L1690513		1-	B	b2
L 1014	M.RFC	10uH			7B05NB-100M	L1690988		1-16	A	F3

MAIN Unit

Parts List

REF	DESCRIPTION	VALUE	V/W	TOL.	MFR'S DESIG	VXSTD P/N	VERS.	LOT	SIDE	LAY ADR
L 1014	M.RFC	10uH			7E05NB-100M	L1691221		17-	A	F3
L 1015	COIL				E2 0.25-1.85-8.5T-L	L0022576		1-	A	G3
L 1016	M.RFC	0.039uH			HK1608 39NJ-T	L1690523		1-78	B	b2
L 1016	M.RFC	0.022uH			HK1608 22NJ-T	L1690520		79-	B	b2
L 1017	M.RFC	0.012uH			HK1608 12NJ-T	L1690517		1-	B	b2
L 1018	M.RFC	4.7uH			ELJ-FC4R7KF	L1690348		1-	A	G2
L 1019	M.RFC	0.056uH			HK1608 56NJ-T	L1690525		1-13	B	c2
L 1019	M.RFC	0.022uH			HK1608 22NJ-T	L1690520		14-78	B	c2
L 1019	M.RFC	0.039uH			HK1608 39NJ-T	L1690523		79-80	B	c2
L 1019	M.RFC	0.033uH			HK1608 33NJ-T	L1690522		81-	B	c2
L 1020	M.RFC	0.068uH			HK1608 68NJ-T	L1690526		1-	B	d4
L 1021	M.RFC	15uH			LAL03TA150K	L1790097		1-	A	F2
L 1023	M.RFC	10uH			LK1608 100K-T	L1690689		1-	A	F1
L 1024	M.RFC	0.015uH			HK1608 15NJ-T	L1690518		1-	B	d4
L 1025	M.RFC	0.022uH			HK1608 22NJ-T	L1690520		1-	B	d4
L 1026	CHIP COIL	0.1uH			C2520C-R10J	L1690544		1-	B	d1
L 1027	COIL				E2 0.28-1.0-4T-R	L0022365		1-	A	E1
L 1028	CHIP COIL	0.47uH			C2520C-R47J	L1690552		1-	B	d1
L 1029	CHIP COIL	0.047uH			C2520C-47NK	L1690540		1-	B	d1
L 1030	CHIP COIL	0.27uH			C2520C-R27J	L1690549		1-6	B	d1
L 1030	CHIP COIL	0.18uH			C2520C-R18J	L1690547		7-78	B	d1
L 1030	CHIP COIL	0.39uH		2%	C2520C-R39G	L1691301		79-	B	d1
L 1031	COIL				E2 0.28-1.0-4T-R	L0022365		1-	A	D1
L 1032	CHIP COIL	0.47uH			C2520C-R47J	L1690552		1-	B	d1
L 1033	CHIP COIL	0.22uH			C2520C-R22J	L1690548		1-6	B	d1
L 1033	CHIP COIL	0.15uH			C2520C-R15J	L1690546		7-78	B	d1
L 1033	CHIP COIL	0.33uH		2%	C2520C-R33G	L1691300		79-	B	d1
L 1034	CHIP COIL	0.1uH			C2520C-R10J	L1690544		1-	B	e1
L 1035	COIL				E2 0.28-1.0-4T-R	L0022365		1-	A	D1
L 1036	M.RFC	0.12uH			LK1608 R12K-T	L1690408		1-	B	d3
L 1037	CHIP COIL	0.082uH			C2520C-82NK	L1690543		1-	A	D1
L 1038	M.RFC	0.15uH			LK1608 R15K-T	L1690409		1-	B	d3
L 1039	M.RFC	4.7uH			LK1608 4R7K-T	L1690688		1-	B	h1
L 1040	CHIP COIL	0.033uH			C2520C-33NK	L1690538		1-	A	F2
L 1041	CHIP COIL	0.33uH			C2520C-R33J	L1690550		1-	A	E2
L 1042	M.RFC	10uH			LK1608 100K-T	L1690689		1-	B	h1
L 1043	M.RFC	10uH			LK1608 100K-T	L1690689		1-	B	h1
L 1044	CHIP COIL	0.033uH			C2520C-33NK	L1690538		1-	A	E2
L 1045	M.RFC	2.2uH			LK1608 2R2K-T	L1690634		1-	B	f3
L 1046	CHIP COIL	330uH			LQH32MN331K23L	L1690105		1-	A	E3
L 1047	M.RFC	0.15uH			HK1608 R15J-T	L1690938		1-	B	e2
L 1048	COIL				E2 0.25-1.85-8.5T-L	L0022576		1-	A	E2
L 1049	COIL 05RF				2.7UH 020812327	L0022833		1-	A	C3
L 1050	M.RFC	10uH			LK1608 100K-T	L1690689		1-	B	h2
L 1051	M.RFC	10uH			LK1608 100K-T	L1690689		1-	B	h2
L 1052	M.RFC	10uH			LK1608 100K-T	L1690689		1-	A	C3
L 1053	M.RFC	10uH			LK1608 100K-T	L1690689		1-	A	D3
L 1054	M.RFC	470uH			FLC32T-471J	L1690235		1-	B	e5
L 1055	M.RFC	470uH			FLC32T-471J	L1690235		1-	A	B4
L 1056	M.RFC	470uH			FLC32T-471J	L1690235		1-	B	g5
L 1057	CHIP COIL	10uH			C2520F-100K	L1690596		18-61	B	b4
L 1057	CHIP COIL	10uH		5%	NLV-25T-100J-PF	L1691436		62-	B	b4
L 1058	CHIP COIL	10uH			C2520F-100K	L1690596		18-61	B	b4
L 1058	CHIP COIL	10uH		5%	NLV-25T-100J-PF	L1691436		62-	B	b4
L 1059	CHIP COIL	10uH			C2520F-100K	L1690596		18-61	B	b4
L 1059	CHIP COIL	10uH		5%	NLV-25T-100J-PF	L1691436		62-72	B	b4
L 1059	CHIP COIL	0.01uH		2%	C2520C-10NG	L1691283		75-	B	b4
L 1060	M.RFC	470uH			FLC32T-471J	L1690235		1-	B	f4
L 1061	M.RFC	22uH			LK2125 220M-T	L1690335		1-	A	H5
L 1062	M.RFC	22uH			LK2125 220M-T	L1690335		1-	A	H5
L 1063	M.RFC	22uH			LK2125 220M-T	L1690335		1-	A	H5
L 1064	M.RFC	22uH			LK2125 220M-T	L1690335		1-	A	H6
L 1065	M.RFC	22uH			LK2125 220M-T	L1690335		1-	A	H6
L 1066	M.RFC	22uH			LK2125 220M-T	L1690335		1-	A	H6
L 1067	COIL				E2 0.26-0.9-3T-R	L0022367		1-	A	F2
L 1068	COIL				E2 0.28-1.0-4T-R	L0022365		1-	A	F2
L 1069	M.RFC	0.015uH			HK1608 15NJ-T	L1690518	W/ CE	3-17	A	E1
L 1069	M.RFC	0.015uH			HK1608 15NJ-T	L1690518		18-	A	E1
P 1001	CONNECTOR				IMSA-9206H-T	P1090988		1-		
P 1002	CONNECTOR				IMSA-9206H-T	P1090988		18-		
Q 1001	FET				2SK2975-T11	G3829757		1-13	A	G3
Q 1001	FET				RD07MVS1-T12	G3070320		14-	A	G3
Q 1002	FET				2SK2975-T11	G3829757		1-13	A	H3

MAIN Unit

Parts List

REF	DESCRIPTION	VALUE	V/W	TOL.	MFR'S DESIG	VXSTD P/N	VERS.	LOT	SIDE	LAY ADR
Q 1002	FET				RD07MVS1-T12	G3070320		14-	A	H3
Q 1003	IC				BU4094BCFV-E2	G1093527		1-16	A	E4
Q 1003	IC				CD4094BPWR	G1093866		17-	A	E4
Q 1004	IC				BU4094BCFV-E2	G1093527		1-16	A	E4
Q 1004	IC				CD4094BPWR	G1093866		17-	A	E4
Q 1005	TRANSISTOR				2SC4154-T111-1E	G3341548E		1-88	B	b2
Q 1005	TRANSISTOR				2SC4081 T106	G3340818		89-	B	b2
Q 1006	FET				2SK2973-T13	G3829738		1-13	A	G2
Q 1006	FET				RD01MUS1-T113	G3070321		14-	A	G2
Q 1007	FET				2SK2973-T13	G3829738		1-13	A	G2
Q 1007	FET				RD01MUS1-T113	G3070321		14-	A	G2
Q 1008	TRANSISTOR				2SC4154-T111-1E	G3341548E		1-88	B	b2
Q 1008	TRANSISTOR				2SC4081 T106	G3340818		89-	B	b2
Q 1009	TRANSISTOR				2SC4154-T111-1E	G3341548E		1-88	B	a1
Q 1009	TRANSISTOR				2SC4081 T106	G3340818		89-	B	a1
Q 1010	IC				BU4094BCFV-E2	G1093527		1-16	A	D4
Q 1010	IC				CD4094BPWR	G1093866		17-	A	D4
Q 1011	FET				2SK2596BXTL-E	G3825967		1-	B	b2
Q 1012	TRANSISTOR				2SC4154-T111-1E	G3341548E		1-88	B	a1
Q 1012	TRANSISTOR				2SC4081 T106	G3340818		89-	B	a1
Q 1013	TRANSISTOR				2SB624-T2B BV3	G3206247C		1-	A	F1
Q 1014	IC				KIA7808API	G1093164		1-	A	F1
Q 1015	TRANSISTOR				FMG5 T148	G3070021		1-	A	G1
Q 1016	IC				M62352GP-70EC	G1092689		1-	A	E4
Q 1017	TRANSISTOR				2SC3357-T2	G3333577		1-	B	b2
Q 1018	TRANSISTOR				UMC5N TR	G3070137		1-	A	F1
Q 1019	IC				BA05FP-E2	G1093209		1-	B	b1
Q 1020	TRANSISTOR				2SB624-T2B BV3	G3206247C		1-	A	F1
Q 1021	TRANSISTOR				RT1N241M-T11-1	G3070249		1-88	B	c3
Q 1021	TRANSISTOR				DTC124EU T106	G3070045		89-	B	c3
Q 1022	IC				UPC2710T-E3	G1091844		1-17	B	c1
Q 1022	IC				UPC2710TB-E3	G1093932		18-	B	c1
Q 1023	IC				BB304CDW-TL	G1093324		1-	B	d3
Q 1024	IC				BB304CDW-TL	G1093324		1-	B	c3
Q 1025	TRANSISTOR				2SC5374-TL	G3353748		1-	B	d3
Q 1026	FET				2SK2685ZT-TR	G3826857		1-17	B	d4
Q 1026	FET				NE34018-T1	G3070328		18-89	B	d4
Q 1026	FET				NE3509M04-T2-A	G3070387		90-	B	d4
Q 1027	TRANSISTOR				UMH6N TR	G3070216		1-	B	d3
Q 1028	IC				BA05FP-E2	G1093209		1-	B	c7
Q 1029	TRANSISTOR				UMD2N TR	G3070076		1-	B	d3
Q 1030	IC				PST3445UR	G1093232		1-	B	b7
Q 1031	FET				2SJ355-T1	G3703558		1-	B	c6
Q 1032	TRANSISTOR				RT1N241M-T11-1	G3070249		1-88	B	c6
Q 1032	TRANSISTOR				DTC124EU T106	G3070045		89-	B	c6
Q 1033	TRANSISTOR				UMC5N TR	G3070137		1-	B	c3
Q 1034	TRANSISTOR				UMC5N TR	G3070137		1-	B	c3
Q 1035	TRANSISTOR				RT1N241M-T11-1	G3070249		1-88	B	c6
Q 1035	TRANSISTOR				DTC124EU T106	G3070045		89-	B	c6
Q 1036	TRANSISTOR				2SA1602A-T111-1F	G3116028F		1-78	A	F7
Q 1036	TRANSISTOR				ISA1602AM1-T111-1F	G3070380		79-88	A	F7
Q 1036	TRANSISTOR				2SA1576A T106 R	G3115768R		89-	A	F7
Q 1037	TRANSISTOR				2SC4154-T111-1E	G3341548E		1-88	A	F7
Q 1037	TRANSISTOR				2SC4081 T106	G3340818		89-	A	F7
Q 1038	IC				TC4W53FU(TE12L_F)	G1091675		1-	A	E6
Q 1039	TRANSISTOR				2SC4154-T111-1E	G3341548E		1-88	B	b6
Q 1039	TRANSISTOR				2SC4081 T106	G3340818		89-	B	b6
Q 1040	TRANSISTOR				2SA1602A-T111-1F	G3116028F		1-78	B	b6
Q 1040	TRANSISTOR				ISA1602AM1-T111-1F	G3070380		79-88	B	b6
Q 1040	TRANSISTOR				2SA1576A T106 R	G3115768R		89-	B	b6
Q 1041	TRANSISTOR				2SC4400-3-TL	G3344008C		1-	B	f3
Q 1042	TRANSISTOR				2SC4154-T111-1E	G3341548E		1-88	B	f3
Q 1042	TRANSISTOR				2SC4081 T106	G3340818		89-	B	f3
Q 1043	TRANSISTOR				2SC4400-3-TL	G3344008C		1-	B	h1
Q 1044	TRANSISTOR				2SC4154-T111-1E	G3341548E		1-88	B	f3
Q 1044	TRANSISTOR				2SC4081 T106	G3340818		89-	B	f3
Q 1045	TRANSISTOR				2SC4154-T111-1E	G3341548E		1-88	B	f3
Q 1045	TRANSISTOR				2SC4081 T106	G3340818		89-	B	f3
Q 1046	TRANSISTOR				2SC4400-3-TL	G3344008C		1-	B	h1
Q 1047	TRANSISTOR				RT1N241M-T11-1	G3070249		1-88	A	E5
Q 1047	TRANSISTOR				DTC124EU T106	G3070045		89-	A	E5
Q 1048	TRANSISTOR				2SC4400-3-TL	G3344008C		1-	B	h1
Q 1049	IC				HD64F2134ATF20V	✳		18-	A	F5

✳ Please contact VERTEX STANDARD.

MAIN Unit

Parts List

REF	DESCRIPTION	VALUE	V/W	TOL.	MFR'S DESIG	VXSTD P/N	VERS.	LOT	SIDE	LAY ADR
Q 1050	TRANSISTOR				2SA1602A-T111-1F	G3116028F		1-78	B	f3
Q 1050	TRANSISTOR				ISA1602AM1-T111-1F	G3070380		79-88	B	f3
Q 1050	TRANSISTOR				2SA1576A T106 R	G3115768R		89-	B	f3
Q 1051	TRANSISTOR				2SC4400-3-TL	G3344008C		1-	B	f3
Q 1052	TRANSISTOR				2SC4400-3-TL	G3344008C		1-	B	g3
Q 1053	TRANSISTOR				DTC114EUA T106	G3070084		1-	A	F5
Q 1054	TRANSISTOR				2SC4154-T111-1E	G3341548E		1-88	B	c1
Q 1054	TRANSISTOR				2SC4081 T106	G3340818		89-	B	c1
Q 1055	TRANSISTOR				2SC4154-T111-1E	G3341548E		1-88	B	e2
Q 1055	TRANSISTOR				2SC4081 T106	G3340818		89-	B	e2
Q 1056	TRANSISTOR				2SC4400-3-TL	G3344008C		1-	B	f3
Q 1057	TRANSISTOR				2SC4154-T111-1E	G3341548E		1-88	A	C3
Q 1057	TRANSISTOR				2SC4081 T106	G3340818		89-	A	C3
Q 1058	IC				CXA1611N-T4	G1092695		1-	B	c2
Q 1059	TRANSISTOR				2SC4400-3-TL	G3344008C		1-	B	h2
Q 1060	TRANSISTOR				UMC5N TR	G3070137		1-	A	C3
Q 1061	IC				BB304CDW-TL	G1093324		1-17	B	e2
Q 1061	IC				BB301CAW-TL	G1093186		18-	B	e2
Q 1062	IC				AD9835BRUZ-REEL7	G1093142		1-	B	h2
Q 1063	TRANSISTOR				UMC5N TR	G3070137		1-	B	c2
Q 1064	TRANSISTOR				2SC4154-T111-1E	G3341548E		1-88	A	D2
Q 1064	TRANSISTOR				2SC4081 T106	G3340818		89-	A	D2
Q 1065	IC				24LC128T-I/SN	G1093668		1-	A	F4
Q 1066	IC				BU4053BCFV-E2	G1093422		1-16	B	d5
Q 1066	IC				CD4053BPWR	G1093864		17-	B	d5
Q 1067	IC				TC4W53FU(TE12L_F)	G1091675		1-	B	d5
Q 1068	TRANSISTOR				2SC4154-T111-1E	G3341548E		1-88	B	f4
Q 1068	TRANSISTOR				2SC4081 T106	G3340818		89-	B	f4
Q 1069	TRANSISTOR				2SC4154-T111-1E	G3341548E		1-88	A	B4
Q 1069	TRANSISTOR				2SC4081 T106	G3340818		89-	A	B4
Q 1070	TRANSISTOR				2SC4154-T111-1E	G3341548E		1-88	B	g3
Q 1070	TRANSISTOR				2SC4081 T106	G3340818		89-	B	g3
Q 1071	IC				SA602AD/01.118	G1093612		1-	A	B4
Q 1073	IC				BB305CEW-TL	G1093677		1-17	B	e4
Q 1073	IC				BB301CAW-TL	G1093186		18-	B	e4
Q 1074	TRANSISTOR				2SC4154-T111-1E	G3341548E		1-88	B	h5
Q 1074	TRANSISTOR				2SC4081 T106	G3340818		89-	B	h5
Q 1075	IC				BB305CEW-TL	G1093677		1-	B	e5
Q 1076	TRANSISTOR				2SC4154-T111-1E	G3341548E		1-88	B	g4
Q 1076	TRANSISTOR				2SC4081 T106	G3340818		89-	B	g4
Q 1077	TRANSISTOR				2SC4154-T111-1E	G3341548E		1-88	A	D5
Q 1077	TRANSISTOR				2SC4081 T106	G3340818		89-	A	D5
Q 1078	TRANSISTOR				2SC4154-T111-1E	G3341548E		1-88	B	h6
Q 1078	TRANSISTOR				2SC4081 T106	G3340818		89-	B	h6
Q 1079	IC				BB305CEW-TL	G1093677		1-	B	e5
Q 1080	IC				TA31136FNG(EL)	G1091605		1-	B	g5
Q 1081	IC				BB305CEW-TL	G1093677		1-17	B	g5
Q 1081	IC				BB301CAW-TL	G1093186		18-	B	g5
Q 1082	IC				SA602AD/01.118	G1093612		1-	A	C4
Q 1083	FET				2SK302Y(TE85R.F)	G3803027Y		1-	B	f4
Q 1084	FET				2SK302Y(TE85R.F)	G3803027Y		1-	B	f5
Q 1085	TRANSISTOR				2SC4154-T111-1E	G3341548E		1-88	A	D5
Q 1085	TRANSISTOR				2SC4081 T106	G3340818		89-	A	D5
Q 1086	TRANSISTOR				RT1N241M-T11-1	G3070249		1-88	A	B5
Q 1086	TRANSISTOR				DTC124EU T106	G3070045		89-	A	B5
Q 1087	IC				M62364FP 600D	G1093033		1-	B	g3
Q 1088	IC				BB305CEW-TL	G1093677		1-17	B	g5
Q 1088	IC				BB301CAW-TL	G1093186		18-	B	g5
Q 1089	IC				BB304CDW-TL	G1093324		1-	B	f4
Q 1090	TRANSISTOR				2SC4154-T111-1E	G3341548E		1-88	A	B5
Q 1090	TRANSISTOR				2SC4081 T106	G3340818		89-	A	B5
Q 1091	TRANSISTOR				RT1N241M-T11-1	G3070249		1-88	B	g5
Q 1091	TRANSISTOR				DTC124EU T106	G3070045		89-	B	g5
Q 1092	IC				AK7712AVT	G1093815		18-	B	b5
Q 1093	TRANSISTOR				2SC4154-T111-1E	G3341548E		1-88	A	D6
Q 1093	TRANSISTOR				2SC4081 T106	G3340818		89-	A	D6
Q 1094	TRANSISTOR				2SC4154-T111-1E	G3341548E		1-88	B	g6
Q 1094	TRANSISTOR				2SC4081 T106	G3340818		89-	B	g6
Q 1095	IC				TA75S01F(TE85R.F)	G1091593		1-	A	A4
Q 1096	TRANSISTOR				2SC4154-T111-1E	G3341548E		1-88	B	f5
Q 1096	TRANSISTOR				2SC4081 T106	G3340818		89-	B	f5
Q 1097	TRANSISTOR				2SC4154-T111-1E	G3341548E		1-88	B	e6
Q 1097	TRANSISTOR				2SC4081 T106	G3340818		89-	B	e6

MAIN Unit

Parts List

REF	DESCRIPTION	VALUE	V/W	TOL.	MFR'S DESIG	VXSTD P/N	VERS.	LOT	SIDE	LAY ADR
Q 1098	IC				TC4W53FU(TE12L_F)	G1091675		1-	B	g3
Q 1099	TRANSISTOR				2SA1602A-T111-1F	G3116028F		1-78	B	e6
Q 1099	TRANSISTOR				ISA1602AM1-T111-1F	G3070380		79-88	B	e6
Q 1099	TRANSISTOR				2SA1576A T106 R	G3115768R		89-	B	e6
Q 1100	IC				TC4S66F(TE85R.F)	G1090893		1-	A	A4
Q 1102	TRANSISTOR				DTC114EUA T106	G3070084		18-	B	b5
Q 1103	IC				M51132FP 600C	G1091930		1-	B	d6
Q 1104	TRANSISTOR				FMG5 T148	G3070021		1-	B	g6
Q 1105	IC				TDA2003H	G1090815		1-	A	E7
Q 1106	TRANSISTOR				FMG5 T148	G3070021		1-	B	g6
Q 1107	TRANSISTOR				RT1N241M-T11-1	G3070249		1-88	B	g6
Q 1107	TRANSISTOR				DTC124EU T106	G3070045		89-	B	g6
Q 1108	TRANSISTOR				2SD2211 T100 QR	G3422117Q		1-	B	h3
Q 1109	TRANSISTOR				2SC4154-T111-1E	G3341548E		1-88	B	b6
Q 1109	TRANSISTOR				2SC4081 T106	G3340818		89-	B	b6
Q 1110	TRANSISTOR				DTC114EUA T106	G3070084		1-	B	d6
Q 1111	IC				NJM2902V-TE1	G1091679		1-	B	b1
Q 1112	IC				NJM2904V-TE1	G1091677		1-	B	a1
Q 1113	IC				BU4011BF-E2	G1092724		1-	A	G5
Q 1114	IC				NJM2902V-TE1	G1091679		1-	A	E5
Q 1115	IC				NJM2902V-TE1	G1091679		18-	B	c5
Q 1116	IC				NJM2902V-TE1	G1091679		18-	B	c5
Q 1117	IC				NJM2904V-TE1	G1091677		1-	B	e4
Q 1118	IC				NJM2902V-TE1	G1091679		1-	B	g3
Q 1119	IC				NJM2902V-TE1	G1091679		1-	B	g3
Q 1120	IC				NJM2902V-TE1	G1091679		1-	A	B3
Q 1121	IC				BU4066BCFV-E2	G1093537		1-16	A	B3
Q 1121	IC				CD4066BPWR	G1093865		17-	A	B3
Q 1122	IC				BU4066BCFV-E2	G1093537		1-	A	B3
Q 1123	IC				NJM2904V-TE1	G1091677		1-	B	g4
Q 1124	TRANSISTOR				UMH6N TR	G3070216		1-	A	D6
Q 1125	TRANSISTOR				UMH6N TR	G3070216		1-	B	e6
Q 1126	TRANSISTOR				UMH6N TR	G3070216		1-	B	g6
Q 1128	IC				SPM5001-TL-E	G1093686		1-	A	D2
Q 1129	IC				TC4S81F(TE85R.F)	G1090895		1-	A	G6
R 1001	CHIP RES.	470	1/16W	5%	RMC1/16S 471JTH	J24189021		1-	B	a1
R 1002	CHIP RES.	470	1/16W	5%	RMC1/16S 471JTH	J24189021		1-	B	a1
R 1003	CHIP RES.	470	1/16W	5%	RMC1/16S 471JTH	J24189021		1-	B	a1
R 1004	CHIP RES.	470	1/16W	5%	RMC1/16S 471JTH	J24189021		1-	B	b1
R 1005	CHIP RES.	470	1/16W	5%	RMC1/16S 471JTH	J24189021		1-	B	b1
R 1006	CHIP RES.	470	1/16W	5%	RMC1/16S 471JTH	J24189021		1-	A	G1
R 1007	CHIP RES.	470	1/16W	5%	RMC1/16S 471JTH	J24189021		1-	A	G1
R 1008	CHIP RES.	470	1/16W	5%	RMC1/16S 471JTH	J24189021		1-	A	G1
R 1010	CHIP RES.	470	1W	5%	RMC1 471JTE	J24305471		1-	B	a4
R 1011	CHIP RES.	470	1W	5%	RMC1 471JTE	J24305471		1-	B	b4
R 1012	CHIP RES.	470	1/16W	5%	RMC1/16S 471JTH	J24189021		1-	B	c4
R 1013	CHIP RES.	220	1W	5%	RMC1 221JTE	J24305221		1-	A	G3
R 1014	CHIP RES.	220	1W	5%	RMC1 221JTE	J24305221		1-	A	H3
R 1015	CHIP RES.	330	1/16W	5%	RMC1/16 331JATP	J24185331		1-13	A	F3
R 1015	CHIP RES.	820	1/16W	5%	RMC1/16 821JATP	J24185821		14-	A	F3
R 1016	CHIP RES.	56	1/16W	5%	RMC1/16 560JATP	J24185560		1-	A	G3
R 1017	CHIP RES.	220	1/16W	5%	RMC1/16 221JATP	J24185221		1-13	A	G3
R 1017	CHIP RES.	470	1/16W	5%	RMC1/16 471JATP	J24185471		14-	A	G3
R 1018	CHIP RES.	100k	1/16W	5%	RMC1/16S 104JTH	J24189049		1-	B	b1
R 1019	CHIP RES.	100k	1/16W	5%	RMC1/16S 104JTH	J24189049		1-	B	a1
R 1020	CHIP RES.	330	1/16W	5%	RMC1/16 331JATP	J24185331		1-13	A	H3
R 1020	CHIP RES.	820	1/16W	5%	RMC1/16 821JATP	J24185821		14-	A	H3
R 1021	CHIP RES.	56	1/16W	5%	RMC1/16 560JATP	J24185560		1-	A	H3
R 1022	CHIP RES.	220	1/16W	5%	RMC1/16 221JATP	J24185221		1-13	A	G3
R 1022	CHIP RES.	470	1/16W	5%	RMC1/16 471JATP	J24185471		14-	A	G3
R 1023	CHIP RES.	470	1/16W	5%	RMC1/16S 471JTH	J24189021		1-	A	E5
R 1024	CHIP RES.	470	1/16W	5%	RMC1/16S 471JTH	J24189021		1-	A	E5
R 1025	CHIP RES.	10k	1/16W	5%	RMC1/16S 103JTH	J24189037		1-	B	b1
R 1026	CHIP RES.	47k	1/16W	5%	RMC1/16S 473JTH	J24189045		1-	B	b1
R 1027	CHIP RES.	2.2M	1/16W	5%	RMC1/16S 225JTH	J24189065		1-	B	b1
R 1028	CHIP RES.	100k	1/16W	5%	RMC1/16S 104JTH	J24189049		1-	B	b2
R 1029	CHIP RES.	68k	1/16W	5%	RMC1/16S 683JTH	J24189047		1-78	B	b2
R 1031	CHIP RES.	470	1/2W	5%	RMC1/2 471JCTP	J24275471		1-	B	b2
R 1032	CHIP RES.	4.7k	1/16W	5%	RMC1/16S 472JTH	J24189033		1-	B	a2
R 1033	CHIP RES.	220	1/4W	5%	RMC1/4 221JATP	J24245221		1-	B	a2
R 1034	CHIP RES.	100k	1/16W	5%	RMC1/16S 104JTH	J24189049		1-	B	b2
R 1035	CHIP RES.	2.7k	1/16W	5%	RMC1/16S 272JTH	J24189030		1-13	A	F2
R 1035	CHIP RES.	1.5k	1/16W	5%	RMC1/16S 152JTH	J24189027		14-	A	F2

MAIN Unit

Parts List

REF	DESCRIPTION	VALUE	V/W	TOL.	MFR'S DESIG	VXSTD P/N	VERS.	LOT	SIDE	LAY ADR
R 1036	CHIP RES.	10k	1/16W	5%	RMC1/16S 103JTH	J24189037		1-	B	b2
R 1037	CHIP RES.	470	1/16W	5%	RMC1/16S 471JTH	J24189021		1-	A	E5
R 1038	CHIP RES.	10	1/16W	5%	RMC1/16 100JATP	J24185100		1-	A	G2
R 1039	CHIP RES.	10	1/16W	5%	RMC1/16 100JATP	J24185100		1-	A	G2
R 1041	CHIP RES.	56	1/16W	5%	RMC1/16 560JATP	J24185560		1-	A	G2
R 1042	CHIP RES.	1k	1/16W	5%	RMC1/16 102JATP	J24185102		1-	A	G2
R 1043	CHIP RES.	4.7k	1/16W	5%	RMC1/16S 472JTH	J24189033		1-	B	b2
R 1044	CHIP RES.	2.2M	1/16W	5%	RMC1/16S 225JTH	J24189065		1-	B	b2
R 1045	CHIP RES.	10	1/16W	5%	RMC1/16S 100JTH	J24189001		1-	B	a2
R 1046	CHIP RES.	2.2k	1/16W	5%	RMC1/16S 222JTH	J24189029		1-	B	a2
R 1047	CHIP RES.	10k	1/16W	5%	RMC1/16S 103JTH	J24189037		1-3	B	a2
R 1048	CHIP RES.	270	1/16W	5%	RMC1/16 271JATP	J24185271		1-78	B	b3
R 1048	CHIP RES.	68	1/16W	5%	RMC1/16 680JATP	J24185680		79-	B	b3
R 1049	CHIP RES.	330	1/16W	5%	RMC1/16S 331JTH	J24189019		1-3	B	b1
R 1049	CHIP RES.	3.3k	1/16W	5%	RMC1/16S 332JTH	J24189031		4-	B	b1
R 1050	CHIP RES.	470	1/10W	5%	RMC1/10T 471J	J24205471		1-	B	b3
R 1051	CHIP RES.	470k	1/16W	5%	RMC1/16S 474JTH	J24189057		1-	B	a2
R 1052	CHIP RES.	1.8k	1/16W	5%	RMC1/16S 182JTH	J24189028		1-12	A	F2
R 1052	CHIP RES.	1.2k	1/16W	5%	RMC1/16S 122JTH	J24189026		13-	A	F2
R 1053	CHIP RES.	100	1/16W	5%	RMC1/16 101JATP	J24185101		1-	A	F2
R 1054	CHIP RES.	470	1/16W	5%	RMC1/16 471JATP	J24185471		1-12	B	b2
R 1054	CHIP RES.	330	1/16W	5%	RMC1/16 331JATP	J24185331		13-	B	b2
R 1057	CHIP RES.	3.3k	1/16W	5%	RMC1/16S 332JTH	J24189031		1-	A	F1
R 1058	CHIP RES.	10k	1/16W	5%	RMC1/16S 103JTH	J24189037		1-	B	a1
R 1059	CHIP RES.	47k	1/16W	5%	RMC1/16S 473JTH	J24189045		1-	B	a1
R 1060	CHIP RES.	3.3k	1/16W	5%	RMC1/16S 332JTH	J24189031		1-	B	a1
R 1061	CHIP RES.	100	1/16W	5%	RMC1/16 101JATP	J24185101		1-	A	G2
R 1062	CHIP RES.	56	1/16W	5%	RMC1/16 560JATP	J24185560		1-28	B	b2
R 1062	CHIP RES.	100	1/16W	5%	RMC1/16 101JATP	J24185101		29-	B	b2
R 1063	CHIP RES.	10k	1/16W	5%	RMC1/16S 103JTH	J24189037		1-	B	a1
R 1064	CHIP RES.	390	1/16W	5%	RMC1/16S 391JTH	J24189020		1-	A	E4
R 1065	CHIP RES.	100	1/16W	5%	RMC1/16 101JATP	J24185101		1-	B	b2
R 1066	CHIP RES.	4.7k	1/16W	5%	RMC1/16S 472JTH	J24189033		1-17	A	E5
R 1066	CHIP RES.	1k	1/16W	5%	RMC1/16S 102JTH	J24189025		18-	A	E5
R 1067	CHIP RES.	47k	1/16W	5%	RMC1/16S 473JTH	J24189045		1-	B	a1
R 1068	CHIP RES.	470	1/16W	5%	RMC1/16S 471JTH	J24189021		1-	A	E5
R 1069	CHIP RES.	10k	1/16W	5%	RMC1/16S 103JTH	J24189037		1-	B	a1
R 1070	CHIP RES.	0	1/16W	5%	RMC1/16 000JATP	J24185000		1-3	A	F2
R 1070	CHIP RES.	2.2k	1/16W	5%	RMC1/16 222JATP	J24185222		4-	A	F2
R 1071	CHIP RES.	1.8k	1/16W	5%	RMC1/16 182JATP	J24185182		1-	B	c2
R 1072	CHIP RES.	1.8k	1/16W	5%	RMC1/16 182JATP	J24185182		1-	B	b2
R 1073	CHIP RES.	10k	1/16W	5%	RMC1/16S 103JTH	J24189037		1-	B	a1
R 1074	CHIP RES.	470	1/16W	5%	RMC1/16S 471JTH	J24189021		1-	A	E5
R 1075	CHIP RES.	1k	1/16W	5%	RMC1/16S 102JTH	J24189025		1-	A	F1
R 1076	CHIP RES.	10k	1/16W	5%	RMC1/16S 103JTH	J24189037		1-	A	E4
R 1077	CHIP RES.	470	1/16W	5%	RMC1/16S 471JTH	J24189021		1-	A	E5
R 1078	CHIP RES.	10k	1/16W	5%	RMC1/16S 103JTH	J24189037		1-	A	E2
R 1079	CHIP RES.	220k	1/16W	5%	RMC1/16S 224JTH	J24189053		1-	B	a1
R 1080	CHIP RES.	120	1/16W	5%	RMC1/16 121JATP	J24185121		1-78	B	c2
R 1080	CHIP RES.	82	1/16W	5%	RMC1/16 820JATP	J24185820		79-	B	c2
R 1082	CHIP RES.	100k	1/16W	5%	RMC1/16S 104JTH	J24189049		1-	B	d3
R 1083	CHIP RES.	2.2k	1/16W	5%	RMC1/16S 222JTH	J24189029		1-	B	d4
R 1084	CHIP RES.	47k	1/16W	5%	RMC1/16S 473JTH	J24189045		1-	B	a1
R 1085	CHIP RES.	470	1/16W	5%	RMC1/16S 471JTH	J24189021		1-	B	d4
R 1086	CHIP RES.	1k	1/16W	5%	RMC1/16S 102JTH	J24189025		1-	A	E3
R 1087	CHIP RES.	1k	1/16W	5%	RMC1/16S 102JTH	J24189025		1-	A	E4
R 1088	CHIP RES.	56	1/16W	5%	RMC1/16 560JATP	J24185560		1-78	B	c2
R 1088	CHIP RES.	100	1/16W	5%	RMC1/16 101JATP	J24185101		79-	B	c2
R 1089	CHIP RES.	1k	1/16W	5%	RMC1/16S 102JTH	J24189025		1-	B	d3
R 1090	CHIP RES.	330	1/16W	5%	RMC1/16 331JATP	J24185331		1-	B	c1
R 1091	CHIP RES.	0	1/16W	5%	RMC1/16S JPTH	J24189070		1-	B	a1
R 1092	CHIP RES.	1k	1/16W	5%	RMC1/16S 102JTH	J24189025		1-	B	d4
R 1093	CHIP RES.	22k	1/16W	5%	RMC1/16S 223JTH	J24189041		1-	B	a1
R 1094	CHIP RES.	10k	1/16W	5%	RMC1/16S 103JTH	J24189037		1-	A	E6
R 1095	CHIP RES.	120	1/16W	5%	RMC1/16 121JATP	J24185121		1-78	B	c2
R 1095	CHIP RES.	82	1/16W	5%	RMC1/16 820JATP	J24185820		79-	B	c2
R 1096	CHIP RES.	10	1/16W	5%	RMC1/16S 100JTH	J24189001		1-	A	E4
R 1097	CHIP RES.	27k	1/16W	5%	RMC1/16S 273JTH	J24189042		1-	A	E6
R 1098	CHIP RES.	470	1/16W	5%	RMC1/16S 471JTH	J24189021		1-56	B	d3
R 1098	CHIP RES.	100	1/16W	5%	RMC1/16S 101JTH	J24189013		57-	B	d3
R 1099	CHIP RES.	470k	1/16W	5%	RMC1/16S 474JTH	J24189057		1-	B	d3
R 1100	CHIP RES.	470k	1/16W	5%	RMC1/16S 474JTH	J24189057		1-	B	c3
R 1101	CHIP RES.	27	1/16W	5%	RMC1/16S 270JTH	J24189006		1-	B	d3

MAIN Unit

Parts List

REF	DESCRIPTION	VALUE	V/W	TOL.	MFR'S DESIG	VXSTD P/N	VERS.	LOT	SIDE	LAY ADR
R 1103	CHIP RES.	120	1/16W	5%	RMC1/16S 121JTH	J24189014		1-	A	F1
R 1104	CHIP RES.	680k	1/16W	5%	RMC1/16S 684JTH	J24189059		1-	B	c3
R 1105	CHIP RES.	680k	1/16W	5%	RMC1/16S 684JTH	J24189059		1-	B	c3
R 1106	CHIP RES.	100k	1/16W	5%	RMC1/16S 104JTH	J24189049		1-	B	c3
R 1107	CHIP RES.	100k	1/16W	5%	RMC1/16S 104JTH	J24189049		1-	B	c3
R 1108	CHIP RES.	33	1/16W	5%	RMC1/16S 330JTH	J24189007		1-	B	d3
R 1109	CHIP RES.	27	1/16W	5%	RMC1/16S 270JTH	J24189006		1-	B	d3
R 1110	CHIP RES.	1k	1/16W	5%	RMC1/16S 102JTH	J24189025		1-	A	F1
R 1111	CHIP RES.	68	1/16W	5%	RMC1/16S 680JTH	J24189011		1-	B	d3
R 1112	CHIP RES.	100k	1/16W	5%	RMC1/16S 104JTH	J24189049		1-	B	d3
R 1113	CHIP RES.	100k	1/16W	5%	RMC1/16S 104JTH	J24189049		1-	B	c3
R 1114	CHIP RES.	18	1/16W	5%	RMC1/16S 180JTH	J24189004		1-78	B	c1
R 1114	CHIP RES.	10	1/16W	5%	RMC1/16S 100JTH	J24189001		79-	B	c1
R 1115	CHIP RES.	470	1/16W	5%	RMC1/16S 471JTH	J24189021		1-	B	d3
R 1116	CHIP RES.	33	1/16W	5%	RMC1/16S 330JTH	J24189007		1-	B	d3
R 1117	CHIP RES.	68	1/16W	5%	RMC1/16S 680JTH	J24189011		1-78	A	F1
R 1117	CHIP RES.	120	1/16W	5%	RMC1/16S 121JTH	J24189014		79-	A	F1
R 1118	CHIP RES.	68	1/16W	5%	RMC1/16S 680JTH	J24189011		1-	B	d4
R 1119	CHIP RES.	470	1/16W	5%	RMC1/16S 471JTH	J24189021		1-	B	d3
R 1120	CHIP RES.	470k	1/16W	5%	RMC1/16S 474JTH	J24189057		1-	B	d2
R 1121	CHIP RES.	470k	1/16W	5%	RMC1/16S 474JTH	J24189057		1-	B	c3
R 1122	CHIP RES.	18	1/16W	5%	RMC1/16S 180JTH	J24189004		1-78	B	c1
R 1122	CHIP RES.	10	1/16W	5%	RMC1/16S 100JTH	J24189001		79-	B	c1
R 1123	CHIP RES.	33	1/16W	5%	RMC1/16S 330JTH	J24189007		1-	B	d4
R 1124	CHIP RES.	10k	1/16W	5%	RMC1/16S 103JTH	J24189037		1-	B	d3
R 1125	CHIP RES.	4.7k	1/16W	5%	RMC1/16S 472JTH	J24189033		1-	B	c3
R 1126	CHIP RES.	1k	1/16W	5%	RMC1/16S 102JTH	J24189025		1-	A	E3
R 1127	CHIP RES.	10	1/16W	5%	RMC1/16S 100JTH	J24189001		1-	A	E3
R 1128	CHIP RES.	10	1/16W	5%	RMC1/16S 100JTH	J24189001		1-	A	E3
R 1129	CHIP RES.	100	1/16W	5%	RMC1/16S 101JTH	J24189013		1-	B	d4
R 1130	CHIP RES.	470	1/16W	5%	RMC1/16S 471JTH	J24189021		1-67	B	d4
R 1131	CHIP RES.	33	1/16W	5%	RMC1/16S 330JTH	J24189007		1-	A	E4
R 1132	CHIP RES.	10	1/16W	5%	RMC1/16S 100JTH	J24189001		1-39	B	d1
R 1132	CHIP RES.	27	1/16W	5%	RMC1/16S 270JTH	J24189006		40-78	B	d1
R 1132	CHIP RES.	22	1/16W	5%	RMC1/16S 220JTH	J24189005		79-	B	d1
R 1133	CHIP RES.	470k	1/16W	5%	RMC1/16S 474JTH	J24189057		1-	B	c3
R 1134	CHIP RES.	100	1/16W	5%	RMC1/16S 101JTH	J24189013		1-	A	E1
R 1135	CHIP RES.	150	1/16W	5%	RMC1/16S 151JTH	J24189015		1-39	B	d1
R 1135	CHIP RES.	27	1/16W	5%	RMC1/16S 270JTH	J24189006		40-78	B	d1
R 1135	CHIP RES.	56	1/16W	5%	RMC1/16S 560JTH	J24189010		79-	B	d1
R 1136	CHIP RES.	1k	1/16W	5%	RMC1/16S 102JTH	J24189025		1-	B	d1
R 1137	CHIP RES.	1k	1/16W	5%	RMC1/16S 102JTH	J24189025		1-	A	E2
R 1138	CHIP RES.	1k	1/16W	5%	RMC1/16S 102JTH	J24189025		1-	A	F2
R 1139	CHIP RES.	1M	1/16W	5%	RMC1/16S 105JTH	J24189061		1-	A	E1
R 1141	CHIP RES.	22k	1/16W	5%	RMC1/16S 223JTH	J24189041		1-	B	c6
R 1142	CHIP RES.	10	1/16W	5%	RMC1/16S 100JTH	J24189001		1-39	B	d1
R 1142	CHIP RES.	27	1/16W	5%	RMC1/16S 270JTH	J24189006		40-78	B	d1
R 1142	CHIP RES.	22	1/16W	5%	RMC1/16S 220JTH	J24189005		79-	B	d1
R 1143	CHIP RES.	470	1/16W	5%	RMC1/16S 471JTH	J24189021		1-	A	E1
R 1144	CHIP RES.	1k	1/16W	5%	RMC1/16S 102JTH	J24189025		1-	B	d3
R 1145	CHIP RES.	1k	1/16W	5%	RMC1/16S 102JTH	J24189025		1-	B	c2
R 1146	CHIP RES.	100k	1/16W	5%	RMC1/16S 104JTH	J24189049		1-	A	E1
R 1147	CHIP RES.	100	1/16W	5%	RMC1/16S 101JTH	J24189013		1-	B	c1
R 1148	CHIP RES.	1k	1/16W	5%	RMC1/16S 102JTH	J24189025		1-	B	d3
R 1149	CHIP RES.	100k	1/16W	5%	RMC1/16S 104JTH	J24189049		1-	A	E1
R 1150	CHIP RES.	33k	1/16W	5%	RMC1/16S 333JTH	J24189043		1-	B	c7
R 1151	CHIP RES.	470	1/16W	5%	RMC1/16S 471JTH	J24189021		1-	A	D1
R 1153	CHIP RES.	10k	1/16W	5%	RMC1/16S 103JTH	J24189037		1-	B	d3
R 1154	CHIP RES.	1M	1/16W	5%	RMC1/16S 105JTH	J24189061		1-	A	E1
R 1155	CHIP RES.	100k	1/16W	5%	RMC1/16S 104JTH	J24189049		1-	A	D1
R 1156	CHIP RES.	82k	1/16W	5%	RMC1/16S 823JTH	J24189048		1-	B	c7
R 1157	CHIP RES.	47k	1/16W	5%	RMC1/16S 473JTH	J24189045		1-	B	c6
R 1158	CHIP RES.	1k	1/16W	5%	RMC1/16S 102JTH	J24189025		1-	B	e1
R 1159	CHIP RES.	4.7k	1/16W	5%	RMC1/16S 472JTH	J24189033		1-	B	b7
R 1160	CHIP RES.	100k	1/16W	5%	RMC1/16S 104JTH	J24189049		1-	B	b7
R 1161	CHIP RES.	100	1/16W	5%	RMC1/16S 101JTH	J24189013		1-	A	D1
R 1162	CHIP RES.	4.7k	1/16W	5%	RMC1/16S 472JTH	J24189033		1-	B	c6
R 1163	CHIP RES.	10k	1/16W	5%	RMC1/16S 103JTH	J24189037		1-	A	F7
R 1164	CHIP RES.	1k	1/16W	5%	RMC1/16S 102JTH	J24189025		1-	A	D1
R 1165	CHIP RES.	3.3k	1/16W	5%	RMC1/16S 332JTH	J24189031		1-6	A	F7
R 1166	CHIP RES.	47k	1/16W	5%	RMC1/16S 473JTH	J24189045		1-	A	F7
R 1167	CHIP RES.	47k	1/16W	5%	RMC1/16S 473JTH	J24189045		1-	A	F7
R 1168	CHIP RES.	47k	1/16W	5%	RMC1/16S 473JTH	J24189045		1-	A	E5

MAIN Unit

Parts List

REF	DESCRIPTION	VALUE	V/W	TOL.	MFR'S DESIG	VXSTD P/N	VERS.	LOT	SIDE	LAY ADR
R 1169	CHIP RES.	100k	1/16W	5%	RMC1/16S 104JTH	J24189049		1-	A	E5
R 1170	CHIP RES.	10k	1/16W	5%	RMC1/16S 103JTH	J24189037		1-17	A	G6
R 1171	CHIP RES.	100k	1/16W	5%	RMC1/16S 104JTH	J24189049		1-	A	F6
R 1172	CHIP RES.	1k	1/16W	5%	RMC1/16S 102JTH	J24189025		1-	B	e1
R 1173	CHIP RES.	100k	1/16W	5%	RMC1/16S 104JTH	J24189049		1-	B	b6
R 1174	CHIP RES.	470	1/16W	5%	RMC1/16S 471JTH	J24189021		1-	A	D1
R 1175	CHIP RES.	100k	1/16W	5%	RMC1/16S 104JTH	J24189049		1-6	B	b6
R 1175	CHIP RES.	220k	1/16W	5%	RMC1/16S 224JTH	J24189053		7-	B	b6
R 1176	CHIP RES.	100	1/16W	5%	RMC1/16S 101JTH	J24189013		1-	B	e1
R 1177	CHIP RES.	100k	1/16W	5%	RMC1/16S 104JTH	J24189049		1-	B	c6
R 1178	CHIP RES.	47k	1/16W	5%	RMC1/16S 473JTH	J24189045		1-	B	b6
R 1179	CHIP RES.	22k	1/16W	5%	RMC1/16S 223JTH	J24189041		1-	B	f2
R 1181	CHIP RES.	22k	1/16W	5%	RMC1/16S 223JTH	J24189041		1-	B	f2
R 1183	CHIP RES.	22k	1/16W	5%	RMC1/16S 223JTH	J24189041		1-	B	f2
R 1184	CHIP RES.	10k	1/16W	5%	RMC1/16S 103JTH	J24189037		1-	B	b6
R 1185	CHIP RES.	22k	1/16W	5%	RMC1/16S 223JTH	J24189041		1-	B	f2
R 1186	CHIP RES.	1k	1/16W	5%	RMC1/16S 102JTH	J24189025		1-	A	C3
R 1187	CHIP RES.	10k	1/16W	5%	RMC1/16S 103JTH	J24189037		1-	A	C3
R 1188	CHIP RES.	10k	1/16W	5%	RMC1/16S 103JTH	J24189037		1-	B	h1
R 1189	CHIP RES.	100	1/16W	5%	RMC1/16S 101JTH	J24189013		1-	B	e1
R 1190	CHIP RES.	1k	1/16W	5%	RMC1/16S 102JTH	J24189025		1-	A	C3
R 1191	CHIP RES.	1k	1/16W	5%	RMC1/16S 102JTH	J24189025		1-	A	F2
R 1192	CHIP RES.	1k	1/16W	5%	RMC1/16S 102JTH	J24189025		1-	B	e1
R 1193	CHIP RES.	100k	1/16W	5%	RMC1/16S 104JTH	J24189049		1-	B	f3
R 1194	CHIP RES.	120k	1/16W	5%	RMC1/16S 124JTH	J24189050		1-	A	E5
R 1195	CHIP RES.	10k	1/16W	5%	RMC1/16S 103JTH	J24189037		1-	B	f3
R 1196	CHIP RES.	1k	1/16W	5%	RMC1/16S 102JTH	J24189025		1-	B	f3
R 1197	CHIP RES.	330k	1/16W	5%	RMC1/16S 334JTH	J24189055		1-	B	h1
R 1198	CHIP RES.	150k	1/16W	5%	RMC1/16S 154JTH	J24189051		1-	A	E5
R 1199	CHIP RES.	1k	1/16W	5%	RMC1/16S 102JTH	J24189025		1-	B	f3
R 1200	CHIP RES.	4.7k	1/16W	5%	RMC1/16S 472JTH	J24189033		1-	B	h1
R 1201	CHIP RES.	100	1/16W	5%	RMC1/16S 101JTH	J24189013		1-	B	h1
R 1202	CHIP RES.	4.7k	1/16W	5%	RMC1/16S 472JTH	J24189033		1-	B	h1
R 1203	CHIP RES.	3.3k	1/16W	5%	RMC1/16S 332JTH	J24189031		1-	B	f3
R 1204	CHIP RES.	100k	1/16W	5%	RMC1/16S 104JTH	J24189049		1-	B	f3
R 1205	CHIP RES.	470	1/16W	5%	RMC1/16S 471JTH	J24189021		1-	A	E3
R 1206	CHIP RES.	330k	1/16W	5%	RMC1/16S 334JTH	J24189055		1-	B	h1
R 1207	CHIP RES.	2.2k	1/16W	5%	RMC1/16S 222JTH	J24189029		1-	B	h1
R 1208	CHIP RES.	47k	1/16W	5%	RMC1/16S 473JTH	J24189045		1-	B	f3
R 1209	CHIP RES.	1k	1/16W	5%	RMC1/16S 102JTH	J24189025		1-	B	f1
R 1210	CHIP RES.	10k	1/16W	5%	RMC1/16S 103JTH	J24189037		1-	B	f3
R 1211	CHIP RES.	100	1/16W	5%	RMC1/16S 101JTH	J24189013		1-49	A	G5
R 1211	CHIP RES.	0	1/16W	5%	RMC1/16S JPTH	J24189070		50-	A	G5
R 1212	CHIP RES.	470k	1/16W	5%	RMC1/16S 474JTH	J24189057		1-	A	E1
R 1213	CHIP RES.	2.2k	1/16W	5%	RMC1/16S 222JTH	J24189029		1-	B	d2
R 1214	CHIP RES.	100k	1/16W	5%	RMC1/16S 104JTH	J24189049		1-	B	f3
R 1215	CHIP RES.	100	1/16W	5%	RMC1/16S 101JTH	J24189013		1-	B	h1
R 1216	CHIP RES.	100k	1/16W	5%	RMC1/16S 104JTH	J24189049		1-	B	f3
R 1217	CHIP RES.	1k	1/16W	5%	RMC1/16S 102JTH	J24189025		1-	B	g3
R 1218	CHIP RES.	100k	1/16W	5%	RMC1/16S 104JTH	J24189049		1-	A	F6
R 1219	CHIP RES.	0	1/16W	5%	RMC1/16 000JATP	J24185000		1-	A	F5
R 1220	CHIP RES.	220k	1/16W	5%	RMC1/16S 224JTH	J24189053		1-	B	g3
R 1221	CHIP RES.	100k	1/16W	5%	RMC1/16S 104JTH	J24189049		1-	A	E5
R 1222	CHIP RES.	47	1/16W	5%	RMC1/16S 470JTH	J24189009		1-	B	f3
R 1223	CHIP RES.	1k	1/16W	5%	RMC1/16S 102JTH	J24189025		1-	B	f3
R 1224	CHIP RES.	2.2k	1/16W	5%	RMC1/16S 222JTH	J24189029		1-	B	e2
R 1225	CHIP RES.	100k	1/16W	5%	RMC1/16S 104JTH	J24189049		1-	A	E5
R 1226	CHIP RES.	10k	1/16W	5%	RMC1/16S 103JTH	J24189037		1-	B	c1
R 1228	CHIP RES.	1k	1/16W	5%	RMC1/16S 102JTH	J24189025		1-	B	f3
R 1229	CHIP RES.	150	1/16W	5%	RMC1/16S 151JTH	J24189015		1-	A	D2
R 1230	CHIP RES.	150	1/16W	5%	RMC1/16S 151JTH	J24189015		1-	A	D2
R 1231	CHIP RES.	10k	1/16W	5%	RMC1/16S 103JTH	J24189037		1-	A	C3
R 1232	CHIP RES.	100	1/16W	5%	RMC1/16S 101JTH	J24189013		1-28	B	e3
R 1232	CHIP RES.	100	1/16W	5%	RMC1/16S 101JTH	J24189013		29-39	B	e3
R 1233	CHIP RES.	33k	1/16W	5%	RMC1/16S 333JTH	J24189043		1-	B	f3
R 1234	CHIP RES.	10k	1/16W	5%	RMC1/16S 103JTH	J24189037		1-	A	C3
R 1235	CHIP RES.	100	1/16W	5%	RMC1/16S 101JTH	J24189013		1-	B	c2
R 1236	CHIP RES.	22k	1/16W	5%	RMC1/16S 223JTH	J24189041		1-	A	C3
R 1237	CHIP RES.	47k	1/16W	5%	RMC1/16S 473JTH	J24189045		1-	B	c1
R 1238	CHIP RES.	10k	1/16W	5%	RMC1/16S 103JTH	J24189037		1-	B	c1
R 1239	CHIP RES.	10	1/16W	5%	RMC1/16S 100JTH	J24189001		1-17	A	C2
R 1239	CHIP RES.	150	1/16W	5%	RMC1/16S 151JTH	J24189015		18-	A	C2
R 1240	CHIP RES.	4.7k	1/16W	5%	RMC1/16S 472JTH	J24189033		1-	A	C3

MAIN Unit

Parts List

REF	DESCRIPTION	VALUE	V/W	TOL.	MFR'S DESIG	VXSTD P/N	VERS.	LOT	SIDE	LAY ADR
R 1241	CHIP RES.	22	1/16W	5%	RMC1/16S 220JTH	J24189005		1-	B	h2
R 1242	CHIP RES.	10k	1/16W	5%	RMC1/16S 103JTH	J24189037		1-	B	c2
R 1243	CHIP RES.	100k	1/16W	5%	RMC1/16S 104JTH	J24189049		1-	B	h2
R 1244	CHIP RES.	56k	1/16W	5%	RMC1/16S 563JTH	J24189046		1-	A	B3
R 1245	CHIP RES.	100	1/16W	5%	RMC1/16S 101JTH	J24189013		1-3	B	e2
R 1245	CHIP RES.	100k	1/16W	5%	RMC1/16S 104JTH	J24189049		4-	B	e2
R 1246	CHIP RES.	2.2k	1/16W	5%	RMC1/16S 222JTH	J24189029		1-	B	h2
R 1247	CHIP RES.	82k	1/16W	5%	RMC1/16S 823JTH	J24189048		1-	A	B3
R 1248	CHIP RES.	470k	1/16W	5%	RMC1/16S 474JTH	J24189057		1-3	B	e2
R 1248	CHIP RES.	330k	1/16W	5%	RMC1/16S 334JTH	J24189055		4-17	B	e2
R 1248	CHIP RES.	150k	1/16W	5%	RMC1/16S 154JTH	J24189051		18-	B	e2
R 1249	CHIP RES.	3.9k	1/16W	5%	RMC1/16S 392JTH	J24189032		1-	B	h2
R 1250	CHIP RES.	33	1/16W	5%	RMC1/16S 330JTH	J24189007		1-	A	D2
R 1251	CHIP RES.	220k	1/16W	5%	RMC1/16S 224JTH	J24189053		18-	B	e2
R 1252	CHIP RES.	100k	1/16W	5%	RMC1/16S 104JTH	J24189049		1-	A	B3
R 1253	CHIP RES.	10k	1/16W	5%	RMC1/16S 103JTH	J24189037		1-	A	F6
R 1254	CHIP RES.	22k	1/16W	5%	RMC1/16S 223JTH	J24189041		1-	A	B3
R 1255	CHIP RES.	68	1/16W	5%	RMC1/16S 680JTH	J24189011		1-	B	h2
R 1256	CHIP RES.	2.2k	1/16W	5%	RMC1/16S 222JTH	J24189029		1-	A	E5
R 1257	CHIP RES.	3.3k	1/16W	5%	RMC1/16S 332JTH	J24189031		1-	A	E2
R 1258	CHIP RES.	4.7k	1/16W	5%	RMC1/16S 472JTH	J24189033		1-	A	E2
R 1259	CHIP RES.	470	1/16W	5%	RMC1/16S 471JTH	J24189021		1-	B	h2
R 1260	CHIP RES.	1k	1/16W	5%	RMC1/16S 102JTH	J24189025		1-	A	D3
R 1262	CHIP RES.	4.7k	1/16W	5%	RMC1/16S 472JTH	J24189033		1-	A	F5
R 1263	CHIP RES.	4.7k	1/16W	5%	RMC1/16S 472JTH	J24189033		1-	A	F5
R 1264	CHIP RES.	470	1/16W	5%	RMC1/16S 471JTH	J24189021		1-	B	h2
R 1265	CHIP RES.	1k	1/16W	5%	RMC1/16S 102JTH	J24189025		1-	A	D3
R 1266	CHIP RES.	2.2k	1/16W	5%	RMC1/16S 222JTH	J24189029		1-	A	E5
R 1267	CHIP RES.	470	1/16W	5%	RMC1/16S 471JTH	J24189021		1-	B	h2
R 1268	CHIP RES.	1.5k	1/16W	5%	RMC1/16S 152JTH	J24189027		1-	B	e3
R 1270	CHIP RES.	1k	1/16W	5%	RMC1/16S 102JTH	J24189025		1-	B	e2
R 1272	CHIP RES.	100	1/16W	5%	RMC1/16S 101JTH	J24189013		1-	B	e2
R 1273	CHIP RES.	1k	1/16W	5%	RMC1/16S 102JTH	J24189025		1-	A	C3
R 1274	CHIP RES.	100k	1/16W	5%	RMC1/16S 104JTH	J24189049		1-	A	B4
R 1275	CHIP RES.	100k	1/16W	5%	RMC1/16S 104JTH	J24189049		1-	A	B4
R 1276	CHIP RES.	100k	1/16W	5%	RMC1/16S 104JTH	J24189049		1-	A	A3
R 1277	CHIP RES.	10k	1/16W	5%	RMC1/16S 103JTH	J24189037		1-	A	E5
R 1278	CHIP RES.	1k	1/16W	5%	RMC1/16S 102JTH	J24189025		1-	A	D3
R 1280	CHIP RES.	100k	1/16W	5%	RMC1/16S 104JTH	J24189049		1-	B	f4
R 1281	CHIP RES.	100	1/16W	5%	RMC1/16S 101JTH	J24189013		1-	A	B4
R 1282	CHIP RES.	47k	1/16W	5%	RMC1/16S 473JTH	J24189045		1-	B	f4
R 1283	CHIP RES.	22k	1/16W	5%	RMC1/16S 223JTH	J24189041		1-	A	E5
R 1284	CHIP RES.	4.7k	1/16W	5%	RMC1/16S 472JTH	J24189033		1-	A	A4
R 1285	CHIP RES.	100	1/16W	5%	RMC1/16S 101JTH	J24189013		1-	A	A4
R 1286	CHIP RES.	68k	1/16W	5%	RMC1/16S 683JTH	J24189047		1-	B	g4
R 1287	CHIP RES.	470k	1/16W	5%	RMC1/16S 474JTH	J24189057		1-	A	B4
R 1288	CHIP RES.	22k	1/16W	5%	RMC1/16S 223JTH	J24189041		1-	B	g4
R 1289	CHIP RES.	22k	1/16W	5%	RMC1/16S 223JTH	J24189041		1-28	A	B4
R 1289	CHIP RES.	15k	1/16W	5%	RMC1/16S 153JTH	J24189039		29-	A	B4
R 1290	CHIP RES.	100k	1/16W	5%	RMC1/16S 104JTH	J24189049		1-17	A	B4
R 1290	CHIP RES.	22k	1/16W	5%	RMC1/16S 223JTH	J24189041		18-	A	B4
R 1291	CHIP RES.	100k	1/16W	5%	RMC1/16S 104JTH	J24189049		1-17	A	B3
R 1291	CHIP RES.	22k	1/16W	5%	RMC1/16S 223JTH	J24189041		18-	A	B3
R 1292	CHIP RES.	220k	1/16W	5%	RMC1/16S 224JTH	J24189053		1-	A	B3
R 1293	CHIP RES.	1k	1/16W	5%	RMC1/16S 102JTH	J24189025		1-	A	B4
R 1294	CHIP RES.	39k	1/16W	5%	RMC1/16S 393JTH	J24189044		1-	A	A3
R 1295	CHIP RES.	22k	1/16W	5%	RMC1/16S 223JTH	J24189041		1-	A	E5
R 1296	CHIP RES.	3.3k	1/16W	5%	RMC1/16S 332JTH	J24189031		1-	B	e4
R 1297	CHIP RES.	47k	1/16W	5%	RMC1/16S 473JTH	J24189045		1-	A	B3
R 1298	CHIP RES.	470k	1/16W	5%	RMC1/16S 474JTH	J24189057		1-	A	B4
R 1299	CHIP RES.	22k	1/16W	5%	RMC1/16S 223JTH	J24189041		1-	A	A5
R 1300	CHIP RES.	4.7k	1/16W	5%	RMC1/16S 472JTH	J24189033		1-	B	e4
R 1301	CHIP RES.	6.8k	1/16W	5%	RMC1/16S 682JTH	J24189035		1-	B	h5
R 1302	CHIP RES.	1k	1/16W	5%	RMC1/16S 102JTH	J24189025		1-	A	C3
R 1303	CHIP RES.	10k	1/16W	5%	RMC1/16S 103JTH	J24189037		1-	B	h4
R 1304	CHIP RES.	100k	1/16W	5%	RMC1/16S 104JTH	J24189049		1-	B	h4
R 1305	CHIP RES.	10k	1/16W	5%	RMC1/16S 103JTH	J24189037		1-	A	D5
R 1306	CHIP RES.	680	1/16W	5%	RMC1/16S 681JTH	J24189023		1-3	B	e3
R 1306	CHIP RES.	1k	1/16W	5%	RMC1/16S 102JTH	J24189025		4-17	B	e3
R 1306	CHIP RES.	470	1/16W	5%	RMC1/16S 471JTH	J24189021		18-	B	e3
R 1307	CHIP RES.	10k	1/16W	5%	RMC1/16S 103JTH	J24189037		1-	A	B3
R 1308	CHIP RES.	10k	1/16W	5%	RMC1/16S 103JTH	J24189037		1-	B	g3
R 1309	CHIP RES.	1k	1/16W	5%	RMC1/16S 102JTH	J24189025		1-	A	B4

MAIN Unit

Parts List

REF	DESCRIPTION	VALUE	V/W	TOL.	MFR'S DESIG	VXSTD P/N	VERS.	LOT	SIDE	LAY ADR
R 1310	CHIP RES.	68k	1/16W	5%	RMC1/16S 683JTH	J24189047		1-	B	h4
R 1311	CHIP RES.	150k	1/16W	5%	RMC1/16S 154JTH	J24189051		1-	B	g3
R 1312	CHIP RES.	150k	1/16W	5%	RMC1/16S 154JTH	J24189051		1-	A	B3
R 1313	CHIP RES.	22k	1/16W	5%	RMC1/16S 223JTH	J24189041		1-	A	C5
R 1314	CHIP RES.	220k	1/16W	5%	RMC1/16S 224JTH	J24189053		1-17	B	e4
R 1314	CHIP RES.	150k	1/16W	5%	RMC1/16S 154JTH	J24189051		18-	B	e4
R 1315	CHIP RES.	100	1/16W	5%	RMC1/16S 101JTH	J24189013		1-	B	h6
R 1316	CHIP RES.	470k	1/16W	5%	RMC1/16S 474JTH	J24189057		1-	A	A3
R 1317	CHIP RES.	10k	1/16W	5%	RMC1/16S 103JTH	J24189037		1-	A	B3
R 1318	CHIP RES.	1M	1/16W	5%	RMC1/16S 105JTH	J24189061		1-	B	e4
R 1319	CHIP RES.	100	1/16W	5%	RMC1/16S 101JTH	J24189013		1-	B	e5
R 1320	CHIP RES.	4.7k	1/16W	5%	RMC1/16S 472JTH	J24189033		1-	B	h5
R 1321	CHIP RES.	4.7k	1/16W	5%	RMC1/16S 472JTH	J24189033		1-	B	g3
R 1322	CHIP RES.	220k	1/16W	5%	RMC1/16S 224JTH	J24189053		1-	B	f3
R 1323	CHIP RES.	33k	1/16W	5%	RMC1/16S 333JTH	J24189043		1-	A	B3
R 1324	CHIP RES.	680k	1/16W	5%	RMC1/16S 684JTH	J24189059		1-	B	h5
R 1325	CHIP RES.	3.3k	1/16W	5%	RMC1/16S 332JTH	J24189031		1-	A	B4
R 1326	CHIP RES.	100k	1/16W	5%	RMC1/16S 104JTH	J24189049		1-	B	e5
R 1327	CHIP RES.	100	1/16W	5%	RMC1/16S 101JTH	J24189013		1-	B	g4
R 1328	CHIP RES.	33k	1/16W	5%	RMC1/16S 333JTH	J24189043		1-	A	B3
R 1329	CHIP RES.	1.5k	1/16W	5%	RMC1/16S 152JTH	J24189027		1-	A	B4
R 1330	CHIP RES.	100	1/16W	5%	RMC1/16S 101JTH	J24189013		1-17	A	C4
R 1330	CHIP RES.	150	1/16W	5%	RMC1/16S 151JTH	J24189015		18-	A	C4
R 1331	CHIP RES.	10k	1/16W	5%	RMC1/16S 103JTH	J24189037		1-	B	e5
R 1332	CHIP RES.	100	1/16W	5%	RMC1/16S 101JTH	J24189013		1-	A	C4
R 1333	CHIP RES.	4.7k	1/16W	5%	RMC1/16S 472JTH	J24189033		1-	B	g4
R 1334	CHIP RES.	1k	1/16W	5%	RMC1/16S 102JTH	J24189025		1-	B	g4
R 1335	CHIP RES.	10k	1/16W	5%	RMC1/16S 103JTH	J24189037		1-	B	h5
R 1336	CHIP RES.	100	1/16W	5%	RMC1/16S 101JTH	J24189013		1-	B	e5
R 1337	CHIP RES.	4.7k	1/16W	5%	RMC1/16S 472JTH	J24189033		1-	B	g3
R 1338	CHIP RES.	1k	1/16W	5%	RMC1/16S 102JTH	J24189025		1-	B	h5
R 1339	CHIP RES.	3.3k	1/16W	5%	RMC1/16S 332JTH	J24189031		1-	B	h5
R 1340	CHIP RES.	2.2k	1/16W	5%	RMC1/16S 222JTH	J24189029		1-72	A	D4
R 1340	CHIP RES.	4.7k	1/16W	5%	RMC1/16S 472JTH	J24189033		73-	A	D4
R 1341	CHIP RES.	100k	1/16W	5%	RMC1/16S 104JTH	J24189049		1-	B	g4
R 1342	CHIP RES.	10k	1/16W	5%	RMC1/16S 103JTH	J24189037		18-	B	c5
R 1343	CHIP RES.	10k	1/16W	5%	RMC1/16S 103JTH	J24189037		18-	B	c5
R 1344	CHIP RES.	470k	1/16W	5%	RMC1/16S 474JTH	J24189057		1-	B	g3
R 1345	CHIP RES.	330k	1/16W	5%	RMC1/16S 334JTH	J24189055		1-	B	g5
R 1346	CHIP RES.	100k	1/16W	5%	RMC1/16S 104JTH	J24189049		1-	A	D5
R 1347	CHIP RES.	3.3k	1/16W	5%	RMC1/16S 332JTH	J24189031		1-	A	B3
R 1348	CHIP RES.	100k	1/16W	5%	RMC1/16S 104JTH	J24189049		1-	B	e5
R 1349	CHIP RES.	1k	1/16W	5%	RMC1/16S 102JTH	J24189025		1-	A	B4
R 1350	CHIP RES.	2.2k	1/16W	5%	RMC1/16S 222JTH	J24189029		1-	B	h6
R 1351	CHIP RES.	4.7k	1/16W	5%	RMC1/16S 472JTH	J24189033		1-	B	h6
R 1352	CHIP RES.	1.5k	1/16W	5%	RMC1/16S 152JTH	J24189027		1-	A	A5
R 1353	CHIP RES.	100	1/16W	5%	RMC1/16S 101JTH	J24189013		1-17	B	g5
R 1353	CHIP RES.	150	1/16W	5%	RMC1/16S 151JTH	J24189015		18-	B	g5
R 1354	CHIP RES.	33k	1/16W	5%	RMC1/16S 333JTH	J24189043	AUSTRALIA	1-	B	g3
R 1354	CHIP RES.	33k	1/16W	5%	RMC1/16S 333JTH	J24189043	EXPORT	1-	B	g3
R 1354	CHIP RES.	33k	1/16W	5%	RMC1/16S 333JTH	J24189043	FRANCE	1-	B	g3
R 1354	CHIP RES.	68k	1/16W	5%	RMC1/16S 683JTH	J24189047	JAPAN	1-	B	g3
R 1354	CHIP RES.	33k	1/16W	5%	RMC1/16S 333JTH	J24189043	USA	1-	B	g3
R 1355	CHIP RES.	22k	1/16W	5%	RMC1/16S 223JTH	J24189041		1-79	B	g3
R 1355	CHIP RES.	15k	1/16W	5%	RMC1/16S 153JTH	J24189039		80-	B	g3
R 1356	CHIP RES.	100	1/16W	5%	RMC1/16S 101JTH	J24189013		1-	B	e5
R 1357	CHIP RES.	1k	1/16W	5%	RMC1/16S 102JTH	J24189025		1-	A	B5
R 1358	CHIP RES.	10k	1/16W	5%	RMC1/16S 103JTH	J24189037		1-	B	f3
R 1359	CHIP RES.	47k	1/16W	5%	RMC1/16S 473JTH	J24189045		1-	B	g3
R 1360	CHIP RES.	470k	1/16W	5%	RMC1/16S 474JTH	J24189057		1-	B	g3
R 1361	CHIP RES.	10k	1/16W	5%	RMC1/16S 103JTH	J24189037		18-	B	c5
R 1362	CHIP RES.	10k	1/16W	5%	RMC1/16S 103JTH	J24189037		18-	B	c6
R 1363	CHIP RES.	150k	1/16W	5%	RMC1/16S 154JTH	J24189051		1-17	B	g4
R 1363	CHIP RES.	33k	1/16W	5%	RMC1/16S 333JTH	J24189043		18-	B	g4
R 1364	CHIP RES.	100	1/16W	5%	RMC1/16S 101JTH	J24189013		1-	B	e5
R 1365	CHIP RES.	22k	1/16W	5%	RMC1/16S 223JTH	J24189041		1-	B	e5
R 1366	CHIP RES.	470	1/16W	5%	RMC1/16S 471JTH	J24189021		1-	B	g3
R 1367	CHIP RES.	3.3k	1/16W	5%	RMC1/16S 332JTH	J24189031		18-	B	c5
R 1368	CHIP RES.	3.3k	1/16W	5%	RMC1/16S 332JTH	J24189031		18-	B	c4
R 1369	CHIP RES.	4.7k	1/16W	5%	RMC1/16S 472JTH	J24189033		1-	B	e5
R 1370	CHIP RES.	33k	1/16W	5%	RMC1/16S 333JTH	J24189043		18-	B	c4
R 1371	CHIP RES.	3.3k	1/16W	5%	RMC1/16S 332JTH	J24189031		18-	B	c6
R 1372	CHIP RES.	3.3k	1/16W	5%	RMC1/16S 332JTH	J24189031		18-	B	c5

MAIN Unit

Parts List

REF	DESCRIPTION	VALUE	V/W	TOL.	MFR'S DESIG	VXSTD P/N	VERS.	LOT	SIDE	LAY ADR
R 1373	CHIP RES.	470	1/16W	5%	RMC1/16S 471JTH	J24189021		1-	B	g3
R 1374	CHIP RES.	68k	1/16W	5%	RMC1/16S 683JTH	J24189047		18-	B	c5
R 1375	CHIP RES.	10k	1/16W	5%	RMC1/16S 103JTH	J24189037		18-	B	c6
R 1376	CHIP RES.	10k	1/16W	5%	RMC1/16S 103JTH	J24189037		18-	B	c5
R 1377	CHIP RES.	470	1/16W	5%	RMC1/16S 471JTH	J24189021		1-	B	g3
R 1379	CHIP RES.	100	1/16W	5%	RMC1/16S 101JTH	J24189013		1-	B	g4
R 1380	CHIP RES.	100	1/16W	5%	RMC1/16S 101JTH	J24189013		1-	A	A5
R 1381	CHIP RES.	470k	1/16W	5%	RMC1/16S 474JTH	J24189057		1-	B	h3
R 1382	CHIP RES.	10k	1/16W	5%	RMC1/16S 103JTH	J24189037		18-	B	c6
R 1383	CHIP RES.	10k	1/16W	5%	RMC1/16S 103JTH	J24189037		18-	B	c5
R 1384	CHIP RES.	5.6k	1/16W	5%	RMC1/16S 562JTH	J24189034		1-	B	f3
R 1385	CHIP RES.	100k	1/16W	5%	RMC1/16S 104JTH	J24189049		1-	A	D5
R 1386	CHIP RES.	220k	1/16W	5%	RMC1/16S 224JTH	J24189053		1-17	B	g5
R 1386	CHIP RES.	150k	1/16W	5%	RMC1/16S 154JTH	J24189051		18-	B	g5
R 1387	CHIP RES.	220k	1/16W	5%	RMC1/16S 224JTH	J24189053		1-	B	g3
R 1388	CHIP RES.	15k	1/16W	5%	RMC1/16S 153JTH	J24189039		1-	B	g3
R 1389	CHIP RES.	2.2k	1/16W	5%	RMC1/16S 222JTH	J24189029		1-	B	g5
R 1390	CHIP RES.	100	1/16W	5%	RMC1/16S 101JTH	J24189013		1-	B	h6
R 1391	CHIP RES.	150	1/16W	5%	RMC1/16S 151JTH	J24189015		1-75	B	f5
R 1391	CHIP RES.	330	1/16W	5%	RMC1/16S 331JTH	J24189019		76-	B	f5
R 1392	CHIP RES.	68k	1/16W	5%	RMC1/16S 683JTH	J24189047		1-	A	D5
R 1393	CHIP RES.	68k	1/16W	5%	RMC1/16S 683JTH	J24189047		18-	B	c5
R 1394	CHIP RES.	1k	1/16W	5%	RMC1/16S 102JTH	J24189025		1-	A	C4
R 1395	CHIP RES.	47k	1/16W	5%	RMC1/16S 473JTH	J24189045		1-	A	B3
R 1396	CHIP RES.	100k	1/16W	5%	RMC1/16S 104JTH	J24189049		1	B	g3
R 1396	CHIP RES.	10k	1/16W	5%	RMC1/16S 103JTH	J24189037		2-	B	g3
R 1397	CHIP RES.	100k	1/16W	5%	RMC1/16S 104JTH	J24189049		1-	B	g3
R 1398	CHIP RES.	68k	1/16W	5%	RMC1/16S 683JTH	J24189047		18-	B	c5
R 1399	CHIP RES.	100	1/10W	5%	RMC1/10T 101J	J24205101		18-	B	b4
R 1400	CHIP RES.	33k	1/16W	5%	RMC1/16S 333JTH	J24189043		1-	B	f3
R 1401	CHIP RES.	470k	1/16W	5%	RMC1/16S 474JTH	J24189057		1-	B	h3
R 1402	CHIP RES.	100	1/16W	5%	RMC1/16S 101JTH	J24189013		1-	A	D5
R 1403	CHIP RES.	2.2k	1/16W	5%	RMC1/16S 222JTH	J24189029		1-	A	D5
R 1404	CHIP RES.	10k	1/16W	5%	RMC1/16S 103JTH	J24189037		1-	A	C4
R 1405	CHIP RES.	3.3k	1/16W	5%	RMC1/16S 332JTH	J24189031		18-	B	c6
R 1406	CHIP RES.	3.3k	1/16W	5%	RMC1/16S 332JTH	J24189031		18-	B	c5
R 1407	CHIP RES.	100	1/16W	5%	RMC1/16S 101JTH	J24189013		1-17	B	g5
R 1407	CHIP RES.	150	1/16W	5%	RMC1/16S 151JTH	J24189015		18-	B	g5
R 1408	CHIP RES.	100	1/16W	5%	RMC1/16S 101JTH	J24189013		1-	A	C4
R 1409	CHIP RES.	10k	1/16W	5%	RMC1/16S 103JTH	J24189037		1-	B	g5
R 1410	CHIP RES.	10k	1/16W	5%	RMC1/16S 103JTH	J24189037		1-17	B	g5
R 1411	CHIP RES.	330	1/16W	5%	RMC1/16S 331JTH	J24189019		18-	B	c6
R 1412	CHIP RES.	330	1/16W	5%	RMC1/16S 331JTH	J24189019		18-	B	c6
R 1413	CHIP RES.	330	1/16W	5%	RMC1/16S 331JTH	J24189019		18-	B	c5
R 1414	CHIP RES.	330	1/16W	5%	RMC1/16S 331JTH	J24189019		18-	B	c5
R 1415	CHIP RES.	4.7k	1/16W	5%	RMC1/16S 472JTH	J24189033		1-	B	f3
R 1416	CHIP RES.	10k	1/16W	5%	RMC1/16S 103JTH	J24189037		1-	B	g3
R 1417	CHIP RES.	6.8k	1/16W	5%	RMC1/16S 682JTH	J24189035		1-	B	g3
R 1418	CHIP RES.	10k	1/16W	5%	RMC1/16S 103JTH	J24189037		1-	B	g5
R 1419	CHIP RES.	33	1/16W	5%	RMC1/16S 330JTH	J24189007		1-	B	e5
R 1420	CHIP RES.	680k	1/16W	5%	RMC1/16S 684JTH	J24189059		1-72	B	g3
R 1420	CHIP RES.	330k	1/16W	5%	RMC1/16S 334JTH	J24189055		73-	B	g3
R 1421	CHIP RES.	150k	1/16W	5%	RMC1/16S 154JTH	J24189051		1-17	A	B3
R 1421	CHIP RES.	100k	1/16W	5%	RMC1/16S 104JTH	J24189049		18-	A	B3
R 1421	CHIP RES.	82k	1/16W	5%	RMC1/16S 823JTH	J24189048		28-	A	B3
R 1422	CHIP RES.	2.2M	1/16W	5%	RMC1/16S 225JTH	J24189065		1-	B	f3
R 1423	CHIP RES.	6.8k	1/16W	5%	RMC1/16S 682JTH	J24189035		18-	B	c5
R 1424	CHIP RES.	100	1/16W	5%	RMC1/16S 101JTH	J24189013		1-	B	f4
R 1425	CHIP RES.	10k	1/16W	5%	RMC1/16S 103JTH	J24189037		1-	B	g6
R 1426	CHIP RES.	10k	1/16W	5%	RMC1/16S 103JTH	J24189037		1-	B	g6
R 1427	CHIP RES.	100k	1/16W	5%	RMC1/16S 104JTH	J24189049		1-	B	g5
R 1428	CHIP RES.	10k	1/16W	5%	RMC1/16S 103JTH	J24189037		1-	A	B3
R 1429	CHIP RES.	100k	1/16W	5%	RMC1/16S 104JTH	J24189049		1-	B	f4
R 1430	CHIP RES.	100	1/16W	5%	RMC1/16S 101JTH	J24189013		1-	B	g5
R 1431	CHIP RES.	2.2k	1/16W	5%	RMC1/16S 222JTH	J24189029		1-	B	f4
R 1432	CHIP RES.	6.8k	1/16W	5%	RMC1/16S 682JTH	J24189035		18-	B	c5
R 1433	CHIP RES.	4.7k	1/16W	5%	RMC1/16S 472JTH	J24189033		1-	B	f4
R 1434	CHIP RES.	1k	1/16W	5%	RMC1/16S 102JTH	J24189025		1-	A	C5
R 1435	CHIP RES.	220k	1/16W	5%	RMC1/16S 224JTH	J24189053		1-17	B	g5
R 1435	CHIP RES.	150k	1/16W	5%	RMC1/16S 154JTH	J24189051		18-	B	g5
R 1436	CHIP RES.	22k	1/16W	5%	RMC1/16S 223JTH	J24189041		1-	B	g3
R 1437	CHIP RES.	1.5k	1/16W	5%	RMC1/16S 152JTH	J24189027		1-78	B	g3
R 1437	CHIP RES.	2.2k	1/16W	5%	RMC1/16S 222JTH	J24189029		79-	B	g3

MAIN Unit

Parts List

REF	DESCRIPTION	VALUE	V/W	TOL.	MFR'S DESIG	VXSTD P/N	VERS.	LOT	SIDE	LAY ADR
R 1438	CHIP RES.	68	1/16W	5%	RMC1/16S 680JTH	J24189011		1-75	B	f5
R 1438	CHIP RES.	22	1/16W	5%	RMC1/16S 220JTH	J24189005		76-	B	f5
R 1439	CHIP RES.	22k	1/16W	5%	RMC1/16S 223JTH	J24189041		1-	B	e6
R 1440	CHIP RES.	10k	1/16W	5%	RMC1/16S 103JTH	J24189037		1-	A	D6
R 1441	CHIP RES.	100k	1/16W	5%	RMC1/16S 104JTH	J24189049		1-17	B	g5
R 1441	CHIP RES.	47k	1/16W	5%	RMC1/16S 473JTH	J24189045		18-	B	g5
R 1442	CHIP RES.	470	1/16W	5%	RMC1/16S 471JTH	J24189021		1-	B	g5
R 1443	CHIP RES.	1M	1/16W	5%	RMC1/16S 105JTH	J24189061		1-	B	f4
R 1444	CHIP RES.	270k	1/16W	5%	RMC1/16S 274JTH	J24189054		1	A	B3
R 1444	CHIP RES.	220k	1/16W	5%	RMC1/16S 224JTH	J24189053		2-17	A	B3
R 1444	CHIP RES.	150k	1/16W	5%	RMC1/16S 154JTH	J24189051		18-	A	B3
R 1446	CHIP RES.	100	1/16W	5%	RMC1/16S 101JTH	J24189013		1-	A	B5
R 1447	CHIP RES.	2.2k	1/16W	5%	RMC1/16S 222JTH	J24189029		1-	B	g6
R 1448	CHIP RES.	22k	1/16W	5%	RMC1/16S 223JTH	J24189041		1-	B	h3
R 1449	CHIP RES.	100k	1/16W	5%	RMC1/16S 104JTH	J24189049		1-	B	f4
R 1450	CHIP RES.	470k	1/16W	5%	RMC1/16S 474JTH	J24189057		1-	B	g3
R 1451	CHIP RES.	22k	1/16W	5%	RMC1/16S 223JTH	J24189041		1-	B	h3
R 1452	CHIP RES.	470	1/16W	5%	RMC1/16S 471JTH	J24189021		1-	A	B5
R 1453	CHIP RES.	1k	1/16W	5%	RMC1/16S 102JTH	J24189025		1-	B	f4
R 1454	CHIP RES.	220	1/16W	5%	RMC1/16S 221JTH	J24189017		1-	A	C5
R 1455	CHIP RES.	2.2M	1/16W	5%	RMC1/16S 225JTH	J24189065		1-	A	A5
R 1456	CHIP RES.	220k	1/16W	5%	RMC1/16S 224JTH	J24189053		1-	B	g6
R 1457	CHIP RES.	47k	1/16W	5%	RMC1/16S 473JTH	J24189045		1-	B	e6
R 1458	CHIP RES.	100k	1/16W	5%	RMC1/16S 104JTH	J24189049		1-	A	A4
R 1459	CHIP RES.	6.8k	1/16W	5%	RMC1/16S 682JTH	J24189035		18-	B	c5
R 1461	CHIP RES.	6.8k	1/16W	5%	RMC1/16S 682JTH	J24189035		1-	B	g4
R 1462	CHIP RES.	470	1/16W	5%	RMC1/16S 471JTH	J24189021		18-	B	b5
R 1463	CHIP RES.	68k	1/16W	5%	RMC1/16S 683JTH	J24189047		1-28	A	B3
R 1463	CHIP RES.	47k	1/16W	5%	RMC1/16S 473JTH	J24189045		29-	A	B3
R 1464	CHIP RES.	22k	1/16W	5%	RMC1/16S 223JTH	J24189041		1-	B	e6
R 1466	CHIP RES.	1k	1/16W	5%	RMC1/16S 102JTH	J24189025		1-	B	e5
R 1467	CHIP RES.	6.8k	1/16W	5%	RMC1/16S 682JTH	J24189035		18-	B	c5
R 1468	CHIP RES.	330k	1/16W	5%	RMC1/16S 334JTH	J24189055		1-	B	f5
R 1469	CHIP RES.	4.7k	1/16W	5%	RMC1/16S 472JTH	J24189033		18-	A	B4
R 1470	CHIP RES.	4.7k	1/16W	5%	RMC1/16S 472JTH	J24189033		1-	B	e6
R 1471	CHIP RES.	33k	1/16W	5%	RMC1/16S 333JTH	J24189043		1-	B	g3
R 1472	CHIP RES.	100	1/16W	5%	RMC1/16S 101JTH	J24189013		1-	B	f5
R 1473	CHIP RES.	33k	1/16W	5%	RMC1/16S 333JTH	J24189043		1-	B	g3
R 1474	CHIP RES.	2.2M	1/16W	5%	RMC1/16S 225JTH	J24189065		18-	B	c5
R 1475	CHIP RES.	10k	1/16W	5%	RMC1/16S 103JTH	J24189037		1-	B	g4
R 1476	CHIP RES.	2.2k	1/16W	5%	RMC1/16S 222JTH	J24189029		1-	A	C6
R 1477	CHIP RES.	100k	1/16W	5%	RMC1/16S 104JTH	J24189049		1-78	B	g4
R 1477	CHIP RES.	68k	1/16W	5%	RMC1/16S 683JTH	J24189047		79-	B	g4
R 1478	CHIP RES.	33k	1/16W	5%	RMC1/16S 333JTH	J24189043		1-	B	g4
R 1479	CHIP RES.	470	1/16W	5%	RMC1/16S 471JTH	J24189021		1-17	A	A4
R 1479	CHIP RES.	100	1/16W	5%	RMC1/16S 101JTH	J24189013		18-	A	A4
R 1482	CHIP RES.	4.7k	1/16W	5%	RMC1/16S 472JTH	J24189033		1-	B	e5
R 1483	CHIP RES.	33k	1/16W	5%	RMC1/16S 333JTH	J24189043		1-	B	g4
R 1484	CHIP RES.	3.3k	1/16W	5%	RMC1/16S 332JTH	J24189031		1-	B	e4
R 1485	CHIP RES.	100k	1/16W	5%	RMC1/16S 104JTH	J24189049		57-	B	f6
R 1486	CHIP RES.	1k	1/16W	5%	RMC1/16S 102JTH	J24189025		1-	B	f6
R 1487	CHIP RES.	2.2M	1/16W	5%	RMC1/16S 225JTH	J24189065		1-	B	g4
R 1488	CHIP RES.	3.3k	1/16W	5%	RMC1/16S 332JTH	J24189031		1-	B	e4
R 1491	CHIP RES.	330k	1/16W	5%	RMC1/16S 334JTH	J24189055		1-	B	e4
R 1493	CHIP RES.	6.8k	1/16W	5%	RMC1/16S 682JTH	J24189035		1-	B	g3
R 1494	CHIP RES.	10k	1/16W	5%	RMC1/16S 103JTH	J24189037		1-	B	g4
R 1495	CHIP RES.	2.2k	1/16W	5%	RMC1/16S 222JTH	J24189029		1-	A	D6
R 1496	CHIP RES.	470	1/16W	5%	RMC1/16S 471JTH	J24189021		1-	B	e6
R 1497	CHIP RES.	100k	1/16W	5%	RMC1/16S 104JTH	J24189049		57-	B	e5
R 1498	CHIP RES.	47	1/16W	5%	RMC1/16S 470JTH	J24189009		1-	B	d5
R 1499	CHIP RES.	470	1/16W	5%	RMC1/16S 471JTH	J24189021		18-	B	b6
R 1500	CHIP RES.	100k	1/16W	5%	RMC1/16S 104JTH	J24189049		1-17	B	b6
R 1500	CHIP RES.	470	1/16W	5%	RMC1/16S 471JTH	J24189021		18-	B	b6
R 1501	CHIP RES.	470	1/16W	5%	RMC1/16S 471JTH	J24189021		18-	B	b6
R 1502	CHIP RES.	470	1/16W	5%	RMC1/16S 471JTH	J24189021		18-	B	b6
R 1503	CHIP RES.	470	1/16W	5%	RMC1/16S 471JTH	J24189021		18-	B	b6
R 1504	CHIP RES.	470	1/16W	5%	RMC1/16S 471JTH	J24189021		18-	B	b6
R 1505	CHIP RES.	4.7k	1/16W	5%	RMC1/16S 472JTH	J24189033		1-	B	e7
R 1506	CHIP RES.	4.7k	1/16W	5%	RMC1/16S 472JTH	J24189033		1-	B	e6
R 1507	CHIP RES.	470	1/16W	5%	RMC1/16S 471JTH	J24189021		1-	B	e7
R 1508	CHIP RES.	470	1/16W	5%	RMC1/16S 471JTH	J24189021		1-	B	e6
R 1509	CHIP RES.	47k	1/16W	5%	RMC1/16S 473JTH	J24189045		1	B	c6
R 1509	CHIP RES.	4.7k	1/16W	5%	RMC1/16S 472JTH	J24189033		2-	B	c6

MAIN Unit

Parts List

REF	DESCRIPTION	VALUE	V/W	TOL.	MFR'S DESIG	VXSTD P/N	VERS.	LOT	SIDE	LAY ADR
R 1510	CHIP RES.	15k	1/16W	5%	RMC1/16S 153JTH	J24189039		1	B	c6
R 1510	CHIP RES.	1.5k	1/16W	5%	RMC1/16S 152JTH	J24189027		2-	B	c6
R 1511	CHIP RES.	1	1W	5%	RMC1 1R0JTE	J24305010		1-	B	d7
R 1512	CHIP RES.	4.7k	1/16W	5%	RMC1/16S 472JTH	J24189033		1-	B	g5
R 1513	CHIP RES.	4.7k	1/16W	5%	RMC1/16S 472JTH	J24189033		1-	B	f6
R 1514	CHIP RES.	470	1/16W	5%	RMC1/16S 471JTH	J24189021		1-	B	g5
R 1515	CHIP RES.	470	1/16W	5%	RMC1/16S 471JTH	J24189021		1-	B	f5
R 1516	CHIP RES.	4.7k	1/16W	5%	RMC1/16S 472JTH	J24189033		1-	B	g7
R 1517	CHIP RES.	4.7k	1/16W	5%	RMC1/16S 472JTH	J24189033		1-	B	g6
R 1518	CHIP RES.	1k	1/16W	5%	RMC1/16S 102JTH	J24189025		1-	B	g5
R 1519	CHIP RES.	220	1/4W	5%	RMC1/4 221JATP	J24245221		1-	B	d6
R 1520	CHIP RES.	4.7	1/10W	5%	RMC1/10T 4R7J	J24205479		1-	B	d6
R 1521	CHIP RES.	47	1/16W	5%	RMC1/16S 470JTH	J24189009		1-	B	g6
R 1522	CHIP RES.	47	1/16W	5%	RMC1/16S 470JTH	J24189009		1-	B	g7
R 1523	CHIP RES.	4.7k	1/16W	5%	RMC1/16S 472JTH	J24189033		1-	B	f5
R 1524	CHIP RES.	47	1/16W	5%	RMC1/16S 470JTH	J24189009		1-	B	f5
R 1525	CHIP RES.	4.7	1/10W	5%	RMC1/10T 4R7J	J24205479		1-	B	d7
R 1526	CHIP RES.	1.5k	1/16W	5%	RMC1/16S 152JTH	J24189027		1-	B	g5
R 1527	CHIP RES.	47	1/16W	5%	RMC1/16S 470JTH	J24189009		1-	B	g5
R 1528	CHIP RES.	220	1/16W	5%	RMC1/16S 221JTH	J24189017		1-	B	d7
R 1530	CHIP RES.	0	1/10W	5%	RMC1/10T 000J	J24205000		1-17		
R 1531	CHIP RES.	0	1/10W	5%	RMC1/10T 000J	J24205000		1-17		
R 1533	CHIP RES.	2.2k	1/16W	5%	RMC1/16S 222JTH	J24189029		1-75	B	g6
R 1533	CHIP RES.	4.7k	1/16W	5%	RMC1/16S 472JTH	J24189033		76-	B	g6
R 1534	CHIP RES.	47	1/16W	5%	RMC1/16S 470JTH	J24189009		1-	B	g6
R 1535	CHIP RES.	470	1/16W	5%	RMC1/16S 471JTH	J24189021		1-	B	b6
R 1537	CHIP RES.	10k	1/16W	5%	RMC1/16S 103JTH	J24189037		1-	B	g6
R 1538	CHIP RES.	470	1/4W	5%	RMC1/4 471JATP	J24245471		1-	B	h3
R 1539	CHIP RES.	470	1/16W	5%	RMC1/16S 471JTH	J24189021		1-	B	b7
R 1541	CHIP RES.	15k	1/16W	5%	RMC1/16S 153JTH	J24189039		1-	B	b6
R 1542	CHIP RES.	220	1/16W	5%	RMC1/16S 221JTH	J24189017		1-	A	D7
R 1543	CHIP RES.	470	1/16W	5%	RMC1/16S 471JTH	J24189021		1-	B	b7
R 1544	CHIP RES.	470	1/16W	5%	RMC1/16S 471JTH	J24189021		1-	A	G5
R 1545	CHIP RES.	470	1/16W	5%	RMC1/16S 471JTH	J24189021		1-	A	G5
R 1546	CHIP RES.	150k	1/16W	5%	RMC1/16S 154JTH	J24189051		1-	B	b6
R 1547	CHIP RES.	68k	1/16W	5%	RMC1/16S 683JTH	J24189047		1-	B	b7
R 1548	CHIP RES.	470	1/16W	5%	RMC1/16S 471JTH	J24189021		1-	A	G5
R 1549	CHIP RES.	470	1/16W	5%	RMC1/16S 471JTH	J24189021		1-	A	G5
R 1550	CHIP RES.	0	1/16W	5%	RMC1/16 000JATP	J24185000		1-	A	G6
R 1551	CHIP RES.	10k	1/16W	5%	RMC1/16S 103JTH	J24189037		1-	B	h5
R 1552	CHIP RES.	10k	1/16W	5%	RMC1/16S 103JTH	J24189037		1-	B	b7
R 1553	CHIP RES.	220	1/16W	5%	RMC1/16S 221JTH	J24189017		1-	B	h3
R 1554	CHIP RES.	220	1/16W	5%	RMC1/16S 221JTH	J24189017		1-	B	h4
R 1555	CHIP RES.	1k	1/16W	5%	RMC1/16S 102JTH	J24189025		1-	B	h3
R 1556	CHIP RES.	0	1/16W	5%	RMC1/16 000JATP	J24185000		1-	A	E6
R 1557	CHIP RES.	1k	1/16W	5%	RMC1/16S 102JTH	J24189025		1-	B	h5
R 1558	CHIP RES.	1k	1/16W	5%	RMC1/16S 102JTH	J24189025		1-	B	h5
R 1559	CHIP RES.	1k	1/16W	5%	RMC1/16S 102JTH	J24189025		1-	B	h4
R 1560	CHIP RES.	1k	1/16W	5%	RMC1/16S 102JTH	J24189025		1-	B	h3
R 1561	CHIP RES.	1k	1/16W	5%	RMC1/16S 102JTH	J24189025		1-	B	h4
R 1562	CHIP RES.	1k	1/16W	5%	RMC1/16S 102JTH	J24189025		1-	B	h4
R 1563	CHIP RES.	1k	1/16W	5%	RMC1/16S 102JTH	J24189025		1-	B	h5
R 1565	CHIP RES.	1k	1/16W	5%	RMC1/16S 102JTH	J24189025		1-	B	h6
R 1566	CHIP RES.	1k	1/16W	5%	RMC1/16S 102JTH	J24189025		1-	B	h6
R 1567	CHIP RES.	1k	1/16W	5%	RMC1/16S 102JTH	J24189025		1-	A	A3
R 1568	CHIP RES.	1k	1/16W	5%	RMC1/16S 102JTH	J24189025		1-	B	h5
R 1569	CHIP RES.	470	1/16W	5%	RMC1/16S 471JTH	J24189021		1-	B	a7
R 1570	CHIP RES.	470	1/16W	5%	RMC1/16S 471JTH	J24189021		1-	B	a7
R 1571	CHIP RES.	1k	1/16W	5%	RMC1/16S 102JTH	J24189025		1-	A	G6
R 1572	CHIP RES.	0	1/16W	5%	RMC1/16S JPTH	J24189070		1-	B	a6
R 1573	CHIP RES.	1k	1/16W	5%	RMC1/16S 102JTH	J24189025		1-	B	a7
R 1576	CHIP RES.	0	1/10W	5%	RMC1/10T 000J	J24205000		1-17		
R 1577	CHIP RES.	3.9	1/2W	5%	RMC1/2 3R9JATP	J24275399		1-	B	h7
R 1578	CHIP RES.	1.5k	1/16W	5%	RMC1/16S 152JTH	J24189027		1-	B	e5
R 1579	CHIP RES.	47k	1/16W	5%	RMC1/16S 473JTH	J24189045		1-	A	D6
R 1580	CHIP RES.	1.5k	1/16W	5%	RMC1/16S 152JTH	J24189027		1-	B	g5
R 1581	CHIP RES.	10k	1/16W	5%	RMC1/16S 103JTH	J24189037		1-	A	A5
R 1582	CHIP RES.	4.7k	1/16W	5%	RMC1/16S 472JTH	J24189033		1-	A	A4
R 1583	CHIP RES.	4.7k	1/16W	5%	RMC1/16S 472JTH	J24189033		1-	B	h4
R 1584	CHIP RES.	10k	1/16W	5%	RMC1/16S 103JTH	J24189037		1-	B	h4
R 1585	CHIP RES.	10k	1/16W	5%	RMC1/16S 103JTH	J24189037		1-	A	B3
R 1586	CHIP RES.	4.7k	1/16W	5%	RMC1/16S 472JTH	J24189033		1-	A	B3
R 1587	CHIP RES.	2.2M	1/16W	5%	RMC1/16S 225JTH	J24189065		1-	B	h3

MAIN Unit

Parts List

REF	DESCRIPTION	VALUE	V/W	TOL.	MFR'S DESIG	VXSTD P/N	VERS.	LOT	SIDE	LAY ADR
R 1588	CHIP RES.	10k	1/16W	5%	RMC1/16S 103JTH	J24189037		1-	B	g4
R 1589	CHIP RES.	470	1/16W	5%	RMC1/16 471JATP	J24185471		1-	A	D2
R 1590	CHIP RES.	15k	1/16W	5%	RMC1/16S 153JTH	J24189039		1-	A	B4
R 1591	CHIP RES.	330	1/16W	5%	RMC1/16S 331JTH	J24189019		1-66	B	f4
R 1592	CHIP RES.	0	1/16W	5%	RMC1/16S JPTH	J24189070		18-	B	b7
R 1593	CHIP RES.	0	1/16W	5%	RMC1/16S JPTH	J24189070		18-	B	b7
R 1594	CHIP RES.	4.7k	1/16W	5%	RMC1/16S 472JTH	J24189033		1-	B	b6
R 1595	CHIP RES.	6.8	1/10W	5%	RMC1/10T 6R8J	J24205689		1	B	c7
R 1595	CHIP RES.	15	1/10W	5%	RMC1/10T 150J	J24205150		2-17	B	c7
R 1595	CHIP RES.	15	1/4W	5%	RMC1/4 150JATP	J24245150		18-	B	c7
R 1596	CHIP RES.	10k	1/16W	5%	RMC1/16S 103JTH	J24189037		1-	B	f3
R 1597	CHIP RES.	4.7	1/16W	5%	RMC1/16 4R7JATP	J24185479		1-3	B	b2
R 1597	CHIP RES.	12	1/16W	5%	RMC1/16 120JATP	J24185120		4-13	B	b2
R 1597	CHIP RES.	27	1/16W	5%	RMC1/16 270JATP	J24185270		14-17	B	b2
R 1599	CHIP RES.	220	1/16W	5%	RMC1/16S 221JTH	J24189017		1-17	B	d4
R 1599	CHIP RES.	120	1/16W	5%	RMC1/16S 121JTH	J24189014		18-	B	d4
R 1600	CHIP RES.	220k	1/16W	5%	RMC1/16S 224JTH	J24189053		1-	B	f4
R 1601	CHIP RES.	10k	1/16W	5%	RMC1/16S 103JTH	J24189037		1-	B	c2
R 1602	CHIP RES.	0	1/16W	5%	RMC1/16S JPTH	J24189070		1-	A	F5
R 1603	CHIP RES.	68k	1/16W	5%	RMC1/16S 683JTH	J24189047		1-3	B	e2
R 1603	CHIP RES.	33k	1/16W	5%	RMC1/16S 333JTH	J24189043		4-28	B	e2
R 1603	CHIP RES.	68k	1/16W	5%	RMC1/16S 683JTH	J24189047		29-33	B	e2
R 1603	CHIP RES.	47k	1/16W	5%	RMC1/16S 473JTH	J24189045		34-	B	e2
R 1604	CHIP RES.	1M	1/16W	5%	RMC1/16S 105JTH	J24189061		1-17	B	e2
R 1604	CHIP RES.	100k	1/16W	5%	RMC1/16S 104JTH	J24189049		18-	B	e2
R 1605	CHIP RES.	10k	1/16W	5%	RMC1/16S 103JTH	J24189037		1-	B	d5
R 1606	CHIP RES.	10k	1/16W	5%	RMC1/16S 103JTH	J24189037		1-	A	F5
R 1609	CHIP RES.	2.2k	1/16W	5%	RMC1/16S 222JTH	J24189029		1-	A	E3
R 1610	CHIP RES.	68k	1/16W	5%	RMC1/16S 683JTH	J24189047		1-	B	f4
R 1611	CHIP RES.	220	1/16W	5%	RMC1/16S 221JTH	J24189017		1-	A	E3
R 1612	CHIP RES.	100k	1/16W	5%	RMC1/16S 104JTH	J24189049		1-	A	G7
R 1613	CHIP RES.	470	1/16W	5%	RMC1/16S 471JTH	J24189021		1-	B	a7
R 1614	CHIP RES.	100k	1/16W	5%	RMC1/16S 104JTH	J24189049		1-	A	G5
R 1617	CHIP RES.	10k	1/16W	5%	RMC1/16S 103JTH	J24189037		1-	A	G5
R 1618	CHIP RES.	10k	1/16W	5%	RMC1/16S 103JTH	J24189037		1-	A	G7
R 1619	CHIP RES.	0	1/16W	5%	RMC1/16S JPTH	J24189070		1-	B	d5
R 1620	CHIP RES.	0	1/16W	5%	RMC1/16S JPTH	J24189070		1-	B	d5
R 1621	CHIP RES.	0	1/16W	5%	RMC1/16S JPTH	J24189070		1-	B	c6
R 1622	CHIP RES.	10k	1/16W	5%	RMC1/16S 103JTH	J24189037		1-	A	F5
R 1623	CHIP RES.	10k	1/16W	5%	RMC1/16S 103JTH	J24189037		1-	A	F5
R 1624	CHIP RES.	10k	1/16W	5%	RMC1/16S 103JTH	J24189037		1-	A	F5
R 1625	CHIP RES.	100k	1/16W	5%	RMC1/16S 104JTH	J24189049		1-	B	c6
R 1630	CHIP RES.	4.7k	1/16W	5%	RMC1/16S 472JTH	J24189033		1-	A	G5
R 1631	CHIP RES.	100k	1/16W	5%	RMC1/16S 104JTH	J24189049		1-	A	H5
R 1632	CHIP RES.	100	1/16W	5%	RMC1/16S 101JTH	J24189013		18-	B	b6
R 1633	CHIP RES.	18k	1/16W	5%	RMC1/16S 183JTH	J24189040		1-17	B	d5
R 1634	CHIP RES.	10k	1/16W	5%	RMC1/16S 103JTH	J24189037		1-17	B	d5
R 1635	CHIP RES.	1k	1/16W	5%	RMC1/16S 102JTH	J24189025		18-	B	c6
R 1638	CHIP RES.	220k	1/16W	5%	RMC1/16S 224JTH	J24189053		18-	B	e4
R 1639	CHIP RES.	220k	1/16W	5%	RMC1/16S 224JTH	J24189053		18-	B	g5
R 1640	CHIP RES.	220k	1/16W	5%	RMC1/16S 224JTH	J24189053		18-	B	g5
R 1641	CHIP RES.	3.9k	1/16W	5%	RMC1/16 392JATP	J24185392		18-28	B	c2
R 1641	CHIP RES.	2.2k	1/16W	5%	RMC1/16 222JATP	J24185222		29-	B	c2
R 1642	CHIP RES.	100	1/16W	5%	RMC1/16S 101JTH	J24189013		40-	B	e3
R 1643	CHIP RES.	0	1/16W	5%	RMC1/16S JPTH	J24189070		40-66	B	d1
R 1643	CHIP RES.	15	1/16W	5%	RMC1/16S 150JTH	J24189003		67-	B	d1
R 1644	CHIP RES.	0	1/16W	5%	RMC1/16S JPTH	J24189070		40-66	B	d1
R 1644	CHIP RES.	15	1/16W	5%	RMC1/16S 150JTH	J24189003		67-	B	d1
R 1645	CHIP RES.	82	1/16W	5%	RMC1/16S 820JTH	J24189012		67-	B	d1
R 1646	CHIP RES.	100k	1/16W	5%	RMC1/16S 104JTH	J24189049		57-		
R 1647	CHIP RES.	470k	1/16W	5%	RMC1/16 474JATP	J24185474		57-		
R 1648	CHIP RES.	33k	1/16W	5%	RMC1/16S 333JTH	J24189043		73-		
R 1649	CHIP RES.	0	1/8W	5%	RMC1/8T 000J	J24215000		73-74		
R 1649	CHIP RES.	3.9k	1/16W	5%	RMC1/16S 392JTH	J24189032		79		
R 1649	CHIP RES.	3.3k	1/16W	5%	RMC1/16S 332JTH	J24189031		80-		
R 1650	CHIP RES.	47k	1/16W	5%	RMC1/16S 473JTH	J24189045		79-		
RB1002	BLOCK RES.				SR4E103JT	J42900027		1-	A	F5
RB1003	BLOCK RES.				SR4E103JT	J42900027		1-	B	g6
RL1001	RELAY		DC12V		G5V-1 DC12V	M1190120		1-	A	D7
S 1001	SLIDE SWITCH				SSSS22	N6090057		1-	A	F2
S 1002	SLIDE SWITCH				SSSS22	N6090057		1-17	A	G7
T 1001	COIL PWR-WIDE				A0898	L0022552		1-	A	H5
T 1002	COIL PWR-WIDE				3A TR9.3X4.8X5.0	L0022642A		1-13	A	G4

MAIN Unit

Parts List

REF	DESCRIPTION	VALUE	V/W	TOL.	MFR'S DESIG	VXSTD P/N	VERS.	LOT	SIDE	LAY ADR
T 1002	COIL PWR-WIDE				ESD-R-10D	L0022847		14-	A	G4
T 1003	COIL PWR-WIDE				3A6 RIB8X14X6.5	L0022641A		1-	A	H2
T 1004	COIL 05RF				100M 010812300A	L0022779		1-	A	E4
T 1005	COIL 05RF				100M 010812300A	L0022779		1-	A	E3
T 1006	COIL 05RF				100M 010812300A	L0022779		1-	A	F3
T 1007	COIL WIDE-TRANS.				3-318707	L0022619		1-	A	E3
T 1008	COIL 05RF				100M 010812300A	L0022779		1-	A	E2
T 1009	COIL 05RF				100M 010812300A	L0022779		1-	A	F3
T 1010	COIL 05RF				100M 010812300A	L0022779		1-	A	F2
T 1011	COIL 05RF				100M 010812300A	L0022779		1-	A	E1
T 1012	COIL 05RF				100M 010812300A	L0022779		1-	A	E1
T 1013	COIL 05RF				100M 010812300A	L0022779		1-	A	D1
T 1014	COIL 05RF				74.62M 010812302	L0022781		1-	A	C3
T 1015	BALUN TRANSFOMERS				#458DB-1616=P3	L0190246		1-	A	D1
T 1016	BALUN TRANSFOMERS				#458DB-1616=P3	L0190246		1-	A	D2
T 1017	COIL WIDE-TRANS.				3-317611	L0022478		1-	A	E2
T 1018	COIL 05RF				74.62M 010812302	L0022781		1-17	A	B3
T 1018	COIL 05RF				74.62M 010812303	L0022782		18-	A	B3
T 1019	COIL 05RF				74.62M 010812302	L0022781		1-	A	B3
T 1020	COIL WIDE-TRANS.				3-317610	L0022479		1-	A	D2
T 1021	COIL 05RF				74.62M 010812302	L0022781		1-	A	D2
T 1022	COIL WIDE-TRANS.				3-317611	L0022478		1-	A	D2
T 1023	COIL 05RF				74.62M 010812303	L0022782		1-17	A	D3
T 1023	COIL 05RF	74.62MHz			74.62M 030812396C	L0022854		18-	A	D3
T 1024	COIL 05RF				74.62M 010812303	L0022782		1-17	A	D3
T 1024	COIL 05RF	74.62MHz			74.62M 030812396C	L0022854		18-	A	D3
T 1025	COIL 05RF	455kHz			455K 030812470	L0022778		1-	A	A3
T 1026	COIL 05RF				74.62M 010812303	L0022782		1-17	A	D4
T 1026	COIL 05RF	74.62MHz			74.62M 030812396C	L0022854		18-	A	D4
T 1027	COIL 05RF	455kHz			455K 030812471	L0022780		1-	A	D5
T 1028	COIL 05RF				50M 010812304	L0022783		1-	A	D4
T 1029	COIL 05RF	455kHz			455K 030812470	L0022778		1-	A	B4
T 1030	COIL 05RF				74.62M 010812302	L0022781		1-	A	D5
T 1031	COIL 05RF	455kHz			455K 030812471	L0022780		1-	A	D5
T 1032	COIL WIDE-TRANS.				3-317611	L0022478		1-	A	C5
T 1033	COIL 05RF	455kHz			455K 030812470	L0022778		1-	A	C4
T 1034	COIL 05RF	455kHz			455K 030812471	L0022780		1-	A	B5
T 1035	COIL 05RF	455kHz			455K 030812470	L0022778		1-	A	C5
T 1036	COIL 05RF	455kHz			455K 030812471	L0022780		1-	A	C5
T 1037	COIL 05RF	455kHz			455K 030812471	L0022780		1-	A	D5
TC1001	TRIMMER CAP.	3pF			ECR-KN003A61X 3P	K91000264		1-	A	E4
TC1002	TRIMMER CAP.	6pF			ECR-KN006A61X 6P	K91000225		1-	A	E1
TC1003	TRIMMER CAP.	6pF			ECR-KN006A61X 6P	K91000225		1-	A	E1
TC1004	TRIMMER CAP.	6pF			ECR-KN006A61X 6P	K91000225		1-	A	D1
TC1005	TRIMMER CAP.	10pF			ECR-KN010C61X	K91000226		1-	A	E2
TH1001	THERMISTOR				TBPS1R223K460H5Q	G9090085		1-	B	a2
VR1001	POT.	1k			EVN-5ESX50B13	J51811102		1-	A	G3
VR1002	POT.	1k			EVN-5ESX50B13	J51811102		1-	A	H3
VR1003	POT.	2.2k			EVN-5ESX50BE3	J51811222		1-	A	G2
VR1004	POT.	2.2k			EVN-5ESX50BE3	J51811222		1-	A	F2
VR1005	POT.	10k			EVN-5ESX50B14	J51811103		1-	A	B4
X 1001	XTAL TSS-6035B	19.82MHz			19.820MHZ	H0103262		1-54	A	G5
X 1001	XTAL TSS-6035B	19.82MHz			19.820MHZ	H0103262A		55-	A	G5
X 1002	XTAL TSS-7050A	22.7785MHz			22.7785MHZ	H0103277		1-38	B	f3
X 1002	XTAL TSS-7050A-2	22778.5kHz			22778.5KHZ	H0103277A		39-	B	f3
X 1003	XTAL TSS-7050A	8.23MHz			8.230MHZ	H0103261		18-	B	b6
XF1001	XTAL FILTER				MF68Q TR-6(3)	H1102349		1-17	A	D3
XF1001	XTAL FILTER				MFT68Q 68.33MHZ	H1102372		18-	A	D3
	HEATSINK PLATE				(MIXER)	RA0416500		1-	B	a3
	SHIELD CASE					RA0439400		1-		
	SHIELD SHEET					RA0459300		1-		
	SHEET					RA0638900		32-39		
	SHEET					RA0638900		32-39		

MAIN Unit

Note

PLL Unit (Lot 1 ~ 11)

Parts Layout

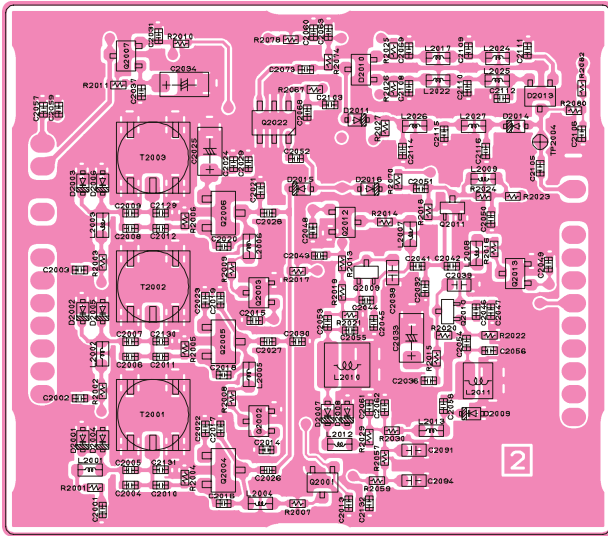

Side A

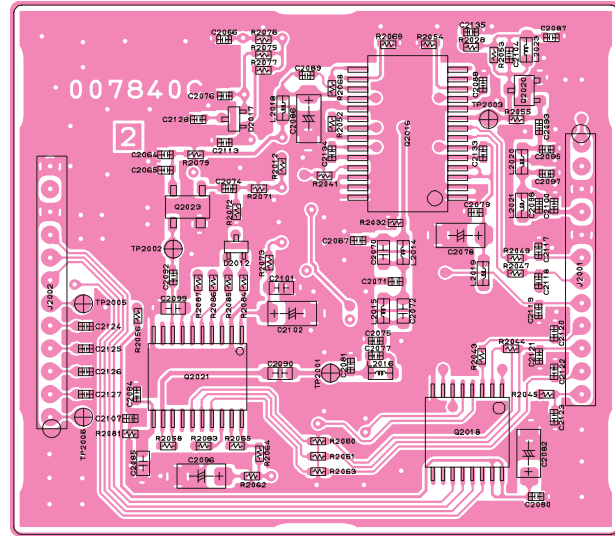

Side B

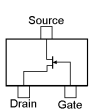

2SK210GR (YG)
(Q2004, 2005, 2006)

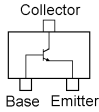

2SC4154E (LE)
(Q2007)
2SC5374 (NA)
(Q2009, 2010, 2011)

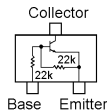

DTC124EU (25)
(Q2001, 2002, 2003, 2012, 2013)

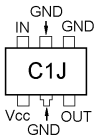

UPC2713 (C1J)
(Q2022)

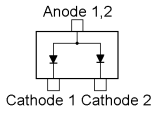

DAP222 (P)
(D2012, 2017)
DAP236U (X)
(D2010, 2013)

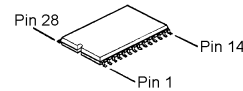

AD9850BRS
(Q2016)

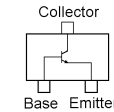

2SC4400 (RT4)
(Q2020)

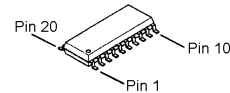

FQ7925
(Q2021)

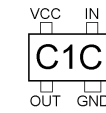

uPC1688G (C1C)
(Q2023)

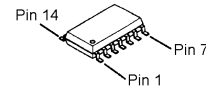

BU4094BCFV-E2
(Q2018)

PLL Unit (Lot 12 ~ 65)

Parts Layout

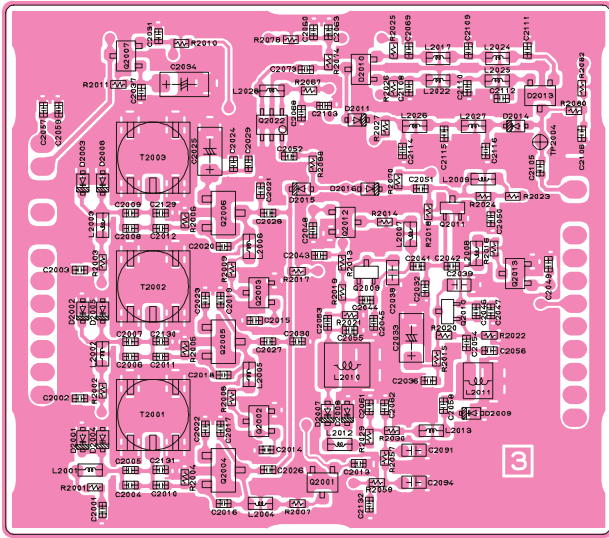

Side A

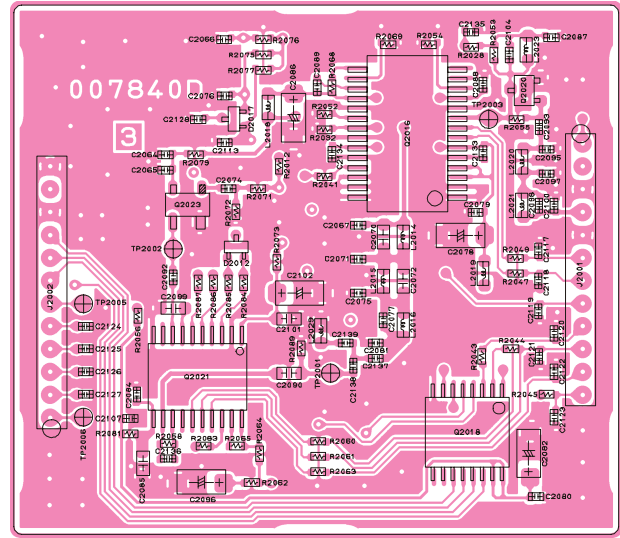

Side B

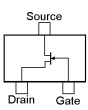

2SK210GR (YG)
(Q2004, 2005, 2006)

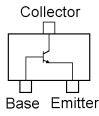

2SC4154E (LE)
(Q2007)
2SC5374 (NA)
(Q2009, 2010, 2011)

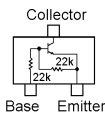

DTC124EU (25)
(Q2001, 2002, 2003, 2012, 2013)



UPC2710 (C1F)
(Q2022)

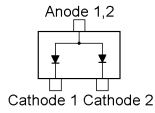

DAP222 (P)
(D2012, 2017)
DAP236U (X)
(D2010, 2013)

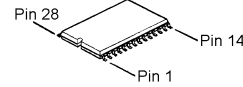

AD9850BRS
(Q2016)

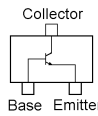

2SC4400 (RT4)
(Q2020)

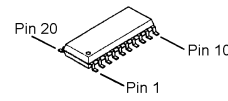

FQ7925
(Q2021)

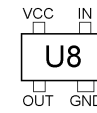

TA4002F (U8)
(Q2023)

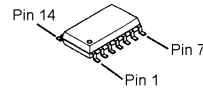

BU4094BCFV-E2
(Q2018)

PLL Unit (Lot 66 ~)

Circuit Diagram

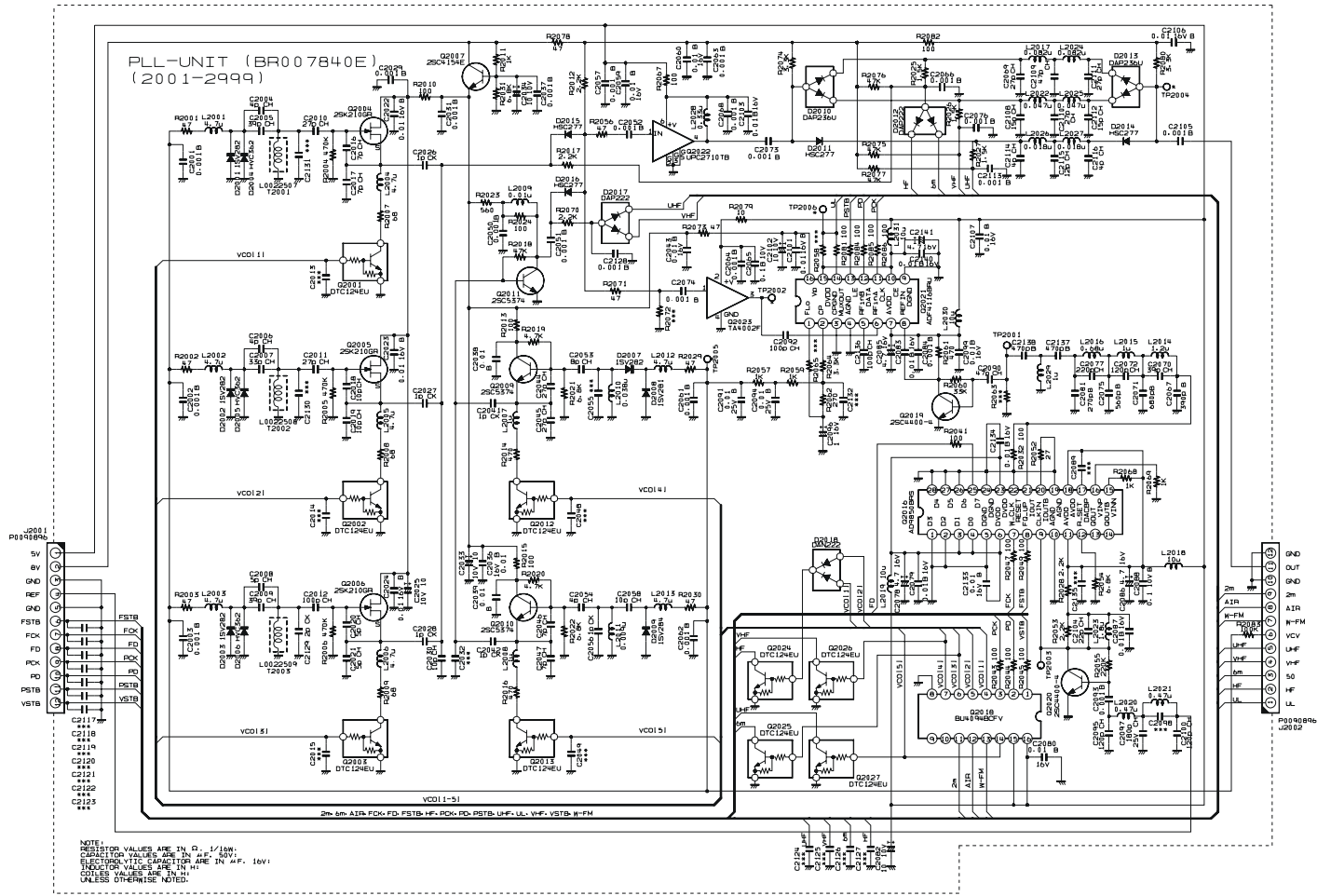

PLL Unit (Lot 66 ~)

Parts Layout

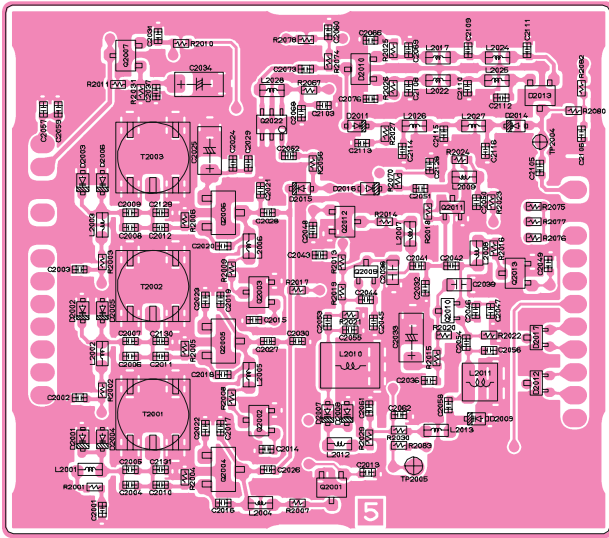

Side A

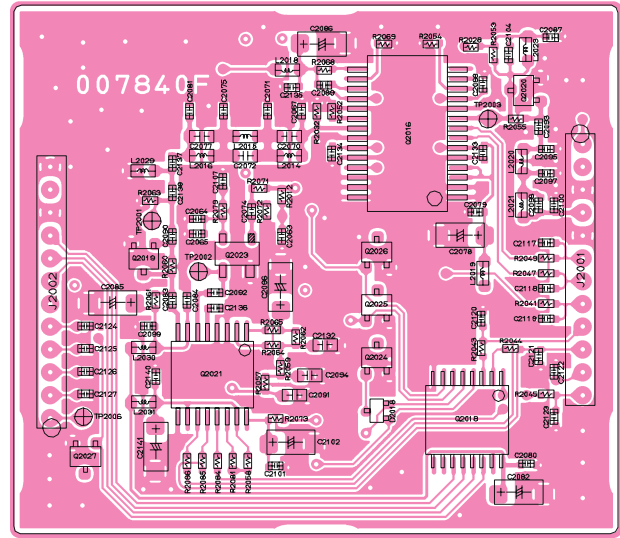

Side B

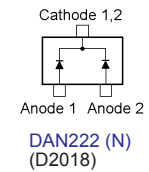
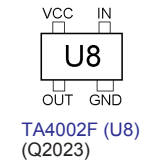
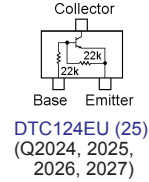
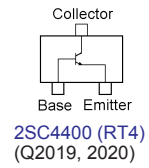
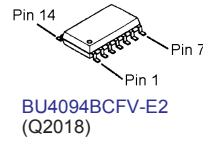
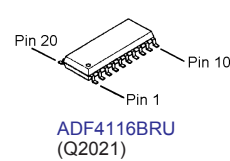
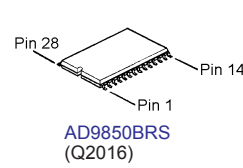
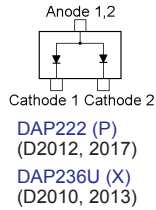
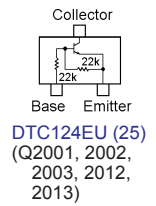
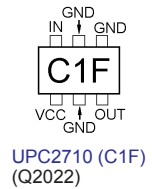
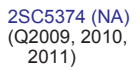
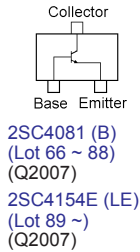
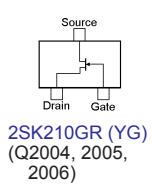

REF	DESCRIPTION	VALUE	V/W	TOL.	MFR'S DESIG	VXSTD P/N	VERS.	LOT	SIDE	LAY ADR
PCB with Components						CB1229001 (Lot 1-65)				
						CB1229002 (Lot 66-)				
Printed Circuit Board					AH007M000	FR007840C		1-11		
					AH007M000	FR007840D		12-65		
					AH007M000	FR007840F		66-		
C 2001	CHIP CAP.	0.001uF	50V	B	UMK105B102KW-F	K22178829		1-65	A	A2
C 2001	CHIP CAP.	0.001uF	50V	B	GRM155B11H102KA01D	K22178809		66-	A	A2
C 2002	CHIP CAP.	0.001uF	50V	B	UMK105B102KW-F	K22178829		1-65	A	A2
C 2002	CHIP CAP.	0.001uF	50V	B	GRM155B11H102KA01D	K22178809		66-	A	A2
C 2003	CHIP CAP.	0.001uF	50V	B	UMK105B102KW-F	K22178829		1-65	A	A1
C 2003	CHIP CAP.	0.001uF	50V	B	GRM155B11H102KA01D	K22178809		66-	A	A1
C 2004	CHIP CAP.	4pF	50V	CH	UMK105CH040CV-F	K22178252		8-65	A	A2
C 2004	CHIP CAP.	4pF	50V	CH	UMK105CH040CV-F	K22178252		66-	A	A2
C 2005	CHIP CAP.	47pF	50V	CH	UMK105CH470JV-F	K22178274		1-7	A	A2
C 2005	CHIP CAP.	39pF	50V	CH	UMK105CH390JV-F	K22178272		8-65	A	A2
C 2005	CHIP CAP.	27pF	50V	CH	GRM1552C1H270JZ01D	K22178222		66-	A	A2
C 2006	CHIP CAP.	4pF	50V	CH	UMK105CH040CV-F	K22178252		8-65	A	A2
C 2006	CHIP CAP.	3pF	50V	CJ	UMK105CJ030CV-F	K22178251		66-	A	A2
C 2007	CHIP CAP.	47pF	50V	CH	UMK105CH470JV-F	K22178274		1-7	A	A2
C 2007	CHIP CAP.	33pF	50V	CH	UMK105CH330JV-F	K22178270		8-65	A	A2
C 2007	CHIP CAP.	27pF	50V	CH	GRM1552C1H270JZ01D	K22178222		66-	A	A2
C 2008	CHIP CAP.	4pF	50V	CH	UMK105CH040CV-F	K22178252		8-50	A	A1
C 2008	CHIP CAP.	5pF	50V	CH	UMK105CH050CV-F	K22178253		51-65	A	A1
C 2008	CHIP CAP.	2pF	50V	CK	GRM1554C1H2R0CZ01D	K22178204		80-	A	A1
C 2009	CHIP CAP.	47pF	50V	CH	UMK105CH470JV-F	K22178274		1-7	A	A1
C 2009	CHIP CAP.	39pF	50V	CH	UMK105CH390JV-F	K22178272		8-65	A	A1
C 2009	CHIP CAP.	33pF	50V	CH	GRM1552C1H330JZ01D	K22178224		66-	A	A1
C 2010	CHIP CAP.	27pF	50V	CH	UMK105CH270JV-F	K22178268		1-65	A	A2
C 2010	CHIP CAP.	33pF	50V	CH	GRM1552C1H330JZ01D	K22178224		66-	A	A2
C 2011	CHIP CAP.	47pF	50V	CH	UMK105CH470JV-F	K22178274		1-7	A	A2
C 2011	CHIP CAP.	27pF	50V	CH	UMK105CH270JV-F	K22178268		8-65	A	A2
C 2011	CHIP CAP.	47pF	50V	CH	GRM1552C1H470JZ01D	K22178228		66-	A	A2
C 2012	CHIP CAP.	100pF	50V	CH	UMK105CH101JV-F	K22178282		1-65	A	A1
C 2012	CHIP CAP.	47pF	50V	CH	GRM1552C1H470JZ01D	K22178228		66-	A	A1
C 2016	CHIP CAP.	12pF	50V	CH	UMK105CH120JV-F	K22178260		1-7	A	A2
C 2016	CHIP CAP.	7pF	50V	CH	UMK105CH070DV-F	K22178255		8-	A	A2
C 2017	CHIP CAP.	12pF	50V	CH	UMK105CH120JV-F	K22178260		1-7	A	A2
C 2017	CHIP CAP.	7pF	50V	CH	UMK105CH070DV-F	K22178255		8-65	A	A2
C 2017	CHIP CAP.	33pF	50V	CH	GRM1552C1H330JZ01D	K22178224		66-	A	A2
C 2018	CHIP CAP.	10pF	50V	CH	UMK105CH100DV-F	K22178258		1-65	A	A2
C 2018	CHIP CAP.	8pF	50V	CH	GRM1552C1H8R0DZ01D	K22178210		66-	A	A2
C 2019	CHIP CAP.	10pF	50V	CH	UMK105CH100DV-F	K22178258		1-65	A	A1
C 2019	CHIP CAP.	22pF	50V	CH	UMK105CH220JV-F	K22178266		66-	A	A1
C 2020	CHIP CAP.	5pF	50V	CH	UMK105CH050CV-F	K22178253		1-65	A	A1
C 2020	CHIP CAP.	9pF	50V	CH	GRM1552C1H9R0DZ01D	K22178211		66-	A	A1
C 2021	CHIP CAP.	5pF	50V	CH	UMK105CH050CV-F	K22178253		1-65	A	A1
C 2021	CHIP CAP.	27pF	50V	CH	GRM1552C1H270JZ01D	K22178222		66-	A	A1
C 2022	CHIP CAP.	0.01uF	16V	B	GRM36B103K16PT	K22128804		1-82	A	A2
C 2022	CHIP CAP.	0.01uF	25V	B	GRM155B11E103KA01D	K22148834		83-	A	A2
C 2023	CHIP CAP.	0.01uF	16V	B	GRM36B103K16PT	K22128804		1-82	A	A1
C 2023	CHIP CAP.	0.01uF	25V	B	GRM155B11E103KA01D	K22148834		83-	A	A1
C 2024	CHIP CAP.	0.01uF	16V	B	GRM36B103K16PT	K22128804		1-82	A	A1
C 2024	CHIP CAP.	0.01uF	25V	B	GRM155B11E103KA01D	K22148834		83-	A	A1
C 2025	CHIP TA.CAP.	10uF	10V		TEESVA1A106M8R	K78100028		1-	A	A1
C 2026	CHIP CAP.	4pF	50V	CH	UMK105CH040CV-F	K22178252		1-11	A	A2
C 2026	CHIP CAP.	1pF	50V	CK	UMK105CK010CV-F	K22178248		12-65	A	A2
C 2026	CHIP CAP.	3pF	50V	CJ	UMK105CJ030CV-F	K22178251		66-	A	A2
C 2027	CHIP CAP.	3pF	50V	CJ	UMK105CJ030CV-F	K22178251		1-11	A	A2
C 2027	CHIP CAP.	1pF	50V	CK	UMK105CK010CV-F	K22178248		12-65	A	A2
C 2027	CHIP CAP.	1.5pF	50V	CK	GRM1554C1H1R5CZ01D	K22178203		66-	A	A2
C 2027	CHIP CAP.	2pF	50V	CK	GRM1554C1H2R0CZ01D	K22178204		77-	A	A2
C 2028	CHIP CAP.	2pF	50V	CK	UMK105CK020CV-F	K22178250		1-	A	A1
C 2028	CHIP CAP.	1pF	50V	CK	UMK105CK010CV-F	K22178248		12-	A	A1
C 2028	CHIP CAP.	2pF	50V	CK	GRM1554C1H2R0CZ01D	K22178204		66-	A	A1
C 2029	CHIP CAP.	0.001uF	50V	B	UMK105B102KW-F	K22178829		1-	A	A1
C 2029	CHIP CAP.	0.001uF	50V	B	GRM155B11H102KA01D	K22178809		66-	A	A1
C 2030	CHIP CAP.	10pF	50V	CH	UMK105CH100DV-F	K22178258		12-65	A	A2
C 2031	CHIP CAP.	0.001uF	50V	B	UMK105B102KW-F	K22178829		1-	A	A1
C 2031	CHIP CAP.	0.001uF	50V	B	GRM155B11H102KA01D	K22178809		66-	A	A1
C 2032	CHIP CAP.	15pF	50V	CH	GRM1552C1H150JZ01D	K22178216		66-	A	B1
C 2033	CHIP TA.CAP.	10uF	10V		TEESVA1A106M8R	K78100028		1-	A	B2
C 2034	CHIP TA.CAP.	10uF	10V		TEESVA1A106M8R	K78100028		1-	A	A1
C 2036	CHIP CAP.	0.01uF	16V	B	GRM36B103K16PT	K22128804		1-82	A	B2

PLL Unit

Parts List

REF	DESCRIPTION	VALUE	V/W	TOL.	MFR'S DESIG	VXSTD P/N	VERS.	LOT	SIDE	LAY ADR
C 2036	CHIP CAP.	0.01uF	25V	B	GRM155B11E103KA01D	K22148834		83-	A	B2
C 2037	CHIP CAP.	0.001uF	50V	B	UMK105B102KW-F	K22178829		1-65	A	A1
C 2037	CHIP CAP.	0.001uF	50V	B	GRM155B11H102KA01D	K22178809		66-	A	A1
C 2038	CHIP CAP.	0.01uF	50V	B	GRM188B11H103KA01D	K22174823		1-	A	B1
C 2039	CHIP CAP.	0.01uF	50V	B	GRM188B11H103KA01D	K22174823		1-	A	B1
C 2041	CHIP CAP.	2pF	50V	CK	UMK105CK020CV-F	K22178250		1-11	A	B1
C 2041	CHIP CAP.	1pF	50V	CK	UMK105CK010CV-F	K22178248		12-65	A	B1
C 2041	CHIP CAP.	3pF	50V	CJ	UMK105CJ030CV-F	K22178251		66-	A	B1
C 2042	CHIP CAP.	3pF	50V	CJ	UMK105CJ030CV-F	K22178251		1-11	A	B1
C 2042	CHIP CAP.	1pF	50V	CK	UMK105CK010CV-F	K22178248		12-	A	B1
C 2043	CHIP CAP.	0.01uF	16V	B	GRM36B103K16PT	K22128804		1-82	A	B1
C 2043	CHIP CAP.	0.01uF	25V	B	GRM155B11E103KA01D	K22148834		83-	A	B1
C 2044	CHIP CAP.	33pF	50V	CH	UMK105CH330JV-F	K22178270		1-65	A	B1
C 2044	CHIP CAP.	27pF	50V	CH	GRM1552C1H270JZ01D	K22178222		66-	A	B1
C 2045	CHIP CAP.	33pF	50V	CH	UMK105CH330JV-F	K22178270		1-65	A	B2
C 2045	CHIP CAP.	27pF	50V	CH	GRM1552C1H270JZ01D	K22178222		66-	A	B2
C 2046	CHIP CAP.	7pF	50V	CH	UMK105CH070DV-F	K22178255		1-	A	B2
C 2047	CHIP CAP.	7pF	50V	CH	UMK105CH070DV-F	K22178255		1-	A	B2
C 2050	CHIP CAP.	0.001uF	50V	B	UMK105B102KW-F	K22178829		1-65	A	B1
C 2050	CHIP CAP.	0.001uF	50V	B	GRM155B11H102KA01D	K22178809		66-	A	B1
C 2051	CHIP CAP.	0.001uF	50V	B	UMK105B102KW-F	K22178829		1-65	A	B1
C 2051	CHIP CAP.	0.001uF	50V	B	GRM155B11H102KA01D	K22178809		66-	A	B1
C 2052	CHIP CAP.	0.001uF	50V	B	UMK105B102KW-F	K22178829		1-65	A	A1
C 2052	CHIP CAP.	0.001uF	50V	B	GRM155B11H102KA01D	K22178809		66-	A	A1
C 2053	CHIP CAP.	5pF	50V	CH	UMK105CH050CV-F	K22178253		1-65	A	B2
C 2053	CHIP CAP.	8pF	50V	CH	GRM1552C1H8R0DZ01D	K22178210		66-	A	B2
C 2054	CHIP CAP.	4pF	50V	CH	UMK105CH040CV-F	K22178252		1-	A	B2
C 2056	CHIP CAP.	0.5pF	50V	CK	UMK105CK0R5CV-F	K22178247		64-	A	B2
C 2056	CHIP CAP.	1pF	50V	CK	UMK105CK010CV-F	K22178248		66-	A	B2
C 2057	CHIP CAP.	0.001uF	50V	B	UMK105B102KW-F	K22178829		1-65	A	A1
C 2057	CHIP CAP.	0.001uF	50V	B	GRM155B11H102KA01D	K22178809		66-	A	A1
C 2058	CHIP CAP.	10pF	50V	CH	UMK105CH100DV-F	K22178258		1-	A	B2
C 2059	CHIP CAP.	0.01uF	16V	B	GRM36B103K16PT	K22128804		1-82	A	A1
C 2059	CHIP CAP.	0.01uF	25V	B	GRM155B11E103KA01D	K22148834		83-	A	A1
C 2060	CHIP CAP.	0.01uF	16V	B	GRM36B103K16PT	K22128804		1-82	A	B1
C 2060	CHIP CAP.	0.01uF	25V	B	GRM155B11E103KA01D	K22148834		83-	A	B1
C 2061	CHIP CAP.	0.001uF	50V	B	UMK105B102KW-F	K22178829		1-65	A	B2
C 2061	CHIP CAP.	0.001uF	50V	B	GRM155B11H102KA01D	K22178809		66-	A	B2
C 2062	CHIP CAP.	0.001uF	50V	B	UMK105B102KW-F	K22178829		1-65	A	B2
C 2062	CHIP CAP.	0.001uF	50V	B	GRM155B11H102KA01D	K22178809		66-	A	B2
C 2063	CHIP CAP.	0.001uF	50V	B	UMK105B102KW-F	K22178829		1-65	B	a1
C 2063	CHIP CAP.	0.001uF	50V	B	GRM155B11H102KA01D	K22178809		66-	B	a1
C 2064	CHIP CAP.	0.001uF	50V	B	UMK105B102KW-F	K22178829		1-65	B	a1
C 2064	CHIP CAP.	0.001uF	50V	B	GRM155B11H102KA01D	K22178809		66-	B	a1
C 2065	CHIP CAP.	0.1uF	10V	B	GRM155B11A104KA01D	K22108802		1-	B	a1
C 2066	CHIP CAP.	0.001uF	50V	B	UMK105B102KW-F	K22178829		1-65	A	B1
C 2066	CHIP CAP.	0.001uF	50V	B	GRM155B11H102KA01D	K22178809		66-	A	B1
C 2067	CHIP CAP.	270pF	50V	B	UMK105B271KW-F	K22178822		1	B	a1
C 2067	CHIP CAP.	330pF	50V	B	UMK105B331KW-F	K22178823		2-65	B	a1
C 2067	CHIP CAP.	390pF	50V	B	UMK105B391KW-F	K22178824		66-	B	a1
C 2068	CHIP CAP.	0.001uF	50V	B	UMK105B102KW-F	K22178829		1-65	A	A1
C 2068	CHIP CAP.	0.001uF	50V	B	GRM155B11H102KA01D	K22178809		66-	A	A1
C 2069	CHIP CAP.	27pF	50V	CH	UMK105CH270JV-F	K22178268		1-65	A	B1
C 2069	CHIP CAP.	27pF	50V	CH	GRM1552C1H270JZ01D	K22178222		66-	A	B1
C 2070	CHIP CAP.	22pF	50V	CH	GRM1882C1H220JA01D	K22174219		1	B	a1
C 2070	CHIP CAP.	82pF	50V	CH	GRM1882C1H820JA01D	K22174233		2-65	B	a1
C 2070	CHIP CAP.	39pF	50V	CH	GRM1882C1H390JA01D	K22174225		66-	B	a1
C 2071	CHIP CAP.	390pF	50V	B	UMK105B391KW-F	K22178824		1	B	a1
C 2071	CHIP CAP.	680pF	50V	B	UMK105B681KW-F	K22178827		2-	B	a1
C 2072	CHIP CAP.	47pF	50V	CH	GRM1882C1H470JA01D	K22174227		1	B	a1
C 2072	CHIP CAP.	68pF	50V	CH	GRM1882C1H680JA01D	K22174231		2-11	B	a1
C 2072	CHIP CAP.	33pF	50V	CH	GRM1882C1H330JA01D	K22174223		12-65	B	a1
C 2072	CHIP CAP.	120pF	50V	CH	GRM1882C1H121JA01D	K22174237		66-	B	a1
C 2073	CHIP CAP.	0.001uF	50V	B	UMK105B102KW-F	K22178829		1-65	A	A1
C 2073	CHIP CAP.	0.001uF	50V	B	GRM155B11H102KA01D	K22178809		66-	A	A1
C 2074	CHIP CAP.	0.001uF	50V	B	UMK105B102KW-F	K22178829		1-65	B	a1
C 2074	CHIP CAP.	0.001uF	50V	B	GRM155B11H102KA01D	K22178809		66-	B	a1
C 2075	CHIP CAP.	390pF	50V	B	UMK105B391KW-F	K22178824		1	B	a1
C 2075	CHIP CAP.	680pF	50V	B	UMK105B681KW-F	K22178827		2-65	B	a1
C 2075	CHIP CAP.	560pF	50V	B	UMK105B561KW-F	K22178826		66-	B	a1
C 2076	CHIP CAP.	0.001uF	50V	B	UMK105B102KW-F	K22178829		1-65	A	B1
C 2076	CHIP CAP.	0.001uF	50V	B	GRM155B11H102KA01D	K22178809		66-	A	B1
C 2077	CHIP CAP.	68pF	50V	CH	UMK105CH680JV-F	K22178278		1	B	a1

PLL Unit

Parts List

REF	DESCRIPTION	VALUE	V/W	TOL.	MFR'S DESIG	VXSTD P/N	VERS.	LOT	SIDE	LAY ADR
C 2077	CHIP CAP.	22pF	50V	CH	UMK105CH220JV-F	K22178266		2-11	B	a1
C 2077	CHIP CAP.	27pF	50V	CH	UMK105CH270JV-F	K22178268		12-65	B	a1
C 2077	CHIP CAP.	220pF	50V	CH	GRM1882C1H221JA01D	K22174243		66-	B	a1
C 2078	CHIP TA.CAP.	4.7uF	16V		TEESVA1C475M8R	K78120031		1-	B	b1
C 2079	CHIP CAP.	0.01uF	16V	B	GRM36B103K16PT	K22128804		1-82	B	b1
C 2079	CHIP CAP.	0.01uF	25V	B	GRM155B11E103KA01D	K22148834		83-	B	b1
C 2080	CHIP CAP.	0.01uF	16V	B	GRM36B103K16PT	K22128804		1-82	B	b2
C 2080	CHIP CAP.	0.01uF	25V	B	GRM155B11E103KA01D	K22148834		83-	B	b2
C 2081	CHIP CAP.	390pF	50V	B	UMK105B391KW-F	K22178824		1-65	B	a1
C 2081	CHIP CAP.	270pF	50V	B	UMK105B271KW-F	K22178822		66-	B	a1
C 2082	CHIP TA.CAP.	10uF	10V		TEESVA1A106M8R	K78100028		1-	B	b2
C 2083	CHIP CAP.	0.01uF	16V	B	GRM36B103K16PT	K22128804		66-82	B	a1
C 2083	CHIP CAP.	0.01uF	25V	B	GRM155B11E103KA01D	K22148834		83-	B	a1
C 2084	CHIP CAP.	0.001uF	50V	B	UMK105B102KW-F	K22178829		1-65	B	a1
C 2084	CHIP CAP.	0.001uF	50V	B	GRM155B11H102KA01D	K22178809		66-	B	a1
C 2085	CHIP CAP.	0.1uF	16V	B	GRM188B11C104KA01D	K22124805		1-65	B	a1
C 2085	CHIP TA.CAP.	4.7uF	16V		TEESVA1C475M8R	K78120031		66-	B	a1
C 2086	CHIP TA.CAP.	4.7uF	16V		TEESVA1C475M8R	K78120031		1-	B	b1
C 2087	CHIP CAP.	0.01uF	16V	B	GRM36B103K16PT	K22128804		1-82	B	b1
C 2087	CHIP CAP.	0.01uF	25V	B	GRM155B11E103KA01D	K22148834		83-	B	b1
C 2088	CHIP CAP.	0.01uF	16V	B	GRM36B103K16PT	K22128804		1	B	b1
C 2088	CHIP CAP.	0.1uF	10V	B	GRM155B11A104KA01D	K22108802		2-	B	b1
C 2090	CHIP CAP.	22pF	50V	CH	GRM1882C1H220JA01D	K22174219		1	B	a1
C 2090	CHIP CAP.	5pF	50V	CH	GRM1882C1H5R0CZ01D	K22174206		2-11	B	a1
C 2090	CHIP CAP.	47pF	50V	CH	GRM1882C1H470JA01D	K22174227		12-65	B	a1
C 2090	CHIP CAP.	47pF	50V	CH	GRM1552C1H470JZ01D	K22178228		66-	B	a1
C 2091	CHIP CAP.	0.01uF	50V	B	GRM188B11H103KA01D	K22174823		1-	B	a2
C 2092	CHIP CAP.	0.001uF	50V	B	UMK105B102KW-F	K22178829		1-65	B	a1
C 2092	CHIP CAP.	100pF	50V	CH	GRM1552C1H101JD01D	K22178236		66-	B	a1
C 2093	CHIP CAP.	0.001uF	50V	B	UMK105B102KW-F	K22178829		1-65	B	b1
C 2093	CHIP CAP.	0.001uF	50V	B	GRM155B11H102KA01D	K22178809		66-	B	b1
C 2094	CHIP CAP.	0.01uF	50V	B	GRM188B11H103KA01D	K22174823		1-	B	a2
C 2095	CHIP CAP.	120pF	50V	CH	UMK105CH121JV-F	K22178284		1-	B	b1
C 2096	CHIP TA.CAP.	1uF	16V		TMCSA1C105MTR	K78120023		1-	B	a1
C 2097	CHIP CAP.	180pF	25V	CH	GRM36CH181J25PT	K22148201		1-65	B	b1
C 2097	CHIP CAP.	180pF	25V	CH	TMK105CH181JV-F	K22148244		66-	B	b1
C 2099	CHIP CAP.	0.1uF	16V	B	GRM188B11C104KA01D	K22124805		1-65	B	a2
C 2099	CHIP CAP.	0.01uF	16V	B	GRM36B103K16PT	K22128804		66-82	B	a2
C 2099	CHIP CAP.	0.01uF	25V	B	GRM155B11E103KA01D	K22148834		83-	B	a2
C 2100	CHIP CAP.	120pF	50V	CH	UMK105CH121JV-F	K22178284		1-	B	b1
C 2101	CHIP CAP.	0.01uF	50V	B	GRM188B11H103KA01D	K22174823		1-65	B	a2
C 2101	CHIP CAP.	0.01uF	16V	B	GRM36B103K16PT	K22128804		66-82	B	a2
C 2101	CHIP CAP.	0.01uF	25V	B	GRM155B11E103KA01D	K22148834		83-	B	a2
C 2102	CHIP TA.CAP.	10uF	10V		TEESVA1A106M8R	K78100028		1-	B	a2
C 2103	CHIP CAP.	0.01uF	16V	B	GRM36B103K16PT	K22128804		1-82	A	B1
C 2103	CHIP CAP.	0.01uF	25V	B	GRM155B11E103KA01D	K22148834		83-	A	B1
C 2104	CHIP CAP.	22pF	50V	CH	UMK105CH220JV-F	K22178266		1-	B	b1
C 2105	CHIP CAP.	0.001uF	50V	B	UMK105B102KW-F	K22178829		1-65	A	B1
C 2105	CHIP CAP.	0.001uF	50V	B	GRM155B11H102KA01D	K22178809		66-	A	B1
C 2106	CHIP CAP.	0.01uF	16V	B	GRM36B103K16PT	K22128804		1-82	A	B1
C 2106	CHIP CAP.	0.01uF	25V	B	GRM155B11E103KA01D	K22148834		83-	A	B1
C 2107	CHIP CAP.	0.01uF	16V	B	GRM36B103K16PT	K22128804		1-82	B	a1
C 2107	CHIP CAP.	0.01uF	25V	B	GRM155B11E103KA01D	K22148834		83-	B	a1
C 2108	CHIP CAP.	15pF	50V	CH	UMK105CH150JV-F	K22178262		1-	A	B1
C 2109	CHIP CAP.	47pF	50V	CH	UMK105CH470JV-F	K22178274		1-65	A	B1
C 2109	CHIP CAP.	47pF	50V	CH	GRM1552C1H470JZ01D	K22178228		66-	A	B1
C 2110	CHIP CAP.	27pF	50V	CH	UMK105CH270JV-F	K22178268		1-65	A	B1
C 2110	CHIP CAP.	27pF	50V	CH	GRM1552C1H270JZ01D	K22178222		66-	A	B1
C 2111	CHIP CAP.	27pF	50V	CH	UMK105CH270JV-F	K22178268		1-65	A	B1
C 2111	CHIP CAP.	27pF	50V	CH	GRM1552C1H270JZ01D	K22178222		66-	A	B1
C 2112	CHIP CAP.	15pF	50V	CH	UMK105CH150JV-F	K22178262		1-	A	B1
C 2113	CHIP CAP.	0.001uF	50V	B	UMK105B102KW-F	K22178829		1-65	A	B1
C 2113	CHIP CAP.	0.001uF	50V	B	GRM155B11H102KA01D	K22178809		66-	A	B1
C 2114	CHIP CAP.	4pF	50V	CH	UMK105CH040CV-F	K22178252		1-	A	B1
C 2115	CHIP CAP.	12pF	50V	CH	UMK105CH120JV-F	K22178260		1-	A	B1
C 2116	CHIP CAP.	4pF	50V	CH	UMK105CH040CV-F	K22178252		1-	A	B1
C 2128	CHIP CAP.	0.001uF	50V	B	UMK105B102KW-F	K22178829		1-65	A	B1
C 2128	CHIP CAP.	0.001uF	50V	B	GRM155B11H102KA01D	K22178809		66-	A	B1
C 2129	CHIP CAP.	3pF	50V	CJ	UMK105CJ030CV-F	K22178251		1-7	A	A1
C 2129	CHIP CAP.	2pF	50V	CK	UMK105CK020CV-F	K22178250		8-65	A	A1
C 2129	CHIP CAP.	1pF	50V	CK	UMK105CK010CV-F	K22178248		66-	A	A1
C 2130	CHIP CAP.	1pF	50V	CK	UMK105CK010CV-F	K22178248		66-	A	A2
C 2131	CHIP CAP.	0.5pF	50V	CK	UMK105CK0R5CV-F	K22178247		66-	A	A2

PLL Unit

Parts List

REF	DESCRIPTION	VALUE	V/W	TOL.	MFR'S DESIG	VXSTD P/N	VERS.	LOT	SIDE	LAY ADR
C 2132	CHIP CAP.	100pF	50V	CH	UMK105CH101JV-F	K22178282		1	B	b2
C 2133	CHIP CAP.	0.01uF	16V	B	GRM36B103K16PT	K22128804		1-82	B	b1
C 2133	CHIP CAP.	0.01uF	25V	B	GRM155B11E103KA01D	K22148834		83-	B	b1
C 2134	CHIP CAP.	0.01uF	16V	B	GRM36B103K16PT	K22128804		1-82	B	b1
C 2134	CHIP CAP.	0.01uF	25V	B	GRM155B11E103KA01D	K22148834		83-	B	b1
C 2136	CHIP CAP.	100pF	50V	CH	GRM1552C1H101JD01D	K22178236		66-	B	a2
C 2137	CHIP CAP.	820pF	50V	B	UMK105B821KW-F	K22178828		12-65	B	a1
C 2137	CHIP CAP.	470pF	50V	B	GRM155B11H471KA01D	K22178805		66-	B	a1
C 2138	CHIP CAP.	820pF	50V	B	UMK105B821KW-F	K22178828		12-65	B	a1
C 2138	CHIP CAP.	470pF	50V	B	GRM155B11H471KA01D	K22178805		66-	B	a1
C 2139	CHIP CAP.	0.0012uF	50V	B	UMK105B122KW-F	K22178830		12-65	B	a1
C 2140	CHIP CAP.	0.01uF	16V	B	GRM36B103K16PT	K22128804		66-82	B	a2
C 2140	CHIP CAP.	0.01uF	25V	B	GRM155B11E103KA01D	K22148834		83-	B	a2
C 2141	CHIP TA.CAP.	4.7uF	16V		TEESVA1C475M8R	K78120031		66-	B	a2
D 2001	DIODE				HVC362TRF-E	G2070636		1-7	A	A2
D 2001	DIODE				1SV282(TPH3.F)	G2070778		8-65	A	A2
D 2001	DIODE				1SV325(TPH3.F)	G2070848		66-	A	A2
D 2002	DIODE				HVC362TRF-E	G2070636		1-7	A	A2
D 2002	DIODE				1SV282(TPH3.F)	G2070778		8-65	A	A2
D 2002	DIODE				1SV325(TPH3.F)	G2070848		66-	A	A2
D 2003	DIODE				HVC362TRF-E	G2070636		1-7	A	A1
D 2003	DIODE				1SV282(TPH3.F)	G2070778		8-65	A	A1
D 2003	DIODE				1SV325(TPH3.F)	G2070848		66-	A	A1
D 2004	DIODE				HVC362TRF-E	G2070636		1-65	A	A2
D 2004	DIODE				1SV325(TPH3.F)	G2070848		66-	A	A2
D 2005	DIODE				HVC362TRF-E	G2070636		1-65	A	A2
D 2005	DIODE				1SV325(TPH3.F)	G2070848		66-	A	A2
D 2006	DIODE				HVC362TRF-E	G2070636		1-65	A	A1
D 2006	DIODE				1SV325(TPH3.F)	G2070848		66-	A	A1
D 2007	DIODE				1SV282(TPH3.F)	G2070778		1-	A	B2
D 2008	DIODE				1SV281(TPH3.F)	G2070620		1-	A	B2
D 2009	DIODE				1SV286(TPH3.F)	G2070610		1-65	A	B2
D 2009	DIODE				1SV284(TPH3.F)	G2070622		66-	A	B2
D 2010	DIODE				DAP236U T106	G2070592		1-	A	B1
D 2011	DIODE				HSC277TRF-E	G2070584		1-	A	B1
D 2012	DIODE				DAP222-TL	G2070432		1-	A	B2
D 2013	DIODE				DAP236U T106	G2070592		1-	A	B1
D 2014	DIODE				HSC277TRF-E	G2070584		1-	A	B1
D 2015	DIODE				HSC277TRF-E	G2070584		1-	A	A1
D 2016	DIODE				HSC277TRF-E	G2070584		1-	A	B1
D 2017	DIODE				DAP222-TL	G2070432		1-	A	B2
D 2018	DIODE				DAN222 TL	G2070174		66-	B	b2
J 2001	CONNECTOR				9230B-1-12Z003-T	P0090896		1-	B	b1
J 2002	CONNECTOR				9230B-1-12Z003-T	P0090896		1-	B	a2
L 2001	M.RFC	4.7uH			LK1608 4R7K-T	L1690688		1-	A	A2
L 2002	M.RFC	4.7uH			LK1608 4R7K-T	L1690688		1-	A	A2
L 2003	M.RFC	4.7uH			LK1608 4R7K-T	L1690688		1-	A	A1
L 2004	M.RFC	4.7uH			LK1608 4R7K-T	L1690688		1-	A	A2
L 2005	M.RFC	4.7uH			LK1608 4R7K-T	L1690688		1-	A	A2
L 2006	M.RFC	4.7uH			LK1608 4R7K-T	L1690688		1-	A	A1
L 2007	M.RFC	1uH			LK1608 1R0K-T	L1690687		1-	A	B1
L 2008	M.RFC	1uH			LK1608 1R0K-T	L1690687		1-	A	B1
L 2009	M.RFC	0.01uH			HK1608 10NJ-T	L1690516		1-67	A	B1
L 2009	M.RFC	0.015uH			HK1608 15NJ-T	L1690518		68-	A	B1
L 2010	COIL				E2 0.4-2.0-5.5T-L	L0022630		1-65	A	B2
L 2010	COIL	0.038uH			AS050630-38N	L0022818		66-	A	B2
L 2011	COIL				E2 0.45-1.4-2.5T-L	L0022618		1-63	A	B2
L 2011	COIL	0.009uH			AS050325-9RONK	L0022612		64-	A	B2
L 2012	M.RFC	4.7uH			LK1608 4R7K-T	L1690688		1-	A	B2
L 2013	M.RFC	4.7uH			LK1608 4R7K-T	L1690688		1-	A	B2
L 2014	M.RFC	2.2uH			LK1608 2R2K-T	L1690634		1	B	a1
L 2014	M.RFC	1.2uH			LK1608 1R2K-T	L1690845		2-	B	a1
L 2015	M.RFC	2.2uH			LK1608 2R2K-T	L1690634		1	B	a1
L 2015	M.RFC	1.8uH			LK1608 1R8K-T	L1690847		2-65	B	a1
L 2015	M.RFC	1uH			LK1608 1R0K-T	L1690687		66-	B	a1
L 2016	M.RFC	1.8uH			LK1608 1R8K-T	L1690847		1-65	B	a1
L 2016	M.RFC	0.68uH			LK1608 R68K-T	L1690416		66-	B	a1
L 2017	M.RFC	0.082uH			HK1608 82NJ-T	L1690527		1-	A	B1
L 2018	M.RFC	10uH			LK1608 100K-T	L1690689		1-	B	a1
L 2019	M.RFC	10uH			LK1608 100K-T	L1690689		1-	B	b1
L 2020	M.RFC	0.47uH			LK1608 R47K-T	L1690414		1-	B	b1
L 2021	M.RFC	0.47uH			LK1608 R47K-T	L1690414		1-	B	b1
L 2022	M.RFC	0.047uH			HK1608 47NJ-T	L1690524		1-	A	B1

PLL Unit

Parts List

REF	DESCRIPTION	VALUE	V/W	TOL.	MFR'S DESIG	VXSTD P/N	VERS.	LOT	SIDE	LAY ADR
L 2023	M.RFC	1.8uH			LK1608 1R8K-T	L1690847		1-	B	b1
L 2024	M.RFC	0.082uH			HK1608 82NJ-T	L1690527		1-	A	B1
L 2025	M.RFC	0.047uH			HK1608 47NJ-T	L1690524		1-	A	B1
L 2026	M.RFC	0.018uH			HK1608 18NJ-T	L1690519		1-	A	B1
L 2027	M.RFC	0.018uH			HK1608 18NJ-T	L1690519		1-	A	B1
L 2028	M.RFC	0.33uH			LK1608 R33K-T	L1690412		12-	A	A1
L 2029	M.RFC	2.2uH			LK1608 2R2K-T	L1690634		12-65	B	a1
L 2029	M.RFC	1uH			LK1608 1R0K-T	L1690687		66-	B	a1
L 2030	M.RFC	10uH			LK1608 100K-T	L1690689		66-	B	a2
L 2031	M.RFC	10uH			LK1608 100K-T	L1690689		66-	B	a2
Q 2001	TRANSISTOR				DTC124EU T106	G3070045		1-	A	B2
Q 2002	TRANSISTOR				DTC124EU T106	G3070045		1-	A	A2
Q 2003	TRANSISTOR				DTC124EU T106	G3070045		1-	A	A1
Q 2004	FET				2SK210-GR(TE85R.F)	G3802107G		1-	A	A2
Q 2005	FET				2SK210-GR(TE85R.F)	G3802107G		1-	A	A2
Q 2006	FET				2SK210-GR(TE85R.F)	G3802107G		1-	A	A1
Q 2007	TRANSISTOR				2SC4154-T111-1E	G3341548E		1-88	A	A1
Q 2007	TRANSISTOR				2SC4081 T106	G3340818		89-	A	A1
Q 2009	TRANSISTOR				2SC5374-TL	G3353748		1-	A	B1
Q 2010	TRANSISTOR				2SC5374-TL	G3353748		1-	A	B2
Q 2011	TRANSISTOR				2SC5374-TL	G3353748		1-	A	B1
Q 2012	TRANSISTOR				DTC124EU T106	G3070045		1-	A	B1
Q 2013	TRANSISTOR				DTC124EU T106	G3070045		1-	A	B1
Q 2016	IC				AD9850BRSZ-REEL	G1092567		1-	B	b1
Q 2018	IC				BU4094BCFV-E2	G1093527		1-	B	b2
Q 2019	TRANSISTOR				2SC4400-4-TL	G3344008D		66-	B	a1
Q 2020	TRANSISTOR				2SC4400-4-TL	G3344008D		1-	B	b1
Q 2021	IC				FQ7925	G1091710		1-65	B	a2
Q 2021	IC				ADF4116BRU(TAPE)	G1093581		66-	B	a2
Q 2022	IC				UPC2713T-E3	G1092862		1-11	A	A1
Q 2022	IC				UPC2710TB-E3	G1093932		12-	A	A1
Q 2023	IC				UPC1688G-T1-A	G1092286		1-11	B	a1
Q 2023	IC				TA4002F(TE85L.F)	G1092813		12-	B	a1
Q 2024	TRANSISTOR				DTC124EU T106	G3070045		66-	B	b2
Q 2025	TRANSISTOR				DTC124EU T106	G3070045		66-	B	b1
Q 2026	TRANSISTOR				DTC124EU T106	G3070045		66-	B	b1
Q 2027	TRANSISTOR				DTC124EU T106	G3070045		66-	B	a2
R 2001	CHIP RES.	47	1/16W	5%	RMC1/16S 470JTH	J24189009		1-	A	A2
R 2002	CHIP RES.	47	1/16W	5%	RMC1/16S 470JTH	J24189009		1-	A	A2
R 2003	CHIP RES.	47	1/16W	5%	RMC1/16S 470JTH	J24189009		1-	A	A1
R 2004	CHIP RES.	470k	1/16W	5%	RMC1/16S 474JTH	J24189057		1-65	A	A2
R 2004	CHIP RES.	100k	1/16W	5%	RMC1/16S 104JTH	J24189049		66-	A	A2
R 2005	CHIP RES.	470k	1/16W	5%	RMC1/16S 474JTH	J24189057		1-65	A	A2
R 2005	CHIP RES.	100k	1/16W	5%	RMC1/16S 104JTH	J24189049		66-	A	A2
R 2006	CHIP RES.	470k	1/16W	5%	RMC1/16S 474JTH	J24189057		1-65	A	A1
R 2006	CHIP RES.	100k	1/16W	5%	RMC1/16S 104JTH	J24189049		66-	A	A1
R 2007	CHIP RES.	68	1/16W	5%	RMC1/16S 680JTH	J24189011		1-65	A	A2
R 2007	CHIP RES.	150	1/16W	5%	RMC1/16S 151JTH	J24189015		66-	A	A2
R 2008	CHIP RES.	68	1/16W	5%	RMC1/16S 680JTH	J24189011		1-65	A	A2
R 2008	CHIP RES.	150	1/16W	5%	RMC1/16S 151JTH	J24189015		66-	A	A2
R 2009	CHIP RES.	68	1/16W	5%	RMC1/16S 680JTH	J24189011		1-65	A	A1
R 2009	CHIP RES.	150	1/16W	5%	RMC1/16S 151JTH	J24189015		66-	A	A1
R 2010	CHIP RES.	47	1/16W	5%	RMC1/16S 470JTH	J24189009		1-11	A	A1
R 2010	CHIP RES.	100	1/16W	5%	RMC1/16S 101JTH	J24189013		12-	A	A1
R 2011	CHIP RES.	1k	1/16W	5%	RMC1/16S 102JTH	J24189025		1-11	A	A1
R 2011	CHIP RES.	470	1/16W	5%	RMC1/16S 471JTH	J24189021		12-65	A	A1
R 2011	CHIP RES.	1k	1/16W	5%	RMC1/16S 102JTH	J24189025		66-	A	A1
R 2012	CHIP RES.	2.2k	1/16W	5%	RMC1/16S 222JTH	J24189029		1-	B	a1
R 2013	CHIP RES.	100	1/16W	5%	RMC1/16S 101JTH	J24189013		1-	A	B1
R 2014	CHIP RES.	470	1/16W	5%	RMC1/16S 471JTH	J24189021		1-65	A	B1
R 2014	CHIP RES.	680	1/16W	5%	RMC1/16S 681JTH	J24189023		66-	A	B1
R 2015	CHIP RES.	100	1/16W	5%	RMC1/16S 101JTH	J24189013		1-	A	B2
R 2016	CHIP RES.	470	1/16W	5%	RMC1/16S 471JTH	J24189021		1-	A	B1
R 2017	CHIP RES.	2.2k	1/16W	5%	RMC1/16S 222JTH	J24189029		1-	A	A1
R 2018	CHIP RES.	68k	1/16W	5%	RMC1/16S 683JTH	J24189047		1-11	A	B1
R 2018	CHIP RES.	47k	1/16W	5%	RMC1/16S 473JTH	J24189045		12-	A	B1
R 2019	CHIP RES.	4.7k	1/16W	5%	RMC1/16S 472JTH	J24189033		1-	A	B1
R 2020	CHIP RES.	4.7k	1/16W	5%	RMC1/16S 472JTH	J24189033		1-	A	B2
R 2021	CHIP RES.	10k	1/16W	5%	RMC1/16S 103JTH	J24189037		1-11	A	B2
R 2021	CHIP RES.	6.8k	1/16W	5%	RMC1/16S 682JTH	J24189035		12-	A	B2
R 2022	CHIP RES.	10k	1/16W	5%	RMC1/16S 103JTH	J24189037		1-11	A	B2
R 2022	CHIP RES.	6.8k	1/16W	5%	RMC1/16S 682JTH	J24189035		12-	A	B2
R 2023	CHIP RES.	560	1/16W	5%	RMC1/16S 561JTH	J24189022		1-	A	B1

PLL Unit

Parts List

REF	DESCRIPTION	VALUE	V/W	TOL.	MFR'S DESIG	VXSTD P/N	VERS.	LOT	SIDE	LAY ADR
R 2024	CHIP RES.	100	1/16W	5%	RMC1/16S 101JTH	J24189013		1-	A	B1
R 2025	CHIP RES.	1.5k	1/16W	5%	RMC1/16S 152JTH	J24189027		1-	A	B1
R 2026	CHIP RES.	1.5k	1/16W	5%	RMC1/16S 152JTH	J24189027		1-	A	B1
R 2027	CHIP RES.	1.5k	1/16W	5%	RMC1/16S 152JTH	J24189027		1-	A	B1
R 2028	CHIP RES.	2.2k	1/16W	5%	RMC1/16S 222JTH	J24189029		1-	B	b1
R 2029	CHIP RES.	47	1/16W	5%	RMC1/16S 470JTH	J24189009		1-	A	B2
R 2030	CHIP RES.	47	1/16W	5%	RMC1/16S 470JTH	J24189009		1-	A	B2
R 2031	CHIP RES.	6.8k	1/16W	5%	RMC1/16S 682JTH	J24189035		66-	A	A1
R 2032	CHIP RES.	100	1/16W	5%	RMC1/16S 101JTH	J24189013		1	B	b1
R 2032	CHIP RES.	47	1/16W	5%	RMC1/16S 470JTH	J24189009		2-11	B	b1
R 2032	CHIP RES.	100	1/16W	5%	RMC1/16S 101JTH	J24189013		12-	B	b1
R 2041	CHIP RES.	470	1/16W	5%	RMC1/16S 471JTH	J24189021		1-65	B	b1
R 2041	CHIP RES.	100	1/16W	5%	RMC1/16S 101JTH	J24189013		66-	B	b1
R 2043	CHIP RES.	470	1/16W	5%	RMC1/16S 471JTH	J24189021		1-65	B	b2
R 2043	CHIP RES.	100	1/16W	5%	RMC1/16S 101JTH	J24189013		66-	B	b2
R 2044	CHIP RES.	470	1/16W	5%	RMC1/16S 471JTH	J24189021		1-65	B	b2
R 2044	CHIP RES.	100	1/16W	5%	RMC1/16S 101JTH	J24189013		66-	B	b2
R 2045	CHIP RES.	470	1/16W	5%	RMC1/16S 471JTH	J24189021		1-65	B	b2
R 2045	CHIP RES.	100	1/16W	5%	RMC1/16S 101JTH	J24189013		66-	B	b2
R 2047	CHIP RES.	470	1/16W	5%	RMC1/16S 471JTH	J24189021		1-65	B	b1
R 2047	CHIP RES.	100	1/16W	5%	RMC1/16S 101JTH	J24189013		66-	B	b1
R 2049	CHIP RES.	470	1/16W	5%	RMC1/16S 471JTH	J24189021		1-65	B	b1
R 2049	CHIP RES.	100	1/16W	5%	RMC1/16S 101JTH	J24189013		66-	B	b1
R 2052	CHIP RES.	27	1/16W	5%	RMC1/16S 270JTH	J24189006		1-	B	b1
R 2053	CHIP RES.	2.2k	1/16W	5%	RMC1/16S 222JTH	J24189029		1-	B	b1
R 2054	CHIP RES.	6.8k	1/16W	5%	RMC1/16S 682JTH	J24189035		1-	B	b1
R 2055	CHIP RES.	220k	1/16W	5%	RMC1/16S 224JTH	J24189053		1-	B	b1
R 2056	CHIP RES.	1k	1/16W	5%	RMC1/16S 102JTH	J24189025		1-65	A	B1
R 2056	CHIP RES.	47	1/16W	5%	RMC1/16S 470JTH	J24189009		66-67	A	B1
R 2056	CHIP RES.	220	1/16W	5%	RMC1/16S 221JTH	J24189017		68-	A	B1
R 2057	CHIP RES.	1k	1/16W	5%	RMC1/16S 102JTH	J24189025		1-	B	a2
R 2058	CHIP RES.	1M	1/16W	5%	RMC1/16S 105JTH	J24189061		1-65	B	a2
R 2059	CHIP RES.	1k	1/16W	5%	RMC1/16S 102JTH	J24189025		1-	B	a2
R 2060	CHIP RES.	470	1/16W	5%	RMC1/16S 471JTH	J24189021		1-65	B	a1
R 2060	CHIP RES.	33k	1/16W	5%	RMC1/16S 333JTH	J24189043		66-	B	a1
R 2061	CHIP RES.	470	1/16W	5%	RMC1/16S 471JTH	J24189021		1-	B	a1
R 2062	CHIP RES.	470	1/16W	5%	RMC1/16S 471JTH	J24189021		1	B	a2
R 2062	CHIP RES.	270	1/16W	5%	RMC1/16S 271JTH	J24189018		2-	B	a2
R 2063	CHIP RES.	470	1/16W	5%	RMC1/16S 471JTH	J24189021		1-65	B	a1
R 2064	CHIP RES.	3.3k	1/16W	5%	RMC1/16S 332JTH	J24189031		1-	B	a2
R 2065	CHIP RES.	0	1/16W	5%	RMC1/16S JPTH	J24189070		1-65	B	a2
R 2067	CHIP RES.	10	1/16W	5%	RMC1/16S 100JTH	J24189001		1-11	A	B1
R 2067	CHIP RES.	100	1/16W	5%	RMC1/16S 101JTH	J24189013		12-67	A	B1
R 2067	CHIP RES.	10	1/16W	5%	RMC1/16S 100JTH	J24189001		68-	A	B1
R 2068	CHIP RES.	1k	1/16W	5%	RMC1/16S 102JTH	J24189025		1-	B	b1
R 2069	CHIP RES.	1k	1/16W	5%	RMC1/16S 102JTH	J24189025		1-	B	b1
R 2070	CHIP RES.	2.2k	1/16W	5%	RMC1/16S 222JTH	J24189029		1-	A	B1
R 2071	CHIP RES.	470	1/16W	5%	RMC1/16S 471JTH	J24189021		1-11	B	a1
R 2071	CHIP RES.	47	1/16W	5%	RMC1/16S 470JTH	J24189009		12-	B	a1
R 2073	CHIP RES.	47	1/16W	5%	RMC1/16S 470JTH	J24189009		1-	B	a2
R 2074	CHIP RES.	3.3k	1/16W	5%	RMC1/16S 332JTH	J24189031		1-	A	B1
R 2075	CHIP RES.	47k	1/16W	5%	RMC1/16S 473JTH	J24189045		1-	A	B1
R 2076	CHIP RES.	47k	1/16W	5%	RMC1/16S 473JTH	J24189045		1-	A	B1
R 2077	CHIP RES.	47k	1/16W	5%	RMC1/16S 473JTH	J24189045		1-	A	B1
R 2078	CHIP RES.	47	1/16W	5%	RMC1/16S 470JTH	J24189009		1-	A	A1
R 2079	CHIP RES.	10	1/16W	5%	RMC1/16S 100JTH	J24189001		1-	B	a1
R 2080	CHIP RES.	3.3k	1/16W	5%	RMC1/16S 332JTH	J24189031		1-	A	B1
R 2081	CHIP RES.	10	1/16W	5%	RMC1/16S 100JTH	J24189001		1-65	B	a2
R 2081	CHIP RES.	100	1/16W	5%	RMC1/16S 101JTH	J24189013		66-	B	a2
R 2082	CHIP RES.	100	1/16W	5%	RMC1/16S 101JTH	J24189013		1-	A	B1
R 2083	CHIP RES.	100	1/16W	5%	RMC1/16S 101JTH	J24189013		1-65	A	B2
R 2083	CHIP RES.	100k	1/16W	5%	RMC1/16S 104JTH	J24189049		66-	A	B2
R 2084	CHIP RES.	100	1/16W	5%	RMC1/16S 101JTH	J24189013		1-	B	a2
R 2085	CHIP RES.	100	1/16W	5%	RMC1/16S 101JTH	J24189013		1-	B	a2
R 2086	CHIP RES.	100	1/16W	5%	RMC1/16S 101JTH	J24189013		1-	B	a2
R 2087	CHIP RES.	100	1/16W	5%	RMC1/16S 101JTH	J24189013		1-65		
R 2088	CHIP RES.	47	1/16W	5%	RMC1/16S 470JTH	J24189009		12-65		
R 2089	CHIP RES.	100	1/16W	5%	RMC1/16S 101JTH	J24189013		12-65		
T 2001	COIL 05RF				CS-4N 5203-JPS-076	L0022507		1-85	A	A2
T 2001	COIL 05RF				CS-4N 5203-G001	L0023019		86-	A	A2
T 2002	COIL 05RF				CS-4N 5203-JPS-077	L0022508		1-85	A	A1
T 2002	COIL 05RF				CS-4N 5203-G002	L0023020		86-	A	A1
T 2003	COIL 05RF				CS-4N 5203-JPS-078	L0022509		1-85	A	A1

PLL Unit

Parts List

REF	DESCRIPTION	VALUE	V/W	TOL.	MFR'S DESIG	VXSTD P/N	VERS.	LOT	SIDE	LAY ADR
T 2003	COIL 05RF SHIELD CASE PLL SHIELD CASE COVER				CS-4N 5203-G003	L0023021 RA0271100 RA02712A0		86- 1- 1-	A	A1

PLL Unit

Note

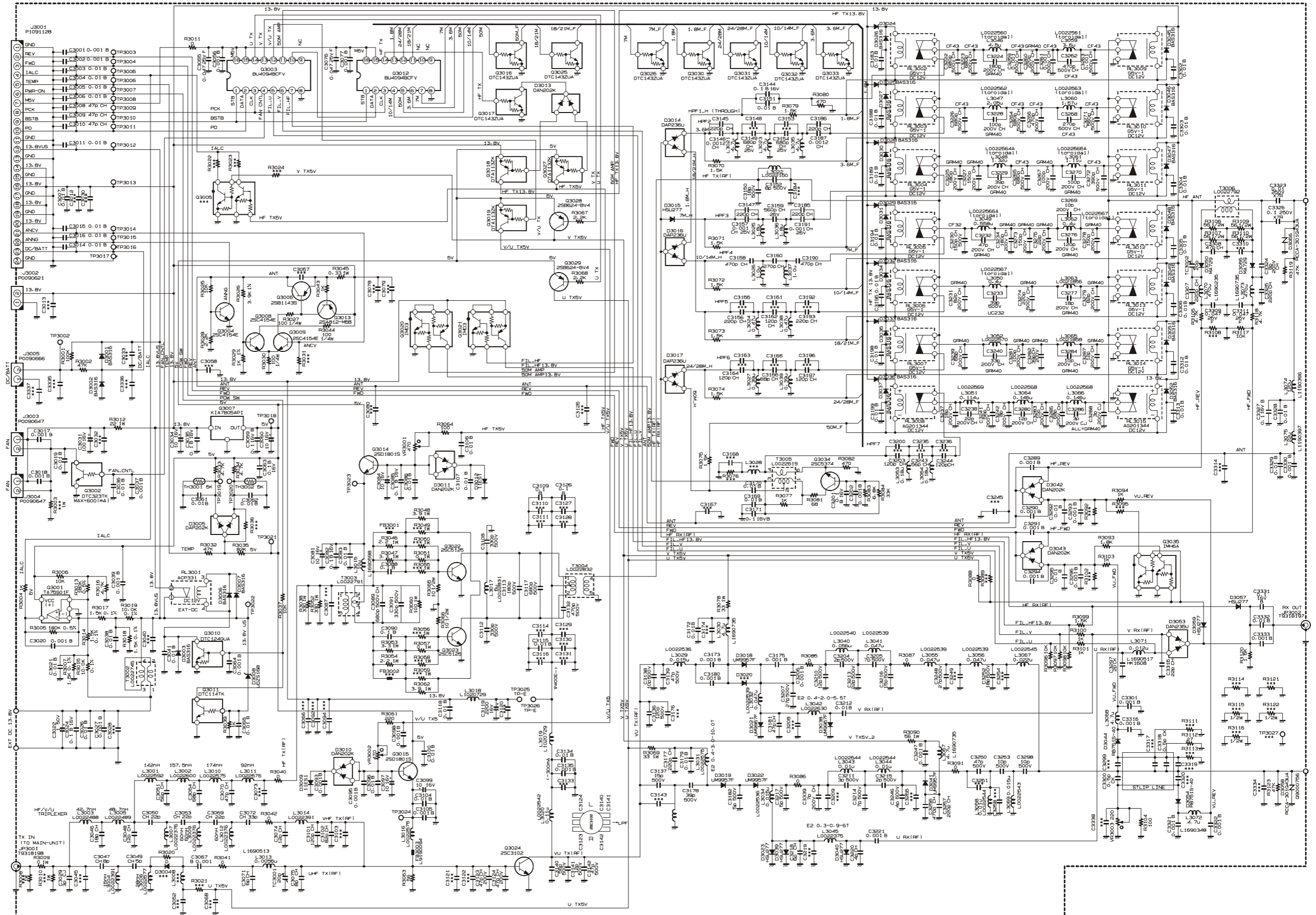

PA Unit (Lot 1 ~ 59)

Note:

PA Unit (Lot 1 ~ 59)

Parts Layout (Side B)

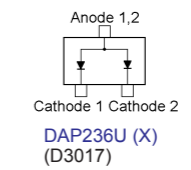
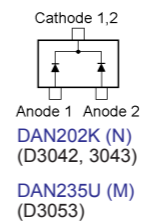
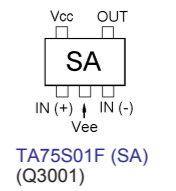
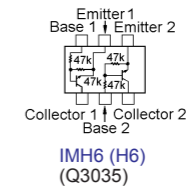
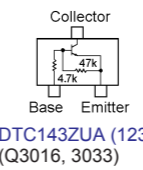
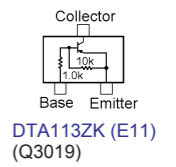
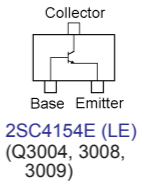
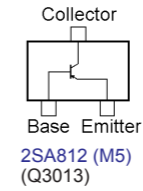
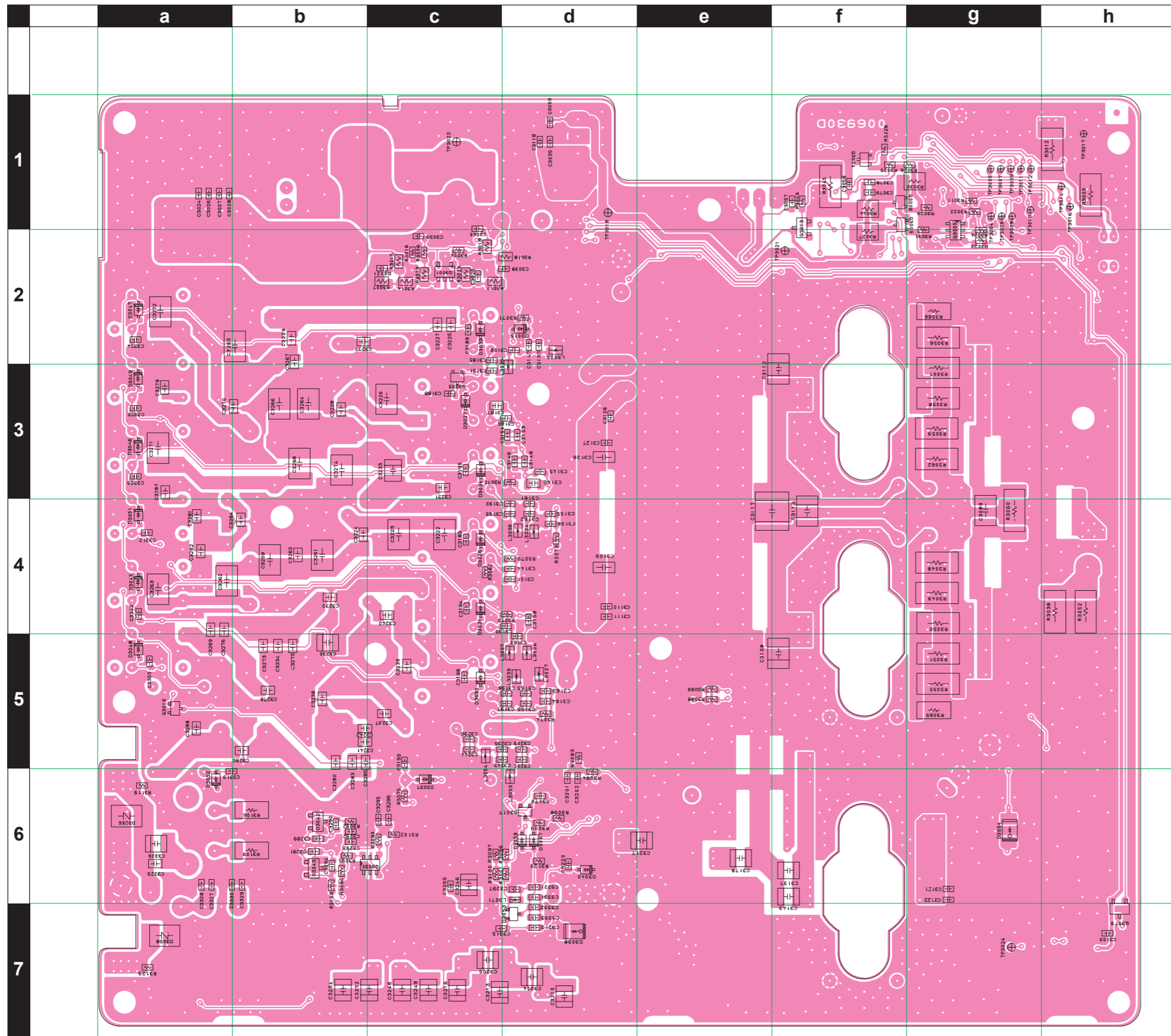

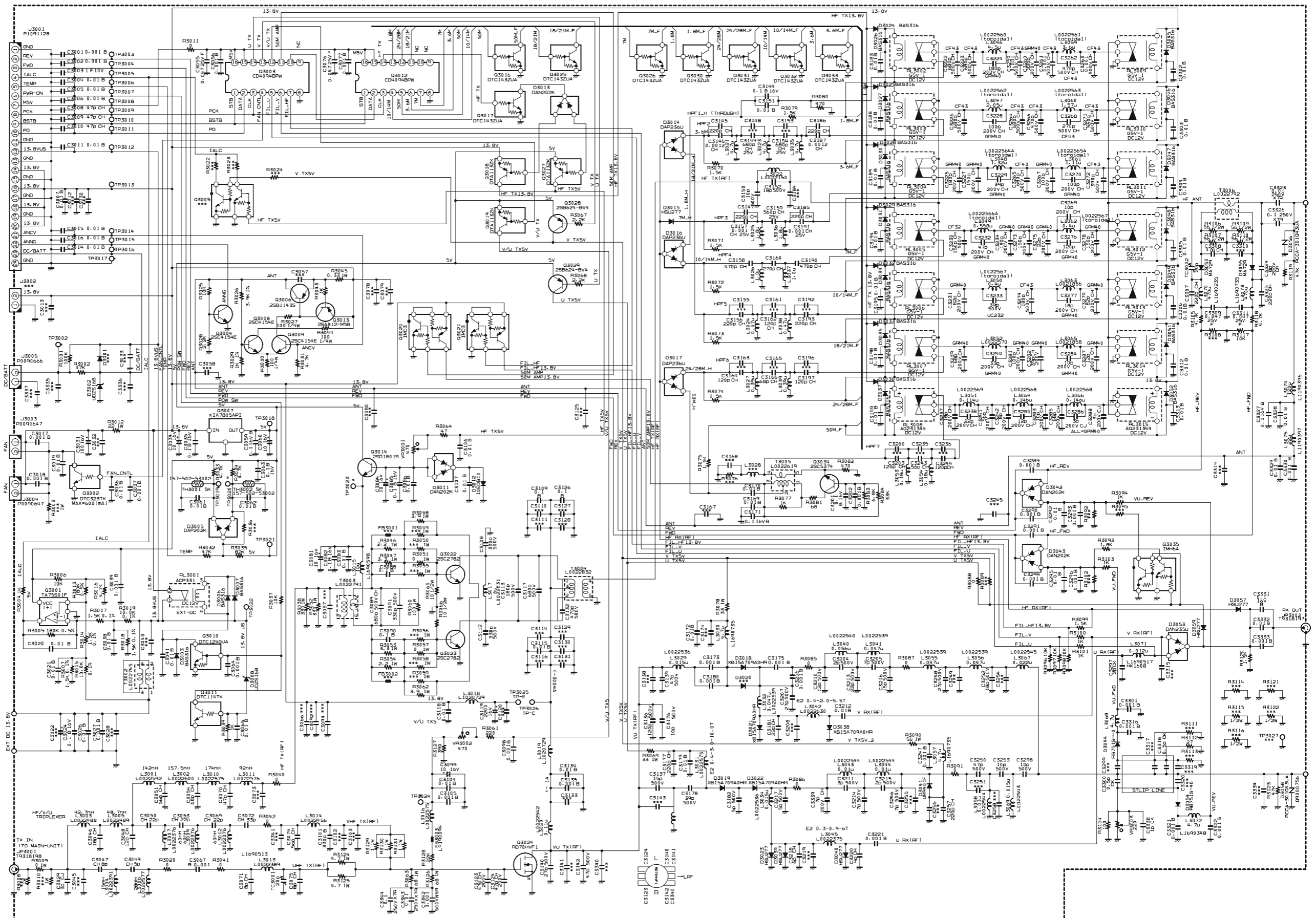

PA Unit (Lot 60 ~ 78)

Note:

PA Unit (Lot 60 ~ 78)

Parts Layout (Side B)

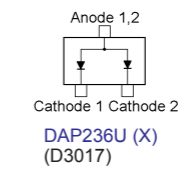
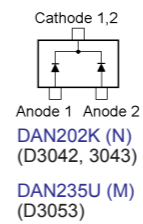
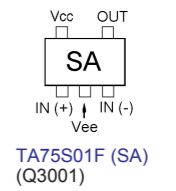
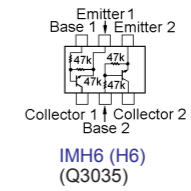
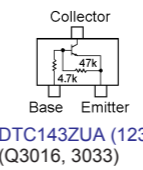
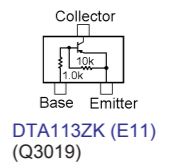
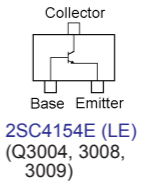
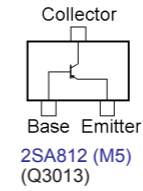
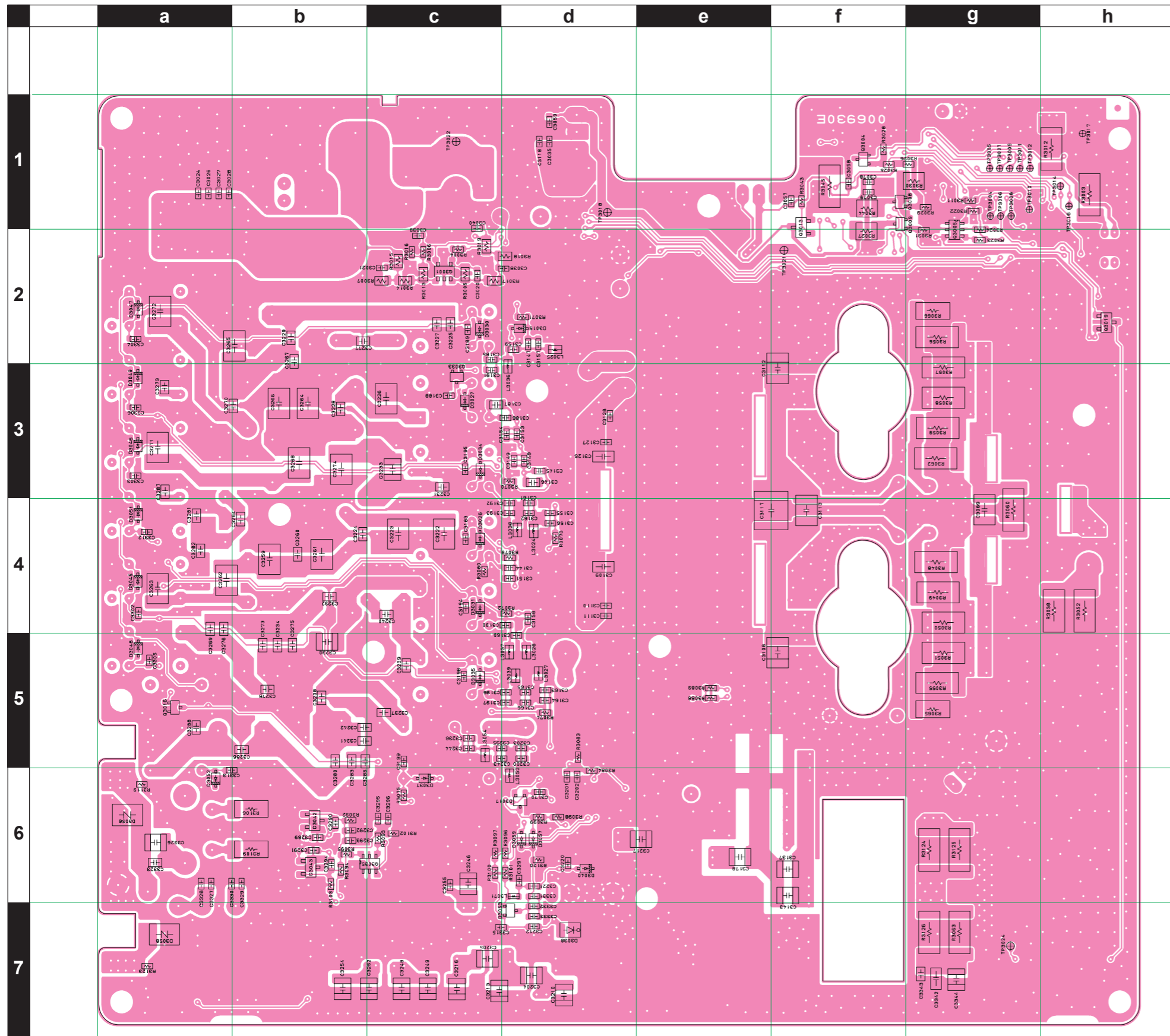

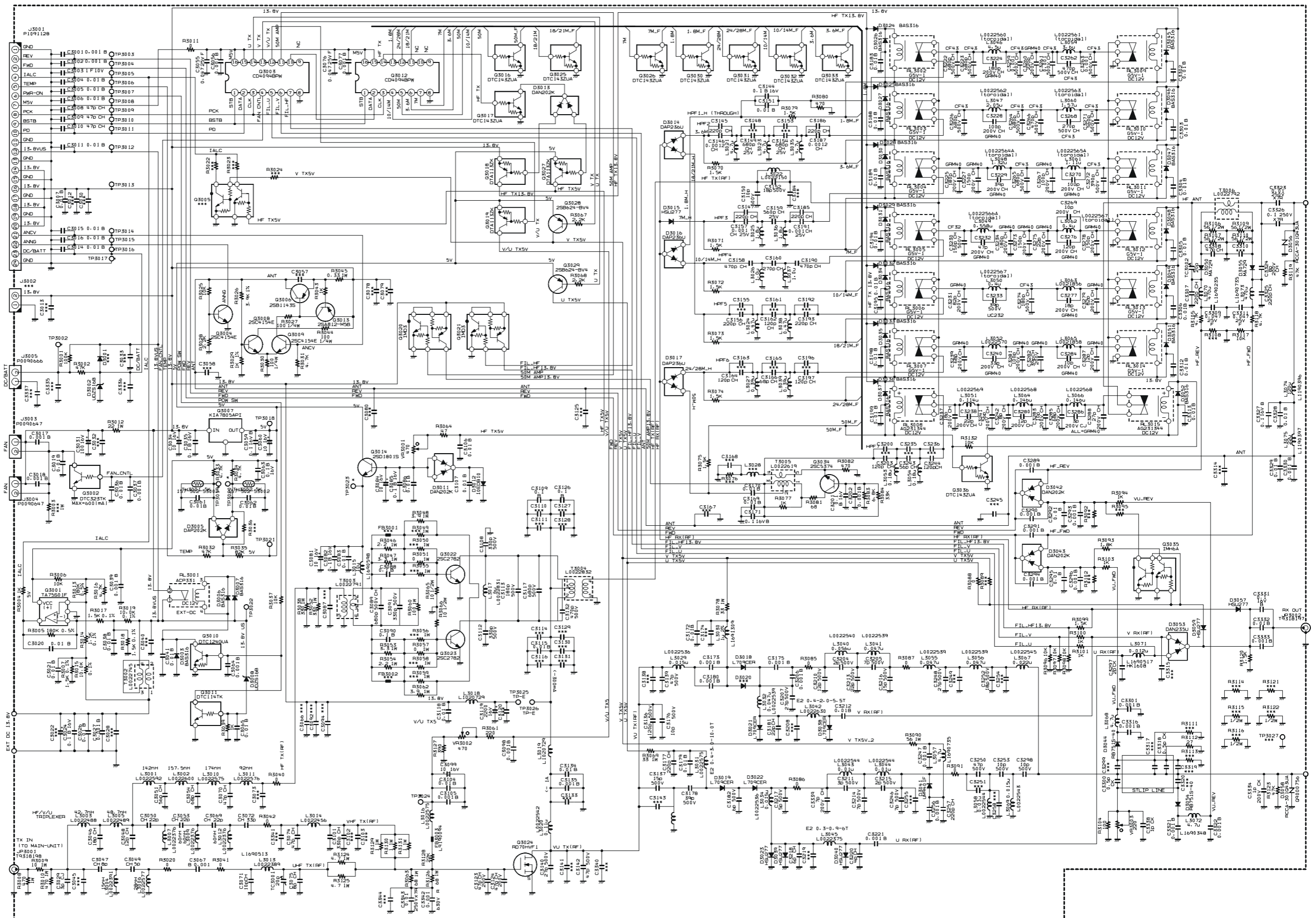

PA Unit (Lot 79 ~)

Note:

PA Unit (Lot 79 ~)

Parts Layout (Side B)

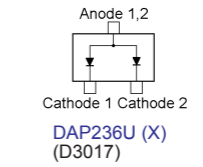
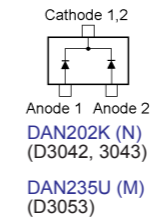
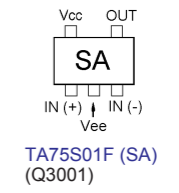
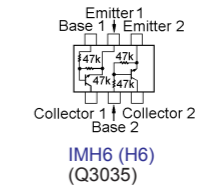
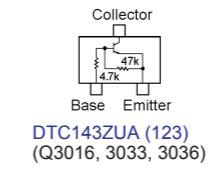
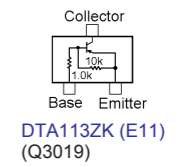
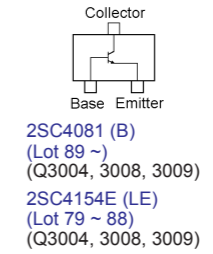
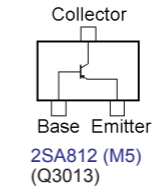
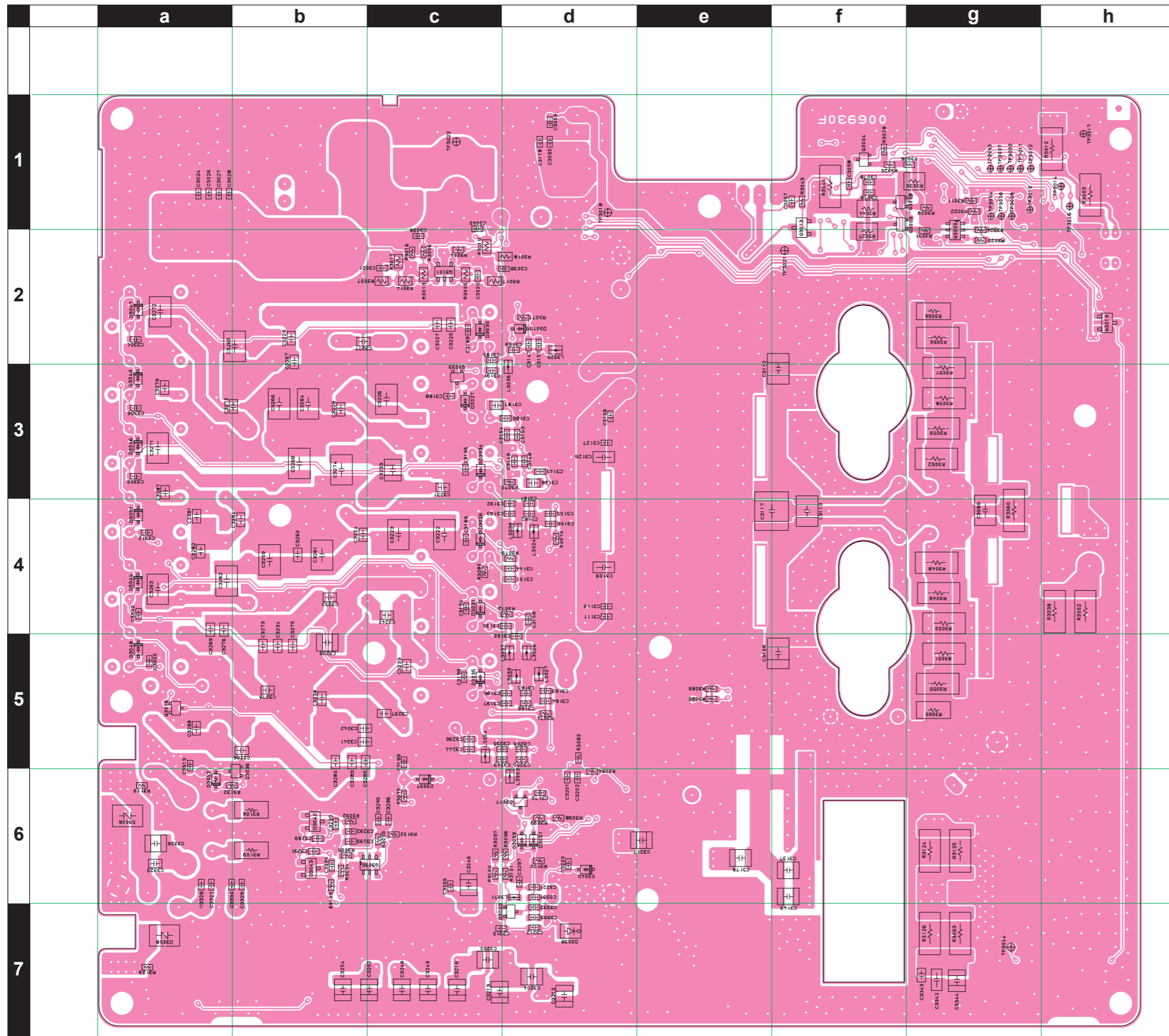

REF	DESCRIPTION	VALUE	V/W	TOL.	MFR'S DESIG	VXSTD P/N	VERS.	LOT	SIDE	LAY	ADR
PCB with Components						CS1851002*	VER. USA (Lot 1-59)				
						CS1851003*	VER. EXP (CE OFF: Lot 1-59)				
						CS1851004*	VER. AUS (CE OFF: Lot 1-59)				
						CS1851005*	VER. FRA (CE OFF: Lot 1-59)				
						CS1851006*	VER. EXP (CE ON: Lot 1-59)				
						CS1851007*	VER. FRA (CE ON: Lot 1-59)				
						CS1869002	VER. USA (Lot 60-)				
						CS1869003	VER. EXP (CE OFF: Lot 60-)				
						CS1869004	VER. AUS (CE OFF: Lot 60-)				
						CS1869005	VER. FRA (CE OFF: Lot 60-)				
						CS1869006	VER. EXP (CE ON: Lot 60-)				
						CS1869007	VER. FRA (CE ON: Lot 60-)				
						*: W/O Q3022/3023/3024					
Printed Circuit Board					AH007M000	FR006930D	1-59				
					AH007M000	FR006930E	60-78				
					AH007M000	FR006930F	79-				
C 3001	CHIP CAP.	0.001uF	50V	B	GRM188B11H102KA01D	K22174821		1-	A	B1	
C 3002	CHIP CAP.	0.001uF	50V	B	GRM188B11H102KA01D	K22174821		1-	A	B1	
C 3003	CHIP CAP.	1uF	10V	F	GRM188F11A105ZA01D	K22105001		1-	A	B1	
C 3004	CHIP CAP.	0.01uF	50V	B	GRM188B11H103KA01D	K22174823		1-	A	A1	
C 3005	CHIP CAP.	0.01uF	50V	B	GRM188B11H103KA01D	K22174823		1-	A	A1	
C 3006	CHIP CAP.	0.01uF	50V	B	GRM188B11H103KA01D	K22174823		1-	A	A1	
C 3007	CHIP CAP.	0.01uF	50V	B	GRM188B11H103KA01D	K22174823		1-	A	B1	
C 3008	CHIP CAP.	47pF	50V	CH	GRM1882C1H470JA01D	K22174227		1-	A	A1	
C 3009	CHIP CAP.	47pF	50V	CH	GRM1882C1H470JA01D	K22174227		1-	A	A1	
C 3010	CHIP CAP.	47pF	50V	CH	GRM1882C1H470JA01D	K22174227		1-	A	A1	
C 3011	CHIP CAP.	0.01uF	50V	B	GRM188B11H103KA01D	K22174823		1-	A	A1	
C 3014	CHIP CAP.	0.01uF	50V	B	GRM188B11H103KA01D	K22174823		1-	A	A1	
C 3015	CHIP CAP.	0.01uF	50V	B	GRM188B11H103KA01D	K22174823		1-	A	A1	
C 3016	CHIP CAP.	0.01uF	50V	B	GRM188B11H103KA01D	K22174823		1-	A	A1	
C 3017	CHIP CAP.	0.001uF	50V	B	GRM188B11H102KA01D	K22174821		1-	A	A1	
C 3018	CHIP CAP.	0.001uF	50V	B	GRM188B11H102KA01D	K22174821		1-	A	A1	
C 3019	CHIP CAP.	0.01uF	50V	B	GRM188B11H103KA01D	K22174823		1-	A	A1	
C 3020	CHIP CAP.	0.01uF	50V	B	GRM188B11H103KA01D	K22174823		1-	B	c2	
C 3021	CHIP CAP.	0.01uF	50V	B	GRM188B11H103KA01D	K22174823		1-	B	c2	
C 3022	AL.ELECTRO.CAP.	1uF	50V		ECEV1HA010SR	K48170019		1	A	G2	
C 3022	AL.ELECTRO.CAP.	1uF	50V		ECEV1HA010SR	K48170019	W/ CE	2-68	A	G2	
C 3022	AL.ELECTRO.CAP.	1uF	50V		EEE1HA010SR	K48170027	W/ CE	69-	A	G2	
C 3024	CHIP CAP.	0.1uF	16V	B	GRM188B11C104KA01D	K22124805		1-	B	a1	
C 3026	CHIP CAP.	0.01uF	50V	B	GRM188B11H103KA01D	K22174823		1-	B	a1	
C 3027	CHIP CAP.	0.001uF	50V	B	GRM188B11H102KA01D	K22174821		1-	B	a1	
C 3029	CHIP CAP.	3pF	50V	CJ	GRM1883C1H3R0CZ01D	K22174204		1-	A	A6	
C 3031	AL.ELECTRO.CAP.	100uF	16V		EEE1CA101WP	K48120012		1-	A	A2	
C 3034	AL.ELECTRO.CAP.	10uF	16V		RV2-16V100MB55U-R	K48120014		1-	A	E1	
C 3035	CHIP CAP.	0.1uF	16V	B	GRM188B11C104KA01D	K22124805		1-	B	d1	
C 3036	CHIP CAP.	0.01uF	50V	B	GRM188B11H103KA01D	K22174823		1-	A	A1	
C 3037	CHIP CAP.	0.001uF	50V	B	GRM188B11H102KA01D	K22174821		1-	A	A2	
C 3038	CHIP CAP.	0.01uF	50V	B	GRM188B11H103KA01D	K22174823		1-	B	d2	
C 3039	CHIP CAP.	0.001uF	50V	B	GRM188B11H102KA01D	K22174821		1-	B	c2	
C 3041	CHIP CAP.	0.01uF	50V	B	GRM188B11H103KA01D	K22174823		1-	A	E2	
C 3046	CHIP CAP.	18pF	50V	CH	GRM1882C1H180JA01D	K22174217		1-	A	A6	
C 3047	CHIP CAP.	8pF	50V	CH	GRM1882C1H8R0DZ01D	K22174209		1-	A	A6	
C 3048	CHIP CAP.	12pF	50V	CH	GRM1882C1H120JA01D	K22174213		1-	A	A6	
C 3049	CHIP CAP.	5pF	50V	CH	GRM1882C1H5R0CZ01D	K22174206		1-	A	A6	
C 3050	CHIP CAP.	22pF	50V	CH	GRM1882C1H220JA01D	K22174219		1-	A	A6	
C 3051	CHIP CAP.	56pF	50V	CH	GRM1882C1H560JA01D	K22174229		1-	A	A5	
C 3053	CHIP CAP.	22pF	50V	CH	GRM1882C1H220JA01D	K22174219		1-	A	A6	
C 3054	CHIP CAP.	68pF	50V	CH	GRM1882C1H680JA01D	K22174231		1-	A	A5	
C 3055	CHIP CAP.	0.047uF	25V	F	GRM39F473Z25PT	K22145002		1-82	A	C1	
C 3055	CHIP CAP.	0.047uF	50V	F	GRM188F11H473ZA01D	K22175001		83-	A	C1	
C 3056	CHIP CAP.	0.001uF	50V	B	GRM188B11H102KA01D	K22174821		1-	A	C1	
C 3059	CHIP CAP.	0.1uF	16V	B	GRM188B11C104KA01D	K22124805		1-	B	d1	
C 3060	AL.ELECTRO.CAP.	10uF	16V		RV2-16V100MB55U-R	K48120014		1-	A	E1	
C 3061	CHIP CAP.	0.01uF	50V	B	GRM188B11H103KA01D	K22174823		1-	A	C3	
C 3062	CHIP CAP.	0.01uF	50V	B	GRM188B11H103KA01D	K22174823		1-	A	C6	
C 3063	CHIP CAP.	0.1uF	16V	B	GRM188B11C104KA01D	K22124805		1-	A	A4	
C 3064	CHIP CAP.	0.001uF	50V	B	GRM188B11H102KA01D	K22174821		1-	A	E2	
C 3065	CHIP CAP.	0.01uF	50V	B	GRM188B11H103KA01D	K22174823		1-	A	E2	
C 3067	CHIP CAP.	0.001uF	50V	B	GRM188B11H102KA01D	K22174821		1-	A	B6	
C 3069	CHIP CAP.	22pF	50V	CH	GRM1882C1H220JA01D	K22174219		1-	A	A6	
C 3070	CHIP CAP.	47pF	50V	CH	GRM1882C1H470JA01D	K22174227		1-	A	A4	
C 3071	CHIP CAP.	6pF	50V	CH	GRM1882C1H6R0DZ01D	K22174207		1-59	A	B6	
C 3071	CHIP CAP.	10pF	50V	CH	GRM1882C1H100JA01D	K22174211		60-	A	B6	

PA Unit

Parts List

REF	DESCRIPTION	VALUE	V/W	TOL.	MFR'S DESIG	VXSTD P/N	VERS.	LOT	SIDE	LAY ADR
C 3072	CHIP CAP.	33pF	50V	CH	GRM1882C1H330JA01D	K22174223		1-	A	A6
C 3074	CHIP CAP.	12pF	50V	CH	GRM1882C1H120JA01D	K22174213		1-59	A	A6
C 3074	CHIP CAP.	47pF	50V	CH	GRM1882C1H470JA01D	K22174227		60-	A	A6
C 3075	CHIP CAP.	8pF	50V	CH	GRM1882C1H8R0DZ01D	K22174209		1-	A	B6
C 3076	CHIP CAP.	0.047uF	25V	F	GRM39F473Z25PT	K22145002		1-82	A	D2
C 3076	CHIP CAP.	0.047uF	50V	F	GRM188F11H473ZA01D	K22175001		83-	A	D2
C 3077	CHIP CAP.	0.001uF	50V	B	GRM188B11H102KA01D	K22174821		1-	A	D2
C 3081	AL.ELECTRO.CAP.	10uF	16V		RV2-16V100MB55U-R	K48120014		1-	A	A3
C 3082	CHIP CAP.	0.1uF	16V	B	GRM188B11C104KA01D	K22124805		1-	A	A3
C 3083	CHIP CAP.	0.01uF	50V	B	GRM188B11H103KA01D	K22174823		1-	A	A3
C 3084	AL.ELECTRO.CAP.	10uF	16V		RV2-16V100MB55U-R	K48120014		1-	A	A2
C 3085	CHIP CAP.	0.1uF	16V	B	GRM188B11C104KA01D	K22124805		1-	A	A2
C 3086	CHIP CAP.	0.01uF	50V	B	GRM188B11H103KA01D	K22174823		1-	A	A2
C 3088	CHIP CAP.	0.1uF	50V	B	GRM42-6B104K50PT	K22171820		1-	A	B4
C 3089	CHIP CAP.	680pF	500V	CH	CF43CH681J500AT	K22277218		1-	B	g4
C 3090	CHIP CAP.	0.1uF	50V	B	GRM42-6B104K50PT	K22171820		1-	A	B3
C 3091	FILM CAP.	330pF	500V		UC342H3300J-T	K33279014		1-		
C 3093	CHIP CAP.	0.001uF	50V	B	GRM188B11H102KA01D	K22174821		1-59		
C 3095	CHIP CAP.	0.001uF	50V	B	GRM188B11H102KA01D	K22174821		1-59		
C 3096	CHIP CAP.	0.01uF	50V	B	GRM188B11H103KA01D	K22174823		1-59		
C 3097	AL.ELECTRO.CAP.	10uF	16V		RV2-16V100MB55U-R	K48120014		1-59		
C 3098	CHIP CAP.	0.001uF	50V	B	GRM188B11H102KA01D	K22174821		1-	A	A7
C 3099	AL.ELECTRO.CAP.	10uF	16V		RV2-16V100MB55U-R	K48120014		1-	A	A7
C 3100	CHIP CAP.	0.01uF	50V	B	GRM188B11H103KA01D	K22174823		1-59		
C 3101	CHIP CAP.	120pF	50V	CH	GRM1882C1H121JA01D	K22174237		1-	A	A6
C 3101	CHIP CAP.	330pF	50V	CH	GRM1882C1H331JA01D	K22174253		60-	A	A6
C 3102	CHIP CAP.	82pF	50V	CH	GRM1882C1H820JA01D	K22174233		1-59	A	A6
C 3104	CHIP CAP.	0.01uF	50V	B	GRM188B11H103KA01D	K22174823		1-	A	A7
C 3105	CHIP CAP.	0.001uF	50V	B	GRM188B11H102KA01D	K22174821		1-	A	A7
C 3106	CHIP CAP.	0.01uF	50V	B	GRM188B11H103KA01D	K22174823		1-	A	A2
C 3107	CHIP CAP.	0.01uF	50V	B	GRM188B11H103KA01D	K22174823		1-	A	B5
C 3108	FILM CAP.	330pF	500V		UC342H3300J-T	K33279014		1-	B	f5
C 3109	CHIP CAP.	0.1uF	50V	B	GRM42-6B104K50PT	K22171820		1-	B	d4
C 3112	FILM CAP.	330pF	500V		UC342H3300J-T	K33279014		1-	B	f3
C 3113	FILM CAP.	180pF	500V		UC342H1800J-T	K33279039		1-	B	f4
C 3115	CHIP CAP.	0.01uF	50V	B	GRM188B11H103KA01D	K22174823		1-	A	E3
C 3117	FILM CAP.	680pF	500V		UC552H6800J-T	K33279042		1-	B	e4
C 3118	CHIP CAP.	0.01uF	50V	B	GRM188B11H103KA01D	K22174823		1-	B	d1
C 3119	AL.ELECTRO.CAP.	2200uF	16V		RE3-16V222MI5#	K40129064		1-	A	D2
C 3123	CHIP CAP.	47pF	200V	CH	GRM2192C2D470JV01D	K22230224		1-2	A	B7
C 3124	CHIP CAP.	47pF	200V	CH	GRM2192C2D470JV01D	K22230224		1-	A	B6
C 3126	CHIP CAP.	0.1uF	50V	B	GRM42-6B104K50PT	K22171820		1-	B	d3
C 3132	FILM CAP.	470pF	500V		UC342H4700J-T	K33279015		1-		
C 3133	CHIP CAP.	100pF	50V	CH	GRM1882C1H101JA01D	K22174235	W/ CE	3-	A	D5
C 3134	CHIP CAP.	0.01uF	50V	B	GRM188B11H103KA01D	K22174823		1-	A	C6
C 3135	CHIP CAP.	0.001uF	50V	B	GRM188B11H102KA01D	K22174821		1-	A	D6
C 3136	FILM CAP.	120pF	500V		UC342H1200J-T	K33279026		1-	A	D6
C 3137	FILM CAP.	15pF	500V		UC232H0150J-T	K33279028		1-	B	f6
C 3138	FILM CAP.	10pF	500V		UC232H0100D-T	K33279019		1-59	A	D7
C 3139	FILM CAP.	47pF	500V		UC232H0470J-T	K33279034		1-	A	D7
C 3140	FILM CAP.	56pF	500V		UC232H0560J-T	K33279035		1-59	A	C6
C 3140	FILM CAP.	27pF	500V		UC232H0270J-T	K33279023		60-	A	C6
C 3141	FILM CAP.	12pF	500V		UC232H0120J-T	K33279020		1-59	A	C6
C 3142	FILM CAP.	47pF	500V		UC232H0470J-T	K33279034		1-	A	C7
C 3144	CHIP CAP.	0.1uF	16V	B	GRM188B11C104KA01D	K22124805		1-	B	d4
C 3145	CHIP CAP.	220pF	50V	CH	GRM1882C1H221JA01D	K22174243		1-	B	d3
C 3146	CHIP CAP.	0.0012uF	50V	CH	GRM40CH122J50PT	K22170290		1-	B	d3
C 3147	CHIP CAP.	220pF	50V	CH	GRM1882C1H221JA01D	K22174243		1-	B	d2
C 3149	CHIP CAP.	680pF	25V	CH	GRM39CH681J25PT	K22144203		1-82	B	d3
C 3149	CHIP CAP.	680pF	50V	CH	GRM1882C1H681JA01D	K22174274		83-	B	d3
C 3150	FILM CAP.	18pF	500V		UC232H0180J-T	K33279029		1-50	A	E5
C 3150	FILM CAP.	10pF	500V		UC232H0100D-T	K33279019		53-	A	E5
C 3151	CHIP CAP.	0.01uF	50V	B	GRM188B11H103KA01D	K22174823		1-	B	d4
C 3152	FILM CAP.	8pF	500V		UC232H0080D-T	K33279005		1-4	A	E5
C 3152	FILM CAP.	18pF	500V		UC232H0180J-T	K33279029		5-	A	E5
C 3154	CHIP CAP.	680pF	25V	CH	GRM39CH681J25PT	K22144203		1-82	B	d3
C 3154	CHIP CAP.	680pF	50V	CH	GRM1882C1H681JA01D	K22174274		83-	B	d3
C 3156	CHIP CAP.	220pF	50V	CH	GRM1882C1H221JA01D	K22174243		1-	B	d4
C 3157	CHIP CAP.	0.001uF	25V	CH	GRM1882C1E102JA01D	K22144204		1-	B	d2
C 3158	CHIP CAP.	470pF	50V	CH	GRM1882C1H471JA01D	K22174249		1-	B	d4
C 3159	CHIP CAP.	560pF	25V	CH	GRM39CH561J25PT	K22144201		1-82	B	d2
C 3159	CHIP CAP.	560pF	50V	CH	GRM1882C1H561JA01D	K22174273		83-	B	d2
C 3160	CHIP CAP.	270pF	50V	CH	GRM1882C1H271JA01D	K22174251		1-	B	d5

REF	DESCRIPTION	VALUE	V/W	TOL.	MFR'S DESIG	VXSTD P/N	VERS.	LOT	SIDE	LAY ADR
C 3162	CHIP CAP.	120pF	50V	CH	GRM1882C1H121JA01D	K22174237		1-	B	d4
C 3164	CHIP CAP.	120pF	50V	CH	GRM1882C1H121JA01D	K22174237		1-	B	d5
C 3166	CHIP CAP.	68pF	50V	CH	GRM1882C1H680JA01D	K22174231		1-	B	d5
C 3169	CHIP CAP.	0.01uF	50V	B	GRM188B11H103KA01D	K22174823		1-	A	E6
C 3170	CHIP CAP.	0.01uF	50V	B	GRM188B11H103KA01D	K22174823		1-	B	d6
C 3171	CHIP CAP.	0.1uF	16V	B	GRM188B11C104KA01D	K22124805		1-	A	E6
C 3172	CHIP CAP.	0.01uF	50V	B	GRM188B11H103KA01D	K22174823		1-	A	D6
C 3173	CHIP CAP.	0.001uF	50V	B	GRM188B11H102KA01D	K22174821		1-	A	D7
C 3175	CHIP CAP.	0.001uF	50V	B	GRM188B11H102KA01D	K22174821		1-	A	E7
C 3176	FILM CAP.	10pF	500V		UC232H0100D-T	K33279019		60-	A	D7
C 3177	CHIP CAP.	220pF	50V	CH	GRM1882C1H221JA01D	K22174243		1-	A	D6
C 3178	FILM CAP.	39pF	500V		UC232H0390J-T	K33279038		1-	B	e6
C 3179	CHIP CAP.	0.01uF	50V	B	GRM188B11H103KA01D	K22174823		1-	A	D6
C 3180	CHIP CAP.	0.001uF	50V	B	GRM188B11H102KA01D	K22174821		1-	A	D7
C 3181	CHIP CAP.	22pF	50V	CH	GRM1882C1H220JA01D	K22174219		1-	A	E7
C 3182	FILM CAP.	5pF	500V		UC232H0050D-T	K33279010		1-63	A	D6
C 3182	FILM CAP.	6pF	500V		UC232H0060D-T	K33279045		64-	A	D6
C 3183	CHIP CAP.	0.01uF	50V	B	GRM188B11H103KA01D	K22174823		1-	B	c4
C 3185	CHIP CAP.	220pF	50V	CH	GRM1882C1H221JA01D	K22174243		1-	B	c2
C 3186	CHIP CAP.	220pF	50V	CH	GRM1882C1H221JA01D	K22174243		1-	B	d3
C 3187	CHIP CAP.	0.0012uF	50V	CH	GRM40CH122J50PT	K22170290		1-	B	c3
C 3188	CHIP CAP.	0.01uF	50V	B	GRM188B11H103KA01D	K22174823		1-	B	c3
C 3189	CHIP CAP.	0.01uF	50V	B	GRM188B11H103KA01D	K22174823		1-	B	c2
C 3190	CHIP CAP.	470pF	50V	CH	GRM1882C1H471JA01D	K22174249		1-	B	d4
C 3191	CHIP CAP.	0.001uF	25V	CH	GRM1882C1E102JA01D	K22144204		1-	B	c3
C 3193	CHIP CAP.	220pF	50V	CH	GRM1882C1H221JA01D	K22174243		1-	B	d4
C 3194	CHIP CAP.	0.01uF	50V	B	GRM188B11H103KA01D	K22174823		1-	B	c4
C 3195	CHIP CAP.	0.01uF	50V	B	GRM188B11H103KA01D	K22174823		1-	B	c3
C 3197	CHIP CAP.	120pF	50V	CH	GRM1882C1H121JA01D	K22174237		1-	B	d5
C 3198	CHIP CAP.	0.01uF	50V	B	GRM188B11H103KA01D	K22174823		1-	B	c5
C 3199	CHIP CAP.	0.01uF	50V	B	GRM188B11H103KA01D	K22174823		1-	B	c5
C 3201	CHIP CAP.	0.1uF	16V	B	GRM188B11C104KA01D	K22124805		1-	B	d6
C 3202	CHIP CAP.	0.001uF	50V	B	GRM188B11H102KA01D	K22174821		1-	B	d6
C 3203	CHIP CAP.	120pF	50V	CH	GRM1882C1H121JA01D	K22174237		1-	B	d5
C 3204	FILM CAP.	2pF	500V		UC232H0020D-T	K33279043		1-	B	d7
C 3205	FILM CAP.	7pF	500V		UC232H0070D-T	K33279046		1-	B	c7
C 3206	CHIP CAP.	0.001uF	50V	B	GRM188B11H102KA01D	K22174821		1-	A	E7
C 3207	FILM CAP.	27pF	500V		UC232H0270J-T	K33279023		1-	A	D7
C 3210	FILM CAP.	12pF	500V		UC232H0120J-T	K33279020		1-	B	d7
C 3211	FILM CAP.	3pF	500V		UC232H0030D-T	K33279027		1-	A	E6
C 3212	CHIP CAP.	0.01uF	50V	B	GRM188B11H103KA01D	K22174823		1-	B	d7
C 3213	FILM CAP.	22pF	500V		UC232H0220J-T	K33279021		1-	B	c7
C 3214	FILM CAP.	7pF	500V		UC232H0070D-T	K33279046		1-	A	E6
C 3215	FILM CAP.	2pF	500V		UC232H0020D-T	K33279043		1-	A	F6
C 3216	FILM CAP.	15pF	500V		UC232H0150J-T	K33279028		1-	B	c7
C 3217	FILM CAP.	5pF	500V		UC232H0050D-T	K33279010		1-	B	e6
C 3218	CHIP CAP.	6pF	50V	CH	GRM1882C1H6R0DZ01D	K22174207		1-	A	E6
C 3220	CHIP CAP.	4pF	50V	CH	GRM1882C1H4R0CZ01D	K22174205		1-	B	d6
C 3221	CHIP CAP.	0.001uF	50V	B	GRM188B11H102KA01D	K22174821		1-	B	d6
C 3222	CHIP CAP.	680pF	500V	CH	CF43CH681J500AT	K22277218		1-	B	c4
C 3223	CHIP CAP.	680pF	500V	CH	CF43CH681J500AT	K22277218		1-	B	c4
C 3224	CHIP CAP.	180pF	200V	CH	GRM21B2C2D181JY21L	K22230231		1-	B	b4
C 3225	CHIP CAP.	180pF	200V	CH	GRM21B2C2D181JY21L	K22230231		1-	B	c2
C 3226	CHIP CAP.	680pF	500V	CH	CF43CH681J500AT	K22277218		1-	B	c3
C 3227	CHIP CAP.	150pF	200V	CH	GRM21B2C2D151JV01L	K22230230		1-	B	c2
C 3228	CHIP CAP.	100pF	200V	CH	GRM21B2C2D101JV01L	K22230228		1-	B	b3
C 3229	CHIP CAP.	39pF	200V	CH	GRM2192C2D390JV01D	K22230223		1-	B	b2
C 3230	CHIP CAP.	150pF	500V	CH	CF32CH151J500AT	K22275249		1-	B	b5
C 3231	CHIP CAP.	82pF	200V	CH	GRM21B2C2D820JV01L	K22230227		1-	B	c3
C 3232	CHIP CAP.	47pF	200V	CH	GRM2192C2D470JV01D	K22230224		1-	B	b4
C 3233	FILM CAP.	39pF	500V		UC232H0390J-T	K33279038		1-2	B	c3
C 3233	FILM CAP.	33pF	500V		UC232H0330J-T	K33279024	W/ CE	3-	B	c3
C 3233	FILM CAP.	39pF	500V		UC232H0390J-T	K33279038	W/O CE	3-	B	c3
C 3234	CHIP CAP.	180pF	200V	CH	GRM21B2C2D181JY21L	K22230231		1-	B	b5
C 3237	CHIP CAP.	18pF	200V	CH	GRM2192C2D180JV01D	K22230219		1-	B	c5
C 3238	CHIP CAP.	22pF	200V	CH	GRM2192C2D220JV01D	K22230220		1-	B	b5
C 3239	CHIP CAP.	68pF	200V	CH	GRM21B2C2D680JV01L	K22230226		1-	B	c5
C 3240	CHIP CAP.	33pF	200V	CH	GRM2192C2D330JV01D	K22230222		1-	B	c4
C 3241	CHIP CAP.	56pF	200V	CH	GRM2192C2D560JV01D	K22230225		1-	B	b5
C 3242	CHIP CAP.	8pF	200V	CH	GRM2192C2D8R0DY21D	K22230214		1-	B	b5
C 3243	CHIP CAP.	56pF	50V	CH	GRM1882C1H560JA01D	K22174229		1-	B	c5
C 3244	CHIP CAP.	120pF	50V	CH	GRM1882C1H121JA01D	K22174237		1-	B	c5
C 3246	FILM CAP.	7pF	500V		UC232H0070D-T	K33279046		1-3	B	c6

PA Unit

Parts List

REF	DESCRIPTION	VALUE	V/W	TOL.	MFR'S DESIG	VXSTD P/N	VERS.	LOT	SIDE	LAY ADR
C 3246	FILM CAP.	10pF	500V		UC232H0100D-T	K33279019		4	B	c6
C 3246	FILM CAP.	7pF	500V		UC232H0070D-T	K33279046		5-17	B	c6
C 3246	FILM CAP.	10pF	500V		UC232H0100D-T	K33279019		18-22	B	c6
C 3246	FILM CAP.	7pF	500V		UC232H0070D-T	K33279046		23-	B	c6
C 3247	CHIP CAP.	0.001uF	50V	B	GRM188B11H102KA01D	K22174821		1-	A	E6
C 3248	FILM CAP.	27pF	500V		UC232H0270J-T	K33279023		1-	B	c7
C 3250	FILM CAP.	47pF	500V		UC232H0470J-T	K33279034		1-	A	F6
C 3252	FILM CAP.	18pF	500V		UC232H0180J-T	K33279029		1-	B	c7
C 3253	FILM CAP.	10pF	500V		UC232H0100D-T	K33279019		1-	A	F7
C 3256	CHIP CAP.	0.001uF	50V	B	GRM188B11H102KA01D	K22174821		64-	A	E7
C 3257	CHIP CAP.	220pF	50V	CH	GRM1882C1H221JA01D	K22174243		1-	A	E7
C 3259	CHIP CAP.	0.001uF	500V	CH	CF43CH102J500AT	K22277222		1-	B	b4
C 3260	CHIP CAP.	220pF	200V	CH	GRM21B2C2D221JY21L	K22230232		1-	B	b4
C 3261	CHIP CAP.	0.001uF	500V	CH	CF43CH102J500AT	K22277222		1-	B	b4
C 3262	CHIP CAP.	470pF	500V	CH	CF43CH471J500AT	K22277214		1-	B	a4
C 3263	CHIP CAP.	0.001uF	500V	CH	CF43CH102J500AT	K22277222		1-	B	a4
C 3264	CHIP CAP.	680pF	500V	CH	CF43CH681J500AT	K22277218		1-	B	b3
C 3265	CHIP CAP.	680pF	500V	CH	CF43CH681J500AT	K22277218		1-	B	b2
C 3266	CHIP CAP.	470pF	500V	CH	CF43CH471J500AT	K22277214		1-	B	b3
C 3267	CHIP CAP.	100pF	200V	CH	GRM21B2C2D101JV01L	K22230228		1-	B	b2
C 3268	CHIP CAP.	270pF	500V	CH	CF43CH271J500AT	K22277208		1-	B	b3
C 3269	CHIP CAP.	10pF	200V	CH	GRM2192C2D100JV01D	K22230216		1-	B	a4
C 3270	CHIP CAP.	100pF	200V	CH	GRM21B2C2D101JV01L	K22230228		1-	B	a3
C 3271	CHIP CAP.	560pF	500V	CH	CF43CH561J500AT	K22277216		1-	B	a3
C 3272	CHIP CAP.	390pF	500V	CH	CF43CH391J500AT	K22277212		1-	B	a2
C 3273	CHIP CAP.	150pF	200V	CH	GRM21B2C2D151JV01L	K22230230		1-	B	b5
C 3274	CHIP CAP.	220pF	500V	CH	CF43CH221J500AT	K22277206		1-11	B	b3
C 3274	CHIP CAP.	180pF	500V	CH	CF43CH181J500AT	K22277204		12-	B	b3
C 3275	CHIP CAP.	22pF	200V	CH	GRM2192C2D220JV01D	K22230220		1-	B	b5
C 3276	CHIP CAP.	120pF	200V	CH	GRM21B2C2D121JV01L	K22230229		1-	B	a4
C 3277	CHIP CAP.	22pF	200V	CH	GRM2192C2D220JV01D	K22230220	W/ CE	1-	B	b2
C 3277	CHIP CAP.	18pF	200V	CH	GRM2192C2D180JV01D	K22230219	W/O CE	1-	B	b2
C 3278	CHIP CAP.	150pF	200V	CH	GRM21B2C2D151JV01L	K22230230		1-	B	b5
C 3279	CHIP CAP.	82pF	200V	CH	GRM21B2C2D820JV01L	K22230227		1-	B	a3
C 3280	CHIP CAP.	12pF	200V	CH	GRM2192C2D120JV01D	K22230217		1-	B	b5
C 3281	CHIP CAP.	100pF	200V	CH	GRM21B2C2D101JV01L	K22230228		1-	B	a4
C 3282	CHIP CAP.	39pF	200V	CH	GRM2192C2D390JV01D	K22230223		1-	B	a4
C 3283	CHIP CAP.	10pF	200V	CH	GRM2192C2D100JV01D	K22230216		1-	B	b5
C 3284	CHIP CAP.	10pF	200V	CH	GRM2192C2D100JV01D	K22230216		1-	B	b4
C 3285	CHIP CAP.	68pF	200V	CH	GRM21B2C2D680JV01D	K22230226		1-	B	b5
C 3286	CHIP CAP.	3pF	200V	CJ	GRM2193C2D3R0CY21D	K22230210		1-	B	b5
C 3287	CHIP CAP.	12pF	200V	CH	GRM2192C2D120JV01D	K22230217		1-	B	a3
C 3288	CHIP CAP.	3pF	200V	CJ	GRM2193C2D3R0CY21D	K22230210		1-76	B	a5
C 3288	CHIP CAP.	3pF	200V	CJ	GRM2193C2D3R0CY21D	K22230210	VER. A2 EXP	77-78	B	a5
C 3288	CHIP CAP.	27pF	200V	CH	GRM2192C2D270JV01D	K22230221	VER. FH	77-78	B	a5
C 3288	CHIP CAP.	3pF	200V	CJ	GRM2193C2D3R0CY21D	K22230210	VER. A1	77-78	B	a5
C 3288	CHIP CAP.	3pF	200V	CJ	GRM2193C2D3R0CY21D	K22230210	VER. A2	77-78	B	a5
C 3288	CHIP CAP.	3pF	200V	CJ	GRM2193C2D3R0CY21D	K22230210	VER. A3	77-78	B	a5
C 3288	CHIP CAP.	3pF	200V	CJ	GRM2193C2D3R0CY21D	K22230210	VER. B1	77-78	B	a5
C 3288	CHIP CAP.	3pF	200V	CJ	GRM2193C2D3R0CY21D	K22230210	VER. B2	77-78	B	a5
C 3288	CHIP CAP.	3pF	200V	CJ	GRM2193C2D3R0CY21D	K22230210	VER. B3	77-78	B	a5
C 3288	CHIP CAP.	3pF	200V	CJ	GRM2193C2D3R0CY21D	K22230210	VER. C1	77-78	B	a5
C 3288	CHIP CAP.	3pF	200V	CJ	GRM2193C2D3R0CY21D	K22230210	VER. C2	77-78	B	a5
C 3288	CHIP CAP.	3pF	200V	CJ	GRM2193C2D3R0CY21D	K22230210	VER. C3	77-78	B	a5
C 3288	CHIP CAP.	3pF	200V	CJ	GRM2193C2D3R0CY21D	K22230210	VER. D1	77-78	B	a5
C 3288	CHIP CAP.	3pF	200V	CJ	GRM2193C2D3R0CY21D	K22230210	VER. D2	77-78	B	a5
C 3288	CHIP CAP.	3pF	200V	CJ	GRM2193C2D3R0CY21D	K22230210	VER. E1	77-78	B	a5
C 3288	CHIP CAP.	3pF	200V	CJ	GRM2193C2D3R0CY21D	K22230210	VER. E2	77-78	B	a5
C 3288	CHIP CAP.	3pF	200V	CJ	GRM2193C2D3R0CY21D	K22230210	VER. E3	77-78	B	a5
C 3288	CHIP CAP.	3pF	200V	CJ	GRM2193C2D3R0CY21D	K22230210	VER. F	77-78	B	a5
C 3288	CHIP CAP.	3pF	200V	CJ	GRM2193C2D3R0CY21D	K22230210	VER. FM	77-78	B	a5
C 3288	CHIP CAP.	3pF	200V	CJ	GRM2193C2D3R0CY21D	K22230210	VER. H1	77-78	B	a5
C 3288	CHIP CAP.	3pF	200V	CJ	GRM2193C2D3R0CY21D	K22230210	VER. H2	77-78	B	a5
C 3288	CHIP CAP.	27pF	200V	CH	GRM2192C2D270JV01D	K22230221		79-	B	a5
C 3289	CHIP CAP.	0.001uF	50V	B	GRM188B11H102KA01D	K22174821		1-	B	b6
C 3290	CHIP CAP.	0.001uF	50V	B	GRM188B11H102KA01D	K22174821		1-	B	b6
C 3291	CHIP CAP.	0.001uF	50V	B	GRM188B11H102KA01D	K22174821		1-	B	b6
C 3292	CHIP CAP.	0.01uF	50V	B	GRM188B11H103KA01D	K22174823		1-	B	b6
C 3293	CHIP CAP.	0.001uF	50V	B	GRM188B11H102KA01D	K22174821		1-	B	b6
C 3294	CHIP CAP.	0.001uF	50V	B	GRM188B11H102KA01D	K22174821		1-	B	b6
C 3295	CHIP CAP.	0.01uF	50V	B	GRM188B11H103KA01D	K22174823		1-	B	c6
C 3296	CHIP CAP.	0.001uF	50V	B	GRM188B11H102KA01D	K22174821		1-	B	c6
C 3297	CHIP CAP.	2pF	50V	CK	GRM1884C1H2R0CZ01D	K22174203		1-	B	d6

REF	DESCRIPTION	VALUE	V/W	TOL.	MFR'S DESIG	VXSTD P/N	VERS.	LOT	SIDE	LAY ADR
C 3298	FILM CAP.	10pF	500V		UC232H0100D-T	K33279019		1-	A	F7
C 3300	CHIP CAP.	0.5pF	50V	CK	GRM1884C1HR50CZ01D	K22174201		1	A	G7
C 3300	CHIP CAP.	0.5pF	50V	CK	GRM1884C1HR50BZ01D	K22174265		2-	A	G7
C 3301	CHIP CAP.	0.001uF	50V	B	GRM188B11H102KA01D	K22174821		1-	A	G7
C 3302	CHIP CAP.	0.01uF	50V	B	GRM188B11H103KA01D	K22174823		1-	B	a4
C 3303	CHIP CAP.	0.01uF	50V	B	GRM188B11H103KA01D	K22174823		1-	B	a3
C 3304	CHIP CAP.	0.01uF	50V	B	GRM188B11H103KA01D	K22174823		1-	B	a2
C 3305	CHIP CAP.	0.01uF	50V	B	GRM188B11H103KA01D	K22174823		1-	B	a5
C 3306	CHIP CAP.	0.01uF	50V	B	GRM188B11H103KA01D	K22174823		1-	B	a3
C 3307	CHIP CAP.	220pF	50V	CH	GRM1882C1H221JA01D	K22174243		1-	A	G6
C 3308	CHIP CAP.	47pF	50V	CH	GRM1882C1H470JA01D	K22174227		1-	A	G6
C 3309	CHIP CAP.	0.047uF	25V	F	GRM39F473Z25PT	K22145002		1-82	A	G6
C 3309	CHIP CAP.	0.047uF	50V	F	GRM188F11H473ZA01D	K22175001		83-	A	G6
C 3311	CHIP CAP.	0.047uF	25V	F	GRM39F473Z25PT	K22145002		1-82	A	G6
C 3311	CHIP CAP.	0.047uF	50V	F	GRM188F11H473ZA01D	K22175001		83-	A	G6
C 3312	CHIP CAP.	0.01uF	50V	B	GRM188B11H103KA01D	K22174823		1-	B	a4
C 3313	CHIP CAP.	0.01uF	50V	B	GRM188B11H103KA01D	K22174823		1-	B	a5
C 3316	CHIP CAP.	0.001uF	50V	B	GRM188B11H102KA01D	K22174821		1-	A	G7
C 3318	CHIP CAP.	0.5pF	50V	CK	GRM1884C1HR50CZ01D	K22174201		1	A	G7
C 3318	CHIP CAP.	0.5pF	50V	CK	GRM1884C1HR50BZ01D	K22174265		2-	A	G7
C 3321	CHIP CAP.	0.001uF	50V	B	GRM188B11H102KA01D	K22174821		1-	A	H7
C 3322	CHIP CAP.	0.001uF	50V	B	GRM188B11H102KA01D	K22174821		1-	A	G7
C 3323	CHIP CAP.	0.01uF	250V	X7R	GRM21BR72E103KW03L	K22240801		1-	B	a6
C 3324	CHIP CAP.	8pF	200V	CH	GRM2192C2D8R0DY21D	K22230214		1-	A	G6
C 3325	CHIP CAP.	220pF	50V	CH	GRM1882C1H221JA01D	K22174243		1-	A	G6
C 3326	CHIP CAP.	0.1uF	250V	X7R	GRM32DR72E104KW01L	K22245801		1-	B	a6
C 3327	CHIP CAP.	0.1uF	16V	B	GRM188B11C104KA01D	K22124805		1-	B	a6
C 3328	CHIP CAP.	0.01uF	50V	B	GRM188B11H103KA01D	K22174823		1-	B	a6
C 3329	CHIP CAP.	0.01uF	50V	B	GRM188B11H103KA01D	K22174823		1-	B	b6
C 3330	CHIP CAP.	0.001uF	50V	B	GRM188B11H102KA01D	K22174821		1-	B	a6
C 3331	CHIP CAP.	0.1uF	16V	B	GRM188B11C104KA01D	K22124805		1-	B	d6
C 3332	CHIP CAP.	0.01uF	50V	B	GRM188B11H103KA01D	K22174823		1-	B	d7
C 3333	CHIP CAP.	0.001uF	50V	B	GRM188B11H102KA01D	K22174821		1-	B	d7
C 3334	CHIP CAP.	1pF	200V	CK	GRM2194C2D1R0CY21D	K22230208	VER. FH	77-78	A	H7
C 3334	CHIP CAP.	1pF	200V	CK	GRM2194C2D1R0CY21D	K22230208		79-	A	H7
C 3338	CHIP CAP.	1pF	50V	CK	GRM1884C1H1R0CZ01D	K22174202	EXPORT	1-	A	G7
C 3338	CHIP CAP.	1pF	50V	CK	GRM1884C1H1R0CZ01D	K22174202	FRANCE	1-	A	G7
C 3339	CHIP CAP.	7pF	200V	CH	GRM2192C2D7R0DY21D	K22230213		1-	A	E6
C 3340	FILM CAP.	10pF	500V		UC232H0100D-T	K33279019		18-59	A	C7
C 3342	CHIP CAP.	0.001uF	630V	R	GRM31BR32J102KY01L	K22281801		60-	B	g7
C 3343	CHIP CAP.	0.01uF	250V	X7R	GRM21BR72E103KW03L	K22240801		60-	B	g7
D 3001	DIODE				BAS316	G2070716		1-5	A	B1
D 3002	DIODE				BAS316	G2070716		1-5	A	B1
D 3002	DIODE				UDZS TE-17 16B	G2070914		6-	A	B1
D 3003	DIODE				BAS316	G2070716		1-	A	E2
D 3005	DIODE				DAP202K T146	G2070180		1-	A	A4
D 3006	DIODE				BAS316	G2070716		1-	A	E2
D 3007	DIODE				BAS316	G2070716		1-	A	E2
D 3008	DIODE				UDZS TE-17 16B	G2070914		1-	A	E2
D 3009	DIODE				11ES1	G2090499		1-18		
D 3009	DIODE				10EDB10	G2090781		19-59		
D 3010	DIODE				DAN202K T146	G2070182		1-59		
D 3011	DIODE				DAN202K T146	G2070182		1-	A	A3
D 3012	DIODE				11ES1	G2090499		1-18	A	C5
D 3012	DIODE				10EDB10	G2090781		19-	A	C5
D 3013	DIODE				DAN202K T146	G2070182		1-	A	B1
D 3014	DIODE				DAP236U T106	G2070592		1-	A	E3
D 3015	DIODE				HSU277TRF-E	G2070118		1-	B	d2
D 3016	DIODE				DAP236U T106	G2070592		1-	A	E4
D 3017	DIODE				DAP236U T106	G2070592		1-	B	d6
D 3018	DIODE				UM9957F/TR	G2070562		1-9	A	D7
D 3018	DIODE				XB15A709A0HR	G2070826		10-63	A	D7
D 3018	DIODE				L709CER	G2071124		64-	A	D7
D 3019	DIODE				UM9957F/TR	G2070562		1-9	A	D6
D 3019	DIODE				XB15A709A0HR	G2070826		10-63	A	D6
D 3019	DIODE				L709CER	G2071124		64-	A	D6
D 3021	DIODE				UM9957F/TR	G2070562		1-9	A	E7
D 3021	DIODE				XB15A709A0HR	G2070826		10-63	A	E7
D 3021	DIODE				L709CER	G2071124		64-	A	E7
D 3022	DIODE				UM9957F/TR	G2070562		1-9	A	D6
D 3022	DIODE				XB15A709A0HR	G2070826		10-63	A	D6
D 3022	DIODE				L709CER	G2071124		64-	A	D6
D 3023	DIODE				HSU277TRF-E	G2070118		1-	A	D6

PA Unit

Parts List

REF	DESCRIPTION	VALUE	V/W	TOL.	MFR'S DESIG	VXSTD P/N	VERS.	LOT	SIDE	LAY ADR
D 3024	DIODE				BAS316	G2070716		1-	A	E4
D 3025	DIODE				BAS316	G2070716		1-	A	E3
D 3026	DIODE				BAS316	G2070716		1-	B	c4
D 3027	DIODE				BAS316	G2070716		1-	B	c3
D 3028	DIODE				BAS316	G2070716		1-	A	E2
D 3029	DIODE				BAS316	G2070716		1-	A	E5
D 3030	DIODE				BAS316	G2070716		1-	B	c2
D 3031	DIODE				BAS316	G2070716		1-	B	c4
D 3032	DIODE				BAS316	G2070716		1-	A	E4
D 3033	DIODE				BAS316	G2070716		1-	A	E5
D 3034	DIODE				BAS316	G2070716		1-	B	c3
D 3035	DIODE				BAS316	G2070716		1-	B	c5
D 3036	DIODE				BAS316	G2070716		1-	A	E5
D 3037	DIODE				BAS316	G2070716		1-	B	c6
D 3038	DIODE				UM9957F/TR	G2070562		1-9	B	d7
D 3038	DIODE				XB15A709A0HR	G2070826		10-63	B	d7
D 3038	DIODE				L709CER	G2071124		64-	B	d7
D 3039	DIODE				HSU277TRF-E	G2070118		1-	A	D6
D 3040	DIODE				HSU277TRF-E	G2070118		1-	B	d6
D 3041	DIODE				UM9957F/TR	G2070562		1-17	A	E7
D 3041	DIODE				MA4P1250	G2070974		18-24	A	E7
D 3041	DIODE				UM9401F/TR	G2070516		25-84	A	E7
D 3041	DIODE				UMX9401F	G2071214		85-	A	E7
D 3042	DIODE				DAN202K T146	G2070182		1-	B	b6
D 3043	DIODE				DAN202K T146	G2070182		1-	B	b6
D 3044	DIODE				RB751S-40TE61	G2070850		1-	A	G7
D 3045	DIODE				BAS316	G2070716		1-	B	a4
D 3046	DIODE				BAS316	G2070716		1-	B	a3
D 3047	DIODE				BAS316	G2070716		1-	B	a2
D 3048	DIODE				BAS316	G2070716		1-	B	a5
D 3049	DIODE				BAS316	G2070716		1-	B	a3
D 3050	DIODE				MA729-(TX)	G2070320		1-	A	G6
D 3051	DIODE				BAS316	G2070716		1-	B	a4
D 3052	DIODE				BAS316	G2070716		1-	B	a6
D 3053	DIODE				DAN235U TL	G2070176		1-	B	d7
D 3054	DIODE				RB751S-40TE61	G2070850		1-	A	H7
D 3055	DIODE				MA729-(TX)	G2070320		1-	A	G6
D 3056	SURGE ABSORBER				RCCA-301Q43UA	Q9000756		1-	B	a6
D 3057	DIODE				HSU277TRF-E	G2070118		1-	B	d6
D 3058	SURGE ABSORBER				RCCA-301Q43UA	Q9000756		1-	B	a7
D 3059	DIODE				HSU277TRF-E	G2070118		1-	B	d6
FB3003	FERRITE BEADS				SMB304729	L9190094		1-	A	B7
FB3004	FERRITE BEADS				FB-43-801	L9190025		1-	A	B7
J 3001	CONNECTOR				24FLT-SM2-TB(LF)(SN)	P1091128		1-	A	A1
J 3002	CONNECTOR				SC25-02WS	P0090621		1	A	B1
J 3003	CONNECTOR				B2B-ZR(LF)(SN)	P0090647		1-	A	A2
J 3004	CONNECTOR				B2B-ZR(LF)(SN)	P0090647		1-	A	A2
J 3005	CONNECTOR				B2B-EH(LF)(SN)	P0090666		1-	A	G1
JP3001	WIRE ASSY				RED 140 TMP/TMP(B1)	T9318198		1-2	A	B6
JP3001	WIRE ASSY				RED 140 TMP/TMP(B1)	T9318201	W/ CE	3-	A	B6
JP3001	WIRE ASSY				RED 140 TMP/TMP(B1)	T9318198	W/O CE	3-	A	B6
JP3002	WIRE ASSY				GRN 290 TMP/TMP(B1)	T9318197		1-	A	E6
JP3003	WIRE ASSY				AH007M	T9207026		1		
JP3003	WIRE ASSY				AH007M	T9207030	W/ CE	2-		
JP3003	WIRE ASSY				AH007M	T9207026	W/O CE	2-		
JP3004	WIRE ASSY				GRN 25 2/2	T50502500	VER. FH	77-78		
L 3001	COIL				E2 0.25-1.9-12T-L	L0022592		1-	A	A6
L 3002	COIL				E2 0.25-1.9-12.5T-L	L0022600		1-	A	A5
L 3003	COIL				E2 0.5-2.0-6T-R	L0022488		1-	A	A6
L 3004	COIL				E2 0.45-1.4-4T-L	L0022391		1-	A	A6
L 3005	COIL				E2 0.5-2.0-7T-R	L0022489		1-	A	A6
L 3006	COIL				E2 0.35-1.6-4.5T-L	L0022577		1-	A	B6
L 3007	COIL				E2 0.3-1.7-8T-L	L0022376		1-	A	A6
L 3009	COIL				E2 0.3-1.7-8T-L	L0022376		1-	A	A6
L 3010	COIL				E2 0.4-3.0-9.5T-L	L0022575		1-	A	A5
L 3011	COIL				E2 0.25-1.85-8.5T-L	L0022576		1-	A	A4
L 3012	COIL				E2 0.3-1.7-8T-L	L0022376		1-	A	A6
L 3013	M.RFC	0.0056uH			HK1608 5N6S-T	L1690513		1-59	A	B6
L 3013	COIL				E2 0.3-0.9-3T-R	L0022389		60-	A	B6
L 3014	COIL				E2 0.45-1.4-4T-L	L0022391		1-59	A	A6
L 3014	COIL				E2 0.35-1.6-4T-L	L0022456		60-	A	A6
L 3015	M.RFC	10uH			CDRH73NP-100MC	L1690598		1-	A	A3
L 3016	COIL				E2 0.4-3.0-9.5T-L	L0022575		1-	A	B7

PA Unit

Parts List

REF	DESCRIPTION	VALUE	V/W	TOL.	MFR'S DESIG	VXSTD P/N	VERS.	LOT	SIDE	LAY ADR
L 3017	TOROIDAL COIL	6uH			6H3 TR10X5X5	L0022831		1-	A	B3
L 3018	RFC WITH BEADS				3A R15.8X6.4-2	L1020729		1-	A	E1
L 3019	RFC WITH BEADS				3A R15.8X6.4-2	L1020729		1-	A	D6
L 3020	COIL	0.11uH			AS0810-B0NK	L0022542		1-	A	C5
L 3021	M.RFC	4.7uH			LK2125 4R7K-T	L1690327		1-	A	E3
L 3022	COIL A1				4.5T6.0D1.2UEW R	L0022150		1-	A	E5
L 3023	M.RFC	4.7uH			LK2125 4R7K-T	L1690327		1-	A	E3
L 3024	M.RFC	0.47uH			LK2125 R47K-T	L1690315		1-	B	d4
L 3025	M.RFC	1.8uH			LK2125 1R8K-T	L1690322		1-	B	d2
L 3026	M.RFC	1uH			LK2125 1R0K-T	L1690319		1-	B	d5
L 3027	M.RFC	0.39uH			LK2125 R39K-T	L1690314		1-	B	d5
L 3029	COIL	0.015uH			AS0803-15NK	L0022536		1-	A	D7
L 3030	CHIP COIL	4.7uH		10%	C2520C-4R7K-RK	L1690735		1-61	A	D7
L 3030	CHIP COIL	1uH		2%	C2520C-1R0G	L1691309		62-	A	D7
L 3031	COIL				E2 0.4-3.0-9.5T-L	L0022575		1-	A	D6
L 3032	COIL	0.047uH			AS0805-47NK	L0022539		1-	A	E7
L 3034	COIL	0.015uH			AS0803-15NK	L0022536		1-	A	E6
L 3035	M.RFC	4.7uH			LK2125 4R7K-T	L1690327		1-	A	E3
L 3036	M.RFC	1.8uH			LK2125 1R8K-T	L1690322		1-	B	d3
L 3037	M.RFC	1uH			LK2125 1R0K-T	L1690319		1-	B	d5
L 3038	M.RFC	0.47uH			LK2125 R47K-T	L1690315		1-	B	d4
L 3039	M.RFC	0.39uH			LK2125 R39K-T	L1690314		1-	B	d5
L 3040	COIL	0.056uH			AS0806-56NK	L0022540		1-	A	E7
L 3041	COIL	0.047uH			AS0805-47NK	L0022539		1-	A	E7
L 3042	COIL				E2 0.4-2.0-5.5T-L	L0022630		1-	A	E7
L 3043	COIL	0.01uH			AS1003-10NK	L0022544		1-	A	E6
L 3044	COIL	0.01uH			AS1003-10NK	L0022544		1-	A	E6
L 3045	COIL				E2 0.3-0.9-6T-R	L0022375		1-	A	E6
L 3046	TOROIDAL COIL	4.5uH			4.50U T44-2	L0022560		1-	A	F4
L 3047	TOROIDAL COIL	2.05uH			2.05U T44-2	L0022562		1-	A	F3
L 3048	TOROIDAL COIL	1.32uH			1.32U T44-2	L0022564A		1-	A	G2
L 3049	TOROIDAL COIL	0.558uH			0.558U T44-10	L0022566A		1-	A	F4
L 3050	TOROIDAL COIL	0.4uH			0.400U T44-10	L0022567		1-	A	F3
L 3051	TOROIDAL COIL	0.114uH			0.114U T44-10	L0022569		1-	A	F5
L 3052	COIL B1				6.0T8.0D0.8UEW L	L0022570		1-	A	F4
L 3053	M.RFC	0.18uH			LK2125 R18K-T	L1690310		1-	B	d6
L 3054	M.RFC	0.18uH			LK2125 R18K-T	L1690310		1-	B	c5
L 3055	COIL	0.047uH			AS0805-47NK	L0022539		1-	A	F7
L 3056	COIL	0.047uH			AS0805-47NK	L0022539		1-	A	F7
L 3057	CHIP COIL	4.7uH		10%	C2520C-4R7K-RK	L1690735		1-	A	E6
L 3058	COIL	0.01uH			AS1003-10NK	L0022544		1-	A	F6
L 3059	TOROIDAL COIL	3.6uH			3.60U T44-2	L0022561		1-	A	G4
L 3060	TOROIDAL COIL	1.57uH			1.57U T44-2	L0022563		1-	A	G3
L 3061	TOROIDAL COIL	1.11uH			1.11U T44-2	L0022565A		1-	A	G3
L 3062	TOROIDAL COIL	0.4uH			0.400U T44-10	L0022567		1-	A	G4
L 3063	COIL B1				9.0T8.5D0.9UEW R	L0021856		1-	A	F2
L 3064	TOROIDAL COIL	0.146uH			0.146U T44-10	L0022568		1-	A	G5
L 3065	COIL B1				7.0T8.5D0.9UEW R	L0021858		1-	A	G4
L 3066	TOROIDAL COIL	0.146uH			0.146U T44-10	L0022568		1-	A	G5
L 3067	COIL	0.022uH			AS1004-22NK	L0022545		1-	A	F7
L 3068	M.RFC	4.7uH			ELJ-FC4R7KF	L1690348		1-	A	G7
L 3069	COIL	0.015uH			AS1203-15NK	L0022543		1-	A	F6
L 3070	M.RFC	470uH			FLC32T-471J	L1690235		1-	A	G6
L 3071	M.RFC	0.012uH			HK1608 12NJ-T	L1690517		1-	B	d6
L 3072	M.RFC	4.7uH			ELJ-FC4R7KF	L1690348		1-	A	H7
L 3073	M.RFC	470uH			FLC32T-471J	L1690235		1-	A	G6
L 3074	M.RFC	120uH			RCH-875 121K	L1190396		1-	A	H7
L 3075	M.RFC	22uH			RCR875DNP-220L	L1190397		1-	A	G7
Q 3001	IC				TA75S01F(TE85R.F)	G1091593		1-	B	c2
Q 3002	TRANSISTOR				DTC323TK T146	G3070042		1-	A	A2
Q 3003	IC				BU4094BCFV-E2	G1093527		1-16	A	B1
Q 3003	IC				CD4094BPWR	G1093866		17-	A	B1
Q 3004	TRANSISTOR				2SC4154-T111-1E	G3341548E		1-88	B	f1
Q 3004	TRANSISTOR				2SC4081 T106	G3340818		89-	B	f1
Q 3006	TRANSISTOR				2SB1143S	G3211430S		1-	A	C1
Q 3007	IC				KIA7805API	G1093163		1-	A	D1
Q 3008	TRANSISTOR				2SC4154-T111-1E	G3341548E		1-88	B	f1
Q 3008	TRANSISTOR				2SC4081 T106	G3340818		89-	B	f1
Q 3009	TRANSISTOR				2SC4154-T111-1E	G3341548E		1-88	B	f1
Q 3009	TRANSISTOR				2SC4081 T106	G3340818		89-	B	f1
Q 3010	TRANSISTOR				DTC124GUA T106	G3070184		1-	A	E2
Q 3011	TRANSISTOR				DTC114TK T146	G3070073		1-	A	E2
Q 3012	IC				BU4094BCFV-E2	G1093527		1-16	A	D2

PA Unit

Parts List

REF	DESCRIPTION	VALUE	V/W	TOL.	MFR'S DESIG	VXSTD P/N	VERS.	LOT	SIDE	LAY ADR
Q 3012	IC				CD4094BPWR	G1093866		17-	A	D2
Q 3013	TRANSISTOR				2SA812-T2B M5B	G3108127E		1-	B	f1
Q 3014	TRANSISTOR				2SD1801S-TL	G3418018S		1-	A	A3
Q 3015	TRANSISTOR				2SD1801S-TL	G3418018S		1-59		
Q 3016	TRANSISTOR				DTC143ZUA T106	G3070188		1-	B	a5
Q 3017	TRANSISTOR				DTC143ZUA T106	G3070188		1-	A	D2
Q 3018	TRANSISTOR				DTA113ZKA T146	G3070129		1-	A	C1
Q 3019	TRANSISTOR				DTA113ZKA T146	G3070129		1-	B	h2
Q 3020	TRANSISTOR				IMD3 T108	G3070053		1-	A	C1
Q 3021	TRANSISTOR				IMD3 T108	G3070053		1-	A	B1
Q 3022	TRANSISTOR				2SC5125-21	G3351250		1-50	A	C4
Q 3022	TRANSISTOR				2SC2782	G3327820		51-	A	C4
Q 3023	TRANSISTOR				2SC5125-21	G3351250		1-50	A	C3
Q 3023	TRANSISTOR				2SC2782	G3327820		51-	A	C3
Q 3024	TRANSISTOR				2SC3102	G3331020		1-59	A	C6
Q 3024	FET				RD70HVF1-101	G3090140		60-	A	C6
Q 3025	TRANSISTOR				DTC143ZUA T106	G3070188		1-	A	D2
Q 3026	TRANSISTOR				DTC143ZUA T106	G3070188		1-	A	E2
Q 3027	TRANSISTOR				DTA113ZKA T146	G3070129		1-	A	B1
Q 3028	TRANSISTOR				2SB624-T2B BV4	G3206247D		1-	A	C1
Q 3029	TRANSISTOR				2SB624-T2B BV4	G3206247D		1-	A	B1
Q 3030	TRANSISTOR				DTC143ZUA T106	G3070188		1-	A	D2
Q 3031	TRANSISTOR				DTC143ZUA T106	G3070188		1-	A	D2
Q 3032	TRANSISTOR				DTC143ZUA T106	G3070188		1-	A	G2
Q 3033	TRANSISTOR				DTC143ZUA T106	G3070188		1-	B	c3
Q 3034	TRANSISTOR				2SC5374-TL	G3353748		1-	A	E5
Q 3035	TRANSISTOR				IMH6A T108	G3070066		1-	B	c6
Q 3036	TRANSISTOR				DTC143ZUA T106	G3070188		79-	B	b6
R 3001	CHIP RES.	100k	1/16W	5%	RMC1/16 104JATP	J24185104		1-	A	B1
R 3002	CHIP RES.	47k	1/16W	5%	RMC1/16 473JATP	J24185473		1-	A	B1
R 3004	CHIP RES.	1k	1/16W	5%	RMC1/16 102JATP	J24185102		1-	B	c2
R 3005	CHIP RES.	180k	1/10W	0.5%	RR1220R-184-D-T5	J24209225		1-	B	c2
R 3006	CHIP RES.	10k	1/16W	5%	RMC1/16 103JATP	J24185103		1-	B	c2
R 3007	CHIP RES.	1.5k	1/10W	0.1%	RR1220P-152-B	J24209078		1-	B	c2
R 3008	CHIP RES.	470	1W	5%	RMC1 471JTE	J24305471		79-	A	B6
R 3009	CHIP RES.	0	1W	5%	RMC1 JPATE	J24305000		1-78	A	A6
R 3009	CHIP RES.	10	1W	5%	RMC1 100JTE	J24305100		79-	A	A6
R 3010	CHIP RES.	470	1W	5%	RMC1 471JTE	J24305471		79-	A	A6
R 3011	CHIP RES.	0	1/16W	5%	RMC1/16 000JATP	J24185000		1-	B	g1
R 3012	CHIP RES.	22	1W	5%	RMC1 220JTE	J24305220		1-	B	h1
R 3013	CHIP RES.	180k	1/10W	0.5%	RR1220R-184-D-T5	J24209225		1-	B	c2
R 3014	CHIP RES.	1.5k	1/10W	0.1%	RR1220P-152-B	J24209078		1-	B	c2
R 3015	CHIP RES.	10k	1/10W	0.1%	RR1220P-103-B	J24209098		1-	B	c2
R 3016	CHIP RES.	4.7k	1/16W	5%	RMC1/16 472JATP	J24185472		1-	B	c2
R 3017	CHIP RES.	1.5k	1/10W	0.1%	RR1220P-152-B	J24209078		1-	B	c2
R 3018	CHIP RES.	1.5k	1/10W	0.1%	RR1220P-152-B	J24209078		1-	B	d2
R 3019	CHIP RES.	10k	1/10W	0.1%	RR1220P-103-B	J24209098		1-	B	c2
R 3020	CHIP RES.	0	1/16W	5%	RMC1/16 000JATP	J24185000		1-	A	A6
R 3025	CHIP RES.	10k	1/16W	5%	RMC1/16 103JATP	J24185103		1-	B	f1
R 3026	CHIP RES.	3.9k	1/16W	1%	RMC1/16 392FTP	J24183392		1-	B	g1
R 3027	CHIP RES.	100	1/4W	5%	RMC1/4 101JATP	J24245101		1-	B	f2
R 3028	CHIP RES.	2.2k	1/16W	5%	RMC1/16 222JATP	J24185222		1-	B	f1
R 3029	CHIP RES.	1k	1/16W	1%	RMC1/16 102FTP	J24183102		1-	B	g1
R 3030	CHIP RES.	100	1/4W	5%	RMC1/4 101JATP	J24245101		1-	B	g1
R 3031	CHIP RES.	4.7k	1/16W	5%	RMC1/16 472JATP	J24185472		1-	B	g1
R 3032	CHIP RES.	47k	1/16W	5%	RMC1/16 473JATP	J24185473		1-	A	A4
R 3033	CHIP RES.	4.7k	1/16W	5%	RMC1/16 472JATP	J24185472		1-	A	A4
R 3034	CHIP RES.	4.7k	1/16W	5%	RMC1/16 472JATP	J24185472		1-	A	A4
R 3035	CHIP RES.	82k	1/16W	5%	RMC1/16 823JATP	J24185823		1-	A	A4
R 3037	CHIP RES.	10k	1/16W	5%	RMC1/16 103JATP	J24185103		1-	A	E2
R 3038	CHIP RES.	330	1W	5%	RMC1 331JTE	J24305331		1-	B	h4
R 3039	CHIP RES.	1k	1/16W	5%	RMC1/16 102JATP	J24185102		1-	A	E2
R 3040	CHIP RES.	0	1/16W	5%	RMC1/16 000JATP	J24185000		1-	A	A4
R 3041	CHIP RES.	0	1/16W	5%	RMC1/16 000JATP	J24185000		1-	A	B6
R 3042	CHIP RES.	0	1/16W	5%	RMC1/16 000JATP	J24185000		1-	A	A7
R 3043	CHIP RES.	1k	1/16W	5%	RMC1/16 102JATP	J24185102		1-	B	f1
R 3044	CHIP RES.	100	1/4W	5%	RMC1/4 101JATP	J24245101		1-	B	f1
R 3045	CHIP RES.	0.33	1W	10%	RMC1 R33KATE	J24309001		1-	B	f1
R 3046	CHIP RES.	2.2	1W	5%	RMC1 2R2JTE	J24305229		1-	A	B5
R 3047	CHIP RES.	3.3	1W	5%	RMC1 3R3JTE	J24305339		1-	A	B5
R 3048	CHIP RES.	3.9	1W	5%	RMC1 3R9JTE	J24305399		1-	B	g4
R 3051	CHIP RES.	0	1W	5%	RMC1 JPATE	J24305000		1-	B	g5
R 3052	CHIP RES.	330	1W	5%	RMC1 331JTE	J24305331		1-	B	h4

PA Unit

Parts List

REF	DESCRIPTION	VALUE	V/W	TOL.	MFR'S DESIG	VXSTD P/N	VERS.	LOT	SIDE	LAY ADR
R 3053	CHIP RES.	3.3	1W	5%	RMC1 3R3JTE	J24305339		1-	A	B2
R 3054	CHIP RES.	2.2	1W	5%	RMC1 2R2JTE	J24305229		1-	A	B3
R 3057	CHIP RES.	0	1W	5%	RMC1 JPATE	J24305000		1-	B	g3
R 3060	CHIP RES.	100	1W	5%	RMC1 101JTE	J24305101		1-	B	g4
R 3061	CHIP RES.	220	1/16W	5%	RMC1/16 221JATP	J24185221		1-	A	A7
R 3062	CHIP RES.	3.9	1W	5%	RMC1 3R9JTE	J24305399		1-	B	g3
R 3063	CHIP RES.	56	1/10W	5%	RMC1/10T 560J	J24205560		1-59	B	g7
R 3063	CHIP RES.	68	1W	5%	RMC1 680JTE	J24305680		60-	B	g7
R 3064	CHIP RES.	100	1/16W	5%	RMC1/16 101JATP	J24185101		1-50	A	A2
R 3064	CHIP RES.	47	1/16W	5%	RMC1/16 470JATP	J24185470		51-	A	A2
R 3065	CHIP RES.	10	1/2W	5%	RMC1/2 100JCTP	J24275100		1-	B	g5
R 3066	CHIP RES.	10	1/2W	5%	RMC1/2 100JCTP	J24275100		1-	B	g2
R 3067	CHIP RES.	2.2k	1/16W	5%	RMC1/16 222JATP	J24185222		1-	A	B1
R 3068	CHIP RES.	2.2k	1/16W	5%	RMC1/16 222JATP	J24185222		1-	A	B1
R 3069	CHIP RES.	33	1W	5%	RMC1 330JTE	J24305330		1-	A	C5
R 3070	CHIP RES.	1.5k	1/16W	5%	RMC1/16 152JATP	J24185152		1-	B	d3
R 3071	CHIP RES.	1.5k	1/16W	5%	RMC1/16 152JATP	J24185152		1-	B	d2
R 3072	CHIP RES.	1.5k	1/16W	5%	RMC1/16 152JATP	J24185152		1-	B	d4
R 3073	CHIP RES.	1.5k	1/16W	5%	RMC1/16 152JATP	J24185152		1-	B	d4
R 3074	CHIP RES.	1.5k	1/16W	5%	RMC1/16 152JATP	J24185152		1-	B	d5
R 3075	CHIP RES.	1.5k	1/16W	5%	RMC1/16 152JATP	J24185152		1-	B	c6
R 3077	CHIP RES.	1k	1/16W	5%	RMC1/16 102JATP	J24185102		1-	A	E6
R 3078	CHIP RES.	33	1W	5%	RMC1 330JTE	J24305330		1-	A	D5
R 3079	CHIP RES.	1.5k	1/16W	5%	RMC1/16 152JATP	J24185152		1-	B	d4
R 3080	CHIP RES.	470	1/16W	5%	RMC1/16 471JATP	J24185471		1-	B	c4
R 3081	CHIP RES.	68	1/16W	5%	RMC1/16 680JATP	J24185680		1-	A	E5
R 3082	CHIP RES.	470	1/16W	5%	RMC1/16 471JATP	J24185471		1-	A	D5
R 3083	CHIP RES.	6.8k	1/16W	5%	RMC1/16 682JATP	J24185682		1-	B	d5
R 3084	CHIP RES.	33k	1/16W	5%	RMC1/16 333JATP	J24185333		1-	B	d6
R 3085	CHIP RES.	0	1/16W	5%	RMC1/16 000JATP	J24185000		1-	A	E7
R 3086	CHIP RES.	0	1/16W	5%	RMC1/16 000JATP	J24185000		1-	A	E6
R 3087	CHIP RES.	0	1/16W	5%	RMC1/16 000JATP	J24185000		1-	A	F7
R 3088	CHIP RES.	0	1/16W	5%	RMC1/16 000JATP	J24185000		1-	B	e5
R 3090	CHIP RES.	56	1W	5%	RMC1 560JTE	J24305560		1-	A	D5
R 3091	CHIP RES.	0	1/16W	5%	RMC1/16 000JATP	J24185000		1-	A	F7
R 3093	CHIP RES.	1.8k	1/16W	5%	RMC1/16 182JATP	J24185182		1-	B	c6
R 3094	CHIP RES.	1k	1/16W	5%	RMC1/16 102JATP	J24185102		1-	B	b6
R 3096	CHIP RES.	10k	1/16W	5%	RMC1/16 103JATP	J24185103		1-	B	d6
R 3097	CHIP RES.	10k	1/16W	5%	RMC1/16 103JATP	J24185103		1-	B	c6
R 3098	CHIP RES.	10k	1/16W	5%	RMC1/16 103JATP	J24185103		1-	B	d6
R 3099	CHIP RES.	1.5k	1/16W	5%	RMC1/16 152JATP	J24185152		1-	B	d6
R 3100	CHIP RES.	1k	1/16W	5%	RMC1/16 102JATP	J24185102		1-	B	c6
R 3101	CHIP RES.	1k	1/16W	5%	RMC1/16 102JATP	J24185102		1-	B	d6
R 3103	CHIP RES.	1k	1/16W	5%	RMC1/16 102JATP	J24185102		1-	B	b6
R 3104	CHIP RES.	100	1/16W	5%	RMC1/16 101JATP	J24185101		1-	A	G7
R 3105	CHIP RES.	4.7k	1/16W	5%	RMC1/16 472JATP	J24185472		1-	A	G6
R 3106	CHIP RES.	56	1/2W	5%	RMC1/2 560JTE	J24275560		1-	B	b6
R 3107	CHIP RES.	56	1/2W	5%	RMC1/2 560JTE	J24275560		1-	A	G6
R 3109	CHIP RES.	56	1/2W	5%	RMC1/2 560JTE	J24275560		1-	B	b6
R 3110	CHIP RES.	56	1/2W	5%	RMC1/2 560JTE	J24275560		1-	A	G6
R 3112	CHIP RES.	27	1/16W	5%	RMC1/16 270JATP	J24185270		1-	A	G7
R 3117	CHIP RES.	10k	1/16W	5%	RMC1/16 103JATP	J24185103		1-	A	G6
R 3118	CHIP RES.	4.7k	1/16W	5%	RMC1/16 472JATP	J24185472		1-	A	G6
R 3119	CHIP RES.	47k	1/16W	5%	RMC1/16 473JATP	J24185473		1-	B	a6
R 3120	CHIP RES.	1.5k	1/16W	5%	RMC1/16 152JATP	J24185152		1-	B	d6
R 3123	CHIP RES.	47k	1/16W	5%	RMC1/16 473JATP	J24185473		1-	B	a7
R 3124	CHIP RES.	4.7	1W	5%	RMC1 4R7JTE	J24305479		60-	B	g6
R 3125	CHIP RES.	4.7	1W	5%	RMC1 4R7JTE	J24305479		60-	B	g6
R 3126	CHIP RES.	68	1W	5%	RMC1 680JTE	J24305680		60-	B	g7
R 3127	CHIP RES.	390	1/16W	5%	RMC1/16 391JATP	J24185391		60-	A	A7
R 3128	CHIP RES.	22k	1/16W	5%	RMC1/16 223JATP	J24185223		60-	A	B7
R 3129	CHIP RES.	1	1W	5%	RMC1 1R0JTE	J24305010		60-	A	B6
R 3130	CHIP RES.	1	1W	5%	RMC1 1R0JTE	J24305010		60-	A	B6
R 3131	CHIP RES.	1	1W	5%	RMC1 1R0JTE	J24305010		60-	A	B7
R 3132	CHIP RES.	10k	1/16W	5%	RMC1/16 103JATP	J24185103		79-	B	a6
RL3001	RELAY		DC12V		ACP331 DC12V	M1190175		1-	A	E1
RL3002	RELAY		DC12V		G5V-1 DC12V	M1190120		1-	A	E4
RL3003	RELAY		DC12V		G5V-1 DC12V	M1190120		1-	A	E3
RL3004	RELAY		DC12V		G5V-1 DC12V	M1190120		1-	A	E2
RL3005	RELAY		DC12V		G5V-1 DC12V	M1190120		1-	A	E4
RL3006	RELAY		DC12V		G5V-1 DC12V	M1190120		1-	A	E3
RL3007	RELAY		DC12V		G5V-1 DC12V	M1190120		1-	A	E5
RL3008	RELAY		DC12V		AG201344 DC12V	M1190124		1-2	A	E6

PA Unit

Parts List

REF	DESCRIPTION	VALUE	V/W	TOL.	MFR'S DESIG	VXSTD P/N	VERS.	LOT	SIDE	LAY ADR
RL3008	RELAY		DC12V		AG231344 DC12V	M1190145		3-	A	E6
RL3009	RELAY		DC12V		G5V-1 DC12V	M1190120		1-	A	H4
RL3010	RELAY		DC12V		G5V-1 DC12V	M1190120		1-	A	H3
RL3011	RELAY		DC12V		G5V-1 DC12V	M1190120		1-	A	H2
RL3012	RELAY		DC12V		G5V-1 DC12V	M1190120		1-	A	H4
RL3013	RELAY		DC12V		G5V-1 DC12V	M1190120		1-	A	H2
RL3014	RELAY		DC12V		G5V-1 DC12V	M1190120		1-	A	H3
RL3015	RELAY		DC12V		AG201344 DC12V	M1190124		1-2	A	G5
RL3015	RELAY		DC12V		AG231344 DC12V	M1190145		3-	A	G5
T 3002	TOROIDAL COIL				D12A R116X8X8(H007)	L0022745		1-	A	F1
T 3003	COIL PWR-WIDE				3A5 RIB10	L0022791		1-	A	A4
T 3004	COIL PWR-WIDE				D12A RIB16X32X22	L0022832		1-	A	D4
T 3005	COIL WIDE-TRANS.				3-318707	L0022619		1-	A	E6
T 3006	COIL WIDE-TRANS.				#223093	L0022792		1-	A	H6
TC3001	TRIMMER CAP.	20pF			ECR-JA020E11X	K91000228		1-	A	B6
TC3002	TRIMMER CAP.	20pF			ECR-JA020E11X	K91000228		1-	A	G6
TH3001	THERMISTOR				157-502-53002TP	G9090049		1-	A	C4
TH3002	THERMISTOR				157-502-53002TP	G9090049		1-	A	C6
TP3025	TERMINAL				TP-E/MS-60124	Q5000016		1-	A	D2
TP3026	TERMINAL				TP-E/MS-60124	Q5000016		1-	A	D3
VR3001	POT.	470			EVN-5ESX50BQ2	J51811471		1-	A	A2
VR3002	POT.	470			EVN-5ESX50BQ2	J51811471		1-	A	A7
VR3003	POT.	220			EVN-5ESX50BE2	J51811221		1-	A	G7
	LEAF SPRING					R0132100	W/ CE	3-		
	LEAF SPRING					R0132100		60-63		
	LEAF SPRING					R0132100		64-		
	GROUND PLATE					RA0415200		64-		
	GROUND PLATE					RA0415200		64-		

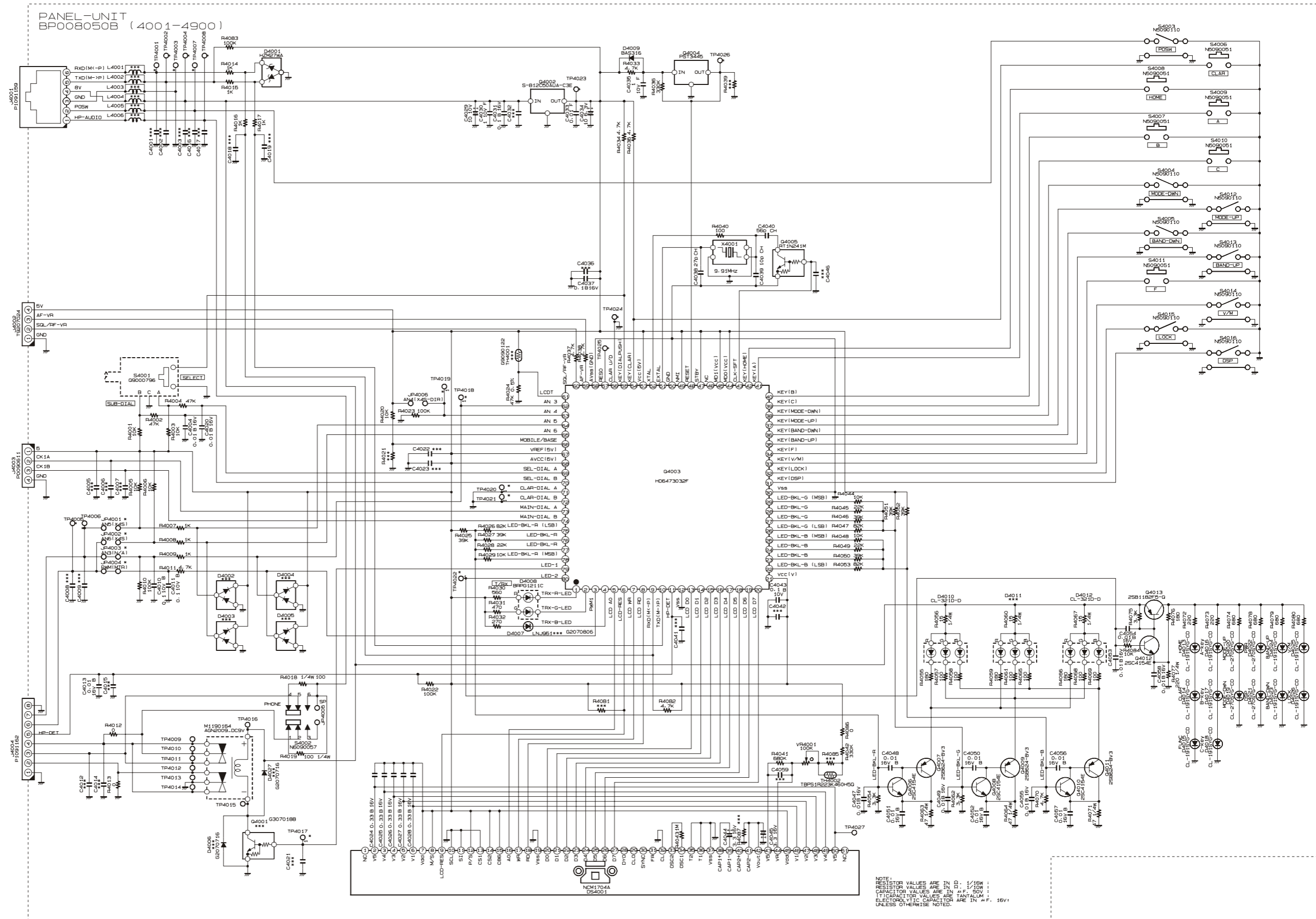

NOTE:
 RESISTOR VALUES ARE IN Ω, 1/16W;
 CAPACITOR VALUES ARE IN Ω, 1/10W;
 CAPACITOR VALUES ARE IN Ω, 1/50W;
 (T) CAPACITOR VALUES ARE TANTALUM;
 ELECTROLYTIC CAPACITOR ARE IN μF, 50V;
 UNLESS OTHERWISE NOTED.

PANEL Unit

Parts List

REF	DESCRIPTION	VALUE	V/W	TOL.	MFR'S DESIG	VXSTD P/N	VERS.	LOT	SIDE	LAY ADR	
PCB with Components						CB1231001					
Printed Circuit Board						AH007M000	FR0098400		1-		
C 4001	CHIP CAP.	470pF	50V	B	GRM155B11H471KA01D	K22178805		1-	B	e1	
C 4002	CHIP CAP.	470pF	50V	B	GRM155B11H471KA01D	K22178805		1-	B	e1	
C 4003	CHIP CAP.	470pF	50V	B	GRM155B11H471KA01D	K22178805		1-	B	e1	
C 4004	CHIP CAP.	0.01uF	16V	B	GRM36B103K16PT	K22128804		1-82	B	g2	
C 4004	CHIP CAP.	0.01uF	25V	B	GRM155B11E103KA01D	K22148834		83-	B	g2	
C 4010	CHIP CAP.	0.1uF	10V	B	GRM155B11A104KA01D	K22108802		1-	B	b2	
C 4011	CHIP CAP.	0.1uF	10V	B	GRM155B11A104KA01D	K22108802		1-	B	b2	
C 4013	CHIP CAP.	0.01uF	16V	B	GRM36B103K16PT	K22128804		1-82	A	G2	
C 4013	CHIP CAP.	0.01uF	25V	B	GRM155B11E103KA01D	K22148834		83-	A	G2	
C 4016	CHIP CAP.	470pF	50V	B	GRM155B11H471KA01D	K22178805		1-	B	e1	
C 4017	CHIP CAP.	470pF	50V	B	GRM155B11H471KA01D	K22178805		1-	B	f1	
C 4020	CHIP CAP.	0.01uF	16V	B	GRM36B103K16PT	K22128804		1-82	B	g2	
C 4020	CHIP CAP.	0.01uF	25V	B	GRM155B11E103KA01D	K22148834		83-	B	g2	
C 4024	CHIP CAP.	0.33uF	16V	B	GRM40B334K16PT	K22120807		1-	B	e2	
C 4025	CHIP CAP.	0.33uF	16V	B	GRM40B334K16PT	K22120807		1-	B	e2	
C 4026	CHIP CAP.	0.33uF	16V	B	GRM40B334K16PT	K22120807		1-	B	e2	
C 4027	CHIP CAP.	0.33uF	16V	B	GRM40B334K16PT	K22120807		1-	B	e2	
C 4028	CHIP CAP.	0.33uF	16V	B	GRM40B334K16PT	K22120807		1-	B	e2	
C 4029	CHIP TA.CAP.	10uF	10V		TEESVA1A106M8R	K78100028		1-	B	e1	
C 4030	CHIP CAP.	1uF	10V	F	GRM188F11A105ZA01D	K22105001		1-	B	e1	
C 4031	CHIP CAP.	0.1uF	16V	B	GRM188B11C104KA01D	K22124805		1-	B	e1	
C 4033	CHIP CAP.	0.01uF	50V	F	UMK105F103ZW-F	K22179017		1-	B	f1	
C 4034	CHIP TA.CAP.	10uF	6.3V		TEESVA0J106M8R	K78080027		1-	B	f2	
C 4035	CHIP CAP.	1uF	10V	F	GRM188F11A105ZA01D	K22105001		1-	B	f2	
C 4037	CHIP CAP.	0.1uF	16V	B	GRM188B11C104KA01D	K22124805		1-	B	e1	
C 4038	CHIP CAP.	27pF	50V	CH	UMK105CH270JV-F	K22178268		1-	B	e1	
C 4039	CHIP CAP.	10pF	50V	CH	UMK105CH100DV-F	K22178258		1-	B	e1	
C 4040	CHIP CAP.	56pF	50V	CH	UMK105CH560JV-F	K22178276		1-	B	e1	
C 4043	CHIP CAP.	0.1uF	10V	B	GRM155B11A104KA01D	K22108802		1-	B	d2	
C 4044	CHIP TA.CAP.	3.3uF	16V		TEESVB21C335M8R	K78120010		1-	B	e2	
C 4045	CHIP TA.CAP.	3.3uF	16V		TEESVB21C335M8R	K78120010		1-	B	e2	
C 4047	CHIP CAP.	0.01uF	16V	B	GRM36B103K16PT	K22128804		1-82	B	c1	
C 4047	CHIP CAP.	0.01uF	25V	B	GRM155B11E103KA01D	K22148834		83-	B	c1	
C 4048	CHIP CAP.	0.01uF	16V	B	GRM36B103K16PT	K22128804		1-82	B	c1	
C 4048	CHIP CAP.	0.01uF	25V	B	GRM155B11E103KA01D	K22148834		83-	B	c1	
C 4049	CHIP CAP.	0.01uF	16V	B	GRM36B103K16PT	K22128804		1-82	B	c1	
C 4049	CHIP CAP.	0.01uF	25V	B	GRM155B11E103KA01D	K22148834		83-	B	c1	
C 4050	CHIP CAP.	0.01uF	16V	B	GRM36B103K16PT	K22128804		1-82	B	c1	
C 4050	CHIP CAP.	0.01uF	25V	B	GRM155B11E103KA01D	K22148834		83-	B	c1	
C 4051	CHIP CAP.	0.01uF	16V	B	GRM36B103K16PT	K22128804		1-82	B	c1	
C 4051	CHIP CAP.	0.01uF	25V	B	GRM155B11E103KA01D	K22148834		83-	B	c1	
C 4052	CHIP CAP.	0.01uF	16V	B	GRM36B103K16PT	K22128804		1-82	B	c1	
C 4052	CHIP CAP.	0.01uF	25V	B	GRM155B11E103KA01D	K22148834		83-	B	c1	
C 4053	CHIP CAP.	0.01uF	16V	B	GRM36B103K16PT	K22128804		1-82	B	f2	
C 4053	CHIP CAP.	0.01uF	25V	B	GRM155B11E103KA01D	K22148834		83-	B	f2	
C 4054	CHIP CAP.	0.01uF	16V	B	GRM36B103K16PT	K22128804		1-82	B	f2	
C 4054	CHIP CAP.	0.01uF	25V	B	GRM155B11E103KA01D	K22148834		83-	B	f2	
C 4055	CHIP CAP.	0.01uF	16V	B	GRM36B103K16PT	K22128804		1-82	B	c2	
C 4055	CHIP CAP.	0.01uF	25V	B	GRM155B11E103KA01D	K22148834		83-	B	c2	
C 4056	CHIP CAP.	0.01uF	16V	B	GRM36B103K16PT	K22128804		1-82	B	c2	
C 4056	CHIP CAP.	0.01uF	25V	B	GRM155B11E103KA01D	K22148834		83-	B	c2	
C 4057	CHIP CAP.	0.01uF	16V	B	GRM36B103K16PT	K22128804		1-82	B	c2	
C 4057	CHIP CAP.	0.01uF	25V	B	GRM155B11E103KA01D	K22148834		83-	B	c2	
C 4058	CHIP CAP.	0.01uF	16V	B	GRM36B103K16PT	K22128804		1-82	B	g1	
C 4058	CHIP CAP.	0.01uF	25V	B	GRM155B11E103KA01D	K22148834		83-	B	g1	
D 4001	DIODE				HZM27WA TR-E	G2070530		1-	B	e1	
D 4007	LED				LNJ951C4BRA	G2070806		1-	A	F1	
D 4008	LED				BRPG1211C-TR	G2070654		1-	A	F1	
D 4009	DIODE				BAS316	G2070716		1-	B	f2	
D 4010	LED				CL-321D-D-T	G2070904		1-18	A	F1	
D 4010	LED				CL-321G-D-T	G2071008		19-	A	F1	
D 4012	LED				CL-321D-D-T	G2070904		1-18	A	F2	
D 4012	LED				CL-321G-D-T	G2071008		19-	A	F2	
D 4013	LED				19-215UYOC/S530-A2/TR8	G2070884		1-45	A	B1	
D 4013	LED				19-213/S2C-AN1P2B/3T	G2071096		46-	A	B1	
D 4014	LED				19-215UYOC/S530-A2/TR8	G2070884		1-45	A	B2	
D 4014	LED				19-213/S2C-AN1P2B/3T	G2071096		46-	A	B2	
D 4015	LED				19-215UYOC/S530-A2/TR8	G2070884		1-45	A	B2	
D 4015	LED				19-213/S2C-AN1P2B/3T	G2071096		46-	A	B2	
D 4016	LED				19-215UYOC/S530-A2/TR8	G2070884		1-45	A	C2	
D 4016	LED				19-213/S2C-AN1P2B/3T	G2071096		46-	A	C2	

PANEL Unit

Parts List

REF	DESCRIPTION	VALUE	V/W	TOL.	MFR'S DESIG	VXSTD P/N	VERS.	LOT	SIDE	LAY ADR
D 4017	LED				19-215UYOC/S530-A2/TR8	G2070884		1-45	A	D2
D 4017	LED				19-213/S2C-AN1P2B/3T	G2071096		46-	A	D2
D 4018	LED				19-215UYOC/S530-A2/TR8	G2070884		1-45	A	E2
D 4018	LED				19-213/S2C-AN1P2B/3T	G2071096		46-	A	E2
D 4019	LED				CL-270TD-C-TS	G2070930		1-	A	C1
D 4020	LED				CL-270TD-C-TS	G2070930		1-	A	C1
D 4021	LED				CL-270TD-C-TS	G2070930		1-	A	D1
D 4022	LED				CL-270TD-C-TS	G2070930		1-	A	E1
D 4023	LED				19-215UYOC/S530-A2/TR8	G2070884		1-45	A	G1
D 4023	LED				19-213/S2C-AN1P2B/3T	G2071096		46-	A	G1
D 4024	LED				19-215UYOC/S530-A2/TR8	G2070884		1-45	A	G1
D 4024	LED				19-213/S2C-AN1P2B/3T	G2071096		46-	A	G1
D 4025	LED				19-215UYOC/S530-A2/TR8	G2070884		1-45	A	H1
D 4025	LED				19-213/S2C-AN1P2B/3T	G2071096		46-	A	H1
D 4026	LED				19-215UYOC/S530-A2/TR8	G2070884		1-45	A	H2
D 4026	LED				19-213/S2C-AN1P2B/3T	G2071096		46-	A	H2
DS4001	LCD MODULE				NCM1704A	Q7000428		1-	A	D1
J 4001	CONNECTOR				HJC0271-011023	P1091159		1-	B	f1
J 4002	WIRE ASSY				AH007M	T9207024		1-	B	g1
J 4003	CONNECTOR				SB20-04WS	P0090611		1-	B	b1
J 4004	CONNECTOR				52745-0896	P1091162		1-	B	b2
JP4003	CHIP RES.	0	1/16W	5%	RMC1/16S JPTH	J24189070		1-	B	b2
JP4004	CHIP RES.	0	1/16W	5%	RMC1/16S JPTH	J24189070		1-	B	b2
L 4001	M.RFC	10uH			LK1608 100K-T	L1690689		1-	B	f1
L 4002	M.RFC	10uH			LK1608 100K-T	L1690689		1-	B	f1
Q 4002	IC				S-812C50AUA-C3E-T2G	G1093652		1-	B	f1
Q 4003	IC				HD6473032F(NO PROG.)	G1093506		1	B	d2
Q 4003	IC				HD6473032F R0717	G1093818		2-6	B	d2
Q 4003	IC				HD6433032ST09F	G1093882		7-	B	d2
Q 4004	IC				PST3445UR	G1093232		1-	B	f2
Q 4005	TRANSISTOR				RT1N241M-T11-1	G3070249		1-88	B	e1
Q 4005	TRANSISTOR				DTC124EU T106	G3070045		89-	B	e1
Q 4006	TRANSISTOR				2SC4154-T111-1E	G3341548E		1-88	B	c1
Q 4006	TRANSISTOR				2SC4081 T106	G3340818		89-	B	c1
Q 4007	TRANSISTOR				2SB624-T2B BV3	G3206247C		1-	B	c1
Q 4008	TRANSISTOR				2SC4154-T111-1E	G3341548E		1-88	B	c2
Q 4008	TRANSISTOR				2SC4081 T106	G3340818		89-	B	c2
Q 4009	TRANSISTOR				2SB624-T2B BV3	G3206247C		1-	B	c1
Q 4010	TRANSISTOR				2SC4154-T111-1E	G3341548E		1-88	B	c2
Q 4010	TRANSISTOR				2SC4081 T106	G3340818		89-	B	c2
Q 4011	TRANSISTOR				2SB624-T2B BV3	G3206247C		1-	B	c2
Q 4012	TRANSISTOR				2SC4154-T111-1E	G3341548E		1-88	B	f1
Q 4012	TRANSISTOR				2SC4081 T106	G3340818		89-	B	f1
Q 4013	TRANSISTOR				2SB1182-TLQ	G3070063		1-	B	f2
R 4001	CHIP RES.	10k	1/16W	5%	RMC1/16S 103JTH	J24189037		1-	B	g2
R 4002	CHIP RES.	47k	1/16W	5%	RMC1/16S 473JTH	J24189045		1-	B	g2
R 4003	CHIP RES.	10k	1/16W	5%	RMC1/16S 103JTH	J24189037		1-	B	g2
R 4004	CHIP RES.	47k	1/16W	5%	RMC1/16S 473JTH	J24189045		1-	B	g2
R 4005	CHIP RES.	10k	1/16W	5%	RMC1/16S 103JTH	J24189037		1-	B	c2
R 4006	CHIP RES.	10k	1/16W	5%	RMC1/16S 103JTH	J24189037		1-	B	c2
R 4007	CHIP RES.	1k	1/16W	5%	RMC1/16S 102JTH	J24189025		1-	B	c2
R 4008	CHIP RES.	1k	1/16W	5%	RMC1/16S 102JTH	J24189025		1-	B	c2
R 4009	CHIP RES.	1k	1/16W	5%	RMC1/16S 102JTH	J24189025		1-	B	c2
R 4010	CHIP RES.	100k	1/16W	5%	RMC1/16S 104JTH	J24189049		1-	B	c2
R 4011	CHIP RES.	4.7k	1/16W	5%	RMC1/16S 472JTH	J24189033		1-	B	c2
R 4012	CHIP RES.	0	1/16W	5%	RMC1/16 000JATP	J24185000		1-	B	a2
R 4013	CHIP RES.	0	1/16W	5%	RMC1/16 000JATP	J24185000		1-	B	a2
R 4014	CHIP RES.	1k	1/16W	5%	RMC1/16S 102JTH	J24189025		1-	B	e1
R 4015	CHIP RES.	1k	1/16W	5%	RMC1/16S 102JTH	J24189025		1-	B	e1
R 4016	CHIP RES.	1k	1/16W	5%	RMC1/16S 102JTH	J24189025		1-	B	e1
R 4017	CHIP RES.	1k	1/16W	5%	RMC1/16S 102JTH	J24189025		1-	B	e1
R 4018	CHIP RES.	100	1/4W	5%	RMC1/4 101JATP	J24245101		1-	B	a1
R 4019	CHIP RES.	100	1/4W	5%	RMC1/4 101JATP	J24245101		1-	A	G1
R 4020	CHIP RES.	10k	1/16W	5%	RMC1/16S 103JTH	J24189037		1-	B	d1
R 4022	CHIP RES.	100k	1/16W	5%	RMC1/16S 104JTH	J24189049		1-	B	d2
R 4023	CHIP RES.	100k	1/16W	5%	RMC1/16S 104JTH	J24189049		1-	B	d1
R 4024	CHIP RES.	47k	1/16W	0.5%	RR0510R-473-D	J24189159		1-	B	d1
R 4025	CHIP RES.	39k	1/16W	5%	RMC1/16S 393JTH	J24189044		1-	B	d1
R 4026	CHIP RES.	82k	1/16W	5%	RMC1/16S 823JTH	J24189048		1-	B	d1
R 4027	CHIP RES.	39k	1/16W	5%	RMC1/16S 393JTH	J24189044		1-	B	d1
R 4028	CHIP RES.	22k	1/16W	5%	RMC1/16S 223JTH	J24189041		1-	B	d1
R 4029	CHIP RES.	10k	1/16W	5%	RMC1/16S 103JTH	J24189037		1-	B	d1
R 4030	CHIP RES.	560	1/10W	5%	RMC1/10T 561J	J24205561		1-	B	c1

PANEL Unit

Parts List

REF	DESCRIPTION	VALUE	V/W	TOL.	MFR'S DESIG	VXSTD P/N	VERS.	LOT	SIDE	LAY ADR
R 4031	CHIP RES.	470	1/10W	5%	RMC1/10T 471J	J24205471		1-	B	b1
R 4032	CHIP RES.	270	1/10W	5%	RMC1/10T 271J	J24205271		1-	B	b1
R 4033	CHIP RES.	4.7k	1/16W	5%	RMC1/16S 472JTH	J24189033		1-	B	f2
R 4034	CHIP RES.	4.7k	1/16W	5%	RMC1/16S 472JTH	J24189033		1-	B	g2
R 4035	CHIP RES.	4.7k	1/16W	5%	RMC1/16S 472JTH	J24189033		1-	B	f2
R 4036	CHIP RES.	330k	1/16W	5%	RMC1/16S 334JTH	J24189055		1-	B	e2
R 4037	CHIP RES.	4.7k	1/16W	5%	RMC1/16S 472JTH	J24189033		1-	B	d1
R 4038	CHIP RES.	4.7k	1/16W	5%	RMC1/16S 472JTH	J24189033		1-	B	d1
R 4040	CHIP RES.	100	1/16W	5%	RMC1/16S 101JTH	J24189013		1-	B	e1
R 4041	CHIP RES.	680k	1/16W	5%	RMC1/16S 684JTH	J24189059		1-25	A	C2
R 4041	CHIP RES.	560k	1/16W	0.5%	MCR01MZPD5603	J24189335		26-	A	C2
R 4042	CHIP RES.	330k	1/16W	5%	RMC1/16S 334JTH	J24189055		1-25	B	e2
R 4042	CHIP RES.	220k	1/16W	0.5%	MCR01MZPD2203	J24189389		26-	B	e2
R 4043	CHIP RES.	1M	1/16W	5%	RMC1/16S 105JTH	J24189061		1-	A	D2
R 4044	CHIP RES.	10k	1/16W	5%	RMC1/16S 103JTH	J24189037		1-	B	d2
R 4045	CHIP RES.	22k	1/16W	5%	RMC1/16S 223JTH	J24189041		1-	B	d2
R 4046	CHIP RES.	39k	1/16W	5%	RMC1/16S 393JTH	J24189044		1-	B	d2
R 4047	CHIP RES.	82k	1/16W	5%	RMC1/16S 823JTH	J24189048		1-	B	d2
R 4048	CHIP RES.	10k	1/16W	5%	RMC1/16S 103JTH	J24189037		1-	B	d2
R 4049	CHIP RES.	22k	1/16W	5%	RMC1/16S 223JTH	J24189041		1-	B	d2
R 4050	CHIP RES.	39k	1/16W	5%	RMC1/16S 393JTH	J24189044		1-	B	d2
R 4051	CHIP RES.	39k	1/16W	5%	RMC1/16S 393JTH	J24189044		1-	B	d2
R 4052	CHIP RES.	39k	1/16W	5%	RMC1/16S 393JTH	J24189044		1-	B	d2
R 4053	CHIP RES.	82k	1/16W	5%	RMC1/16S 823JTH	J24189048		1-	B	d2
R 4054	CHIP RES.	3.3k	1/10W	5%	RMC1/10T 332J	J24205332		1-	B	c1
R 4055	CHIP RES.	180	1/10W	5%	RMC1/10T 181J	J24205181		1-	B	c1
R 4056	CHIP RES.	15	1/4W	5%	RMC1/4 150JATP	J24245150		1-	B	b1
R 4057	CHIP RES.	100	1/10W	5%	RMC1/10T 101J	J24205101		1-	B	c1
R 4058	CHIP RES.	100	1/10W	5%	RMC1/10T 101J	J24205101		1-	B	b1
R 4059	CHIP RES.	180	1/10W	5%	RMC1/10T 181J	J24205181		1-	B	c1
R 4060	CHIP RES.	15	1/4W	5%	RMC1/4 150JATP	J24245150		1-	B	b1
R 4061	CHIP RES.	100	1/10W	5%	RMC1/10T 101J	J24205101		1-	B	c1
R 4062	CHIP RES.	3.3k	1/10W	5%	RMC1/10T 332J	J24205332		1-	B	c1
R 4063	CHIP RES.	47	1/4W	5%	RMC1/4 470JATP	J24245470		1-	B	c1
R 4064	CHIP RES.	47	1/4W	5%	RMC1/4 470JATP	J24245470		1-	B	c1
R 4065	CHIP RES.	100	1/10W	5%	RMC1/10T 101J	J24205101		1-	B	b1
R 4066	CHIP RES.	180	1/10W	5%	RMC1/10T 181J	J24205181		1-	B	c2
R 4067	CHIP RES.	15	1/4W	5%	RMC1/4 150JATP	J24245150		1-	B	b2
R 4068	CHIP RES.	100	1/10W	5%	RMC1/10T 101J	J24205101		1-	B	c2
R 4069	CHIP RES.	100	1/10W	5%	RMC1/10T 101J	J24205101		1-	B	b2
R 4070	CHIP RES.	4.7k	1/10W	5%	RMC1/10T 472J	J24205472		1-	B	c2
R 4071	CHIP RES.	47	1/4W	5%	RMC1/4 470JATP	J24245470		1-	B	c2
R 4072	CHIP RES.	680	1/10W	5%	RMC1/10T 681J	J24205681		1-	B	f1
R 4073	CHIP RES.	680	1/10W	5%	RMC1/10T 681J	J24205681		1-	B	f2
R 4074	CHIP RES.	1.2k	1/10W	5%	RMC1/10T 122J	J24205122		1-	B	e1
R 4075	CHIP RES.	3.3k	1/16W	5%	RMC1/16S 332JTH	J24189031		1-	B	f1
R 4076	CHIP RES.	180	1/16W	5%	RMC1/16S 181JTH	J24189016		1-	B	f1
R 4077	CHIP RES.	220	1/4W	5%	RMC1/4 221JATP	J24245221		1-	B	g2
R 4078	CHIP RES.	1.2k	1/10W	5%	RMC1/10T 122J	J24205122		1-	B	c1
R 4079	CHIP RES.	1.2k	1/10W	5%	RMC1/10T 122J	J24205122		1-	B	a1
R 4080	CHIP RES.	1.2k	1/10W	5%	RMC1/10T 122J	J24205122		1-	B	a1
R 4082	CHIP RES.	4.7k	1/16W	5%	RMC1/16S 472JTH	J24189033		1-	B	d2
R 4083	CHIP RES.	100k	1/16W	5%	RMC1/16S 104JTH	J24189049		1-	B	e1
R 4084	CHIP RES.	10k	1/16W	5%	RMC1/16S 103JTH	J24189037		1-	B	g2
R 4086	CHIP RES.	33k	1/16W	5%	RMC1/16S 333JTH	J24189043		1-	B	e2
S 4001	ROTARY ENCODER				EC12E24244A4	Q9000796		1-	A	A2
S 4002	SLIDE SWITCH				SSSS22	N6090057		1-	B	a1
S 4003	TACT SWITCH				SKQTLA	N5090110		1-	A	E1
S 4004	TACT SWITCH				SKQTLA	N5090110		1-	A	C1
S 4005	TACT SWITCH				SKQTLA	N5090110		1-	A	G1
S 4006	TACT SWITCH				SKQDAA	N5090051		1-	A	B1
S 4007	TACT SWITCH				SKQDAA	N5090051		1-	A	D2
S 4008	TACT SWITCH				SKQDAA	N5090051		1-	A	B1
S 4009	TACT SWITCH				SKQDAA	N5090051		1-	A	C2
S 4010	TACT SWITCH				SKQDAA	N5090051		1-	A	E2
S 4011	TACT SWITCH				SKQDAA	N5090051		1-	A	B2
S 4012	TACT SWITCH				SKQTLA	N5090110		1-	A	D1
S 4013	TACT SWITCH				SKQTLA	N5090110		1-	A	G1
S 4014	TACT SWITCH				SKQTLA	N5090110		1-	A	H1
S 4015	TACT SWITCH				SKQTLA	N5090110		1-	A	H2
S 4016	TACT SWITCH				SKQTLA	N5090110		1-	A	D1
S 4017	ROTARY ENCODER				RES20D50-201-1G	Q9000709A		1-	B	
TH4002	THERMISTOR				TBPS1R223K460H5Q	G9090085		1-	B	e2

PANEL Unit

Parts List

REF	DESCRIPTION	VALUE	V/W	TOL.	MFR'S DESIG	VXSTD P/N	VERS.	LOT	SIDE	LAY ADR
VR4001	POT.	100k			EVN-5ESX50B15	J51811104		1-	B	e2
X 4001	XTAL TSS-7050A	9.91MHz			9.91MHZ	H0103276		1-	B	e1
	LIGHT GUIDE				(LCD)	RA0451000		1-		
	LCD HOLDER					RA0450900		1-		
	REFLECTOR SHEET					RA0452400		1-		
	DIFFUSER SHEET					RA0452500		1-		
	SHEET				(LCD)	RA0481000		1-		
	SPACER				(LCD)	RA0481900		1-		
	SPONGE RUBBER				(TX)	RA0484900		1-		
	LIGHT SHEET				(A)	RA0485300		1-		
	LIGHT SHEET				(B)	RA0485400		1-		
	SHIELD SHEET				(DSP)	RA0460300		3-		

REF Unit

Circuit Diagram

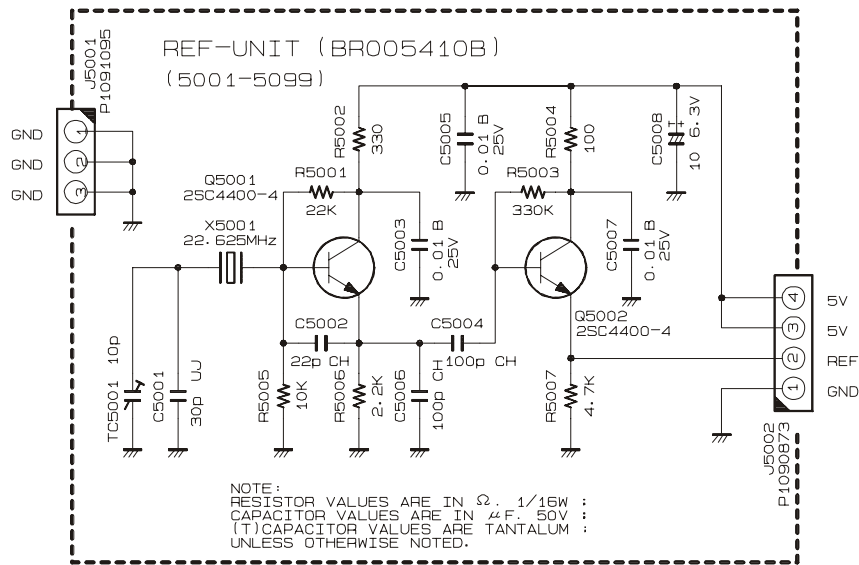

Parts Layout

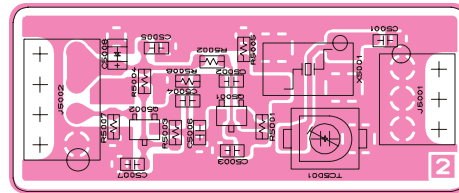
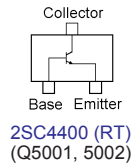

Side A



Side B

Parts List

REF	DESCRIPTION	VALUE	V/W	TOL.	MFR'S DESIG	VXSTD P/N	VERS.	LOT	SIDE	LAY ADR
PCB with Components						CB1232001				
Printed Circuit Board						FR0054100			1-	
C 5001	CHIP CAP.	27pF	50V	CH	GRM39CH270J50PT	K22174221		1-		
C 5002	CHIP CAP.	22pF	50V	CH	GRM39CH220J50PT	K22174219		1-		
C 5003	CHIP CAP.	0.01uF	50V	B	GRM39B103M50PT	K22174823		1-		
C 5004	CHIP CAP.	100pF	50V	CH	GRM39CH101J50PT	K22174235		1-		
C 5005	CHIP CAP.	0.01uF	50V	B	GRM39B103M50PT	K22174823		1-		
C 5006	CHIP CAP.	100pF	50V	CH	GRM39CH101J50PT	K22174235		1-		
C 5007	CHIP CAP.	0.01uF	50V	B	GRM39B103M50PT	K22174823		1-		
C 5008	CHIP TA.CAP.	10uF	6.3V		TESVSP0J106M-8R	K78080055		1-		
J 5001	CONNECTOR				9117S-03D	P1091095		1-		
J 5002	CONNECTOR				9117S-04D	P1090873		1-		
Q 5001	TRANSISTOR				2SC4400-4-TL	G3344008D		1-		
Q 5002	TRANSISTOR				2SC4400-4-TL	G3344008D		1-		
R 5001	CHIP RES.	22k	1/16W	5%	RMC1/16 223JATP	J24185223		1-		
R 5002	CHIP RES.	330	1/16W	5%	RMC1/16 331JATP	J24185331		1-		
R 5003	CHIP RES.	330k	1/16W	5%	RMC1/16 334JATP	J24185334		1-		
R 5004	CHIP RES.	100	1/16W	5%	RMC1/16 101JATP	J24185101		1-		
R 5005	CHIP RES.	10k	1/16W	5%	RMC1/16 103JATP	J24185103		1-		
R 5006	CHIP RES.	2.2k	1/16W	5%	RMC1/16 222JATP	J24185222		1-		
R 5007	CHIP RES.	4.7k	1/16W	5%	RMC1/16 472JATP	J24185472		1-		
TC5001	TRIMMER CAP.	20pF			ECR-JA020E11X	K91000228		1-		
X 5001	XTAL TSS-6035B				22.625MHZ	H0103273		1-		

PHONE-JACK Unit

Circuit Diagram

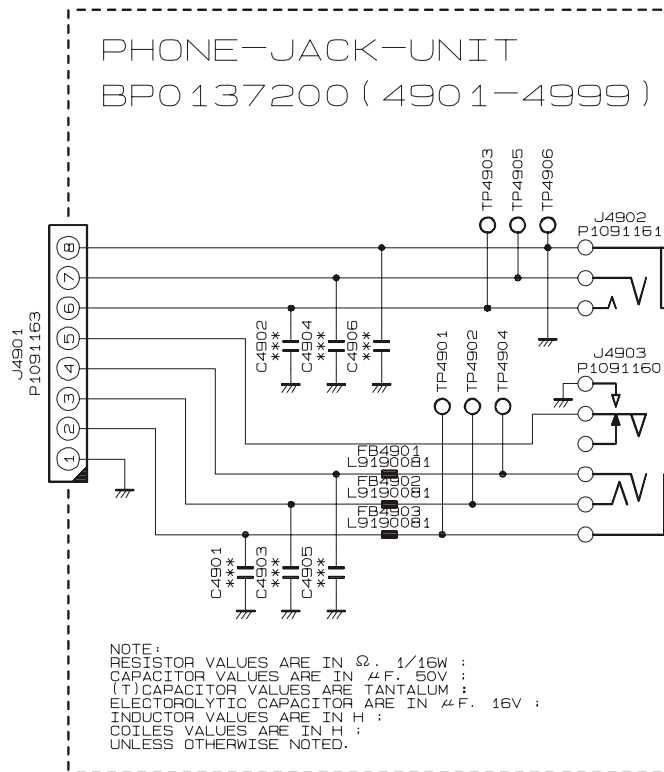

Parts Layout

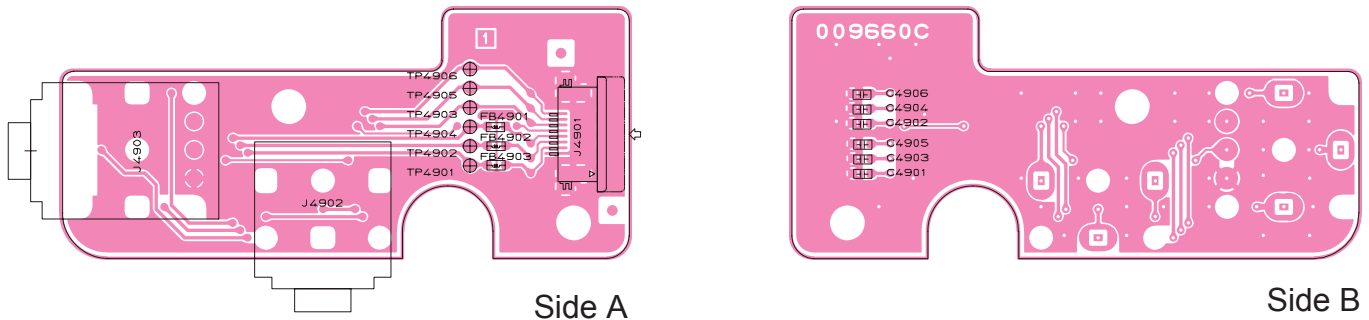

Parts List

REF	DESCRIPTION	VALUE	V/W	TOL.	MFR'S DESIG	VXSTD P/N	VERS.	LOT	SIDE	LAY ADR
	PCB with Components					CB2331001				
	Printed Circuit Board				AH007M000	FR0096600		1-		
FB4901	FERRITE BEADS				BK1608HS121-T	L9190081		1-		
FB4902	FERRITE BEADS				BK1608HS121-T	L9190081		1-		
FB4903	FERRITE BEADS				BK1608HS121-T	L9190081		1-		
J 4901	CONNECTOR				52746-0890	P1091163		1-		
J 4902	CONNECTOR				HSJ7062-01-440	P1091161		1-		
J 4903	CONNECTOR				HSJ7063-01-440	P1091160		1-		
P 4901	WIRE ASSY				AH007M	T9207025		1-		

VR Unit

Circuit Diagram

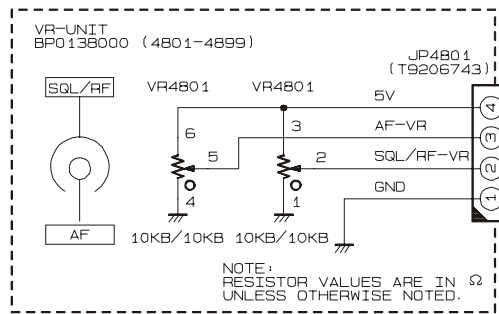

Parts Layout

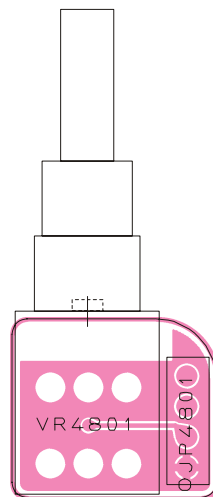

Side A

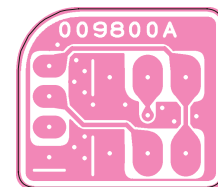

Side B

Parts List

REF	DESCRIPTION	VALUE	VW	TOL.	MFR'S DESIG	VXSTD P/N	VERS.	LOT	SIDE	LAY ADR
	PCB with Components					CB2339001				
	Printed Circuit Board				AH007M000	FR0098000				
VR4801	POT.				RK0972210 10KB/10KB	J62800141		1-	A	

CONNECTOR Unit

Circuit Diagram

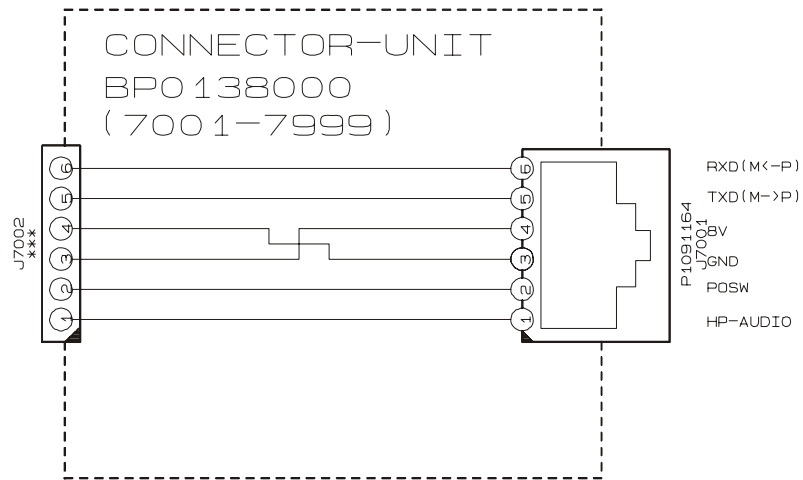

Parts Layout

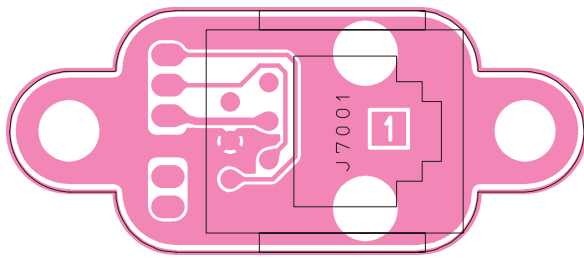

Side A

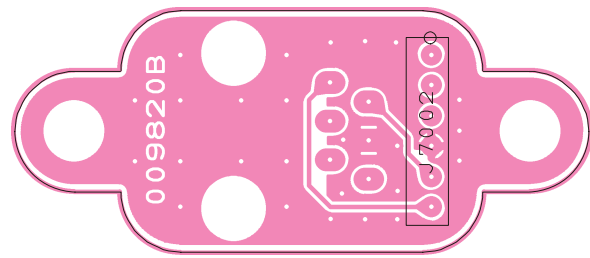

Side B

Parts List

REF	DESCRIPTION	VALUE	V/W	TOL.	MFR'S DESIG	VXSTD P/N	VERS.	LOT	SIDE	LAY ADR
	PCB with Components					CB2338001				
	Printed Circuit Board				AH007M000	FR009820B		1-		
J 7001	CONNECTOR				HJC0278-010022	P1091164		1-		
J 7002	WIRE ASSY				AH007M	T9207023		1-		

DSP-2 Unit (FT-857 Option)

Circuit Diagram

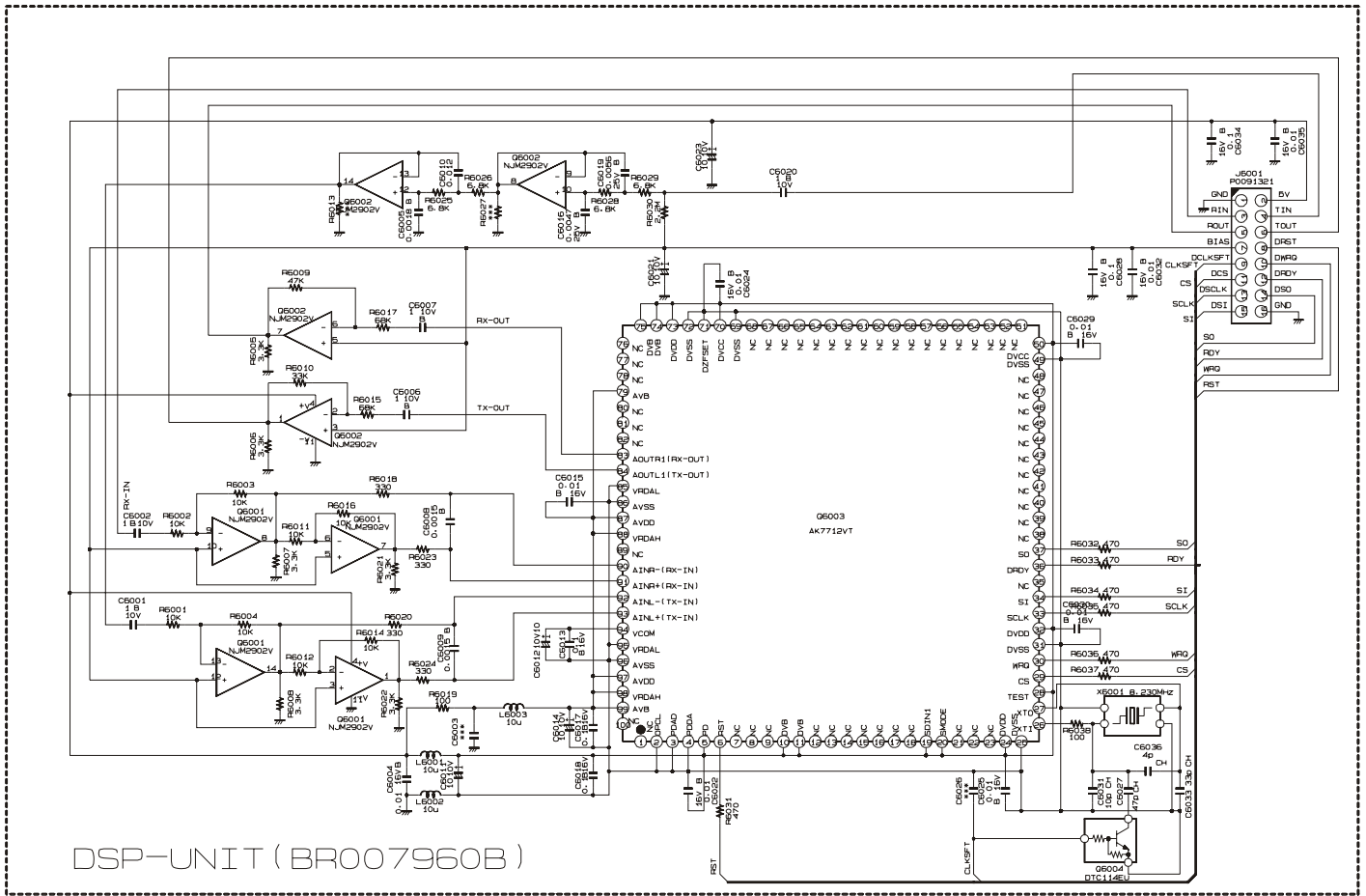

Parts Layout

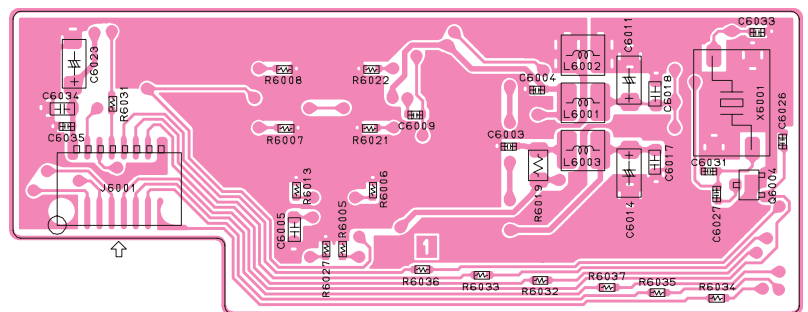
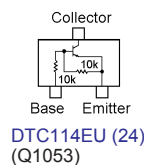
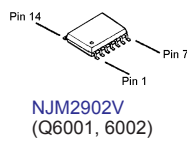
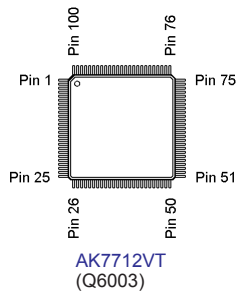

Side A

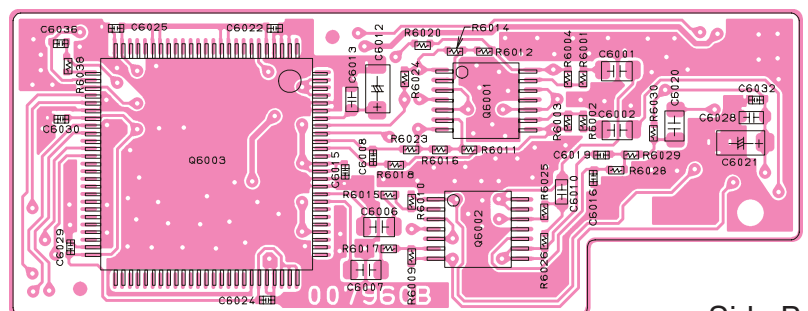

Side B

DSP-2 Unit (FT-857 Option)

Parts List

REF	DESCRIPTION	VALUE	V/W	TOL.	MFR'S DESIG	VXSTD P/N	VERS.	LOT	SIDE	LAY ADR
	Printed Circuit Board				AAC62X000	FR0079600		1-		
C 6001	CHIP CAP.	1uF	10V	B	GRM40B105K10PT	K22100802		1-	B	
C 6002	CHIP CAP.	1uF	10V	B	GRM40B105K10PT	K22100802		1-	B	
C 6004	CHIP CAP.	0.01uF	16V	B	GRM36B103K16PT	K22128804		1-	A	
C 6005	CHIP CAP.	0.0018uF	50V	B	GRM39B182M50PT	K22174812		1-	A	
C 6006	CHIP CAP.	1uF	10V	B	GRM40B105K10PT	K22100802		1-	B	
C 6007	CHIP CAP.	1uF	10V	B	GRM40B105K10PT	K22100802		1-	B	
C 6008	CHIP CAP.	0.0015uF	50V	B	GRM36B152K50PT	K22178811		1-	B	
C 6009	CHIP CAP.	0.0015uF	50V	B	GRM36B152K50PT	K22178811		1-	A	
C 6010	CHIP CAP.	0.012uF	50V	B	GRM39B123K50PT	K22174825		1-	B	
C 6011	CHIP TA.CAP.	10uF	10V		TEMSVA1A106M-8R	K78100028		1-	B	
C 6012	CHIP TA.CAP.	10uF	10V		TEMSVA1A106M-8R	K78100028		1-	A	
C 6013	CHIP CAP.	0.1uF	16V	B	GRM39B104K16PT	K22124805		1-	B	
C 6014	CHIP TA.CAP.	10uF	10V		TEMSVA1A106M-8R	K78100028		1-	A	
C 6015	CHIP CAP.	0.01uF	16V	B	GRM36B103K16PT	K22128804		1-	B	
C 6016	CHIP CAP.	0.0047uF	25V	B	GRM36B472K25PT	K22148830		1-	B	
C 6017	CHIP CAP.	0.1uF	16V	B	GRM39B104K16PT	K22124805		1-	A	
C 6018	CHIP CAP.	0.1uF	16V	B	GRM39B104K16PT	K22124805		1-	A	
C 6019	CHIP CAP.	0.0056uF	25V	B	GRM36B562K50PT	K22148802		1-	B	
C 6020	CHIP CAP.	1uF	10V	B	GRM40B105K10PT	K22100802		1-	B	
C 6021	CHIP TA.CAP.	10uF	10V		TEMSVA1A106M-8R	K78100028		1-	B	
C 6022	CHIP CAP.	0.01uF	16V	B	GRM36B103K16PT	K22128804		1-	B	
C 6023	CHIP TA.CAP.	10uF	10V		TEMSVA1A106M-8R	K78100028		1-	A	
C 6024	CHIP CAP.	0.01uF	16V	B	GRM36B103K16PT	K22128804		1-	B	
C 6025	CHIP CAP.	0.01uF	16V	B	GRM36B103K16PT	K22128804		1-	B	
C 6027	CHIP CAP.	47pF	50V	CH	GRM36CH470J50PT	K22178228		1-	A	
C 6028	CHIP CAP.	0.1uF	16V	B	GRM39B104K16PT	K22124805		1-	B	
C 6029	CHIP CAP.	0.01uF	16V	B	GRM36B103K16PT	K22128804		1-	B	
C 6030	CHIP CAP.	0.01uF	16V	B	GRM36B103K16PT	K22128804		1-	B	
C 6031	CHIP CAP.	10pF	50V	CH	GRM36CH100D50PT	K22178212		1-	A	
C 6032	CHIP CAP.	0.01uF	16V	B	GRM36B103K16PT	K22128804		1-	B	
C 6033	CHIP CAP.	33pF	50V	CH	GRM36CH330J50PT	K22178224		1-	A	
C 6034	CHIP CAP.	0.1uF	16V	B	GRM39B104K16PT	K22124805		1-	A	
C 6035	CHIP CAP.	0.01uF	16V	B	GRM36B103K16PT	K22128804		1-	A	
C 6036	CHIP CAP.	4pF	50V	CH	GRM36CH040C50PT	K22178206		1-	B	
J 6001	CONNECTOR				IL-WX-16PB-HF-B-E1000	P0091321		1-	A	
L 6001	CHIP COIL	10uH			C2520F-100K	L1690596		1-	A	
L 6002	CHIP COIL	10uH			C2520F-100K	L1690596		1-	A	
L 6003	CHIP COIL	10uH			C2520F-100K	L1690596		1-	A	
Q 6001	IC				NJM2902V-TE1	G1091679		1-	B	
Q 6002	IC				NJM2902V-TE1	G1091679		1-	B	
Q 6003	IC				AK7712VT	G1092699		1-	B	
Q 6004	TRANSISTOR				DTC114EU T106	G3070084		1-	A	
R 6001	CHIP RES.	10k	1/16W	5%	RMC1/16S 103JTH	J24189037		1-	B	
R 6002	CHIP RES.	10k	1/16W	5%	RMC1/16S 103JTH	J24189037		1-	B	
R 6003	CHIP RES.	10k	1/16W	5%	RMC1/16S 103JTH	J24189037		1-	B	
R 6004	CHIP RES.	10k	1/16W	5%	RMC1/16S 103JTH	J24189037		1-	B	
R 6005	CHIP RES.	3.3k	1/16W	5%	RMC1/16S 332JTH	J24189031		1-	A	
R 6006	CHIP RES.	3.3k	1/16W	5%	RMC1/16S 332JTH	J24189031		1-	A	
R 6007	CHIP RES.	3.3k	1/16W	5%	RMC1/16S 332JTH	J24189031		1-	A	
R 6008	CHIP RES.	3.3k	1/16W	5%	RMC1/16S 332JTH	J24189031		1-	A	
R 6009	CHIP RES.	47k	1/16W	5%	RMC1/16S 473JTH	J24189045		1-	B	
R 6010	CHIP RES.	33k	1/16W	5%	RMC1/16S 333JTH	J24189043		1-	B	
R 6011	CHIP RES.	10k	1/16W	5%	RMC1/16S 103JTH	J24189037		1-	B	
R 6012	CHIP RES.	10k	1/16W	5%	RMC1/16S 103JTH	J24189037		1-	B	
R 6014	CHIP RES.	10k	1/16W	5%	RMC1/16S 103JTH	J24189037		1-	B	
R 6015	CHIP RES.	68k	1/16W	5%	RMC1/16S 683JTH	J24189047		1-	B	
R 6016	CHIP RES.	10k	1/16W	5%	RMC1/16S 103JTH	J24189037		1-	B	
R 6017	CHIP RES.	68k	1/16W	5%	RMC1/16S 683JTH	J24189047		1-	B	
R 6018	CHIP RES.	330	1/16W	5%	RMC1/16S 331JTH	J24189019		1-	B	
R 6019	CHIP RES.	100	1/10W	5%	RMC1/10T 101J	J24205101		1-	A	
R 6020	CHIP RES.	330	1/16W	5%	RMC1/16S 331JTH	J24189019		1-	B	
R 6021	CHIP RES.	3.3k	1/16W	5%	RMC1/16S 332JTH	J24189031		1-	A	
R 6022	CHIP RES.	3.3k	1/16W	5%	RMC1/16S 332JTH	J24189031		1-	A	
R 6023	CHIP RES.	330	1/16W	5%	RMC1/16S 331JTH	J24189019		1-	B	
R 6024	CHIP RES.	330	1/16W	5%	RMC1/16S 331JTH	J24189019		1-	B	
R 6025	CHIP RES.	6.8k	1/16W	5%	RMC1/16S 682JTH	J24189035		1-	B	
R 6026	CHIP RES.	6.8k	1/16W	5%	RMC1/16S 682JTH	J24189035		1-	B	
R 6028	CHIP RES.	6.8k	1/16W	5%	RMC1/16S 682JTH	J24189035		1-	B	
R 6029	CHIP RES.	6.8k	1/16W	5%	RMC1/16S 682JTH	J24189035		1-	B	
R 6030	CHIP RES.	2.2M	1/16W	5%	RMC1/16S 225JTH	J24189065		1-	B	
R 6031	CHIP RES.	470	1/16W	5%	RMC1/16S 471JTH	J24189021		1-	A	
R 6032	CHIP RES.	470	1/16W	5%	RMC1/16S 471JTH	J24189021		1-	A	

DSP-2 Unit (FT-857 Option)

Parts List

REF	DESCRIPTION	VALUE	V/W	TOL.	MFR'S DESIG	VXSTD P/N	VERS.	LOT	SIDE	LAY ADR
R 6033	CHIP RES.	470	1/16W	5%	RMC1/16S 471JTH	J24189021		1-	A	
R 6034	CHIP RES.	470	1/16W	5%	RMC1/16S 471JTH	J24189021		1-	A	
R 6035	CHIP RES.	470	1/16W	5%	RMC1/16S 471JTH	J24189021		1-	A	
R 6036	CHIP RES.	470	1/16W	5%	RMC1/16S 471JTH	J24189021		1-	A	
R 6037	CHIP RES.	470	1/16W	5%	RMC1/16S 471JTH	J24189021		1-	A	
R 6038	CHIP RES.	100	1/16W	5%	RMC1/16S 101JTH	J24189013		1-	B	
X 6001	XTAL TSS-7050A	8.23MHz			8.230MHZ	H0103261		1-	A	

TCXO-9 Unit (Option)

Circuit Diagram

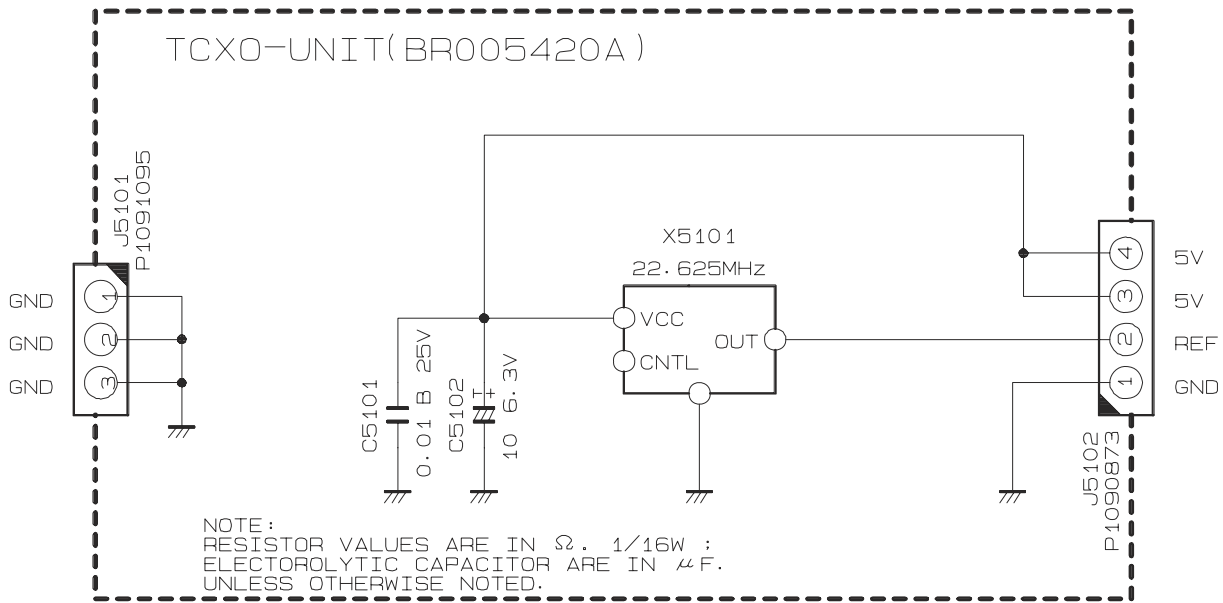

Parts Layout

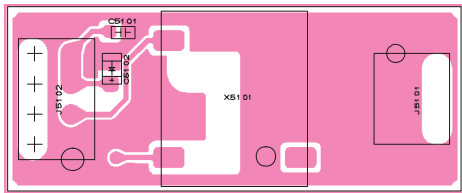

Side A

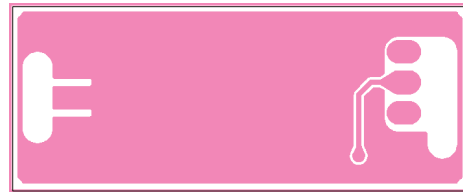

Side B

Parts List

REF	DESCRIPTION	VALUE	V/W	TOL.	MFR'S DESIG	VXSTD P/N	VERS.	LOT	SIDE	LAY ADR
	Printed Circuit Board					FR005860C		1-		
C 5101	CHIP CAP.	0.01uF	25V	B	GRM39B103K25PT	K22144803		1-		
C 5102	CHIP TA.CAP.	10uF	6.3V		TESVSP0J106M-8R	K78080055		1-		
J 5101	CONNECTOR				9117S-03D	P1091095		1-		
J 5102	CONNECTOR				9117S-04D	P1090873		1-		
X 5101	XTAL OSC	22.625MHZ			NT0-801BS 22.625MHZ	H9500560		1-		



Copyright 2008
VERTEX STANDARD CO., LTD.
All rights reserved

No portion of this manual
may be reproduced without
the permission of
VERTEX STANDARD CO., LTD.