

# YAESU

## FT-847

HF & V/UHF Band Transceiver

### Technical Supplement

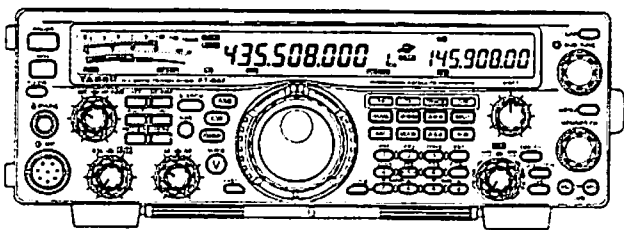

**YAESU MUSEN CO., LTD.**

1-20-2 Shimomaruko, Ota-Ku, Tokyo 146-8649, Japan

**YAESU U.S.A.**

17210 Edwards Rd., Cerritos, CA 90703, U.S.A.

**YAESU INTERNATIONAL DIVISION**, (Caribbean, Mexico, Central & So. America)

7270 NW 12th St., Suite 320, Miami, FL 33126, U.S.A.

**YAESU EUROPE B.V.**

Snipweg 3, 1118DN Schiphol, The Netherlands

**YAESU UK LTD.**

Unit 2, Maple Grove Business Centre,

Lawrence Rd., Hounslow, Middlesex, TW4 6DR, U.K.

**YAESU GERMANY GmbH**

Am Kronberger Hang 2, D-65824 Schwalbach, Germany

**YAESU HK LTD.**

11th Floor Tsim Sha Tsui Centre, 66 Mody Rd.,

Tsim Sha Tsui East, Kowloon, Hong Kong

# Contents

<i>Introduction</i> .....	1-1
<i>Specifications</i> .....	1-2
<i>Chip Component Information</i> .....	1-3
<i>Mechanical Details (Exploded Views &amp; Mechanical Parts)</i> .....	2-1
<i>Alignment</i> .....	3-1
<i>Block &amp; Interconnection Diagrams</i> .....	4-1
<i>PCB Diagrams &amp; Parts List</i>	
AF-CNTL Unit .....	5A-1
PLL Unit .....	5B-1
RF Unit .....	5C-1
V/U-PA Unit .....	5D-1
PA Unit .....	5E-1
DSP Unit .....	5F-1
Panel Unit .....	5G-1
SSB-Filter Unit .....	5H-1
Phone-Jack Unit .....	5 I-1
Mic Unit .....	5 J-1

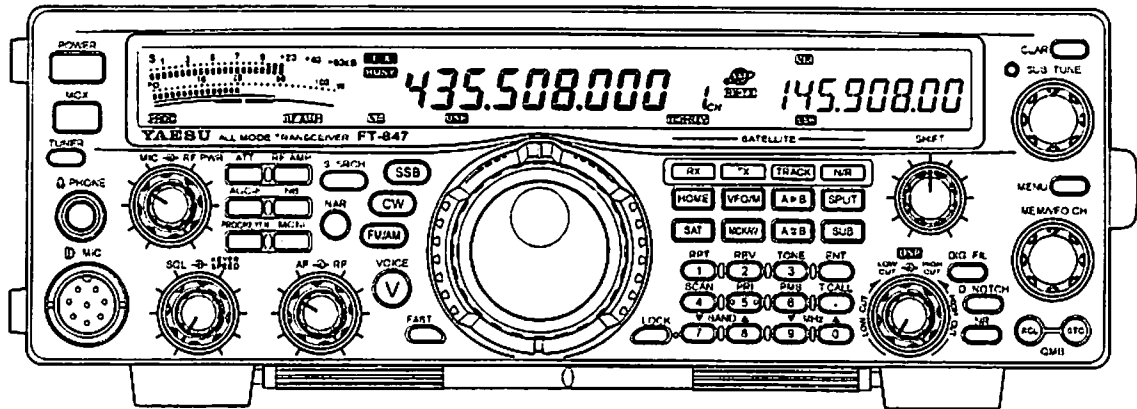

This manual provides technical information necessary for servicing the Yaesu FT-847 HF & V/UHF-Band Transceiver. It does not include information on installation and operation, which are described in the FT-847 Operating Manual provided with the transceiver, or on accessories which are described in their manuals.

The FT-847 is carefully designed to allow the knowledgeable operator to make nearly all adjustments required for various station conditions, modes and operator preferences simply from the controls on the panels, without opening the case of the transceiver. The FT-847 Operating Manual describes these adjustments, plus certain internal settings.

Servicing this equipment requires expertise in handling surface mount chip components. Attempts by unqualified persons to service this equipment may result in permanent damage not

covered by warranty. For the major circuit boards, each side of the board is identified by the type of the majority of components installed on that side. In most cases one side has only chip components, and the other has either a mixture of both chip and lead components (trimmers, coils, electrolytic capacitors, packaged ICs, etc.), or lead components only.

While we believe the technical information in this manual is correct, Yaesu assumes no liability for damage that may occur as a result of typographical or other errors that may be present. Your cooperation in pointing out any inconsistencies in the technical information would be appreciated. Yaesu Musen reserves the right to make changes in this transceiver and the alignment procedures, in the interest of technological improvement, without notification of owners.

# Specifications

## General

Frequency range:	160 ~ 6m amateur bands only, 144 ~ 146 or 148, 430 ~ 440 or 450 MHz
TX1	100.00 kHz ~ 75.999999 MHz, 108 ~ 174 MHz, 420 ~ 512 MHz
RX	
Frequency Stability:	< 2 ppm (0 ~ 40 °C, except FM) < 5 ppm (-10 ~ 50 °C, except FM)
Frequency Accuracy:	< 5ppm (FM < ± 1 kHz)
Operating Temperature Range:	-10 °C ~ 50 °C
Emission Modes:	LSB, USB, CW, FSK, AM, FM
Frequency Step:	Minimum 0.1 Hz for SSB and CW, Minimum 10 Hz for AM and FM
Antenna Impedance:	50-Ω unbalanced
Power Consumption (Approx.):	RX (no signal) 1.5 A, RX (signal) 2.0 A, TX (100 W) 22 A
Supply voltage:	DC 13.8 V ± 10 %
Dimensions (W×H×D):	260 × 86 × 270 mm
Weight (Approx.):	7 kg

## Transmitter

Power output:	Adjustable up to 100 W (1.8 ~ 29.7 MHz and 50 MHz, 25 W AM carrier) Adjustable up to 50 W (144 MHz and 430 MHz, 12.5 W AM carrier)
Modulation Types:	SSB: J3E Balanced, filtered carrier AM: A3E Low-level (early stage) FM: F3E Variable reactance AFSK: J1D, J2D, Audio frequency shift keying
Maximum FM Deviation:	± 2.5 kHz (narrow), ± 5kHz (wide)
FSK Shift Frequency:	170, 425 and 850 Hz
Harmonic Radiation:	at least 50 dB below peak output (1.8 ~ 29.7 MHz) at least 70 dB below peak output (50 MHz) at least 60 dB below peak output (144/430 MHz)
SSB Carrier Suppression:	at least 40 dB below peak output
Undesired Side band Suppression:	at least 40 dB below peak output
3rd-order IMD:	-31 dB or better (100 W PEP, 14 MHz)
Audio Response (SSB):	not more than -6 dB from 400 to 2600 Hz
Microphone Impedance:	200 ~ 10 kΩ

## Receiver

Circuit type:	Double-conversion Superheterodyne
Intermediate Frequencies:	45.705 MHz and 455 kHz

Sensitivity:

	100 ~ 500 kHz	0.5 ~ 1.8 MHz	1.8 ~ 30 MHz	50 ~ 54 MHz	144/430 MHz
SSB	-	-	0.25 μV	0.2 μV	0.125 μV
AM	-	10 μV	1 μV	0.5 μV	-
FM	-	-	0.5 μV (29 MHz)	0.25 μV	0.2 μV

Selectivity (-6 dB/-60dB):

SSB, CW:	2.2 kHz/4.5 kHz
CW narrow:	500 Hz/2.0 kHz (w/ optional CW filter YF-115C)
AM:	9 kHz/20 kHz
AM narrow:	2.2 kHz/4.5 kHz
FM:	15 kHz/30 kHz
FM narrow:	9 kHz/20 kHz

Squelch Sensitivity:

< 20 μV	(SSB, CW, AM 0.5 ~ 1.8 MHz)
< 2 μV	(SSB, CW, AM 1.8 ~ 30 MHz)
< 1 μV	(SSB, CW, AM 50 ~ 54 MHz)
< 0.5 μV	(SSB, CW, AM 144/430 MHz)
< 0.25 μV	(FM 29 MHz)
< 0.2 μV	(FM 50 ~ 54 MHz)
< 0.16 μV	(FM 144/430 MHz)

IF Rejection:

more than 60 dB

Image Rejection:

more than 60 dB

Maximum Audio output:

1.5 W (@ 8 Ω, 13.8 V, 5 % THD)

Audio output Impedance:

4 ~ 16 Ω (8 Ω typical)



# Chip Component Information

The diagrams below indicate some of the distinguishing features of common chip components.

## Capacitors

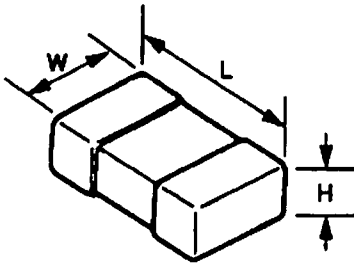

(Unit: mm)

Type	L	W	H
2125	2.0	1.25	0.35 ~ 0.5
1608	1.6	0.8	0.65 ~ 0.95
1005	1.0	0.5	0.45 ~ 0.55

## Tantalum Capacitors

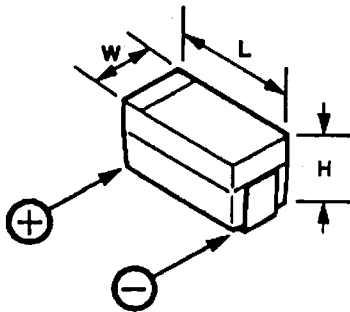

(Unit: mm)

Type	L	W	H
P	2.0	1.25	1.2
A	3.2	1.6	1.6
B	3.4	2.8	1.9
C	5.8	3.2	2.3

## Resistors

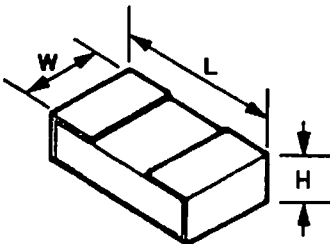

Indicated Letters

**1 2 3 4 5 6 7 8 9 0 .**

(Unit: mm)

Type	L	W	H
1/10	2.0	1.25	0.5
1/16	1.6	0.8	0.45
1/16S	1.0	0.5	0.35

Marking\* 100, 222, 473...

473

Tens	Ones	Multiplier
0	0	10 <sup>0</sup>
1	1	10 <sup>1</sup>
2	2	10 <sup>2</sup>
3	3	10 <sup>3</sup>
4	4	10 <sup>4</sup>
5	5	10 <sup>5</sup>
6	6	10 <sup>6</sup>
7	7	10 <sup>7</sup>
8	8	10 <sup>8</sup>
9	9	10 <sup>9</sup>

Examples: 100=10Ω  
222=2.2kΩ  
473=47kΩ

# Chip Component Information

---

## Replacing Chip Components

Chip components are installed at the factory by a series of robots. The first one places a small spot of adhesive resin at the location where each part is to be installed, and later robots handle and place parts using vacuum suction.

For single sided boards, solder paste is applied and the board is then baked to harden the resin and flow the solder. For double sided boards, no solder paste is applied, but the board is baked (or exposed to ultra-violet light) to cure the resin before dip soldering.

In our laboratories and service shops, small quantities of chip components are mounted manually by applying a spot of resin, placing the components with tweezers, and then soldering by very small dual streams of hot air (without physical contact during soldering). We remove parts by first removing solder using a vacuum suction iron, which applies a light steady vacuum at the iron tip, and then breaking the adhesive with tweezers.

Special vacuum/desoldering equipment is recommended if you expect to do a lot of chip replacements. Otherwise, it is usually possible to remove and replace chip components with only a tapered, temperature-controlled soldering iron, a set of tweezers and braided copper solder wick. Soldering iron temperature should be below 280°C (536°F).

## Precautions for Chip Replacement

- Do not disconnect a chip forcefully, or the foil pattern may peel off the board.
- Never re-use a chip component. Dispose of all removed chip components immediately to avoid mixing with new parts.
- Limit soldering time to 3 seconds or less to avoid damaging the component and board.

## Removing Chip Components

- Remove the solder at each joint, one joint at a time, using solder wick whetted with non-acidic fluxes as shown below. Avoid applying pressure, and do not attempt to remove tinning from the chip's electrode.

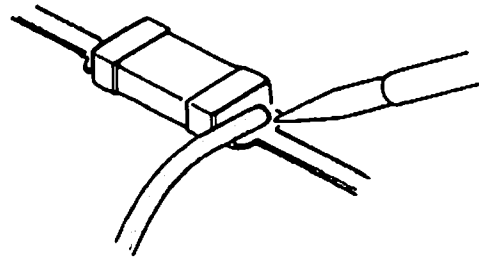

- Grasp the chip on both sides with tweezers, and gently twist the tweezers back and forth (to break the adhesive bond) while alternately heating each electrode. Be careful to avoid peeling the foil traces from the board. Dispose of the chip when removed.
- After removing the chip, use the copper braid and soldering iron to wick away any excess solder and smooth the land for installation of the replacement part.

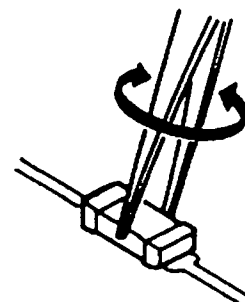

---

# Chip Component Information

## *Installing a Replacement Chip*

As the value of some chip components is not indicated on the body of the chip, be careful to get the right part for replacement.

- Apply a small amount of solder to the land on one side where the chip is to be installed. Avoid too much solder, which may cause bridging (shorting to other parts).

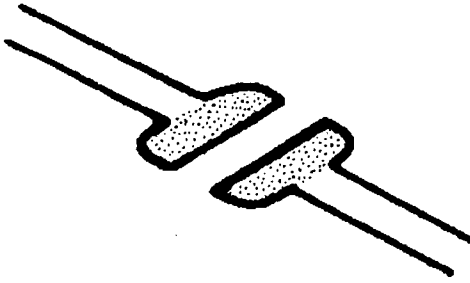

- Hold the chip with tweezers in the desired position, and apply the soldering iron with a motion line as indicated by the arrow in the diagram below. Do not apply heat for more than 3 seconds.

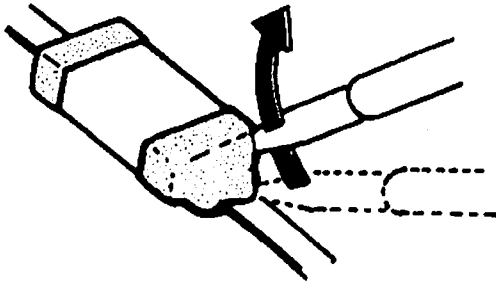

- Remove the tweezers and solder the electrode on the other side in the manner just described.

# Chip Component Information

---

*Notes:*

# Exploded View & Miscellaneous Parts

REF	Description	YAESU PIN	Qty
①	PAN HEAD SCREW M2.6x6	U00206001	4
②	PAN HEAD SCREW M3x8	U00308001	14
③	PAN HEAD SCREW M3x30	U00330001	4
④	PAN HEAD SCREW M4x6B	U00406007	2
⑤	SEMS SCREW ASM3x6	U03308001	8
⑥	BINDING HEAD SCREW M2x4B	U20104007	1
⑦	BINDING HEAD SCREW M3x6	U20306001	3
⑧	TAPTITE SCREW M3x6	U24306001	63
⑨	TAPTITE SCREW M3x8	U24308001	9
⑩	OVAL HEAD SCREW M4x6B	U31406007	2
⑪	OVAL HEAD SCREW M4x10B	U31410007	4
⑫	OVAL HEAD SCREW M4x16B	U31416007	2
⑬	TAPTITE SCREW M3x6	U34308001	4
⑭	TAPTITE SCREW M3x6	U44306001	8
⑮	TOOTHED LOCK WASHER OW4NI	U72004002	1
⑯	HEX HEAD BOLT HSM4x16NI	U9900076	1
⑰	BINDING HEAD SCREW M3x18	U20318001	4

Non-designated parts are available only as part of a designated assembly.

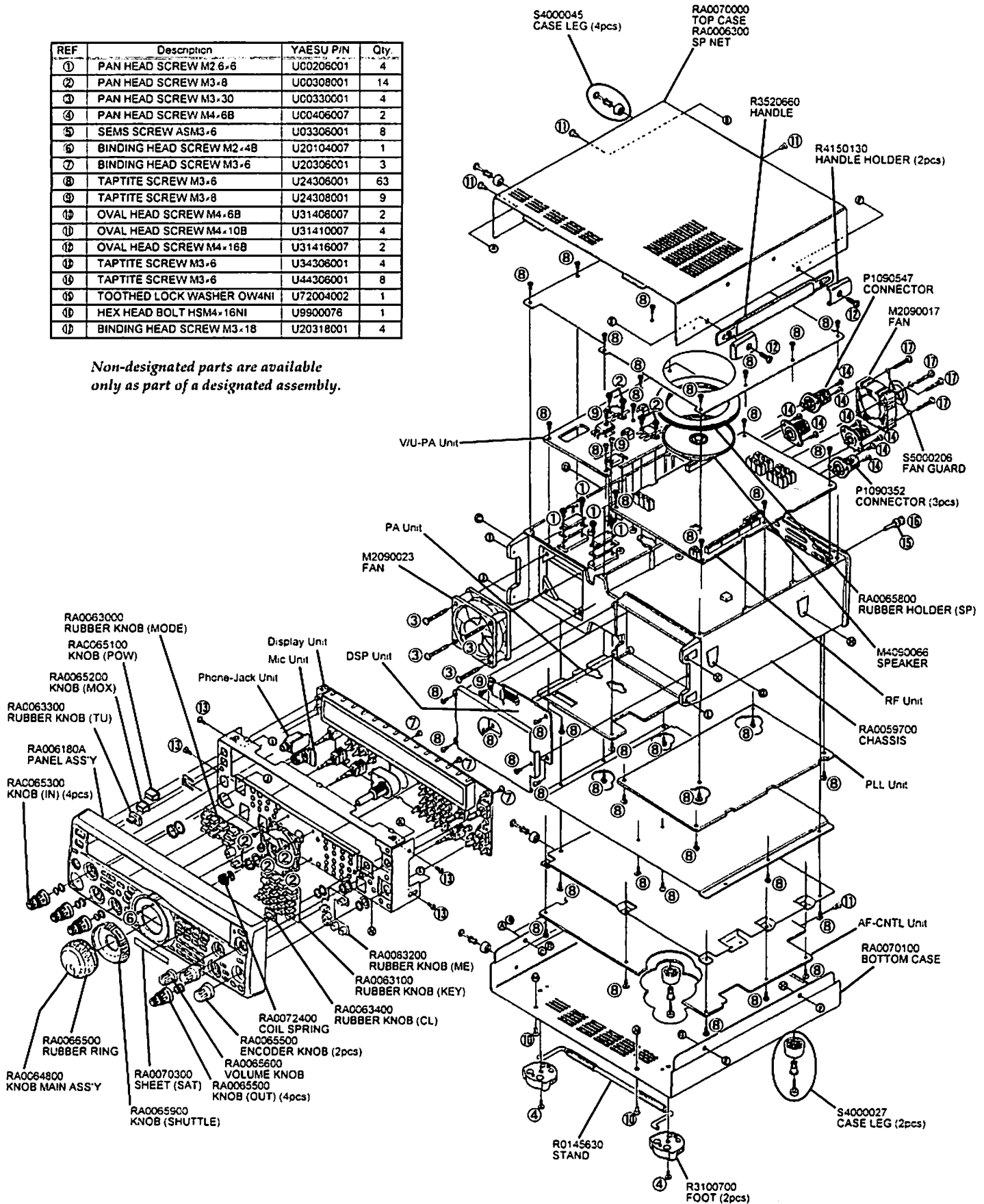

# Exploded View & Miscellaneous Parts

REF.	DESCRIPTION	VALUE	V/W	TOL.	MFR'S DESIG	YAESU P/N	VERS.	LOT.
*** MAIN ASSY ***								
C 0001	AL.ELECTRO.CAP.	100uF	16V		RE3-16V101M 100UF	K40129063		
F 0951	BLADE FUSE	25A			1025-0000-00	Q0000074		
FN0001	FAN				A0512 DC12V	M2090017		
FN0002	FAN				JF0625S1M-050 DC12V	M2090023		
J 0001	CONNECTOR				FM-MDR-MI	P1090352		
J 0002	CONNECTOR				FM-MDR-MI	P1090352		
J 0003	CONNECTOR				FM-MDR-MI	P1090352		
J 0004	CONNECTOR				020-0291	P1090547		
P 0001	WIRE ASSY				A1179	T9206718		
P 0002	WIRE ASSY				A1179	T9206702		
P 0003	WIRE ASSY				A1179	T9206703		
P 0004	WIRE ASSY				A1179	T9206704		
P 0005	WIRE ASSY				A1179	T9206705		
P 0005	WIRE ASSY				A1179	T9206705A		2-
P 0006	WIRE ASSY				A1179	T9206706		
P 0006	WIRE ASSY				A1179	T9206706A		2-
P 0007	WIRE ASSY				RED 280/400 V5.5	T9318054		
P 0008	WIRE ASSY				BLK 280/360 V5.5	T9318055		
P 0009	WIRE ASSY				GRA 280 TMP/TMP	T9311201		
P 0010	WIRE ASSY				A1179	T9206707		
P 0011	WIRE ASSY				A1179	T9206708		
P 0012	WIRE ASSY				A1179	T9206710A		
P 0013	WIRE ASSY				A1179	T9206709A		
P 0014	WIRE ASSY				A1179	T9206711		
P 0015	WIRE ASSY				A1179	T9206712		
P 0016	WIRE ASSY				BRN 330 TMP/TMP	T9318041		
P 0017	WIRE ASSY				YEL 210 TMP/TMP	T9318042		
P 0018	WIRE ASSY				BLK 340 TMP/TMP	T9318043		
P 0018	WIRE ASSY				BLK 360 TMP/TMP	T9318056		2-
P 0019	WIRE ASSY				ORG 200 TMP/TMP	T9318044		
P 0020	WIRE ASSY				A1179	T9206713		
P 0021	WIRE ASSY				A1179	T9206714		
P 0022	WIRE ASSY				BLK 60 TMP/TMP	T9318045		
P 0022	WIRE ASSY				RED 60 TMP/TMP	T9318059		2-
P 0023	WIRE ASSY				ORG 120 TMP/TMP	T9318046		
P 0023	WIRE ASSY				GRN 110 TMP/TMP	T9318060		2-
P 0024	WIRE ASSY				BLK 140 TMP/TMP	T9318047		
P 0024	WIRE ASSY				YEL 140 TMP/TMP	T9318061		2-
P 0025	WIRE ASSY				ORG 150 TMP/TMP	T9318048		
P 0025	WIRE ASSY				GRA 150 TMP/'	T9318065		2-
P 0026	WIRE ASSY				A1179	T9206715		
P 0027	WIRE ASSY				GRN 500 TMP/TMP	T9318049		
P 0028	WIRE ASSY				RED 290 TMP/TMP	T9311404		
P 0028	WIRE ASSY				RED 310 TMP/TMP	T9318058		2-
P 0029	WIRE ASSY				A1179	T9206716		
P 0030	WIRE ASSY				A1179	T9206717		
P 0951	DC CABLE					T9019925		
S 0001	ROTARY ENCODER				RSM20-250	Q9000631		
S 0002	ROTARY SWITCH				SRGPVJ-E	N0190173		
SP0001	SPEAKER	8-ohm			VS-66Y 3W/8 OHM	M4090066		

## *Introduction and Precautions*

The following procedures cover adjustments that are not normally required once the transceiver has left the factory. However, if damage occurs and some parts subsequently are replaced, realignment may be required. If a sudden problem occurs during normal operation, it is likely due to component failure; realignment should not be done until after the faulty component has been replaced.

We recommend that servicing be performed by authorized Yaesu service technicians, who are experienced with the circuitry and fully equipped for repair and alignment. If a fault is suspected, contact the selling dealer for instructions regarding repair. Authorized Yaesu service technicians have the latest modification information, and realign all circuits and make complete performance checks to ensure compliance with the factory specifications after repairs.

Those who do undertake any of the following alignments are cautioned to proceed at their own risk. Problems caused by unauthorized attempts at realignment are not covered by the warranty policy. Also, Yaesu must reserve the right to change circuits and alignment procedures in the interest of improved performance, without notifying owners. Under no circumstances should any alignment be attempted unless the normal function and operation of the transceiver are clearly understood, the cause of the malfunction has been clearly pinpointed and any faulty components replaced, and the need for realignment determined to be absolutely necessary.

The following test equipment (and thorough familiarity with its correct use) is necessary for complete realignment. Correction of problems caused by misalignment resulting from unauthorized adjustments made with improper test equipment is not covered by warranty. Although

most steps do not require all of the equipment listed, the interaction of some adjustments may require that more complex adjustments be performed afterwards. Do not attempt to perform only a single step unless it is clearly isolated electrically from all other steps. Rather, have all test equipment ready before beginning, and follow all of the steps in a section in the order they are presented.

## *Required Test Equipment*

- Digital DC Voltmeter (high-Z, 1 M $\Omega$ /V)
- DC Ammeter
- RF Millivoltmeter
- AC Voltmeter
- RF Standard Signal Generator w/ calibrated output and dB scale, 0 dB $\mu$  = 0.5  $\mu$ V
- AF Signal Generator with calibrated output
- Frequency Counter
- Two 50- $\Omega$  Dummy Loads (150 ~ 250 watts)
- 150- $\Omega$  Dummy Load (150 watts)
- In-Line Wattmeter (150 ~ 250 watts, 50- $\Omega$ )
- Linear Detector
- RF Attenuator (150 watts, 40 dB) or sampling coupler

## *Alignment Preparation & Precautions*

A 50- $\Omega$  dummy load and in-line wattmeter must be connected to the antenna jack in all procedures that call for transmission, except where specified otherwise. Correct alignment is not possible with an antenna. Except where specified otherwise, the transceiver should be tuned to 14.2000 MHz, USB mode, and these controls set as indicated:

- **MOX, PROC/KEYER, MONI OFF**
- **MIC & RF PWR** fully CCW
- **ATT, RF AMP, AGC-F, NB OFF**
- **AF** as required
- **SQL** fully CCW
- **SHIFT** 12-o'clock

# Alignment

- **LOW CUT** fully CCW
- **HIGH CUT, RF GAIN** fully CW

The transceiver's Alignment Routine is required for some procedures. If an Alignment Routine cannot be selected, power may have to be switched off then back on to re-enable menu selection.

To begin, turn the transceiver off. Press the **UP**, **DWN** and **FAST** keys on the microphone together while turning the transceiver on again.

In the alignment procedure, each alignment parameter is selected by rotating the **SUB-TUNE** dial. The alignment is performed by pressing the **MCK/W** key while injecting a signal of the required frequency and level.

Pressing the **MENU** key after a setting is made stores the entry. To exit the alignment routine, press **POWER**. After performing the system alignment in its entirety, individual settings can be returned to and adjusted should the need arise.

Read each step to determine if the same test equipment used in the previous step will be required. If not, remove the test equipment (except dummy load and wattmeter, if connected) before proceeding. Correct alignment requires that the ambient temperature be the same as that of the transceiver and test equipment, and that this temperature be held constant within 20 ~ 30°C (68 ~ 86°F). If the transceiver is brought into the shop from hot or cold air, it should be allowed time for thermal equalization with the environment before alignment. Alignments must only be made with oscillator shields and circuit boards firmly affixed in place. Also, the test equipment must be thoroughly warmed up before beginning.

*Note: Signal levels in dB referred to in alignment are based on 0 dBμ = 0.5 μV.*

*Table Note: DC voltages should be within ±10 % of those listed in the voltage tables.*

## PLL Adjustments

### HF-VCO VCV adjustment

- Connect the DC voltmeter to the TP2001, and referring to table below, tune the transceiver to each frequency, then confirm or adjust the listed component for the required voltage.

HF VCO Adjustment		
Tune to:	Adjust/Confirm	for
10.495 MHz	adjust T2001	6.5V±0.1V
0.100 MHz	confirm	at least 0.5V
21.995 MHz	adjust T2002	6.5V±0.1V
10.500 MHz	confirm	at least 0.5V
36.995 MHz	adjust T2003	6.5V±0.1V
22.000 MHz	confirm	at least 0.5V
53.995 MHz	adjust T2004	6.5V±0.1V
37.000 MHz	confirm	at least 0.5V
75.995 MHz	adjust T2005	6.5V±0.1V
54.000 MHz	confirm	at least 0.5V

### VHF-VCO VCV check

- Connect the DC voltmeter to the TP2002, and referring to table below, tune the transceiver to each frequency, then confirm that the required voltage is present.

VHF VCO check	
Tune to:	for
108.000 MHz	at least 0.5V
139.995 MHz	less than 6.5V
140.000 MHz	at least 0.5V
173.995 MHz	less than 6.5V

### UHF-VCO VCV check

- Connect the DC voltmeter to the TP2003, and referring to table below, tune the transceiver to each frequency. Confirm that the required voltage is present.

UHF VCO check	
Tune to:	for
420.000 MHz	at least 0.5V
469.995 MHz	less than 6.5V
470.000 MHz	at least 0.5V
511.995 MHz	less than 6.5V



## PA Unit Adjustments (HF)

### Pre-drive section Idling Current Adjustment

- Connect the 50  $\Omega$  dummy load to the HF antenna jack, and remove the jumper connector J5006. Connect the ammeter to J5006 (pin 1 "+" lead, pin 2 "-" lead). Tune the transceiver to 14.005 MHz, and select the CW mode.
- Press the **MOX** switch, and without closing the Key line, adjust VR5001 for 0.25 A ( $\pm 0.025$  A) on the ammeter. Then remove the ammeter and reinstall the jumper connector J5006.

### Drive section Idling Current Adjustment

- Connect the 50  $\Omega$  dummy load to the HF antenna jack, and remove the jumper connector J5007. Connect the ammeter to J5007 (pin 1 "+" lead, pin 2 "-" lead). Tune the transceiver to 14.005 MHz, and select the CW mode.
- Press the **MOX** switch, and without closing the Key line, adjust VR5002 for 1.5 A ( $\pm 0.15$  A) on the ammeter. Then remove the ammeter and reinstall the jumper connector J5007.

### Final section Idling Current Adjustment

- Connect the 50  $\Omega$  dummy load to the HF antenna jack, and remove the jumper between TP5001 and TP5002. Connect the ammeter between TP5001 ("+" lead) and TP5002 ("- lead). Tune the transceiver to 14.005 MHz, and select the CW mode.
- Press the **MOX** switch, and without closing the Key line, adjust VR5003 for 0.26 A ( $\pm 0.025$  A) on the ammeter. Then remove the ammeter and reinstall the jumper between TP5001 and TP5002.

### CM coupler balance

- Tune the transceiver to 53.995 MHz, and connect the 50  $\Omega$  dummy load to the **50MHz** antenna jack. Preset the **RF PWR** control fully clockwise and select the FM mode. Connect the DC voltmeter between J5001's pin 1 and

chassis ground.

- Key the transmitter, and with no microphone input, adjust TC5001 for minimum indication on the DC voltmeter.

## V/U-PA Unit Adjustments

### VHF-PA section Idling Current Adjustment

- Tune the transceiver to 145.995 MHz, and select the CW mode. Connect the 50  $\Omega$  dummy load to the **144MHz** antenna jack. Remove the jumper between TP4001 and TP4002, and connect the ammeter between TP4001 ("- lead) and TP4002 ("+" lead).
- Press the **MOX** switch, and without closing the Key line, adjust VR4002 for 0.3 A ( $\pm 0.03$  A) on the ammeter. Then remove the ammeter and reinstall the jumper between TP4001 and TP4002.

### UHF-PA section Idling Current Adjustment

- Tune the transceiver to 439.995 MHz, and select the CW mode. Connect the 50  $\Omega$  dummy load to the **430MHz** antenna jack. Remove the jumper between TP4003 and TP4004, and connect the ammeter between TP4003 ("- lead) and TP4004 ("+" lead).
- Press the **MOX** switch, and without closing the Key line, adjust VR4001 for 0.3 A ( $\pm 0.03$  A) on the ammeter. Then remove the ammeter and reinstall the jumper between TP4003 and TP4004.

## TX and RX IF Adjustments

### Reference Output Adjustment

- Connect the RF millivoltmeter to TP1002, and adjust T1010 and T1007 for maximum indication on the RF millivoltmeter.
- Replace the RF millivoltmeter with the frequency counter, and adjust TC1001 for 45.250 MHz ( $\pm 10$  Hz) on the frequency counter.
- Remove the coaxial plug from J1002 and connect the RF millivoltmeter across the socket. Adjust T1003 for maximum indication on the RF millivoltmeter.

# Alignment

---

- ❑ Remove the RF millivoltmeter, and replace the plug into J1002.

## *TX Local Adjustment*

- ❑ Connect the 50  $\Omega$  dummy load to the HF antenna jack and connect the DC voltmeter to TP1003. Select the CW mode.
- ❑ Key the transmitter, and adjust T1009 for 4.0 V ( $\pm 0.2$  V) on the DC voltmeter.

## *TX DDS Adjustment*

- ❑ Connect the RF millivoltmeter to TP1004, and adjust T1020 for maximum indication on the RF millivoltmeter.

## *RX DDS Adjustment*

- ❑ Connect the RF millivoltmeter to TP1005, and adjust T1021 for maximum indication on the RF millivoltmeter.

## *FM IF Adjustment*

- ❑ Connect the 50  $\Omega$  dummy load to the HF antenna jack and connect the RF millivoltmeter to TP1005. Select the FM mode.
- ❑ Key the transmitter, and adjust T1012 ~ T1014 for maximum indication on the RF millivoltmeter.
- ❑ Replace the RF millivoltmeter with the frequency counter. Key the transmitter, and adjust T1016 for 45.580 MHz ( $\pm 100$  Hz) on the frequency counter.

## *Carrier Frequency Adjustment*

- ❑ Remove the coaxial plug from J1003 and connect the frequency counter across the socket. Select the CW mode.
- ❑ Key the transmitter, and adjust TC1002 for 45.580 MHz ( $\pm 10$  Hz) on the frequency counter.
- ❑ Replace the frequency counter with the RF millivoltmeter, and key the transmitter, and adjust T1002 for maximum indication on the RF millivoltmeter.
- ❑ Remove the RF millivoltmeter, and replace the

plug into J1002.

## *RX IF Sensitivity*

- ❑ Preset the RF control fully clockwise. Remove the coaxial plug from J1001 and connect the signal generator across the socket, and inject 0 dBm at 45.705 MHz (no modulation). Connect the DC voltmeter to TP1048.
- ❑ Adjust T1005, T1008, T1015, and T1017 ~ T1019 for minimum indication on the DC voltmeter.
- ❑ Remove the signal generator, and replace the plug into J1001.

## *Noise Blanker Adjustment*

- ❑ Remove the coaxial plug from J1001 and connect the signal generator across the socket, and connect the DC voltmeter to TP1049. Inject a signal at 45.705 MHz (no modulation) so as to get a reading on the DC voltmeter.
- ❑ Adjust T1004 and T1006 for minimum indication on the DC voltmeter. Increase the signal generator level, if necessary, to maintain a useful DC voltage indication.
- ❑ Remove the signal generator, and replace the plug into J1001.

## *TX and RX Adjustments*

### *VHF RX IF Sensitivity*

- ❑ Connect the signal generator to the **144MHz** antenna jack, and connect the SINAD meter and 4  $\Omega$  dummy load to the **EXT SPKR** jack. Tune the transceiver to 145.995 MHz, and select the FM mode. Preset the RF control fully clockwise and the **SQL** control fully counter-clockwise.
- ❑ Inject a signal from the signal generator at 145.995 MHz ( $\pm 3.5$  kHz deviation of a 1 kHz tone), adjust the level to get a moderate SINAD reading on the meter, and adjust T3006, T3012, T3014, T3017, T3027, T3029, and T3031 for optimum SINAD.
- ❑ Connect the DC voltmeter to TP1048 and chassis ground, and select the CW mode.

- Inject a signal at 145.995 MHz so as to get a reading on the DC voltmeter, and adjust T3006, T3012, T3014, T3017, and T3031 for minimum indication on the DC voltmeter.
- Now inject a signal at 129.995 MHz, and tune the transceiver to 129.995 MHz. Adjust T3007, T3011, T3015, and T3018 for minimum indication on the DC voltmeter.

### 50 MHz RX IF Sensitivity

- Connect the signal generator to the **50MHz** antenna jack, and connect the DC voltmeter between TP1048 and chassis ground. Tune the transceiver to 53.995 MHz, and select the CW mode. Preset the **RF** control fully clockwise and the **SQL** control fully counter-clockwise.
- Inject a signal at 53.995 MHz so as to get deflection on the DC voltmeter, and adjust T3019, T3021, T3025, and T3028 for minimum indication on the DC voltmeter.

### 144 MHz TX Adjustment

- With the inline wattmeter and 50  $\Omega$  dummy load connected to the **144MHz** antenna jack, connect the AF generator to the **MIC** jack (pin 8: mic input, pin 7: ground). Tune the transceiver to 145.995 MHz, and select the USB mode.
- Inject a 1 kHz tone at 3 mV level to the **MIC** jack. Key the transmitter, and adjust T1002 on the AF-CNTL Unit and T3005, T3008, and T3010 on the RF Unit in succession several times for maximum indication on the inline wattmeter.
- Select the FM mode. Key the transmitter, and adjust TC4002 for maximum indication on the inline wattmeter.
- Connect the DC voltmeter between pin 3 of J4007 and chassis ground. Key the transmitter, and adjust VR4004 for minimum indication on the DC voltmeter.
- Select the FM mode. Key the transmitter, and adjust VR3003 for 50 W on the inline wattmeter.

### 430 MHz TX Adjustment

- With the inline wattmeter and 50  $\Omega$  dummy load connected to the **430MHz** antenna jack, and connect the AF generator to the **MIC** jack (pin 8: mic input, pin 7: ground). Tune the transceiver to 439.995 MHz, and select the USB mode.
- Inject a 1 kHz tone at 3 mV level to the **MIC** jack. Key the transmitter, and adjust TC3001, TC3003, and TC3004 in succession several times for maximum indication on the inline wattmeter.
- Select the FM mode. Key the transmitter, and adjust TC4001, TC4003, and TC4005 in succession several times for maximum indication on the inline wattmeter.
- Connect the DC voltmeter between pin 3 of J4007 and chassis ground.
- Key the transmitter, and adjust VR4002 for minimum indication on the DC voltmeter.
- Select the FM mode. Key the transmitter, and adjust VR3002 for 50 W on the inline wattmeter.

### 50 MHz TX Adjustment

- With the inline wattmeter and 50  $\Omega$  dummy load connected to the **50MHz** antenna jack, connect the AF generator to the **MIC** jack. Tune the transceiver to 50.005 MHz, and select the USB mode.
- Inject a signal from the AF generator at 1 kHz tone. Key the transmitter, adjust the audio level so as to produce power output that can be read on the external wattmeter, and then adjust T3003, T3009, T3013, and T3016 in succession several times for maximum indication on the external wattmeter.
- Tune the transceiver to 52.005 MHz, and select the FM mode. Key the transmitter, and adjust VR3004 for 100 W on the external wattmeter.

### HF TX Adjustment

- With the inline wattmeter and 50  $\Omega$  dummy load connected to the **HF** antenna jack, tune

# Alignment

---

the transceiver to 3.505 MHz, and select the FM mode.

- Key the transmitter, and adjust VR3006 for 100 W on the inline wattmeter.
- Tune the transceiver to 1.900 MHz, and select the FM mode. Key the transmitter, and adjust VR3005 for 100 W on the inline wattmeter.

## *AFP adjustment*

- Preset VR3007, VR3008, and VR3009 fully clockwise, and connect the ammeter between the transceiver's **13.8VDC** connector and the DC power supply.
- Tune the transceiver to 145.995 MHz and select the CW mode (with no connection to the **144MHz** antenna jack). Key the transmitter, and adjust VR1001 for 8.0 A on the ammeter.
- Tune the transceiver to 439.995 MHz and select the CW mode (with no connection to the **430MHz** antenna jack). Key the transmitter, and confirm the current on the ammeter. If over 8.0 A on the ammeter, adjust VR1001 for 8.0 A on the ammeter. If under 8.0 A on the ammeter, adjust VR3007 for 8.0 A on the ammeter.
- Connect the 150  $\Omega$  dummy load (or three 50  $\Omega$  loads in parallel) to the **HF** antenna jack. Tune the transceiver to 14.005 MHz and select the CW mode. Key the transmitter, and confirm the current on the ammeter. If over 15.0 A ( $\pm 0.1$  A) on the ammeter, adjust VR1001 for 15.0 A ( $\pm 0.1$  A) on the ammeter. If under 15.0 A ( $\pm 0.1$  A) on the ammeter, adjust VR3008 for 15.0 A ( $\pm 0.1$  A) on the ammeter.

## *TX and RX Adjustments*

### *(Alignment Menu Adjustments)*

#### *144 MHz Band FM-S1 Adjustment*

- Connect the signal generator to the **144MHz** antenna jack, and tune the transceiver to 145.995 MHz. Select the FM mode.

- Select alignment menu [FM-S1], and inject a 0 dB $\mu$  signal ( $\pm 3.5$  kHz deviation of a 1 kHz tone). Then press the **MCK/W** key.

#### *144 MHz Band FM-Full Scale Adjustment*

- Connect the signal generator to the **144MHz** antenna jack, and tune the transceiver to 145.995 MHz. Select the FM mode.
- Select alignment menu [FM-FULL], and inject a +25.0 dB $\mu$  signal ( $\pm 3.5$  kHz deviation of a 1 kHz tone). Then press the **MCK/W** key.

#### *144 MHz Band Scan Discriminator*

##### *Center-Stop Adjustment*

- Connect the signal generator to the **144MHz** antenna jack, and tune the transceiver to 145.995 MHz. Select the FM mode.
- Select alignment menu [DISC-L], and inject a signal at 145.992 MHz, level +25.0 dB $\mu$  ( $\pm 3.5$  kHz deviation of a 1 kHz tone). Then press the **MCK/W** key.
- Select alignment menu [DISC-H], and inject a signal at 145.998 MHz, level +25.0 dB $\mu$  ( $\pm 3.5$  kHz deviation of a 1 kHz tone). Then press the **MCK/W** key.

#### *144 MHz Band SQL Threshold Adjustment*

- Tune the transceiver to 145.995 MHz, and the select FM mode.
- Select alignment menu [SQL-TH-L], and inject no RF input. Then press the **MCK/W** key.
- Press the **A $\blacktriangleright$ B** key ([SQL-TH-H] will appear on the display), and apply no RF input. Then press the **MCK/W** key.

#### *144 MHz Band SQL Tight Adjustment*

- Connect the signal generator to the **144MHz** antenna jack, and tune the transceiver to 145.995 MHz. Select the FM mode.
- Select alignment menu [SQL-TI-L], and inject a signal at 145.995 MHz, level +3.0 dB $\mu$  ( $\pm 3.5$  kHz deviation of a 1 kHz tone). Then press the **MCK/W** key.

- Press the **A↔B** key ([SQL-TI-H] display), and inject a signal at 145.995 MHz, level +3.0 dB $\mu$  ( $\pm 3.5$  kHz deviation of a 1 kHz tone). Then press the **MCK/W** key.

## 144 MHz Band SSB-S1 Adjustment

- Select alignment menu [SSB-S1], and tune the transceiver to 145.995 MHz. Select the CW mode, preset the **RF** control to the 2-o'clock position, and inject no RF input. Then press the **MCK/W** key.

## 144 MHz Band SSB-S9 Adjustment

- Connect the signal generator to the **144MHz** antenna jack, and tune the transceiver to 145.995 MHz.
- Select alignment menu [SSB-S9], select the CW mode, and preset the **RF** control fully clockwise. Inject a signal of level +33 dB $\mu$  (no modulation), then press the **MCK/W** key.

## 144 MHz Band SSB-Full Scale Adjustment

- Connect the signal generator to the **144MHz** antenna jack, and tune the transceiver to 145.995 MHz. Select alignment menu [SSB-FULL], and inject a signal of level +93 dB $\mu$  (no modulation). Then press the **MCK/W** key.

## 144 MHz Band RX Gain Adjustment

- Connect the signal generator to the **144MHz** antenna jack, and tune the transceiver to 145.995 MHz.
- Select alignment menu [RX-GAIN], and select the CW mode. Inject a signal of level +3 dB $\mu$  (no modulation), and adjust the **MEM/VFO CH** control for just 1 segment indication on the S-meter. Then press the **MCK/W** key.

## 430 MHz Band RX Gain Adjustment

- Connect the signal generator to the **430MHz** antenna jack, and tune the transceiver to 439.995 MHz.
- Select alignment menu [RX-GAIN], and select

the CW mode. Inject a signal of level +3 dB $\mu$  (no modulation), and adjust the **MEM/VFO CH** control for just 1 segment indication on the S-meter. Then press the **MCK/W** key.

## 50 MHz Band RX Gain Adjustment

- Connect the signal generator to the **50MHz** antenna jack, and tune the transceiver to 51.995 MHz.
- Select alignment menu [RX-GAIN], and select the CW mode. Inject a signal of level +6 dB $\mu$  (no modulation), and adjust the **MEM/VFO CH** control for just 1 segment indication on the S-meter. Then press the **MCK/W** key.

## HF Band RX Gain Adjustment

- Connect the signal generator to the **HF** antenna jack, and tune the transceiver and RF signal generator to 28.995 MHz.
- Select alignment menu [RX-GAIN], and select the CW mode. Inject a signal of level +9 dB $\mu$  (no modulation), and adjust the **MEM/VFO CH** control for just 1 segment indication on the S-meter. Then press the **MCK/W** key.
- Tune the transceiver and RF signal generator to 14.005 MHz, and select the CW mode. Inject a signal of level +9 dB $\mu$  (no modulation), and adjust the **MEM/VFO CH** control for just 1 segment indication on the S-meter. Then press the **MCK/W** key.
- Tune the transceiver and RF signal generator to 3.505 MHz, and select the CW mode. Inject a signal of level +29 dB $\mu$  (no modulation), and adjust the **MEM/VFO CH** control for just 1 segment indication on the S-meter. Then press the **MCK/W** key.

## SHIFT Control Center Preset

- Preset the **SHIFT** control to the 12-o'clock position. Select alignment menu [SFT-CTR], and press the **MCK/W** key. *After this preset procedure, do not turn the **SHIFT** control. If you acci-*

# Alignment

---

dentally turn it, repeat the above procedure for pre-setting the **SHIFT** control.

## RX SSB Carrier Point Adjustment

- Tune the transceiver to the 145.995 MHz. Select alignment menu [RXC-PNT], and inject no RF input.
- Adjust the **MEM/VFO CH** control for identical "sound" of the noise from the speaker while switching between USB and LSB. Then press the **MCK/W** key.

## TX SSB Carrier Point Adjustment

- Connect the 50  $\Omega$  dummy load to the **144MHz** antenna jack, and connect the ammeter between the transceiver's **13.8VDC** connector and DC power supply. Tune the transceiver to 145.995 MHz, and select alignment menu [TXC-USB].
- Set "regular" Menu #92 and #93 to "0" if they are not already set to that value.
- Key the transmitter, and adjust the **MEM/VFO CH** control for minimum indication on the ammeter.
- Select alignment menu [TXC-LSB]. Key the transmitter, and adjust the **MEM/VFO CH** control for minimum indication on the ammeter.

## HF Band PO Meter Adjustment

- Connect the 50  $\Omega$  dummy load to the **HF** antenna jack. Tune the transceiver to 14.005 MHz, and select the CW mode.
- Select alignment menu [PWR-100W]. Key the transmitter, and adjust the **RF PWR** control for 100 W indication on the external wattmeter. Then press the **MCK/W** key.
- Select alignment menu [PWR-50W]. Key the transmitter, and adjust the **RF PWR** control for 50 W indication on the external wattmeter. Then press the **MCK/W** key.
- Select alignment menu [PWR-20W]. Key the transmitter, and adjust the **RF PWR** control

for 20 W indication on the external wattmeter. Then press the **MCK/W** key.

- Select alignment menu [PWR-10W]. Key the transmitter, and adjust **RF PWR** control for 10 W indication on the external wattmeter. Then press the **MCK/W** key.

## 1.9 MHz Band PO Meter Adjustment

- Connect the 50  $\Omega$  dummy load to the **HF** antenna jack. Tune the transceiver to 1.900 MHz, and select the CW mode.
- Select alignment menu [PWR-100W]. Key the transmitter, and adjust the **RF PWR** control for 100 W indication on the external wattmeter. Then press the **MCK/W** key.
- Select alignment menu [PWR-50W]. Key the transmitter, and adjust the **RF PWR** control for 50 W indication on the external wattmeter. Then press the **MCK/W** key.
- Select alignment menu [PWR-20W]. Key the transmitter, and adjust the **RF PWR** control for 20 W indication on the external wattmeter. Then press the **MCK/W** key.
- Select alignment menu [PWR-10W]. Key the transmitter, and adjust the **RF PWR** control for 10 W indication on the external wattmeter. Then press the **MCK/W** key.

## 50 MHz Band PO Meter Adjustment

- Connect the 50  $\Omega$  dummy load to the **50MHz** antenna jack. Tune the transceiver to 51.995 MHz, and select the CW mode.
- Select alignment menu [PWR-100W]. Key the transmitter, and adjust the **RF PWR** control for 100 W indication on the external wattmeter. Then press **MCK/W** key.
- Select alignment menu [PWR-50W]. Key the transmitter, and adjust the **RF PWR** control for 50 W indication on the external wattmeter. Then press the **MCK/W** key.
- Select alignment menu [PWR-20W]. Key the transmitter, and adjust the **RF PWR** control

for 20 W indication on the external wattmeter. Then press the **MCK/W** key.

- Select alignment menu [PWR-10W]. Key the transmitter, and adjust the **RF PWR** control for 10 W indication on the external wattmeter. Then press the **MCK/W** key.

### *144/430 MHz Band PO Meter Adjustment*

- Connect the 50  $\Omega$  dummy load to the **144MHz** antenna jack. Tune the transceiver to 145.995 MHz, and select the CW mode.
- Select alignment menu [PWR-100W]. Rotate the **MEM/VFO CH** control to select the (hexadecimal data) value of "FF".
- Select alignment menu [PWR-50W]. Key the transmitter, and adjust the **RF PWR** control for 50 W indication on the external wattmeter. Then press the **MCK/W** key.
- Select alignment menu [PWR-20W]. Key the transmitter, and adjust the **RF PWR** control for 20 W indication on the external wattmeter. Then press the **MCK/W** key.
- Select alignment menu [PWR-10W]. Key the transmitter, and adjust the **RF PWR** control for 10 W indication on the external wattmeter. Then press the **MCK/W** key.

### *ALC Meter Adjustment*

- With the inline wattmeter and 50  $\Omega$  dummy load connected to the **144MHz** antenna jack, connect the AF generator to the **MIC** jack. Tune the transceiver to 145.005 MHz, and select the USB mode.
- Select alignment menu [ALC-1] and inject no microphone input. Key the transmitter, then press the **MCK/W** key. Now adjust the **MEM/VFO CH** control for a (hexadecimal data) "+4" indication on the display.
- Select alignment menu [ALC-9] and inject a 1 kHz tone signal of level 3 mV to the **MIC** jack. Key the transmitter, and adjust the **MIC** control for just 1 segment indication on the ALC meter.

- Without touching the setting of the **MIC** control, inject a 1 kHz tone at 10 mV to the **MIC** jack. Then press the **MCK/W** key.

### *144 MHz Band TX Adjustment*

- With the inline wattmeter and 50  $\Omega$  dummy load connected to the **144MHz** antenna jack, connect the AF generator to the **MIC** jack (pin 8: mic input, pin 7: ground). Tune the transceiver to 145.995 MHz, and select the USB mode. Preset the **MIC** control to the 12-o'clock position.
- Select alignment menu [TX-GAIN] and inject a 1 kHz tone at 1 mV level to the **MIC** jack. Key the transmitter, and adjust the **MEM/VFO CH** control for 25 W on the external wattmeter.

### *430 MHz Band TX Adjustment*

- With the inline wattmeter and 50  $\Omega$  dummy load connected to the **430MHz** antenna jack, connect the AF generator to the **MIC** jack (pin 8: mic input, pin 7: ground). Tune the transceiver to 439.995 MHz, and select the USB mode. Preset the **MIC** control to the 12-o'clock position.
- Select alignment menu [TX-GAIN] and inject a 1 kHz tone at 1 mV level to the **MIC** jack. Key the transmitter, and adjust the **MEM/VFO CH** control for 25 W on the external wattmeter.

### *50 MHz Band TX Adjustment*

- With the inline wattmeter and 50  $\Omega$  dummy load connected to the **50MHz** antenna jack, connect the AF generator to the **MIC** jack (pin 8: mic input, pin 7: ground). Tune the transceiver to 51.995 MHz, and select the USB mode. Preset the **MIC** control to the 12-o'clock position.
- Select alignment menu [TX-GAIN] and inject a 1 kHz tone at 1 mV level to the **MIC** jack. Key the transmitter, and adjust the **MEM/VFO CH** control for 50 W on the external wattmeter.

# Alignment

---

## *HF Band TX Adjustment*

- With the inline wattmeter and 50  $\Omega$  dummy load connected to the **HF** antenna jack, connect the AF generator to the **MIC** jack (pin 8: mic input, pin 7: ground). Select alignment menu [TX-GAIN], and select the USB mode. Preset the **MIC** control to the 12-o'clock position.
- Tune the transceiver to 28.995 MHz and inject a 1 kHz tone at 1 mV level to the **MIC** jack. Key the transmitter, and adjust the **MEM/VFO CH** control for 50 W on the inline wattmeter.
- Tune the transceiver to 14.005 MHz and inject 1 mV at 1 kHz tone to the **MIC** jack. Key the transmitter, and adjust the **MEM/VFO CH** control for 50 W on the inline wattmeter.
- Tune the transceiver to 7.005 MHz and inject 1 mV at 1 kHz tone to the **MIC** jack. Key the transmitter, and adjust the **MEM/VFO CH** control for 50 W on the inline wattmeter.

## *SWR Meter Adjustment*

- With the inline wattmeter and 50  $\Omega$  dummy load connected to the **HF** antenna jack, select the CW mode. Tune the transceiver to 14.005 MHz. Select alignment menu [SWR 1.5].
- Key the transmitter, and adjust the **RF PWR** control for 10 W on the external wattmeter.
- Replace the 50  $\Omega$  dummy load with a 100  $\Omega$  dummy load (two 50  $\Omega$  loads in parallel) connected to the **HF** antenna jack.
- Key the transmitter, and press the **MCK/W** key.
- Replace the 100  $\Omega$  dummy load with the 50  $\Omega$  dummy load connected to the **HF** antenna jack, and select alignment menu [SWR 3.0].
- Key the transmitter, and adjust the **RF PWR** control for 50 W on the inline wattmeter.
- Replace the 50  $\Omega$  dummy load with the 150  $\Omega$  dummy load (or three 50  $\Omega$ s in parallel) to the **HF** antenna jack.
- Key the transmitter, and press the **MCK/W** key.

## *FM Deviation Adjustment*

- With the 50 dB attenuator (or 50  $\Omega$  dummy load and sampling coupler) and linear detector connected to the **144MHz** antenna jack, connect the AF generator to the **MIC** jack (pin 8: mic input, pin 7: ground). Tune the transceiver to the 145.995 MHz, and select the FM mode.
- Inject a 1 kHz tone at 15 mV level. Key the transmitter, and adjust VR1003 for  $\pm 4.5$  kHz deviation on the linear detector.
- Select the 88.5 Hz (default) subaudible tone, and activate CTCSS Encode operation. Key the transmitter, and adjust VR1004 for  $\pm 0.7$  kHz deviation on the linear detector.

## *Speech Processor Adjustment*

- With the inline wattmeter and 50  $\Omega$  dummy load connected to the **144MHz** antenna jack, connect the AF generator to the **MIC** jack (pin 8: mic input, pin 7: ground). Tune the transceiver to 145.995 MHz, select the USB mode, and leave the **PROC** switch off for now.
- Inject a 1 kHz tone at 1 mV level. Key the transmitter, and adjust the **MIC** control for 12.5 W on the wattmeter.
- Switch **PROC** on, key the transmitter, and adjust the VR1002 for 25 W on the wattmeter.

## *Carrier Level Adjustment*

- Connect the 50  $\Omega$  dummy load to the **HF** antenna jack. Tune the transceiver to 1.900 MHz, select the CW mode, and set **PROC** off. Select the TX meter to read ALC.
- Key the transmitter, and adjust VR1006 for at least a 5-segment indication on the ALC meter.
- Connect the AF generator to the **MIC** jack (pin 8: mic input, pin 7: ground). Select the AM mode, and inject a 1 kHz tone at 1 mV level to the **MIC** jack. Key the transmitter, and adjust VR1005 for at least a 5-segment indication on the ALC meter.



## AF-CNTL Unit Alignment Points

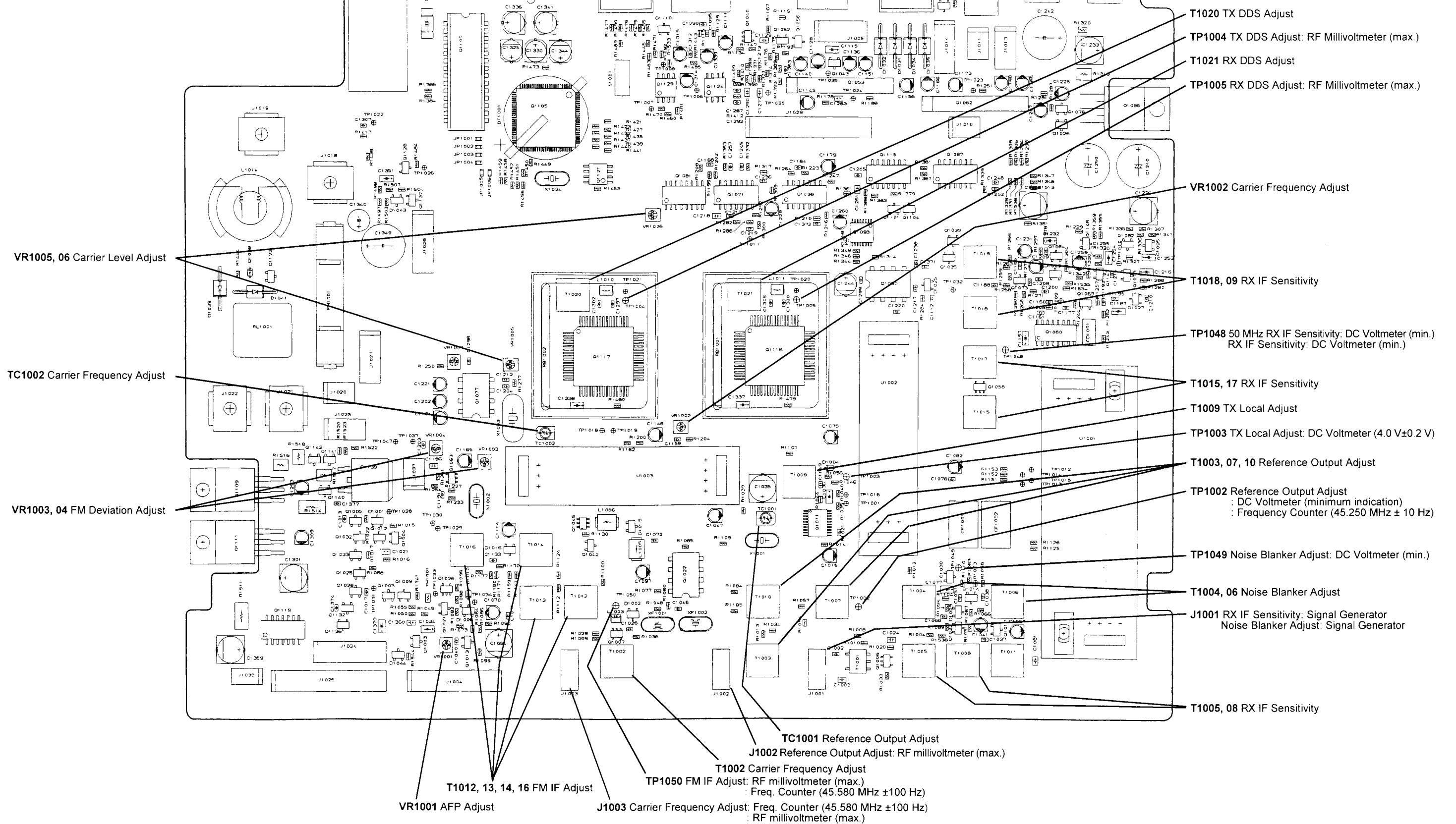

## PLL Unit Alignment Points

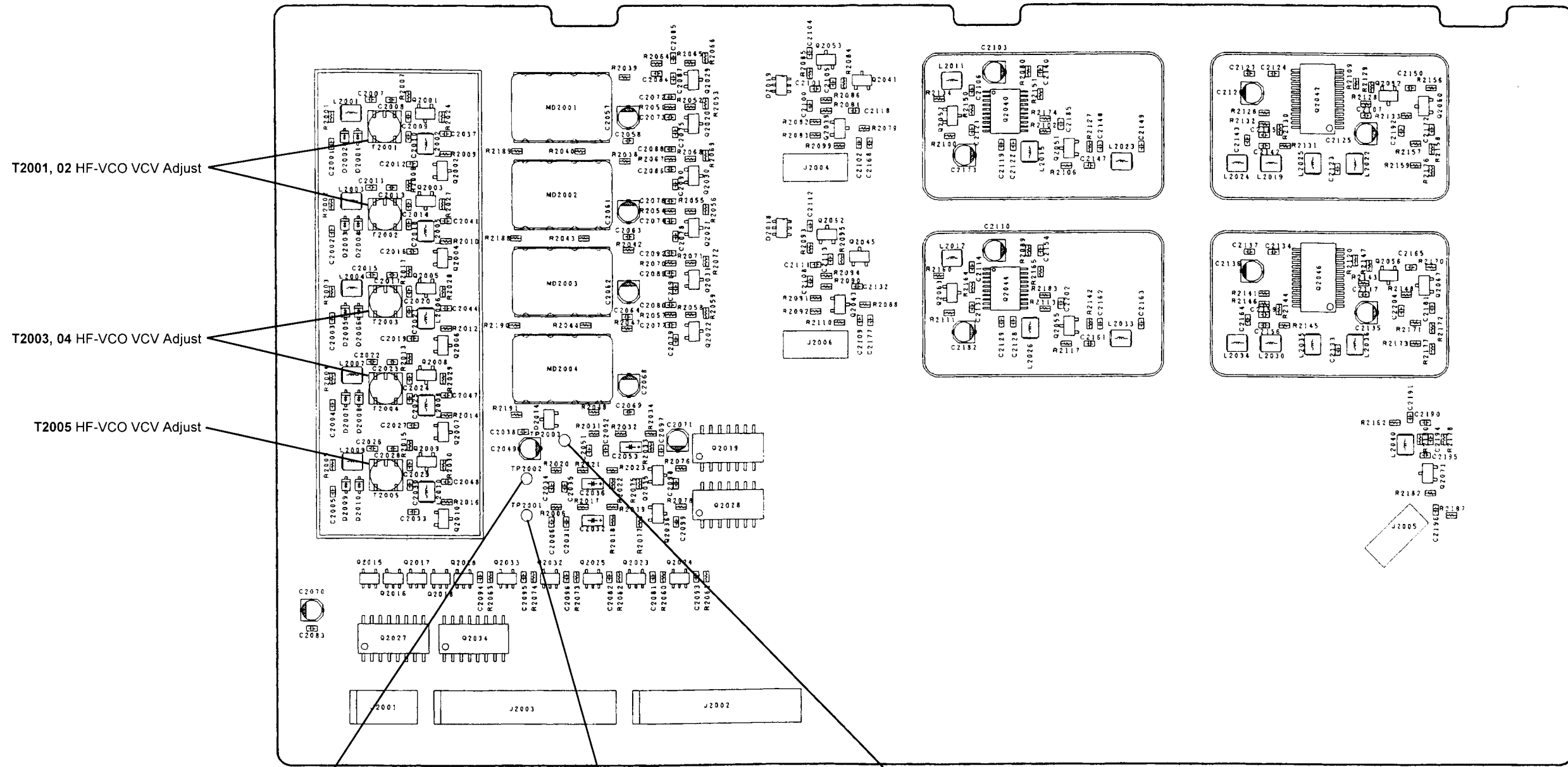

TP2002 VHF-VCO VCV Check: DC Voltmeter

VHF VCO check	
Tune to:	for
108.000 MHz	at least 0.5V
139.995 MHz	less than 6.5V
140.000 MHz	at least 0.5V
173.995 MHz	less than 6.5V

TP2001 HF-VCO VCV Adjust: DC Voltmeter

HF VCO Adjustment		
Tune to:	Adjust/Confirm	for
10.495 MHz	adjust T2001	6.5V±0.1V
0.100 MHz	confirm	at least 0.5V
21.995 MHz	adjust T2002	6.5V±0.1V
10.500 MHz	confirm	at least 0.5V
36.995 MHz	adjust T2003	6.5V±0.1V
22.000 MHz	confirm	at least 0.5V
53.995 MHz	adjust T2004	6.5V±0.1V
37.000 MHz	confirm	at least 0.5V
75.995 MHz	adjust T2005	6.5V±0.1V
54.000 MHz	confirm	at least 0.5V

TP2003 UHF-VCO VCV Check: DC Voltmeter

UHF VCO check	
Tune to:	for
420.000 MHz	at least 0.5V
469.995 MHz	less than 6.5V
470.000 MHz	at least 0.5V
511.995 MHz	less than 6.5V

RF Unit Alignment Points

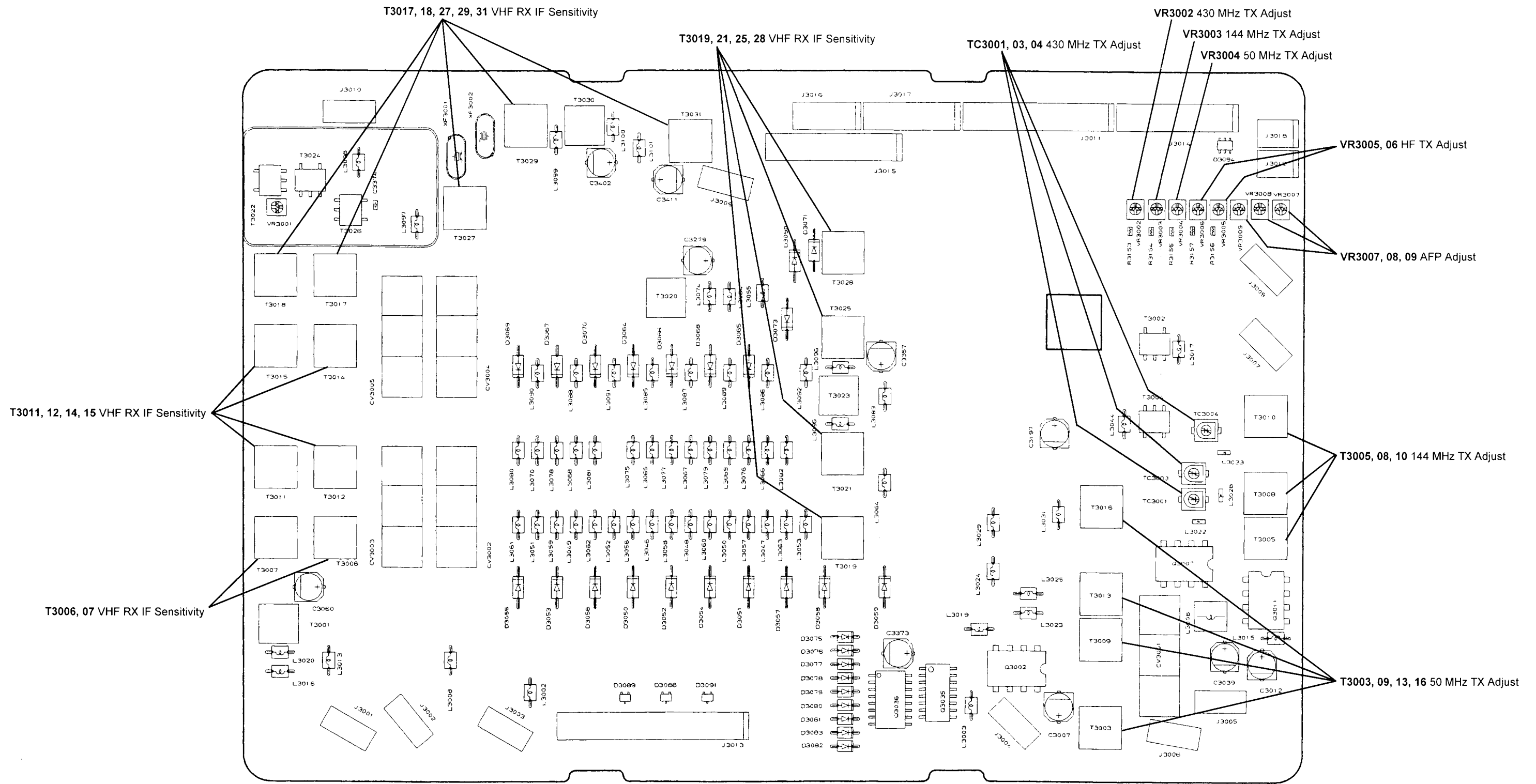

V/U-PA Unit Alignment Points

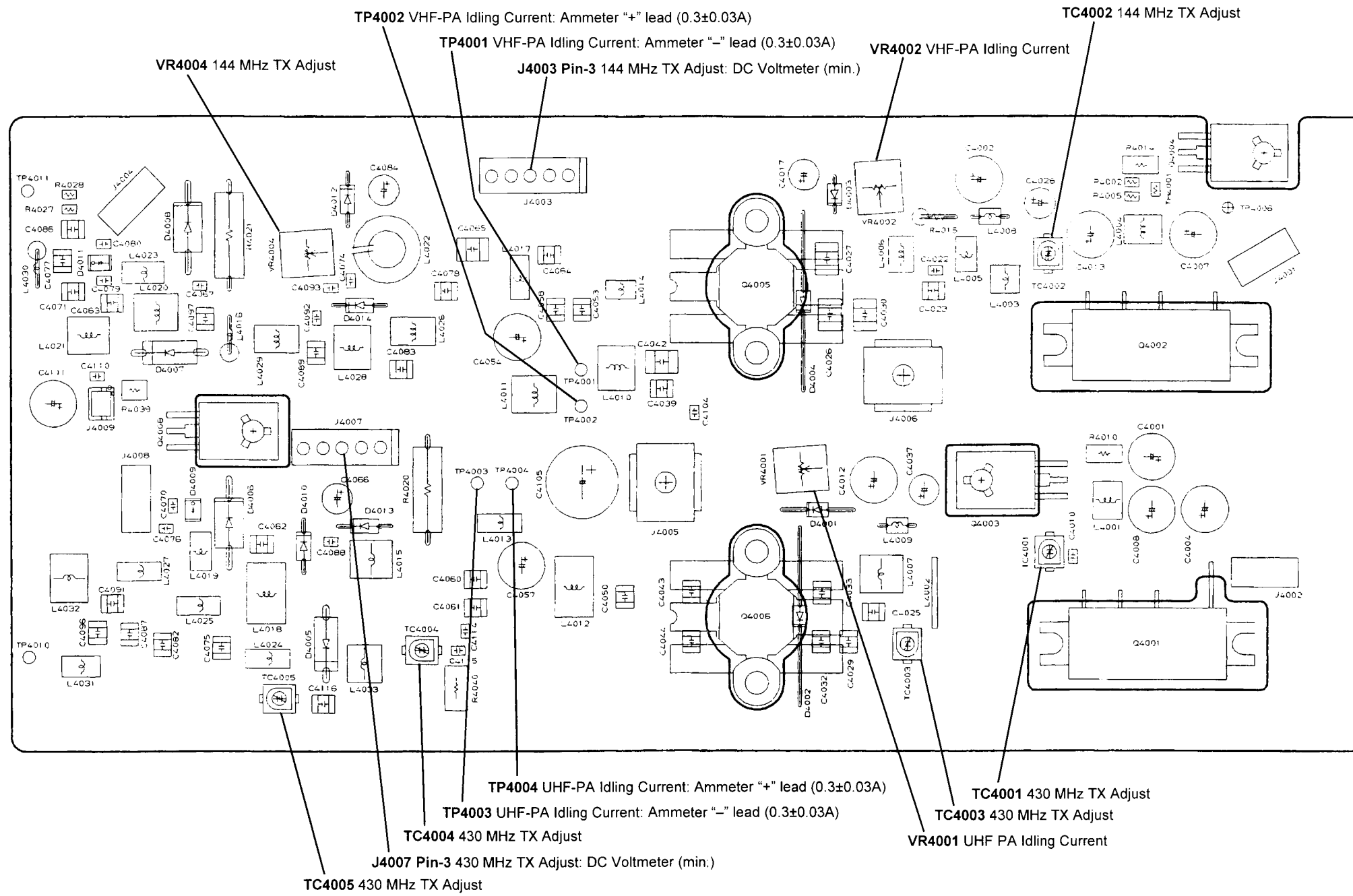

PA Unit Alignment Points

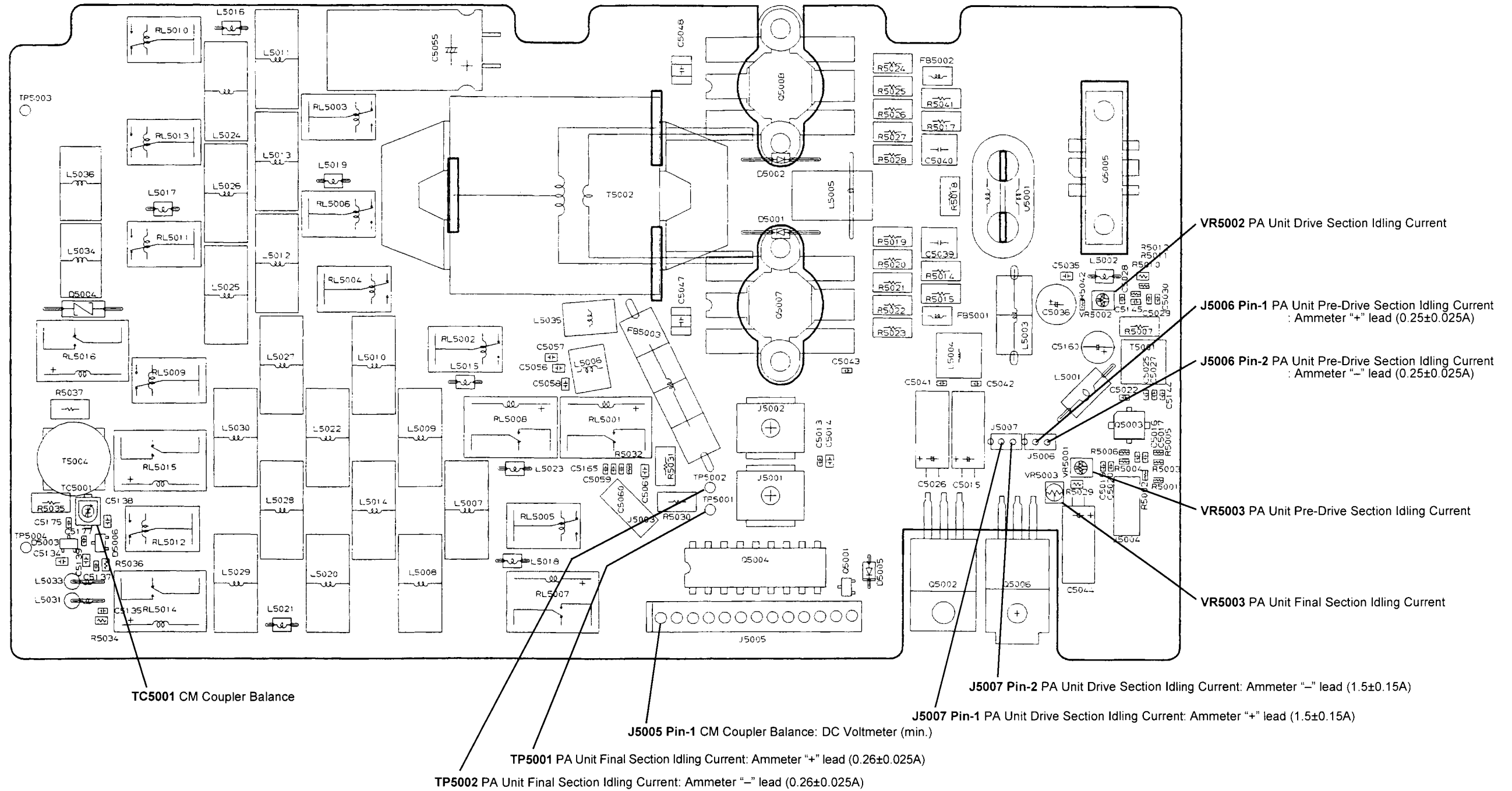

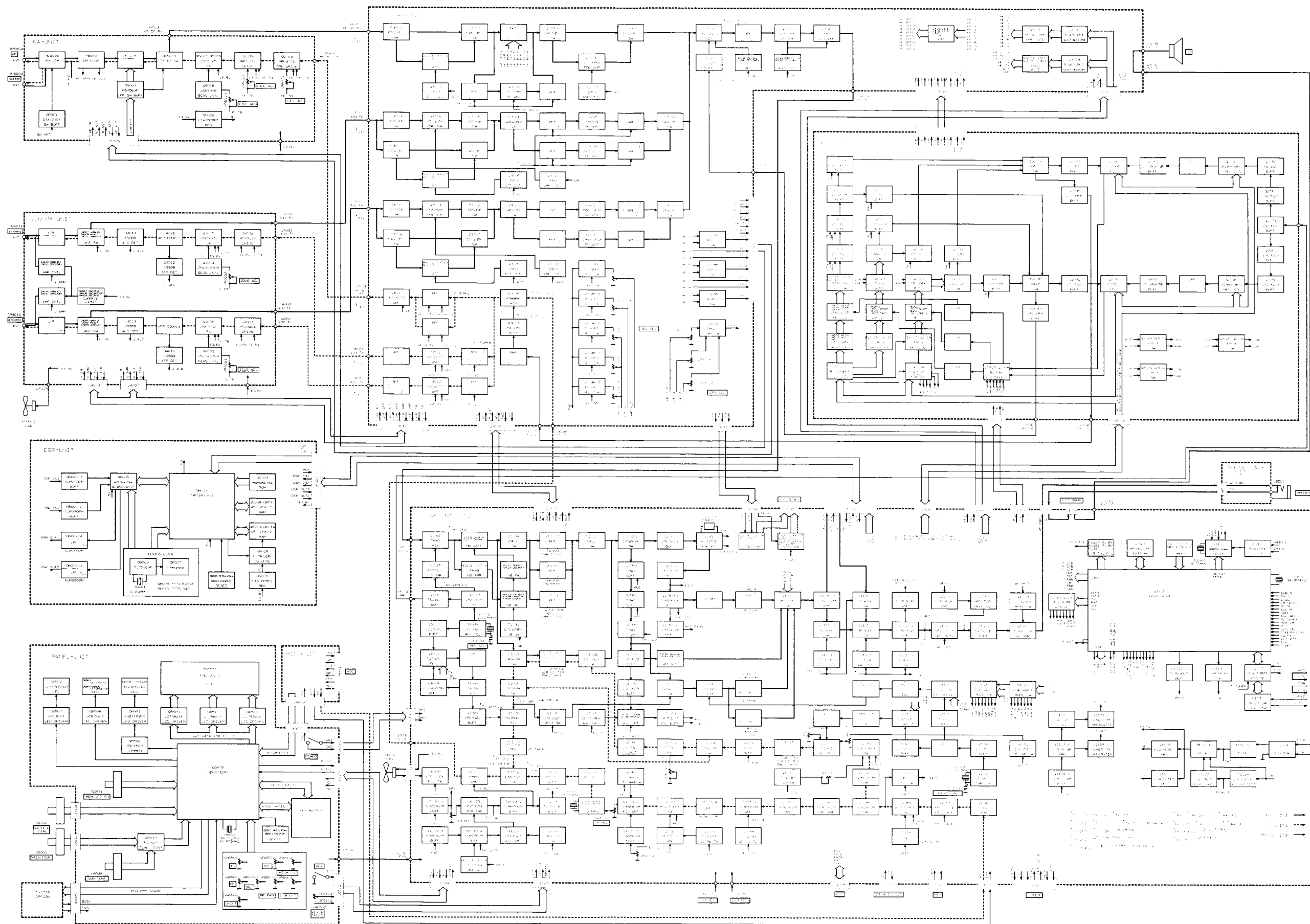

# Interconnection Diagram

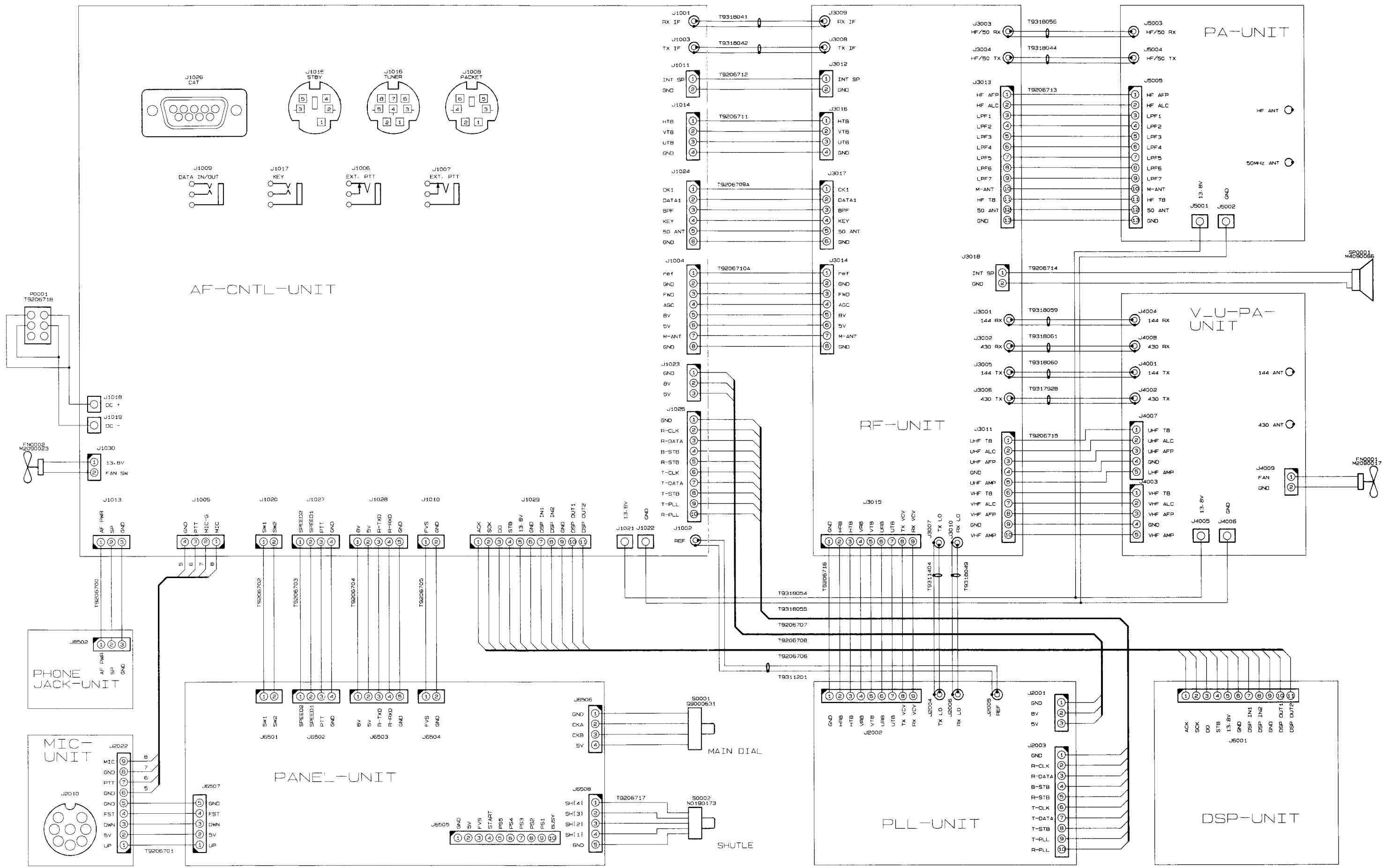

Circuit Diagram

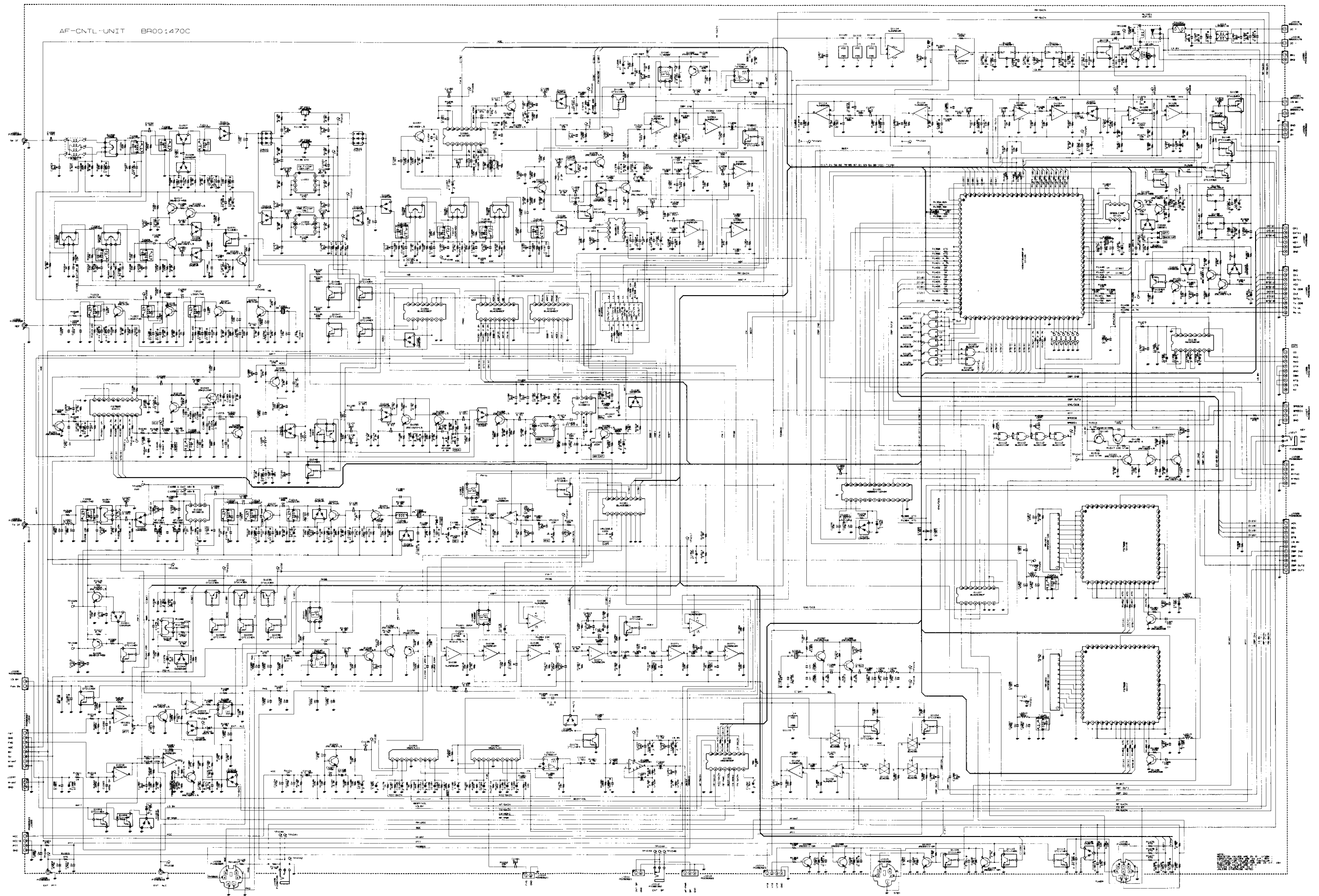



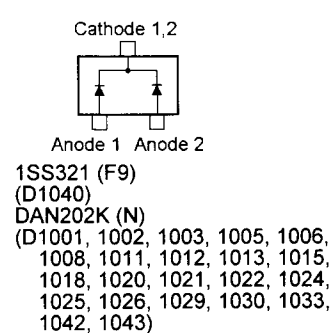
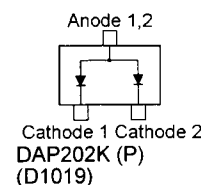
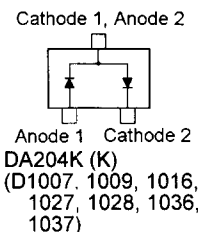
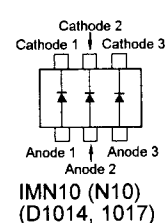
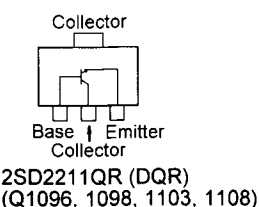
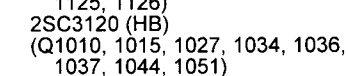
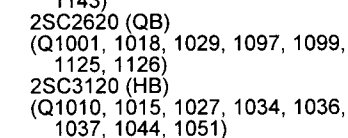
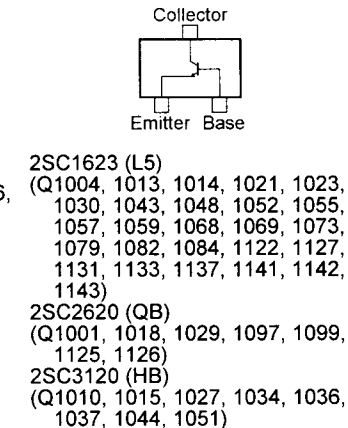
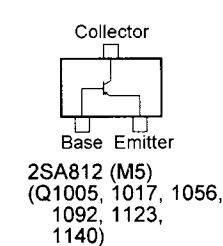
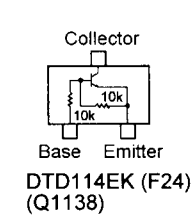
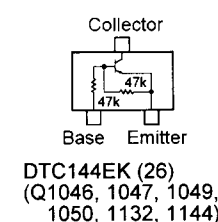
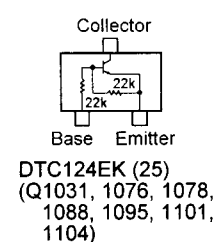
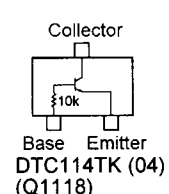
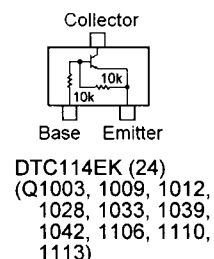
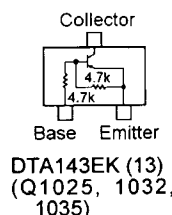
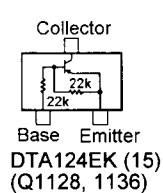
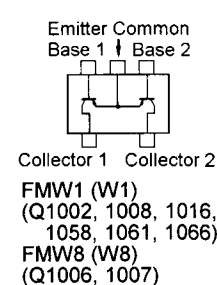
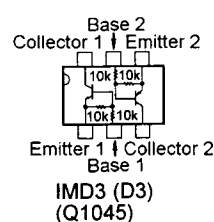
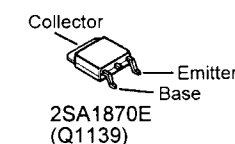
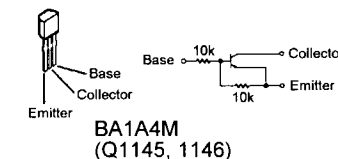
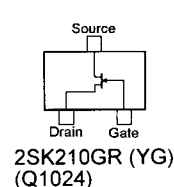
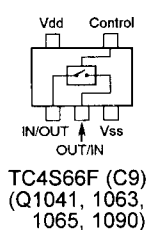
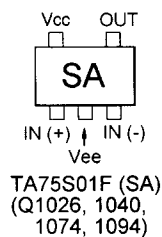
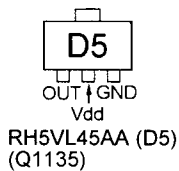
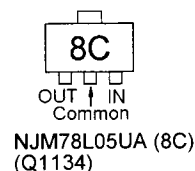
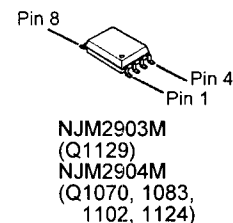
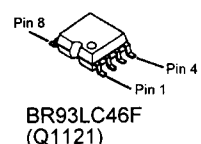
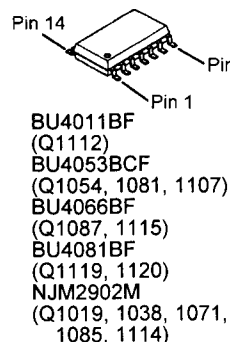
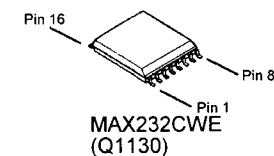
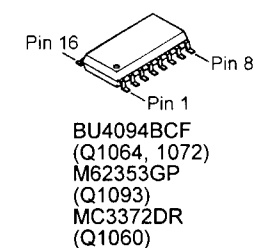
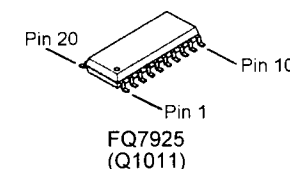
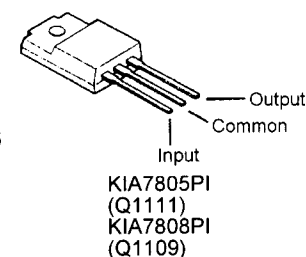
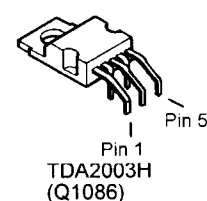
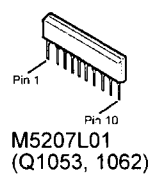
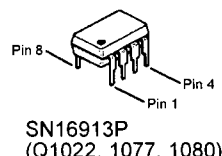
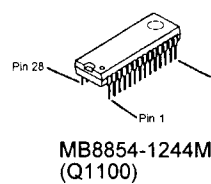
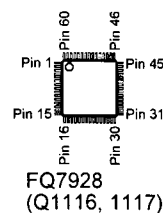
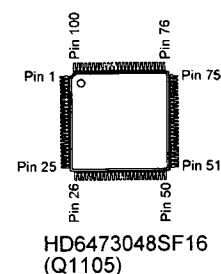

Parts Layout

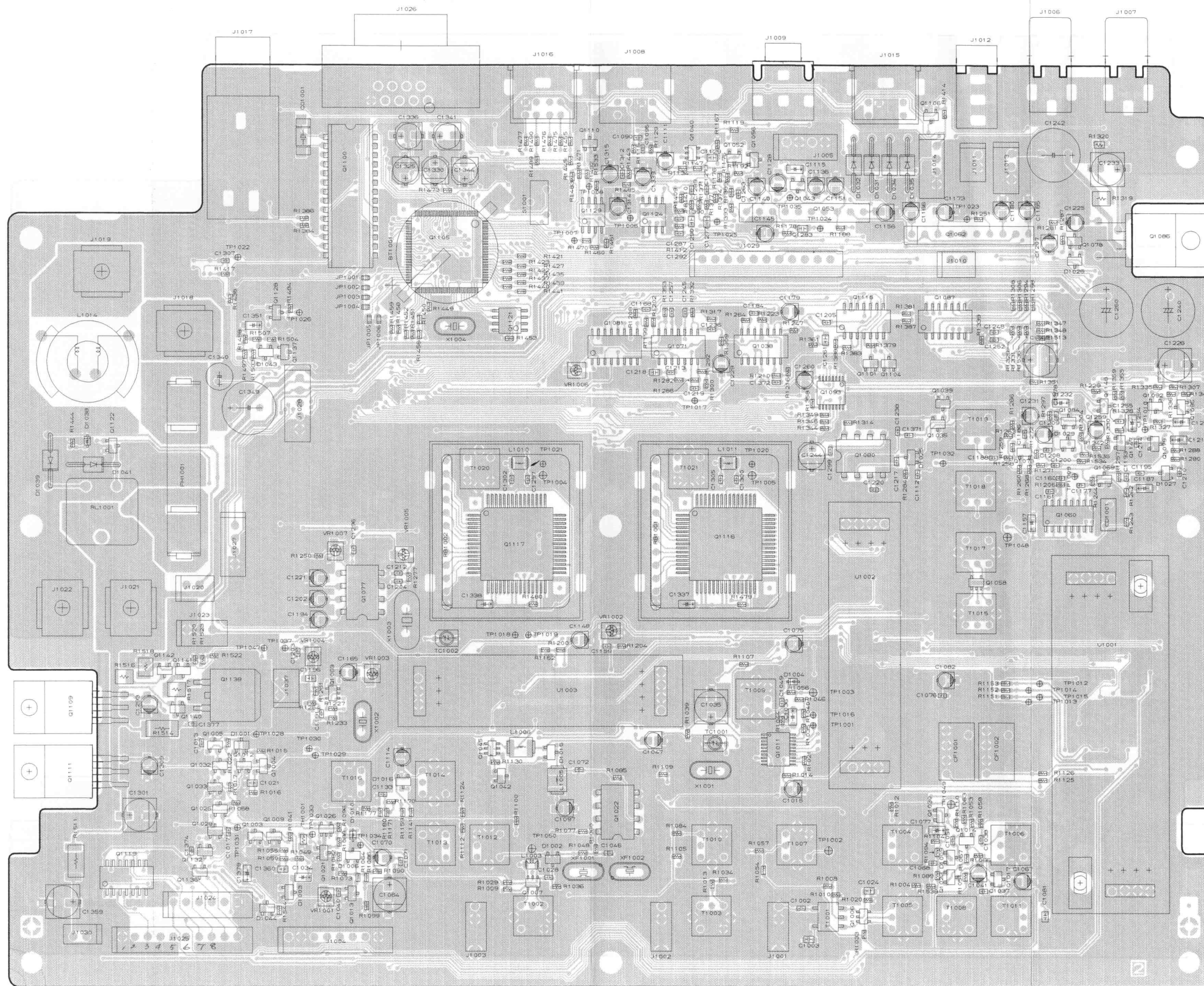

Component Side



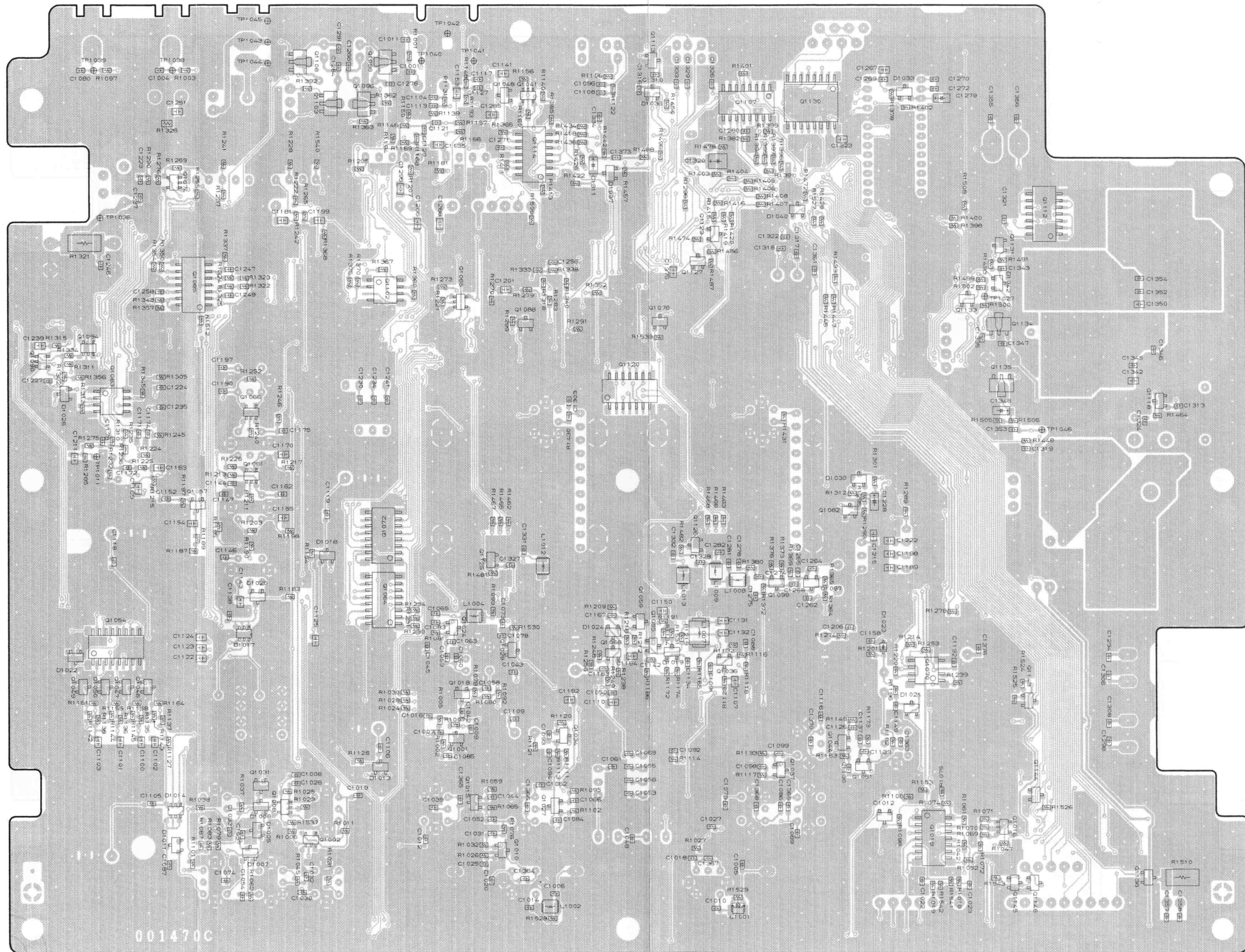

Chip Side

## Parts List

REF.	DESCRIPTION	VALUE	V/W	TOL.	MFR'S DESIG	YAESU P/N	VERS.	LOT.
*** AF-CNTL UNIT ***								
	PCB with Components					CB0214003	EXPORT(A1)	
	PCB with Components					CB0214004	USA(A2)	
	PCB with Components					CB0214005	EXPORT(A2)	
	PCB with Components					CB0214006	EXPORT(A3)	
	PCB with Components					CB0214007	EXPORT(B1)	
	PCB with Components					CB0214008	EXPORT(B2)	
	PCB with Components					CB0214009	EXPORT(B3)	
	PCB with Components					CB0214010	EXPORT(C1)	
	PCB with Components					CB0214011	EXPORT(C2)	
	PCB with Components					CB0214012	EXPORT(C3)	
	PCB with Components					CB0214013	EXPORT(D1)	
	PCB with Components					CB0214014	EXPORT(D2)	
	PCB with Components					CB0214015	AUSTRALIA(H1)	
	PCB with Components					CB0214016	AUSTRALIA(H2)	
	PCB with Components					CB0214017	FRANCE(E1)	
	PCB with Components					CB0214018	FRANCE(E2)	
	PCB with Components					CB0214019	FRANCE(E3)	
Printed Circuit Board						FR001470C		
BT1001	LITHIUM BATT.		3V		CR2016-TS1	Q9000552		
C 1001	CHIP CAP.	470pF	50V	CH	GRM39CH471J50PT	K22174249		
C 1002	CHIP CAP.	0.001uF	50V	B	GRM39B102M50PT	K22174809		
C 1003	CHIP CAP.	0.1uF	25V	B	GRM40B104M25PT	K22140811		
C 1004	CHIP CAP.	470pF	50V	CH	GRM39CH471J50PT	K22174249		
C 1005	CHIP CAP.	56pF	50V	CH	GRM39CH560J50PT	K22174229		
C 1007	CHIP CAP.	47pF	50V	CH	GRM39CH470J50PT	K22174227		
C 1008	CHIP CAP.	0.047uF	16V	B	GRM39B473K16PT	K22124804		
C 1009	CHIP CAP.	0.1uF	16V	B	GRM39B104K16PT	K22124805		
C 1010	CHIP CAP.	56pF	50V	CH	GRM39CH560J50PT	K22174229		
C 1011	CHIP CAP.	470pF	50V	CH	GRM39CH471J50PT	K22174249		
C 1012	CHIP CAP.	0.001uF	50V	B	GRM39B102M50PT	K22174809		
C 1013	CHIP CAP.	0.01uF	25V	B	GRM39B103M25PT	K22144802		
C 1015	AL.ELECTRO.CAP.	10uF	16V		ECEV1CS100SR	K48120001		
C 1016	CHIP CAP.	0.01uF	25V	B	GRM39B103M25PT	K22144802		
C 1017	CHIP CAP.	0.01uF	25V	B	GRM39B103M25PT	K22144802		
C 1018	CHIP CAP.	0.01uF	25V	B	GRM39B103M25PT	K22144802		
C 1019	CHIP CAP.	0.047uF	16V	B	GRM39B473K16PT	K22124804		
C 1020	CHIP CAP.	0.01uF	25V	B	GRM39B103M25PT	K22144802		
C 1021	CHIP CAP.	0.1uF	25V	B	GRM40B104M25PT	K22140811		
C 1022	CHIP CAP.	100pF	50V	CH	GRM39CH101J50PT	K22174235		
C 1023	CHIP CAP.	100pF	50V	CH	GRM39CH101J50PT	K22174235		
C 1024	CHIP CAP.	0.1uF	25V	B	GRM40B104M25PT	K22140811		
C 1025	CHIP CAP.	0.01uF	25V	B	GRM39B103M25PT	K22144802		
C 1026	CHIP CAP.	0.01uF	25V	B	GRM39B103M25PT	K22144802		
C 1027	CHIP CAP.	0.01uF	25V	B	GRM39B103M25PT	K22144802		
C 1028	CHIP CAP.	0.001uF	50V	B	GRM39B102M50PT	K22174809		
C 1030	CHIP CAP.	0.047uF	16V	B	GRM39B473K16PT	K22124804		
C 1031	CHIP CAP.	47pF	50V	CH	GRM39CH470J50PT	K22174227		
C 1032	CHIP CAP.	0.001uF	50V	B	GRM39B102M50PT	K22174809		
C 1033	CHIP CAP.	0.047uF	16V	B	GRM39B473K16PT	K22124804		
C 1034	TANTALUM CHIP CAP.	0.1uF	35V		TESVA1V104M1-8R	K78160025		
C 1035	AL.ELECTRO.CAP.	47uF	16V		ECEV1CA470SP	K48120005		
C 1036	TANTALUM CHIP CAP.	1uF	16V		TESVA1C105M1-8R	K78120009		
C 1037	CHIP CAP.	0.01uF	25V	B	GRM39B103M25PT	K22144802		
C 1038	CHIP CAP.	47pF	50V	CH	GRM39CH470J50PT	K22174227		
C 1039	CHIP CAP.	0.01uF	25V	B	GRM39B103M25PT	K22144802		
C 1040	CHIP CAP.	0.001uF	50V	B	GRM39B102M50PT	K22174809		

# AF-CNTL Unit

REF.	DESCRIPTION	VALUE	V/W	TOL.	MFR'S DESIG	YAESU P/N	VERS.	LOT.
C 1041	AL.ELECTRO.CAP.	10uF	16V		ECEV1CS100SR	K48120001		
C 1042	CHIP CAP.	0.001uF	50V	B	GRM39B102M50PT	K22174809		
C 1043	CHIP CAP.	0.01uF	25V	B	GRM39B103M25PT	K22144802		
C 1044	CHIP CAP.	0.01uF	25V	B	GRM39B103M25PT	K22144802		
C 1045	CHIP CAP.	0.0047uF	50V	B	GRM39B472M50PT	K22174817		
C 1046	CHIP CAP.	0.01uF	25V	B	GRM39B103M25PT	K22144802		
C 1047	AL.ELECTRO.CAP.	1uF	50V		ECEV1HS010SR	K48170001		
C 1049	CHIP CAP.	8pF	50V	CH	GRM39CH080D50PT	K22174209		
C 1050	CHIP CAP.	0.01uF	25V	B	GRM39B103M25PT	K22144802		
C 1051	CHIP CAP.	0.01uF	25V	B	GRM39B103M25PT	K22144802		
C 1052	CHIP CAP.	5pF	50V	CH	GRM39CH050C50PT	K22174206		
C 1053	CHIP CAP.	0.047uF	16V	B	GRM39B473K16PT	K22124804		
C 1054	CHIP CAP.	0.1uF	16V	B	GRM39B104K16PT	K22124805		
C 1055	CHIP CAP.	0.047uF	16V	B	GRM39B473K16PT	K22124804		
C 1056	CHIP CAP.	0.047uF	16V	B	GRM39B473K16PT	K22124804		
C 1057	CHIP CAP.	0.001uF	50V	B	GRM39B102M50PT	K22174809		
C 1058	CHIP CAP.	1pF	50V	CK	GRM39CK010C50PT	K22174202		
C 1059	CHIP CAP.	9pF	50V	CH	GRM39CH090D50PT	K22174210		
C 1060	CHIP CAP.	15pF	50V	CH	GRM39CH150J50PT	K22174215		
C 1061	CHIP CAP.	0.047uF	16V	B	GRM39B473K16PT	K22124804		
C 1062	CHIP CAP.	0.01uF	25V	B	GRM39B103M25PT	K22144802		
C 1063	CHIP CAP.	8pF	50V	CH	GRM39CH080D50PT	K22174209		
C 1064	AL.ELECTRO.CAP.	47uF	16V		ECEV1CA470P	K48120003		
C 1065	CHIP CAP.	22pF	50V	CH	GRM39CH220J50PT	K22174219		
C 1066	CHIP CAP.	0.01uF	25V	B	GRM39B103M25PT	K22144802		
C 1067	AL.ELECTRO.CAP.	10uF	16V		ECEV1CS100SR	K48120001		
C 1068	CHIP CAP.	220pF	50V	CH	GRM39CH221J50PT	K22174243		
C 1069	CHIP CAP.	0.001uF	50V	B	GRM39B102M50PT	K22174809		
C 1070	AL.ELECTRO.CAP.	1uF	50V		ECEV1HS010SR	K48170001		
C 1071	CHIP CAP.	0.01uF	25V	B	GRM39B103M25PT	K22144802		
C 1072	CHIP CAP.	0.001uF	50V	B	GRM39B102M50PT	K22174809		
C 1073	CHIP CAP.	1pF	50V	CK	GRM39CK010C50PT	K22174202		
C 1074	CHIP CAP.	0.047uF	16V	B	GRM39B473K16PT	K22124804		
C 1075	AL.ELECTRO.CAP.	10uF	16V		ECEV1CS100SR	K48120001		
C 1076	CHIP CAP.	0.01uF	25V	B	GRM39B103M25PT	K22144802		
C 1077	TANTALUM CHIP CAP.	0.47uF	25V		TESVA1E474M1-8R	K78140009		
C 1078	CHIP CAP.	10pF	50V	CH	GRM39CH100D50PT	K22174211		
C 1079	CHIP CAP.	10pF	50V	CH	GRM39CH100D50PT	K22174211		
C 1080	CHIP CAP.	100pF	50V	CH	GRM39CH101J50PT	K22174235		
C 1081	CHIP CAP.	0.1uF	25V	B	GRM40B104M25PT	K22140811		
C 1082	AL.ELECTRO.CAP.	10uF	16V		ECEV1CS100SR	K48120001		
C 1083	CHIP CAP.	0.01uF	25V	B	GRM39B103M25PT	K22144802		
C 1084	CHIP CAP.	10pF	50V	CH	GRM39CH100D50PT	K22174211		
C 1085	CHIP CAP.	10pF	50V	CH	GRM39CH100D50PT	K22174211		
C 1086	CHIP CAP.	0.5pF	50V	CK	GRM39CK0R5C50PT	K22174201		
C 1087	CHIP CAP.	10pF	50V	CH	GRM39CH100D50PT	K22174211		
C 1088	CHIP CAP.	0.01uF	25V	B	GRM39B103M25PT	K22144802		
C 1089	CHIP CAP.	0.01uF	25V	B	GRM39B103M25PT	K22144802		
C 1090	CHIP CAP.	100pF	50V	CH	GRM39CH101J50PT	K22174235		
C 1091	CHIP CAP.	100pF	50V	CH	GRM39CH101J50PT	K22174235		
C 1092	CHIP CAP.	0.01uF	25V	B	GRM39B103M25PT	K22144802		
C 1093	CHIP CAP.	150pF	50V	CH	GRM39CH151J50PT	K22174239		
C 1094	CHIP CAP.	150pF	50V	CH	GRM39CH151J50PT	K22174239		
C 1095	CHIP CAP.	100pF	50V	CH	GRM39CH101J50PT	K22174235		
C 1096	CHIP CAP.	100pF	50V	CH	GRM39CH101J50PT	K22174235		
C 1097	AL.ELECTRO.CAP.	10uF	16V		ECEV1CS100SR	K48120001		
C 1098	CHIP CAP.	0.01uF	25V	B	GRM39B103M25PT	K22144802		

REF.	DESCRIPTION	VALUE	V/W	TOL.	MFR'S DESIG	YAESU P/N	VERS.	LOT.
C 1099	CHIP CAP.	22pF	50V	CH	GRM39CH220J50PT	K22174219		
C 1100	CHIP CAP.	0.1uF	25V	B	GRM40B104M25PT	K22140811		
C 1101	CHIP CAP.	0.1uF	25V	B	GRM40B104M25PT	K22140811		
C 1102	CHIP CAP.	0.1uF	25V	B	GRM40B104M25PT	K22140811		
C 1103	CHIP CAP.	0.1uF	25V	B	GRM40B104M25PT	K22140811		
C 1104	CHIP CAP.	470pF	50V	CH	GRM39CH471J50PT	K22174249		
C 1105	CHIP CAP.	0.01uF	25V	B	GRM39B103M25PT	K22144802		
C 1106	CHIP CAP.	0.01uF	25V	B	GRM39B103M25PT	K22144802		
C 1107	CHIP CAP.	0.1uF	25V	B	GRM40B104M25PT	K22140811		
C 1108	CHIP CAP.	100pF	50V	CH	GRM39CH101J50PT	K22174235		
C 1109	CHIP CAP.	15pF	50V	CH	GRM39CH150J50PT	K22174215		
C 1110	CHIP CAP.	0.1uF	25V	B	GRM40B104M25PT	K22140811		
C 1111	AL.ELECTRO.CAP.	1uF	50V		ECEV1HS010SR	K48170001		
C 1112	CHIP CAP.	10pF	50V	CH	GRM39CH100D50PT	K22174211		
C 1113	CHIP CAP.	470pF	50V	CH	GRM39CH471J50PT	K22174249		
C 1114	AL.ELECTRO.CAP.	10uF	16V		ECEV1CS100SR	K48120001		
C 1115	TANTALUM CHIP CAP.	0.1uF	35V		TESVA1V104M1-8R	K78160025		
C 1116	CHIP CAP.	0.01uF	25V	B	GRM39B103M25PT	K22144802		
C 1117	CHIP CAP.	100pF	50V	CH	GRM39CH101J50PT	K22174235		
C 1118	CHIP CAP.	0.01uF	25V	B	GRM39B103M25PT	K22144802		
C 1119	CHIP CAP.	0.01uF	25V	B	GRM39B103M25PT	K22144802		
C 1120	CHIP CAP.	47pF	50V	CH	GRM39CH470J50PT	K22174227		
C 1121	CHIP CAP.	100pF	50V	CH	GRM39CH101J50PT	K22174235		
C 1122	CHIP CAP.	0.1uF	25V	B	GRM40B104M25PT	K22140811		
C 1123	CHIP CAP.	0.1uF	25V	B	GRM40B104M25PT	K22140811		
C 1124	CHIP CAP.	0.1uF	25V	B	GRM40B104M25PT	K22140811		
C 1125	CHIP CAP.	0.1uF	25V	B	GRM40B104M25PT	K22140811		
C 1126	CHIP CAP.	0.01uF	25V	B	GRM39B103M25PT	K22144802		
C 1127	CHIP CAP.	100pF	50V	CH	GRM39CH101J50PT	K22174235		
C 1128	AL.ELECTRO.CAP.	10uF	16V		ECEV1CS100SR	K48120001		
C 1129	CHIP CAP.	0.1uF	25V	B	GRM40B104M25PT	K22140811		
C 1130	CHIP CAP.	0.001uF	50V	B	GRM39B102M50PT	K22174809		
C 1131	CHIP CAP.	0.1uF	25V	B	GRM40B104M25PT	K22140811		
C 1132	CHIP CAP.	0.1uF	25V	B	GRM40B104M25PT	K22140811		
C 1133	CHIP CAP.	0.01uF	25V	B	GRM39B103M25PT	K22144802		
C 1134	CHIP CAP.	0.001uF	50V	B	GRM39B102M50PT	K22174809		
C 1135	CHIP CAP.	1uF	10V	B	GRM40B105K10PT	K22100802		
C 1136	AL.ELECTRO.CAP.	10uF	16V		ECEV1CS100SR	K48120001		
C 1137	CHIP CAP.	150pF	50V	CH	GRM39CH151J50PT	K22174239		
C 1138	CHIP CAP.	10pF	50V	CH	GRM39CH100D50PT	K22174211		
C 1139	CHIP CAP.	150pF	50V	CH	GRM39CH151J50PT	K22174239		
C 1140	AL.ELECTRO.CAP.	1uF	50V		ECEV1HS010SR	K48170001		
C 1141	CHIP CAP.	0.1uF	25V	B	GRM40B104M25PT	K22140811		
C 1142	CHIP CAP.	0.01uF	50V	B	GRM39B103M50PT	K22174823		
C 1143	CHIP CAP.	0.1uF	25V	B	GRM40B104M25PT	K22140811		
C 1144	CHIP CAP.	0.001uF	50V	B	GRM39B102M50PT	K22174809		
C 1145	AL.ELECTRO.CAP.	10uF	16V		ECEV1CS100SR	K48120001		
C 1146	CHIP CAP.	0.01uF	25V	B	GRM39B103M25PT	K22144802		
C 1147	CHIP CAP.	0.01uF	25V	B	GRM39B103M25PT	K22144802		
C 1148	AL.ELECTRO.CAP.	1uF	50V		ECEV1HS010SR	K48170001		
C 1149	CHIP CAP.	0.001uF	50V	B	GRM39B102M50PT	K22174809		
C 1150	CHIP CAP.	0.1uF	25V	B	GRM40B104M25PT	K22140811		
C 1151	AL.ELECTRO.CAP.	10uF	16V		ECEV1CS100SR	K48120001		
C 1152	CHIP CAP.	82pF	50V	CH	GRM39CH820J50PT	K22174233		
C 1153	CHIP CAP.	0.1uF	25V	B	GRM40B104M25PT	K22140811		
C 1154	CHIP CAP.	0.1uF	25V	B	GRM40B104M25PT	K22140811		
C 1155	CHIP CAP.	0.1uF	25V	B	GRM40B104M25PT	K22140811		



# AF-CNTL Unit

REF.	DESCRIPTION	VALUE	V/W	TOL.	MFR'S DESIG	YAESU P/N	VERS.	LOT.
C 1156	AL.ELECTRO.CAP.	10uF	16V		ECEV1CS100SR	K48120001		
C 1157	TANTALUM CAP.	4.7uF	16V		DN1C4R7M1S	K70127475		
C 1158	CHIP CAP.	0.001uF	50V	B	GRM39B102M50PT	K22174809		
C 1159	CHIP CAP.	0.01uF	25V	B	GRM39B103M25PT	K22144802		
C 1160	CHIP CAP.	0.1uF	16V	B	GRM39B104K16PT	K22124805		
C 1161	CHIP CAP.	0.001uF	50V	B	GRM39B102M50PT	K22174809		
C 1162	CHIP CAP.	0.01uF	25V	B	GRM39B103M25PT	K22144802		
C 1163	CHIP CAP.	0.1uF	25V	B	GRM40B104M25PT	K22140811		
C 1164	CHIP CAP.	0.1uF	25V	B	GRM40B104M25PT	K22140811		
C 1165	AL.ELECTRO.CAP.	1uF	50V		ECEV1HS010SR	K48170001		
C 1166	AL.ELECTRO.CAP.	1uF	50V		ECEV1HS010SR	K48170001		
C 1167	CHIP CAP.	0.001uF	50V	B	GRM39B102M50PT	K22174809		
C 1168	CHIP CAP.	0.01uF	50V	B	GRM39B103M50PT	K22174823		
C 1169	CHIP CAP.	0.1uF	25V	B	GRM40B104M25PT	K22140811		
C 1170	CHIP CAP.	0.1uF	25V	B	GRM40B104M25PT	K22140811		
C 1171	CHIP CAP.	47pF	50V	CH	GRM39CH470J50PT	K22174227		
C 1172	CHIP CAP.	82pF	50V	CH	GRM39CH820J50PT	K22174233		
C 1173	AL.ELECTRO.CAP.	10uF	16V		ECEV1CS100SR	K48120001		
C 1174	CHIP CAP.	47pF	50V	CH	GRM39CH470J50PT	K22174227		
C 1175	CHIP CAP.	0.01uF	25V	B	GRM39B103M25PT	K22144802		
C 1177	CHIP CAP.	0.001uF	50V	B	GRM39B102M50PT	K22174809		
C 1178	CHIP CAP.	0.001uF	50V	B	GRM39B102M50PT	K22174809		
C 1179	AL.ELECTRO.CAP.	10uF	16V		ECEV1CS100SR	K48120001		
C 1180	AL.ELECTRO.CAP.	10uF	16V		ECEV1CS100SR	K48120001		
C 1181	CHIP CAP.	0.1uF	25V	B	GRM40B104M25PT	K22140811		
C 1182	CHIP CAP.	0.1uF	25V	B	GRM40B104M25PT	K22140811		
C 1183	CHIP CAP.	0.01uF	50V	B	GRM39B103M50PT	K22174823		
C 1184	CHIP CAP.	0.0047uF	50V	B	GRM39B472M50PT	K22174817		
C 1185	AL.ELECTRO.CAP.	10uF	16V		ECEV1CS100SR	K48120001		
C 1186	CHIP CAP.	0.047uF	16V	B	GRM39B473K16PT	K22124804		
C 1187	TANTALUM CAP.	4.7uF	16V		DN1C4R7M1S	K70127475		
C 1188	CHIP CAP.	100pF	50V	CH	GRM39CH101J50PT	K22174235		
C 1189	CHIP CAP.	0.1uF	25V	B	GRM40B104M25PT	K22140811		
C 1190	CHIP CAP.	0.047uF	16V	B	GRM39B473K16PT	K22124804		
C 1191	CHIP CAP.	0.022uF	25V	B	GRM39B223M25PT	K22144808		
C 1192	CHIP CAP.	0.01uF	25V	B	GRM39B103M25PT	K22144802		
C 1193	CHIP CAP.	0.01uF	25V	B	GRM39B103M25PT	K22144802		
C 1194	AL.ELECTRO.CAP.	10uF	16V		ECEV1CS100SR	K48120001		
C 1195	CHIP CAP.	0.047uF	16V	B	GRM39B473K16PT	K22124804		
C 1196	CHIP CAP.	0.1uF	25V	B	GRM40B104M25PT	K22140811		
C 1197	CHIP CAP.	47pF	50V	CH	GRM39CH470J50PT	K22174227		
C 1198	CHIP CAP.	0.1uF	25V	B	GRM40B104M25PT	K22140811		
C 1199	CHIP CAP.	0.1uF	25V	B	GRM40B104M25PT	K22140811		
C 1200	CHIP CAP.	0.01uF	25V	B	GRM39B103M25PT	K22144802		
C 1201	CHIP CAP.	0.1uF	25V	B	GRM40B104M25PT	K22140811		
C 1202	AL.ELECTRO.CAP.	10uF	16V		ECEV1CS100SR	K48120001		
C 1203	CHIP CAP.	0.01uF	25V	B	GRM39B103M25PT	K22144802		
C 1204	CHIP CAP.	470pF	50V	CH	GRM39CH471J50PT	K22174249		
C 1205	CHIP CAP.	0.01uF	25V	B	GRM39B103M25PT	K22144802		
C 1206	CHIP CAP.	0.01uF	25V	B	GRM39B103M25PT	K22144802		
C 1207	AL.ELECTRO.CAP.	1uF	50V		ECEV1HS010SR	K48170001		
C 1208	CHIP CAP.	0.01uF	25V	B	GRM39B103M25PT	K22144802		
C 1209	AL.ELECTRO.CAP.	1uF	50V		ECEV1HS010SR	K48170001		
C 1210	CHIP CAP.	0.047uF	16V	B	GRM39B473K16PT	K22124804		
C 1211	CHIP CAP.	0.1uF	25V	B	GRM40B104M25PT	K22140811		
C 1212	CHIP CAP.	470pF	50V	CH	GRM39CH471J50PT	K22174249		
C 1213	CHIP CAP.	0.01uF	25V	B	GRM39B103M25PT	K22144802		

REF.	DESCRIPTION	VALUE	V/W	TOL.	MFR'S DESIG	YAESU P/N	VERS.	LOT.
C 1214	CHIP CAP.	470pF	50V	B	GRM39B471M50PT	K22174805		
C 1215	CHIP CAP.	0.1uF	25V	B	GRM40B104M25PT	K22140811		
C 1216	TANTALUM CHIP CAP.	0.47uF	25V		TESVA1E474M1-8R	K78140009		
C 1217	CHIP CAP.	0.001uF	50V	B	GRM39B102M50PT	K22174809		
C 1218	CHIP CAP.	0.1uF	25V	B	GRM40B104M25PT	K22140811		
C 1219	CHIP CAP.	10pF	50V	CH	GRM39CH100D50PT	K22174211		
C 1220	CHIP CAP.	0.01uF	25V	B	GRM39B103M25PT	K22144802		
C 1221	AL.ELECTRO.CAP.	10uF	16V		ECEV1CS100SR	K48120001		
C 1222	CHIP CAP.	0.1uF	25V	B	GRM40B104M25PT	K22140811		
C 1223	CHIP CAP.	0.015uF	25V	B	GRM39B153K25PT	K22144805		
C 1224	CHIP CAP.	0.0022uF	50V	B	GRM39B222M50PT	K22174813		
C 1225	AL.ELECTRO.CAP.	1uF	50V		ECEV1HS010SR	K48170001		
C 1226	AL.ELECTRO.CAP.	47uF	16V		ECEV1CA470P	K48120003		
C 1227	CHIP CAP.	0.01uF	25V	B	GRM39B103M25PT	K22144802		
C 1228	TANTALUM CHIP CAP.	2.2uF	10V		TESVA1A225M1-8R	K78100021		
C 1229	AL.ELECTRO.CAP.	1uF	50V		ECEV1HS010SR	K48170001		
C 1230	CHIP CAP.	0.01uF	25V	B	GRM39B103M25PT	K22144802		
C 1231	AL.ELECTRO.CAP.	10uF	16V		ECEV1CS100SR	K48120001		
C 1232	TANTALUM CHIP CAP.	0.1uF	35V		TESVA1V104M1-8R	K78160025		
C 1233	AL.ELECTRO.CAP.	47uF	16V		ECEV1CA470SP	K48120005		
C 1234	CHIP CAP.	0.01uF	25V	B	GRM39B103M25PT	K22144802		
C 1235	CHIP CAP.	0.047uF	16V	B	GRM39B473K16PT	K22124804		
C 1236	CHIP CAP.	0.001uF	50V	B	GRM39B102M50PT	K22174809		
C 1237	CHIP CAP.	0.01uF	25V	B	GRM39B103M25PT	K22144802		
C 1238	CHIP CAP.	0.01uF	25V	B	GRM39B103M25PT	K22144802		
C 1239	CHIP CAP.	0.1uF	25V	B	GRM40B104M25PT	K22140811		
C 1240	AL.ELECTRO.CAP.	1000uF	16V		RE3-16V102MS 1000UF	K40129067		
C 1241	CHIP CAP.	0.047uF	16V	B	GRM39B473K16PT	K22124804		
C 1242	AL.ELECTRO.CAP.	470uF	16V		RE2-16V471M 470UF	K40129049		
C 1244	AL.ELECTRO.CAP.	10uF	25V		UUV1E100MFR1GS	K48140005		
C 1245	CHIP CAP.	820pF	50V	B	GRM39B821M50PT	K22174808		
C 1246	CHIP CAP.	0.01uF	25V	B	GRM39B103M25PT	K22144802		
C 1247	CHIP CAP.	0.0047uF	50V	B	GRM39B472M50PT	K22174817		
C 1248	CHIP CAP.	0.0022uF	50V	B	GRM39B222M50PT	K22174813		
C 1249	CHIP CAP.	0.0022uF	50V	B	GRM39B222M50PT	K22174813		
C 1250	AL.ELECTRO.CAP.	1000uF	16V		RE3-16V102MS 1000UF	K40129067		
C 1251	CHIP CAP.	0.1uF	25V	B	GRM40B104M25PT	K22140811		
C 1252	CHIP CAP.	0.001uF	50V	B	GRM39B102M50PT	K22174809		
C 1253	TANTALUM CHIP CAP.	2.2uF	10V		TESVA1A225M1-8R	K78100021		
C 1254	TANTALUM CHIP CAP.	0.1uF	35V		TESVA1V104M1-8R	K78160025		
C 1255	CHIP CAP.	0.01uF	25V	B	GRM39B103M25PT	K22144802		
C 1256	CHIP CAP.	0.01uF	25V	B	GRM39B103M25PT	K22144802		
C 1257	CHIP CAP.	0.001uF	50V	B	GRM39B102M50PT	K22174809		
C 1258	CHIP CAP.	0.01uF	25V	B	GRM39B103M25PT	K22144802		
C 1259	AL.ELECTRO.CAP.	10uF	16V		ECEV1CS100SR	K48120001		
C 1260	AL.ELECTRO.CAP.	1uF	50V		ECEV1HS010SR	K48170001		
C 1261	CHIP CAP.	0.1uF	25V	B	GRM40B104M25PT	K22140811		
C 1262	CHIP CAP.	15pF	50V	CH	GRM39CH150J50PT	K22174215		
C 1263	CHIP CAP.	0.01uF	25V	B	GRM39B103M25PT	K22144802		
C 1264	CHIP CAP.	150pF	50V	CH	GRM39CH151J50PT	K22174239		
C 1265	CHIP CAP.	150pF	50V	CH	GRM39CH151J50PT	K22174239		
C 1266	CHIP CAP.	0.001uF	50V	B	GRM39B102M50PT	K22174809		
C 1267	CHIP CAP.	0.1uF	25V	B	GRM40B104M25PT	K22140811		
C 1268	CHIP CAP.	10pF	50V	CH	GRM39CH100D50PT	K22174211		
C 1269	CHIP CAP.	0.01uF	25V	B	GRM39B103M25PT	K22144802		
C 1270	CHIP CAP.	33pF	50V	CH	GRM39CH330J50PT	K22174223		
C 1271	CHIP CAP.	0.001uF	50V	B	GRM39B102M50PT	K22174809		



# AF-CNTL Unit

REF.	DESCRIPTION	VALUE	V/W	TOL.	MFR'S DESIG	YAESU P/N	VERS.	LOT.
C 1272	CHIP CAP.	33pF	50V	CH	GRM39CH330J50PT	K22174223		
C 1273	CHIP CAP.	0.0033uF	50V	B	GRM39B332M50PT	K22174815		
C 1274	CHIP CAP.	0.001uF	50V	B	GRM39B102M50PT	K22174809		
C 1275	CHIP CAP.	0.01uF	25V	B	GRM39B103M25PT	K22144802		
C 1276	CHIP CAP.	0.001uF	50V	B	GRM39B102M50PT	K22174809		
C 1277	CHIP CAP.	0.1uF	25V	B	GRM40B104M25PT	K22140811		
C 1278	CHIP CAP.	22pF	50V	CH	GRM39CH220J50PT	K22174219		
C 1279	TANTALUM CHIP CAP.	1uF	16V		TESVA1C105M1-8R	K78120009		
C 1280	CHIP CAP.	0.0022uF	50V	B	GRM39B222M50PT	K22174813		
C 1281	CHIP CAP.	47pF	50V	CH	GRM39CH470J50PT	K22174227		
C 1282	CHIP CAP.	22pF	50V	CH	GRM39CH220J50PT	K22174219		
C 1283	CHIP CAP.	0.1uF	25V	B	GRM40B104M25PT	K22140811		
C 1284	CHIP CAP.	0.001uF	50V	B	GRM39B102M50PT	K22174809		
C 1285	CHIP CAP.	0.1uF	25V	B	GRM40B104M25PT	K22140811		
C 1286	CHIP CAP.	0.1uF	25V	B	GRM40B104M25PT	K22140811		
C 1287	CHIP CAP.	0.0022uF	50V	B	GRM39B222M50PT	K22174813		
C 1288	CHIP CAP.	0.1uF	25V	B	GRM40B104M25PT	K22140811		
C 1289	CHIP CAP.	0.0033uF	50V	B	GRM39B332M50PT	K22174815		
C 1290	CHIP CAP.	0.1uF	25V	B	GRM40B104M25PT	K22140811		
C 1291	CHIP CAP.	0.001uF	50V	B	GRM39B102M50PT	K22174809		
C 1292	CHIP CAP.	0.0022uF	50V	B	GRM39B222M50PT	K22174813		
C 1293	AL.ELECTRO.CAP.	10uF	16V		ECEV1CS100SR	K48120001		
C 1294	CHIP CAP.	0.01uF	25V	B	GRM39B103M25PT	K22144802		
C 1295	CHIP CAP.	0.1uF	25V	B	GRM40B104M25PT	K22140811		
C 1296	CHIP CAP.	0.001uF	50V	B	GRM39B102M50PT	K22174809		
C 1297	CHIP CAP.	470pF	50V	CH	GRM39CH471J50PT	K22174249		
C 1298	CHIP CAP.	0.01uF	25V	B	GRM39B103M25PT	K22144802		
C 1299	CHIP CAP.	0.001uF	50V	B	GRM39B102M50PT	K22174809		
C 1300	CHIP CAP.	470pF	50V	CH	GRM39CH471J50PT	K22174249		
C 1301	AL.ELECTRO.CAP.	47uF	16V		ECEV1CA470SP	K48120005		
C 1302	CHIP CAP.	470pF	50V	CH	GRM39CH471J50PT	K22174249		
C 1303	CHIP CAP.	100pF	50V	CH	GRM39CH101J50PT	K22174235		
C 1305	CHIP CAP.	470pF	50V	CH	GRM39CH471J50PT	K22174249		
C 1306	CHIP CAP.	0.01uF	25V	B	GRM39B103M25PT	K22144802		
C 1307	CHIP CAP.	0.01uF	25V	B	GRM39B103M25PT	K22144802		
C 1308	CHIP CAP.	0.01uF	25V	B	GRM39B103M25PT	K22144802		
C 1309	AL.ELECTRO.CAP.	10uF	16V		ECEV1CS100SR	K48120001		
C 1310	CHIP CAP.	0.01uF	25V	B	GRM39B103M25PT	K22144802		
C 1311	TANTALUM CHIP CAP.	1uF	16V		TESVA1C105M1-8R	K78120009		
C 1312	CHIP CAP.	0.01uF	25V	B	GRM39B103M25PT	K22144802		
C 1313	CHIP CAP.	0.01uF	25V	B	GRM39B103M25PT	K22144802		
C 1314	AL.ELECTRO.CAP.	1uF	50V		ECEV1HS010SR	K48170001		
C 1315	AL.ELECTRO.CAP.	1uF	50V		ECEV1HS010SR	K48170001		
C 1316	CHIP CAP.	0.001uF	50V	B	GRM39B102M50PT	K22174809		
C 1317	CHIP CAP.	33pF	50V	CH	GRM39CH330J50PT	K22174223		
C 1318	CHIP CAP.	33pF	50V	CH	GRM39CH330J50PT	K22174223		
C 1319	CHIP CAP.	0.001uF	50V	B	GRM39B102M50PT	K22174809		
C 1320	TANTALUM CHIP CAP.	10uF	6.3V		TEMSVB20J106M-8R	K78080019		
C 1321	CHIP CAP.	0.01uF	25V	B	GRM39B103M25PT	K22144802		
C 1322	CHIP CAP.	0.01uF	25V	B	GRM39B103M25PT	K22144802		
C 1323	CHIP CAP.	0.1uF	25V	B	GRM40B104M25PT	K22140811		
C 1324	CHIP CAP.	0.01uF	25V	B	GRM39B103M25PT	K22144802		
C 1325	AL.ELECTRO.CAP.	10uF	25V		UUV1E100MFR1GS	K48140005		
C 1326	CHIP CAP.	0.001uF	50V	B	GRM39B102M50PT	K22174809		
C 1327	CHIP CAP.	10pF	50V	CH	GRM39CH100D50PT	K22174211		
C 1328	CHIP CAP.	10pF	50V	CH	GRM39CH100D50PT	K22174211		
C 1329	CHIP CAP.	0.001uF	50V	B	GRM39B102M50PT	K22174809		

REF.	DESCRIPTION	VALUE	V/W	TOL.	MFR'S DESIG	YAESU P/N	VERS.	LOT.
C 1330	AL.ELECTRO.CAP.	10uF	25V		UUV1E100MFR1GS	K48140005		
C 1331	CHIP CAP.	0.01uF	25V	B	GRM39B103M25PT	K22144802		
C 1332	CHIP CAP.	0.01uF	25V	B	GRM39B103M25PT	K22144802		
C 1333	CHIP CAP.	0.01uF	25V	B	GRM39B103M25PT	K22144802		
C 1334	CHIP CAP.	0.01uF	25V	B	GRM39B103M25PT	K22144802		
C 1335	CHIP CAP.	0.047uF	16V	B	GRM39B473K16PT	K22124804		
C 1336	AL.ELECTRO.CAP.	10uF	25V		UUV1E100MFR1GS	K48140005		
C 1337	TANTALUM CHIP CAP.	1uF	16V		TESVA1C105M1-8R	K78120009		
C 1338	TANTALUM CHIP CAP.	1uF	16V		TESVA1C105M1-8R	K78120009		
C 1339	AL.ELECTRO.CAP.	10uF	16V		ECEV1CS100SR	K48120001		
C 1340	AL.ELECTRO.CAP.	100uF	6.3V		RE2-6V101M 100UF	K40089018		
C 1341	AL.ELECTRO.CAP.	10uF	25V		UUV1E100MFR1GS	K48140005		
C 1342	CHIP CAP.	0.1uF	25V	B	GRM40B104M25PT	K22140811		
C 1343	CHIP CAP.	0.01uF	25V	B	GRM39B103M25PT	K22144802		
C 1344	AL.ELECTRO.CAP.	10uF	25V		UUV1E100MFR1GS	K48140005		
C 1345	CHIP CAP.	0.01uF	25V	B	GRM39B103M25PT	K22144802		
C 1346	CHIP CAP.	0.001uF	50V	B	GRM39B102M50PT	K22174809		
C 1347	CHIP CAP.	0.01uF	25V	B	GRM39B103M25PT	K22144802		
C 1348	TANTALUM CHIP CAP.	1uF	16V		TESVA1C105M1-8R	K78120009		
C 1349	AL.ELECTRO.CAP.	470uF	16V		RE2-16V471M 470UF	K40129049		
C 1350	CHIP CAP.	0.1uF	25V	B	GRM40B104M25PT	K22140811		
C 1351	TANTALUM CHIP CAP.	2.2uF	10V		TESVA1A225M1-8R	K78100021		
C 1352	CHIP CAP.	0.01uF	25V	B	GRM39B103M25PT	K22144802		
C 1353	CHIP CAP.	0.047uF	16V	B	GRM39B473K16PT	K22124804		
C 1354	CHIP CAP.	0.001uF	50V	B	GRM39B102M50PT	K22174809		
C 1355	CHIP CAP.	0.001uF	50V	B	GRM39B102M50PT	K22174809		
C 1356	CHIP CAP.	0.001uF	50V	B	GRM39B102M50PT	K22174809		
C 1357	CHIP CAP.	0.001uF	50V	B	GRM39B102M50PT	K22174809		
C 1358	CHIP CAP.	0.001uF	50V	B	GRM39B102M50PT	K22174809		
C 1359	AL.ELECTRO.CAP.	47uF	16V		ECEV1CA470P	K48120003		
C 1360	CHIP CAP.	0.1uF	25V	B	GRM40B104M25PT	K22140811		
C 1361	CHIP CAP.	0.022uF	25V	B	GRM39B223M25PT	K22144808		
C 1362	AL.ELECTRO.CAP.	47uF	10V		RC2-10V470M(6X7)	K40109010		
C 1370	CHIP CAP.	15pF	50V	CH	GRM39CH150J50PT	K22174215		
C 1371	CHIP CAP.	0.1uF	16V	B	GRM39B104K16PT	K22124805		
C 1372	CHIP CAP.	470pF	50V	B	GRM39B471M50PT	K22174805		
C 1373	CHIP CAP.	0.1uF	16V	B	GRM39B104K16PT	K22124805		
C 1374	CERAMIC CAP.	0.022uF	25V	X	UAT06X223K-L45AE	K19149017		
C 1375	CHIP CAP.	0.1uF	16V	B	GRM39B104K16PT	K22124805		
C 1376	CHIP CAP.	0.01uF	50V	B	GRM39B103M50PT	K22174823		
C 1377	TANTALUM CAP.	2.2uF	25V		DN1E2R2M1S	K70147225		
CD1001	CERAMIC DISC				CDBM455C7	H7900480		
CF1001	CERAMIC FILTER				CFWS455E	H3900505		
CF1002	CERAMIC FILTER				CFWS455G	H3900507		
CO1001	CERAMIC OSC	4MHz			CSAC4.00MGCM-TC	H7900850		
D 1001	DIODE				DAN202K T146	G2070182		
D 1002	DIODE				DAN202K T146	G2070182		
D 1003	DIODE				DAN202K T146	G2070182		
D 1004	DIODE				1SV214 TPH	G2070356		
D 1005	DIODE				DAN202K T146	G2070182		
D 1006	DIODE				DAN202K T146	G2070182		
D 1007	DIODE				DA204K T146	G2070388		
D 1008	DIODE				DAN202K T146	G2070182		
D 1009	DIODE				DA204K T146	G2070388		
D 1010	DIODE				UDZ TE-17 3.9B	G2070576		
D 1011	DIODE				DAN202K T146	G2070182		
D 1012	DIODE				DAN202K T146	G2070182		

# AF-CNTL Unit

REF.	DESCRIPTION	VALUE	V/W	TOL.	MFR'S DESIG	YAESU P/N	VERS.	LOT.
D 1013	DIODE				DAN202K T146	G2070182		
D 1014	DIODE				IMN10 T108	G2070078		
D 1015	DIODE				DAN202K T146	G2070182		
D 1016	DIODE				DA204K T146	G2070388		
D 1017	DIODE				IMN10 T108	G2070078		
D 1018	DIODE				DAN202K T146	G2070182		
D 1019	DIODE				DAP202K T146	G2070180		
D 1020	DIODE				DAN202K T146	G2070182		
D 1021	DIODE				DAN202K T146	G2070182		
D 1022	DIODE				DAN202K T146	G2070182		
D 1023	DIODE				HVU362TRF	G2070490		
D 1024	DIODE				DAN202K T146	G2070182		
D 1025	DIODE				DAN202K T146	G2070182		
D 1026	DIODE				DAN202K T146	G2070182		
D 1027	DIODE				DA204K T146	G2070388		
D 1028	DIODE				DA204K T146	G2070388		
D 1029	DIODE				DAN202K T146	G2070182		
D 1030	DIODE				DAN202K T146	G2070182		
D 1031	DIODE				10E1	G2090306		
D 1032	DIODE				10E1	G2090306		
D 1033	DIODE				DAN202K T146	G2070182		
D 1034	DIODE				10E1	G2090306		
D 1035	DIODE				10E1	G2090306		
D 1036	DIODE				DA204K T146	G2070388		
D 1037	DIODE				DA204K T146	G2070388		
D 1038	DIODE				UDZ TE-17 16B	G2070578		
D 1039	DIODE				10E1	G2090306		
D 1040	DIODE				1SS321 TE85R	G2070076		
D 1041	DIODE				10E1	G2090306		
D 1042	DIODE				DAN202K T146	G2070182		
D 1043	DIODE				DAN202K T146	G2070182		
D 1044	DIODE				1SS270TJ	G2060004		
F 1001	FUSE				MF60NR32V30A-DC01	Q0000010		
F 1001	FUSE	30A			AF30A 30A	Q0000078		2-
FH1001	FUSE CLIP (2pcs)				S-N5051#01	P2000059		
J 1001	CONNECTOR				TMP-J01X-A2	P1090255		
J 1002	CONNECTOR				TMP-J01X-A2	P1090255		
J 1003	CONNECTOR				TMP-J01X-A2	P1090255		
J 1004	CONNECTOR				SC25-08WS	P0090627		
J 1005	CONNECTOR				SC25-04WS	P0090623		
J 1006	CONNECTOR				JPJ2545-01-510	P1090633		
J 1007	CONNECTOR				JPJ2545-01-510	P1090633		
J 1008	CONNECTOR				CSK-M50-06 R41-0599D	P1090925		
J 1009	CONNECTOR				HSJ0912-01-041	P1090749		
J 1010	CONNECTOR				SC25-02WS	P0090621		
J 1011	CONNECTOR				SC25-02WS	P0090621		
J 1012	CONNECTOR				SG8035#01	P1090350		
J 1013	CONNECTOR				SC25-03WS	P0090622		
J 1014	CONNECTOR				SC25-04WS	P0090623		
J 1015	CONNECTOR				TCS7930-15-401	P1090698		
J 1016	CONNECTOR				CSK-M50-08 R41-0576F	P1090804		
J 1017	CONNECTOR				HLJ0540-01-010	P1090565		
J 1018	TERMINAL				Y106	S5000179		
J 1019	TERMINAL				Y106	S5000179		
J 1020	CONNECTOR				SC25-02WS	P0090621		
J 1021	TERMINAL				Y106	S5000179		
J 1022	TERMINAL				Y106	S5000179		

REF.	DESCRIPTION	VALUE	V/W	TOL.	MFR'S DESIG	YAESU P/N	VERS.	LOT.
J 1023	CONNECTOR				SC25-03WS	P0090622		
J 1024	CONNECTOR				SC25-06WS	P0090625		
J 1025	CONNECTOR				SC25-10WS	P0090629		
J 1026	CONNECTOR				1210-062-09P-AA	P0091208		
J 1027	CONNECTOR				SC25-04WS	P0090623		
J 1028	CONNECTOR				SC25-05WS	P0090624		
J 1029	CONNECTOR				SC25-11WS	P0090630		
J 1030	CONNECTOR				B2B-EH	P0090666		
J 1031	CONNECTOR				3022-04B	P0090523		
J 1032	CONNECTOR				3022-04B	P0090523		
J 1033	CONNECTOR				3022-03B	P0090520		
J 1034	CONNECTOR				3022-04B	P0090523		
J 1035	CONNECTOR				3022-03B	P0090520		
J 1036	CONNECTOR				3022-04B	P0090523		
JP1001	CHIP RES.	0ohm	1/16W	5%	RMC1/16 000JATP	J24185000	VERSION A1	
JP1001	CHIP RES.	0ohm	1/16W	5%	RMC1/16 000JATP	J24185000	VERSION A2	
JP1001	CHIP RES.	0ohm	1/16W	5%	RMC1/16 000JATP	J24185000	VERSION C1	
JP1001	CHIP RES.	0ohm	1/16W	5%	RMC1/16 000JATP	J24185000	VERSION H1	
JP1002	CHIP RES.	0ohm	1/16W	5%	RMC1/16 000JATP	J24185000	VERSION B1	
JP1002	CHIP RES.	0ohm	1/16W	5%	RMC1/16 000JATP	J24185000	VERSION C1	
JP1002	CHIP RES.	0ohm	1/16W	5%	RMC1/16 000JATP	J24185000	VERSION E1	
JP1003	CHIP RES.	0ohm	1/16W	5%	RMC1/16 000JATP	J24185000	VERSION D1	
JP1003	CHIP RES.	0ohm	1/16W	5%	RMC1/16 000JATP	J24185000	VERSION E1	
JP1003	CHIP RES.	0ohm	1/16W	5%	RMC1/16 000JATP	J24185000	VERSION H1	
JP1004	CHIP RES.	0ohm	1/16W	5%	RMC1/16 000JATP	J24185000	VERSION A1	
JP1004	CHIP RES.	0ohm	1/16W	5%	RMC1/16 000JATP	J24185000	VERSION B1	
JP1004	CHIP RES.	0ohm	1/16W	5%	RMC1/16 000JATP	J24185000	VERSION C1	
JP1004	CHIP RES.	0ohm	1/16W	5%	RMC1/16 000JATP	J24185000	VERSION D1	
JP1004	CHIP RES.	0ohm	1/16W	5%	RMC1/16 000JATP	J24185000	VERSION E1	
JP1004	CHIP RES.	0ohm	1/16W	5%	RMC1/16 000JATP	J24185000	VERSION H1	
JP1005	CHIP RES.	0ohm	1/16W	5%	RMC1/16 000JATP	J24185000	VERSION A1	
JP1005	CHIP RES.	0ohm	1/16W	5%	RMC1/16 000JATP	J24185000	VERSION A2	
JP1005	CHIP RES.	0ohm	1/16W	5%	RMC1/16 000JATP	J24185000	VERSION B1	
JP1005	CHIP RES.	0ohm	1/16W	5%	RMC1/16 000JATP	J24185000	VERSION B2	
JP1005	CHIP RES.	0ohm	1/16W	5%	RMC1/16 000JATP	J24185000	VERSION C1	
JP1005	CHIP RES.	0ohm	1/16W	5%	RMC1/16 000JATP	J24185000	VERSION C2	
JP1005	CHIP RES.	0ohm	1/16W	5%	RMC1/16 000JATP	J24185000	VERSION D1	
JP1005	CHIP RES.	0ohm	1/16W	5%	RMC1/16 000JATP	J24185000	VERSION D2	
JP1005	CHIP RES.	0ohm	1/16W	5%	RMC1/16 000JATP	J24185000	VERSION E1	
JP1005	CHIP RES.	0ohm	1/16W	5%	RMC1/16 000JATP	J24185000	VERSION E2	
JP1005	CHIP RES.	0ohm	1/16W	5%	RMC1/16 000JATP	J24185000	VERSION H1	
JP1005	CHIP RES.	0ohm	1/16W	5%	RMC1/16 000JATP	J24185000	VERSION H2	
JP1006	CHIP RES.	0ohm	1/16W	5%	RMC1/16 000JATP	J24185000	VERSION A1	
JP1006	CHIP RES.	0ohm	1/16W	5%	RMC1/16 000JATP	J24185000	VERSION A2	
JP1006	CHIP RES.	0ohm	1/16W	5%	RMC1/16 000JATP	J24185000	VERSION A3	
JP1006	CHIP RES.	0ohm	1/16W	5%	RMC1/16 000JATP	J24185000	VERSION B1	
JP1006	CHIP RES.	0ohm	1/16W	5%	RMC1/16 000JATP	J24185000	VERSION B2	
JP1006	CHIP RES.	0ohm	1/16W	5%	RMC1/16 000JATP	J24185000	VERSION B3	
JP1006	CHIP RES.	0ohm	1/16W	5%	RMC1/16 000JATP	J24185000	VERSION C1	
JP1006	CHIP RES.	0ohm	1/16W	5%	RMC1/16 000JATP	J24185000	VERSION C2	
JP1006	CHIP RES.	0ohm	1/16W	5%	RMC1/16 000JATP	J24185000	VERSION C3	
JP1006	CHIP RES.	0ohm	1/16W	5%	RMC1/16 000JATP	J24185000	VERSION D1	
JP1006	CHIP RES.	0ohm	1/16W	5%	RMC1/16 000JATP	J24185000	VERSION D2	
JP1006	CHIP RES.	0ohm	1/16W	5%	RMC1/16 000JATP	J24185000	VERSION E1	
JP1006	CHIP RES.	0ohm	1/16W	5%	RMC1/16 000JATP	J24185000	VERSION E2	
JP1006	CHIP RES.	0ohm	1/16W	5%	RMC1/16 000JATP	J24185000	VERSION E3	
JP1006	CHIP RES.	0ohm	1/16W	5%	RMC1/16 000JATP	J24185000	VERSION H1	

# AF-CNTL Unit

REF.	DESCRIPTION	VALUE	V/W	TOL.	MFR'S DESIG	YAESU P/N	VERS.	LOT.
JP1006	CHIP RES.	0ohm	1/16W	5%	RMC1/16 000JATP	J24185000	VERSION H2	
L 1001	M.RFC	0.27uH			ELJ-FCR27MF	L1690341		
L 1003	M.RFC	4.7uH			ELJ-FC4R7KF	L1690348		
L 1004	M.RFC	0.68uH			ELJ-FAR68MF	L1690398		
L 1005	CHIP COIL	1mH			LQH4N102K-S	L1690108		
L 1006	CHIP COIL	1mH			LQH4N102K-S	L1690108		
L 1007	CHIP COIL	1mH			LQH4N102K-S	L1690108		
L 1008	M.RFC	15uH			FLC32T-150J	L1690217		
L 1009	M.RFC	15uH			FLC32T-150J	L1690217		
L 1010	M.RFC	330uH			FLC32T-331J	L1690233		
L 1011	M.RFC	330uH			FLC32T-331J	L1690233		
L 1012	M.RFC	330uH			FLC32T-331J	L1690233		
L 1013	M.RFC	330uH			FLC32T-331J	L1690233		
L 1014	TOROIDAL COIL				D12A RI16X8X8	L0022119		
Q 1001	TRANSISTOR				2SC2620QBTR	G3326207B		
Q 1002	TRANSISTOR				FMW1 T98	G3070009		
Q 1003	TRANSISTOR				DTC114EK T96	G3070002		
Q 1004	TRANSISTOR				2SC1623-T2BL5	G3316237E		
Q 1005	TRANSISTOR				2SA812-T2B M5B	G3108127E		
Q 1006	TRANSISTOR				FMW8 T148	G3070155		
Q 1007	TRANSISTOR				FMW8 T148	G3070155		
Q 1008	TRANSISTOR				FMW1 T98	G3070009		
Q 1009	TRANSISTOR				DTC114EK T96	G3070002		
Q 1010	TRANSISTOR				2SC3120TE85R	G3331207		
Q 1011	IC				FQ7925	G1091710		
Q 1012	TRANSISTOR				DTC114EK T96	G3070002		
Q 1013	TRANSISTOR				2SC1623-T2BL5	G3316237E		
Q 1014	TRANSISTOR				2SC1623-T2BL5	G3316237E		
Q 1015	TRANSISTOR				2SC3120TE85R	G3331207		
Q 1016	TRANSISTOR				FMW1 T98	G3070009		
Q 1017	TRANSISTOR				2SA812-T2B M5B	G3108127E		
Q 1018	TRANSISTOR				2SC2620QBTR	G3326207B		
Q 1019	IC				NJM2902M-T2	G1090908		
Q 1021	TRANSISTOR				2SC1623-T2BL5	G3316237E		
Q 1022	IC				SN16913P	G1090012		
Q 1023	TRANSISTOR				2SC1623-T2BL5	G3316237E		
Q 1024	FET				2SK210GR TE85R	G3802107G		
Q 1025	TRANSISTOR				DTA143EK T146	G3070010		
Q 1026	IC				TA75S01F TE85R	G1091593		
Q 1027	TRANSISTOR				2SC3120TE85R	G3331207		
Q 1028	TRANSISTOR				DTC114EK T96	G3070002		
Q 1029	TRANSISTOR				2SC2620QBTR	G3326207B		
Q 1030	TRANSISTOR				2SC1623-T2BL5	G3316237E		
Q 1031	TRANSISTOR				DTC124EK T146	G3070034		
Q 1032	TRANSISTOR				DTA143EK T146	G3070010		
Q 1033	TRANSISTOR				DTC114EK T96	G3070002		
Q 1034	TRANSISTOR				2SC3120TE85R	G3331207		
Q 1035	TRANSISTOR				DTA143EK T146	G3070010		
Q 1036	TRANSISTOR				2SC3120TE85R	G3331207		
Q 1037	TRANSISTOR				2SC3120TE85R	G3331207		
Q 1038	IC				NJM2902M-T2	G1090908		
Q 1039	TRANSISTOR				DTC114EK T96	G3070002		
Q 1040	IC				TA75S01F TE85R	G1091593		
Q 1041	IC				TC4S66F TE85R	G1090893		
Q 1042	TRANSISTOR				DTC114EK T96	G3070002		
Q 1043	TRANSISTOR				2SC1623-T2BL5	G3316237E		
Q 1044	TRANSISTOR				2SC3120TE85R	G3331207		

REF.	DESCRIPTION	VALUE	VW	TOL.	MFR'S DESIG	YAESU P/N	VERS.	LOT.
Q 1045	TRANSISTOR				IMD3 T108	G3070053		
Q 1046	TRANSISTOR				DTC144EK T146	G3070033		
Q 1047	TRANSISTOR				DTC144EK T146	G3070033		
Q 1048	TRANSISTOR				2SC1623-T2BL5	G3316237E		
Q 1049	TRANSISTOR				DTC144EK T146	G3070033		
Q 1050	TRANSISTOR				DTC144EK T146	G3070033		
Q 1051	TRANSISTOR				2SC3120TE85R	G3331207		
Q 1052	TRANSISTOR				2SC1623-T2BL5	G3316237E		
Q 1053	IC				M5207L01	G1092622		
Q 1054	IC				BU4053BCF(TAPING)	G1092723		
Q 1055	TRANSISTOR				2SC1623-T2BL5	G3316237E		
Q 1056	TRANSISTOR				2SA812-T2B M5B	G3108127E		
Q 1057	TRANSISTOR				2SC1623-T2BL5	G3316237E		
Q 1058	TRANSISTOR				FMW1 T98	G3070009		
Q 1059	TRANSISTOR				2SC1623-T2BL5	G3316237E		
Q 1060	IC				MC3372DR	G1091339		
Q 1061	TRANSISTOR				FMW1 T98	G3070009		
Q 1062	IC				M5207L01	G1092622		
Q 1063	IC				TC4S66F TE85R	G1090893		
Q 1064	IC				BU4094BCF-E2	G1092684		
Q 1065	IC				TC4S66F TE85R	G1090893		
Q 1066	TRANSISTOR				FMW1 T98	G3070009		
Q 1068	TRANSISTOR				2SC1623-T2BL5	G3316237E		
Q 1069	TRANSISTOR				2SC1623-T2BL5	G3316237E		
Q 1070	IC				NJM2904M-T2	G1091374		
Q 1071	IC				NJM2902M-T2	G1090908		
Q 1072	IC				BU4094BCF-E2	G1092684		
Q 1073	TRANSISTOR				2SC1623-T2BL5	G3316237E		
Q 1074	IC				TA75S01F TE85R	G1091593		
Q 1076	TRANSISTOR				DTC124EK T146	G3070034		
Q 1077	IC				SN16913P	G1090012		
Q 1078	TRANSISTOR				DTC124EK T146	G3070034		
Q 1079	TRANSISTOR				2SC1623-T2BL5	G3316237E		
Q 1080	IC				SN16913P	G1090012		
Q 1081	IC				BU4053BCF(TAPING)	G1092723		
Q 1082	TRANSISTOR				2SC1623-T2BL5	G3316237E		
Q 1083	IC				NJM2904M-T2	G1091374		
Q 1084	TRANSISTOR				2SC1623-T2BL5	G3316237E		
Q 1085	IC				NJM2902M-T2	G1090908		
Q 1086	IC				TDA2003H	G1090815		
Q 1087	IC				BU4066BF-E2	G1092593		
Q 1088	TRANSISTOR				DTC124EK T146	G3070034		
Q 1090	IC				TC4S66F TE85R	G1090893		
Q 1092	TRANSISTOR				2SA812-T2B M5B	G3108127E		
Q 1093	IC				M62353GP 70ED	G1092621		
Q 1094	IC				TA75S01F TE85R	G1091593		
Q 1095	TRANSISTOR				DTC124EK T146	G3070034		
Q 1096	TRANSISTOR				2SD2211 T100 QR	G3422117Q		
Q 1097	TRANSISTOR				2SC2620QBTR	G3326207B		
Q 1098	TRANSISTOR				2SD2211 T100 QR	G3422117Q		
Q 1099	TRANSISTOR				2SC2620QBTR	G3326207B		
Q 1100	IC				MB8854-1244M	G1090999		
Q 1101	TRANSISTOR				DTC124EK T146	G3070034		
Q 1102	IC				NJM2904M-T2	G1091374		
Q 1103	TRANSISTOR				2SD2211 T100 QR	G3422117Q		
Q 1104	TRANSISTOR				DTC124EK T146	G3070034		
Q 1105	IC				HD6473048SF16	G1092800	AUSTRALIA	

# AF-CNTL Unit

REF.	DESCRIPTION	VALUE	V/W	TOL.	MFR'S DESIG	YAESU P/N	VERS.	LOT.
Q 1105	IC				HD6473048SF16	G1092789	EXPORT	
Q 1105	IC				HD6473048SF16	G1092801	FRANCE	
Q 1105	IC				HD6473048SF16	G1092789	USA	
Q 1106	TRANSISTOR				DTC114EK T96	G3070002		
Q 1107	IC				BU4053BCF(TAPING)	G1092723		
Q 1108	TRANSISTOR				2SD2211 T100 QR	G3422117Q		
Q 1109	IC				KIA7808PI	G1092425		
Q 1110	TRANSISTOR				DTC114EK T96	G3070002		
Q 1111	IC				KIA7805PI	G1092261		
Q 1112	IC				BU4011BF(TAPING)	G1092724		
Q 1113	TRANSISTOR				DTC114EK T96	G3070002		
Q 1114	IC				NJM2902M-T2	G1090908		
Q 1115	IC				BU4066BF-E2	G1092593		
Q 1116	IC				FQ7928	G1092005		
Q 1117	IC				FQ7928	G1092005		
Q 1118	TRANSISTOR				DTC114TK T146	G3070073		
Q 1119	IC				BU4081BF	G1092720		
Q 1120	IC				BU4081BF	G1092720		
Q 1121	IC				BR93LC46F-E2	G1091867		
Q 1122	TRANSISTOR				2SC1623-T2BL5	G3316237E		
Q 1123	TRANSISTOR				2SA812-T2B M5B	G3108127E		
Q 1124	IC				NJM2904M-T2	G1091374		
Q 1125	TRANSISTOR				2SC2620QBTR	G3326207B		
Q 1126	TRANSISTOR				2SC2620QBTR	G3326207B		
Q 1127	TRANSISTOR				2SC1623-T2BL5	G3316237E		
Q 1128	TRANSISTOR				DTA124EK T146	G3070030		
Q 1129	IC				NJM2903M T2	G1091073		
Q 1130	IC				MAX232CWE-T	G1091907		
Q 1131	TRANSISTOR				2SC1623-T2BL5	G3316237E		
Q 1132	TRANSISTOR				DTC144EK T146	G3070033		
Q 1133	TRANSISTOR				2SC1623-T2BL5	G3316237E		
Q 1134	IC				NJM78L05UA TE2	G1091325		
Q 1135	IC				RH5VL45AA-T1	G1090966		
Q 1136	TRANSISTOR				DTA124EK T146	G3070030		
Q 1137	TRANSISTOR				2SC1623-T2BL5	G3316237E		
Q 1138	TRANSISTOR				DTD114EK T146	G3070146		
Q 1139	TRANSISTOR				2SA1870 TL E	G3118708E		
Q 1140	TRANSISTOR				2SA812-T2B M5B	G3108127E		
Q 1141	TRANSISTOR				2SC1623-T2BL5	G3316237E		
Q 1142	TRANSISTOR				2SC1623-T2BL5	G3316237E		
Q 1143	TRANSISTOR				2SC1623-T2BL5	G3316237E		
Q 1144	TRANSISTOR				DTC144EK T146	G3070033		
Q 1145	TRANSISTOR				BA1A4M-T	G3050001		
Q 1146	TRANSISTOR				BA1A4M-T	G3050001		
Q 1147	TRANSISTOR				BA1A4M-T	G3050001		
Q 1148	TRANSISTOR				BN1A4M-T	G3050004		
R 1001	CHIP RES.	470ohm	1/16W	5%	RMC1/16 471JATP	J24185471		
R 1002	CHIP RES.	68kohm	1/16W	5%	RMC1/16 683JATP	J24185683		
R 1003	CHIP RES.	470ohm	1/16W	5%	RMC1/16 471JATP	J24185471		
R 1004	CHIP RES.	1kohm	1/16W	5%	RMC1/16 102JATP	J24185102		
R 1005	CHIP RES.	1kohm	1/16W	5%	RMC1/16 102JATP	J24185102		
R 1006	CHIP RES.	10kohm	1/16W	5%	RMC1/16 103JATP	J24185103		
R 1007	CHIP RES.	4.7kohm	1/16W	5%	RMC1/16 472JATP	J24185472		
R 1008	CHIP RES.	22kohm	1/16W	5%	RMC1/16 223JATP	J24185223		
R 1009	CHIP RES.	100ohm	1/16W	5%	RMC1/16 101JATP	J24185101		
R 1010	CHIP RES.	5.6kohm	1/16W	5%	RMC1/16 562JATP	J24185562		
R 1011	CHIP RES.	10kohm	1/16W	5%	RMC1/16 103JATP	J24185103		

REF.	DESCRIPTION	VALUE	V/W	TOL.	MFR'S DESIG	YAESU P/N	VERS.	LOT.
R 1012	CHIP RES.	100ohm	1/16W	5%	RMC1/16 101JATP	J24185101		
R 1013	CHIP RES.	100ohm	1/16W	5%	RMC1/16 101JATP	J24185101		
R 1014	CHIP RES.	47ohm	1/16W	5%	RMC1/16 470JATP	J24185470		
R 1015	CHIP RES.	4.7kohm	1/16W	5%	RMC1/16 472JATP	J24185472		
R 1016	CHIP RES.	10kohm	1/16W	5%	RMC1/16 103JATP	J24185103		
R 1017	CHIP RES.	4.7kohm	1/16W	5%	RMC1/16 472JATP	J24185472		
R 1018	CHIP RES.	1kohm	1/16W	5%	RMC1/16 102JATP	J24185102		
R 1019	CHIP RES.	1kohm	1/16W	5%	RMC1/16 102JATP	J24185102		
R 1020	CHIP RES.	330ohm	1/16W	5%	RMC1/16 331JATP	J24185331		
R 1021	CHIP RES.	1Mohm	1/16W	5%	RMC1/16 105JATP	J24185105		
R 1022	CHIP RES.	22kohm	1/16W	5%	RMC1/16 223JATP	J24185223		
R 1023	CHIP RES.	470ohm	1/16W	5%	RMC1/16 471JATP	J24185471		
R 1024	CHIP RES.	4.7kohm	1/16W	5%	RMC1/16 472JATP	J24185472		
R 1025	CHIP RES.	10kohm	1/16W	5%	RMC1/16 103JATP	J24185103		
R 1026	CHIP RES.	1kohm	1/16W	5%	RMC1/16 102JATP	J24185102		
R 1027	CHIP RES.	470ohm	1/16W	5%	RMC1/16 471JATP	J24185471		
R 1028	CHIP RES.	4.7kohm	1/16W	5%	RMC1/16 472JATP	J24185472		
R 1029	CHIP RES.	10kohm	1/16W	5%	RMC1/16 103JATP	J24185103		
R 1030	CHIP RES.	4.7kohm	1/16W	5%	RMC1/16 472JATP	J24185472		
R 1031	CHIP RES.	22kohm	1/16W	5%	RMC1/16 223JATP	J24185223		
R 1032	CHIP RES.	6.8kohm	1/16W	5%	RMC1/16 682JATP	J24185682		
R 1033	CHIP RES.	47ohm	1/16W	5%	RMC1/16 470JATP	J24185470		
R 1034	CHIP RES.	22kohm	1/16W	5%	RMC1/16 223JATP	J24185223		
R 1035	CHIP RES.	4.7kohm	1/16W	5%	RMC1/16 472JATP	J24185472		
R 1036	CHIP RES.	2.2kohm	1/16W	5%	RMC1/16 222JATP	J24185222		
R 1037	CHIP RES.	10kohm	1/16W	5%	RMC1/16 103JATP	J24185103		
R 1038	CHIP RES.	100ohm	1/16W	5%	RMC1/16 101JATP	J24185101		
R 1039	CHIP RES.	100ohm	1/16W	5%	RMC1/16 101JATP	J24185101		
R 1040	CHIP RES.	1kohm	1/16W	5%	RMC1/16 102JATP	J24185102		
R 1041	CHIP RES.	100kohm	1/16W	5%	RMC1/16 104JATP	J24185104		
R 1042	CHIP RES.	100kohm	1/16W	5%	RMC1/16 104JATP	J24185104		
R 1044	CHIP RES.	1kohm	1/16W	5%	RMC1/16 102JATP	J24185102		
R 1046	CHIP RES.	4.7kohm	1/16W	5%	RMC1/16 472JATP	J24185472		
R 1047	CHIP RES.	10kohm	1/16W	5%	RMC1/16 103JATP	J24185103		
R 1048	CHIP RES.	1kohm	1/16W	5%	RMC1/16 102JATP	J24185102		
R 1049	CHIP RES.	100kohm	1/16W	5%	RMC1/16 104JATP	J24185104		
R 1050	CHIP RES.	10kohm	1/16W	5%	RMC1/16 103JATP	J24185103		
R 1051	CHIP RES.	100ohm	1/16W	5%	RMC1/16 101JATP	J24185101		
R 1052	CHIP RES.	10kohm	1/16W	5%	RMC1/16 103JATP	J24185103		
R 1053	CHIP RES.	100kohm	1/16W	5%	RMC1/16 104JATP	J24185104		
R 1054	CHIP RES.	100ohm	1/16W	5%	RMC1/16 101JATP	J24185101		
R 1055	CHIP RES.	4.7kohm	1/16W	5%	RMC1/16 472JATP	J24185472		
R 1056	CHIP RES.	100kohm	1/16W	5%	RMC1/16 104JATP	J24185104		
R 1057	CHIP RES.	22kohm	1/16W	5%	RMC1/16 223JATP	J24185223		
R 1058	CHIP RES.	100kohm	1/16W	5%	RMC1/16 104JATP	J24185104		
R 1059	CHIP RES.	2.2kohm	1/16W	5%	RMC1/16 222JATP	J24185222		
R 1060	CHIP RES.	100ohm	1/16W	5%	RMC1/16 101JATP	J24185101		
R 1061	CHIP RES.	330kohm	1/16W	5%	RMC1/16 334JATP	J24185334		
R 1062	CHIP RES.	1kohm	1/16W	5%	RMC1/16 102JATP	J24185102		
R 1063	CHIP RES.	2.2kohm	1/16W	5%	RMC1/16 222JATP	J24185222		
R 1064	CHIP RES.	100kohm	1/16W	5%	RMC1/16 104JATP	J24185104		
R 1065	CHIP RES.	6.8kohm	1/16W	5%	RMC1/16 682JATP	J24185682		
R 1066	CHIP RES.	10kohm	1/16W	5%	RMC1/16 103JATP	J24185103		
R 1067	CHIP RES.	2.2kohm	1/16W	5%	RMC1/16 222JATP	J24185222		
R 1068	CHIP RES.	47ohm	1/16W	5%	RMC1/16 470JATP	J24185470		
R 1069	CHIP RES.	470kohm	1/16W	5%	RMC1/16 474JATP	J24185474		
R 1071	CHIP RES.	470kohm	1/16W	5%	RMC1/16 474JATP	J24185474		



# AF-CNTL Unit

REF.	DESCRIPTION	VALUE	V/W	TOL.	MFR'S DESIG	YAESU P/N	VERS.	LOT.
R 1072	CHIP RES.	3.9kohm	1/16W	5%	RMC1/16 392JATP	J24185392		
R 1073	CHIP RES.	1Mohm	1/16W	5%	RMC1/16 105JATP	J24185105		
R 1074	CHIP RES.	4.7kohm	1/16W	5%	RMC1/16 472JATP	J24185472		
R 1075	CHIP RES.	2.2kohm	1/16W	5%	RMC1/16 222JATP	J24185222		
R 1076	CHIP RES.	1kohm	1/16W	5%	RMC1/16 102JATP	J24185102		
R 1077	CHIP RES.	47ohm	1/16W	5%	RMC1/16 470JATP	J24185470		
R 1078	CHIP RES.	330kohm	1/16W	5%	RMC1/16 334JATP	J24185334		
R 1079	CHIP RES.	10kohm	1/16W	5%	RMC1/16 103JATP	J24185103		
R 1080	CHIP RES.	2.2kohm	1/16W	5%	RMC1/16 222JATP	J24185222		
R 1081	CHIP RES.	470kohm	1/16W	5%	RMC1/16 474JATP	J24185474		
R 1082	CHIP RES.	470ohm	1/16W	5%	RMC1/16 471JATP	J24185471		
R 1083	CHIP RES.	6.8kohm	1/16W	5%	RMC1/16 682JATP	J24185682		
R 1084	CHIP RES.	100ohm	1/16W	5%	RMC1/16 101JATP	J24185101		
R 1085	CHIP RES.	0ohm	1/16W	5%	RMC1/16 000JATP	J24185000		
R 1086	CHIP RES.	1Mohm	1/16W	5%	RMC1/16 105JATP	J24185105		
R 1087	CHIP RES.	2.2kohm	1/16W	5%	RMC1/16 222JATP	J24185222		
R 1088	CHIP RES.	47kohm	1/16W	5%	RMC1/16 473JATP	J24185473		
R 1089	CHIP RES.	47kohm	1/16W	5%	RMC1/16 473JATP	J24185473		
R 1090	CHIP RES.	4.7kohm	1/16W	5%	RMC1/16 472JATP	J24185472		
R 1092	CHIP RES.	100ohm	1/16W	5%	RMC1/16 101JATP	J24185101		
R 1093	CHIP RES.	220ohm	1/16W	5%	RMC1/16 221JATP	J24185221		
R 1094	CHIP RES.	47kohm	1/16W	5%	RMC1/16 473JATP	J24185473		
R 1095	CHIP RES.	1kohm	1/16W	5%	RMC1/16 102JATP	J24185102		
R 1096	CHIP RES.	47kohm	1/16W	5%	RMC1/16 473JATP	J24185473		
R 1097	CHIP RES.	4.7kohm	1/16W	5%	RMC1/16 472JATP	J24185472		
R 1098	CHIP RES.	47kohm	1/16W	5%	RMC1/16 473JATP	J24185473		
R 1099	CHIP RES.	10kohm	1/16W	5%	RMC1/16 103JATP	J24185103		
R 1100	CHIP RES.	1kohm	1/16W	5%	RMC1/16 102JATP	J24185102		
R 1101	CHIP RES.	100ohm	1/16W	5%	RMC1/16 101JATP	J24185101		
R 1102	CHIP RES.	6.8kohm	1/16W	5%	RMC1/16 682JATP	J24185682		
R 1103	CHIP RES.	47kohm	1/16W	5%	RMC1/16 473JATP	J24185473		
R 1105	CHIP RES.	22kohm	1/16W	5%	RMC1/16 223JATP	J24185223		
R 1106	CHIP RES.	4.7kohm	1/16W	5%	RMC1/16 472JATP	J24185472		
R 1107	CHIP RES.	2.2kohm	1/16W	5%	RMC1/16 222JATP	J24185222		
R 1108	CHIP RES.	10kohm	1/16W	5%	RMC1/16 103JATP	J24185103		
R 1109	CHIP RES.	100ohm	1/16W	5%	RMC1/16 101JATP	J24185101		
R 1110	CHIP RES.	10kohm	1/16W	5%	RMC1/16 103JATP	J24185103		
R 1111	CHIP RES.	4.7kohm	1/16W	5%	RMC1/16 472JATP	J24185472		
R 1112	CHIP RES.	100ohm	1/16W	5%	RMC1/16 101JATP	J24185101		
R 1113	CHIP RES.	1.5kohm	1/16W	5%	RMC1/16 152JATP	J24185152		
R 1114	CHIP RES.	2.2kohm	1/16W	5%	RMC1/16 222JATP	J24185222		
R 1115	CHIP RES.	470ohm	1/16W	5%	RMC1/16 471JATP	J24185471		
R 1116	CHIP RES.	47kohm	1/16W	5%	RMC1/16 473JATP	J24185473		
R 1117	CHIP RES.	1kohm	1/16W	5%	RMC1/16 102JATP	J24185102		
R 1118	CHIP RES.	47kohm	1/16W	5%	RMC1/16 473JATP	J24185473		
R 1119	CHIP RES.	4.7kohm	1/16W	5%	RMC1/16 472JATP	J24185472		
R 1120	CHIP RES.	47kohm	1/16W	5%	RMC1/16 473JATP	J24185473		
R 1121	CHIP RES.	47kohm	1/16W	5%	RMC1/16 473JATP	J24185473		
R 1122	CHIP RES.	470ohm	1/16W	5%	RMC1/16 471JATP	J24185471		
R 1123	CHIP RES.	100ohm	1/16W	5%	RMC1/16 101JATP	J24185101		
R 1124	CHIP RES.	22kohm	1/16W	5%	RMC1/16 223JATP	J24185223		
R 1125	CHIP RES.	2.2kohm	1/16W	5%	RMC1/16 222JATP	J24185222		
R 1126	CHIP RES.	2.2kohm	1/16W	5%	RMC1/16 222JATP	J24185222		
R 1127	CHIP RES.	2.2kohm	1/16W	5%	RMC1/16 222JATP	J24185222		
R 1128	CHIP RES.	2.2kohm	1/16W	5%	RMC1/16 222JATP	J24185222		
R 1129	CHIP RES.	100kohm	1/16W	5%	RMC1/16 104JATP	J24185104		
R 1130	CHIP RES.	1kohm	1/16W	5%	RMC1/16 102JATP	J24185102		

REF.	DESCRIPTION	VALUE	V/W	TOL.	MFR'S DESIG	YAESU P/N	VERS.	LOT.
R 1131	CHIP RES.	1kohm	1/16W	5%	RMC1/16 102JATP	J24185102		
R 1132	CHIP RES.	47kohm	1/16W	5%	RMC1/16 473JATP	J24185473		
R 1133	CHIP RES.	6.8kohm	1/16W	5%	RMC1/16 682JATP	J24185682		
R 1134	CHIP RES.	68kohm	1/16W	5%	RMC1/16 683JATP	J24185683		
R 1135	CHIP RES.	470ohm	1/16W	5%	RMC1/16 471JATP	J24185471		
R 1136	CHIP RES.	470ohm	1/16W	5%	RMC1/16 471JATP	J24185471		
R 1137	CHIP RES.	470ohm	1/16W	5%	RMC1/16 471JATP	J24185471		
R 1138	CHIP RES.	470ohm	1/16W	5%	RMC1/16 471JATP	J24185471		
R 1139	CHIP RES.	4.7kohm	1/16W	5%	RMC1/16 472JATP	J24185472		
R 1140	CHIP RES.	22kohm	1/16W	5%	RMC1/16 223JATP	J24185223		
R 1141	CHIP RES.	100ohm	1/16W	5%	RMC1/16 101JATP	J24185101		
R 1142	CHIP RES.	22kohm	1/16W	5%	RMC1/16 223JATP	J24185223		
R 1143	CHIP RES.	22kohm	1/16W	5%	RMC1/16 223JATP	J24185223		
R 1144	CHIP RES.	22kohm	1/16W	5%	RMC1/16 223JATP	J24185223		
R 1145	CHIP RES.	22kohm	1/16W	5%	RMC1/16 223JATP	J24185223		
R 1146	CHIP RES.	47kohm	1/16W	5%	RMC1/16 473JATP	J24185473		
R 1147	CHIP RES.	1Mohm	1/16W	5%	RMC1/16 105JATP	J24185105		
R 1148	CHIP RES.	1kohm	1/16W	5%	RMC1/16 102JATP	J24185102		
R 1149	CHIP RES.	1kohm	1/16W	5%	RMC1/16 102JATP	J24185102		
R 1150	CHIP RES.	12kohm	1/16W	5%	RMC1/16 123JATP	J24185123		
R 1151	CHIP RES.	2.2kohm	1/16W	5%	RMC1/16 222JATP	J24185222		
R 1152	CHIP RES.	2.2kohm	1/16W	5%	RMC1/16 222JATP	J24185222		
R 1153	CHIP RES.	2.2kohm	1/16W	5%	RMC1/16 222JATP	J24185222		
R 1154	CHIP RES.	2.2kohm	1/16W	5%	RMC1/16 222JATP	J24185222		
R 1155	CHIP RES.	47ohm	1/16W	5%	RMC1/16 470JATP	J24185470		
R 1156	CHIP RES.	10kohm	1/16W	5%	RMC1/16 103JATP	J24185103		
R 1157	CHIP RES.	3.3kohm	1/16W	5%	RMC1/16 332JATP	J24185332		
R 1158	CHIP RES.	47ohm	1/16W	5%	RMC1/16 470JATP	J24185470		
R 1159	CHIP RES.	22kohm	1/16W	5%	RMC1/16 223JATP	J24185223		
R 1160	CHIP RES.	8.2kohm	1/16W	5%	RMC1/16 822JATP	J24185822		
R 1161	CHIP RES.	47ohm	1/16W	5%	RMC1/16 470JATP	J24185470		
R 1162	CHIP RES.	100ohm	1/16W	5%	RMC1/16 101JATP	J24185101		
R 1163	CHIP RES.	6.8kohm	1/16W	5%	RMC1/16 682JATP	J24185682		
R 1164	CHIP RES.	47ohm	1/16W	5%	RMC1/16 470JATP	J24185470		
R 1165	CHIP RES.	0ohm	1/16W	5%	RMC1/16 000JATP	J24185000		
R 1166	CHIP RES.	330ohm	1/16W	5%	RMC1/16 331JATP	J24185331		
R 1167	CHIP RES.	10kohm	1/16W	5%	RMC1/16 103JATP	J24185103		
R 1168	CHIP RES.	10kohm	1/16W	5%	RMC1/16 103JATP	J24185103		
R 1169	CHIP RES.	100ohm	1/16W	5%	RMC1/16 101JATP	J24185101		
R 1170	CHIP RES.	47ohm	1/16W	5%	RMC1/16 470JATP	J24185470		
R 1171	CHIP RES.	470ohm	1/16W	5%	RMC1/16 471JATP	J24185471		
R 1172	CHIP RES.	2.2kohm	1/16W	5%	RMC1/16 222JATP	J24185222		
R 1173	CHIP RES.	1kohm	1/16W	5%	RMC1/16 102JATP	J24185102		
R 1174	CHIP RES.	2.2kohm	1/16W	5%	RMC1/16 222JATP	J24185222		
R 1175	CHIP RES.	100kohm	1/16W	5%	RMC1/16 104JATP	J24185104		
R 1176	CHIP RES.	4.7kohm	1/16W	5%	RMC1/16 472JATP	J24185472		
R 1177	CHIP RES.	22kohm	1/16W	5%	RMC1/16 223JATP	J24185223		
R 1178	CHIP RES.	1kohm	1/16W	5%	RMC1/16 102JATP	J24185102		
R 1180	CHIP RES.	22kohm	1/16W	5%	RMC1/16 223JATP	J24185223		
R 1182	CHIP RES.	2.2kohm	1/16W	5%	RMC1/16 222JATP	J24185222		
R 1183	CHIP RES.	100ohm	1/16W	5%	RMC1/16 101JATP	J24185101		
R 1184	CHIP RES.	0ohm	1/16W	5%	RMC1/16 000JATP	J24185000		
R 1186	CHIP RES.	1kohm	1/16W	5%	RMC1/16 102JATP	J24185102		
R 1187	CHIP RES.	100kohm	1/16W	5%	RMC1/16 104JATP	J24185104		
R 1188	CHIP RES.	1kohm	1/16W	5%	RMC1/16 102JATP	J24185102		
R 1189	CHIP RES.	100kohm	1/16W	5%	RMC1/16 104JATP	J24185104		
R 1190	CHIP RES.	4.7kohm	1/16W	5%	RMC1/16 472JATP	J24185472		

# AF-CNTL Unit

REF.	DESCRIPTION	VALUE	V/W	TOL.	MFR'S DESIG	YAESU P/N	VERS.	LOT.
R 1191	CHIP RES.	4.7kohm	1/16W	5%	RMC1/16 472JATP	J24185472		
R 1193	CHIP RES.	100kohm	1/16W	5%	RMC1/16 104JATP	J24185104		
R 1195	CHIP RES.	1kohm	1/16W	5%	RMC1/16 102JATP	J24185102		
R 1196	CHIP RES.	100kohm	1/16W	5%	RMC1/16 104JATP	J24185104		
R 1197	CHIP RES.	4.7kohm	1/16W	5%	RMC1/16 472JATP	J24185472		
R 1198	CHIP RES.	100ohm	1/16W	5%	RMC1/16 101JATP	J24185101		
R 1199	CHIP RES.	15kohm	1/16W	5%	RMC1/16 153JATP	J24185153		
R 1200	CHIP RES.	100ohm	1/16W	5%	RMC1/16 101JATP	J24185101		
R 1201	CHIP RES.	47kohm	1/16W	5%	RMC1/16 473JATP	J24185473		
R 1202	CHIP RES.	100kohm	1/16W	5%	RMC1/16 104JATP	J24185104		
R 1203	CHIP RES.	22kohm	1/16W	5%	RMC1/16 223JATP	J24185223		
R 1204	CHIP RES.	2.2kohm	1/16W	5%	RMC1/16 222JATP	J24185222		
R 1205	CHIP RES.	100ohm	1/16W	5%	RMC1/16 101JATP	J24185101		
R 1206	CHIP RES.	47kohm	1/16W	5%	RMC1/16 473JATP	J24185473		
R 1207	CHIP RES.	100kohm	1/16W	5%	RMC1/16 104JATP	J24185104		
R 1208	CHIP RES.	100kohm	1/16W	5%	RMC1/16 104JATP	J24185104		
R 1209	CHIP RES.	6.8kohm	1/16W	5%	RMC1/16 682JATP	J24185682		
R 1210	CHIP RES.	47kohm	1/16W	5%	RMC1/16 473JATP	J24185473		
R 1211	CHIP RES.	4.7kohm	1/16W	5%	RMC1/16 472JATP	J24185472		
R 1212	CHIP RES.	22kohm	1/16W	5%	RMC1/16 223JATP	J24185223		
R 1213	CHIP RES.	1kohm	1/16W	5%	RMC1/16 102JATP	J24185102		
R 1214	CHIP RES.	10kohm	1/16W	5%	RMC1/16 103JATP	J24185103		
R 1215	CHIP RES.	2.2kohm	1/16W	5%	RMC1/16 222JATP	J24185222		
R 1216	CHIP RES.	10kohm	1/16W	5%	RMC1/16 103JATP	J24185103		
R 1217	CHIP RES.	100ohm	1/16W	5%	RMC1/16 101JATP	J24185101		
R 1218	CHIP RES.	1kohm	1/16W	5%	RMC1/16 102JATP	J24185102		
R 1219	CHIP RES.	100ohm	1/16W	5%	RMC1/16 101JATP	J24185101		
R 1220	CHIP RES.	22kohm	1/16W	5%	RMC1/16 223JATP	J24185223		
R 1221	CHIP RES.	220kohm	1/16W	5%	RMC1/16 224JATP	J24185224		
R 1222	CHIP RES.	1kohm	1/16W	5%	RMC1/16 102JATP	J24185102		
R 1223	CHIP RES.	4.7kohm	1/16W	5%	RMC1/16 472JATP	J24185472		
R 1224	CHIP RES.	470kohm	1/16W	5%	RMC1/16 474JATP	J24185474		
R 1225	CHIP RES.	47kohm	1/16W	5%	RMC1/16 473JATP	J24185473		
R 1226	CHIP RES.	10kohm	1/16W	5%	RMC1/16 103JATP	J24185103		
R 1227	CHIP RES.	22kohm	1/16W	5%	RMC1/16 223JATP	J24185223		
R 1229	CHIP RES.	1kohm	1/16W	5%	RMC1/16 102JATP	J24185102		
R 1230	CHIP RES.	2.2kohm	1/16W	5%	RMC1/16 222JATP	J24185222		
R 1231	CHIP RES.	2.2kohm	1/16W	5%	RMC1/16 222JATP	J24185222		
R 1232	CHIP RES.	1.8kohm	1/16W	5%	RMC1/16 182JATP	J24185182		
R 1233	CHIP RES.	22kohm	1/16W	5%	RMC1/16 223JATP	J24185223		
R 1234	CHIP RES.	2.2kohm	1/16W	5%	RMC1/16 222JATP	J24185222		
R 1235	CHIP RES.	1.2kohm	1/16W	5%	RMC1/16 122JATP	J24185122		
R 1236	CHIP RES.	10kohm	1/16W	5%	RMC1/16 103JATP	J24185103		
R 1237	CHIP RES.	1kohm	1/16W	5%	RMC1/16 102JATP	J24185102		
R 1238	CHIP RES.	680ohm	1/16W	5%	RMC1/16 681JATP	J24185681		
R 1239	CHIP RES.	10kohm	1/16W	5%	RMC1/16 103JATP	J24185103		
R 1240	CHIP RES.	2.2kohm	1/16W	5%	RMC1/16 222JATP	J24185222		
R 1242	CHIP RES.	10kohm	1/16W	5%	RMC1/16 103JATP	J24185103		
R 1243	CHIP RES.	0ohm	1/16W	5%	RMC1/16 000JATP	J24185000		
R 1244	CHIP RES.	220kohm	1/16W	5%	RMC1/16 224JATP	J24185224		
R 1245	CHIP RES.	4.7kohm	1/16W	5%	RMC1/16 472JATP	J24185472		
R 1246	CHIP RES.	1kohm	1/16W	5%	RMC1/16 102JATP	J24185102		
R 1247	CHIP RES.	10kohm	1/16W	5%	RMC1/16 103JATP	J24185103		
R 1248	CHIP RES.	6.8kohm	1/16W	5%	RMC1/16 682JATP	J24185682		
R 1249	CHIP RES.	22kohm	1/16W	5%	RMC1/16 223JATP	J24185223		
R 1250	CHIP RES.	47ohm	1/16W	5%	RMC1/16 470JATP	J24185470		
R 1251	CHIP RES.	150kohm	1/16W	5%	RMC1/16 154JATP	J24185154		

REF.	DESCRIPTION	VALUE	V/W	TOL.	MFR'S DESIG	YAESU P/N	VERS.	LOT.
R 1252	CHIP RES.	22kohm	1/16W	5%	RMC1/16 223JATP	J24185223		
R 1253	CHIP RES.	1Mohm	1/16W	5%	RMC1/16 105JATP	J24185105		
R 1254	CHIP RES.	33kohm	1/16W	5%	RMC1/16 333JATP	J24185333		
R 1255	CHIP RES.	100ohm	1/16W	5%	RMC1/16 101JATP	J24185101		
R 1256	CHIP RES.	4.7kohm	1/16W	5%	RMC1/16 472JATP	J24185472		
R 1257	CHIP RES.	1kohm	1/16W	5%	RMC1/16 102JATP	J24185102		
R 1258	CHIP RES.	2.2kohm	1/16W	5%	RMC1/16 222JATP	J24185222		
R 1259	CHIP RES.	100kohm	1/16W	5%	RMC1/16 104JATP	J24185104		
R 1260	CHIP RES.	100kohm	1/16W	5%	RMC1/16 104JATP	J24185104		
R 1261	CHIP RES.	33kohm	1/16W	5%	RMC1/16 333JATP	J24185333		
R 1262	CHIP RES.	100ohm	1/16W	5%	RMC1/16 101JATP	J24185101		
R 1263	CHIP RES.	100ohm	1/16W	5%	RMC1/16 101JATP	J24185101		
R 1264	CHIP RES.	22kohm	1/16W	5%	RMC1/16 223JATP	J24185223		
R 1265	CHIP RES.	15kohm	1/16W	5%	RMC1/16 153JATP	J24185153		
R 1266	CHIP RES.	1kohm	1/16W	5%	RMC1/16 102JATP	J24185102		
R 1268	CHIP RES.	2.2kohm	1/16W	5%	RMC1/16 222JATP	J24185222		
R 1269	CHIP RES.	22kohm	1/16W	5%	RMC1/16 223JATP	J24185223		
R 1270	CHIP RES.	10kohm	1/16W	5%	RMC1/16 103JATP	J24185103		
R 1271	CHIP RES.	2.2kohm	1/16W	5%	RMC1/16 222JATP	J24185222		
R 1272	CHIP RES.	2.2kohm	1/16W	5%	RMC1/16 222JATP	J24185222		
R 1273	CHIP RES.	100kohm	1/16W	5%	RMC1/16 104JATP	J24185104		
R 1274	CHIP RES.	1.5kohm	1/16W	5%	RMC1/16 152JATP	J24185152		
R 1275	CHIP RES.	33kohm	1/16W	5%	RMC1/16 333JATP	J24185333		
R 1276	CHIP RES.	10kohm	1/16W	5%	RMC1/16 103JATP	J24185103		
R 1277	CHIP RES.	330ohm	1/16W	5%	RMC1/16 331JATP	J24185331		
R 1278	CHIP RES.	22kohm	1/16W	5%	RMC1/16 223JATP	J24185223		
R 1279	CHIP RES.	5.6kohm	1/16W	5%	RMC1/16 562JATP	J24185562		
R 1280	CHIP RES.	22kohm	1/16W	5%	RMC1/16 223JATP	J24185223		
R 1281	CHIP RES.	4.7kohm	1/16W	5%	RMC1/16 472JATP	J24185472		
R 1283	CHIP RES.	4.7kohm	1/16W	5%	RMC1/16 472JATP	J24185472		
R 1284	CHIP RES.	22kohm	1/16W	5%	RMC1/16 223JATP	J24185223		
R 1285	CHIP RES.	100kohm	1/16W	5%	RMC1/16 104JATP	J24185104		
R 1286	CHIP RES.	680kohm	1/16W	5%	RMC1/16 684JATP	J24185684		
R 1287	CHIP RES.	10kohm	1/16W	5%	RMC1/16 103JATP	J24185103		
R 1288	CHIP RES.	22kohm	1/16W	5%	RMC1/16 223JATP	J24185223		
R 1289	CHIP RES.	100kohm	1/16W	5%	RMC1/16 104JATP	J24185104		
R 1290	CHIP RES.	100kohm	1/16W	5%	RMC1/16 104JATP	J24185104		
R 1291	CHIP RES.	1kohm	1/16W	5%	RMC1/16 102JATP	J24185102		
R 1292	CHIP RES.	4.7kohm	1/16W	5%	RMC1/16 472JATP	J24185472		
R 1293	CHIP RES.	100kohm	1/16W	5%	RMC1/16 104JATP	J24185104		
R 1294	CHIP RES.	15kohm	1/16W	5%	RMC1/16 153JATP	J24185153		
R 1295	CHIP RES.	220kohm	1/16W	5%	RMC1/16 224JATP	J24185224		
R 1296	CHIP RES.	4.7kohm	1/16W	5%	RMC1/16 472JATP	J24185472		
R 1297	CHIP RES.	470kohm	1/16W	5%	RMC1/16 474JATP	J24185474		
R 1298	CHIP RES.	15kohm	1/16W	5%	RMC1/16 153JATP	J24185153		
R 1299	CHIP RES.	22kohm	1/16W	5%	RMC1/16 223JATP	J24185223		
R 1300	CHIP RES.	4.7kohm	1/16W	5%	RMC1/16 472JATP	J24185472		
R 1301	CHIP RES.	33kohm	1/16W	5%	RMC1/16 333JATP	J24185333		
R 1302	CHIP RES.	100ohm	1/16W	5%	RMC1/16 101JATP	J24185101		
R 1304	CHIP RES.	4.7kohm	1/16W	5%	RMC1/16 472JATP	J24185472		
R 1305	CHIP RES.	1kohm	1/16W	5%	RMC1/16 102JATP	J24185102		
R 1306	CHIP RES.	10kohm	1/16W	5%	RMC1/16 103JATP	J24185103		
R 1307	CHIP RES.	10kohm	1/16W	5%	RMC1/16 103JATP	J24185103		
R 1308	CHIP RES.	150kohm	1/16W	5%	RMC1/16 154JATP	J24185154		
R 1309	CHIP RES.	56kohm	1/16W	5%	RMC1/16 563JATP	J24185563		
R 1310	CHIP RES.	100kohm	1/16W	5%	RMC1/16 104JATP	J24185104		
R 1311	CHIP RES.	1Mohm	1/16W	5%	RMC1/16 105JATP	J24185105		

# AF-CNTL Unit

REF.	DESCRIPTION	VALUE	V/W	TOL.	MFR'S DESIG	YAESU P/N	VERS.	LOT.
R 1312	CHIP RES.	3.3kohm	1/16W	5%	RMC1/16 332JATP	J24185332		
R 1314	CHIP RES.	47ohm	1/16W	5%	RMC1/16 470JATP	J24185470		
R 1315	CHIP RES.	1kohm	1/16W	5%	RMC1/16 102JATP	J24185102		
R 1317	CHIP RES.	56kohm	1/16W	5%	RMC1/16 563JATP	J24185563		
R 1318	CHIP RES.	1Mohm	1/16W	5%	RMC1/16 105JATP	J24185105		
R 1319	CHIP RES.	220ohm	1/4W	5%	RMC1/4 221JATP	J24245221		
R 1320	CHIP RES.	4.7ohm	1/10W	5%	RMC1/10T 4R7J	J24205479		
R 1321	CHIP RES.	1ohm	1W	5%	RMC1 1R0JTE	J24305010		
R 1322	CHIP RES.	33kohm	1/16W	5%	RMC1/16 333JATP	J24185333		
R 1323	CHIP RES.	33kohm	1/16W	5%	RMC1/16 333JATP	J24185333		
R 1324	CHIP RES.	33kohm	1/16W	5%	RMC1/16 333JATP	J24185333		
R 1325	CHIP RES.	33kohm	1/16W	5%	RMC1/16 333JATP	J24185333		
R 1326	CHIP RES.	4.7ohm	1/10W	5%	RMC1/10T 4R7J	J24205479		
R 1327	CHIP RES.	1kohm	1/16W	5%	RMC1/16 102JATP	J24185102		
R 1328	CHIP RES.	10kohm	1/16W	5%	RMC1/16 103JATP	J24185103		
R 1330	CHIP RES.	68kohm	1/16W	5%	RMC1/16 683JATP	J24185683		
R 1332	CHIP RES.	10kohm	1/16W	5%	RMC1/16 103JATP	J24185103		
R 1333	CHIP RES.	18kohm	1/16W	5%	RMC1/16 183JATP	J24185183		
R 1334	CHIP RES.	2.2Mohm	1/16W	5%	RMC1/16 225JATP	J24185225		
R 1335	CHIP RES.	1kohm	1/16W	5%	RMC1/16 102JATP	J24185102		
R 1336	CHIP RES.	47kohm	1/16W	5%	RMC1/16 473JATP	J24185473		
R 1337	CHIP RES.	10kohm	1/16W	5%	RMC1/16 103JATP	J24185103		
R 1338	CHIP RES.	18kohm	1/16W	5%	RMC1/16 183JATP	J24185183		
R 1339	CHIP RES.	10kohm	1/16W	5%	RMC1/16 103JATP	J24185103		
R 1340	CHIP RES.	1Mohm	1/16W	5%	RMC1/16 105JATP	J24185105		
R 1341	CHIP RES.	10kohm	1/16W	5%	RMC1/16 103JATP	J24185103		
R 1342	CHIP RES.	100kohm	1/16W	5%	RMC1/16 104JATP	J24185104		
R 1343	CHIP RES.	33kohm	1/16W	5%	RMC1/16 333JATP	J24185333		
R 1344	CHIP RES.	470ohm	1/16W	5%	RMC1/16 471JATP	J24185471		
R 1345	CHIP RES.	10kohm	1/16W	5%	RMC1/16 103JATP	J24185103		
R 1346	CHIP RES.	470ohm	1/16W	5%	RMC1/16 471JATP	J24185471		
R 1347	CHIP RES.	47kohm	1/16W	5%	RMC1/16 473JATP	J24185473		
R 1348	CHIP RES.	68kohm	1/16W	5%	RMC1/16 683JATP	J24185683		
R 1349	CHIP RES.	470ohm	1/16W	5%	RMC1/16 471JATP	J24185471		
R 1350	CHIP RES.	100kohm	1/16W	5%	RMC1/16 104JATP	J24185104		
R 1351	CHIP RES.	10kohm	1/16W	5%	RMC1/16 103JATP	J24185103		
R 1352	CHIP RES.	18kohm	1/16W	5%	RMC1/16 183JATP	J24185183		
R 1353	CHIP RES.	10kohm	1/16W	5%	RMC1/16 103JATP	J24185103		
R 1354	CHIP RES.	10kohm	1/16W	5%	RMC1/16 103JATP	J24185103		
R 1355	CHIP RES.	4.7kohm	1/16W	5%	RMC1/16 472JATP	J24185472		
R 1356	CHIP RES.	4.7kohm	1/16W	5%	RMC1/16 472JATP	J24185472		
R 1357	CHIP RES.	10kohm	1/16W	5%	RMC1/16 103JATP	J24185103		
R 1358	CHIP RES.	47ohm	1/16W	5%	RMC1/16 470JATP	J24185470		
R 1359	CHIP RES.	1kohm	1/16W	5%	RMC1/16 102JATP	J24185102		
R 1360	CHIP RES.	47kohm	1/16W	5%	RMC1/16 473JATP	J24185473		
R 1361	CHIP RES.	10kohm	1/16W	5%	RMC1/16 103JATP	J24185103		
R 1362	CHIP RES.	10kohm	1/16W	5%	RMC1/16 103JATP	J24185103		
R 1363	CHIP RES.	10kohm	1/16W	5%	RMC1/16 103JATP	J24185103		
R 1364	CHIP RES.	1kohm	1/16W	5%	RMC1/16 102JATP	J24185102		
R 1365	CHIP RES.	470kohm	1/16W	5%	RMC1/16 474JATP	J24185474		
R 1366	CHIP RES.	10kohm	1/16W	5%	RMC1/16 103JATP	J24185103		
R 1367	CHIP RES.	68kohm	1/16W	5%	RMC1/16 683JATP	J24185683		
R 1368	CHIP RES.	10kohm	1/16W	5%	RMC1/16 103JATP	J24185103		
R 1369	CHIP RES.	4.7kohm	1/16W	5%	RMC1/16 472JATP	J24185472		
R 1370	CHIP RES.	47kohm	1/16W	5%	RMC1/16 473JATP	J24185473		
R 1371	CHIP RES.	2.2Mohm	1/16W	5%	RMC1/16 225JATP	J24185225		
R 1372	CHIP RES.	47kohm	1/16W	5%	RMC1/16 473JATP	J24185473		

REF.	DESCRIPTION	VALUE	V/W	TOL.	MFR'S DESIG	YAESU P/N	VERS.	LOT.
R 1373	CHIP RES.	47kohm	1/16W	5%	RMC1/16 473JATP	J24185473		
R 1374	CHIP RES.	68kohm	1/16W	5%	RMC1/16 683JATP	J24185683		
R 1375	CHIP RES.	0ohm	1/16W	5%	RMC1/16 000JATP	J24185000		
R 1376	CHIP RES.	4.7kohm	1/16W	5%	RMC1/16 472JATP	J24185472		
R 1377	CHIP RES.	68kohm	1/16W	5%	RMC1/16 683JATP	J24185683		
R 1378	CHIP RES.	100kohm	1/16W	5%	RMC1/16 104JATP	J24185104		
R 1379	CHIP RES.	47kohm	1/16W	5%	RMC1/16 473JATP	J24185473		
R 1380	CHIP RES.	680ohm	1/16W	5%	RMC1/16 681JATP	J24185681		
R 1381	CHIP RES.	22kohm	1/16W	5%	RMC1/16 223JATP	J24185223		
R 1382	CHIP RES.	470ohm	1/16W	5%	RMC1/16 471JATP	J24185471		
R 1383	CHIP RES.	100kohm	1/16W	5%	RMC1/16 104JATP	J24185104		
R 1384	CHIP RES.	470ohm	1/16W	5%	RMC1/16 471JATP	J24185471		
R 1385	CHIP RES.	10kohm	1/16W	5%	RMC1/16 103JATP	J24185103		
R 1386	CHIP RES.	470ohm	1/16W	5%	RMC1/16 471JATP	J24185471		
R 1387	CHIP RES.	22kohm	1/16W	5%	RMC1/16 223JATP	J24185223		
R 1388	CHIP RES.	100kohm	1/16W	5%	RMC1/16 104JATP	J24185104		
R 1389	CHIP RES.	4.7kohm	1/16W	5%	RMC1/16 472JATP	J24185472		
R 1390	CHIP RES.	2.2Mohm	1/16W	5%	RMC1/16 225JATP	J24185225		
R 1391	CHIP RES.	10kohm	1/16W	5%	RMC1/16 103JATP	J24185103		
R 1392	CHIP RES.	4.7kohm	1/16W	5%	RMC1/16 472JATP	J24185472		
R 1393	CHIP RES.	22kohm	1/16W	5%	RMC1/16 223JATP	J24185223		
R 1394	CHIP RES.	82kohm	1/16W	5%	RMC1/16 823JATP	J24185823		
R 1395	CHIP RES.	39kohm	1/16W	5%	RMC1/16 393JATP	J24185393		
R 1396	CHIP RES.	10kohm	1/16W	5%	RMC1/16 103JATP	J24185103		
R 1397	CHIP RES.	10kohm	1/16W	5%	RMC1/16 103JATP	J24185103		
R 1398	CHIP RES.	470ohm	1/16W	5%	RMC1/16 471JATP	J24185471		
R 1399	CHIP RES.	470ohm	1/16W	5%	RMC1/16 471JATP	J24185471		
R 1400	CHIP RES.	4.7kohm	1/16W	5%	RMC1/16 472JATP	J24185472		
R 1401	CHIP RES.	4.7kohm	1/16W	5%	RMC1/16 472JATP	J24185472		
R 1402	CHIP RES.	1kohm	1/16W	5%	RMC1/16 102JATP	J24185102		
R 1403	CHIP RES.	1kohm	1/16W	5%	RMC1/16 102JATP	J24185102		
R 1404	CHIP RES.	1kohm	1/16W	5%	RMC1/16 102JATP	J24185102		
R 1405	CHIP RES.	1kohm	1/16W	5%	RMC1/16 102JATP	J24185102		
R 1406	CHIP RES.	1kohm	1/16W	5%	RMC1/16 102JATP	J24185102		
R 1407	CHIP RES.	470ohm	1/16W	5%	RMC1/16 471JATP	J24185471		
R 1408	CHIP RES.	4.7kohm	1/16W	5%	RMC1/16 472JATP	J24185472		
R 1409	CHIP RES.	47kohm	1/16W	5%	RMC1/16 473JATP	J24185473		
R 1410	CHIP RES.	47kohm	1/16W	5%	RMC1/16 473JATP	J24185473		
R 1411	CHIP RES.	100kohm	1/16W	5%	RMC1/16 104JATP	J24185104		
R 1412	CHIP RES.	1kohm	1/16W	5%	RMC1/16 102JATP	J24185102		
R 1413	CHIP RES.	10kohm	1/16W	5%	RMC1/16 103JATP	J24185103		
R 1414	CHIP RES.	4.7kohm	1/16W	5%	RMC1/16 472JATP	J24185472		
R 1415	CHIP RES.	10kohm	1/16W	5%	RMC1/16 103JATP	J24185103		
R 1416	CHIP RES.	22kohm	1/16W	5%	RMC1/16 223JATP	J24185223		
R 1417	CHIP RES.	330kohm	1/16W	5%	RMC1/16 334JATP	J24185334		
R 1418	CHIP RES.	1Mohm	1/16W	5%	RMC1/16 105JATP	J24185105		
R 1419	CHIP RES.	10kohm	1/16W	5%	RMC1/16 103JATP	J24185103		
R 1420	CHIP RES.	22kohm	1/16W	5%	RMC1/16 223JATP	J24185223		
R 1421	CHIP RES.	22kohm	1/16W	5%	RMC1/16 223JATP	J24185223		
R 1422	CHIP RES.	10kohm	1/16W	5%	RMC1/16 103JATP	J24185103		
R 1423	CHIP RES.	1kohm	1/16W	5%	RMC1/16 102JATP	J24185102		
R 1426	CHIP RES.	47kohm	1/16W	5%	RMC1/16 473JATP	J24185473		
R 1427	CHIP RES.	1kohm	1/16W	5%	RMC1/16 102JATP	J24185102		
R 1428	CHIP RES.	2.2kohm	1/16W	5%	RMC1/16 222JATP	J24185222		
R 1430	CHIP RES.	4.7kohm	1/16W	5%	RMC1/16 472JATP	J24185472		
R 1431	CHIP RES.	4.7kohm	1/16W	5%	RMC1/16 472JATP	J24185472		
R 1432	CHIP RES.	1kohm	1/16W	5%	RMC1/16 102JATP	J24185102		

# AF-CNTL Unit

REF.	DESCRIPTION	VALUE	V/W	TOL.	MFR'S DESIG	YAESU P/N	VERS.	LOT.
R 1433	CHIP RES.	4.7kohm	1/16W	5%	RMC1/16 472JATP	J24185472		
R 1434	CHIP RES.	15kohm	1/16W	5%	RMC1/16 153JATP	J24185153		
R 1435	CHIP RES.	1kohm	1/16W	5%	RMC1/16 102JATP	J24185102		
R 1436	CHIP RES.	470kohm	1/16W	5%	RMC1/16 474JATP	J24185474		
R 1437	CHIP RES.	1kohm	1/16W	5%	RMC1/16 102JATP	J24185102		
R 1438	CHIP RES.	120kohm	1/16W	5%	RMC1/16 124JATP	J24185124		
R 1439	CHIP RES.	1kohm	1/16W	5%	RMC1/16 102JATP	J24185102		
R 1440	CHIP RES.	1kohm	1/16W	5%	RMC1/16 102JATP	J24185102		
R 1441	CHIP RES.	1kohm	1/16W	5%	RMC1/16 102JATP	J24185102		
R 1442	CHIP RES.	10kohm	1/16W	5%	RMC1/16 103JATP	J24185103		
R 1443	CHIP RES.	3.3kohm	1/16W	5%	RMC1/16 332JATP	J24185332		
R 1444	CHIP RES.	1kohm	1/16W	5%	RMC1/16 102JATP	J24185102		
R 1445	CHIP RES.	10kohm	1/16W	5%	RMC1/16 103JATP	J24185103		
R 1446	CHIP RES.	1kohm	1/16W	5%	RMC1/16 102JATP	J24185102		
R 1447	CHIP RES.	1kohm	1/16W	5%	RMC1/16 102JATP	J24185102		
R 1448	CHIP RES.	4.7kohm	1/16W	5%	RMC1/16 472JATP	J24185472		
R 1449	CHIP RES.	10kohm	1/16W	5%	RMC1/16 103JATP	J24185103		
R 1450	CHIP RES.	10kohm	1/16W	5%	RMC1/16 103JATP	J24185103		
R 1451	CHIP RES.	39kohm	1/16W	5%	RMC1/16 393JATP	J24185393		
R 1452	CHIP RES.	82kohm	1/16W	5%	RMC1/16 823JATP	J24185823		
R 1453	CHIP RES.	47kohm	1/16W	5%	RMC1/16 473JATP	J24185473		
R 1454	CHIP RES.	10kohm	1/16W	5%	RMC1/16 103JATP	J24185103		
R 1455	CHIP RES.	470ohm	1/16W	5%	RMC1/16 471JATP	J24185471		
R 1456	CHIP RES.	10kohm	1/16W	5%	RMC1/16 103JATP	J24185103		
R 1457	CHIP RES.	100kohm	1/16W	5%	RMC1/16 104JATP	J24185104		
R 1458	CHIP RES.	4.7kohm	1/16W	5%	RMC1/16 472JATP	J24185472		
R 1459	CHIP RES.	4.7kohm	1/16W	5%	RMC1/16 472JATP	J24185472		
R 1460	CHIP RES.	6.8kohm	1/16W	5%	RMC1/16 682JATP	J24185682		
R 1461	CHIP RES.	680ohm	1/16W	5%	RMC1/16 681JATP	J24185681		
R 1462	CHIP RES.	470ohm	1/16W	5%	RMC1/16 471JATP	J24185471		
R 1463	CHIP RES.	470ohm	1/16W	5%	RMC1/16 471JATP	J24185471		
R 1464	CHIP RES.	47kohm	1/16W	5%	RMC1/16 473JATP	J24185473		
R 1465	CHIP RES.	470ohm	1/16W	5%	RMC1/16 471JATP	J24185471		
R 1466	CHIP RES.	470ohm	1/16W	5%	RMC1/16 471JATP	J24185471		
R 1467	CHIP RES.	470ohm	1/16W	5%	RMC1/16 471JATP	J24185471		
R 1468	CHIP RES.	470ohm	1/16W	5%	RMC1/16 471JATP	J24185471		
R 1470	CHIP RES.	100kohm	1/16W	5%	RMC1/16 104JATP	J24185104		
R 1471	CHIP RES.	10kohm	1/16W	5%	RMC1/16 103JATP	J24185103		
R 1472	CHIP RES.	10kohm	1/16W	5%	RMC1/16 103JATP	J24185103		
R 1473	CHIP RES.	47ohm	1/16W	5%	RMC1/16 470JATP	J24185470		
R 1474	CHIP RES.	2.2kohm	1/16W	5%	RMC1/16 222JATP	J24185222		
R 1475	CHIP RES.	470ohm	1/16W	5%	RMC1/16 471JATP	J24185471		
R 1476	CHIP RES.	470ohm	1/16W	5%	RMC1/16 471JATP	J24185471		
R 1477	CHIP RES.	470ohm	1/16W	5%	RMC1/16 471JATP	J24185471		
R 1478	CHIP RES.	10kohm	1/16W	5%	RMC1/16 103JATP	J24185103		
R 1479	CHIP RES.	1kohm	1/16W	5%	RMC1/16 102JATP	J24185102		
R 1480	CHIP RES.	1kohm	1/16W	5%	RMC1/16 102JATP	J24185102		
R 1481	CHIP RES.	100kohm	1/16W	5%	RMC1/16 104JATP	J24185104		
R 1482	CHIP RES.	100kohm	1/16W	5%	RMC1/16 104JATP	J24185104		
R 1483	CHIP RES.	4.7kohm	1/16W	5%	RMC1/16 472JATP	J24185472		
R 1484	CHIP RES.	10kohm	1/16W	5%	RMC1/16 103JATP	J24185103		
R 1485	CHIP RES.	5.6kohm	1/16W	5%	RMC1/16 562JATP	J24185562		
R 1486	CHIP RES.	22kohm	1/16W	5%	RMC1/16 223JATP	J24185223		
R 1487	CHIP RES.	5.6kohm	1/16W	5%	RMC1/16 562JATP	J24185562		
R 1489	CHIP RES.	4.7kohm	1/16W	5%	RMC1/16 472JATP	J24185472		
R 1490	CHIP RES.	470ohm	1/16W	5%	RMC1/16 471JATP	J24185471		
R 1491	CHIP RES.	10kohm	1/16W	5%	RMC1/16 103JATP	J24185103		

REF.	DESCRIPTION	VALUE	V/W	TOL.	MFR'S DESIG	YAESU P/N	VERS.	LOT.
R 1492	CHIP RES.	4.7kohm	1/16W	5%	RMC1/16 472JATP	J24185472		
R 1493	CHIP RES.	22kohm	1/16W	5%	RMC1/16 223JATP	J24185223		
R 1496	CHIP RES.	22kohm	1/16W	5%	RMC1/16 223JATP	J24185223		
R 1497	CHIP RES.	1kohm	1/16W	5%	RMC1/16 102JATP	J24185102		
R 1498	CHIP RES.	10kohm	1/16W	5%	RMC1/16 103JATP	J24185103		
R 1499	CHIP RES.	4.7kohm	1/16W	5%	RMC1/16 472JATP	J24185472		
R 1500	CHIP RES.	220ohm	1/16W	5%	RMC1/16 221JATP	J24185221		
R 1502	CHIP RES.	47kohm	1/16W	5%	RMC1/16 473JATP	J24185473		
R 1503	CHIP RES.	0ohm	1/16W	5%	RMC1/16 000JATP	J24185000		
R 1504	CHIP RES.	47kohm	1/16W	5%	RMC1/16 473JATP	J24185473		
R 1505	CHIP RES.	4.7kohm	1/16W	5%	RMC1/16 472JATP	J24185472		
R 1506	CHIP RES.	3.3kohm	1/16W	5%	RMC1/16 332JATP	J24185332		
R 1507	CHIP RES.	22kohm	1/16W	5%	RMC1/16 223JATP	J24185223		
R 1508	CHIP RES.	470ohm	1/16W	5%	RMC1/16 471JATP	J24185471		
R 1509	CHIP RES.	10kohm	1/16W	5%	RMC1/16 103JATP	J24185103		
R 1510	CHIP RES.	68ohm	1W	5%	RMC1 680JTE	J24305680		
R 1511	CHIP RES.	15ohm	1W	5%	RMC1 150JTE	J24305150		
R 1512	CHIP RES.	5.6kohm	1/16W	5%	RMC1/16 562JATP	J24185562		
R 1513	CHIP RES.	3.3kohm	1/16W	5%	RMC1/16 332JATP	J24185332		
R 1514	CHIP RES.	0.33ohm	1W	10%	RMC1 R33KATE	J24309001		
R 1516	CHIP RES.	100ohm	1/4W	5%	RMC1/4 101JATP	J24245101		
R 1517	CHIP RES.	100ohm	1/4W	5%	RMC1/4 101JATP	J24245101		
R 1518	CHIP RES.	100ohm	1/4W	5%	RMC1/4 101JATP	J24245101		
R 1520	CHIP RES.	3.3kohm	1/16W	5%	RMC1/16 332JATP	J24185332		
R 1522	CHIP RES.	3.9kohm	1/16W	5%	RMC1/16 392JATP	J24185392		
R 1523	CHIP RES.	1kohm	1/16W	5%	RMC1/16 102JATP	J24185102		
R 1524	CHIP RES.	10kohm	1/16W	5%	RMC1/16 103JATP	J24185103		
R 1525	CHIP RES.	2.2kohm	1/16W	5%	RMC1/16 222JATP	J24185222		
R 1526	CHIP RES.	1kohm	1/16W	5%	RMC1/16 102JATP	J24185102		
R 1527	CHIP RES.	2.7kohm	1/16W	5%	RMC1/16 272JATP	J24185272		
R 1528	CHIP RES.	0ohm	1/16W	5%	RMC1/16 000JATP	J24185000		
R 1530	CHIP RES.	220kohm	1/16W	5%	RMC1/16 224JATP	J24185224		
R 1531	CHIP RES.	4.7kohm	1/16W	5%	RMC1/16 472JATP	J24185472		
R 1533	CARBON FILM RES.	470kohm	1/6W	5%	RD16PJ474 470K	J01225474		
R 1534	CHIP RES.	100ohm	1/16W	5%	RMC1/16 101JATP	J24185101		
R 1535	CARBON FILM RES.	100ohm	1/6W	5%	RD16PJ101 100	J01225101		
R 1536	CARBON FILM RES.	100kohm	1/6W	5%	RD16PJ104 100K	J01225104		
R 1537	CARBON FILM RES.	6.8kohm	1/6W	5%	RD16PJ682 6.8K	J01225682		
R 1538	CARBON FILM RES.	100kohm	1/6W	5%	RD16PJ104 100K	J01225104		
R 1538	CHIP RES.	100kohm	1/10W	5%	RMC1/10T 104J	J24205104		2-
R 1539	CARBON FILM RES.	1kohm	1/6W	5%	RD16PJ102 1K	J01225102		
R 1539	CHIP RES.	1kohm	1/16W	5%	RMC1/16 102JATP	J24185102		2-
R 1540	CARBON FILM RES.	330kohm	1/6W	5%	RD16PJ334 330K	J01225334		
R 1540	CHIP RES.	330kohm	1/16W	5%	RMC1/16 334JATP	J24185334		2-
R 1541	CHIP RES.	220kohm	1/16W	5%	RMC1/16 224JATP	J24185224		
R 1542	CHIP RES.	220kohm	1/16W	5%	RMC1/16 224JATP	J24185224		
R 1543	CARBON FILM RES.	10kohm	1/6W	5%	RD16PJ103 10K	J01225103		
R 1544	CARBON FILM RES.	100kohm	1/6W	5%	RD16PJ104 100K	J01225104		
R 1545	CARBON FILM RES.	220kohm	1/6W	5%	RD16PJ224 220K	J01225224		
R 1546	CARBON FILM RES.	100kohm	1/6W	5%	RD16PJ104 100K	J01225104		
RB1001	BLOCK RES.				RRP20B-12Z-10K/20K	J40900180		
RB1002	BLOCK RES.				RRP20B-12Z-10K/20K	J40900180		
RL1001	RELAY		DC12V		ACP131 DC12V	M1190152		
S 1001	SLIDE SWITCH				SSSS21	N6090069		
T 1001	COIL WIDE-TRANS.				960812088	L0022478		
T 1002	COIL 07RF	47.7MHz			47.7M R12-M419A	L0021740		
T 1003	COIL 07RF	47.7MHz			47.7M R12-M419A	L0021740		



# AF-CNTL Unit

REF.	DESCRIPTION	VALUE	V/W	TOL.	MFR'S DESIG	YAESU P/N	VERS.	LOT.
T 1004	COIL RF				R12-7947C	L0020422		
T 1005	COIL 07RF	455kHz			455K R12-F777A	L0021737		
T 1006	COIL RF				R12-7947C	L0020422		
T 1007	COIL 07RF	47.7MHz			47.7M R12-M419A	L0021740		
T 1008	COIL RF				R12-7947C	L0020422		
T 1009	COIL 07RF	52MHz			52M R12-S881X	L0022513		
T 1010	COIL 07RF	47.7MHz			47.7M R12-M419A	L0021740		
T 1011	COIL RF				R12-7947C	L0020422		
T 1012	COIL 07RF	45.705MHz			45.705M R12-S882X	L0022514		
T 1013	COIL 07RF	45.705MHz			45.705M R12-S882X	L0022514		
T 1014	COIL 07RF	16.9MHz			16.9M	L0022135		
T 1015	COIL RF				R12-7947C	L0020422		
T 1016	COIL 07RF	3uH			3.00U R12-1787X	L0021257		
T 1017	COIL RF				R12-7947C	L0020422		
T 1018	COIL RF				R12-7947C	L0020422		
T 1019	COIL 07RF	455kHz			455K R12-F777A	L0021737		
T 1020	COIL RF				R12-7947C	L0020422		
T 1021	COIL RF				R12-7947C	L0020422		
TC1001	TRIMMER CAP.	20pF			ECR-KN020E11X 20P	K91000154		
TC1002	TRIMMER CAP.	20pF			ECR-KN020E11X 20P	K91000154		
TH1001	THERMISTOR				TBSS2R223K385H5Q	G9090072		
VR1001	POT.	10kohm			EVN-5ESX50B14	J51811103		
VR1002	POT.	2.2kohm			EVN-5ESX50BE3	J51811222		
VR1003	POT.	10kohm			EVN-5ESX50B14	J51811103		
VR1004	POT.	10kohm			EVN-5ESX50B14	J51811103		
VR1005	POT.	100kohm			EVN-5ESX50B15	J51811104		
VR1006	POT.	100kohm			EVN-5ESX50B15	J51811104		
VR1007	POT.	10kohm			EVN-5ESX50B14	J51811103		
X 1001	XTAL UM-1	22.625MHz			22.625MHZ	H0103180		
X 1002	XTAL UM-1	15.196MHz			15.196MHZ	H0103179		
X 1003	XTAL HC-49/U	6.7109MHz			6.7109MHZ	H0103176		
X 1004	XTAL UM-1	14.855MHz			14.855MHZ	H0103178		
XF1001	XTAL FILTER				45S15B1	H1102312		
XF1002	XTAL FILTER				45S15B1	H1102312		
Z 1001	SHIELD CASE (2pcs)					RA0071400		
Z 1002	CARD SPACER				WLS-04-0	S6000191		
Z 1003	CARD SPACER				WLS-04-0	S6000191		
Z 1004	GAP PAD				GAP-PAD-S52-YM02	S6000367		

Circuit Diagram

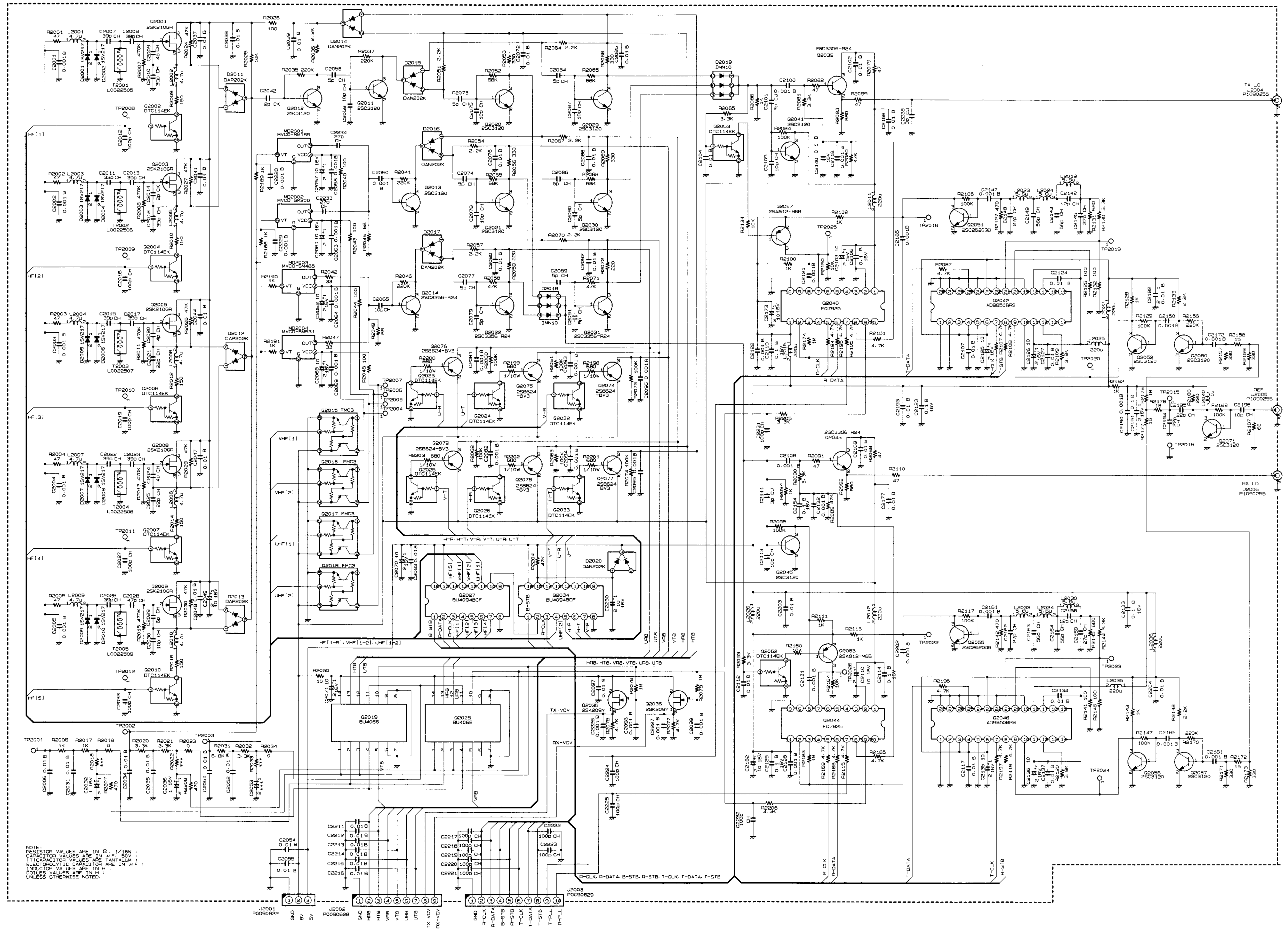

Parts Layout

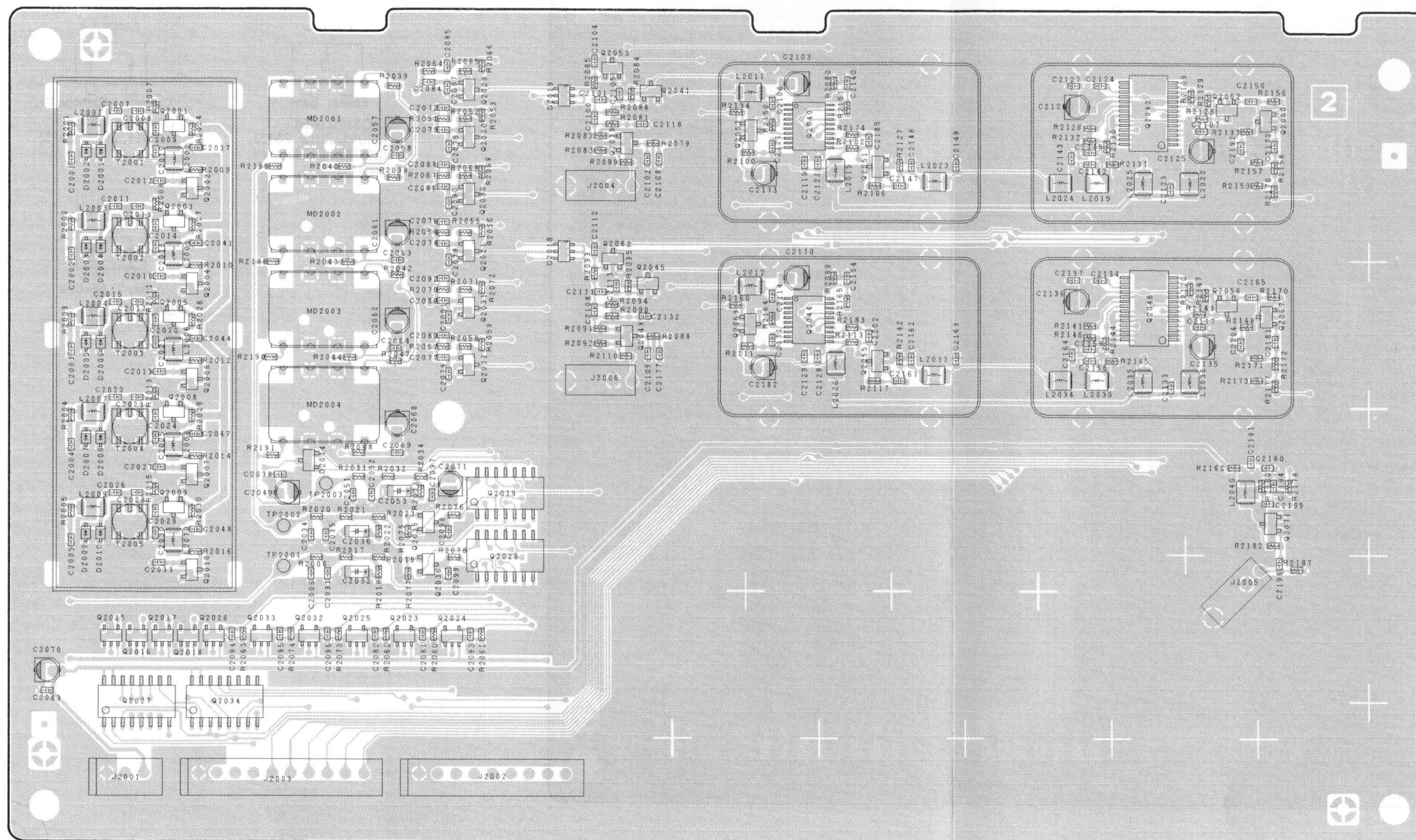

Component Side

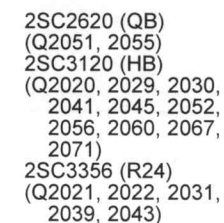
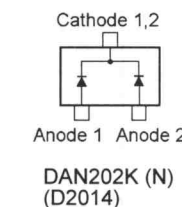
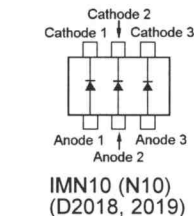
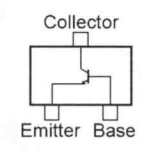
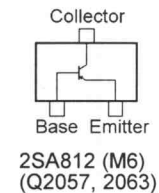
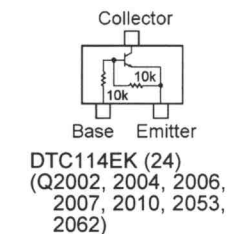
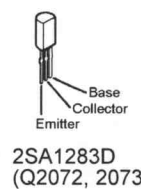
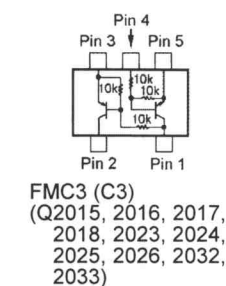
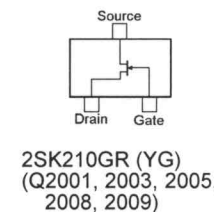
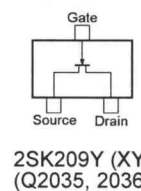
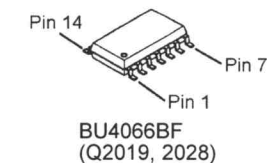
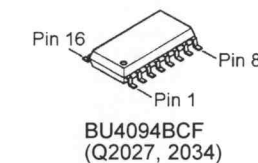
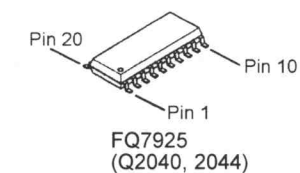
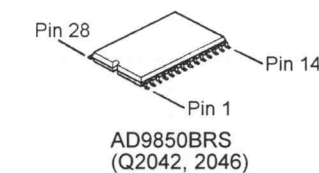



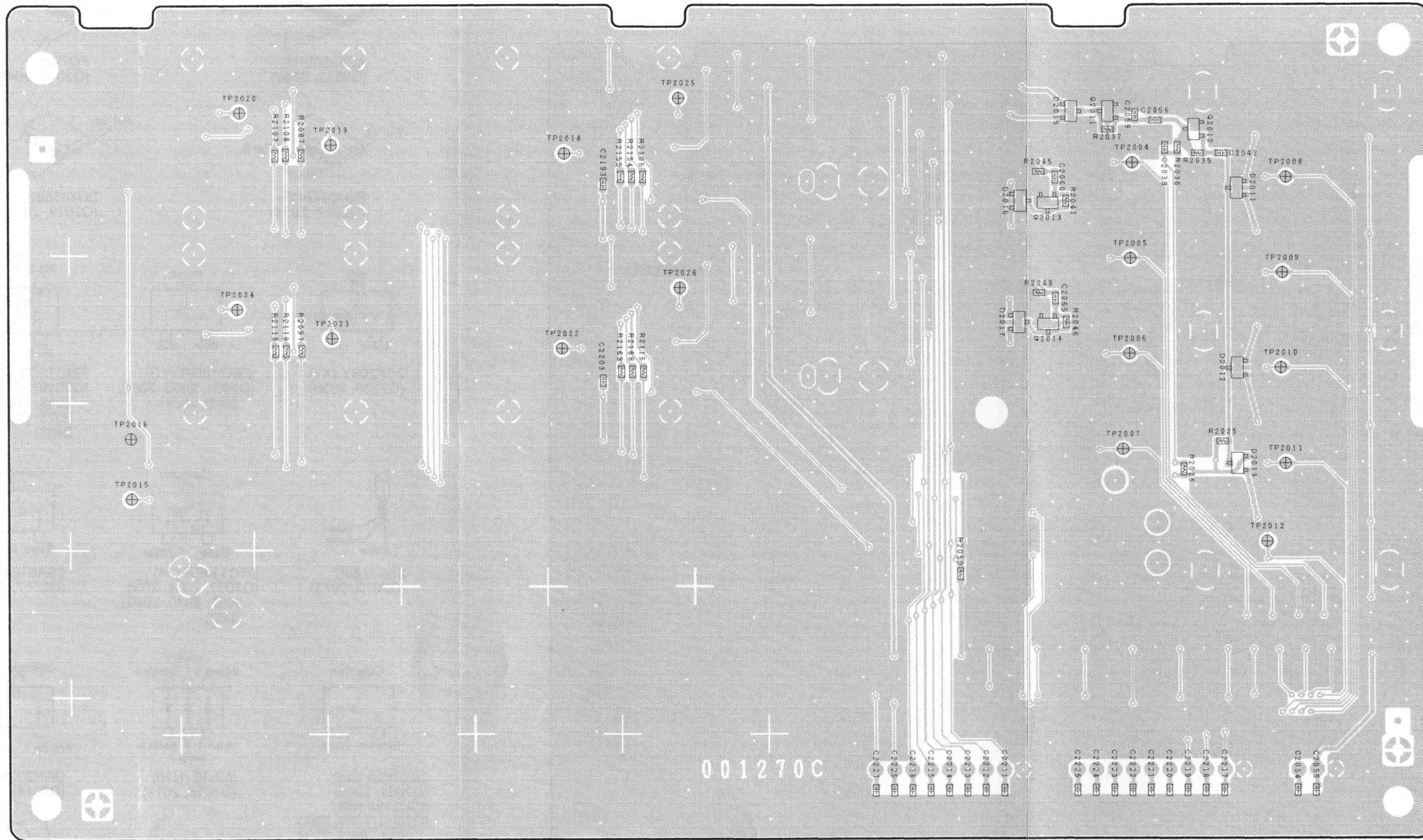

Chip Side

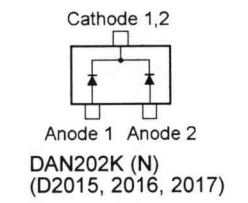
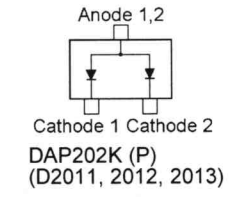
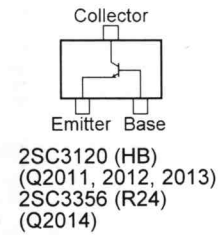

## Parts List

REF.	DESCRIPTION	VALUE	V/W	TOL.	MFR'S DESIG	YAESU P/N	VERS.	LOT.
*** PLL UNIT ***								
PCB with Components						CB0215001		
Printed Circuit Board						FR001270C		
C 2001	CHIP CAP.	0.001uF	50V	B	GRM39B102M50PT	K22174809		
C 2002	CHIP CAP.	0.001uF	50V	B	GRM39B102M50PT	K22174809		
C 2003	CHIP CAP.	0.001uF	50V	B	GRM39B102M50PT	K22174809		
C 2004	CHIP CAP.	0.001uF	50V	B	GRM39B102M50PT	K22174809		
C 2005	CHIP CAP.	0.001uF	50V	B	GRM39B102M50PT	K22174809		
C 2006	CHIP CAP.	0.01uF	50V	B	GRM39B103M50PT	K22174823		
C 2007	CHIP CAP.	39pF	50V	CH	GRM39CH390J50PT	K22174225		
C 2008	CHIP CAP.	39pF	50V	CH	GRM39CH390J50PT	K22174225		
C 2009	CHIP CAP.	4pF	50V	CH	GRM39CH040C50PT	K22174205		
C 2010	CHIP CAP.	39pF	50V	CH	GRM39CH390J50PT	K22174225		
C 2011	CHIP CAP.	33pF	50V	CH	GRM39CH330J50PT	K22174223		
C 2012	CHIP CAP.	100pF	50V	CH	GRM39CH101J50PT	K22174235		
C 2013	CHIP CAP.	39pF	50V	CH	GRM39CH390J50PT	K22174225		
C 2014	CHIP CAP.	2pF	50V	CK	GRM39CK020C50PT	K22174203		
C 2015	CHIP CAP.	39pF	50V	CH	GRM39CH390J50PT	K22174225		
C 2016	CHIP CAP.	100pF	50V	CH	GRM39CH101J50PT	K22174235		
C 2017	CHIP CAP.	39pF	50V	CH	GRM39CH390J50PT	K22174225		
C 2018	CHIP CAP.	39pF	50V	CH	GRM39CH390J50PT	K22174225		
C 2019	CHIP CAP.	100pF	50V	CH	GRM39CH101J50PT	K22174235		
C 2020	CHIP CAP.	4pF	50V	CH	GRM39CH040C50PT	K22174205		
C 2021	CHIP CAP.	22pF	50V	CH	GRM39CH220J50PT	K22174219		
C 2022	CHIP CAP.	39pF	50V	CH	GRM39CH390J50PT	K22174225		
C 2023	CHIP CAP.	39pF	50V	CH	GRM39CH390J50PT	K22174225		
C 2024	CHIP CAP.	4pF	50V	CH	GRM39CH040C50PT	K22174205		
C 2025	CHIP CAP.	22pF	50V	CH	GRM39CH220J50PT	K22174219		
C 2026	CHIP CAP.	39pF	50V	CH	GRM39CH390J50PT	K22174225		
C 2027	CHIP CAP.	100pF	50V	CH	GRM39CH101J50PT	K22174235		
C 2028	CHIP CAP.	47pF	50V	CH	GRM39CH470J50PT	K22174227		
C 2029	CHIP CAP.	6pF	50V	CH	GRM39CH060D50PT	K22174207		
C 2030	CHIP CAP.	10pF	50V	CH	GRM39CH100D50PT	K22174211		
C 2031	CHIP CAP.	0.01uF	50V	B	GRM39B103M50PT	K22174823		
C 2032	TANTALUM CHIP CAP.	1uF	16V		TESVA1C105M1-8R	K78120009		
C 2033	CHIP CAP.	100pF	50V	CH	GRM39CH101J50PT	K22174235		
C 2034	CHIP CAP.	0.01uF	50V	B	GRM39B103M50PT	K22174823		
C 2035	CHIP CAP.	0.01uF	50V	B	GRM39B103M50PT	K22174823		
C 2036	TANTALUM CHIP CAP.	1uF	16V		TESVA1C105M1-8R	K78120009		
C 2037	CHIP CAP.	0.01uF	50V	B	GRM39B103M50PT	K22174823		
C 2038	CHIP CAP.	0.01uF	50V	B	GRM39B103M50PT	K22174823		
C 2039	CHIP CAP.	0.01uF	50V	B	GRM39B103M50PT	K22174823		
C 2041	CHIP CAP.	0.01uF	50V	B	GRM39B103M50PT	K22174823		
C 2042	CHIP CAP.	2pF	50V	CK	GRM39CK020C50PT	K22174203		
C 2044	CHIP CAP.	0.01uF	50V	B	GRM39B103M50PT	K22174823		
C 2047	CHIP CAP.	0.01uF	50V	B	GRM39B103M50PT	K22174823		
C 2048	CHIP CAP.	0.01uF	50V	B	GRM39B103M50PT	K22174823		
C 2049	AL.ELECTRO.CAP.	10uF	16V		ECEV1CS100SR	K48120001		
C 2051	CHIP CAP.	0.01uF	50V	B	GRM39B103M50PT	K22174823		
C 2052	CHIP CAP.	0.01uF	50V	B	GRM39B103M50PT	K22174823		
C 2054	CHIP CAP.	0.01uF	50V	B	GRM39B103M50PT	K22174823		
C 2055	CHIP CAP.	0.01uF	50V	B	GRM39B103M50PT	K22174823		
C 2056	CHIP CAP.	5pF	50V	CH	GRM39CH050C50PT	K22174206		
C 2057	AL.ELECTRO.CAP.	10uF	16V		ECEV1CS100SR	K48120001		
C 2058	CHIP CAP.	0.001uF	50V	B	GRM39B102M50PT	K22174809		
C 2059	CHIP CAP.	10pF	50V	CH	GRM39CH100D50PT	K22174211		

# PLL Unit

REF.	DESCRIPTION	VALUE	V/W	TOL.	MFR'S DESIG	YAESU P/N	VERS.	LOT.
C 2060	CHIP CAP.	0.001uF	50V	B	GRM39B102M50PT	K22174809		
C 2061	AL.ELECTRO.CAP.	10uF	16V		ECEV1CS100SR	K48120001		
C 2062	AL.ELECTRO.CAP.	10uF	16V		ECEV1CS100SR	K48120001		
C 2063	CHIP CAP.	0.001uF	50V	B	GRM39B102M50PT	K22174809		
C 2064	CHIP CAP.	0.001uF	50V	B	GRM39B102M50PT	K22174809		
C 2065	CHIP CAP.	10pF	50V	CH	GRM39CH100D50PT	K22174211		
C 2068	AL.ELECTRO.CAP.	10uF	16V		ECEV1CS100SR	K48120001		
C 2069	CHIP CAP.	0.001uF	50V	B	GRM39B102M50PT	K22174809		
C 2070	AL.ELECTRO.CAP.	10uF	16V		ECEV1CS100SR	K48120001		
C 2071	AL.ELECTRO.CAP.	10uF	16V		ECEV1CS100SR	K48120001		
C 2072	CHIP CAP.	0.01uF	50V	B	GRM39B103M50PT	K22174823		
C 2073	CHIP CAP.	2pF	50V	CK	GRM39CK020C50PT	K22174203		
C 2074	CHIP CAP.	5pF	50V	CH	GRM39CH050C50PT	K22174206		
C 2075	CHIP CAP.	10pF	50V	CH	GRM39CH100D50PT	K22174211		
C 2076	CHIP CAP.	0.01uF	50V	B	GRM39B103M50PT	K22174823		
C 2077	CHIP CAP.	5pF	50V	CH	GRM39CH050C50PT	K22174206		
C 2078	CHIP CAP.	10pF	50V	CH	GRM39CH100D50PT	K22174211		
C 2079	CHIP CAP.	5pF	50V	CH	GRM39CH050C50PT	K22174206		
C 2080	CHIP CAP.	0.01uF	50V	B	GRM39B103M50PT	K22174823		
C 2081	CHIP CAP.	0.001uF	50V	B	GRM39B102M50PT	K22174809		
C 2082	CHIP CAP.	0.001uF	50V	B	GRM39B102M50PT	K22174809		
C 2083	CHIP CAP.	0.01uF	50V	B	GRM39B103M50PT	K22174823		
C 2084	CHIP CAP.	2pF	50V	CK	GRM39CK020C50PT	K22174203		
C 2085	CHIP CAP.	0.01uF	50V	B	GRM39B103M50PT	K22174823		
C 2086	CHIP CAP.	5pF	50V	CH	GRM39CH050C50PT	K22174206		
C 2087	CHIP CAP.	10pF	50V	CH	GRM39CH100D50PT	K22174211		
C 2088	CHIP CAP.	0.01uF	50V	B	GRM39B103M50PT	K22174823		
C 2089	CHIP CAP.	5pF	50V	CH	GRM39CH050C50PT	K22174206		
C 2090	CHIP CAP.	5pF	50V	CH	GRM39CH050C50PT	K22174206		
C 2091	CHIP CAP.	5pF	50V	CH	GRM39CH050C50PT	K22174206		
C 2092	CHIP CAP.	0.01uF	50V	B	GRM39B103M50PT	K22174823		
C 2093	CHIP CAP.	0.001uF	50V	B	GRM39B102M50PT	K22174809		
C 2094	CHIP CAP.	0.001uF	50V	B	GRM39B102M50PT	K22174809		
C 2095	CHIP CAP.	0.001uF	50V	B	GRM39B102M50PT	K22174809		
C 2096	CHIP CAP.	0.001uF	50V	B	GRM39B102M50PT	K22174809		
C 2097	CHIP CAP.	0.01uF	50V	B	GRM39B103M50PT	K22174823		
C 2098	CHIP CAP.	0.001uF	50V	B	GRM39B102M50PT	K22174809		
C 2099	CHIP CAP.	0.001uF	50V	B	GRM39B102M50PT	K22174809		
C 2100	CHIP CAP.	0.001uF	50V	B	GRM39B102M50PT	K22174809		
C 2101	CHIP CAP.	3pF	50V	CJ	GRM39CJ030C50PT	K22174204		
C 2102	CHIP CAP.	0.01uF	50V	B	GRM39B103M50PT	K22174823		
C 2103	AL.ELECTRO.CAP.	10uF	16V		ECEV1CS100SR	K48120001		
C 2104	CHIP CAP.	0.01uF	50V	B	GRM39B103M50PT	K22174823		
C 2105	CHIP CAP.	10pF	50V	CH	GRM39CH100D50PT	K22174211		
C 2106	CHIP CAP.	0.1uF	16V	B	GRM39B104K16PT	K22124805		
C 2107	CHIP CAP.	0.01uF	50V	B	GRM39B103M50PT	K22174823		
C 2108	CHIP CAP.	0.001uF	50V	B	GRM39B102M50PT	K22174809		
C 2109	CHIP CAP.	0.01uF	50V	B	GRM39B103M50PT	K22174823		
C 2110	AL.ELECTRO.CAP.	10uF	16V		ECEV1CS100SR	K48120001		
C 2111	CHIP CAP.	3pF	50V	CJ	GRM39CJ030C50PT	K22174204		
C 2112	CHIP CAP.	0.01uF	50V	B	GRM39B103M50PT	K22174823		
C 2113	CHIP CAP.	10pF	50V	CH	GRM39CH100D50PT	K22174211		
C 2114	CHIP CAP.	0.1uF	16V	B	GRM39B104K16PT	K22124805		
C 2117	CHIP CAP.	0.01uF	50V	B	GRM39B103M50PT	K22174823		
C 2118	CHIP CAP.	0.001uF	50V	B	GRM39B102M50PT	K22174809		
C 2119	CHIP CAP.	0.1uF	16V	B	GRM39B104K16PT	K22124805		

REF.	DESCRIPTION	VALUE	V/W	TOL.	MFR'S DESIG	YAESU P/N	VERS.	LOT.
C 2121	CHIP CAP.	0.001uF	50V	B	GRM39B102M50PT	K22174809		
C 2122	CHIP CAP.	0.001uF	50V	B	GRM39B102M50PT	K22174809		
C 2123	CHIP CAP.	0.1uF	16V	B	GRM39B104K16PT	K22124805		
C 2124	CHIP CAP.	0.01uF	50V	B	GRM39B103M50PT	K22174823		
C 2125	AL.ELECTRO.CAP.	10uF	16V		ECEV1CS100SR	K48120001		
C 2126	AL.ELECTRO.CAP.	10uF	16V		ECEV1CS100SR	K48120001		
C 2127	CHIP CAP.	0.01uF	50V	B	GRM39B103M50PT	K22174823		
C 2128	CHIP CAP.	0.001uF	50V	B	GRM39B102M50PT	K22174809		
C 2129	CHIP CAP.	0.1uF	16V	B	GRM39B104K16PT	K22124805		
C 2131	CHIP CAP.	0.001uF	50V	B	GRM39B102M50PT	K22174809		
C 2132	CHIP CAP.	0.001uF	50V	B	GRM39B102M50PT	K22174809		
C 2133	CHIP CAP.	0.1uF	16V	B	GRM39B104K16PT	K22124805		
C 2134	CHIP CAP.	0.01uF	50V	B	GRM39B103M50PT	K22174823		
C 2135	AL.ELECTRO.CAP.	10uF	16V		ECEV1CS100SR	K48120001		
C 2136	AL.ELECTRO.CAP.	10uF	16V		ECEV1CS100SR	K48120001		
C 2137	CHIP CAP.	0.01uF	50V	B	GRM39B103M50PT	K22174823		
C 2140	CHIP CAP.	0.1uF	16V	B	GRM39B104K16PT	K22124805		
C 2142	CHIP CAP.	12pF	50V	CH	GRM39CH120J50PT	K22174213		
C 2143	CHIP CAP.	56pF	50V	CH	GRM39CH560J50PT	K22174229		
C 2145	CHIP CAP.	27pF	50V	CH	GRM39CH270J50PT	K22174221		
C 2147	CHIP CAP.	0.001uF	50V	B	GRM39B102M50PT	K22174809		
C 2148	CHIP CAP.	27pF	50V	CH	GRM39CH270J50PT	K22174221		
C 2149	CHIP CAP.	56pF	50V	CH	GRM39CH560J50PT	K22174229		
C 2150	CHIP CAP.	0.001uF	50V	B	GRM39B102M50PT	K22174809		
C 2150	CHIP CAP.	10pF	50V	CH	GRM39CH100D50PT	K22174211		2-
C 2154	CHIP CAP.	0.1uF	16V	B	GRM39B104K16PT	K22124805		
C 2156	CHIP CAP.	12pF	50V	CH	GRM39CH120J50PT	K22174213		
C 2159	CHIP CAP.	27pF	50V	CH	GRM39CH270J50PT	K22174221		
C 2161	CHIP CAP.	0.001uF	50V	B	GRM39B102M50PT	K22174809		
C 2162	CHIP CAP.	27pF	50V	CH	GRM39CH270J50PT	K22174221		
C 2163	CHIP CAP.	56pF	50V	CH	GRM39CH560J50PT	K22174229		
C 2164	CHIP CAP.	56pF	50V	CH	GRM39CH560J50PT	K22174229		
C 2165	CHIP CAP.	0.001uF	50V	B	GRM39B102M50PT	K22174809		
C 2165	CHIP CAP.	10pF	50V	CH	GRM39CH100D50PT	K22174211		2-
C 2168	CHIP CAP.	0.01uF	50V	B	GRM39B103M50PT	K22174823		
C 2172	CHIP CAP.	0.001uF	50V	B	GRM39B102M50PT	K22174809		
C 2173	AL.ELECTRO.CAP.	10uF	16V		ECEV1CS100SR	K48120001		
C 2177	CHIP CAP.	0.01uF	50V	B	GRM39B103M50PT	K22174823		
C 2181	CHIP CAP.	0.001uF	50V	B	GRM39B102M50PT	K22174809		
C 2182	AL.ELECTRO.CAP.	10uF	16V		ECEV1CS100SR	K48120001		
C 2185	CHIP CAP.	0.001uF	50V	B	GRM39B102M50PT	K22174809		
C 2190	CHIP CAP.	0.001uF	50V	B	GRM39B102M50PT	K22174809		
C 2191	CHIP CAP.	0.1uF	16V	B	GRM39B104K16PT	K22124805		
C 2192	CHIP CAP.	0.01uF	50V	B	GRM39B103M50PT	K22174823		
C 2193	CHIP CAP.	0.01uF	50V	B	GRM39B103M50PT	K22174823		
C 2194	CHIP CAP.	22pF	50V	CH	GRM39CH220J50PT	K22174219		
C 2195	CHIP CAP.	22pF	50V	CH	GRM39CH220J50PT	K22174219		
C 2196	CHIP CAP.	10pF	50V	CH	GRM39CH100D50PT	K22174211		
C 2202	CHIP CAP.	0.001uF	50V	B	GRM39B102M50PT	K22174809		
C 2203	CHIP CAP.	0.01uF	50V	B	GRM39B103M50PT	K22174823		
C 2204	CHIP CAP.	0.01uF	50V	B	GRM39B103M50PT	K22174823		
C 2211	CHIP CAP.	0.01uF	50V	B	GRM39B103M50PT	K22174823		
C 2212	CHIP CAP.	0.01uF	50V	B	GRM39B103M50PT	K22174823		
C 2213	CHIP CAP.	0.01uF	50V	B	GRM39B103M50PT	K22174823		
C 2214	CHIP CAP.	0.01uF	50V	B	GRM39B103M50PT	K22174823		
C 2215	CHIP CAP.	0.01uF	50V	B	GRM39B103M50PT	K22174823		

# PLL Unit

REF.	DESCRIPTION	VALUE	V/W	TOL.	MFR'S DESIG	YAESU P/N	VERS.	LOT.
C 2216	CHIP CAP.	0.01uF	50V	B	GRM39B103M50PT	K22174823		
C 2217	CHIP CAP.	100pF	50V	CH	GRM39CH101J50PT	K22174235		
C 2218	CHIP CAP.	100pF	50V	CH	GRM39CH101J50PT	K22174235		
C 2219	CHIP CAP.	100pF	50V	CH	GRM39CH101J50PT	K22174235		
C 2220	CHIP CAP.	100pF	50V	CH	GRM39CH101J50PT	K22174235		
C 2221	CHIP CAP.	100pF	50V	CH	GRM39CH101J50PT	K22174235		
C 2222	CHIP CAP.	100pF	50V	CH	GRM39CH101J50PT	K22174235		
C 2223	CHIP CAP.	100pF	50V	CH	GRM39CH101J50PT	K22174235		
C 2224	CHIP CAP.	100pF	50V	CH	GRM39CH101J50PT	K22174235		
C 2225	CHIP CAP.	100pF	50V	CH	GRM39CH101J50PT	K22174235		
C 2226	CHIP CAP.	0.001uF	50V	B	GRM39B102M50PT	K22174809		
C 2227	CHIP CAP.	0.001uF	50V	B	GRM39B102M50PT	K22174809		
C 2228	CHIP CAP.	0.001uF	50V	B	GRM40B102M50PT	K22170805		
C 2229	CHIP CAP.	0.001uF	50V	B	GRM40B102M50PT	K22170805		
C 2230	CHIP CAP.	100pF	50V	CH	GRM40CH101J50PT	K22170235		
C 2231	CHIP CAP.	100pF	50V	CH	GRM40CH101J50PT	K22170235		
C 2232	CHIP CAP.	10pF	50V	CH	GRM39CH100D50PT	K22174211		
C 2233	CHIP CAP.	10pF	50V	CH	GRM39CH100D50PT	K22174211		
C 2235	CHIP CAP.	3pF	50V	CJ	GRM39CJ030C50PT	K22174204		
D 2001	DIODE				1SV217(TPH3)	G2070568		
D 2002	DIODE				1SV217(TPH3)	G2070568		
D 2003	DIODE				1SV217(TPH3)	G2070568		
D 2004	DIODE				1SV217(TPH3)	G2070568		
D 2005	DIODE				1SV217(TPH3)	G2070568		
D 2006	DIODE				1SV217(TPH3)	G2070568		
D 2007	DIODE				1SV217(TPH3)	G2070568		
D 2008	DIODE				1SV217(TPH3)	G2070568		
D 2009	DIODE				1SV217(TPH3)	G2070568		
D 2010	DIODE				1SV217(TPH3)	G2070568		
D 2011	DIODE				DAP202K T146	G2070180		
D 2012	DIODE				DAP202K T146	G2070180		
D 2013	DIODE				DAP202K T146	G2070180		
D 2014	DIODE				DAN202K T146	G2070182		
D 2015	DIODE				DAN202K T146	G2070182		
D 2016	DIODE				DAN202K T146	G2070182		
D 2017	DIODE				DAN202K T146	G2070182		
D 2018	DIODE				IMN10 T108	G2070078		
D 2019	DIODE				IMN10 T108	G2070078		
J 2001	CONNECTOR				SC25-03WS	P0090622		
J 2002	CONNECTOR				SC25-09WS	P0090628		
J 2003	CONNECTOR				SC25-10WS	P0090629		
J 2004	CONNECTOR				TMP-J01X-A2	P1090255		
J 2005	CONNECTOR				TMP-J01X-A2	P1090255		
J 2006	CONNECTOR				TMP-J01X-A2	P1090255		
L 2001	M.RFC	4.7uH			FLC32T-4R7K	L1690211		
L 2002	M.RFC	4.7uH			FLC32T-4R7K	L1690211		
L 2003	M.RFC	4.7uH			FLC32T-4R7K	L1690211		
L 2004	M.RFC	4.7uH			FLC32T-4R7K	L1690211		
L 2005	M.RFC	4.7uH			FLC32T-4R7K	L1690211		
L 2006	M.RFC	4.7uH			FLC32T-4R7K	L1690211		
L 2007	M.RFC	4.7uH			FLC32T-4R7K	L1690211		
L 2008	M.RFC	4.7uH			FLC32T-4R7K	L1690211		
L 2009	M.RFC	4.7uH			FLC32T-4R7K	L1690211		
L 2010	M.RFC	4.7uH			FLC32T-4R7K	L1690211		
L 2011	M.RFC	220uH			FLC32T-221J	L1690231		
L 2012	M.RFC	220uH			FLC32T-221J	L1690231		



REF.	DESCRIPTION	VALUE	V/W	TOL.	MFR'S DESIG	YAESU P/N	VERS.	LOT.
L 2015	M.RFC	220uH			FLC32T-221J	L1690231		
L 2019	M.RFC	5.6uH			FLC32T-5R6K	L1690212		
L 2022	M.RFC	220uH			FLC32T-221J	L1690231		
L 2023	M.RFC	5.6uH			FLC32T-5R6K	L1690212		
L 2024	M.RFC	5.6uH			FLC32T-5R6K	L1690212		
L 2025	M.RFC	220uH			FLC32T-221J	L1690231		
L 2026	M.RFC	220uH			FLC32T-221J	L1690231		
L 2030	M.RFC	5.6uH			FLC32T-5R6K	L1690212		
L 2033	M.RFC	5.6uH			FLC32T-5R6K	L1690212		
L 2034	M.RFC	5.6uH			FLC32T-5R6K	L1690212		
L 2035	M.RFC	220uH			FLC32T-221J	L1690231		
L 2036	M.RFC	220uH			FLC32T-221J	L1690231		
L 2040	M.RFC	1uH			FLC32T-1R0K	L1690203		
MD2001	VCO MODULE				MVCO-SM169	Q7000253		
MD2002	VCO MODULE				MVCO-SM200	Q7000254		
MD2003	VCO MODULE				MVCO-SM485	Q7000255		
MD2004	VCO MODULE				MVCO-SM531	Q7000256		
Q 2001	FET				2SK210GR TE85R	G3802107G		
Q 2002	TRANSISTOR				DTC114EK T96	G3070002		
Q 2003	FET				2SK210GR TE85R	G3802107G		
Q 2004	TRANSISTOR				DTC114EK T96	G3070002		
Q 2005	FET				2SK210GR TE85R	G3802107G		
Q 2006	TRANSISTOR				DTC114EK T96	G3070002		
Q 2007	TRANSISTOR				DTC114EK T96	G3070002		
Q 2008	FET				2SK210GR TE85R	G3802107G		
Q 2009	FET				2SK210GR TE85R	G3802107G		
Q 2010	TRANSISTOR				DTC114EK T96	G3070002		
Q 2011	TRANSISTOR				2SC3120TE85R	G3331207		
Q 2012	TRANSISTOR				2SC3120TE85R	G3331207		
Q 2013	TRANSISTOR				2SC3120TE85R	G3331207		
Q 2014	TRANSISTOR				2SC3356-T2B R24	G3333567D		
Q 2015	TRANSISTOR				FMC3 T148	G3070046		
Q 2016	TRANSISTOR				FMC3 T148	G3070046		
Q 2017	TRANSISTOR				FMC3 T148	G3070046		
Q 2018	TRANSISTOR				FMC3 T148	G3070046		
Q 2019	IC				BU4066BF-E2	G1092593		
Q 2020	TRANSISTOR				2SC3120TE85R	G3331207		
Q 2021	TRANSISTOR				2SC3120TE85R	G3331207		
Q 2022	TRANSISTOR				2SC3356-T2B R24	G3333567D		
Q 2023	TRANSISTOR				FMC3 T148	G3070046		
Q 2024	TRANSISTOR				FMC3 T148	G3070046		
Q 2025	TRANSISTOR				FMC3 T148	G3070046		
Q 2026	TRANSISTOR				FMC3 T148	G3070046		
Q 2027	IC				BU4094BCF-E2	G1092684		
Q 2028	IC				BU4066BF-E2	G1092593		
Q 2029	TRANSISTOR				2SC3120TE85R	G3331207		
Q 2030	TRANSISTOR				2SC3120TE85R	G3331207		
Q 2031	TRANSISTOR				2SC3356-T2B R24	G3333567D		
Q 2032	TRANSISTOR				FMC3 T148	G3070046		
Q 2033	TRANSISTOR				FMC3 T148	G3070046		
Q 2034	IC				BU4094BCF-E2	G1092684		
Q 2035	FET				2SK209Y TE85R	G3802097Y		
Q 2036	FET				2SK209Y TE85R	G3802097Y		
Q 2039	TRANSISTOR				2SC3356-T2B R24	G3333567D		
Q 2040	IC				FQ7925	G1091710		
Q 2041	TRANSISTOR				2SC3120TE85R	G3331207		

# PLL Unit

REF.	DESCRIPTION	VALUE	V/W	TOL.	MFR'S DESIG	YAESU P/N	VERS.	LOT.
Q 2042	IC				AD9850BRS-REEL	G1092567		
Q 2043	TRANSISTOR				2SC3356-T2B R24	G3333567D		
Q 2044	IC				FQ7925	G1091710		
Q 2045	TRANSISTOR				2SC3120TE85R	G3331207		
Q 2046	IC				AD9850BRS-REEL	G1092567		
Q 2051	TRANSISTOR				2SC2620QBTR	G3326207B		
Q 2052	TRANSISTOR				2SC3120TE85R	G3331207		
Q 2052	TRANSISTOR				2SC3356-T2B R24	G3333567D		2-
Q 2053	TRANSISTOR				DTC114EK T96	G3070002		
Q 2055	TRANSISTOR				2SC2620QBTR	G3326207B		
Q 2056	TRANSISTOR				2SC3120TE85R	G3331207		
Q 2056	TRANSISTOR				2SC3356-T2B R24	G3333567D		2-
Q 2057	TRANSISTOR				2SA812-T2B M6B	G3108127F		
Q 2060	TRANSISTOR				2SC3120TE85R	G3331207		
Q 2062	TRANSISTOR				DTC114EK T96	G3070002		
Q 2063	TRANSISTOR				2SA812-T2B M6B	G3108127F		
Q 2067	TRANSISTOR				2SC3120TE85R	G3331207		
Q 2071	TRANSISTOR				2SC3120TE85R	G3331207		
Q 2072	TRANSISTOR				2SA1283D	G3112830D		
Q 2073	TRANSISTOR				2SA1283D	G3112830D		
R 2001	CHIP RES.	47ohm	1/16W	5%	RMC1/16 470JATP	J24185470		
R 2002	CHIP RES.	47ohm	1/16W	5%	RMC1/16 470JATP	J24185470		
R 2003	CHIP RES.	47ohm	1/16W	5%	RMC1/16 470JATP	J24185470		
R 2004	CHIP RES.	47ohm	1/16W	5%	RMC1/16 470JATP	J24185470		
R 2005	CHIP RES.	47ohm	1/16W	5%	RMC1/16 470JATP	J24185470		
R 2006	CHIP RES.	1kohm	1/16W	5%	RMC1/16 102JATP	J24185102		
R 2007	CHIP RES.	470kohm	1/16W	5%	RMC1/16 474JATP	J24185474		
R 2008	CHIP RES.	470kohm	1/16W	5%	RMC1/16 474JATP	J24185474		
R 2009	CHIP RES.	150ohm	1/16W	5%	RMC1/16 151JATP	J24185151		
R 2010	CHIP RES.	150ohm	1/16W	5%	RMC1/16 151JATP	J24185151		
R 2011	CHIP RES.	470kohm	1/16W	5%	RMC1/16 474JATP	J24185474		
R 2012	CHIP RES.	150ohm	1/16W	5%	RMC1/16 151JATP	J24185151		
R 2013	CHIP RES.	470kohm	1/16W	5%	RMC1/16 474JATP	J24185474		
R 2014	CHIP RES.	150ohm	1/16W	5%	RMC1/16 151JATP	J24185151		
R 2015	CHIP RES.	470kohm	1/16W	5%	RMC1/16 474JATP	J24185474		
R 2016	CHIP RES.	150ohm	1/16W	5%	RMC1/16 151JATP	J24185151		
R 2017	CHIP RES.	1kohm	1/16W	5%	RMC1/16 102JATP	J24185102		
R 2019	CHIP RES.	0ohm	1/16W	5%	RMC1/16 000JATP	J24185000		
R 2020	CHIP RES.	3.3kohm	1/16W	5%	RMC1/16 332JATP	J24185332		
R 2021	CHIP RES.	3.3kohm	1/16W	5%	RMC1/16 332JATP	J24185332		
R 2023	CHIP RES.	0ohm	1/16W	5%	RMC1/16 000JATP	J24185000		
R 2024	CHIP RES.	47kohm	1/16W	5%	RMC1/16 473JATP	J24185473		
R 2025	CHIP RES.	10kohm	1/16W	5%	RMC1/16 103JATP	J24185103		
R 2026	CHIP RES.	100ohm	1/16W	5%	RMC1/16 101JATP	J24185101		
R 2027	CHIP RES.	47kohm	1/16W	5%	RMC1/16 473JATP	J24185473		
R 2028	CHIP RES.	47kohm	1/16W	5%	RMC1/16 473JATP	J24185473		
R 2029	CHIP RES.	47kohm	1/16W	5%	RMC1/16 473JATP	J24185473		
R 2030	CHIP RES.	47kohm	1/16W	5%	RMC1/16 473JATP	J24185473		
R 2031	CHIP RES.	6.8kohm	1/16W	5%	RMC1/16 682JATP	J24185682		
R 2032	CHIP RES.	3.3kohm	1/16W	5%	RMC1/16 332JATP	J24185332		
R 2034	CHIP RES.	0ohm	1/16W	5%	RMC1/16 000JATP	J24185000		
R 2035	CHIP RES.	220kohm	1/16W	5%	RMC1/16 224JATP	J24185224		
R 2036	CHIP RES.	2.2kohm	1/16W	5%	RMC1/16 222JATP	J24185222		
R 2037	CHIP RES.	220kohm	1/16W	5%	RMC1/16 224JATP	J24185224		
R 2040	CHIP RES.	100ohm	1/16W	5%	RMC1/16 101JATP	J24185101		
R 2041	CHIP RES.	220kohm	1/16W	5%	RMC1/16 224JATP	J24185224		

REF.	DESCRIPTION	VALUE	V/W	TOL.	MFR'S DESIG	YAESU P/N	VERS.	LOT.
R 2042	CHIP RES.	33ohm	1/16W	5%	RMC1/16 330JATP	J24185330		
R 2043	CHIP RES.	100ohm	1/16W	5%	RMC1/16 101JATP	J24185101		
R 2044	CHIP RES.	100ohm	1/16W	5%	RMC1/16 101JATP	J24185101		
R 2045	CHIP RES.	68ohm	1/16W	5%	RMC1/16 680JATP	J24185680		
R 2046	CHIP RES.	220kohm	1/16W	5%	RMC1/16 224JATP	J24185224		
R 2047	CHIP RES.	33ohm	1/16W	5%	RMC1/16 330JATP	J24185330		
R 2048	CHIP RES.	100ohm	1/16W	5%	RMC1/16 101JATP	J24185101		
R 2049	CHIP RES.	68ohm	1/16W	5%	RMC1/16 680JATP	J24185680		
R 2050	CHIP RES.	10ohm	1/16W	5%	RMC1/16 100JATP	J24185100		
R 2051	CHIP RES.	2.2kohm	1/16W	5%	RMC1/16 222JATP	J24185222		
R 2052	CHIP RES.	68kohm	1/16W	5%	RMC1/16 683JATP	J24185683		
R 2053	CHIP RES.	330ohm	1/16W	5%	RMC1/16 331JATP	J24185331		
R 2054	CHIP RES.	2.2kohm	1/16W	5%	RMC1/16 222JATP	J24185222		
R 2055	CHIP RES.	68kohm	1/16W	5%	RMC1/16 683JATP	J24185683		
R 2056	CHIP RES.	330ohm	1/16W	5%	RMC1/16 331JATP	J24185331		
R 2057	CHIP RES.	2.2kohm	1/16W	5%	RMC1/16 222JATP	J24185222		
R 2058	CHIP RES.	47kohm	1/16W	5%	RMC1/16 473JATP	J24185473		
R 2059	CHIP RES.	220ohm	1/16W	5%	RMC1/16 221JATP	J24185221		
R 2060	CHIP RES.	100kohm	1/16W	5%	RMC1/16 104JATP	J24185104		
R 2061	CHIP RES.	100kohm	1/16W	5%	RMC1/16 104JATP	J24185104		
R 2062	CHIP RES.	100kohm	1/16W	5%	RMC1/16 104JATP	J24185104		
R 2063	CHIP RES.	100kohm	1/16W	5%	RMC1/16 104JATP	J24185104		
R 2064	CHIP RES.	2.2kohm	1/16W	5%	RMC1/16 222JATP	J24185222		
R 2065	CHIP RES.	68kohm	1/16W	5%	RMC1/16 683JATP	J24185683		
R 2066	CHIP RES.	330ohm	1/16W	5%	RMC1/16 331JATP	J24185331		
R 2067	CHIP RES.	2.2kohm	1/16W	5%	RMC1/16 222JATP	J24185222		
R 2068	CHIP RES.	68kohm	1/16W	5%	RMC1/16 683JATP	J24185683		
R 2069	CHIP RES.	330ohm	1/16W	5%	RMC1/16 331JATP	J24185331		
R 2070	CHIP RES.	2.2kohm	1/16W	5%	RMC1/16 222JATP	J24185222		
R 2071	CHIP RES.	47kohm	1/16W	5%	RMC1/16 473JATP	J24185473		
R 2072	CHIP RES.	220ohm	1/16W	5%	RMC1/16 221JATP	J24185221		
R 2073	CHIP RES.	100kohm	1/16W	5%	RMC1/16 104JATP	J24185104		
R 2074	CHIP RES.	100kohm	1/16W	5%	RMC1/16 104JATP	J24185104		
R 2075	CHIP RES.	4.7kohm	1/16W	5%	RMC1/16 472JATP	J24185472		
R 2076	CHIP RES.	1Mohm	1/16W	5%	RMC1/16 105JATP	J24185105		
R 2077	CHIP RES.	4.7kohm	1/16W	5%	RMC1/16 472JATP	J24185472		
R 2078	CHIP RES.	1Mohm	1/16W	5%	RMC1/16 105JATP	J24185105		
R 2079	CHIP RES.	47ohm	1/16W	5%	RMC1/16 470JATP	J24185470		
R 2080	CHIP RES.	47kohm	1/16W	5%	RMC1/16 473JATP	J24185473		
R 2081	CHIP RES.	3.3kohm	1/16W	5%	RMC1/16 332JATP	J24185332		
R 2082	CHIP RES.	47ohm	1/16W	5%	RMC1/16 470JATP	J24185470		
R 2083	CHIP RES.	330ohm	1/16W	5%	RMC1/16 331JATP	J24185331		
R 2084	CHIP RES.	100kohm	1/16W	5%	RMC1/16 104JATP	J24185104		
R 2085	CHIP RES.	3.3kohm	1/16W	5%	RMC1/16 332JATP	J24185332		
R 2086	CHIP RES.	1kohm	1/16W	5%	RMC1/16 102JATP	J24185102		
R 2087	CHIP RES.	4.7kohm	1/16W	5%	RMC1/16 472JATP	J24185472		
R 2088	CHIP RES.	47ohm	1/16W	5%	RMC1/16 470JATP	J24185470		
R 2089	CHIP RES.	47kohm	1/16W	5%	RMC1/16 473JATP	J24185473		
R 2090	CHIP RES.	3.3kohm	1/16W	5%	RMC1/16 332JATP	J24185332		
R 2091	CHIP RES.	47ohm	1/16W	5%	RMC1/16 470JATP	J24185470		
R 2092	CHIP RES.	330ohm	1/16W	5%	RMC1/16 331JATP	J24185331		
R 2093	CHIP RES.	3.3kohm	1/16W	5%	RMC1/16 332JATP	J24185332		
R 2094	CHIP RES.	1kohm	1/16W	5%	RMC1/16 102JATP	J24185102		
R 2095	CHIP RES.	100kohm	1/16W	5%	RMC1/16 104JATP	J24185104		
R 2099	CHIP RES.	47ohm	1/16W	5%	RMC1/16 470JATP	J24185470		
R 2100	CHIP RES.	1kohm	1/16W	5%	RMC1/16 102JATP	J24185102		

# PLL Unit

REF.	DESCRIPTION	VALUE	V/W	TOL.	MFR'S DESIG	YAESU P/N	VERS.	LOT.
R 2102	CHIP RES.	1kohm	1/16W	5%	RMC1/16 102JATP	J24185102		
R 2105	CHIP RES.	4.7kohm	1/16W	5%	RMC1/16 472JATP	J24185472		
R 2106	CHIP RES.	100kohm	1/16W	5%	RMC1/16 104JATP	J24185104		
R 2107	CHIP RES.	4.7kohm	1/16W	5%	RMC1/16 472JATP	J24185472		
R 2108	CHIP RES.	4.7kohm	1/16W	5%	RMC1/16 472JATP	J24185472		
R 2109	CHIP RES.	3.9kohm	1/16W	5%	RMC1/16 392JATP	J24185392		
R 2110	CHIP RES.	47ohm	1/16W	5%	RMC1/16 470JATP	J24185470		
R 2111	CHIP RES.	1kohm	1/16W	5%	RMC1/16 102JATP	J24185102		
R 2113	CHIP RES.	1kohm	1/16W	5%	RMC1/16 102JATP	J24185102		
R 2115	CHIP RES.	4.7kohm	1/16W	5%	RMC1/16 472JATP	J24185472		
R 2117	CHIP RES.	100kohm	1/16W	5%	RMC1/16 104JATP	J24185104		
R 2119	CHIP RES.	4.7kohm	1/16W	5%	RMC1/16 472JATP	J24185472		
R 2120	CHIP RES.	3.9kohm	1/16W	5%	RMC1/16 392JATP	J24185392		
R 2126	CHIP RES.	100ohm	1/16W	5%	RMC1/16 101JATP	J24185101		
R 2127	CHIP RES.	470ohm	1/16W	5%	RMC1/16 471JATP	J24185471		
R 2128	CHIP RES.	1kohm	1/16W	5%	RMC1/16 102JATP	J24185102		
R 2129	CHIP RES.	100kohm	1/16W	5%	RMC1/16 104JATP	J24185104		
R 2130	CHIP RES.	3.3kohm	1/16W	5%	RMC1/16 332JATP	J24185332		
R 2131	CHIP RES.	680ohm	1/16W	5%	RMC1/16 681JATP	J24185681		
R 2132	CHIP RES.	100ohm	1/16W	5%	RMC1/16 101JATP	J24185101		
R 2133	CHIP RES.	2.2kohm	1/16W	5%	RMC1/16 222JATP	J24185222		
R 2134	CHIP RES.	10kohm	1/16W	5%	RMC1/16 103JATP	J24185103		
R 2141	CHIP RES.	100ohm	1/16W	5%	RMC1/16 101JATP	J24185101		
R 2142	CHIP RES.	470ohm	1/16W	5%	RMC1/16 471JATP	J24185471		
R 2143	CHIP RES.	1kohm	1/16W	5%	RMC1/16 102JATP	J24185102		
R 2144	CHIP RES.	3.3kohm	1/16W	5%	RMC1/16 332JATP	J24185332		
R 2145	CHIP RES.	680ohm	1/16W	5%	RMC1/16 681JATP	J24185681		
R 2146	CHIP RES.	100ohm	1/16W	5%	RMC1/16 101JATP	J24185101		
R 2147	CHIP RES.	100kohm	1/16W	5%	RMC1/16 104JATP	J24185104		
R 2148	CHIP RES.	2.2kohm	1/16W	5%	RMC1/16 222JATP	J24185222		
R 2150	CHIP RES.	10kohm	1/16W	5%	RMC1/16 103JATP	J24185103		
R 2151	CHIP RES.	4.7kohm	1/16W	5%	RMC1/16 472JATP	J24185472		
R 2156	CHIP RES.	220kohm	1/16W	5%	RMC1/16 224JATP	J24185224		
R 2157	CHIP RES.	330ohm	1/16W	5%	RMC1/16 331JATP	J24185331		
R 2158	CHIP RES.	15ohm	1/16W	5%	RMC1/16 150JATP	J24185150		
R 2159	CHIP RES.	330ohm	1/16W	5%	RMC1/16 331JATP	J24185331		
R 2160	CHIP RES.	10kohm	1/16W	5%	RMC1/16 103JATP	J24185103		
R 2162	CHIP RES.	1kohm	1/16W	5%	RMC1/16 102JATP	J24185102		
R 2164	CHIP RES.	10kohm	1/16W	5%	RMC1/16 103JATP	J24185103		
R 2165	CHIP RES.	4.7kohm	1/16W	5%	RMC1/16 472JATP	J24185472		
R 2168	CHIP RES.	4.7kohm	1/16W	5%	RMC1/16 472JATP	J24185472		
R 2169	CHIP RES.	4.7kohm	1/16W	5%	RMC1/16 472JATP	J24185472		
R 2170	CHIP RES.	220kohm	1/16W	5%	RMC1/16 224JATP	J24185224		
R 2171	CHIP RES.	330ohm	1/16W	5%	RMC1/16 331JATP	J24185331		
R 2172	CHIP RES.	15ohm	1/16W	5%	RMC1/16 150JATP	J24185150		
R 2173	CHIP RES.	330ohm	1/16W	5%	RMC1/16 331JATP	J24185331		
R 2174	CHIP RES.	1Mohm	1/16W	5%	RMC1/16 105JATP	J24185105		
R 2176	CHIP RES.	18ohm	1/16W	5%	RMC1/16 180JATP	J24185180		
R 2177	CHIP RES.	18ohm	1/16W	5%	RMC1/16 180JATP	J24185180		
R 2178	CHIP RES.	18ohm	1/16W	5%	RMC1/16 180JATP	J24185180		
R 2180	CHIP RES.	220ohm	1/16W	5%	RMC1/16 221JATP	J24185221		
R 2182	CHIP RES.	100kohm	1/16W	5%	RMC1/16 104JATP	J24185104		
R 2183	CHIP RES.	1Mohm	1/16W	5%	RMC1/16 105JATP	J24185105		
R 2187	CHIP RES.	68ohm	1/16W	5%	RMC1/16 680JATP	J24185680		
R 2188	CHIP RES.	1kohm	1/16W	5%	RMC1/16 102JATP	J24185102		
R 2189	CHIP RES.	1kohm	1/16W	5%	RMC1/16 102JATP	J24185102		

REF.	DESCRIPTION	VALUE	V/W	TOL.	MFR'S DESIG	YAESU P/N	VERS.	LOT.
R 2190	CHIP RES.	1kohm	1/16W	5%	RMC1/16 102JATP	J24185102		
R 2191	CHIP RES.	1kohm	1/16W	5%	RMC1/16 102JATP	J24185102		
R 2192	CARBON FILM RES.	470ohm	1/6W	5%	RD16PJ471 470	J01225471		
R 2193	CARBON FILM RES.	470ohm	1/6W	5%	RD16PJ471 470	J01225471		
R 2194	CARBON FILM RES.	4.7kohm	1/6W	5%	RD16PJ472 4.7K	J01225472		
R 2195	CARBON FILM RES.	4.7kohm	1/6W	5%	RD16PJ472 4.7K	J01225472		
R 2196	CARBON FILM RES.	4.7kohm	1/6W	5%	RD16PJ472 4.7K	J01225472		
R 2197	CARBON FILM RES.	4.7kohm	1/6W	5%	RD16PJ472 4.7K	J01225472		
R 2198	CARBON FILM RES.	3.3kohm	1/6W	5%	RD16PJ332 3.3K	J01225332		
R 2199	CARBON FILM RES.	3.3kohm	1/6W	5%	RD16PJ332 3.3K	J01225332		
R 2207	CARBON FILM RES.	470ohm	1/6W	5%	RD16PJ471 470	J01225471		
R 2208	CARBON FILM RES.	470ohm	1/6W	5%	RD16PJ471 470	J01225471		
T 2001	COIL 05RF				CS-4N 5203-JPS-074	L0022505		
T 2002	COIL 05RF				CS-4N 5203-JPS-075	L0022506		
T 2003	COIL 05RF				CS-4N 5203-JPS-076	L0022507		
T 2004	COIL 05RF				CS-4N 5203-JPS-077	L0022508		
T 2005	COIL 05RF				CS-4N 5203-JPS-078	L0022509		
TP2001	TERMINAL				TP-G MK1095	Q5000036		
TP2002	TERMINAL				TP-G MK1095	Q5000036		
TP2003	TERMINAL				TP-G MK1095	Q5000036		
Z 2001	SHIELD CASE					RA0069800		
Z 2002	SHIELD CASE COVER					RA0069900		
Z 2003	SHIELD CASE (4pcs)					RA0071300		

# PLL Unit

---

*Notes:*

Circuit Diagram

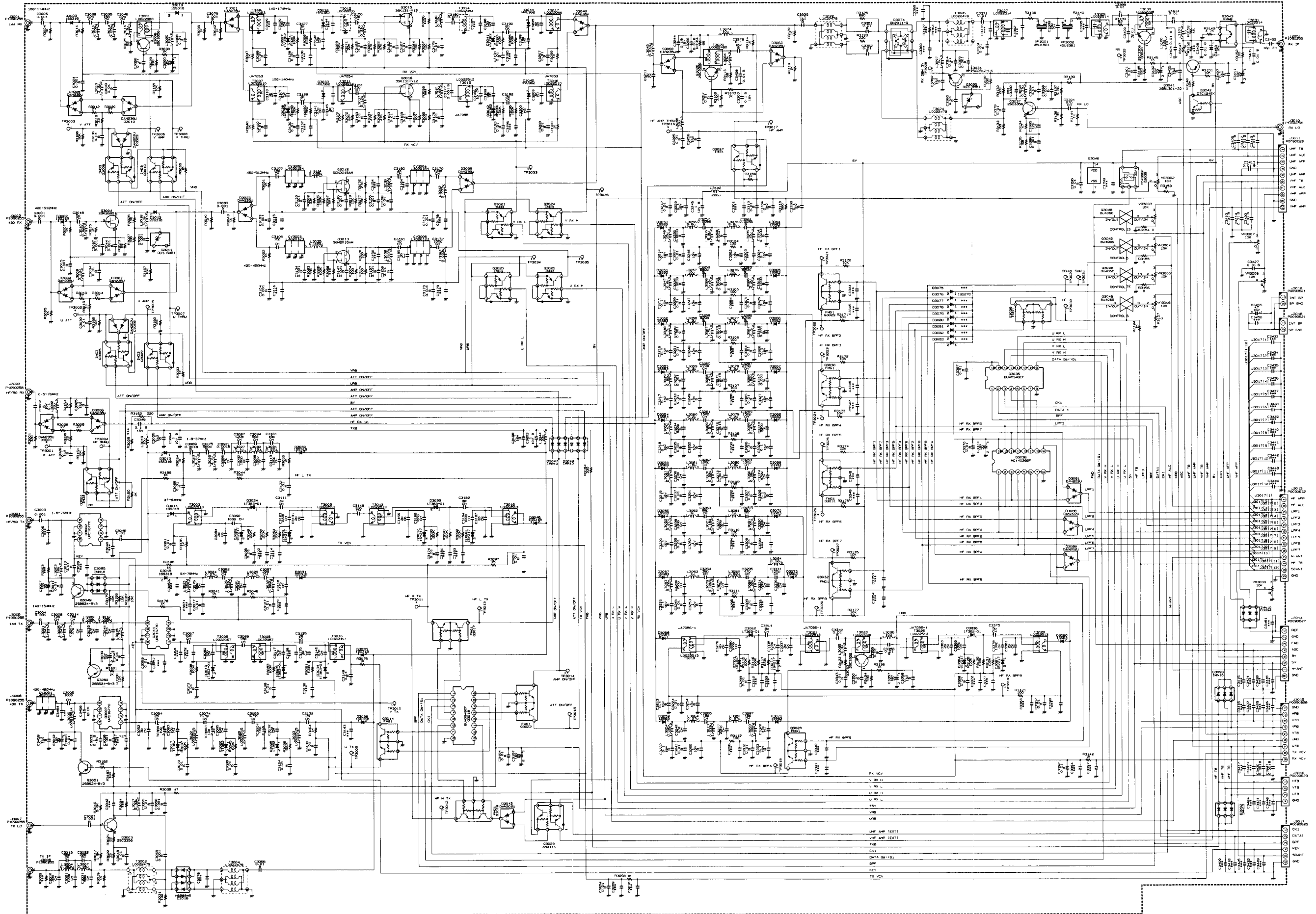



Parts Layout

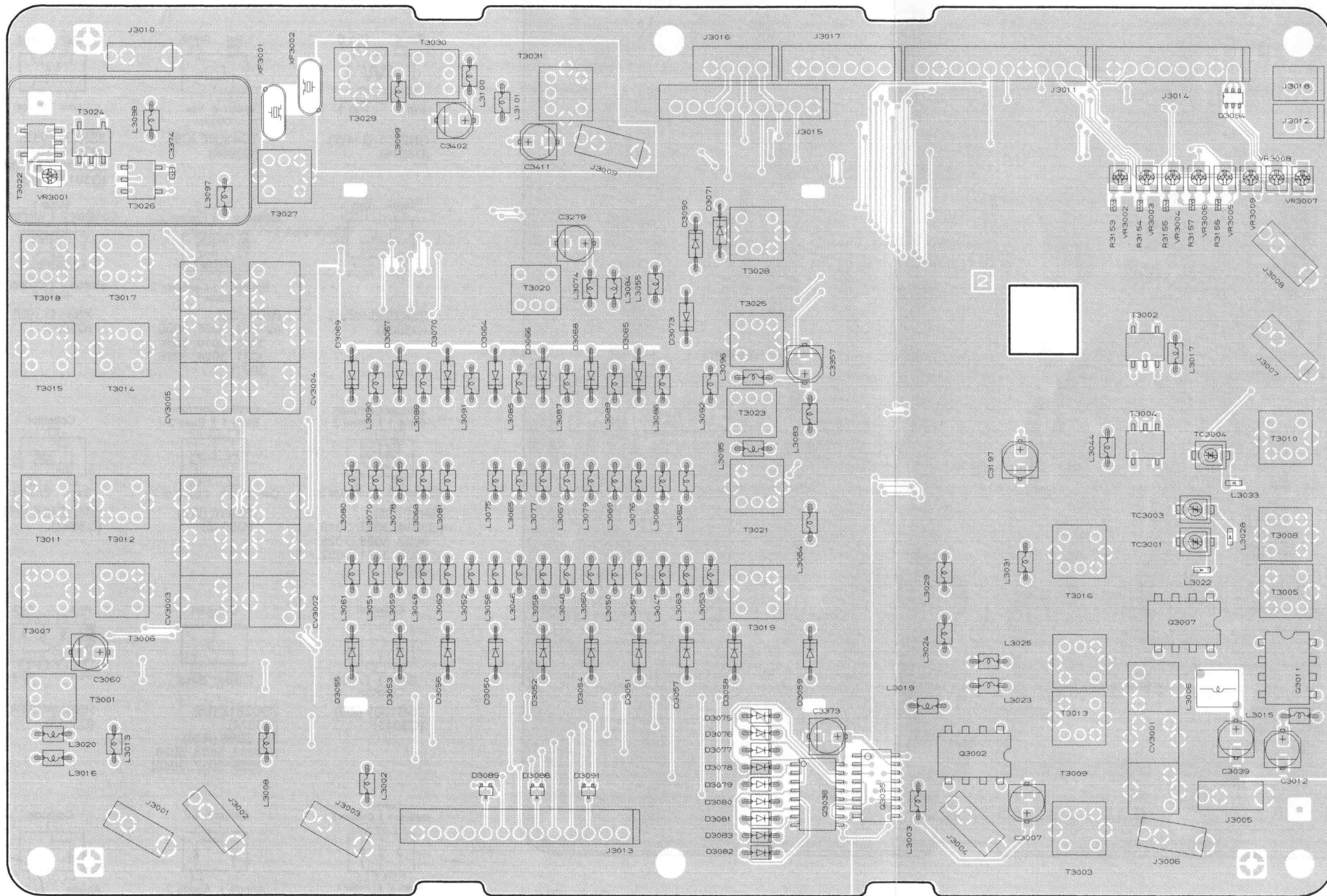

Component Side

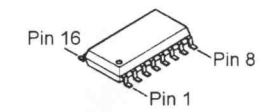

BU4094BCF  
(Q3035)  
MC14028BFL  
(Q3036)

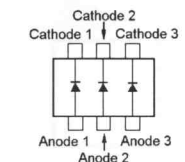

IMN10 (N10)  
(D3094)

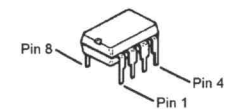

μPC1677C  
(Q3002, 3007, 3011)

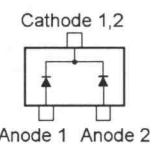

DAN202U (N)  
(D3088, 3089, 3091)



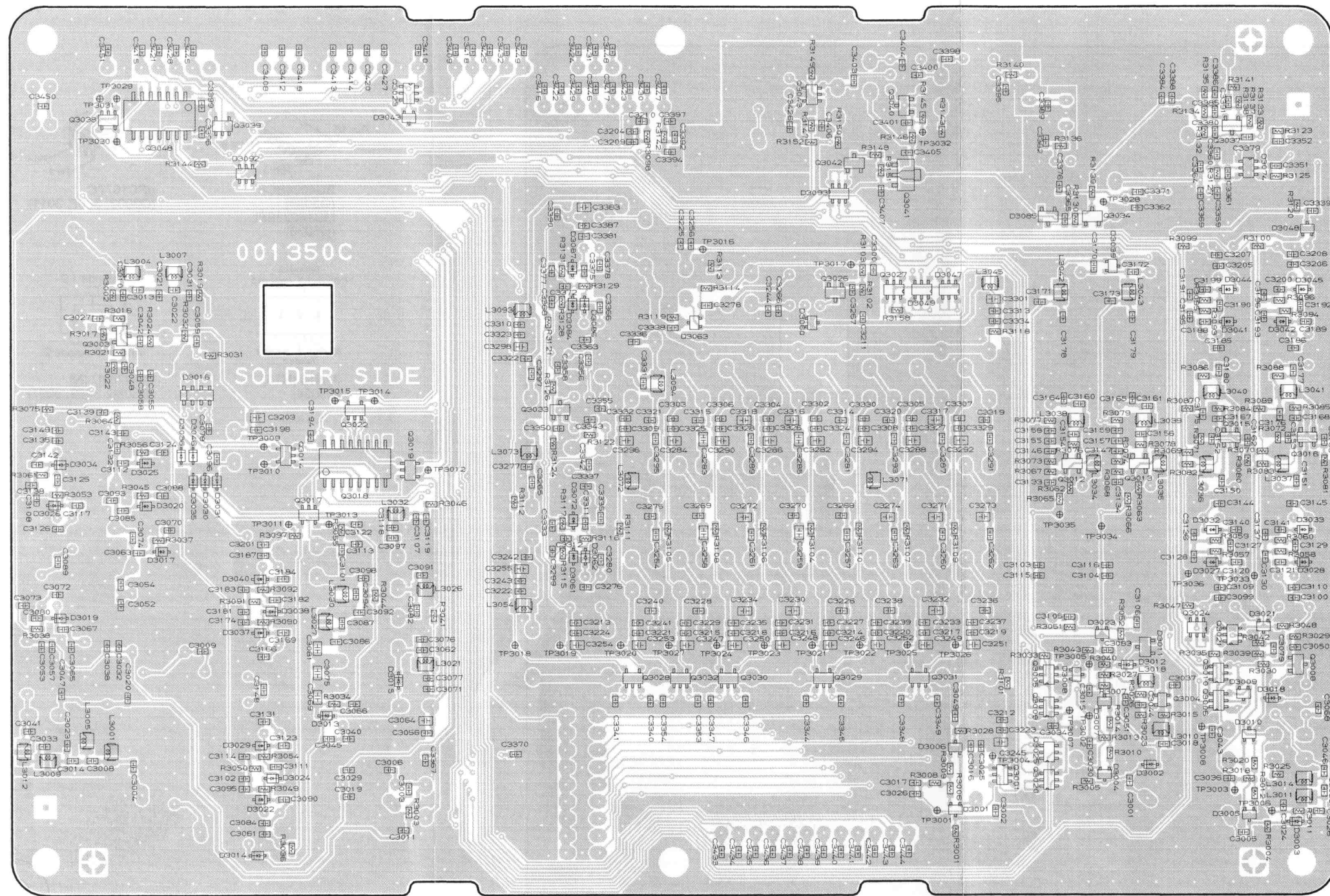

Chip Side

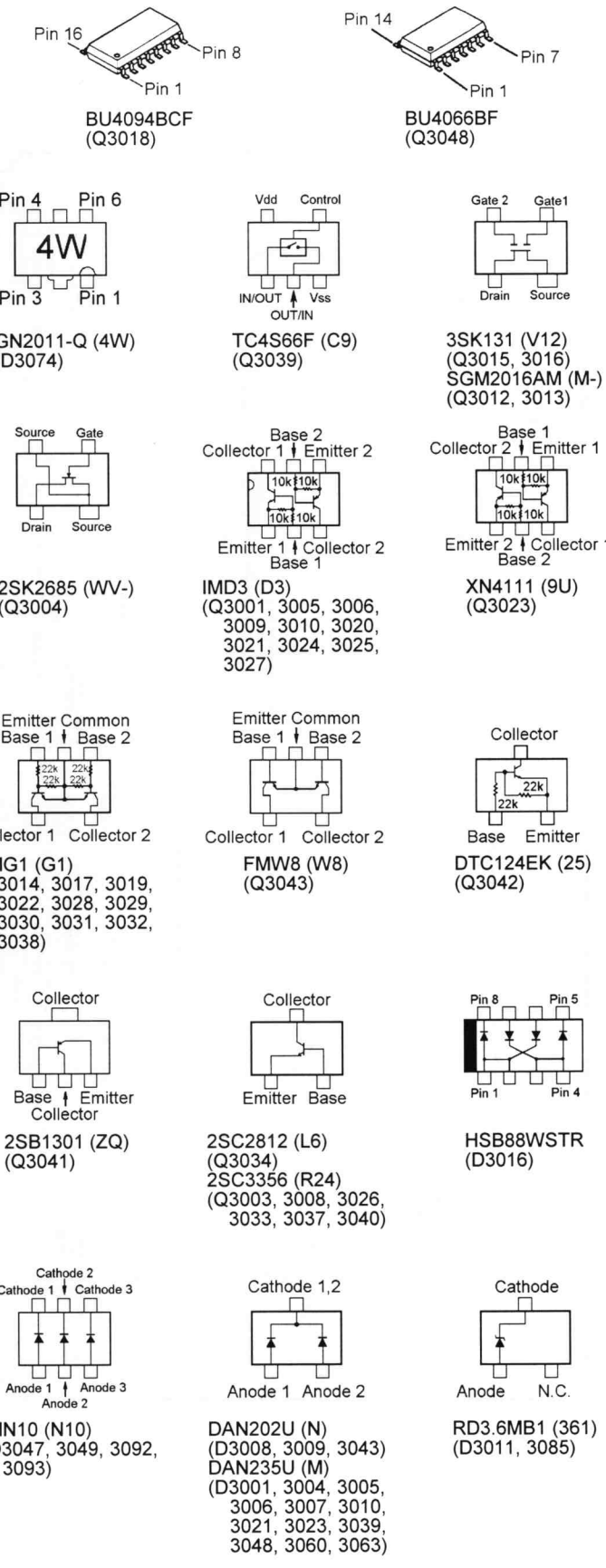

## Parts List

REF.	DESCRIPTION	VALUE	V/W	TOL.	MFR'S DESIG	YAESU P/N	VERS.	LOT.
*** RF UNIT ***								
PCB with Components						CB0216001		
Printed Circuit Board						FR001350C		
C 3001	CHIP CAP.	0.001uF	50V	B	GRM39B102M50PT	K22174809		
C 3002	CHIP CAP.	0.1uF	16V	B	GRM39B104K16PT	K22124805		
C 3003	CHIP CAP.	0.001uF	50V	B	GRM39B102M50PT	K22174809		
C 3004	CHIP CAP.	0.001uF	50V	B	GRM39B102M50PT	K22174809		
C 3005	CHIP CAP.	0.001uF	50V	B	GRM39B102M50PT	K22174809		
C 3007	AL.ELECTRO.CAP.	22uF	16V		ECEV1CA220SR	K48120002		
C 3008	CHIP CAP.	12pF	50V	CH	GRM39CH120J50PT	K22174213		
C 3009	CHIP CAP.	100pF	50V	CH	GRM39CH101J50PT	K22174235		
C 3010	CHIP CAP.	39pF	50V	CH	GRM39CH390J50PT	K22174225		
C 3011	CHIP CAP.	0.01uF	50V	B	GRM39B103M50PT	K22174823		
C 3012	AL.ELECTRO.CAP.	22uF	16V		ECEV1CA220SR	K48120002		
C 3013	CHIP CAP.	56pF	50V	CH	GRM39CH560J50PT	K22174229		
C 3014	CHIP CAP.	18pF	50V	CH	GRM39CH180J50PT	K22174217		
C 3015	CHIP CAP.	0.001uF	50V	B	GRM39B102M50PT	K22174809		
C 3018	CHIP CAP.	5pF	50V	CH	GRM39CH050C50PT	K22174206		
C 3019	CHIP CAP.	0.01uF	50V	B	GRM39B103M50PT	K22174823		
C 3020	CHIP CAP.	0.01uF	50V	B	GRM39B103M50PT	K22174823		
C 3021	CHIP CAP.	100pF	50V	CH	GRM39CH101J50PT	K22174235		
C 3022	CHIP CAP.	22pF	50V	CH	GRM39CH220J50PT	K22174219		
C 3023	CHIP CAP.	27pF	50V	CH	GRM39CH270J50PT	K22174221		
C 3024	CHIP CAP.	0.001uF	50V	B	GRM39B102M50PT	K22174809		
C 3025	CHIP CAP.	0.1uF	16V	B	GRM39B104K16PT	K22124805		
C 3026	CHIP CAP.	0.1uF	16V	B	GRM39B104K16PT	K22124805		
C 3027	CHIP CAP.	0.001uF	50V	B	GRM39B102M50PT	K22174809		
C 3028	CHIP CAP.	22pF	50V	CH	GRM39CH220J50PT	K22174219		
C 3030	CHIP CAP.	0.01uF	50V	B	GRM39B103M50PT	K22174823		
C 3031	CHIP CAP.	68pF	50V	CH	GRM39CH680J50PT	K22174231		
C 3032	CHIP CAP.	0.1uF	16V	B	GRM39B104K16PT	K22124805		
C 3033	CHIP CAP.	47pF	50V	CH	GRM39CH470J50PT	K22174227		
C 3034	CHIP CAP.	0.01uF	50V	B	GRM39B103M50PT	K22174823		
C 3035	CHIP CAP.	15pF	50V	CH	GRM39CH150J50PT	K22174215		
C 3036	CHIP CAP.	0.01uF	50V	B	GRM39B103M50PT	K22174823		
C 3037	CHIP CAP.	0.001uF	50V	B	GRM39B102M50PT	K22174809		
C 3038	CHIP CAP.	0.001uF	50V	B	GRM39B102M50PT	K22174809		
C 3039	AL.ELECTRO.CAP.	22uF	16V		ECEV1CA220SR	K48120002		
C 3041	CHIP CAP.	27pF	50V	CH	GRM39CH270J50PT	K22174221		
C 3043	CHIP CAP.	0.01uF	50V	B	GRM39B103M50PT	K22174823		
C 3044	CHIP CAP.	0.001uF	50V	B	GRM39B102M50PT	K22174809		
C 3045	CHIP CAP.	0.01uF	50V	B	GRM39B103M50PT	K22174823		
C 3046	CHIP CAP.	22pF	50V	CH	GRM39CH220J50PT	K22174219		
C 3047	CHIP CAP.	0.01uF	50V	B	GRM39B103M50PT	K22174823		
C 3048	CHIP CAP.	0.01uF	50V	B	GRM39B103M50PT	K22174823		
C 3049	CHIP CAP.	0.1uF	16V	B	GRM39B104K16PT	K22124805		
C 3050	CHIP CAP.	0.01uF	50V	B	GRM39B103M50PT	K22174823		
C 3051	CHIP CAP.	0.001uF	50V	B	GRM39B102M50PT	K22174809		
C 3052	CHIP CAP.	2pF	50V	CK	GRM39CK020C50PT	K22174203		
C 3053	CHIP CAP.	0.01uF	50V	B	GRM39B103M50PT	K22174823		
C 3054	CHIP CAP.	2pF	50V	CK	GRM39CK020C50PT	K22174203		
C 3055	CHIP CAP.	0.01uF	50V	B	GRM39B103M50PT	K22174823		
C 3056	CHIP CAP.	0.1uF	16V	B	GRM39B104K16PT	K22124805		
C 3058	CHIP CAP.	0.001uF	50V	B	GRM39B102M50PT	K22174809		
C 3059	CHIP CAP.	0.001uF	50V	B	GRM39B102M50PT	K22174809		
C 3060	AL.ELECTRO.CAP.	22uF	16V		ECEV1CA220SR	K48120002		

# RF Unit

REF.	DESCRIPTION	VALUE	V/W	TOL.	MFR'S DESIG	YAESU P/N	VERS.	LOT.
C 3061	CHIP CAP.	0.01uF	50V	B	GRM39B103M50PT	K22174823		
C 3063	CHIP CAP.	10pF	50V	CH	GRM39CH100D50PT	K22174211		
C 3064	CHIP CAP.	1uF	10V	B	GRM40B105K10PT	K22100802		
C 3066	CHIP CAP.	0.01uF	50V	B	GRM39B103M50PT	K22174823		
C 3067	CHIP CAP.	10pF	50V	CH	GRM39CH100D50PT	K22174211		
C 3068	CHIP CAP.	0.01uF	50V	B	GRM39B103M50PT	K22174823		
C 3069	CHIP CAP.	0.0018uF	50V	SL	GRM40SL182J50PT	K22170165		
C 3070	CHIP CAP.	0.01uF	50V	B	GRM39B103M50PT	K22174823		
C 3073	CHIP CAP.	0.01uF	50V	B	GRM39B103M50PT	K22174823		
C 3074	CHIP CAP.	0.5pF	50V	CK	GRM39CK0R5C50PT	K22174201		
C 3075	CHIP CAP.	560pF	50V	SL	GRM40SL561J50PT	K22170153		
C 3076	CHIP CAP.	68pF	50V	CH	GRM39CH680J50PT	K22174231		
C 3077	CHIP CAP.	0.01uF	50V	B	GRM39B103M50PT	K22174823		
C 3079	CHIP CAP.	0.001uF	50V	B	GRM39B102M50PT	K22174809		
C 3080	CHIP CAP.	33pF	50V	CH	GRM39CH330J50PT	K22174223		
C 3081	CHIP CAP.	0.0018uF	50V	SL	GRM40SL182J50PT	K22170165		
C 3082	CHIP CAP.	18pF	50V	CH	GRM39CH180J50PT	K22174217		
C 3083	CHIP CAP.	0.001uF	50V	B	GRM39B102M50PT	K22174809		
C 3084	CHIP CAP.	2pF	50V	CK	GRM39CK020C50PT	K22174203		
C 3085	CHIP CAP.	10pF	50V	CH	GRM39CH100D50PT	K22174211		
C 3086	CHIP CAP.	47pF	50V	CH	GRM39CH470J50PT	K22174227		
C 3087	CHIP CAP.	120pF	50V	CH	GRM39CH121J50PT	K22174237		
C 3088	CHIP CAP.	0.01uF	50V	B	GRM39B103M50PT	K22174823		
C 3089	CHIP CAP.	15pF	50V	CH	GRM39CH150J50PT	K22174215		
C 3090	CHIP CAP.	100pF	50V	CH	GRM39CH101J50PT	K22174235		
C 3091	CHIP CAP.	220pF	50V	CH	GRM39CH221J50PT	K22174243		
C 3092	CHIP CAP.	100pF	50V	CH	GRM39CH101J50PT	K22174235		
C 3093	CHIP CAP.	0.5pF	50V	CK	GRM39CK0R5C50PT	K22174201		
C 3094	CHIP CAP.	56pF	50V	CH	GRM39CH560J50PT	K22174229		
C 3095	CHIP CAP.	0.01uF	50V	B	GRM39B103M50PT	K22174823		
C 3096	CHIP CAP.	0.01uF	50V	B	GRM39B103M50PT	K22174823		
C 3097	CHIP CAP.	22pF	50V	CH	GRM39CH220J50PT	K22174219		
C 3098	CHIP CAP.	150pF	50V	CH	GRM39CH151J50PT	K22174239		
C 3099	CHIP CAP.	0.01uF	50V	B	GRM39B103M50PT	K22174823		
C 3100	CHIP CAP.	0.01uF	50V	B	GRM39B103M50PT	K22174823		
C 3101	CHIP CAP.	18pF	50V	CH	GRM39CH180J50PT	K22174217		
C 3103	CHIP CAP.	0.001uF	50V	B	GRM39B102M50PT	K22174809		
C 3104	CHIP CAP.	0.001uF	50V	B	GRM39B102M50PT	K22174809		
C 3105	CHIP CAP.	15pF	50V	CH	GRM39CH150J50PT	K22174215		
C 3106	CHIP CAP.	15pF	50V	CH	GRM39CH150J50PT	K22174215		
C 3107	CHIP CAP.	0.01uF	50V	B	GRM39B103M50PT	K22174823		
C 3108	CHIP CAP.	0.01uF	50V	B	GRM39B103M50PT	K22174823		
C 3110	CHIP CAP.	1pF	50V	CK	GRM39CK010C50PT	K22174202		
C 3111	CHIP CAP.	4pF	50V	CH	GRM39CH040C50PT	K22174205		
C 3112	CHIP CAP.	10pF	50V	CH	GRM39CH100D50PT	K22174211		
C 3113	CHIP CAP.	100pF	50V	CH	GRM39CH101J50PT	K22174235		
C 3117	CHIP CAP.	47pF	50V	CH	GRM39CH470J50PT	K22174227		
C 3118	CHIP CAP.	47pF	50V	CH	GRM39CH470J50PT	K22174227		
C 3120	CHIP CAP.	18pF	50V	CH	GRM39CH180J50PT	K22174217		
C 3121	CHIP CAP.	27pF	50V	CH	GRM39CH270J50PT	K22174221		
C 3122	CHIP CAP.	0.01uF	50V	B	GRM39B103M50PT	K22174823		
C 3123	CHIP CAP.	100pF	50V	CH	GRM39CH101J50PT	K22174235		
C 3124	CHIP CAP.	0.01uF	50V	B	GRM39B103M50PT	K22174823		
C 3125	CHIP CAP.	2pF	50V	CK	GRM39CK020C50PT	K22174203		
C 3127	CHIP CAP.	3pF	50V	CJ	GRM39CJ030C50PT	K22174204		
C 3128	CHIP CAP.	0.01uF	50V	B	GRM39B103M50PT	K22174823		

REF.	DESCRIPTION	VALUE	V/W	TOL.	MFR'S DESIG	YAESU P/N	VERS.	LOT.
C 3129	CHIP CAP.	3pF	50V	CJ	GRM39CJ030C50PT	K22174204		
C 3130	CHIP CAP.	0.01uF	50V	B	GRM39B103M50PT	K22174823		
C 3131	CHIP CAP.	2pF	50V	CK	GRM39CK020C50PT	K22174203		
C 3132	CHIP CAP.	2pF	50V	CK	GRM39CK020C50PT	K22174203		
C 3133	CHIP CAP.	0.001uF	50V	B	GRM39B102M50PT	K22174809		
C 3134	CHIP CAP.	0.001uF	50V	B	GRM39B102M50PT	K22174809		
C 3135	CHIP CAP.	3pF	50V	CJ	GRM39CJ030C50PT	K22174204		
C 3139	CHIP CAP.	0.01uF	50V	B	GRM39B103M50PT	K22174823		
C 3140	CHIP CAP.	12pF	50V	CH	GRM39CH120J50PT	K22174213		
C 3141	CHIP CAP.	27pF	50V	CH	GRM39CH270J50PT	K22174221		
C 3142	CHIP CAP.	47pF	50V	CH	GRM39CH470J50PT	K22174227		
C 3145	CHIP CAP.	3pF	50V	CJ	GRM39CJ030C50PT	K22174204		
C 3146	CHIP CAP.	0.001uF	50V	B	GRM39B102M50PT	K22174809		
C 3147	CHIP CAP.	0.001uF	50V	B	GRM39B102M50PT	K22174809		
C 3148	CHIP CAP.	33pF	50V	CH	GRM39CH330J50PT	K22174223		
C 3149	CHIP CAP.	0.01uF	50V	B	GRM39B103M50PT	K22174823		
C 3150	CHIP CAP.	22pF	50V	CH	GRM39CH220J50PT	K22174219		
C 3151	CHIP CAP.	33pF	50V	CH	GRM39CH330J50PT	K22174223		
C 3152	CHIP CAP.	0.01uF	50V	B	GRM39B103M50PT	K22174823		
C 3153	CHIP CAP.	0.01uF	50V	B	GRM39B103M50PT	K22174823		
C 3155	CHIP CAP.	0.001uF	50V	B	GRM39B102M50PT	K22174809		
C 3157	CHIP CAP.	0.001uF	50V	B	GRM39B102M50PT	K22174809		
C 3158	CHIP CAP.	0.01uF	50V	B	GRM39B103M50PT	K22174823		
C 3159	CHIP CAP.	0.01uF	50V	B	GRM39B103M50PT	K22174823		
C 3160	CHIP CAP.	4pF	50V	CH	GRM39CH040C50PT	K22174205		
C 3161	CHIP CAP.	4pF	50V	CH	GRM39CH040C50PT	K22174205		
C 3162	CHIP CAP.	0.01uF	50V	B	GRM39B103M50PT	K22174823		
C 3163	CHIP CAP.	0.01uF	50V	B	GRM39B103M50PT	K22174823		
C 3165	CHIP CAP.	3pF	50V	CJ	GRM39CJ030C50PT	K22174204		
C 3166	CHIP CAP.	2pF	50V	CK	GRM39CK020C50PT	K22174203		
C 3167	CHIP CAP.	0.01uF	50V	B	GRM39B103M50PT	K22174823		
C 3168	CHIP CAP.	0.01uF	50V	B	GRM39B103M50PT	K22174823		
C 3169	CHIP CAP.	100pF	50V	CH	GRM39CH101J50PT	K22174235		
C 3170	CHIP CAP.	100pF	50V	CH	GRM39CH101J50PT	K22174235		
C 3171	CHIP CAP.	0.001uF	50V	B	GRM39B102M50PT	K22174809		
C 3172	CHIP CAP.	100pF	50V	CH	GRM39CH101J50PT	K22174235		
C 3173	CHIP CAP.	0.001uF	50V	B	GRM39B102M50PT	K22174809		
C 3174	CHIP CAP.	0.01uF	50V	B	GRM39B103M50PT	K22174823		
C 3175	CHIP CAP.	0.01uF	50V	B	GRM39B103M50PT	K22174823		
C 3176	CHIP CAP.	0.01uF	50V	B	GRM39B103M50PT	K22174823		
C 3177	CHIP CAP.	0.001uF	50V	B	GRM39B102M50PT	K22174809		
C 3180	CHIP CAP.	0.001uF	50V	B	GRM39B102M50PT	K22174809		
C 3182	CHIP CAP.	6pF	50V	CH	GRM39CH060D50PT	K22174207		
C 3184	CHIP CAP.	100pF	50V	CH	GRM39CH101J50PT	K22174235		
C 3186	CHIP CAP.	1pF	50V	CK	GRM39CK010C50PT	K22174202		
C 3187	CHIP CAP.	2pF	50V	CK	GRM39CK020C50PT	K22174203		
C 3188	CHIP CAP.	15pF	50V	CH	GRM39CH150J50PT	K22174215		
C 3189	CHIP CAP.	18pF	50V	CH	GRM39CH180J50PT	K22174217		
C 3190	CHIP CAP.	2pF	50V	CK	GRM39CK020C50PT	K22174203		
C 3191	CHIP CAP.	0.01uF	50V	B	GRM39B103M50PT	K22174823		
C 3192	CHIP CAP.	2pF	50V	CK	GRM39CK020C50PT	K22174203		
C 3193	CHIP CAP.	0.01uF	50V	B	GRM39B103M50PT	K22174823		
C 3194	CHIP CAP.	0.01uF	50V	B	GRM39B103M50PT	K22174823		
C 3197	AL.ELECTRO.CAP.	22uF	16V		ECEV1CA220SR	K48120002		
C 3198	CHIP CAP.	0.1uF	16V	B	GRM39B104K16PT	K22124805		
C 3199	CHIP CAP.	15pF	50V	CH	GRM39CH150J50PT	K22174215		

# RF Unit

REF.	DESCRIPTION	VALUE	VW	TOL.	MFR'S DESIG	YAESU P/N	VERS.	LOT.
C 3200	CHIP CAP.	15pF	50V	CH	GRM39CH150J50PT	K22174215		
C 3201	CHIP CAP.	0.01uF	50V	B	GRM39B103M50PT	K22174823		
C 3203	CHIP CAP.	1uF	10V	B	GRM40B105K10PT	K22100802		
C 3204	CHIP CAP.	0.01uF	50V	B	GRM39B103M50PT	K22174823		
C 3205	CHIP CAP.	4pF	50V	CH	GRM39CH040C50PT	K22174205		
C 3206	CHIP CAP.	3pF	50V	CJ	GRM39CJ030C50PT	K22174204		
C 3207	CHIP CAP.	0.01uF	50V	B	GRM39B103M50PT	K22174823		
C 3208	CHIP CAP.	0.01uF	50V	B	GRM39B103M50PT	K22174823		
C 3211	CHIP CAP.	2pF	50V	CK	GRM39CK020C50PT	K22174203		
C 3212	CHIP CAP.	0.01uF	50V	B	GRM39B103M50PT	K22174823		
C 3213	CHIP CAP.	0.1uF	16V	B	GRM39B104K16PT	K22124805		
C 3214	CHIP CAP.	0.1uF	16V	B	GRM39B104K16PT	K22124805		
C 3215	CHIP CAP.	0.1uF	16V	B	GRM39B104K16PT	K22124805		
C 3216	CHIP CAP.	0.1uF	16V	B	GRM39B104K16PT	K22124805		
C 3217	CHIP CAP.	0.1uF	16V	B	GRM39B104K16PT	K22124805		
C 3218	CHIP CAP.	0.1uF	16V	B	GRM39B104K16PT	K22124805		
C 3219	CHIP CAP.	0.1uF	16V	B	GRM39B104K16PT	K22124805		
C 3220	CHIP CAP.	0.1uF	16V	B	GRM39B104K16PT	K22124805		
C 3221	CHIP CAP.	0.1uF	16V	B	GRM39B104K16PT	K22124805		
C 3222	CHIP CAP.	0.1uF	16V	B	GRM39B104K16PT	K22124805		
C 3223	CHIP CAP.	0.1uF	16V	B	GRM39B104K16PT	K22124805		
C 3224	CHIP CAP.	0.01uF	50V	B	GRM39B103M50PT	K22174823		
C 3225	CHIP CAP.	0.01uF	50V	B	GRM39B103M50PT	K22174823		
C 3226	CHIP CAP.	0.0033uF	50V	B	GRM39B332M50PT	K22174815		
C 3227	CHIP CAP.	0.01uF	50V	B	GRM39B103M50PT	K22174823		
C 3228	CHIP CAP.	0.0033uF	50V	B	GRM39B332M50PT	K22174815		
C 3229	CHIP CAP.	0.01uF	50V	B	GRM39B103M50PT	K22174823		
C 3230	CHIP CAP.	0.0018uF	50V	SL	GRM40SL182J50PT	K22170165		
C 3230	CHIP CAP.	0.001uF	50V	SL	GRM40SL102J50PT	K22170159		2-
C 3231	CHIP CAP.	0.01uF	50V	B	GRM39B103M50PT	K22174823		
C 3232	CHIP CAP.	820pF	50V	SL	GRM40SL821J50PT	K22170157		
C 3232	CHIP CAP.	0.001uF	50V	SL	GRM40SL102J50PT	K22170159		2-
C 3233	CHIP CAP.	0.01uF	50V	B	GRM39B103M50PT	K22174823		
C 3234	CHIP CAP.	820pF	50V	SL	GRM40SL821J50PT	K22170157		
C 3235	CHIP CAP.	0.01uF	50V	B	GRM39B103M50PT	K22174823		
C 3236	CHIP CAP.	470pF	50V	CH	GRM39CH471J50PT	K22174249		
C 3237	CHIP CAP.	0.01uF	50V	B	GRM39B103M50PT	K22174823		
C 3238	CHIP CAP.	330pF	50V	CH	GRM39CH331J50PT	K22174253		
C 3239	CHIP CAP.	0.01uF	50V	B	GRM39B103M50PT	K22174823		
C 3240	CHIP CAP.	150pF	50V	CH	GRM39CH151J50PT	K22174239		
C 3241	CHIP CAP.	0.01uF	50V	B	GRM39B103M50PT	K22174823		
C 3242	CHIP CAP.	47pF	50V	CH	GRM39CH470J50PT	K22174227		
C 3243	CHIP CAP.	0.01uF	50V	B	GRM39B103M50PT	K22174823		
C 3244	CHIP CAP.	0.1uF	16V	B	GRM39B104K16PT	K22124805		
C 3245	CHIP CAP.	1uF	10V	B	GRM40B105K10PT	K22100802		
C 3246	CHIP CAP.	1uF	10V	B	GRM40B105K10PT	K22100802		
C 3247	CHIP CAP.	1uF	10V	B	GRM40B105K10PT	K22100802		
C 3248	CHIP CAP.	1uF	10V	B	GRM40B105K10PT	K22100802		
C 3249	CHIP CAP.	1uF	10V	B	GRM40B105K10PT	K22100802		
C 3250	CHIP CAP.	1uF	10V	B	GRM40B105K10PT	K22100802		
C 3251	CHIP CAP.	1uF	10V	B	GRM40B105K10PT	K22100802		
C 3252	CHIP CAP.	1uF	10V	B	GRM40B105K10PT	K22100802		
C 3253	CHIP CAP.	1uF	10V	B	GRM40B105K10PT	K22100802		
C 3254	CHIP CAP.	1uF	10V	B	GRM40B105K10PT	K22100802		
C 3255	CHIP CAP.	1uF	10V	B	GRM40B105K10PT	K22100802		
C 3256	CHIP CAP.	0.1uF	16V	B	GRM39B104K16PT	K22124805		



REF.	DESCRIPTION	VALUE	V/W	TOL.	MFR'S DESIG	YAESU P/N	VERS.	LOT.
C 3257	CHIP CAP.	0.0056uF	50V	B	GRM39B562M50PT	K22174818		
C 3258	CHIP CAP.	680pF	50V	SL	GRM40SL681J50PT	K22170155		
C 3259	CHIP CAP.	680pF	50V	SL	GRM40SL681J50PT	K22170155		
C 3259	CHIP CAP.	820pF	50V	SL	GRM40SL821J50PT	K22170157		2-
C 3260	CHIP CAP.	470pF	50V	CH	GRM39CH471J50PT	K22174249		
C 3260	CHIP CAP.	270pF	50V	CH	GRM39CH271J50PT	K22174251		2-
C 3261	CHIP CAP.	150pF	50V	CH	GRM39CH151J50PT	K22174239		
C 3262	CHIP CAP.	100pF	50V	CH	GRM39CH101J50PT	K22174235		
C 3263	CHIP CAP.	82pF	50V	CH	GRM39CH820J50PT	K22174233		
C 3264	CHIP CAP.	39pF	50V	CH	GRM39CH390J50PT	K22174225		
C 3265	CHIP CAP.	18pF	50V	CH	GRM39CH180J50PT	K22174217		
C 3266	CHIP CAP.	0.01uF	50V	B	GRM39B103M50PT	K22174823		
C 3267	CHIP CAP.	0.01uF	50V	B	GRM39B103M50PT	K22174823		
C 3268	CHIP CAP.	0.0047uF	50V	B	GRM39B472M50PT	K22174817		
C 3269	CHIP CAP.	0.0056uF	50V	B	GRM39B562M50PT	K22174818		
C 3270	CHIP CAP.	0.0027uF	50V	B	GRM39B272M50PT	K22174814		
C 3270	CHIP CAP.	0.0018uF	50V	B	GRM39B182M50PT	K22174812		2-
C 3271	CHIP CAP.	0.0015uF	50V	SL	GRM40SL152J50PT	K22170163		
C 3271	CHIP CAP.	0.0018uF	50V	SL	GRM40SL182J50PT	K22170165		2-
C 3272	CHIP CAP.	0.0015uF	50V	SL	GRM40SL152J50PT	K22170163		
C 3273	CHIP CAP.	0.001uF	50V	SL	GRM40SL102J50PT	K22170159		
C 3274	CHIP CAP.	680pF	50V	SL	GRM40SL681J50PT	K22170155		
C 3275	CHIP CAP.	470pF	50V	CH	GRM39CH471J50PT	K22174249		
C 3276	CHIP CAP.	2pF	50V	CK	GRM39CK020C50PT	K22174203		
C 3277	CHIP CAP.	220pF	50V	CH	GRM39CH221J50PT	K22174243		
C 3278	CHIP CAP.	0.1uF	16V	B	GRM39B104K16PT	K22124805		
C 3280	CHIP CAP.	100pF	50V	CH	GRM39CH101J50PT	K22174235		
C 3281	CHIP CAP.	0.0056uF	50V	B	GRM39B562M50PT	K22174818		
C 3282	CHIP CAP.	1uF	10V	B	GRM40B105K10PT	K22100802		
C 3283	CHIP CAP.	680pF	50V	SL	GRM40SL681J50PT	K22170155		
C 3285	CHIP CAP.	680pF	50V	SL	GRM40SL681J50PT	K22170155		
C 3285	CHIP CAP.	820pF	50V	SL	GRM40SL821J50PT	K22170157		2-
C 3287	CHIP CAP.	470pF	50V	CH	GRM39CH471J50PT	K22174249		
C 3287	CHIP CAP.	270pF	50V	CH	GRM39CH271J50PT	K22174251		2-
C 3289	CHIP CAP.	150pF	50V	CH	GRM39CH151J50PT	K22174239		
C 3291	CHIP CAP.	100pF	50V	CH	GRM39CH101J50PT	K22174235		
C 3293	CHIP CAP.	82pF	50V	CH	GRM39CH820J50PT	K22174233		
C 3295	CHIP CAP.	47pF	50V	CH	GRM39CH470J50PT	K22174227		
C 3297	CHIP CAP.	18pF	50V	CH	GRM39CH180J50PT	K22174217		
C 3299	CHIP CAP.	0.01uF	50V	B	GRM39B103M50PT	K22174823		
C 3300	CHIP CAP.	0.1uF	16V	B	GRM39B104K16PT	K22124805		
C 3303	CHIP CAP.	0.01uF	50V	B	GRM39B103M50PT	K22174823		
C 3304	CHIP CAP.	0.01uF	50V	B	GRM39B103M50PT	K22174823		
C 3305	CHIP CAP.	0.01uF	50V	B	GRM39B103M50PT	K22174823		
C 3306	CHIP CAP.	0.01uF	50V	B	GRM39B103M50PT	K22174823		
C 3307	CHIP CAP.	0.01uF	50V	B	GRM39B103M50PT	K22174823		
C 3308	CHIP CAP.	0.01uF	50V	B	GRM39B103M50PT	K22174823		
C 3309	CHIP CAP.	0.01uF	50V	B	GRM39B103M50PT	K22174823		
C 3310	CHIP CAP.	0.01uF	50V	B	GRM39B103M50PT	K22174823		
C 3311	CHIP CAP.	8pF	50V	CH	GRM39CH080D50PT	K22174209		
C 3313	CHIP CAP.	0.01uF	50V	B	GRM39B103M50PT	K22174823		
C 3314	CHIP CAP.	0.0033uF	50V	B	GRM39B332M50PT	K22174815		
C 3315	CHIP CAP.	0.0033uF	50V	B	GRM39B332M50PT	K22174815		
C 3316	CHIP CAP.	0.0018uF	50V	SL	GRM40SL182J50PT	K22170165		
C 3316	CHIP CAP.	0.001uF	50V	SL	GRM40SL102J50PT	K22170159		
C 3317	CHIP CAP.	820pF	50V	SL	GRM40SL821J50PT	K22170157		2-

# RF Unit

REF.	DESCRIPTION	VALUE	V/W	TOL.	MFR'S DESIG	YAESU P/N	VERS.	LOT.
C 3317	CHIP CAP.	0.001uF	50V	SL	GRM40SL102J50PT	K22170159		2-
C 3318	CHIP CAP.	820pF	50V	SL	GRM40SL821J50PT	K22170157		
C 3319	CHIP CAP.	470pF	50V	CH	GRM39CH471J50PT	K22174249		
C 3320	CHIP CAP.	330pF	50V	CH	GRM39CH331J50PT	K22174253		
C 3321	CHIP CAP.	220pF	50V	CH	GRM39CH221J50PT	K22174243		
C 3322	CHIP CAP.	47pF	50V	CH	GRM39CH470J50PT	K22174227		
C 3323	CHIP CAP.	0.1uF	16V	B	GRM39B104K16PT	K22124805		
C 3324	CHIP CAP.	0.1uF	16V	B	GRM39B104K16PT	K22124805		
C 3325	CHIP CAP.	0.1uF	16V	B	GRM39B104K16PT	K22124805		
C 3326	CHIP CAP.	0.1uF	16V	B	GRM39B104K16PT	K22124805		
C 3327	CHIP CAP.	0.1uF	16V	B	GRM39B104K16PT	K22124805		
C 3328	CHIP CAP.	0.1uF	16V	B	GRM39B104K16PT	K22124805		
C 3329	CHIP CAP.	0.1uF	16V	B	GRM39B104K16PT	K22124805		
C 3331	CHIP CAP.	100pF	50V	CH	GRM39CH101J50PT	K22174235		
C 3334	CHIP CAP.	0.1uF	16V	B	GRM39B104K16PT	K22124805		
C 3335	CHIP CAP.	100pF	50V	CH	GRM39CH101J50PT	K22174235		
C 3336	CHIP CAP.	68pF	50V	CH	GRM39CH680J50PT	K22174231		
C 3337	CHIP CAP.	2pF	50V	CK	GRM39CK020C50PT	K22174203		
C 3338	CHIP CAP.	0.1uF	16V	B	GRM39B104K16PT	K22124805		
C 3339	CHIP CAP.	0.1uF	16V	B	GRM39B104K16PT	K22124805		
C 3342	CHIP CAP.	0.01uF	50V	B	GRM39B103M50PT	K22174823		
C 3343	CHIP CAP.	0.01uF	50V	B	GRM39B103M50PT	K22174823		
C 3350	CHIP CAP.	0.01uF	50V	B	GRM39B103M50PT	K22174823		
C 3351	CHIP CAP.	0.01uF	50V	B	GRM39B103M50PT	K22174823		
C 3352	CHIP CAP.	0.01uF	50V	B	GRM39B103M50PT	K22174823		
C 3355	CHIP CAP.	0.01uF	50V	B	GRM39B103M50PT	K22174823		
C 3356	CHIP CAP.	0.01uF	50V	B	GRM39B103M50PT	K22174823		
C 3357	AL.ELECTRO.CAP.	22uF	16V		ECEV1CA220SR	K48120002		
C 3358	CHIP CAP.	0.1uF	16V	B	GRM39B104K16PT	K22124805		
C 3362	CHIP CAP.	0.1uF	16V	B	GRM39B104K16PT	K22124805		
C 3363	CHIP CAP.	2pF	50V	CK	GRM39CK020C50PT	K22174203		
C 3364	CHIP CAP.	0.01uF	50V	B	GRM39B103M50PT	K22174823		
C 3365	CHIP CAP.	0.01uF	50V	B	GRM39B103M50PT	K22174823		
C 3366	CHIP CAP.	100pF	50V	CH	GRM39CH101J50PT	K22174235		
C 3367	CHIP CAP.	0.01uF	50V	B	GRM39B103M50PT	K22174823		
C 3368	CHIP CAP.	0.01uF	50V	B	GRM39B103M50PT	K22174823		
C 3369	CHIP CAP.	0.001uF	50V	B	GRM39B102M50PT	K22174809		
C 3370	CHIP CAP.	0.01uF	50V	B	GRM39B103M50PT	K22174823		
C 3371	CHIP CAP.	0.01uF	50V	B	GRM39B103M50PT	K22174823		
C 3373	AL.ELECTRO.CAP.	22uF	16V		ECEV1CA220SR	K48120002		
C 3374	CHIP CAP.	0.01uF	50V	B	GRM39B103M50PT	K22174823		
C 3375	CHIP CAP.	5pF	50V	CH	GRM39CH050C50PT	K22174206		
C 3378	CHIP CAP.	100pF	50V	CH	GRM39CH101J50PT	K22174235		
C 3379	CHIP CAP.	0.01uF	50V	B	GRM39B103M50PT	K22174823		
C 3381	CHIP CAP.	2pF	50V	CK	GRM39CK020C50PT	K22174203		
C 3384	CHIP CAP.	0.01uF	50V	B	GRM39B103M50PT	K22174823		
C 3385	CHIP CAP.	12pF	50V	CH	GRM39CH120J50PT	K22174213		
C 3386	CHIP CAP.	0.001uF	50V	B	GRM39B102M50PT	K22174809		
C 3387	CHIP CAP.	0.01uF	50V	B	GRM39B103M50PT	K22174823		
C 3388	CHIP CAP.	0.001uF	50V	B	GRM39B102M50PT	K22174809		
C 3389	CHIP CAP.	15pF	50V	CH	GRM39CH150J50PT	K22174215		
C 3391	CHIP CAP.	27pF	50V	CH	GRM39CH270J50PT	K22174221		
C 3392	CHIP CAP.	0.01uF	50V	B	GRM39B103M50PT	K22174823		
C 3396	CHIP CAP.	0.01uF	50V	B	GRM39B103M50PT	K22174823		
C 3398	CHIP CAP.	0.01uF	50V	B	GRM39B103M50PT	K22174823		
C 3400	CHIP CAP.	3pF	50V	CJ	GRM39CJ030C50PT	K22174204		

REF.	DESCRIPTION	VALUE	V/W	TOL.	MFR'S DESIG	YAESU P/N	VERS.	LOT.
C 3401	CHIP CAP.	0.01uF	50V	B	GRM39B103M50PT	K22174823		
C 3402	AL.ELECTRO.CAP.	22uF	16V		ECEV1CA220SR	K48120002		
C 3403	CHIP CAP.	0.01uF	50V	B	GRM39B103M50PT	K22174823		
C 3404	CHIP CAP.	0.01uF	50V	B	GRM39B103M50PT	K22174823		
C 3405	CHIP CAP.	0.1uF	16V	B	GRM39B104K16PT	K22124805		
C 3406	CHIP CAP.	0.01uF	50V	B	GRM39B103M50PT	K22174823		
C 3407	CHIP CAP.	0.1uF	16V	B	GRM39B104K16PT	K22124805		
C 3408	CHIP CAP.	0.01uF	50V	B	GRM39B103M50PT	K22174823		
C 3410	CHIP CAP.	0.01uF	50V	B	GRM39B103M50PT	K22174823		
C 3411	AL.ELECTRO.CAP.	22uF	16V		ECEV1CA220SR	K48120002		
C 3412	CHIP CAP.	0.01uF	50V	B	GRM39B103M50PT	K22174823		
C 3413	CHIP CAP.	0.01uF	50V	B	GRM39B103M50PT	K22174823		
C 3414	CHIP CAP.	0.01uF	50V	B	GRM39B103M50PT	K22174823		
C 3419	CHIP CAP.	0.01uF	50V	B	GRM39B103M50PT	K22174823		
C 3420	CHIP CAP.	0.01uF	50V	B	GRM39B103M50PT	K22174823		
C 3426	CHIP CAP.	0.01uF	50V	B	GRM39B103M50PT	K22174823		
C 3427	CHIP CAP.	0.01uF	50V	B	GRM39B103M50PT	K22174823		
C 3430	CHIP CAP.	0.001uF	50V	B	GRM39B102M50PT	K22174809		
C 3447	CHIP CAP.	0.001uF	50V	B	GRM39B102M50PT	K22174809		
C 3452	CHIP CAP.	10pF	50V	CH	GRM40CH100D50PT	K22170211		
C 3452	CERAMIC CAP.	10pF	50V	CH	DD104CH100D50	K02173100		2-
C 3453	TANTALUM CAP.	1uF	35V		DN1V010M1S	K70167105		
C 3456	CHIP CAP.	1pF	50V	CK	GRM39CK010C50PT	K22174202		
C 3458	CHIP CAP.	0.01uF	50V	B	GRM39B103M50PT	K22174823		
C 3459	CHIP CAP.	0.1uF	16V	B	GRM39B104K16PT	K22124805		
CV3001	HELICAL RESONATOR	440MHz			7HT 1448AM 440M	L4020123		
CV3002	HELICAL RESONATOR	475MHz			475M 222859	L4020154		
CV3003	HELICAL RESONATOR	440MHz			7HT 1448AM 440M	L4020123		
CV3004	HELICAL RESONATOR	475MHz			475M 222859	L4020154		
CV3005	HELICAL RESONATOR	440MHz			7HT 1448AM 440M	L4020123		
D 3001	DIODE				DAN235U TL	G2070176		
D 3002	DIODE				1SS318 TT11	G2070322		
D 3003	DIODE				1SS318 TT11	G2070322		
D 3004	DIODE				DAN235U TL	G2070176		
D 3005	DIODE				DAN235U TL	G2070176		
D 3006	DIODE				DAN235U TL	G2070176		
D 3007	DIODE				DAN235U TL	G2070176		
D 3008	DIODE				DAN202U T106	G2070162		
D 3009	DIODE				DAN202U T106	G2070162		
D 3010	DIODE				DAN235U TL	G2070176		
D 3011	DIODE				RD3.6MB1-T1B	G2070392		
D 3012	DIODE				1SS318 TT11	G2070322		
D 3013	DIODE				1SS318 TT11	G2070322		
D 3014	DIODE				1SS318 TT11	G2070322		
D 3015	DIODE				1SS318 TT11	G2070322		
D 3016	DIODE				HSB88WSTR	G2070290		
D 3017	DIODE				1T362-01-T8A	G2070102		
D 3018	DIODE				1SS318 TT11	G2070322		
D 3019	DIODE				1T363-01-T8A	G2070114		
D 3020	DIODE				1T362-01-T8A	G2070102		
D 3021	DIODE				DAN235U TL	G2070176		
D 3022	DIODE				1SV217(TPH3)	G2070568		
D 3023	DIODE				DAN235U TL	G2070176		
D 3024	DIODE				1T363-01-T8A	G2070114		
D 3025	DIODE				1T362-01-T8A	G2070102		
D 3026	DIODE				1T363-01-T8A	G2070114		



# RF Unit

REF.	DESCRIPTION	VALUE	V/W	TOL.	MFR'S DESIG	YAESU P/N	VERS.	LOT.
D 3027	DIODE				HVU362TRF	G2070490		
D 3028	DIODE				HVU362TRF	G2070490		
D 3029	DIODE				1SV217(TPH3)	G2070568		
D 3030	DIODE				1SS318 TT11	G2070322		
D 3031	DIODE				1SS318 TT11	G2070322		
D 3032	DIODE				HVU362TRF	G2070490		
D 3033	DIODE				HVU362TRF	G2070490		
D 3034	DIODE				1T363-01-T8A	G2070114		
D 3035	DIODE				1SS318 TT11	G2070322		
D 3036	DIODE				1SS318 TT11	G2070322		
D 3037	DIODE				1SV217(TPH3)	G2070568		
D 3038	DIODE				1T363-01-T8A	G2070114		
D 3039	DIODE				DAN235U TL	G2070176		
D 3040	DIODE				1SV217(TPH3)	G2070568		
D 3041	DIODE				HVU362TRF	G2070490		
D 3042	DIODE				HVU362TRF	G2070490		
D 3043	DIODE				DAN202U T106	G2070162		
D 3044	DIODE				HVU362TRF	G2070490		
D 3045	DIODE				HVU362TRF	G2070490		
D 3046	DIODE				1SS318 TT11	G2070322		
D 3047	DIODE				IMN10 T108	G2070078		
D 3048	DIODE				DAN235U TL	G2070176		
D 3049	DIODE				IMN10 T108	G2070078		
D 3050	DIODE				1SS83TD	G2060022		
D 3051	DIODE				1SS83TD	G2060022		
D 3052	DIODE				1SS83TD	G2060022		
D 3053	DIODE				1SS83TD	G2060022		
D 3054	DIODE				1SS83TD	G2060022		
D 3055	DIODE				1SS83TD	G2060022		
D 3056	DIODE				1SS83TD	G2060022		
D 3057	DIODE				1SS83TD	G2060022		
D 3058	DIODE				1SS83TD	G2060022		
D 3059	DIODE				1SS83TD	G2060022		
D 3060	DIODE				DAN235U TL	G2070176		
D 3061	DIODE				1SV217(TPH3)	G2070568		
D 3062	DIODE				1T363-01-T8A	G2070114		
D 3063	DIODE				DAN235U TL	G2070176		
D 3064	DIODE				1SS83TD	G2060022		
D 3065	DIODE				1SS83TD	G2060022		
D 3066	DIODE				1SS83TD	G2060022		
D 3067	DIODE				1SS83TD	G2060022		
D 3068	DIODE				1SS83TD	G2060022		
D 3069	DIODE				1SS83TD	G2060022		
D 3070	DIODE				1SS83TD	G2060022		
D 3071	DIODE				1SS83TD	G2060022		
D 3072	DIODE				1SV217(TPH3)	G2070568		
D 3073	DIODE				1SS83TD	G2060022		
D 3074	IC				GN2011-Q(TX)	G1092183		
D 3084	DIODE				1SV217(TPH3)	G2070568		
D 3085	DIODE				RD3.6MB1-T1B	G2070392		
D 3086	DIODE				1T363-01-T8A	G2070114		
D 3087	DIODE				1SV217(TPH3)	G2070568		
D 3088	DIODE				DAN202U T106	G2070162		
D 3089	DIODE				DAN202U T106	G2070162		
D 3090	DIODE				1SS83TD	G2060022		
D 3091	DIODE				DAN202U T106	G2070162		

REF.	DESCRIPTION	VALUE	V/W	TOL.	MFR'S DESIG	YAESU P/N	VERS.	LOT.
D 3092	DIODE				IMN10 T108	G2070078		
D 3093	DIODE				IMN10 T108	G2070078		
D 3094	DIODE				IMN10 T108	G2070078		
J 3001	CONNECTOR				TMP-J01X-A2	P1090255		
J 3002	CONNECTOR				TMP-J01X-A2	P1090255		
J 3003	CONNECTOR				TMP-J01X-A2	P1090255		
J 3004	CONNECTOR				TMP-J01X-A2	P1090255		
J 3005	CONNECTOR				TMP-J01X-A2	P1090255		
J 3006	CONNECTOR				TMP-J01X-A2	P1090255		
J 3007	CONNECTOR				TMP-J01X-A2	P1090255		
J 3008	CONNECTOR				TMP-J01X-A2	P1090255		
J 3009	CONNECTOR				TMP-J01X-A2	P1090255		
J 3010	CONNECTOR				TMP-J01X-A2	P1090255		
J 3011	CONNECTOR				SC25-10WS	P0090629		
J 3012	CONNECTOR				SC25-02WS	P0090621		
J 3013	CONNECTOR				SC25-13WS	P0090632		
J 3014	CONNECTOR				SC25-08WS	P0090627		
J 3015	CONNECTOR				SC25-09WS	P0090628		
J 3016	CONNECTOR				SC25-04WS	P0090623		
J 3017	CONNECTOR				SC25-06WS	P0090625		
J 3018	CONNECTOR				SC25-02WS	P0090621		
L 3001	M.RFC	0.047uH			ELJ-NC47NJF	L1690643		
L 3002	M.RFC	33uH			LAP02TA330K	L1790064		
L 3003	M.RFC	10uH			LAP02TA100K	L1790058		
L 3004	M.RFC	0.082uH			ELJ-NC82NJF	L1690646		
L 3005	M.RFC	0.047uH			ELJ-NC47NJF	L1690643		
L 3006	COIL A1				6.5T3.5D0.6UEW R	L0021821A		
L 3007	M.RFC	0.15uH			ELJ-NCR15JF	L1690649		
L 3008	M.RFC	0.33uH			LAP02TAR33K	L1790040		
L 3009	M.RFC	0.056uH			ELJ-NC56NJF	L1690644		
L 3010	M.RFC	0.022uH			ELJ-NC22NKF	L1690639		
L 3011	M.RFC	0.056uH			ELJ-NC56NJF	L1690644		
L 3012	M.RFC	0.056uH			ELJ-NC56NJF	L1690644		
L 3013	M.RFC	3.3uH			LAP02TA3R3K	L1790052		
L 3014	M.RFC	0.056uH			ELJ-NC56NJF	L1690644		
L 3015	M.RFC	0.33uH			LAP02TAR33K	L1790040		
L 3016	M.RFC	3.3uH			LAP02TA3R3K	L1790052		
L 3017	M.RFC	0.33uH			LAP02TAR33K	L1790040		
L 3018	M.RFC	0.1uH			ELJ-NCR10JF	L1690647		
L 3019	M.RFC	10uH			LAP02TA100K	L1790058		
L 3020	M.RFC	10uH			LAP02TA100K	L1790058		
L 3021	M.RFC	0.082uH			ELJ-NC82NJF	L1690646		
L 3022	COIL A1				1.5T2.0D0.4UEW R	L0022515		
L 3023	M.RFC	4.7uH			LAP02TA4R7K	L1790054		
L 3024	M.RFC	0.27uH			LAP02TAR27K	L1790039		
L 3025	M.RFC	4.7uH			LAP02TA4R7K	L1790054		
L 3026	M.RFC	0.033uH			ELJ-NC33NJF	L1690641		
L 3027	M.RFC	0.1uH			ELJ-NCR10JF	L1690647		
L 3028	COIL A1				1.5T2.0D0.4UEW R	L0022515		
L 3029	M.RFC	0.27uH			LAP02TAR27K	L1790039		
L 3030	M.RFC	0.18uH			ELJ-NCR18JF	L1690650		
L 3031	M.RFC	0.22uH			LAP02TAR22K	L1790038		
L 3032	M.RFC	0.082uH			ELJ-NC82NJF	L1690646		
L 3033	COIL A1				1.5T2.0D0.4UEW R	L0022515		
L 3034	M.RFC	0.039uH			ELJ-NC39NJF	L1690642		
L 3035	M.RFC	0.039uH			ELJ-NC39NJF	L1690642		

# RF Unit

REF.	DESCRIPTION	VALUE	V/W	TOL.	MFR'S DESIG	YAESU P/N	VERS.	LOT.
L 3036	M.RFC	0.22uH			ELJ-NCR22JF	L1690651		
L 3037	M.RFC	0.12uH			ELJ-NCR12JF	L1690648		
L 3038	M.RFC	0.022uH			ELJ-NC22NKF	L1690639		
L 3039	M.RFC	0.022uH			ELJ-NC22NKF	L1690639		
L 3040	M.RFC	0.12uH			ELJ-NCR12JF	L1690648		
L 3041	M.RFC	0.22uH			ELJ-NCR22JF	L1690651		
L 3042	M.RFC	0.033uH			ELJ-NC33NJF	L1690641		
L 3043	M.RFC	0.033uH			ELJ-NC33NJF	L1690641		
L 3044	M.RFC	33uH			LAP02TA330K	L1790064		
L 3045	M.RFC	0.033uH			ELJ-NC33NJF	L1690641		
L 3046	M.RFC	15uH			LAP02TA150K	L1790060		
L 3047	M.RFC	2.2uH			LAP02TA2R2K	L1790050		
L 3048	M.RFC	1.8uH			LAP02TA1R8K	L1790049		
L 3048	M.RFC	2.7uH			LAP02TA2R7K	L1790051		2-
L 3049	M.RFC	1.2uH			LAP02TA1R2K	L1790047		
L 3049	M.RFC	0.82uH			LAP02TAR82K	L1790045		2-
L 3050	M.RFC	0.47uH			LAP02TAR47K	L1790042		
L 3051	M.RFC	0.39uH			LAP02TAR39K	L1790041		
L 3052	M.RFC	0.27uH			LAP02TAR27K	L1790039		
L 3053	M.RFC	0.22uH			LAP02TAR22K	L1790038		
L 3054	M.RFC	0.082uH			ELJ-NC82NJF	L1690646		
L 3055	M.RFC	33uH			LAP02TA330K	L1790064		
L 3056	M.RFC	6.8uH			LAP02TA6R8K	L1790056		
L 3057	M.RFC	10uH			LAP02TA100K	L1790058		
L 3058	M.RFC	5.6uH			LAP02TA5R6K	L1790055		
L 3058	M.RFC	3.3uH			LAP02TA3R3K	L1790052		2-
L 3059	M.RFC	2.2uH			LAP02TA2R2K	L1790050		
L 3059	M.RFC	3.3uH			LAP02TA3R3K	L1790052		2-
L 3060	M.RFC	2.2uH			LAP02TA2R2K	L1790050		
L 3061	M.RFC	1.8uH			LAP02TA1R8K	L1790049		
L 3062	M.RFC	1uH			LAP02TA1R0K	L1790046		
L 3063	M.RFC	1uH			LAP02TA1R0K	L1790046		
L 3064	M.RFC	0.27uH			LAP02TAR27K	L1790039		
L 3065	M.RFC	6.8uH			LAP02TA6R8K	L1790056		
L 3066	M.RFC	1.2uH			LAP02TA1R2K	L1790047		
L 3067	M.RFC	1uH			LAP02TA1R0K	L1790046		
L 3067	M.RFC	1.5uH			LAP02TA1R5K	L1790048		2-
L 3068	M.RFC	0.68uH			LAP02TAR68K	L1790044		
L 3068	M.RFC	0.47uH			LAP02TAR47K	L1790042		2-
L 3069	M.RFC	0.27uH			LAP02TAR27K	L1790039		
L 3070	M.RFC	0.22uH			LAP02TAR22K	L1790038		
L 3071	M.RFC	0.15uH			ELJ-NCR15JF	L1690649		
L 3072	M.RFC	0.082uH			ELJ-NC82NJF	L1690646		
L 3073	M.RFC	0.033uH			ELJ-NC33NJF	L1690641		
L 3074	M.RFC	10uH			LAP02TA100K	L1790058		
L 3075	M.RFC	6.8uH			LAP02TA6R8K	L1790056		
L 3076	M.RFC	10uH			LAP02TA100K	L1790058		
L 3077	M.RFC	5.6uH			LAP02TA5R6K	L1790055		
L 3077	M.RFC	3.3uH			LAP02TA3R3K	L1790052		2-
L 3078	M.RFC	2.2uH			LAP02TA2R2K	L1790050		
L 3078	M.RFC	3.3uH			LAP02TA3R3K	L1790052		2-
L 3079	M.RFC	2.2uH			LAP02TA2R2K	L1790050		
L 3080	M.RFC	1.8uH			LAP02TA1R8K	L1790049		
L 3081	M.RFC	1uH			LAP02TA1R0K	L1790046		
L 3082	M.RFC	0.82uH			LAP02TAR82K	L1790045		
L 3083	M.RFC	0.27uH			LAP02TAR27K	L1790039		

REF.	DESCRIPTION	VALUE	V/W	TOL.	MFR'S DESIG	YAESU P/N	VERS.	LOT.
L 3084	M.RFC	33uH			LAP02TA330K	L1790064		
L 3085	M.RFC	15uH			LAP02TA150K	L1790060		
L 3086	M.RFC	2.2uH			LAP02TA2R2K	L1790050		
L 3087	M.RFC	1.8uH			LAP02TA1R8K	L1790049		
L 3087	M.RFC	2.7uH			LAP02TA2R7K	L1790051		2-
L 3088	M.RFC	1.2uH			LAP02TA1R2K	L1790047		
L 3088	M.RFC	0.82uH			LAP02TAR82K	L1790045		2-
L 3089	M.RFC	0.47uH			LAP02TAR47K	L1790042		
L 3090	M.RFC	0.39uH			LAP02TAR39K	L1790041		
L 3091	M.RFC	0.27uH			LAP02TAR27K	L1790039		
L 3092	M.RFC	0.22uH			LAP02TAR22K	L1790038		
L 3093	M.RFC	0.082uH			ELJ-NC82NJF	L1690646		
L 3094	M.RFC	0.12uH			ELJ-NCR12JF	L1690648		
L 3095	M.RFC	3.3uH			LAP02TA3R3K	L1790052		
L 3096	M.RFC	10uH			LAP02TA100K	L1790058		
L 3097	M.RFC	10uH			LAP02TA100K	L1790058		
L 3098	M.RFC	0.33uH			LAP02TAR33K	L1790040		
L 3100	M.RFC	10uH			LAP02TA100K	L1790058		
L 3101	M.RFC	1uH			LAP02TA1R0K	L1790046		
L 3102	M.RFC	220uH			LAL03NA221K	L1190222		
Q 3001	TRANSISTOR				IMD3 T108	G3070053		
Q 3002	IC				UPC1677C	G1092096		
Q 3003	TRANSISTOR				2SC3356-T2B	G3333567		
Q 3004	FET				2SK2685ZT-TR	G3826857		
Q 3005	TRANSISTOR				IMD3 T108	G3070053		
Q 3006	TRANSISTOR				IMD3 T108	G3070053		
Q 3007	IC				UPC1677C	G1092096		
Q 3008	TRANSISTOR				2SC3356-T2B	G3333567		
Q 3009	TRANSISTOR				IMD3 T108	G3070053		
Q 3010	TRANSISTOR				IMD3 T108	G3070053		
Q 3011	IC				UPC1677C	G1092096		
Q 3012	FET				SGM2016AM-T7	G4070012		
Q 3013	FET				SGM2016AM-T7	G4070012		
Q 3014	TRANSISTOR				FMG1 T148	G3070107		
Q 3015	FET				3SK131-T2B V12	G4801317B		
Q 3016	FET				3SK131-T2B V12	G4801317B		
Q 3017	TRANSISTOR				FMG1 T148	G3070107		
Q 3018	IC				BU4094BCF-E2	G1092684		
Q 3019	TRANSISTOR				FMG1 T148	G3070107		
Q 3020	TRANSISTOR				IMD3 T108	G3070053		
Q 3021	TRANSISTOR				IMD3 T108	G3070053		
Q 3022	TRANSISTOR				FMG1 T148	G3070107		
Q 3023	TRANSISTOR				XN4111-(TX)	G3070210		
Q 3024	TRANSISTOR				IMD3 T108	G3070053		
Q 3025	TRANSISTOR				IMD3 T108	G3070053		
Q 3026	TRANSISTOR				2SC3356-T2B	G3333567		
Q 3027	TRANSISTOR				IMD3 T108	G3070053		
Q 3028	TRANSISTOR				FMG1 T148	G3070107		
Q 3029	TRANSISTOR				FMG1 T148	G3070107		
Q 3030	TRANSISTOR				FMG1 T148	G3070107		
Q 3031	TRANSISTOR				FMG1 T148	G3070107		
Q 3032	TRANSISTOR				FMG1 T148	G3070107		
Q 3033	TRANSISTOR				2SC3356-T2B	G3333567		
Q 3034	TRANSISTOR				2SC2812L6-TA	G3328127F		
Q 3035	IC				BU4094BCF-E2	G1092684		
Q 3036	IC				MC14028BFL	G1090998		

# RF Unit

REF.	DESCRIPTION	VALUE	V/W	TOL.	MFR'S DESIG	YAESU P/N	VERS.	LOT.
Q 3037	TRANSISTOR				2SC3356-T2B	G3333567		
Q 3038	TRANSISTOR				FMG1 T148	G3070107		
Q 3039	IC				TC4S66F TE85R	G1090893		
Q 3040	TRANSISTOR				2SC3356-T2B	G3333567		
Q 3041	TRANSISTOR				2SB1301-T2 ZQ	G3213017Q		
Q 3042	TRANSISTOR				DTC124EK T146	G3070034		
Q 3043	TRANSISTOR				FMW8 T148	G3070155		
Q 3048	IC				BU4066BF-E2	G1092593		
R 3001	CHIP RES.	330ohm	1/16W	5%	RMC1/16 331JATP	J24185331		
R 3004	CHIP RES.	1kohm	1/16W	5%	RMC1/16 102JATP	J24185102		
R 3005	CHIP RES.	1kohm	1/16W	5%	RMC1/16 102JATP	J24185102		
R 3006	CHIP RES.	27ohm	1/16W	5%	RMC1/16 270JATP	J24185270		
R 3007	CHIP RES.	1kohm	1/16W	5%	RMC1/16 102JATP	J24185102		
R 3008	CHIP RES.	33ohm	1/16W	5%	RMC1/16 330JATP	J24185330		
R 3009	CHIP RES.	27ohm	1/16W	5%	RMC1/16 270JATP	J24185270		
R 3010	CHIP RES.	27ohm	1/16W	5%	RMC1/16 270JATP	J24185270		
R 3011	CHIP RES.	1kohm	1/16W	5%	RMC1/16 102JATP	J24185102		
R 3012	CHIP RES.	27ohm	1/16W	5%	RMC1/16 270JATP	J24185270		
R 3013	CHIP RES.	33ohm	1/16W	5%	RMC1/16 330JATP	J24185330		
R 3014	CHIP RES.	27ohm	1/16W	5%	RMC1/16 270JATP	J24185270		
R 3015	CHIP RES.	1kohm	1/16W	5%	RMC1/16 102JATP	J24185102		
R 3016	CHIP RES.	5.6kohm	1/16W	5%	RMC1/16 562JATP	J24185562		
R 3017	CHIP RES.	1.8kohm	1/16W	5%	RMC1/16 182JATP	J24185182		
R 3018	CHIP RES.	33ohm	1/16W	5%	RMC1/16 330JATP	J24185330		
R 3019	CHIP RES.	1kohm	1/16W	5%	RMC1/16 102JATP	J24185102		
R 3020	CHIP RES.	27ohm	1/16W	5%	RMC1/16 270JATP	J24185270		
R 3021	CHIP RES.	22ohm	1/16W	5%	RMC1/16 220JATP	J24185220		
R 3022	CHIP RES.	33ohm	1/16W	5%	RMC1/16 330JATP	J24185330		
R 3023	CHIP RES.	68ohm	1/16W	5%	RMC1/16 680JATP	J24185680		
R 3025	CHIP RES.	82ohm	1/16W	5%	RMC1/16 820JATP	J24185820		
R 3026	CHIP RES.	100ohm	1/16W	5%	RMC1/16 101JATP	J24185101		
R 3027	CHIP RES.	330ohm	1/16W	5%	RMC1/16 331JATP	J24185331		
R 3029	CHIP RES.	330ohm	1/16W	5%	RMC1/16 331JATP	J24185331		
R 3030	CHIP RES.	1kohm	1/16W	5%	RMC1/16 102JATP	J24185102		
R 3031	CHIP RES.	100ohm	1/16W	5%	RMC1/16 101JATP	J24185101		
R 3032	CHIP RES.	47ohm	1/16W	5%	RMC1/16 470JATP	J24185470		
R 3033	CHIP RES.	1kohm	1/16W	5%	RMC1/16 102JATP	J24185102		
R 3034	CHIP RES.	1kohm	1/16W	5%	RMC1/16 102JATP	J24185102		
R 3035	CHIP RES.	1kohm	1/16W	5%	RMC1/16 102JATP	J24185102		
R 3036	CHIP RES.	1kohm	1/16W	5%	RMC1/16 102JATP	J24185102		
R 3037	CHIP RES.	100kohm	1/16W	5%	RMC1/16 104JATP	J24185104		
R 3038	CHIP RES.	100kohm	1/16W	5%	RMC1/16 104JATP	J24185104		
R 3039	CHIP RES.	1kohm	1/16W	5%	RMC1/16 102JATP	J24185102		
R 3040	CHIP RES.	1kohm	1/16W	5%	RMC1/16 102JATP	J24185102		
R 3041	CHIP RES.	1kohm	1/16W	5%	RMC1/16 102JATP	J24185102		
R 3042	CHIP RES.	1kohm	1/16W	5%	RMC1/16 102JATP	J24185102		
R 3043	CHIP RES.	1kohm	1/16W	5%	RMC1/16 102JATP	J24185102		
R 3044	CHIP RES.	100ohm	1/16W	5%	RMC1/16 101JATP	J24185101		
R 3045	CHIP RES.	100kohm	1/16W	5%	RMC1/16 104JATP	J24185104		
R 3046	CHIP RES.	1kohm	1/16W	5%	RMC1/16 102JATP	J24185102		
R 3047	CHIP RES.	1kohm	1/16W	5%	RMC1/16 102JATP	J24185102		
R 3048	CHIP RES.	1kohm	1/16W	5%	RMC1/16 102JATP	J24185102		
R 3049	CHIP RES.	100kohm	1/16W	5%	RMC1/16 104JATP	J24185104		
R 3050	CHIP RES.	100kohm	1/16W	5%	RMC1/16 104JATP	J24185104		
R 3051	CHIP RES.	1kohm	1/16W	5%	RMC1/16 102JATP	J24185102		
R 3052	CHIP RES.	1kohm	1/16W	5%	RMC1/16 102JATP	J24185102		

REF.	DESCRIPTION	VALUE	V/W	TOL.	MFR'S DESIG	YAESU P/N	VERS.	LOT.
R 3053	CHIP RES.	100kohm	1/16W	5%	RMC1/16 104JATP	J24185104		
R 3054	CHIP RES.	100kohm	1/16W	5%	RMC1/16 104JATP	J24185104		
R 3055	CHIP RES.	1kohm	1/16W	5%	RMC1/16 102JATP	J24185102		
R 3056	CHIP RES.	100kohm	1/16W	5%	RMC1/16 104JATP	J24185104		
R 3057	CHIP RES.	100kohm	1/16W	5%	RMC1/16 104JATP	J24185104		
R 3058	CHIP RES.	100kohm	1/16W	5%	RMC1/16 104JATP	J24185104		
R 3059	CHIP RES.	100kohm	1/16W	5%	RMC1/16 104JATP	J24185104		
R 3060	CHIP RES.	100kohm	1/16W	5%	RMC1/16 104JATP	J24185104		
R 3061	CHIP RES.	100kohm	1/16W	5%	RMC1/16 104JATP	J24185104		
R 3062	CHIP RES.	33kohm	1/16W	5%	RMC1/16 333JATP	J24185333		
R 3063	CHIP RES.	33kohm	1/16W	5%	RMC1/16 333JATP	J24185333		
R 3064	CHIP RES.	1kohm	1/16W	5%	RMC1/16 102JATP	J24185102		
R 3065	CHIP RES.	100kohm	1/16W	5%	RMC1/16 104JATP	J24185104		
R 3066	CHIP RES.	100kohm	1/16W	5%	RMC1/16 104JATP	J24185104		
R 3069	CHIP RES.	150kohm	1/16W	5%	RMC1/16 154JATP	J24185154		
R 3070	CHIP RES.	150kohm	1/16W	5%	RMC1/16 154JATP	J24185154		
R 3071	CHIP RES.	22kohm	1/16W	5%	RMC1/16 223JATP	J24185223		
R 3072	CHIP RES.	22kohm	1/16W	5%	RMC1/16 223JATP	J24185223		
R 3073	CHIP RES.	100ohm	1/16W	5%	RMC1/16 101JATP	J24185101		
R 3074	CHIP RES.	100ohm	1/16W	5%	RMC1/16 101JATP	J24185101		
R 3075	CHIP RES.	1kohm	1/16W	5%	RMC1/16 102JATP	J24185102		
R 3076	CHIP RES.	270ohm	1/16W	5%	RMC1/16 271JATP	J24185271		
R 3077	CHIP RES.	100ohm	1/16W	5%	RMC1/16 101JATP	J24185101		
R 3078	CHIP RES.	330ohm	1/16W	5%	RMC1/16 331JATP	J24185331		
R 3079	CHIP RES.	100ohm	1/16W	5%	RMC1/16 101JATP	J24185101		
R 3080	CHIP RES.	47kohm	1/16W	5%	RMC1/16 473JATP	J24185473		
R 3081	CHIP RES.	47kohm	1/16W	5%	RMC1/16 473JATP	J24185473		
R 3082	CHIP RES.	47kohm	1/16W	5%	RMC1/16 473JATP	J24185473		
R 3083	CHIP RES.	47kohm	1/16W	5%	RMC1/16 473JATP	J24185473		
R 3084	CHIP RES.	100ohm	1/16W	5%	RMC1/16 101JATP	J24185101		
R 3085	CHIP RES.	100ohm	1/16W	5%	RMC1/16 101JATP	J24185101		
R 3087	CHIP RES.	100ohm	1/16W	5%	RMC1/16 101JATP	J24185101		
R 3089	CHIP RES.	100ohm	1/16W	5%	RMC1/16 101JATP	J24185101		
R 3090	CHIP RES.	100kohm	1/16W	5%	RMC1/16 104JATP	J24185104		
R 3091	CHIP RES.	100kohm	1/16W	5%	RMC1/16 104JATP	J24185104		
R 3092	CHIP RES.	100kohm	1/16W	5%	RMC1/16 104JATP	J24185104		
R 3093	CHIP RES.	100kohm	1/16W	5%	RMC1/16 104JATP	J24185104		
R 3094	CHIP RES.	100kohm	1/16W	5%	RMC1/16 104JATP	J24185104		
R 3095	CHIP RES.	100kohm	1/16W	5%	RMC1/16 104JATP	J24185104		
R 3096	CHIP RES.	100kohm	1/16W	5%	RMC1/16 104JATP	J24185104		
R 3097	CHIP RES.	1kohm	1/16W	5%	RMC1/16 102JATP	J24185102		
R 3098	CHIP RES.	1kohm	1/16W	5%	RMC1/16 102JATP	J24185102		
R 3099	CHIP RES.	1kohm	1/16W	5%	RMC1/16 102JATP	J24185102		
R 3100	CHIP RES.	1kohm	1/16W	5%	RMC1/16 102JATP	J24185102		
R 3102	CHIP RES.	330ohm	1/16W	5%	RMC1/16 331JATP	J24185331		
R 3103	CHIP RES.	1kohm	1/16W	5%	RMC1/16 102JATP	J24185102		
R 3104	CHIP RES.	100ohm	1/16W	5%	RMC1/16 101JATP	J24185101		
R 3105	CHIP RES.	100ohm	1/16W	5%	RMC1/16 101JATP	J24185101		
R 3106	CHIP RES.	100ohm	1/16W	5%	RMC1/16 101JATP	J24185101		
R 3107	CHIP RES.	100ohm	1/16W	5%	RMC1/16 101JATP	J24185101		
R 3108	CHIP RES.	100ohm	1/16W	5%	RMC1/16 101JATP	J24185101		
R 3109	CHIP RES.	100ohm	1/16W	5%	RMC1/16 101JATP	J24185101		
R 3110	CHIP RES.	100ohm	1/16W	5%	RMC1/16 101JATP	J24185101		
R 3111	CHIP RES.	100ohm	1/16W	5%	RMC1/16 101JATP	J24185101		
R 3112	CHIP RES.	100ohm	1/16W	5%	RMC1/16 101JATP	J24185101		
R 3113	CHIP RES.	68ohm	1/16W	5%	RMC1/16 680JATP	J24185680		

# RF Unit

REF.	DESCRIPTION	VALUE	V/W	TOL.	MFR'S DESIG	YAESU P/N	VERS.	LOT.
R 3114	CHIP RES.	1kohm	1/16W	5%	RMC1/16 102JATP	J24185102		
R 3115	CHIP RES.	100kohm	1/16W	5%	RMC1/16 104JATP	J24185104		
R 3116	CHIP RES.	100kohm	1/16W	5%	RMC1/16 104JATP	J24185104		
R 3117	CHIP RES.	100kohm	1/16W	5%	RMC1/16 104JATP	J24185104		
R 3118	CHIP RES.	560ohm	1/16W	5%	RMC1/16 561JATP	J24185561		
R 3119	CHIP RES.	1kohm	1/16W	5%	RMC1/16 102JATP	J24185102		
R 3120	CHIP RES.	1kohm	1/16W	5%	RMC1/16 102JATP	J24185102		
R 3121	CHIP RES.	100ohm	1/16W	5%	RMC1/16 101JATP	J24185101		
R 3122	CHIP RES.	82ohm	1/16W	5%	RMC1/16 820JATP	J24185820		
R 3123	CHIP RES.	220ohm	1/16W	5%	RMC1/16 221JATP	J24185221		
R 3124	CHIP RES.	330ohm	1/16W	5%	RMC1/16 331JATP	J24185331		
R 3125	CHIP RES.	220ohm	1/16W	5%	RMC1/16 221JATP	J24185221		
R 3126	CHIP RES.	1kohm	1/16W	5%	RMC1/16 102JATP	J24185102		
R 3128	CHIP RES.	100kohm	1/16W	5%	RMC1/16 104JATP	J24185104		
R 3129	CHIP RES.	100kohm	1/16W	5%	RMC1/16 104JATP	J24185104		
R 3130	CHIP RES.	330ohm	1/16W	5%	RMC1/16 331JATP	J24185331		
R 3131	CHIP RES.	100kohm	1/16W	5%	RMC1/16 104JATP	J24185104		
R 3132	CHIP RES.	220ohm	1/16W	5%	RMC1/16 221JATP	J24185221		
R 3133	CHIP RES.	68ohm	1/16W	5%	RMC1/16 680JATP	J24185680		
R 3134	CHIP RES.	47ohm	1/16W	5%	RMC1/16 470JATP	J24185470		
R 3135	CHIP RES.	68ohm	1/16W	5%	RMC1/16 680JATP	J24185680		
R 3136	CHIP RES.	0ohm	1/16W	5%	RMC1/16 000JATP	J24185000		
R 3137	CHIP RES.	5.6kohm	1/16W	5%	RMC1/16 562JATP	J24185562		
R 3138	CHIP RES.	1.8kohm	1/16W	5%	RMC1/16 182JATP	J24185182		
R 3139	CHIP RES.	47ohm	1/16W	5%	RMC1/16 470JATP	J24185470		
R 3140	CHIP RES.	0ohm	1/16W	5%	RMC1/16 000JATP	J24185000		
R 3141	CHIP RES.	1kohm	1/16W	5%	RMC1/16 102JATP	J24185102		
R 3142	CHIP RES.	1kohm	1/16W	5%	RMC1/16 102JATP	J24185102		
R 3144	CHIP RES.	1kohm	1/16W	5%	RMC1/16 102JATP	J24185102		
R 3145	CHIP RES.	220ohm	1/16W	5%	RMC1/16 221JATP	J24185221		
R 3146	CHIP RES.	1kohm	1/16W	5%	RMC1/16 102JATP	J24185102		
R 3147	CHIP RES.	4.7kohm	1/16W	5%	RMC1/16 472JATP	J24185472		
R 3148	CHIP RES.	10kohm	1/16W	5%	RMC1/16 103JATP	J24185103		
R 3149	CHIP RES.	4.7kohm	1/16W	5%	RMC1/16 472JATP	J24185472		
R 3151	CHIP RES.	10kohm	1/16W	5%	RMC1/16 103JATP	J24185103		
R 3152	CHIP RES.	100ohm	1/16W	5%	RMC1/16 101JATP	J24185101		
R 3153	CHIP RES.	0ohm	1/16W	5%	RMC1/16 000JATP	J24185000		
R 3154	CHIP RES.	0ohm	1/16W	5%	RMC1/16 000JATP	J24185000		
R 3155	CHIP RES.	0ohm	1/16W	5%	RMC1/16 000JATP	J24185000		
R 3156	CHIP RES.	0ohm	1/16W	5%	RMC1/16 000JATP	J24185000		
R 3157	CHIP RES.	0ohm	1/16W	5%	RMC1/16 000JATP	J24185000		
R 3158	CHIP RES.	1kohm	1/16W	5%	RMC1/16 102JATP	J24185102		
R 3159	CARBON FILM RES.	68ohm	1/6W	5%	RD16PJ680 68	J01225680		
R 3160	CHIP RES.	1kohm	1/16W	5%	RMC1/16 102JATP	J24185102		
R 3161	CHIP RES.	10kohm	1/16W	5%	RMC1/16 103JATP	J24185103		
R 3162	CHIP RES.	220ohm	1/16W	5%	RMC1/16 221JATP	J24185221		
R 3163	CHIP RES.	10kohm	1/16W	5%	RMC1/16 103JATP	J24185103		
R 3164	CHIP RES.	68ohm	1/16W	5%	RMC1/16 680JATP	J24185680		
R 3189	CHIP RES.	82ohm	1/16W	5%	RMC1/16 820JATP	J24185820		
T 3001	COIL 07WIDE				CP22	L0022008		
T 3002	COIL WIDE-TRANS.				950812004	L0022479		
T 3003	COIL 07RF	52MHz			52M R12-S881X	L0022513		
T 3004	COIL WIDE-TRANS.				950812004	L0022479		
T 3005	COIL 07RF	145MHz			145M R12-L044X	L0022067		
T 3006	COIL 07RF	160MHz			160M R12-K905X	L0022053		
T 3007	COIL 07RF	120MHz			120M R12-S878X	L0022510		

REF.	DESCRIPTION	VALUE	V/W	TOL.	MFR'S DESIG	YAESU P/N	VERS.	LOT.
T 3008	COIL 07RF	145MHz			145M R12-L044X	L0022067		
T 3009	COIL 07RF	52MHz			52M R12-S881X	L0022513		
T 3010	COIL 07RF	145MHz			145M R12-L044X	L0022067		
T 3011	COIL 07RF	120MHz			120M R12-S879X	L0022511		
T 3012	COIL 07RF	160MHz			160M R12-K907X	L0022055		
T 3013	COIL 07RF	52MHz			52M R12-S881X	L0022513		
T 3014	COIL 07RF	160MHz			160M R12-K908X	L0022054		
T 3015	COIL 07RF	120MHz			120M R12-S880X	L0022512		
T 3016	COIL 07RF	52MHz			52M R12-S881X	L0022513		
T 3017	COIL 07RF	160MHz			160M R12-K906X	L0022056		
T 3018	COIL 07RF	120MHz			120M R12-S878X	L0022510		
T 3019	COIL 07RF	52MHz			52M R12-S881X	L0022513		
T 3020	COIL 07WIDE				970812093	L0022480		
T 3021	COIL 07RF	52MHz			52M R12-S881X	L0022513		
T 3022	COIL WIDE-TRANS.				960812088	L0022478		
T 3023	COIL 07WIDE				CP22	L0022008		
T 3024	COIL WIDE-TRANS.				950812004	L0022479		
T 3025	COIL 07RF	52MHz			52M R12-S881X	L0022513		
T 3026	COIL WIDE-TRANS.				960812088	L0022478		
T 3027	COIL 07RF	45.705MHz			45.705M R12-S882X	L0022514		
T 3028	COIL 07RF	52MHz			52M R12-S881X	L0022513		
T 3029	COIL 07RF	45.705MHz			45.705M R12-S882X	L0022514		
T 3030	COIL 07WIDE				CP22	L0022008		
T 3031	COIL 07RF	45.705MHz			45.705M R12-S882X	L0022514		
TC3001	TRIMMER CAP.	10pF			ECR-JA010A12X	K91000179		
TC3003	TRIMMER CAP.	10pF			ECR-JA010A12X	K91000179		
TC3004	TRIMMER CAP.	10pF			ECR-JA010A12X	K91000179		
VR3002	POT.	10kohm			EVN-5ESX50B14	J51811103		
VR3003	POT.	10kohm			EVN-5ESX50B14	J51811103		
VR3004	POT.	10kohm			EVN-5ESX50B14	J51811103		
VR3005	POT.	10kohm			EVN-5ESX50B14	J51811103		
VR3006	POT.	10kohm			EVN-5ESX50B14	J51811103		
VR3007	POT.	10kohm			EVN-5ESX50B14	J51811103		
VR3008	POT.	10kohm			EVN-5ESX50B14	J51811103		
VR3009	POT.	10kohm			EVN-5ESX50B14	J51811103		
XF3001	XTAL FILTER				45U15B1	H1102311		
XF3002	XTAL FILTER				45U15B1	H1102311		
Z 3001	LEAF SPRING (2pcs)					R0140031		



# RF Unit

---

*Notes:*

Circuit Diagram

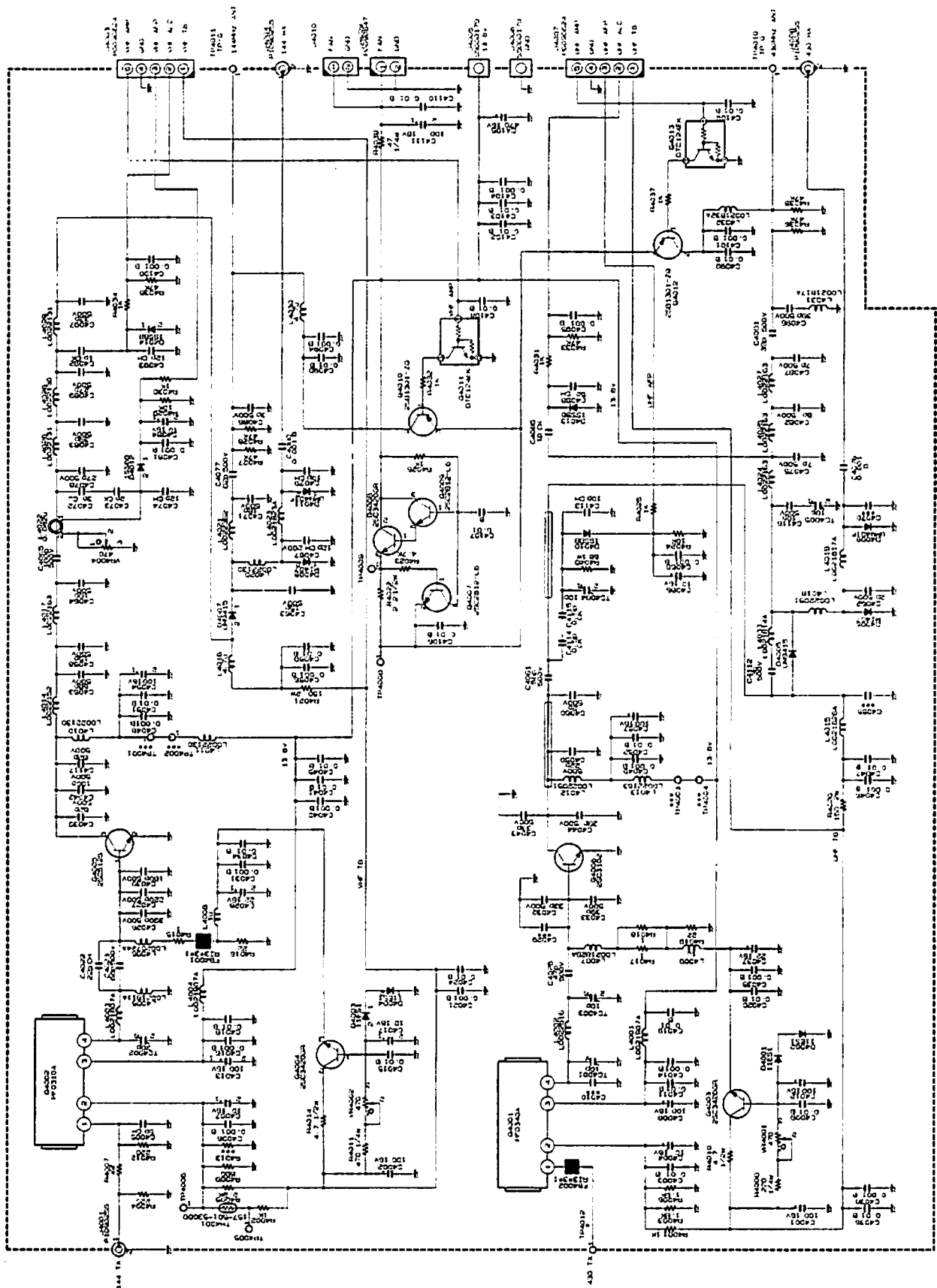

# V/U-PA Unit

---

*Notes:*

Parts Layout

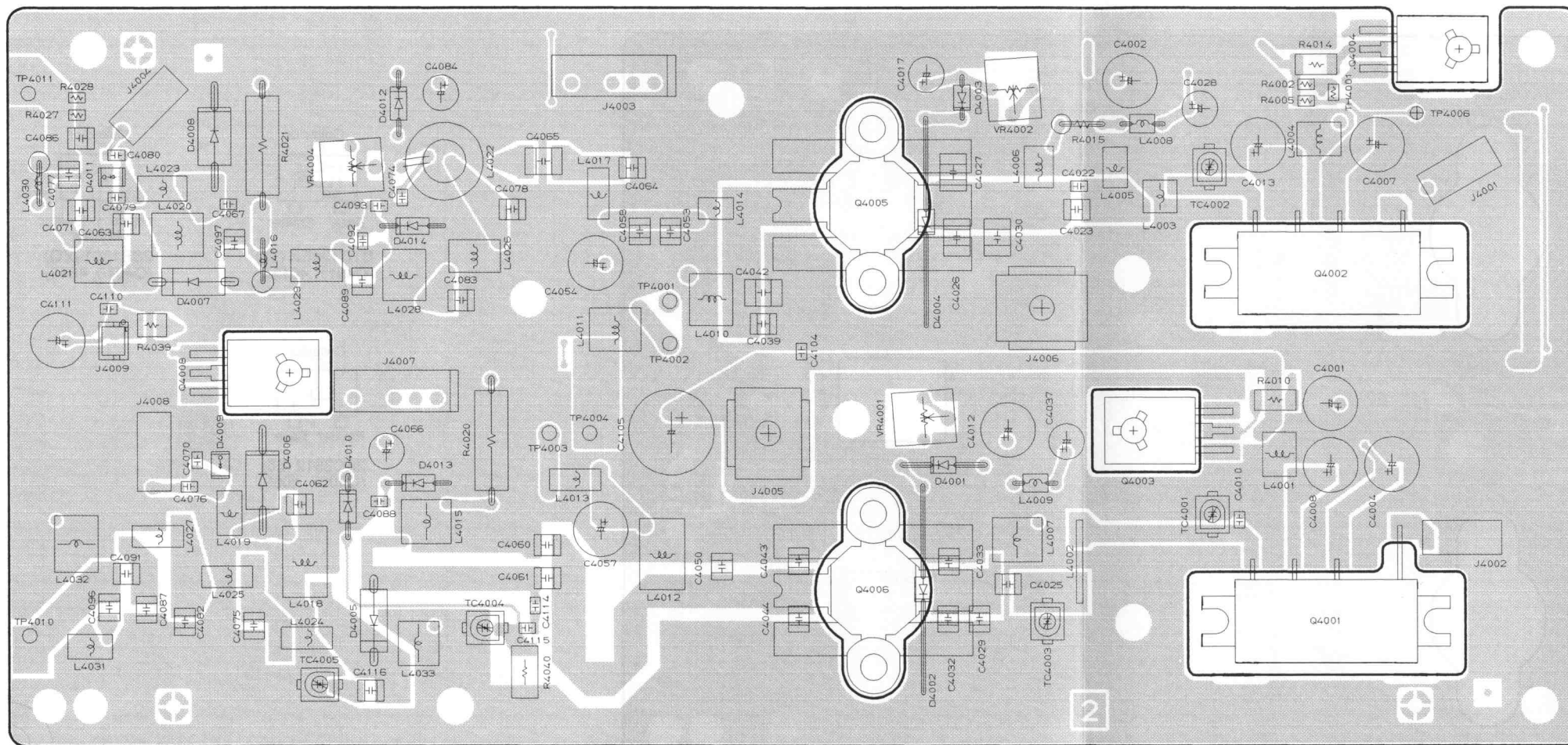

Component Side

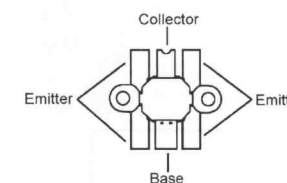

2SC5125  
(Q4005)  
2SC3102  
(Q4006)

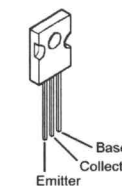

2SC3420GR  
(Q4003, 4004, 4008)

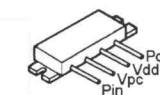

PF0310A  
(Q4002)  
PF0340A  
(Q4001)

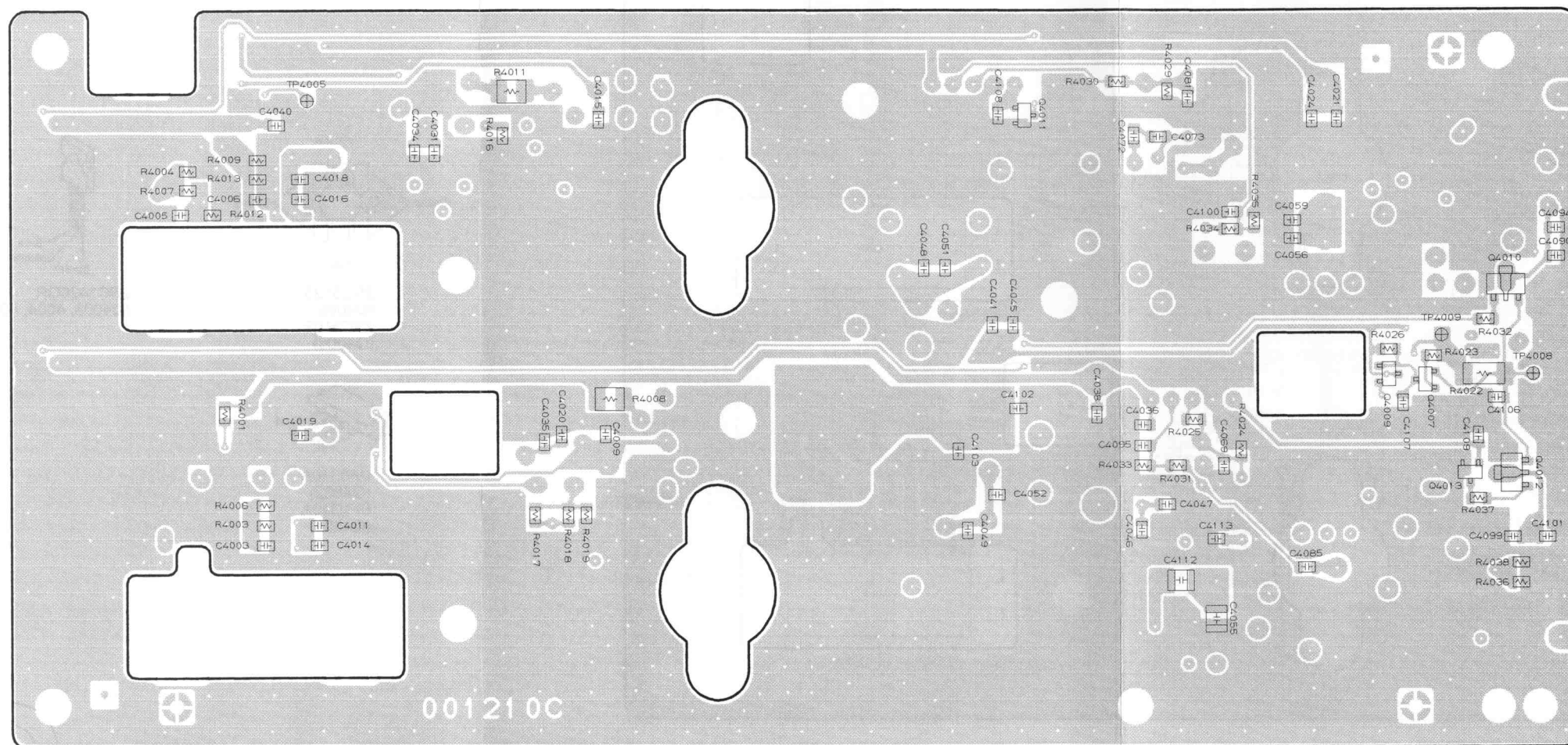

Chip Side

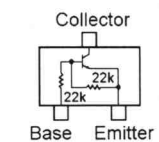

DTC124EK (25)  
(Q4011, 4013)

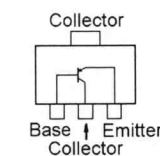

2SB1301 (ZQ)  
(Q4010, 4012)

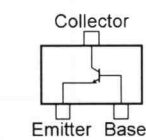

2SC2812 (L6)  
(Q4007, 4009)

## Parts List

REF.	DESCRIPTION	VALUE	V/W	TOL.	MFR'S DESIG	YAESU P/N	VERS.	LOT.
*** V/U-PA UNIT ***								
PCB with Components (w/ C4026,C4027,C4030,C4032,C4033,C4043,C4044,FB4001, Q4001,Q4002,Q4003,Q4004,Q4005,Q4006,Q4008)						CS1575001		
Printed Circuit Board						FR001210C		
C 4001	AL.ELECTRO.CAP.	100uF	16V		16V101M6X7TR2	K46120007		
C 4002	AL.ELECTRO.CAP.	100uF	16V		16V101M6X7TR2	K46120007		
C 4003	CHIP CAP.	0.01uF	50V	B	GRM40B103M50PT	K22170817		
C 4004	AL.ELECTRO.CAP.	10uF	16V		16V100M4X7TR2	K46120004		
C 4005	CHIP CAP.	5pF	50V	CH	GRM40CH050C50PT	K22170206		
C 4006	CHIP CAP.	0.001uF	50V	B	GRM40B102M50PT	K22170805		
C 4007	AL.ELECTRO.CAP.	10uF	16V		16V100M4X7TR2	K46120004		
C 4008	AL.ELECTRO.CAP.	100uF	16V		16V101M6X7TR2	K46120007		
C 4009	CHIP CAP.	0.01uF	50V	B	GRM40B103M50PT	K22170817		
C 4011	CHIP CAP.	0.01uF	50V	B	GRM40B103M50PT	K22170817		
C 4012	AL.ELECTRO.CAP.	100uF	16V		16V101M6X7TR2	K46120007		
C 4013	AL.ELECTRO.CAP.	100uF	16V		16V101M6X7TR2	K46120007		
C 4014	CHIP CAP.	0.001uF	50V	B	GRM40B102M50PT	K22170805		
C 4015	CHIP CAP.	0.01uF	50V	B	GRM40B103M50PT	K22170817		
C 4016	CHIP CAP.	0.001uF	50V	B	GRM40B102M50PT	K22170805		
C 4017	AL.ELECTRO.CAP.	10uF	16V		16V100M4X7TR2	K46120004		
C 4018	CHIP CAP.	0.01uF	50V	B	GRM40B103M50PT	K22170817		
C 4019	CHIP CAP.	0.01uF	50V	B	GRM40B103M50PT	K22170817		
C 4020	CHIP CAP.	0.01uF	50V	B	GRM40B103M50PT	K22170817		
C 4021	CHIP CAP.	0.001uF	50V	B	GRM40B102M50PT	K22170805		
C 4022	CHIP CAP.	22pF	50V	CH	GRM40CH220J50PT	K22170219		
C 4023	FILM CAP.	68pF	500V		UC232H0680J-T	K33279030		
C 4024	CHIP CAP.	0.01uF	50V	B	GRM40B103M50PT	K22170817		
C 4025	FILM CAP.	47pF	500V		UC232H0470J-T	K33279034		
C 4026	FILM CAP.	390pF	500V		UC342H3900J-T	K33279040		
C 4027	FILM CAP.	220pF	500V		UC342H2200J-T	K33279011		
C 4028	AL.ELECTRO.CAP.	22uF	16V		RC2-16V220M-T34(4X7)	K46120008		
C 4030	FILM CAP.	180pF	500V		UC342H1800J-T	K33279039		
C 4031	CHIP CAP.	0.001uF	50V	B	GRM40B102M50PT	K22170805		
C 4032	FILM CAP.	33pF	500V		UC232H0330J-T	K33279024		
C 4033	FILM CAP.	39pF	500V		UC232H0390J-T	K33279038		
C 4034	CHIP CAP.	0.01uF	50V	B	GRM40B103M50PT	K22170817		
C 4035	CHIP CAP.	0.001uF	50V	B	GRM40B102M50PT	K22170805		
C 4036	CHIP CAP.	0.01uF	50V	B	GRM40B103M50PT	K22170817		
C 4037	AL.ELECTRO.CAP.	22uF	16V		RC2-16V220M-T34(4X7)	K46120008		
C 4038	CHIP CAP.	0.001uF	50V	B	GRM40B102M50PT	K22170805		
C 4039	FILM CAP.	82pF	500V		UC232H0820J-T	K33279033		
C 4040	CHIP CAP.	0.001uF	50V	B	GRM40B102M50PT	K22170805		
C 4041	CHIP CAP.	0.01uF	50V	B	GRM40B103M50PT	K22170817		
C 4042	FILM CAP.	100pF	500V		UC342H1000J-T	K33279031		
C 4043	FILM CAP.	33pF	500V		UC232H0330J-T	K33279024		
C 4044	FILM CAP.	39pF	500V		UC232H0390J-T	K33279038		
C 4045	CHIP CAP.	0.01uF	50V	B	GRM40B103M50PT	K22170817		
C 4046	CHIP CAP.	0.001uF	50V	B	GRM40B102M50PT	K22170805		
C 4047	CHIP CAP.	0.01uF	50V	B	GRM40B103M50PT	K22170817		
C 4048	CHIP CAP.	0.001uF	50V	B	GRM40B102M50PT	K22170805		
C 4049	CHIP CAP.	0.001uF	50V	B	GRM40B102M50PT	K22170805		
C 4050	FILM CAP.	22pF	500V		UC232H0220J-T	K33279021		
C 4051	CHIP CAP.	0.01uF	50V	B	GRM40B103M50PT	K22170817		
C 4052	CHIP CAP.	0.01uF	50V	B	GRM40B103M50PT	K22170817		
C 4053	FILM CAP.	68pF	500V		UC232H0680J-T	K33279030		
C 4054	AL.ELECTRO.CAP.	100uF	16V		16V101M6X7TR2	K46120007		
C 4056	CHIP CAP.	0.001uF	50V	B	GRM40B102M50PT	K22170805		
C 4057	AL.ELECTRO.CAP.	100uF	16V		16V101M6X7TR2	K46120007		
C 4058	FILM CAP.	15pF	500V		UC232H0150J-T	K33279028		
C 4059	CHIP CAP.	0.01uF	50V	B	GRM40B103M50PT	K22170817		
C 4060	FILM CAP.	2pF	500V		UC232H0020D-T	K33279043		
C 4061	FILM CAP.	56pF	500V		UC232H0560J-T	K33279035		

# V/U-PA Unit

REF.	DESCRIPTION	VALUE	V/W	TOL.	MFR'S DESIG	YAESU P/N	VERS.	LOT.
C 4062	FILM CAP.	2pF	500V		UC232H0020D-T	K33279043		
C 4063	FILM CAP.	15pF	500V		UC232H0150J-T	K33279028		
C 4064	FILM CAP.	10pF	500V		UC232H0100D-T	K33279019		
C 4065	FILM CAP.	100pF	500V		UC342H1000J-T	K33279031		
C 4066	AL.ELECTRO.CAP.	10uF	16V		16V100M4X7TR2	K46120004		
C 4067	CHIP CAP.	12pF	200V	CH	GRM40CH120J200PT	K22230217		
C 4069	CHIP CAP.	0.001uF	50V	B	GRM40B102M50PT	K22170805		
C 4071	FILM CAP.	18pF	500V		UC232H0180J-T	K33279029		
C 4072	CHIP CAP.	3pF	50V	CJ	GRM40CJ030C50PT	K22170204		
C 4073	CHIP CAP.	2pF	50V	CK	GRM40CK020C50PT	K22170203		
C 4074	CHIP CAP.	12pF	50V	CH	GRM40CH120J50PT	K22170213		
C 4075	FILM CAP.	4pF	500V		UC232H0040D-T	K33279046		
C 4076	CHIP CAP.	0.001uF	50V	B	GRM40B102M50PT	K22170805		
C 4077	FILM CAP.	82pF	500V		UC232H0820J-T	K33279033		
C 4078	FILM CAP.	27pF	500V		UC232H0270J-T	K33279023		
C 4079	CHIP CAP.	10pF	50V	CH	GRM40CH100D50PT	K22170211		
C 4080	CHIP CAP.	0.001uF	50V	B	GRM40B102M50PT	K22170805		
C 4081	CHIP CAP.	0.001uF	50V	B	GRM40B102M50PT	K22170805		
C 4082	FILM CAP.	8pF	500V		UC232H0080D-T	K33279005		
C 4083	FILM CAP.	39pF	500V		UC232H0390J-T	K33279038		
C 4084	AL.ELECTRO.CAP.	10uF	16V		16V100M4X7TR2	K46120004		
C 4085	CHIP CAP.	1pF	50V	CK	GRM40CK010C50PT	K22170202		
C 4086	FILM CAP.	3pF	500V		UC232H0030D-T	K33279027		
C 4087	FILM CAP.	4pF	500V		UC232H0040D-T	K33279046		
C 4088	CHIP CAP.	5pF	50V	CH	GRM40CH050C50PT	K22170206		
C 4089	FILM CAP.	27pF	500V		UC232H0270J-T	K33279023		
C 4090	CHIP CAP.	0.01uF	50V	B	GRM40B103M50PT	K22170817		
C 4091	FILM CAP.	39pF	500V		UC232H0390J-T	K33279038		
C 4092	CHIP CAP.	1pF	50V	CK	GRM40CK010C50PT	K22170202		
C 4093	CHIP CAP.	12pF	50V	CH	GRM40CH120J50PT	K22170213		
C 4094	CHIP CAP.	0.001uF	50V	B	GRM40B102M50PT	K22170805		
C 4095	CHIP CAP.	0.001uF	50V	B	GRM40B102M50PT	K22170805		
C 4096	FILM CAP.	39pF	500V		UC232H0390J-T	K33279038		
C 4097	FILM CAP.	33pF	500V		UC232H0330J-T	K33279024		
C 4099	CHIP CAP.	0.01uF	50V	B	GRM40B103M50PT	K22170817		
C 4100	CHIP CAP.	0.001uF	50V	B	GRM40B102M50PT	K22170805		
C 4101	CHIP CAP.	0.001uF	50V	B	GRM40B102M50PT	K22170805		
C 4102	CHIP CAP.	0.01uF	50V	B	GRM40B103M50PT	K22170817		
C 4103	CHIP CAP.	0.01uF	50V	B	GRM40B103M50PT	K22170817		
C 4104	CHIP CAP.	0.001uF	50V	B	GRM40B102M50PT	K22170805		
C 4105	AL.ELECTRO.CAP.	470uF	16V		RE2-16V471MM-T2	K46120003		
C 4106	CHIP CAP.	0.01uF	50V	B	GRM40B103M50PT	K22170817		
C 4107	CHIP CAP.	0.01uF	50V	B	GRM40B103M50PT	K22170817		
C 4108	CHIP CAP.	0.01uF	50V	B	GRM40B103M50PT	K22170817		
C 4109	CHIP CAP.	0.01uF	50V	B	GRM40B103M50PT	K22170817		
C 4110	CHIP CAP.	0.01uF	50V	B	GRM40B103M50PT	K22170817		
C 4111	AL.ELECTRO.CAF	100uF	16V		16V101M6X7TR2	K46120007		
C 4112	FILM CAP.	3pF	500V		UC232H0030D-T	K33279027		
C 4113	CHIP CAP.	10pF	50V	CH	GRM40CH100D50PT	K22170211		
C 4114	CHIP CAP.	0.5pF	50V	CK	GRM40CK0R5C50PT	K22170201		
C 4115	CHIP CAP.	0.5pF	50V	CK	GRM40CK0R5C50PT	K22170201		
C 4116	FILM CAP.	10pF	500V		UC232H0100D-T	K33279019		
C 4117	FILM CAP.	82pF	500V		UC232H0820J-T	K33279033		
D 4001	DIODE				11ES1	G2090499		
D 4002	DIODE				11ES1	G2090499		
D 4003	DIODE				11ES1	G2090499		
D 4004	DIODE				11ES1	G2090499		
D 4005	DIODE				UM9415	G2090425		
D 4006	DIODE				MI407	G2090345		
D 4007	DIODE				UM9415	G2090425		
D 4008	DIODE				MI407	G2090345		
D 4009	DIODE				UM9401F/TR	G2070516		



REF.	DESCRIPTION	VALUE	V/W	TOL.	MFR'S DESIG	YAESU P/N	VERS.	LOT.
D 4010	DIODE				1SS88	G2090636		
D 4011	DIODE				UM9401F/TR	G2070516		
D 4012	DIODE				1SS88	G2090636		
D 4013	DIODE				1SS88	G2090636		
D 4014	DIODE				1SS88	G2090636		
FB4001	FERRITE BEADS				4A2 RI3X3-1	L9190001		
FB4002	FERRITE BEADS				4A2 RI3X3-1	L9190001		
J 4001	CONNECTOR				TMP-J01X-A2	P1090255		
J 4003	CONNECTOR				SC25-05WS	P0090624		
J 4004	CONNECTOR				TMP-J01X-A2	P1090255		
J 4005	TERMINAL				Y106	S5000179		
J 4006	TERMINAL				Y106	S5000179		
J 4007	CONNECTOR				SC25-05WS	P0090624		
J 4008	CONNECTOR				TMP-J01X-A2	P1090255		
J 4009	CONNECTOR				B2B-ZR	P0090647		
L 4001	COIL A1				4.5T4.5D0.8UEW R	L0021907A		
L 4002	COIL A2				0.5T5.0D0.8TA	L0022516		
L 4003	COIL A1				4.5T2.5D0.5UEW R	L0021807A		
L 4004	COIL A1				4.5T4.5D0.8UEW R	L0021907A		
L 4005	COIL A1				2.5T3.0D0.6UEW R	L0021811A		
L 4006	COIL A1				8.5T3.0D0.5UEW R	L0020724A		
L 4007	COIL A1				5.5T4.0D0.6UEW R	L0021826A		
L 4008	M.RFC	1uH			LAP02TA1R0K	L1790046		
L 4009	M.RFC	1uH			LAP02TA1R0K	L1790046		
L 4010	COIL A1				3.5T5.0D1.2UEW R	L0022130		
L 4011	COIL A1				3.5T5.0D1.2UEW R	L0022130		
L 4012	COIL A1				2.5T6.0D1.2UEW R	L0022051		
L 4013	COIL A1				1.5T5.0D1.2UEW R	L0022163		
L 4014	COIL A1				1.5T3.0D1.2UEW R	L0022152		
L 4015	COIL A1				5.5T4.0D0.6UEW R	L0021826A		
L 4016	M.RFC	4.7uH			LAL04NA4R7K	L1190095		
L 4017	COIL A1				1.5T5.0D1.2UEW R	L0022163		
L 4018	COIL A1				2.5T6.0D1.2UEW R	L0022051		
L 4019	COIL A1				2.5T3.5D0.6UEW R	L0021817A		
L 4020	COIL A1				3.5T5.0D1.2UEW R	L0022130		
L 4021	COIL A1				4.5T4.0D1.2UEW R	L0022362		
L 4022	TOROIDAL COIL	0.082uH			0.082U T-37-6	L0022361		
L 4023	COIL A1				2.5T4.0D0.6UEW R	L0021823A		
L 4024	COIL A1				1.5T5.0D1.2UEW R	L0022163		
L 4025	COIL A1				1.5T5.0D1.2UEW R	L0022163		
L 4026	COIL A1				2.5T5.0D1.2UEW R	L0022131		
L 4027	COIL A1				1.5T5.0D1.2UEW R	L0022163		
L 4028	COIL A1				3.5T5.0D1.2UEW R	L0022130		
L 4029	COIL A1				2.5T5.0D1.2UEW R	L0022131		
L 4030	M.RFC	4.7uH			LAL04NA4R7K	L1190095		
L 4031	COIL A1				2.5T3.5D0.6UEW R	L0021817A		
L 4032	COIL A1				5.5T5.0D0.6UEW R	L0021832A		
L 4033	COIL A1				5.5T3.0D0.6UEW R	L0021814A		
Q 4001	IC				PF0340A	G1092570		
Q 4002	IC				PF0310A	G1091912		
Q 4003	TRANSISTOR				2SC3420GR	G3334200G		
Q 4004	TRANSISTOR				2SC3420GR	G3334200G		
Q 4005	TRANSISTOR				2SC5125-21	G3351250		
Q 4006	TRANSISTOR				2SC3102	G3331020		
Q 4007	TRANSISTOR				2SC2812L6-TA	G3328127F		
Q 4008	TRANSISTOR				2SC3420GR	G3334200G		
Q 4009	TRANSISTOR				2SC2812L6-TA	G3328127F		
Q 4010	TRANSISTOR				2SB1301-T2 ZQ	G3213017Q		
Q 4011	TRANSISTOR				DTC124EK T146	G3070034		
Q 4012	TRANSISTOR				2SB1301-T2 ZQ	G3213017Q		
Q 4013	TRANSISTOR				DTC124EK T146	G3070034		
R 4001	CHIP RES.	1kohm	1/10W	5%	RMC1/10T 102J	J24205102		



# V/U-PA Unit

REF.	DESCRIPTION	VALUE	V/W	TOL.	MFR'S DESIG	YAESU P/N	VERS.	LOT.
R 4002	CHIP RES.	1kohm	1/10W	5%	RMC1/10T 102J	J24205102		
R 4003	CHIP RES.	1.8kohm	1/10W	5%	RMC1/10T 182J	J24205182		
R 4004	CHIP RES.	220ohm	1/10W	5%	RMC1/10T 221J	J24205221		
R 4005	CHIP RES.	2.2kohm	1/10W	5%	RMC1/10T 222J	J24205222		
R 4006	CHIP RES.	1.8kohm	1/10W	5%	RMC1/10T 182J	J24205182		
R 4007	CHIP RES.	220ohm	1/10W	5%	RMC1/10T 220J	J24205220		
R 4008	CHIP RES.	220ohm	1/4W	5%	RMC1/4 221JATP	J24245221		
R 4009	CHIP RES.	680ohm	1/10W	5%	RMC1/10T 681J	J24205681		
R 4010	CHIP RES.	4.7ohm	1/2W	5%	RMC1/2 4R7JCTP	J24275479		
R 4011	CHIP RES.	470ohm	1/4W	5%	RMC1/4 471JATP	J24245471		
R 4012	CHIP RES.	220ohm	1/10W	5%	RMC1/10T 221J	J24205221		
R 4014	CHIP RES.	4.7ohm	1/2W	5%	RMC1/2 4R7JCTP	J24275479		
R 4015	CARBON FILM RES.	1ohm	1/4W	5%	RD14SJ1R0 1	J02245010		
R 4016	CHIP RES.	220ohm	1/10W	5%	RMC1/10T 220J	J24205220		
R 4017	CHIP RES.	1ohm	1/10W	5%	RMC1/10T 1R0J	J24205010		
R 4018	CHIP RES.	1ohm	1/10W	5%	RMC1/10T 1R0J	J24205010		
R 4019	CHIP RES.	220ohm	1/10W	5%	RMC1/10T 220J	J24205220		
R 4020	METAL FILM RES.	150ohm	2W	5%	ERG-2SJ151P 150	J22339010		
R 4021	METAL FILM RES.	150ohm	2W	5%	ERG-2SJ151P 150	J22339010		
R 4022	CHIP RES.	2.2ohm	1/2W	5%	RMC1/2 2R2JCTP	J24275229		
R 4023	CHIP RES.	4.7kohm	1/10W	5%	RMC1/10T 472J	J24205472		
R 4024	CHIP RES.	10kohm	1/10W	5%	RMC1/10T 103J	J24205103		
R 4025	CHIP RES.	1kohm	1/10W	5%	RMC1/10T 102J	J24205102		
R 4026	CHIP RES.	1kohm	1/10W	5%	RMC1/10T 102J	J24205102		
R 4027	CHIP RES.	47kohm	1/10W	5%	RMC1/10T 473J	J24205473		
R 4028	CHIP RES.	47kohm	1/10W	5%	RMC1/10T 473J	J24205473		
R 4029	CHIP RES.	10kohm	1/10W	5%	RMC1/10T 103J	J24205103		
R 4030	CHIP RES.	1kohm	1/10W	5%	RMC1/10T 102J	J24205102		
R 4031	CHIP RES.	1kohm	1/10W	5%	RMC1/10T 102J	J24205102		
R 4032	CHIP RES.	1kohm	1/10W	5%	RMC1/10T 102J	J24205102		
R 4033	CHIP RES.	47kohm	1/10W	5%	RMC1/10T 473J	J24205473		
R 4034	CHIP RES.	1kohm	1/10W	5%	RMC1/10T 102J	J24205102		
R 4035	CHIP RES.	47kohm	1/10W	5%	RMC1/10T 473J	J24205473		
R 4036	CHIP RES.	47kohm	1/10W	5%	RMC1/10T 473J	J24205473		
R 4037	CHIP RES.	1kohm	1/10W	5%	RMC1/10T 102J	J24205102		
R 4038	CHIP RES.	47kohm	1/10W	5%	RMC1/10T 473J	J24205473		
R 4039	CHIP RES.	47ohm	1/4W	5%	RMC1/4 470JATP	J24245470		
R 4040	CHIP RES.	68ohm	1W	5%	RMC1 680JTE	J24305680		
TC4001	TRIMMER CAP.	10pF			ECR-JA010A11X	K91000227		
TC4002	TRIMMER CAP.	30pF			ECR-JA030E12X	K91000180		
TC4003	TRIMMER CAP.	10pF			ECR-JA010A11X	K91000227		
TC4004	TRIMMER CAP.	10pF			ECR-JA010A11X	K91000227		
TC4005	TRIMMER CAP.	10pF			ECR-JA010A11X	K91000227		
TH4001	THERMISTOR				157-501-53009TP	G9090058		
TP4010	TERMINAL				TP-G MK1095	Q5000036		
TP4011	TERMINAL				TP-G MK1095	Q5000036		
VR4001	POT.	470ohm			RH0638CS2R 470B	J51808471		
VR4002	POT.	470ohm			RH0638CS2R 470B	J51808471		
VR4004	POT.	470ohm			RH0638CS2R 470B	J51808471		
Z 4001	LEAF SPRING					R0132100		
Z 4002	LEAF SPRING					R0125800		2-

Circuit Diagram

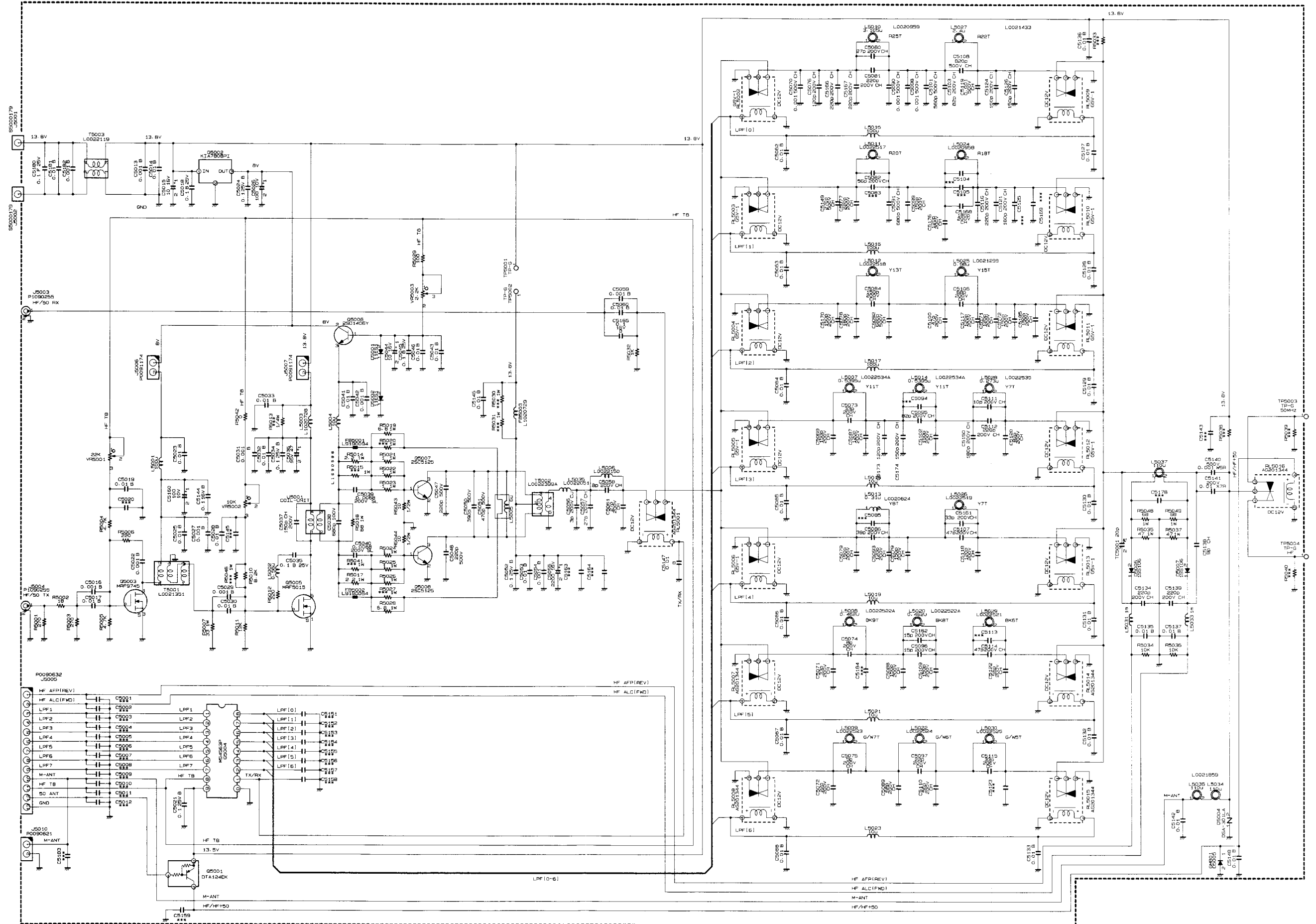

Parts Layout

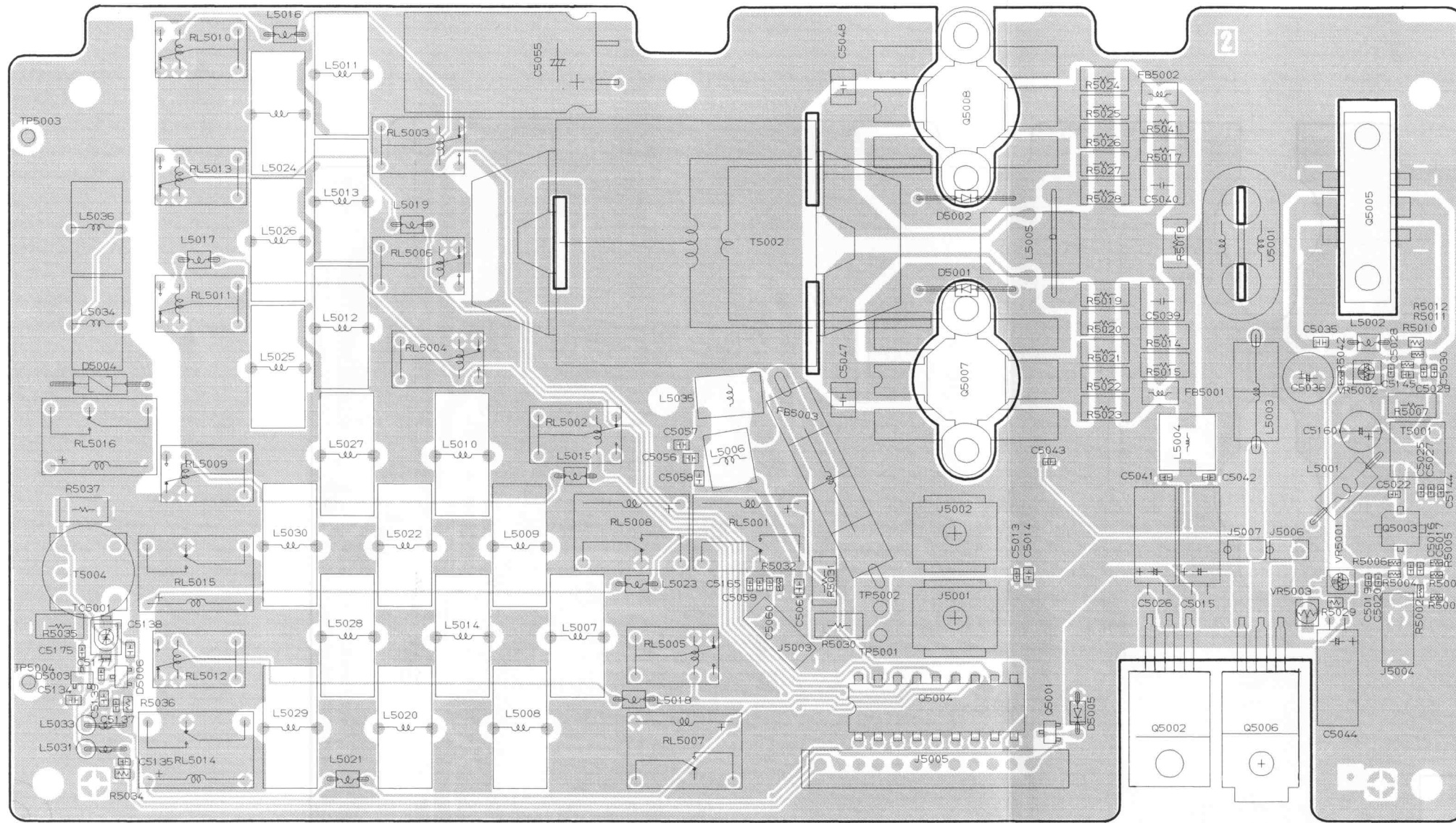

Component Side

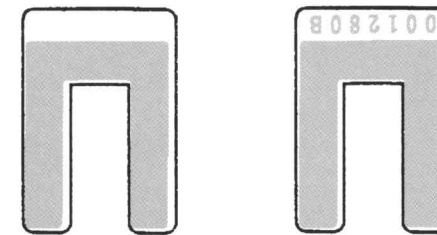

Coil Unit

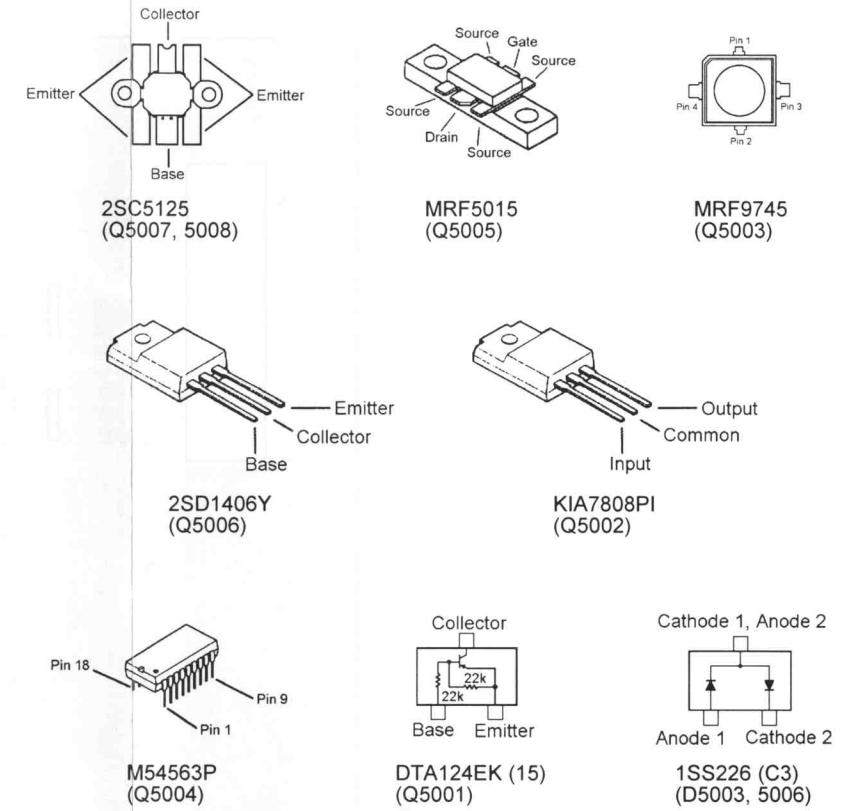

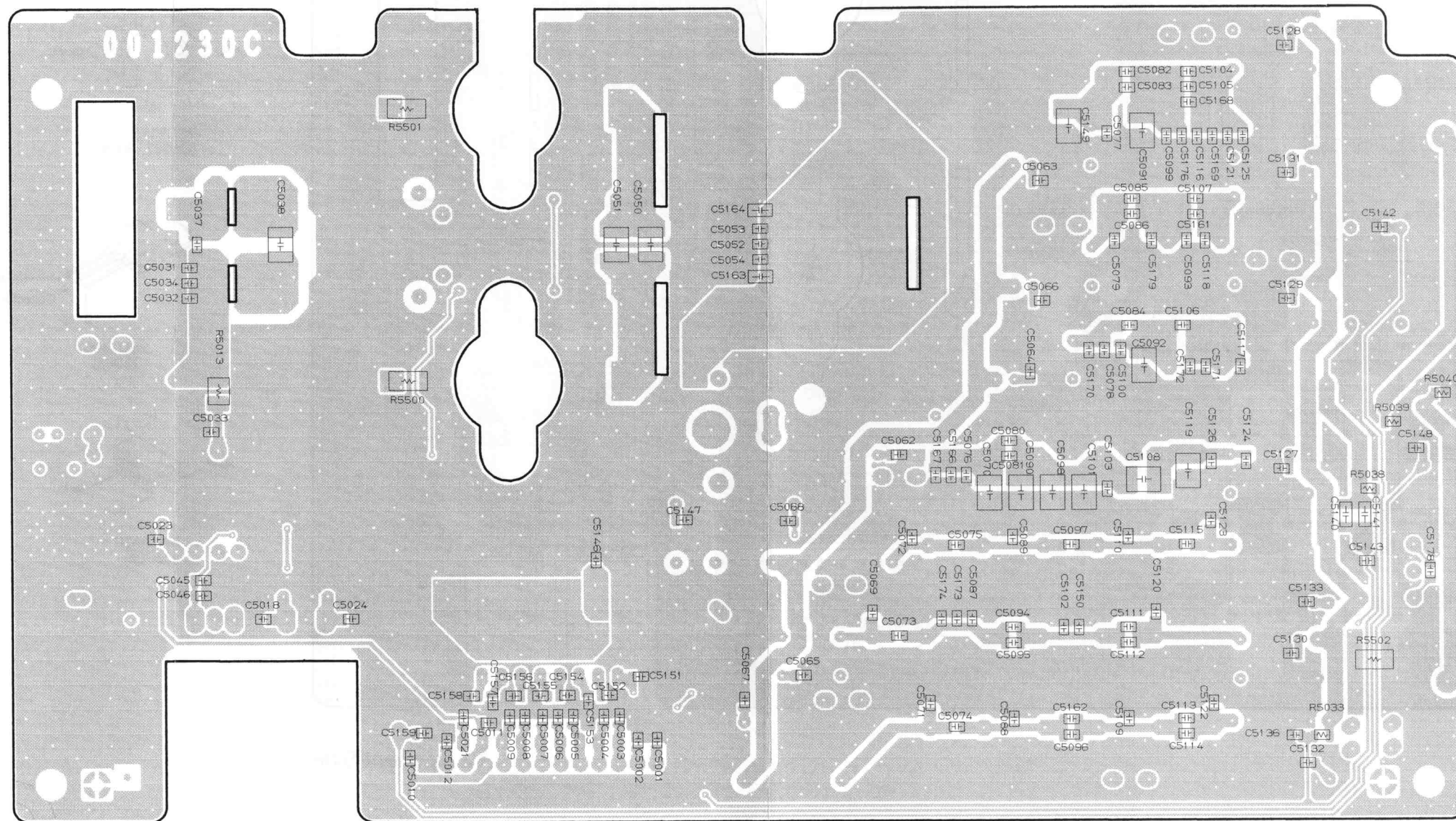

Chip Side



Parts List

REF.	DESCRIPTION	VALUE	V/W	TOL.	MFR'S DESIG	YAESU P/N	VERS.	LOT.
*** PA UNIT ***								
PCB with Components (w/ P5001,P5002,Q5005,Q5007,Q5008)						CS1576001		
Printed Circuit Board						FR001230C		
C 5015	AL.ELECTRO.CAP.	10uF	16V		RE2-16V100MMA 10UF	K40129004		
C 5016	CHIP CAP.	0.001uF	50V	B	GRM39B102M50PT	K22174809		
C 5017	CHIP CAP.	0.01uF	50V	B	GRM39B103M50PT	K22174823		
C 5018	CHIP CAP.	0.1uF	25V	B	GRM40B104M25PT	K22140811		
C 5019	CHIP CAP.	0.01uF	50V	B	GRM39B103M50PT	K22174823		
C 5021	CHIP CAP.	0.1uF	25V	B	GRM40B104M25PT	K22140811		
C 5022	CHIP CAP.	0.001uF	50V	B	GRM39B102M50PT	K22174809		
C 5023	CHIP CAP.	0.01uF	50V	B	GRM40B103K50PT	K22170826		
C 5024	CHIP CAP.	0.1uF	25V	B	GRM40B104M25PT	K22140811		
C 5025	CHIP CAP.	0.01uF	50V	B	GRM39B103M50PT	K22174823		
C 5026	AL.ELECTRO.CAP.	100uF	10V		RE2-10V101M 100UF	K40109024		
C 5027	CHIP CAP.	0.001uF	50V	B	GRM39B102M50PT	K22174809		
C 5028	CHIP CAP.	0.01uF	50V	B	GRM39B103M50PT	K22174823		
C 5029	CHIP CAP.	0.001uF	50V	B	GRM39B102M50PT	K22174809		
C 5030	CHIP CAP.	0.01uF	50V	B	GRM39B103M50PT	K22174823		
C 5031	CHIP CAP.	0.001uF	50V	B	GRM40B102K50PT	K22170825		
C 5032	CHIP CAP.	0.01uF	50V	B	GRM40B103K50PT	K22170826		
C 5033	CHIP CAP.	0.01uF	50V	B	GRM40B103K50PT	K22170826		
C 5034	CHIP CAP.	0.1uF	25V	B	GRM40B104M25PT	K22140811		
C 5035	CHIP CAP.	0.1uF	25V	B	GRM40B104M25PT	K22140811		
C 5036	AL.ELECTRO.CAP.	47uF	16V		16V470M6X7TR2	K46120006		
C 5037	CHIP CAP.	150pF	200V	CH	GRM40CH151J200PT	K22230230		
C 5038	FILM CAP.	680pF	100V		UC342A6800J-T	K33209036		
C 5039	CERAMIC CAP.	0.0068uF	200V	SL	GRM44-1SL682J200PT	K22236101		
C 5040	CERAMIC CAP.	0.0068uF	200V	SL	GRM44-1SL682J200PT	K22236101		
C 5041	CHIP CAP.	0.01uF	50V	B	GRM39B103M50PT	K22174823		
C 5042	CHIP CAP.	0.001uF	50V	B	GRM39B102M50PT	K22174809		
C 5043	CHIP CAP.	0.01uF	50V	B	GRM39B103M50PT	K22174823		
C 5044	AL.ELECTRO.CAP.	10uF	16V		RE2-16V100MMA 10UF	K40129004		
C 5045	CHIP CAP.	0.1uF	25V	B	GRM40B104M25PT	K22140811		
C 5046	CHIP CAP.	0.01uF	50V	B	GRM40B103K50PT	K22170826		
C 5047	FILM CAP.	220pF	500V		UC342H2200J-T	K33279011		
C 5048	FILM CAP.	220pF	500V		UC342H2200J-T	K33279011		
C 5050	FILM CAP.	390pF	500V		UC342H3900J-T	K33279040		
C 5051	FILM CAP.	470pF	500V		UC342H4700J-T	K33279015		
C 5052	CHIP CAP.	0.1uF	25V	B	GRM40B104M25PT	K22140811		
C 5053	CHIP CAP.	0.01uF	50V	B	GRM40B103K50PT	K22170826		
C 5054	CHIP CAP.	0.001uF	50V	B	GRM40B102K50PT	K22170825		
C 5055	AL.ELECTRO.CAP.	2200uF	16V		RE2-16V222M 2200UF	K40129050		
C 5056	CHIP CAP.	3pF	200V	CJ	GRM40CJ030C200PT	K22230210		
C 5057	CHIP CAP.	27pF	200V	CH	GRM40CH270J200PT	K22230221		
C 5058	CHIP CAP.	8pF	200V	CH	GRM40CH080D200PT	K22230214		
C 5059	CHIP CAP.	0.001uF	50V	B	GRM39B102M50PT	K22174809		
C 5060	CHIP CAP.	0.01uF	50V	B	GRM39B103M50PT	K22174823		
C 5061	CHIP CAP.	27pF	200V	CH	GRM40CH270J200PT	K22230221		
C 5062	CHIP CAP.	0.01uF	50V	B	GRM40B103K50PT	K22170826		
C 5063	CHIP CAP.	0.01uF	50V	B	GRM40B103K50PT	K22170826		
C 5064	CHIP CAP.	0.01uF	50V	B	GRM40B103K50PT	K22170826		
C 5065	CHIP CAP.	0.01uF	50V	B	GRM40B103K50PT	K22170826		
C 5066	CHIP CAP.	0.01uF	50V	B	GRM40B103K50PT	K22170826		
C 5067	CHIP CAP.	0.01uF	50V	B	GRM40B103K50PT	K22170826		
C 5068	CHIP CAP.	0.01uF	50V	B	GRM40B103K50PT	K22170826		
C 5069	CHIP CAP.	150pF	200V	CH	GRM40CH151J200PT	K22230230		

# PA Unit

REF.	DESCRIPTION	VALUE	V/W	TOL.	MFR'S DESIG	YAESU P/N	VERS.	LOT.
C 5070	CHIP CAP.	0.001uF	500V	CH	CF43CH102J500AT	K22277222		
C 5071	CHIP CAP.	33pF	200V	CH	GRM40CH330J200PT	K22230222		
C 5072	CHIP CAP.	22pF	200V	CH	GRM40CH220J200PT	K22230220		
C 5073	CHIP CAP.	33pF	200V	CH	GRM40CH330J200PT	K22230222		
C 5074	CHIP CAP.	8pF	200V	CH	GRM40CH080D200PT	K22230214		
C 5075	CHIP CAP.	5pF	200V	CH	GRM40CH050C200PT	K22230207		
C 5076	CHIP CAP.	120pF	200V	CH	GRM40CH121J200PT	K22230229		
C 5077	CHIP CAP.	220pF	200V	CH	GRM40CH221J200PT	K22230232		
C 5078	CHIP CAP.	180pF	200V	CH	GRM40CH181J200PT	K22230231		
C 5079	CHIP CAP.	150pF	200V	CH	GRM40CH151J200PT	K22230230		
C 5080	CHIP CAP.	27pF	200V	CH	GRM40CH270J200PT	K22230221		
C 5081	CHIP CAP.	220pF	200V	CH	GRM40CH221J200PT	K22230232		
C 5082	CHIP CAP.	56pF	200V	CH	GRM40CH560J200PT	K22230225		
C 5084	CHIP CAP.	150pF	200V	CH	GRM40CH151J200PT	K22230230		
C 5086	CHIP CAP.	39pF	200V	CH	GRM40CH390J200PT	K22230223		
C 5087	CHIP CAP.	120pF	200V	CH	GRM40CH121J200PT	K22230229		
C 5088	CHIP CAP.	150pF	200V	CH	GRM40CH151J200PT	K22230230		
C 5089	CHIP CAP.	68pF	200V	CH	GRM40CH680J200PT	K22230226		
C 5090	CHIP CAP.	0.001uF	500V	CH	CF43CH102J500AT	K22277222		
C 5091	CHIP CAP.	680pF	500V	CH	CF43CH681J500AT	K22277218		
C 5092	CHIP CAP.	680pF	500V	CH	CF43CH681J500AT	K22277218		
C 5093	CHIP CAP.	120pF	200V	CH	GRM40CH121J200PT	K22230229		
C 5095	CHIP CAP.	82pF	200V	CH	GRM40CH820J200PT	K22230227		
C 5096	CHIP CAP.	15pF	200V	CH	GRM40CH150J200PT	K22230218		
C 5097	CHIP CAP.	22pF	200V	CH	GRM40CH220J200PT	K22230220		
C 5098	CHIP CAP.	0.001uF	500V	CH	CF43CH102J500AT	K22277222		
C 5099	CHIP CAP.	150pF	200V	CH	GRM40CH151J200PT	K22230230		
C 5100	CHIP CAP.	47pF	200V	CH	GRM40CH470J200PT	K22230224		
C 5101	CHIP CAP.	560pF	500V	CH	CF43CH561J500AT	K22277216		
C 5102	CHIP CAP.	150pF	200V	CH	GRM40CH151J200PT	K22230230		
C 5103	CHIP CAP.	82pF	200V	CH	GRM40CH820J200PT	K22230227		
C 5106	CHIP CAP.	68pF	200V	CH	GRM40CH680J200PT	K22230226		
C 5107	CHIP CAP.	47pF	200V	CH	GRM40CH470J200PT	K22230224		
C 5108	CHIP CAP.	820pF	500V	CH	CF43CH821J500AT	K22277220		
C 5109	CHIP CAP.	150pF	200V	CH	GRM40CH151J200PT	K22230230		
C 5110	CHIP CAP.	56pF	200V	CH	GRM40CH560J200PT	K22230225		
C 5111	CHIP CAP.	10pF	200V	CH	GRM40CH100D200PT	K22230216		
C 5112	CHIP CAP.	220pF	200V	CH	GRM40CH221J200PT	K22230232		
C 5114	CHIP CAP.	47pF	200V	CH	GRM40CH470J200PT	K22230224		
C 5115	CHIP CAP.	33pF	200V	CH	GRM40CH330J200PT	K22230222		
C 5116	CHIP CAP.	220pF	200V	CH	GRM40CH221J200PT	K22230232		
C 5117	CHIP CAP.	120pF	200V	CH	GRM40CH121J200PT	K22230229		
C 5118	CHIP CAP.	120pF	200V	CH	GRM40CH121J200PT	K22230229		
C 5119	CHIP CAP.	0.001uF	500V	CH	CF43CH102J500AT	K22277222		
C 5120	CHIP CAP.	82pF	200V	CH	GRM40CH820J200PT	K22230227		
C 5121	CHIP CAP.	180pF	200V	CH	GRM40CH181J200PT	K22230231		
C 5122	CHIP CAP.	56pF	200V	CH	GRM40CH560J200PT	K22230225		
C 5124	CHIP CAP.	150pF	200V	CH	GRM40CH151J200PT	K22230230		
C 5126	CHIP CAP.	150pF	200V	CH	GRM40CH151J200PT	K22230230		
C 5127	CHIP CAP.	0.01uF	50V	B	GRM40B103K50PT	K22170826		
C 5128	CHIP CAP.	0.01uF	50V	B	GRM40B103K50PT	K22170826		
C 5129	CHIP CAP.	0.01uF	50V	B	GRM40B103K50PT	K22170826		
C 5130	CHIP CAP.	0.01uF	50V	B	GRM40B103K50PT	K22170826		
C 5131	CHIP CAP.	0.01uF	50V	B	GRM40B103K50PT	K22170826		
C 5132	CHIP CAP.	0.01uF	50V	B	GRM40B103K50PT	K22170826		
C 5133	CHIP CAP.	0.01uF	50V	B	GRM40B103K50PT	K22170826		

REF.	DESCRIPTION	VALUE	V/W	TOL.	MFR'S DESIG	YAESU P/N	VERS.	LOT.
C 5134	CHIP CAP.	220pF	200V	CH	GRM40CH221J200PT	K22230232		
C 5135	CHIP CAP.	0.01uF	50V	B	GRM39B103M50PT	K22174823		
C 5136	CHIP CAP.	0.01uF	50V	B	GRM40B103K50PT	K22170826		
C 5137	CHIP CAP.	0.01uF	50V	B	GRM39B103M50PT	K22174823		
C 5138	CHIP CAP.	9pF	50V	CH	GRM40CH090D50PT	K22170210		
C 5139	CHIP CAP.	220pF	200V	CH	GRM40CH221J200PT	K22230232		
C 5140	CHIP CAP.	0.001uF	500V	W5R	CF316W5R102K500AT	K22271802		
C 5141	CHIP CAP.	0.01uF	200V	X7R	GRM42-6X7R103K200PT	K22231802		
C 5142	CHIP CAP.	0.01uF	50V	B	GRM40B103K50PT	K22170826		
C 5144	CHIP CAP.	0.1uF	16V	B	GRM39B104K16PT	K22124805		
C 5146	CHIP CAP.	0.01uF	50V	B	GRM40B103K50PT	K22170826		
C 5147	CHIP CAP.	0.01uF	50V	B	GRM40B103K50PT	K22170826		
C 5148	CHIP CAP.	0.01uF	50V	B	GRM40B103K50PT	K22170826		
C 5149	CHIP CAP.	270pF	500V	CH	CF43CH271J500AT	K22277208		
C 5150	CHIP CAP.	180pF	200V	CH	GRM40CH181J200PT	K22230231		
C 5160	AL.ELECTRO.CAP.	100uF	10V		10V101M5X11TR5	K46100004		
C 5161	CHIP CAP.	33pF	200V	CH	GRM40CH330J200PT	K22230222		
C 5162	CHIP CAP.	15pF	200V	CH	GRM40CH150J200PT	K22230218		
C 5165	CHIP CAP.	0.1uF	16V	B	GRM39B104K16PT	K22124805		
C 5166	CHIP CAP.	220pF	200V	CH	GRM40CH221J200PT	K22230232		
C 5167	CHIP CAP.	220pF	200V	CH	GRM40CH221J200PT	K22230232		
C 5168	CHIP CAP.	180pF	200V	CH	GRM40CH181J200PT	K22230231		
C 5170	CHIP CAP.	150pF	200V	CH	GRM40CH151J200PT	K22230230		
C 5171	CHIP CAP.	120pF	200V	CH	GRM40CH121J200PT	K22230229		
C 5172	CHIP CAP.	150pF	200V	CH	GRM40CH151J200PT	K22230230		
C 5173	CHIP CAP.	120pF	200V	CH	GRM40CH121J200PT	K22230229		
C 5174	CHIP CAP.	150pF	200V	CH	GRM40CH151J200PT	K22230230		
C 5175	CHIP CAP.	0.01uF	50V	B	GRM39B103M50PT	K22174823		
C 5176	CHIP CAP.	120pF	200V	CH	GRM40CH121J200PT	K22230229		
C 5177	CHIP CAP.	0.01uF	50V	B	GRM39B103M50PT	K22174823		
C 5179	CHIP CAP.	150pF	200V	CH	GRM40CH151J200PT	K22230230		
C 5185	CHIP CAP.	150pF	200V	CH	GRM40CH151J200PT	K22230230		
D 5001	DIODE				11ES1	G2090499		
D 5002	DIODE				11ES1	G2090499		
D 5004	SURGE ABSORBER				DSA-301LA	Q9000371		
D 5005	DIODE				GMB01-BT	G2060016		
D 5006	DIODE				1SS106RE	G2050005		
D 5007	DIODE				1SS106RE	G2050005		
FB5001	FERRITE BEADS				SMB304729	L9190094		
FB5002	FERRITE BEADS				SMB304729	L9190094		
FB5003	RFC WITH BEADS				3A R15.8X6.4-2	L1020729		
FB5004	CORE				3A5 RIB-10X20X10	L9190101		
J 5001	TERMINAL				Y106	S5000179		
J 5002	TERMINAL				Y106	S5000179		
J 5003	CONNECTOR				TMP-J01X-A2	P1090255		
J 5004	CONNECTOR				TMP-J01X-A2	P1090255		
J 5005	CONNECTOR				SC25-13WS	P0090632		
J 5006	CONNECTOR				IMSA-9202B-1-02-T	P0091174		
J 5007	CONNECTOR				IMSA-9202B-1-02-T	P0091174		
L 5001	M.RFC	100uH			LAL04NA101K	L1190133		
L 5002	M.RFC	0.56uH			LAP02TAR56K	L1790043		
L 5003	RFC WITH BEADS				3A R15.8X6.4-2	L1020728		
L 5004	M.RFC	10uH			CDRH73-100MC	L1690598		
L 5005	TOROIDAL COIL	6uH			U 6H3 10X5X5	L0022039		
L 5006	COIL A1				4.5T6.0D1.2UEW R	L0022150		
L 5007	TOROIDAL COIL	0.534uH			0.534U T-50-6	L0022533		

# PA Unit

REF.	DESCRIPTION	VALUE	V/W	TOL.	MFR'S DESIG	YAESU P/N	VERS.	LOT.
L 5007	TOROIDAL COIL	0.5395uH			0.5395U T-50-6	L0022534A		2-
L 5008	TOROIDAL COIL				T50-10 9T #222895	L0022522		
L 5008	TOROIDAL COIL	0.462uH			0.462U T50-10	L0022522A		2-
L 5009	TOROIDAL COIL				T50-12 7T #222879	L0022523		
L 5010	TOROIDAL COIL	3.105uH			3.105U T50-2	L0020959		
L 5011	TOROIDAL COIL				T50-2 20T #222874	L0022517		
L 5012	TOROIDAL COIL				T50-6 13T #222875	L0022518		
L 5013	TOROIDAL COIL	0.31uH			0.310U T50-6	L0020624		
L 5014	TOROIDAL COIL	0.545uH			0.545U T-50-6	L0022534		
L 5014	TOROIDAL COIL	0.5395uH			0.5395U T-50-6	L0022534A		2-
L 5015	M.RFC	100uH			LAP02TA101K	L1790070		
L 5016	M.RFC	100uH			LAP02TA101K	L1790070		
L 5017	M.RFC	100uH			LAP02TA101K	L1790070		
L 5018	M.RFC	10uH			LAP02TA100K	L1790058		
L 5019	M.RFC	10uH			LAP02TA100K	L1790058		
L 5020	TOROIDAL COIL				T50-10 8T #222877	L0022520		
L 5020	TOROIDAL COIL	0.462uH			0.462U T50-10	L0022522A		2-
L 5021	M.RFC	10uH			LAP02TA100K	L1790058		
L 5022	TOROIDAL COIL				T50-12 6T #222880	L0022524		
L 5023	M.RFC	10uH			LAP02TA100K	L1790058		
L 5024	TOROIDAL COIL	1.6uH			1.600U T50-2	L0020958		
L 5025	TOROIDAL COIL	0.98uH			0.980U T50-6	L0021299		
L 5026	TOROIDAL COIL				T50-6 7T #222876	L0022519		
L 5027	TOROIDAL COIL	2.4uH			2.400U T-50-2	L0021433		
L 5028	TOROIDAL COIL	0.273uH			0.273U T-50-6	L0022535		
L 5029	TOROIDAL COIL				T50-10 6T #222878	L0022521		
L 5030	TOROIDAL COIL				T50-12 5T #222881	L0022525		
L 5031	M.RFC	1mH			LAL03VB102K	L1790164		
L 5033	M.RFC	1mH			LAL03VB102K	L1790164		
L 5034	TOROIDAL COIL	110uH			110U RI9.3-4.8-5	L0021859		
L 5035	COIL A1				2.5T6.0D1.2UEW R	L0022051		
L 5036	TOROIDAL COIL	110uH			110U RI9.3-4.8-5	L0021859		
L 5037	TOROIDAL COIL	110uH			110U RI9.3-4.8-5	L0021859		
P 5001	CONNECTOR				IMSA-9206H-T	P1090988		
P 5002	CONNECTOR				IMSA-9206H-T	P1090988		
Q 5001	TRANSISTOR				DTA124EK T146	G3070030		
Q 5002	IC				KIA7808PI	G1092425		
Q 5003	FET				MRF9745T1	G3070189		
Q 5004	IC				M54563P	G1090721		
Q 5005	FET				MRF5015	G3090113		
Q 5006	TRANSISTOR				2SD1406Y	G3414060Y		
Q 5007	TRANSISTOR				2SC5125-21	G3351250		
Q 5008	TRANSISTOR				2SC5125-21	G3351250		
R 5001	CHIP RES.	270ohm	1/16W	5%	RMC1/16 271JATP	J24185271		
R 5002	CHIP RES.	18ohm	1/16W	5%	RMC1/16 180JATP	J24185180		
R 5003	CHIP RES.	270ohm	1/16W	5%	RMC1/16 271JATP	J24185271		
R 5004	CHIP RES.	4.7kohm	1/16W	5%	RMC1/16 472JATP	J24185472		
R 5005	CHIP RES.	4.7kohm	1/16W	5%	RMC1/16 472JATP	J24185472		
R 5006	CHIP RES.	220ohm	1/16W	5%	RMC1/16 221JATP	J24185221		
R 5007	CHIP RES.	33ohm	1W	5%	RMC1 330JTE	J24305330		
R 5010	CHIP RES.	8.2kohm	1/16W	5%	RMC1/16 822JATP	J24185822		
R 5011	CHIP RES.	12kohm	1/16W	5%	RMC1/16 123JATP	J24185123		
R 5012	CHIP RES.	220ohm	1/10W	5%	RMC1/10T 221J	J24205221		
R 5014	CHIP RES.	2.2ohm	1W	5%	RMC1 2R2JTE	J24305229		
R 5017	CHIP RES.	2.2ohm	1W	5%	RMC1 2R2JTE	J24305229		
R 5018	CHIP RES.	68ohm	1W	5%	RMC1 680JTE	J24305680		



REF.	DESCRIPTION	VALUE	V/W	TOL.	MFR'S DESIG	YAESU P/N	VERS.	LOT.
R 5019	CHIP RES.	6.8ohm	1W	5%	RMC1 6R8JTE	J24305689		
R 5021	CHIP RES.	1ohm	1W	5%	RMC1 1R0JTE	J24305010		
R 5022	CHIP RES.	1ohm	1W	5%	RMC1 1R0JTE	J24305010		
R 5023	CHIP RES.	1ohm	1W	5%	RMC1 1R0JTE	J24305010		
R 5024	CHIP RES.	1ohm	1W	5%	RMC1 1R0JTE	J24305010		
R 5025	CHIP RES.	1ohm	1W	5%	RMC1 1R0JTE	J24305010		
R 5026	CHIP RES.	1ohm	1W	5%	RMC1 1R0JTE	J24305010		
R 5028	CHIP RES.	6.8ohm	1W	5%	RMC1 6R8JTE	J24305689		
R 5029	CHIP RES.	100ohm	1/10W	5%	RMC1/10T 101J	J24205101		
R 5032	CHIP RES.	1kohm	1/16W	5%	RMC1/16 102JATP	J24185102		
R 5034	CHIP RES.	10kohm	1/10W	5%	RMC1/10T 103J	J24205103		
R 5035	CHIP RES.	47ohm	1W	5%	RMC1 470JTE	J24305470		
R 5036	CHIP RES.	10kohm	1/10W	5%	RMC1/10T 103J	J24205103		
R 5037	CHIP RES.	47ohm	1W	5%	RMC1 470JTE	J24305470		
R 5042	CHIP RES.	0ohm	1/16W	5%	RMC1/16 000JATP	J24185000		
R 5043	CHIP RES.	10ohm	1/2W	5%	RMC1/2 100JCTP	J24275100		
R 5044	CHIP RES.	10ohm	1/2W	5%	RMC1/2 100JCTP	J24275100		
R 5048	CHIP RES.	68ohm	1W	5%	RMC1 680JTE	J24305680		
R 5049	CHIP RES.	68ohm	1W	5%	RMC1 680JTE	J24305680		
RL5001	RELAY		DC12V		AG201344 DC12V	M1190124		
RL5002	RELAY		DC12V		G5V-1 DC12V	M1190120		
RL5003	RELAY		DC12V		G5V-1 DC12V	M1190120		
RL5004	RELAY		DC12V		G5V-1 DC12V	M1190120		
RL5005	RELAY		DC12V		G5V-1 DC12V	M1190120		
RL5006	RELAY		DC12V		G5V-1 DC12V	M1190120		
RL5007	RELAY		DC12V		AG201344 DC12V	M1190124		
RL5008	RELAY		DC12V		AG201344 DC12V	M1190124		
RL5009	RELAY		DC12V		G5V-1 DC12V	M1190120		
RL5010	RELAY		DC12V		G5V-1 DC12V	M1190120		
RL5011	RELAY		DC12V		G5V-1 DC12V	M1190120		
RL5012	RELAY		DC12V		G5V-1 DC12V	M1190120		
RL5013	RELAY		DC12V		G5V-1 DC12V	M1190120		
RL5014	RELAY		DC12V		AG201344 DC12V	M1190124		
RL5015	RELAY		DC12V		AG201344 DC12V	M1190124		
RL5016	RELAY		DC12V		AG201344 DC12V	M1190124		
T 5001	COIL 07WIDE				4-1 2001F FR6	L0021351		
T 5002	COIL PWR-WIDE				D12A RIB16	L0022399A		
TC5001	TRIMMER CAP.	20pF			ECR-JA020E11X	K91000228		
TP5003	TERMINAL				TP-G MK1095	Q5000036		
TP5004	TERMINAL				TP-G MK1095	Q5000036		
VR5001	POT.	22kohm			EVN-5ESX50BE4	J51811223		
VR5002	POT.	10kohm			EVN-5ESX50B14	J51811103		
VR5003	POT.	2.2kohm			RH03A3AJ3X 2.2K	J51807222		

# PA Unit

---

*Notes:*



# DSP Unit

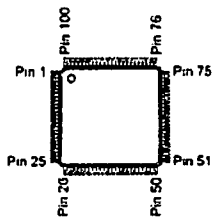

**TMS320C203PZ57**  
(Q6012)

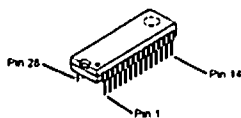

**TMS27C256-15JL**  
(Q6003)

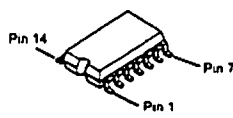

**TC74HC20AF**  
(Q6009)

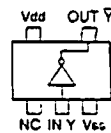

**TC7SU04F (E6)**  
(Q6002, 6010)

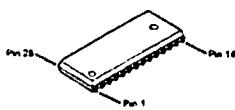

**AS7C256-15JC**  
(Q6008, 6011, 6013,  
6014)

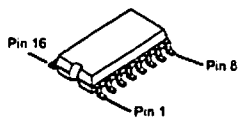

**TC74HC4040AF**  
(Q6007)

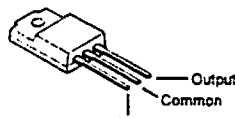

**KIA7805PI**  
(Q6001)

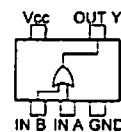

**TC7SH32FU (H4)**  
(Q6015)

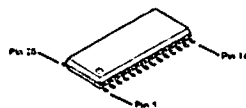

**AK4520A**  
(Q6005)

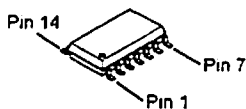

**NJM2902M**  
(Q6004)

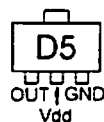

**RH5VL45AA (D5)**  
(Q6006)

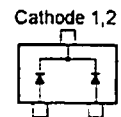

**DAN202K (N)**  
(D6001)

Parts Layout

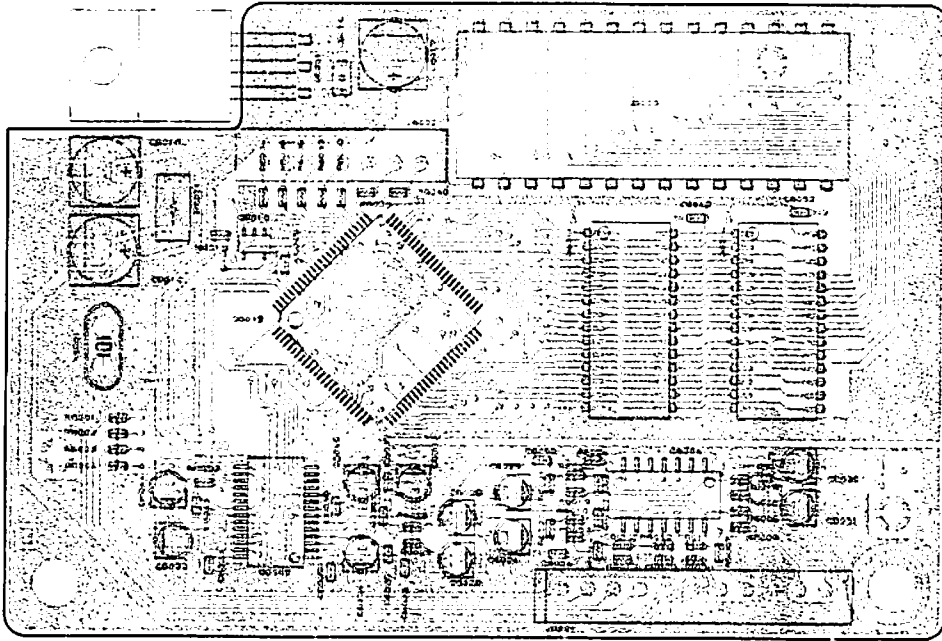

Component Side

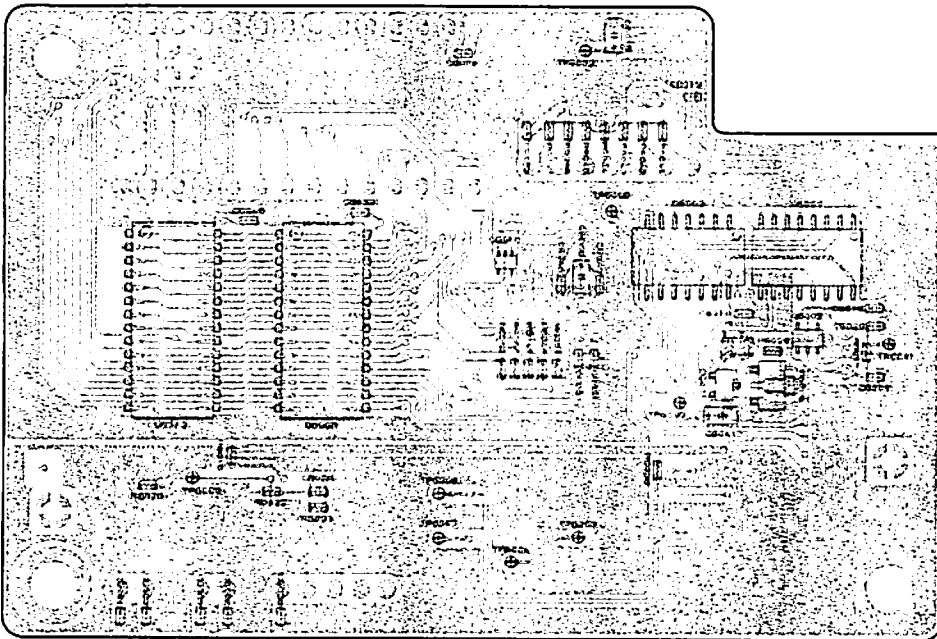

Chip Side

# DSP Unit

## Parts List

REF.	DESCRIPTION	VALUE	V/W	TOL.	MFR'S DESIG	YAESU P/N	VERS.	LOT.
*** DSP UNIT ***								
PCB with Components						CB0221001		
Printed Circuit Board						FR001910B		
C 6001	CHIP CAP.	0.047uF	16V	B	GRM39B473K16PT	K22124804		
C 6002	CHIP CAP.	0.001uF	50V	B	GRM39B102M50PT	K22174809		
C 6003	CHIP CAP.	33pF	50V	CH	GRM39CH330J50PT	K22174223		
C 6004	CHIP CAP.	0.1uF	16V	B	GRM39B104K16PT	K22124805		
C 6005	CHIP CAP.	0.001uF	50V	B	GRM39B102M50PT	K22174809		
C 6006	CHIP CAP.	0.001uF	50V	B	GRM39B102M50PT	K22174809		
C 6007	CHIP CAP.	100pF	50V	CH	GRM39CH101J50PT	K22174235		
C 6007	CHIP CAP.	470pF	50V	B	GRM39B471M50PT	K22174805		2-
C 6008	CHIP CAP.	0.001uF	50V	B	GRM39B102M50PT	K22174809		
C 6009	CHIP CAP.	0.001uF	50V	B	GRM39B102M50PT	K22174809		
C 6010	AL.ELECTRO.CAP.	47uF	16V		ECEV1CA470P	K48120003		
C 6011	CHIP CAP.	0.001uF	50V	B	GRM39B102M50PT	K22174809		
C 6012	CHIP CAP.	100pF	50V	CH	GRM39CH101J50PT	K22174235		
C 6013	CHIP CAP.	0.001uF	50V	B	GRM39B102M50PT	K22174809		
C 6014	TANTALUM CHIP CAP.	0.1uF	35V		TESVA1V104M1-8R	K78160025		
C 6015	AL.ELECTRO.CAP.	47uF	16V		ECEV1CA470P	K48120003		
C 6016	CHIP CAP.	0.01uF	25V	B	GRM39B103M25PT	K22144802		
C 6017	AL.ELECTRO.CAP.	47uF	16V		ECEV1CA470P	K48120003		
C 6018	TANTALUM CHIP CAP.	1uF	16V		TESVA1C105M1-8R	K78120009		
C 6019	CHIP CAP.	0.1uF	16V	B	GRM39B104K16PT	K22124805		
C 6020	CHIP CAP.	33pF	50V	CH	GRM39CH330J50PT	K22174223		
C 6021	CHIP CAP.	100pF	50V	CH	GRM39CH101J50PT	K22174235		
C 6021	CHIP CAP.	220pF	50V	CH	GRM39CH221J50PT	K22174243		2-
C 6022	AL.ELECTRO.CAP.	10uF	16V		ECEV1CS100SR	K48120001		
C 6023	CHIP CAP.	0.1uF	16V	B	GRM39B104K16PT	K22124805		
C 6024	AL.ELECTRO.CAP.	10uF	16V		ECEV1CS100SR	K48120001		
C 6025	AL.ELECTRO.CAP.	10uF	16V		ECEV1CS100SR	K48120001		
C 6026	CHIP CAP.	100pF	50V	CH	GRM39CH101J50PT	K22174235		
C 6027	CHIP CAP.	0.1uF	16V	B	GRM39B104K16PT	K22124805		
C 6028	AL.ELECTRO.CAP.	10uF	16V		ECEV1CS100SR	K48120001		
C 6029	AL.ELECTRO.CAP.	10uF	16V		ECEV1CS100SR	K48120001		
C 6030	AL.ELECTRO.CAP.	10uF	16V		ECEV1CS100SR	K48120001		
C 6031	AL.ELECTRO.CAP.	10uF	16V		ECEV1CS100SR	K48120001		
C 6032	CHIP CAP.	0.1uF	16V	B	GRM39B104K16PT	K22124805		
C 6033	CHIP CAP.	0.0022uF	50V	B	GRM39B222M50PT	K22174813		
C 6034	AL.ELECTRO.CAP.	10uF	16V		ECEV1CS100SR	K48120001		
C 6035	CHIP CAP.	0.1uF	16V	B	GRM39B104K16PT	K22124805		
C 6036	CHIP CAP.	0.0022uF	50V	B	GRM39B222M50PT	K22174813		
C 6037	CHIP CAP.	0.1uF	16V	B	GRM39B104K16PT	K22124805		
C 6038	CHIP CAP.	0.1uF	16V	B	GRM39B104K16PT	K22124805		
C 6039	AL.ELECTRO.CAP.	10uF	16V		ECEV1CS100SR	K48120001		
C 6040	AL.ELECTRO.CAP.	10uF	16V		ECEV1CS100SR	K48120001		
C 6041	TANTALUM CHIP CAP.	1uF	16V		TESVA1C105M1-8R	K78120009		
C 6042	CHIP CAP.	0.1uF	16V	B	GRM39B104K16PT	K22124805		
C 6043	CHIP CAP.	0.1uF	16V	B	GRM39B104K16PT	K22124805		
C 6044	AL.ELECTRO.CAP.	10uF	16V		ECEV1CS100SR	K48120001		
C 6045	CHIP CAP.	0.1uF	16V	B	GRM39B104K16PT	K22124805		
C 6046	TANTALUM CHIP CAP.	1uF	16V		TESVA1C105M1-8R	K78120009		
C 6047	CHIP CAP.	0.001uF	50V	B	GRM39B102M50PT	K22174809		
C 6048	CHIP CAP.	0.1uF	16V	B	GRM39B104K16PT	K22124805		
C 6049	CHIP CAP.	0.1uF	16V	B	GRM39B104K16PT	K22124805		
C 6050	CHIP CAP.	0.1uF	16V	B	GRM39B104K16PT	K22124805		
C 6051	CHIP CAP.	0.001uF	50V	B	GRM39B102M50PT	K22174809		

REF.	DESCRIPTION	VALUE	V/W	TOL.	MFR'S DESIG	YAESU P/N	VERS.	LOT.
C 6052	CHIP CAP.	0.1uF	16V	B	GRM39B104K16PT	K22124805		
C 6053	CHIP CAP.	0.1uF	16V	B	GRM39B104K16PT	K22124805		
C 6054	CHIP CAP.	0.0047uF	50V	B	GRM39B472M50PT	K22174817		2-
C 6055	CHIP CAP.	0.0012uF	50V	B	GRM39B122M50PT	K22174810		
C 6056	CHIP CAP.	0.001uF	50V	B	GRM39B102M50PT	K22174809		
C 6057	CHIP CAP.	0.001uF	50V	B	GRM39B102M50PT	K22174809		
C 6058	CHIP CAP.	0.001uF	50V	B	GRM39B102M50PT	K22174809		
C 6059	CHIP CAP.	0.001uF	50V	B	GRM39B102M50PT	K22174809		
D 6001	DIODE				DAN202K T146	G2070182		
J 6001	CONNECTOR				SC25-11WS	P0090630		
J 6002	CONNECTOR				SC25-07WS	P0090626		
Q 6001	IC				KIA7805PI	G1092261		
Q 6002	IC				TC7SU04F TE85R	G1092701		
Q 6003	IC				TMS27C256-12JL	G1091647		
Q 6004	IC				NJM2902M-T2	G1090908		
Q 6005	IC				AK4520A-VF(TAPING)	G1092640		
Q 6006	IC				RH5VL45AA-T1	G1090966		
Q 6007	IC				TC74HC4040AF TP2	G1091457		
Q 6008	IC				AS7C256-15JC(TAPING)	G1092718		
Q 6009	IC				TC74HC20AF(EL)	G1091504		
Q 6010	IC				TC7SU04F TE85R	G1092701		
Q 6011	IC				AS7C256-15JC(TAPING)	G1092718		
Q 6012	IC				TMS320C203P257	G1092641		
Q 6013	IC				AS7C256-15JC(TAPING)	G1092718		
Q 6014	IC				AS7C256-15JC(TAPING)	G1092718		
Q 6015	IC				TC7SH32FU TE85L	G1092729		
QS6001	IC SOCKET				IC99-2806-S4	P3090104		
R 6001	CHIP RES.	1kohm	1/16W	5%	RMC1/16 102JATP	J24185102		
R 6002	CHIP RES.	1kohm	1/16W	5%	RMC1/16 102JATP	J24185102		
R 6003	CHIP RES.	1kohm	1/16W	5%	RMC1/16 102JATP	J24185102		
R 6004	CHIP RES.	1kohm	1/16W	5%	RMC1/16 102JATP	J24185102		
R 6005	CHIP RES.	1kohm	1/16W	5%	RMC1/16 102JATP	J24185102		
R 6006	CHIP RES.	1kohm	1/16W	5%	RMC1/16 102JATP	J24185102		
R 6007	CHIP RES.	1kohm	1/16W	5%	RMC1/16 102JATP	J24185102		
R 6008	CHIP RES.	1kohm	1/16W	5%	RMC1/16 102JATP	J24185102		
R 6009	CHIP RES.	10kohm	1/16W	5%	RMC1/16 103JATP	J24185103		
R 6010	CHIP RES.	100kohm	1/16W	5%	RMC1/16 104JATP	J24185104		
R 6010	CHIP RES.	470kohm	1/16W	5%	RMC1/16 474JATP	J24185474		2-
R 6011	CHIP RES.	4.7ohm	1W	5%	RMC1 4R7JTE	J24305479		
R 6012	CHIP RES.	100kohm	1/16W	5%	RMC1/16 104JATP	J24185104		
R 6013	CHIP RES.	100kohm	1/16W	5%	RMC1/16 104JATP	J24185104		
R 6014	CHIP RES.	10kohm	1/16W	5%	RMC1/16 103JATP	J24185103		
R 6015	CHIP RES.	10ohm	1/16W	5%	RMC1/16 100JATP	J24185100		
R 6016	CHIP RES.	47ohm	1/16W	5%	RMC1/16 470JATP	J24185470		
R 6017	CHIP RES.	1Mohm	1/16W	5%	RMC1/16 105JATP	J24185105		
R 6018	CHIP RES.	10kohm	1/16W	5%	RMC1/16 103JATP	J24185103		
R 6019	CHIP RES.	120kohm	1/16W	5%	RMC1/16 124JATP	J24185124		
R 6020	CHIP RES.	47kohm	1/16W	5%	RMC1/16 473JATP	J24185473		
R 6021	CHIP RES.	220kohm	1/16W	5%	RMC1/16 224JATP	J24185224		
R 6022	CHIP RES.	100kohm	1/16W	5%	RMC1/16 104JATP	J24185104		
R 6023	CHIP RES.	220kohm	1/16W	5%	RMC1/16 224JATP	J24185224		
R 6024	CHIP RES.	10kohm	1/16W	5%	RMC1/16 103JATP	J24185103		
R 6025	CHIP RES.	470ohm	1/16W	5%	RMC1/16 471JATP	J24185471		
R 6026	CHIP RES.	470ohm	1/16W	5%	RMC1/16 471JATP	J24185471		
R 6027	CHIP RES.	4.7kohm	1/16W	5%	RMC1/16 472JATP	J24185472		
R 6028	CHIP RES.	3.3kohm	1/16W	5%	RMC1/16 332JATP	J24185332		

# DSP Unit

REF.	DESCRIPTION	VALUE	VW	TOL.	MFR'S DESIG	YAESU P/N	VERS.	LOT.
R 6029	CHIP RES.	1kohm	1/16W	5%	RMC1/16 102JATP	J24185102		
R 6030	CHIP RES.	2.2ohm	1/16W	5%	RMC1/16 2R2JATP	J24185229		
R 6031	CHIP RES.	1kohm	1/16W	5%	RMC1/16 102JATP	J24185102		
R 6032	CHIP RES.	100kohm	1/16W	5%	RMC1/16 104JATP	J24185104		
R 6033	CHIP RES.	4.7ohm	1/16W	5%	RMC1/16 4R7JATP	J24185479		
R 6034	CHIP RES.	1kohm	1/16W	5%	RMC1/16 102JATP	J24185102		
R 6035	CHIP RES.	1kohm	1/16W	5%	RMC1/16 102JATP	J24185102		
R 6036	CHIP RES.	1kohm	1/16W	5%	RMC1/16 102JATP	J24185102		
R 6037	CHIP RES.	1kohm	1/16W	5%	RMC1/16 102JATP	J24185102		
R 6038	CHIP RES.	1kohm	1/16W	5%	RMC1/16 102JATP	J24185102		
R 6039	CHIP RES.	1kohm	1/16W	5%	RMC1/16 102JATP	J24185102		
R 6040	CHIP RES.	1kohm	1/16W	5%	RMC1/16 102JATP	J24185102		
R 6041	CHIP RES.	47kohm	1/16W	5%	RMC1/16 473JATP	J24185473		
R 6042	CHIP RES.	47kohm	1/16W	5%	RMC1/16 473JATP	J24185473		
R 6043	CHIP RES.	47kohm	1/16W	5%	RMC1/16 473JATP	J24185473		
R 6044	CHIP RES.	47kohm	1/16W	5%	RMC1/16 473JATP	J24185473		
R 6045	CHIP RES.	47kohm	1/16W	5%	RMC1/16 473JATP	J24185473		
R 6046	CHIP RES.	47kohm	1/16W	5%	RMC1/16 473JATP	J24185473		
R 6047	CHIP RES.	47kohm	1/16W	5%	RMC1/16 473JATP	J24185473		
R 6048	CHIP RES.	4.7kohm	1/16W	5%	RMC1/16 472JATP	J24185472		
R 6049	CHIP RES.	4.7kohm	1/16W	5%	RMC1/16 472JATP	J24185472		
R 6050	CHIP RES.	4.7kohm	1/16W	5%	RMC1/16 472JATP	J24185472		
R 6051	CHIP RES.	4.7kohm	1/16W	5%	RMC1/16 472JATP	J24185472		
R 6052	CHIP RES.	4.7kohm	1/16W	5%	RMC1/16 472JATP	J24185472		
R 6053	CHIP RES.	100kohm	1/16W	5%	RMC1/16 104JATP	J24185104		2-
R 6054	CHIP RES.	82kohm	1/16W	5%	RMC1/16 823JATP	J24185823		
X 6001	XTAL UM-1	6.848MHz			6.848MHZ	H0103177		
Z 6001	LEAF SPRING					R0132100		



Circuit Diagram

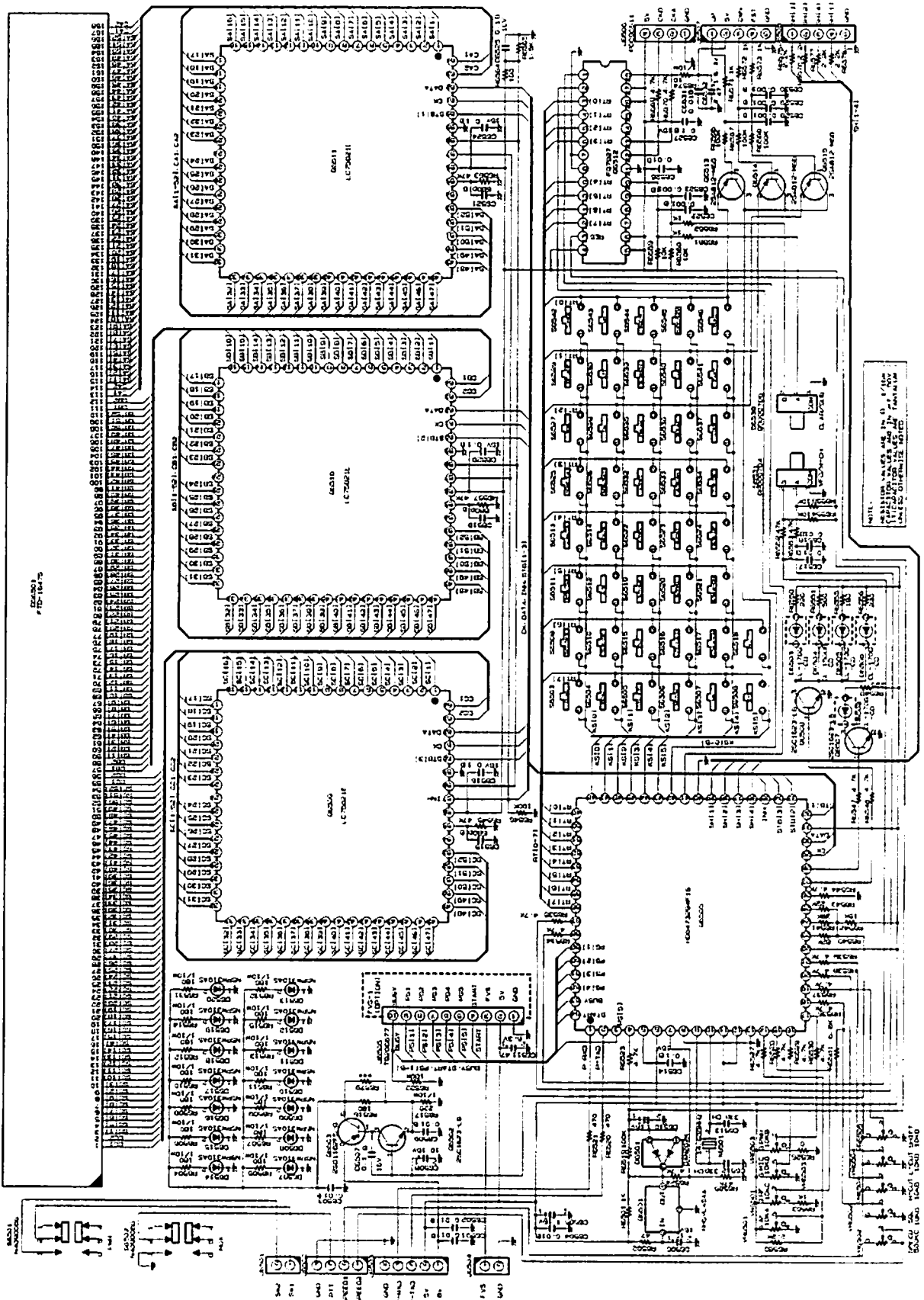

# Panel Unit

---

*Notes:*

Parts Layout

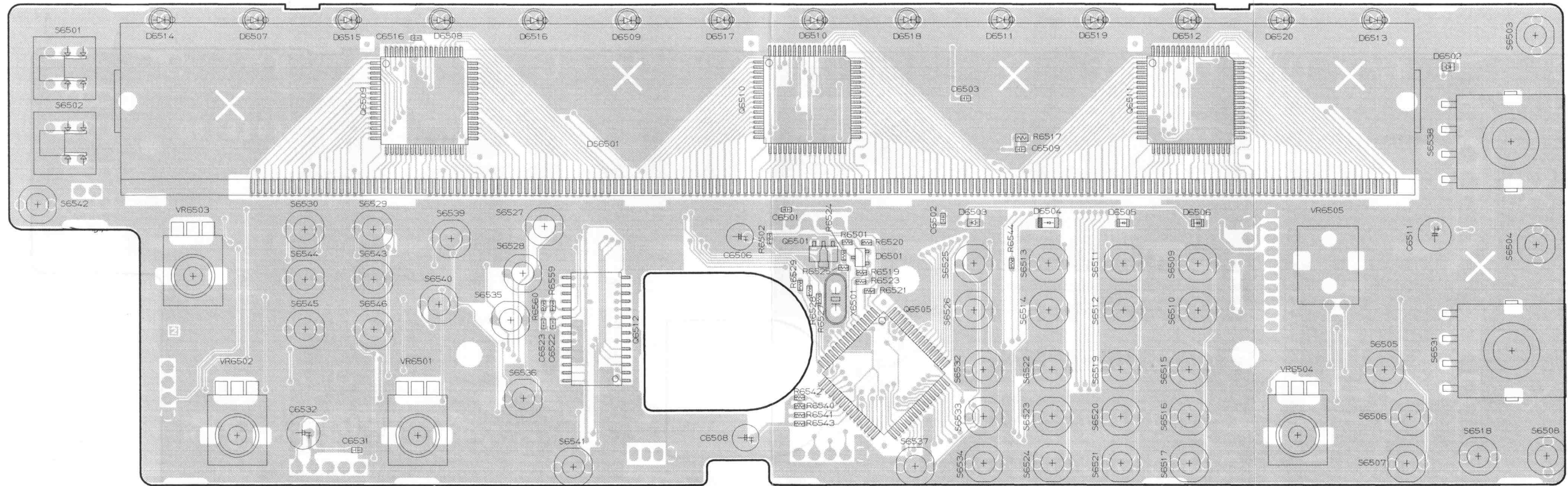

Component Side

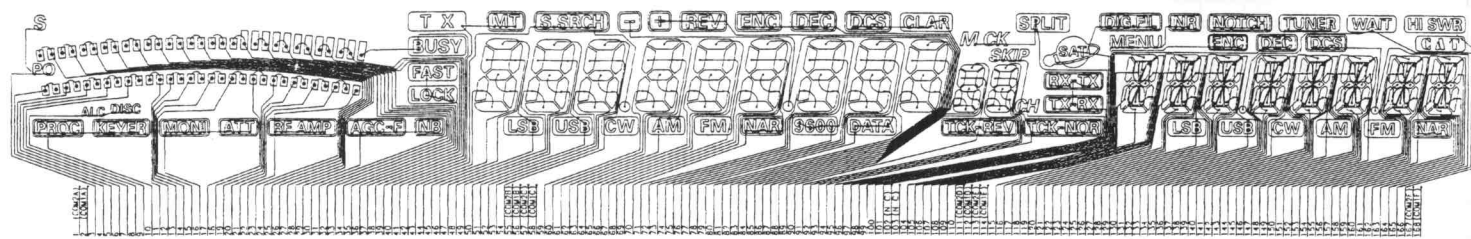
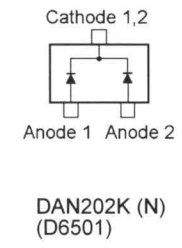
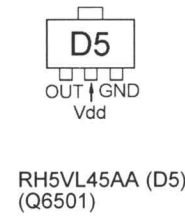
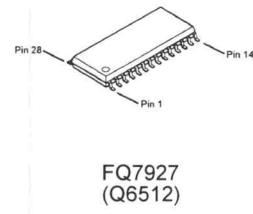
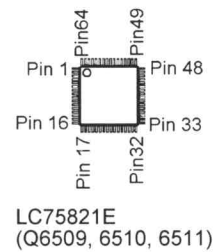
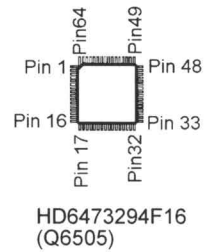

LCD Segmentation Circuit Diagram

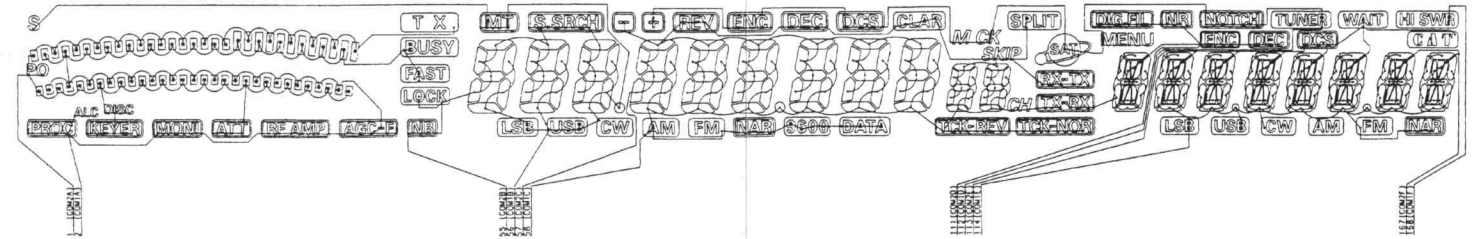

LCD Backplane Circuit Diagram

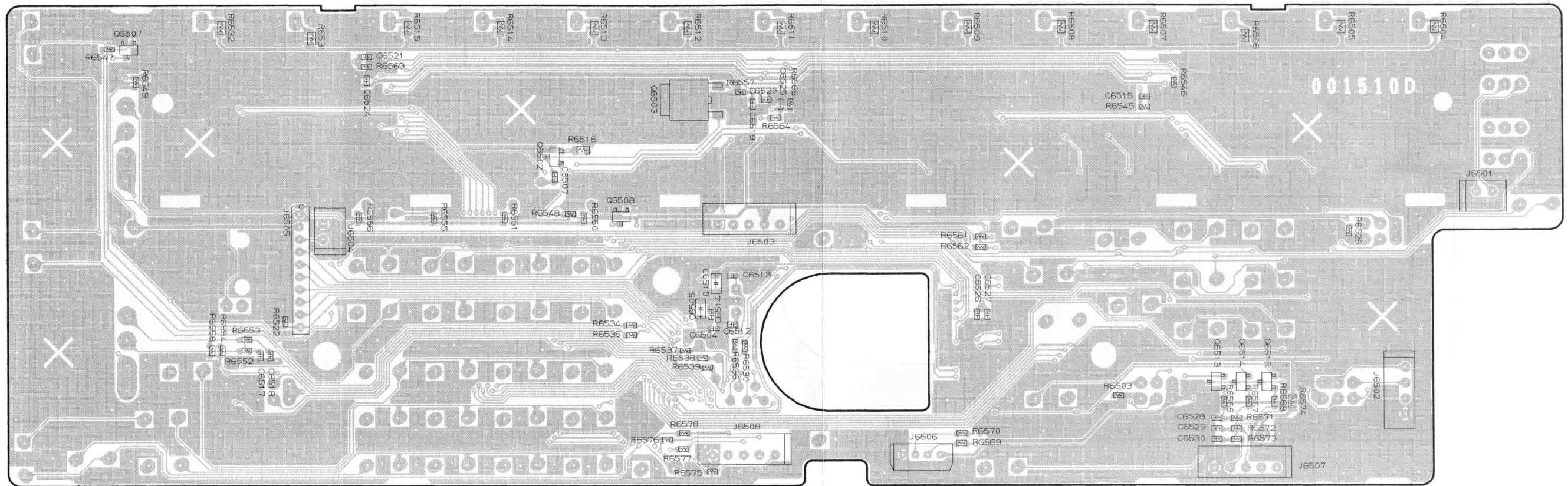

Chip Side

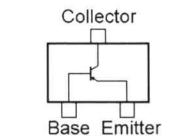

2SA812 (M6)  
(Q6513, 6514, 6515)

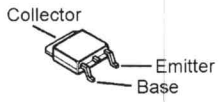

2SB1182Q  
(Q6503)

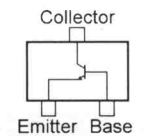

2SC1623 (L6)  
(Q6502, 6507, 6508)



## Parts List

REF.	DESCRIPTION	VALUE	V/W	TOL.	MFR'S DESIG	YAESU P/N	VERS.	LOT.
*** PANEL UNIT ***								
PCB with Components						CB0222001		
Printed Circuit Board						FR001750C		
C 6501	CHIP CAP.	0.01uF	50V	B	GRM39B103M50PT	K22174823		
C 6502	CHIP CAP.	0.01uF	50V	B	GRM39B103M50PT	K22174823		
C 6503	CHIP CAP.	0.01uF	50V	B	GRM39B103M50PT	K22174823		
C 6504	CHIP CAP.	0.01uF	50V	B	GRM39B103M50PT	K22174823		
C 6505	TANTALUM CHIP CAP.	1uF	16V		TESVA1C105M1-8R	K78120009		
C 6506	AL.ELECTRO.CAP.	10uF	16V		16V100M4X7TR2	K46120004		
C 6507	CHIP CAP.	0.1uF	16V	B	GRM39B104K16PT	K22124805		
C 6508	AL.ELECTRO.CAP.	10uF	16V		16V100M4X7TR2	K46120004		
C 6509	CHIP CAP.	0.01uF	50V	B	GRM39B103M50PT	K22174823		
C 6510	TANTALUM CHIP CAP.	1uF	16V		TESVA1C105M1-8R	K78120009		
C 6511	AL.ELECTRO.CAP.	47uF	6.3V		6V470M5X7TR2	K46080004		
C 6512	CHIP CAP.	33pF	50V	CH	GRM39CH330J50PT	K22174223		
C 6513	CHIP CAP.	33pF	50V	CH	GRM39CH330J50PT	K22174223		
C 6514	CHIP CAP.	0.1uF	16V	B	GRM39B104K16PT	K22124805		
C 6515	CHIP CAP.	680pF	50V	B	GRM39B681M50PT	K22174807		
C 6516	CHIP CAP.	0.1uF	16V	B	GRM39B104K16PT	K22124805		
C 6517	CHIP CAP.	0.01uF	50V	B	GRM39B103M50PT	K22174823		
C 6518	CHIP CAP.	0.01uF	50V	B	GRM39B103M50PT	K22174823		
C 6519	CHIP CAP.	680pF	50V	B	GRM39B681M50PT	K22174807		
C 6520	CHIP CAP.	0.1uF	16V	B	GRM39B104K16PT	K22124805		
C 6521	CHIP CAP.	680pF	50V	B	GRM39B681M50PT	K22174807		
C 6522	CHIP CAP.	0.001uF	50V	B	GRM39B102M50PT	K22174809		
C 6523	CHIP CAP.	0.001uF	50V	B	GRM39B102M50PT	K22174809		
C 6524	CHIP CAP.	0.1uF	16V	B	GRM39B104K16PT	K22124805		
C 6525	CHIP CAP.	0.1uF	16V	B	GRM39B104K16PT	K22124805		
C 6526	CHIP CAP.	0.01uF	50V	B	GRM39B103M50PT	K22174823		
C 6527	CHIP CAP.	0.1uF	16V	B	GRM39B104K16PT	K22124805		
C 6528	CHIP CAP.	0.001uF	50V	B	GRM39B102M50PT	K22174809		
C 6529	CHIP CAP.	0.001uF	50V	B	GRM39B102M50PT	K22174809		
C 6530	CHIP CAP.	0.001uF	50V	B	GRM39B102M50PT	K22174809		
C 6531	CHIP CAP.	0.01uF	50V	B	GRM39B103M50PT	K22174823		
C 6532	AL.ELECTRO.CAP.	47uF	6.3V		6V470M5X7TR2	K46080004		
D 6501	DIODE				DAN202K T146	G2070182		
D 6502	LED				CL-170G-CD-T	G2070226		
D 6503	LED				CL-170G-CD-T	G2070226		
D 6504	LED				CL-150UR-CD-T	G2070234		
D 6505	LED				CL-170D-CD-T	G2070344		
D 6506	LED				CL-170D-CD-T	G2070344		
D 6507	LED				NSPW310AS	G2090705		
D 6508	LED				NSPW310AS	G2090705		
D 6509	LED				NSPW310AS	G2090705		
D 6510	LED				NSPW310AS	G2090705		
D 6511	LED				NSPW310AS	G2090705		
D 6512	LED				NSPW310AS	G2090705		
D 6513	LED				NSPW310AS	G2090705		
D 6514	LED				NSPW310AS	G2090705		
D 6515	LED				NSPW310AS	G2090705		
D 6516	LED				NSPW310AS	G2090705		
D 6517	LED				NSPW310AS	G2090705		
D 6518	LED				NSPW310AS	G2090705		
D 6519	LED				NSPW310AS	G2090705		
D 6520	LED				NSPW310AS	G2090705		
DS6501	LCD				FTD-16475	G6090128		

# Panel Unit

REF.	DESCRIPTION	VALUE	V/W	TOL.	MFR'S DESIG	YAESU P/N	VERS.	LOT.
J 6501	CONNECTOR				SC25-02WS	P0090621		
J 6502	CONNECTOR				SC25-04WS	P0090623		
J 6503	CONNECTOR				SC25-05WS	P0090624		
J 6504	CONNECTOR				SC25-02WS	P0090621		
J 6505	WIRE ASSY				A1179	T9206677		
J 6506	CONNECTOR				SB20-04WS	P0090611		
J 6507	CONNECTOR				SC25-05WS	P0090624		
J 6508	CONNECTOR				SC25-05WS	P0090624		
Q 6501	IC				RH5VL45AA-T1	G1090966		
Q 6502	TRANSISTOR				2SC1623-T2BL6	G3316237F		
Q 6503	TRANSISTOR				2SB1182-TLQ	G3070063		
Q 6505	IC				HD6473294F16	G1092797		
Q 6507	TRANSISTOR				2SC1623-T2BL6	G3316237F		
Q 6508	TRANSISTOR				2SC1623-T2BL6	G3316237F		
Q 6509	IC				LC75821E	G1092191		
Q 6510	IC				LC75821E	G1092191		
Q 6511	IC				LC75821E	G1092191		
Q 6512	IC				FQ7927	G1091854		
Q 6513	TRANSISTOR				2SA812-T2B M6B	G3108127F		
Q 6514	TRANSISTOR				2SA812-T2B M6B	G3108127F		
Q 6515	TRANSISTOR				2SA812-T2B M6B	G3108127F		
R 6501	CHIP RES.	1kohm	1/16W	5%	RMC1/16 102JATP	J24185102		
R 6502	CHIP RES.	47ohm	1/16W	5%	RMC1/16 470JATP	J24185470		
R 6503	CHIP RES.	1kohm	1/16W	5%	RMC1/16 102JATP	J24185102		
R 6504	CHIP RES.	180ohm	1/10W	5%	RMC1/10T 181J	J24205181		
R 6505	CHIP RES.	180ohm	1/10W	5%	RMC1/10T 181J	J24205181		
R 6506	CHIP RES.	180ohm	1/10W	5%	RMC1/10T 181J	J24205181		
R 6507	CHIP RES.	180ohm	1/10W	5%	RMC1/10T 181J	J24205181		
R 6508	CHIP RES.	180ohm	1/10W	5%	RMC1/10T 181J	J24205181		
R 6509	CHIP RES.	180ohm	1/10W	5%	RMC1/10T 181J	J24205181		
R 6510	CHIP RES.	180ohm	1/10W	5%	RMC1/10T 181J	J24205181		
R 6511	CHIP RES.	180ohm	1/10W	5%	RMC1/10T 181J	J24205181		
R 6512	CHIP RES.	180ohm	1/10W	5%	RMC1/10T 181J	J24205181		
R 6513	CHIP RES.	180ohm	1/10W	5%	RMC1/10T 181J	J24205181		
R 6514	CHIP RES.	180ohm	1/10W	5%	RMC1/10T 181J	J24205181		
R 6515	CHIP RES.	180ohm	1/10W	5%	RMC1/10T 181J	J24205181		
R 6516	CHIP RES.	180ohm	1/10W	5%	RMC1/10T 181J	J24205181		
R 6517	CHIP RES.	220ohm	1/10W	5%	RMC1/10T 221J	J24205221		
R 6519	CHIP RES.	100kohm	1/16W	5%	RMC1/16 104JATP	J24185104		
R 6522	CHIP RES.	100kohm	1/16W	5%	RMC1/16 104JATP	J24185104		
R 6523	CHIP RES.	4.7kohm	1/16W	5%	RMC1/16 472JATP	J24185472		
R 6524	CHIP RES.	4.7kohm	1/16W	5%	RMC1/16 472JATP	J24185472		
R 6525	CHIP RES.	47kohm	1/16W	5%	RMC1/16 473JATP	J24185473		
R 6526	CHIP RES.	0ohm	1/16W	5%	RMC1/16 000JATP	J24185000		
R 6527	CHIP RES.	4.7kohm	1/16W	5%	RMC1/16 472JATP	J24185472		
R 6528	CHIP RES.	4.7kohm	1/16W	5%	RMC1/16 472JATP	J24185472		
R 6529	CHIP RES.	4.7kohm	1/16W	5%	RMC1/16 472JATP	J24185472		
R 6530	CHIP RES.	4.7kohm	1/16W	5%	RMC1/16 472JATP	J24185472		
R 6531	CHIP RES.	180ohm	1/10W	5%	RMC1/10T 181J	J24205181		
R 6532	CHIP RES.	180ohm	1/10W	5%	RMC1/10T 181J	J24205181		
R 6534	CHIP RES.	4.7kohm	1/16W	5%	RMC1/16 472JATP	J24185472		
R 6535	CHIP RES.	4.7kohm	1/16W	5%	RMC1/16 472JATP	J24185472		
R 6536	CHIP RES.	4.7kohm	1/16W	5%	RMC1/16 472JATP	J24185472		
R 6537	CHIP RES.	4.7kohm	1/16W	5%	RMC1/16 472JATP	J24185472		
R 6538	CHIP RES.	4.7kohm	1/16W	5%	RMC1/16 472JATP	J24185472		
R 6539	CHIP RES.	4.7kohm	1/16W	5%	RMC1/16 472JATP	J24185472		

REF.	DESCRIPTION	VALUE	V/W	TOL.	MFR'S DESIG	YAESU P/N	VERS.	LOT.
R 6540	CHIP RES.	82kohm	1/16W	5%	RMC1/16 823JATP	J24185823		
R 6541	CHIP RES.	39kohm	1/16W	5%	RMC1/16 393JATP	J24185393		
R 6542	CHIP RES.	15kohm	1/16W	5%	RMC1/16 153JATP	J24185153		
R 6543	CHIP RES.	22kohm	1/16W	5%	RMC1/16 223JATP	J24185223		
R 6544	CHIP RES.	4.7kohm	1/16W	5%	RMC1/16 472JATP	J24185472		
R 6545	CHIP RES.	47kohm	1/16W	5%	RMC1/16 473JATP	J24185473		
R 6546	CHIP RES.	100kohm	1/16W	5%	RMC1/16 104JATP	J24185104		
R 6547	CHIP RES.	4.7kohm	1/16W	5%	RMC1/16 472JATP	J24185472		
R 6548	CHIP RES.	4.7kohm	1/16W	5%	RMC1/16 472JATP	J24185472		
R 6549	CHIP RES.	220ohm	1/16W	5%	RMC1/16 221JATP	J24185221		
R 6550	CHIP RES.	220ohm	1/16W	5%	RMC1/16 221JATP	J24185221		
R 6551	CHIP RES.	560ohm	1/16W	5%	RMC1/16 561JATP	J24185561		
R 6552	CHIP RES.	47kohm	1/16W	5%	RMC1/16 473JATP	J24185473		
R 6553	CHIP RES.	47kohm	1/16W	5%	RMC1/16 473JATP	J24185473		
R 6554	CHIP RES.	10kohm	1/16W	5%	RMC1/16 103JATP	J24185103		
R 6555	CHIP RES.	180ohm	1/16W	5%	RMC1/16 181JATP	J24185181		
R 6556	CHIP RES.	220ohm	1/16W	5%	RMC1/16 221JATP	J24185221		
R 6557	CHIP RES.	47kohm	1/16W	5%	RMC1/16 473JATP	J24185473		
R 6558	CHIP RES.	10kohm	1/16W	5%	RMC1/16 103JATP	J24185103		
R 6559	CHIP RES.	10kohm	1/16W	5%	RMC1/16 103JATP	J24185103		
R 6560	CHIP RES.	10kohm	1/16W	5%	RMC1/16 103JATP	J24185103		
R 6561	CHIP RES.	1kohm	1/16W	5%	RMC1/16 102JATP	J24185102		
R 6562	CHIP RES.	1kohm	1/16W	5%	RMC1/16 102JATP	J24185102		
R 6563	CHIP RES.	47kohm	1/16W	5%	RMC1/16 473JATP	J24185473		
R 6564	CHIP RES.	100ohm	1/16W	5%	RMC1/16 101JATP	J24185101		
R 6565	CHIP RES.	1.5kohm	1/16W	5%	RMC1/16 152JATP	J24185152		
R 6566	CHIP RES.	100kohm	1/16W	5%	RMC1/16 104JATP	J24185104		
R 6567	CHIP RES.	100kohm	1/16W	5%	RMC1/16 104JATP	J24185104		
R 6568	CHIP RES.	100kohm	1/16W	5%	RMC1/16 104JATP	J24185104		
R 6569	CHIP RES.	4.7kohm	1/16W	5%	RMC1/16 472JATP	J24185472		
R 6570	CHIP RES.	4.7kohm	1/16W	5%	RMC1/16 472JATP	J24185472		
R 6571	CHIP RES.	1kohm	1/16W	5%	RMC1/16 102JATP	J24185102		
R 6572	CHIP RES.	1kohm	1/16W	5%	RMC1/16 102JATP	J24185102		
R 6573	CHIP RES.	1kohm	1/16W	5%	RMC1/16 102JATP	J24185102		
R 6574	CHIP RES.	10ohm	1/10W	5%	RMC1/10T 100J	J24205100		
R 6575	CHIP RES.	2.2kohm	1/16W	5%	RMC1/16 222JATP	J24185222		
R 6576	CHIP RES.	2.2kohm	1/16W	5%	RMC1/16 222JATP	J24185222		
R 6577	CHIP RES.	2.2kohm	1/16W	5%	RMC1/16 222JATP	J24185222		
R 6578	CHIP RES.	2.2kohm	1/16W	5%	RMC1/16 222JATP	J24185222		
R 6580	CHIP RES.	2.2kohm	1/16W	5%	RMC1/16 222JATP	J24185222		
R 6581	CHIP RES.	6.8kohm	1/10W	5%	RMC1/10T 682J	J24205682		
S 6501	PUSH SWITCH				SPH121A94	N4090086		
S 6502	PUSH SWITCH				SPH121A94	N4090086		
S 6503	TACT SWITCH				EVQ11L09K	N5090101		
S 6504	TACT SWITCH				EVQ11L09K	N5090101		
S 6505	TACT SWITCH				EVQ11L09K	N5090101		
S 6506	TACT SWITCH				EVQ11L09K	N5090101		
S 6507	TACT SWITCH				EVQ11L09K	N5090101		
S 6508	TACT SWITCH				EVQ11L09K	N5090101		
S 6509	TACT SWITCH				EVQ11L09K	N5090101		
S 6510	TACT SWITCH				EVQ11L09K	N5090101		
S 6511	TACT SWITCH				EVQ11L09K	N5090101		
S 6512	TACT SWITCH				EVQ11L09K	N5090101		
S 6513	TACT SWITCH				EVQ11L09K	N5090101		
S 6514	TACT SWITCH				EVQ11L09K	N5090101		
S 6515	TACT SWITCH				EVQ11L09K	N5090101		

# Panel Unit

REF.	DESCRIPTION	VALUE	V/W	TOL.	MFR'S DESIG	YAESU P/N	VERS.	LOT.
S 6516	TACT SWITCH				EVQ11L09K	N5090101		
S 6517	TACT SWITCH				EVQ11L09K	N5090101		
S 6518	TACT SWITCH				EVQ11L09K	N5090101		
S 6519	TACT SWITCH				EVQ11L09K	N5090101		
S 6520	TACT SWITCH				EVQ11L09K	N5090101		
S 6521	TACT SWITCH				EVQ11L09K	N5090101		
S 6522	TACT SWITCH				EVQ11L09K	N5090101		
S 6523	TACT SWITCH				EVQ11L09K	N5090101		
S 6524	TACT SWITCH				EVQ11L09K	N5090101		
S 6525	TACT SWITCH				EVQ11L09K	N5090101		
S 6526	TACT SWITCH				EVQ11L09K	N5090101		
S 6527	TACT SWITCH				EVQ11L09K	N5090101		
S 6528	TACT SWITCH				EVQ11L09K	N5090101		
S 6529	TACT SWITCH				EVQ11L09K	N5090101		
S 6530	TACT SWITCH				EVQ11L09K	N5090101		
S 6531	ROTARY ENCODER				EVQVEMF0324B	Q9000704		
S 6532	TACT SWITCH				EVQ11L09K	N5090101		
S 6533	TACT SWITCH				EVQ11L09K	N5090101		
S 6534	TACT SWITCH				EVQ11L09K	N5090101		
S 6535	TACT SWITCH				EVQ11L09K	N5090101		
S 6536	TACT SWITCH				EVQ11L09K	N5090101		
S 6537	TACT SWITCH				EVQ11L09K	N5090101		
S 6538	ROTARY ENCODER				EVQVEJF0324B	Q9000706		
S 6539	TACT SWITCH				EVQ11L09K	N5090101		
S 6540	TACT SWITCH				EVQ11L09K	N5090101		
S 6541	TACT SWITCH				EVQ11L09K	N5090101		
S 6542	TACT SWITCH				EVQ11L09K	N5090101		
S 6543	TACT SWITCH				EVQ11L09K	N5090101		
S 6544	TACT SWITCH				EVQ11L09K	N5090101		
S 6545	TACT SWITCH				EVQ11L09K	N5090101		
S 6546	TACT SWITCH				EVQ11L09K	N5090101		
VR6501	POT.				RH96D190 10KA/10KC	J62800135		
VR6502	POT.				RH96D190 10KB/500KC	J62800136		
VR6503	POT.				RH96D190 10KB/10KB	J62800134		
VR6504	POT.				RH96D190 10KB/10KB	J62800134		
VR6505	POT.				EVU-F2JFL3B14 10KB	J60800234		
X 6501	XTAL UM-1	14.855MHz			14.855MHZ	H0103178		
Z 6501	INTER CONNECTOR					RA0061400		
Z 6502	LCD HOLDER					RA0062700		
Z 6503	LIGHT GUIDE					RA0062300		
Z 6504	COLOR FILTER					RA0075000		
Z 6505	LCD FILTER					RA0072700		
Z 6506	REFLECTOR SHEET					RA0072800		
Z 6507	LIGHT SHEET				(L)	RA0073300		
Z 6508	LIGHT SHEET (2pcs)				(S)	RA0073400		
Z 6509	LED SPACER (14pcs)				LH-5-2	S6000235		
Z 6510	SPONGE RUBBER (4pcs)					R7132721		
Z 6512	LIGHT SHEET				(R)	RA0086200		2-
Z 6515	BLIND SHEET					RA0057900		2-



# SSB-Filter Unit

## Circuit Diagram

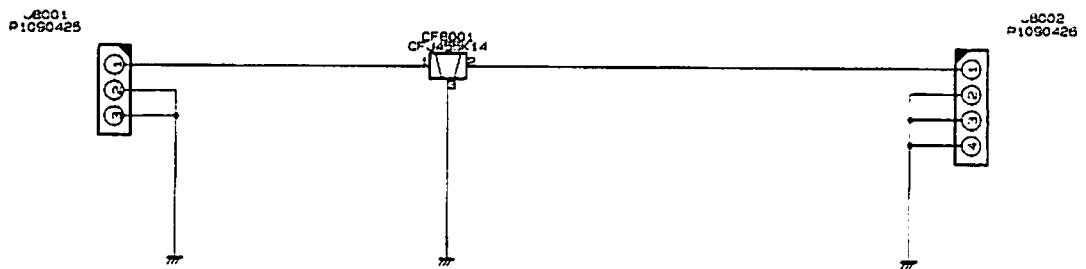

## Parts Layout



Component Side

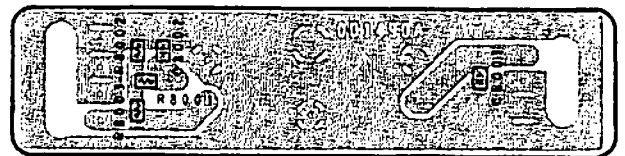

Chip Side

## Parts List

REF.	DESCRIPTION	VALUE	V/W	TOL.	MFR'S DESIG	YAESU P/N	VERS.	LOT.
*** SSB-FILTER UNIT ***								
PCB with Components						CB0347001		
Printed Circuit Board						FR001530A		
CF8001	CERAMIC FILTER				CFJ455K14	H3900386		
J 8001	CONNECTOR				5124-03BHPB	P1090425		
J 8002	CONNECTOR				5124-04BHPB	P1090426		

# SSB-Filter Unit

---

*Notes:*

# Phone-Jack Unit

## Circuit Diagram

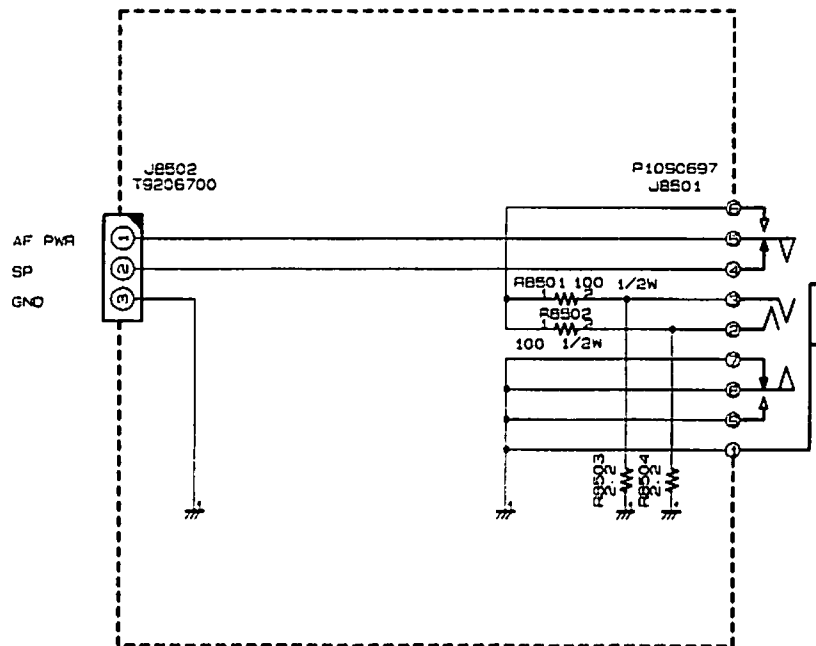

## Parts Layout

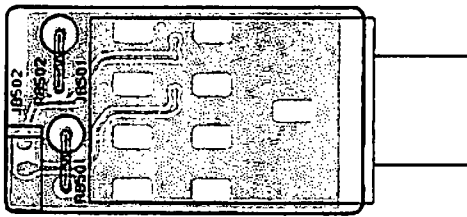

Component Side

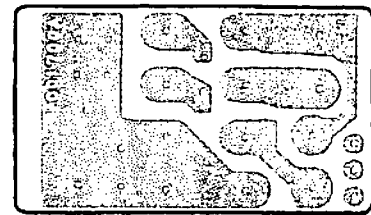

Solder Side

## Parts List

REF.	DESCRIPTION	VALUE	V/W	TOL.	MFR'S DESIG	YAESU P/N	VERS.	LOT.
*** PHONE-JACK UNIT ***								
PCB with Components						CB0391001		
Printed Circuit Board						FR001750C		
J 8501	CONNECTOR				S-G4617#02	P1090697		
J 8502	WIRE ASSY				A1179	T9206700		
R 8501	CARBON FILM RES.	100ohm	1/2W	5%	RD12TJ101 100	J01275101		
R 8502	CARBON FILM RES.	100ohm	1/2W	5%	RD12TJ101 100	J01275101		
R 8503	CARBON FILM RES.	2.2ohm	1/6W	5%	RD16TPJ2R2 2.2	J07225229		
R 8504	CARBON FILM RES.	2.2ohm	1/6W	5%	RD16TPJ2R2 2.2	J07225229		

# Phone-Jack Unit

---

*Notes:*

## Circuit Diagram

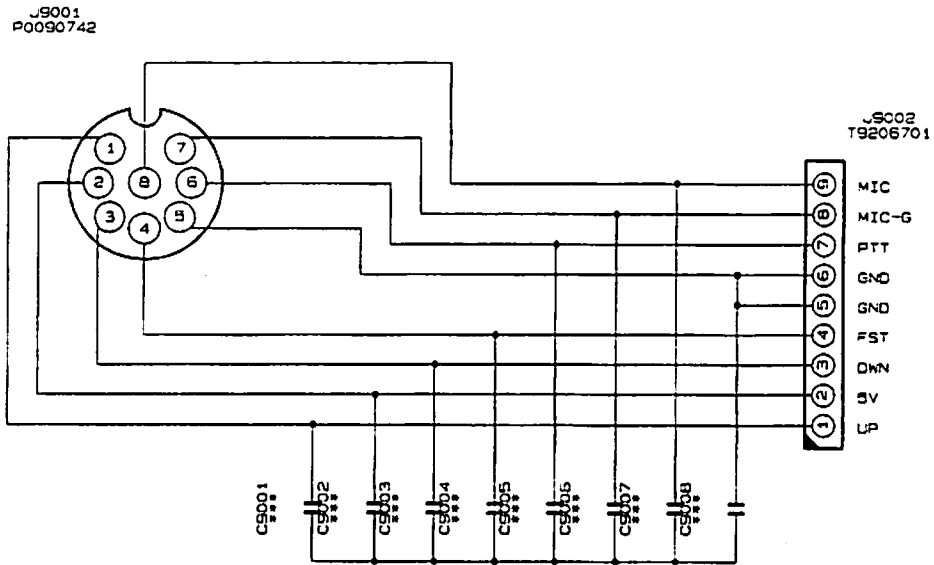

## Parts Layout

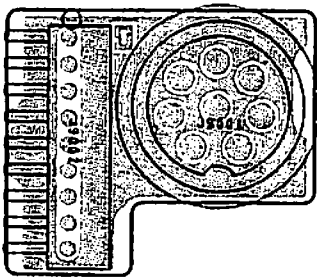

Component Side

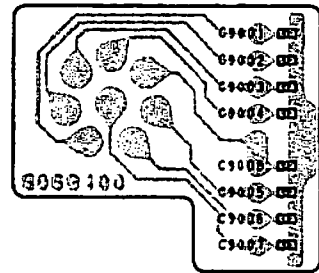

Chip Side

## Parts List

REF.	DESCRIPTION	VALUE	V/W	TOL.	MFR'S DESIG	YAESU P/N	VERS.	LOT.
*** MIC UNIT ***								
	PCB with Components					CB0426001		
	Printed Circuit Board					FR001900B		
J 9001	CONNECTOR				FM214-8SMPT-1	P0090742		
J 9002	WIRE ASSY				A1179	T9206701		
J 9002	WIRE ASSY				A1179	T9206701A		2-

# Mic Unit

---

*Notes:*

# **YAESU**

*...leading the way.<sup>SM</sup>*

Copyright © 1998  
Yaesu Musen Co., Ltd.  
All rights reserved

No portion of this manual may be  
reproduced without the permission  
of Yaesu Musen Co., Ltd.