

Oct. 2008



SERVICE MANUAL ADDENDUM

IC-7700

CONTENTS

PARTS LIST	1
BOARD LAYOUTS (MAIN AND SCOPE UNITS) ...	43
VOLTAGE DIAGRAM	45

SECTION 5 PARTS LIST

[RF UNIT]

REF NO.	ORDER NO.	DESCRIPTION	M.	H/V LOCATION
IC101	1130011510	S.IC BU2099FV-E2	T	146.4/152.3
IC102	1130011510	S.IC BU2099FV-E2	T	153.5/152.3
IC501	1110006100	S.IC NJM5534MD-TE1	T	156.6/40.9
IC502	1110006100	S.IC NJM5534MD-TE1	T	144.4/40.9
IC503	1110005461	S.IC TA4107F (TE12L,F)	T	133.6/40.9
IC1051	1190002010	S.IC SD5400CY <TOMO>	T	7.1/100.2
IC1081	1110006180	S.IC UPG2009TB-E3	T	39/91.7
IC1402	1190002110	S.IC NJG1519KC1-TE3	T	30.5/49.3
IC1403	1190002110	S.IC NJG1519KC1-TE3	T	30/4.2
IC1501	1110006121	S.IC DBM9A41-G-TR	T	88/15.3
IC1502	1110006121	S.IC DBM9A41-G-TR	T	96.5/15.3
IC1503	1110006100	S.IC NJM5534MD-TE1	T	119.2/7.5
IC1504	1110006100	S.IC NJM5534MD-TE1	T	119.2/25.9
IC1505	1110006190	S.IC NJM074M-TE1	T	136.2/16.7
IC1506	1110006100	S.IC NJM5534MD-TE1	T	147.6/19.3
IC1651	1130011921	S.IC TC74LX00F (EL,F)	T	89.7/26.5
IC1652	1110005420	S.IC BA15532F-E2	T	147.6/8.7
IC1653	1110005100	S.IC NJM072BM-TE1	B	156/8.7
IC1701	1130011530	S.IC CD74HC4094M96	T	129/142.5
IC1702	1130011530	S.IC CD74HC4094M96	T	129/133
IC1703	1160000131	S.IC TD62783AFG (S,EL)	T	117.3/143.1
IC1704	1180000790	S.IC AN78L10M (E1)	T	65.4/27.8
IC1901	1160000131	S.IC TD62783AFG (S,EL)	T	140.9/119.5
IC1902	1160000131	S.IC TD62783AFG (S,EL)	T	154.5/119.5
IC1903	1130011530	S.IC CD74HC4094M96	T	143.7/131.5
IC1904	1130011530	S.IC CD74HC4094M96	T	157.3/131.5
Q260	1590001330	S.TR DTA114EUA T106	T	63.8/211.2
Q320	1590001330	S.TR DTA114EUA T106	B	63.8/211.4
Q381	1590000680	S.TR DTC114EUA T106	B	86.4/237
Q383	1590000680	S.TR DTC114EUA T106	B	106.6/231.2
Q384	1590000680	S.TR DTC114EUA T106	B	110/231.2
Q385	1590000680	S.TR DTC114EUA T106	B	101.5/240
Q386	1590000680	S.TR DTC114EUA T106	B	105.4/236.8
Q387	1590000680	S.TR DTC114EUA T106	B	86.4/234.1
Q401	1530002841	S.TR 2SC4116-Y (TE85R,F)	B	50.8/233.9
Q402	1530002060	S.TR 2SC4081 T106 R	B	54.2/236.2
Q403	1590001330	S.TR DTA114EUA T106	B	54.2/233.4
Q404	1590000680	S.TR DTC114EUA T106	B	50.8/236.7
Q421	1590000680	S.TR DTC114EUA T106	B	88.8/145.7
Q422	1590000680	S.TR DTC114EUA T106	B	92.3/145.6
Q501	1580000751	S.FET 3SK294 (TE85L,F)	T	123.7/42.5
Q502	1590000680	S.TR DTC114EUA T106	B	118.1/52.2
Q503	1590002710	S.TR UMH11NTN	T	118/52.5
Q504	1560000561	S.FET 2SK882-GR (TE85L,F)	B	109.2/59
Q506	1560000561	S.FET 2SK882-GR (TE85L,F)	B	106.7/99.1
Q507	1530003151	S.TR 2SC4673D-TD-E	B	87.2/118.2
Q508	1530003841	S.TR 2SC5501-4-TR-E	B	121.7/120
Q509	1590001960	S.TR XP4311 (TX)	T	123.2/51.3
Q801	1530003851	S.TR 2SC5551F-TD-E	B	162.2/68.6
Q802	1520000531	S.TR 2SB1119S-TD-E	B	159/97.5
Q803	1590000680	S.TR DTC114EUA T106	B	166.6/96.9
Q804	1590002710	S.TR UMH11NTN	T	158.9/59.4
Q805	1590000680	S.TR DTM114EUA T106	T	157.3/56.6
Q901	1590001960	S.TR XP4311 (TX)	T	77.5/142.3
Q902	1530003851	S.TR 2SC5551F-TD-E	B	65/139.3
Q1005	1590001960	S.TR XP4311 (TX)	T	41.6/141.6
Q1006	1530003851	S.TR 2SC5551F-TD-E	B	25.9/142.3
Q1007	1530003851	S.TR 2SC5551F-TD-E	B	35.4/130.6
Q1008	1530003851	S.TR 2SC5551F-TD-E	B	35.4/116.8
Q1101	1530003860	TR 2SC3950D		
Q1102	1590000680	S.TR DTC114EUA T106	T	18.5/66.3
Q1103	1520000561	S.TR 2SB1123 T-TD-E	B	15.4/72.3
Q1104	1530003860	TR 2SC3950D		
Q1105	1530003841	S.TR 2SC5501-4-TR-E	T	17.5/58
Q1205	1590001960	S.TR XP4311 (TX)	T	21.2/135.7
Q1209	1530003851	S.TR 2SC5551F-TD-E	B	50.3/109.5
Q1210	1530003851	S.TR 2SC5551F-TD-E	B	64.5/109.5
Q1211	1560001311	S.FET MMBFU310LT1G	T	28/90.6
Q1212	1560001311	S.FET MMBFU310LT1G	T	34/90.6
Q1213	1590000680	S.TR DTC114EUA T106	B	30/63.2
Q1214	1520000561	S.TR 2SB1123 T-TD-E	B	32/73.4
Q1301	1530003151	S.TR 2SC4673D-TD-E	T	29.7/66.1
Q1352	1530003851	S.TR 2SC5551F-TD-E	B	60.9/77.5
Q1401	1530003841	S.TR 2SC5501-4-TR-E	B	58.4/15
Q1402	1530003021	S.TR 2SC4402-3-TL-E	T	64.7/17.8
Q1403	1530003021	S.TR 2SC4402-3-TL-E	T	64.7/10.9
Q1501	1530003450	S.TR 2SC4835-R (TX)	T	110.2/8.6
Q1502	1530003450	S.TR 2SC4835-R (TX)	T	110.2/20.8
Q1651	1530002601	S.TR 2SC4215-O (TE85R,F)	B	98.3/35.1
Q1701	1590001960	S.TR XP4311 (TX)	T	72.7/98.9
Q1702	1590001960	S.TR XP4311 (TX)	T	54.7/52
Q1703	1590001960	S.TR XP4311 (TX)	T	54.7/54.5
Q2001	1530002060	S.TR 2SC4081 T106 R	B	160.7/233.8
Q2002	1590001330	S.TR DTA114EUA T106	B	146.5/142.6
D1	1790001250	S.DIO MA2S111-(TX)	B	147/218.8
D21	1790001250	S.DIO MA2S111-(TX)	B	131.5/218.8
D51	1790001250	S.DIO MA2S111-(TX)	B	116/218.8
D81	1790001250	S.DIO MA2S111-(TX)	B	100.6/218.8
D111	1790001250	S.DIO MA2S111-(TX)	B	85/218.8
D141	1790001250	S.DIO MA2S111-(TX)	B	69.5/218.8
D171	1790001250	S.DIO MA2S111-(TX)	B	50/218.8
D201	1790001250	S.DIO MA2S111-(TX)	B	34.5/218.8
D231	1790001250	S.DIO MA2S111-(TX)	B	19.1/218.8
D260	1750000581	S.DIO 1SV307 (TPH3,F)	T	65.1/175.7

[RF UNIT]

REF NO.	ORDER NO.	DESCRIPTION	M.	H/V LOCATION
D261	1790001250	S.DIO MA2S111-(TX)	B	3.8/218.8
D262	1750000581	S.DIO 1SV307 (TPH3,F)	T	65/204.5
D320	1750000581	S.DIO 1SV307 (TPH3,F)	B	65.1/175.7
D321	1750000581	S.DIO 1SV307 (TPH3,F)	B	65/204.5
D351	1790001250	S.DIO MA2S111-(TX)	B	87/227.1
D352	1790001250	S.DIO MA2S111-(TX)	B	83.1/233.5
D353	1790001250	S.DIO MA2S111-(TX)	B	72.6/227.1
D373	1790001250	S.DIO MA2S111-(TX)	B	78.5/242.3
D391	1750000581	S.DIO 1SV307 (TPH3,F)	B	95.7/233
D392	1750000581	S.DIO 1SV307 (TPH3,F)	B	95.7/236.5
D393	1750000581	S.DIO 1SV307 (TPH3,F)	B	92.7/236.5
D401	1790001250	S.DIO MA2S111-(TX)	B	50.9/228.5
D402	1790000980	S.DIO MA742 (TX)	B	46.1/235.1
D410	1790001250	S.DIO MA2S111-(TX)	B	37/224.9
D421	1790000620	S.DIO MA77 (TX)	B	86/143
D422	1790000620	S.DIO MA77 (TX)	B	95/143
D423	1790000620	S.DIO MA77 (TX)	B	88.7/136.9
D424	1790000620	S.DIO MA77 (TX)	B	92.5/136.9
D431	1790001250	S.DIO MA2S111-(TX)	B	30.9/224.9
D501	1790000620	S.DIO MA77 (TX)	B	107.1/41
D502	1790000620	S.DIO MA77 (TX)	B	115/41
D503	1790000620	S.DIO MA77 (TX)	B	104.5/53.9
D504	1790000620	S.DIO MA77 (TX)	B	112.4/53.9
D505	1750000431	S.DIO HSB88WSTR-E	T	100.9/71.4
D506	1750000431	S.DIO HSB88WSTR-E	T	100.9/113
D536	1790001250	S.DIO MA2S111-(TX)	B	114.6/105.5
D601	1790000620	S.DIO MA77 (TX)	B	124.1/60.2
D602	1790000620	S.DIO MA77 (TX)	B	145.1/60.2
D603	1790000620	S.DIO MA77 (TX)	B	124.1/71
D604	1790000620	S.DIO MA77 (TX)	B	145.1/71
D605	1790000620	S.DIO MA77 (TX)	B	124.1/81.8
D606	1790000620	S.DIO MA77 (TX)	B	145.1/81.8
D607	1790000620	S.DIO MA77 (TX)	B	124.1/92.6
D608	1790000620	S.DIO MA77 (TX)	B	145.1/92.6
D609	1790000620	S.DIO MA77 (TX)	B	124.1/103.5
D610	1790000620	S.DIO MA77 (TX)	B	145.1/103.5
D611	1790000620	S.DIO MA77 (TX)	T	124.1/66.3
D612	1790000620	S.DIO MA77 (TX)	T	145.1/66.3
D613	1790000620	S.DIO MA77 (TX)	T	124.1/74.2
D614	1790000620	S.DIO MA77 (TX)	T	145.1/75.3
D615	1790000620	S.DIO MA77 (TX)	T	124.1/84.4
D616	1790000620	S.DIO MA77 (TX)	T	145.1/84.3
D617	1790000620	S.DIO MA77 (TX)	T	124.1/93.3
D618	1790000620	S.DIO MA77 (TX)	T	145.1/93.3
D619	1790000620	S.DIO MA77 (TX)	T	124.1/102.3
D620	1790000620	S.DIO MA77 (TX)	T	145.1/102.3
D801	1790000620	S.DIO MA77 (TX)	T	148.2/62
D802	1750000581	S.DIO 1SV307 (TPH3,F)	T	148.2/60.2
D806	1790000620	S.DIO MA77 (TX)	B	89.3/94.5
D873	1790001250	S.DIO MA2S111-(TX)	B	27.7/226.1
D1001	1750000581	S.DIO 1SV307 (TPH3,F)	T	18.9/136
D1101	1790000620	S.DIO MA77 (TX)	T	10.6/53.7
D1102	1790000620	S.DIO MA77 (TX)	T	25.5/53.7
D1201	1750000581	S.DIO 1SV307 (TPH3,F)	T	46.3/92.3
D1653	1750000550	S.DIO 1SS355 TE-17	B	149.6/11.4
D1654	1750000550	S.DIO 1SS355 TE-17	B	149.7/6
D1701	1790001670	S.DIO RB706F-40T106	B	161.9/14.3
D2001	1790001750	S.DIO DSM3MA4	T	120.2/241.3
D2002	1790001750	S.DIO DSM3MA4	T	115.6/241.3
D2003	1790001670	S.DIO RB706F-40T106	B	165.6/240.3
D2004	1750000550	S.DIO 1SS355 TE-17	B	154.7/234
FI501	2020001070	CER CFWLA455KJFA-B0 (CFWS455D)		
FI502	2020001510	CER CFWLA455KJFA-B0 (CFWS455IT)		
FI503	20100002580	S.FIL FL-348 (64.455 MHz)	T	112/87
L1	6200005521	S.COL NLV25T-470J	B	149.9/159.8
L2	6200005521	S.COL NLV25T-470J	B	143.9/159.8
L3	6200010830	S.COL C2520C-3R3G-A	T	147.8/183.8
L4	6200010830	S.COL C2520C-3R3G-A	T	147.8/195.9
L5	6200010830	S.COL C2520C-3R3G-A	T	147/188.1
L6	6200010830	S.COL C2520C-3R3G-A	T	147/200.2
L21	6200005521	S.COL NLV25T-470J	B	134.4/161
L22	6200005521	S.COL NLV25T-470J	B	128.4/161
L23	6140004040	COL LR-443		
L24	6140004050	COL LR-444		
L25	6140004050	COL LR-444		
L26	6140004050	COL LR-444		
L27	6140004040	COL LR-443		
L51	6200005521	S.COL NLV25T-470J	B	118.9/161
L52	6200005521	S.COL NLV25T-470J	B	112.9/161
L53	6140004060	COL LR-445		
L54	6140004080	COL LR-446		
L55	6140004080	COL LR-446		
L56	6140004080	COL LR-446		
L57	6140004060	COL LR-445		
L81	6200005521	S.COL NLV25T-470J	B	103.5/161
L82	6200005521	S.COL NLV25T-470J	B	97.5/161
L83	6140004090	COL LR-447		
L84	6140004230	COL LR-458		
L85	6140004230	COL LR-458		
L86	6140004230	COL LR-458		
L87	6140004090	COL LR-447		
L111	6200005521	S.COL NLV25T-470J	B	88/161
L112	6200005521	S.COL NLV25T-470J	B	82/161
L113	6140004090	COL LR-447		

M.=Mounted side (T: Mounted on the Top side B: Mounted on the Bottom side) S.=Surface mount

[RF UNIT]

REF NO.	ORDER NO.	DESCRIPTION	M.	H/V LOCATION
L114	6140004100	COL LR-448		
L115	6140004100	COL LR-448		
L116	6140004100	COL LR-448		
L117	6140004090	COL LR-447		
L141	6200005521	S.COL NLV25T-470J	B	72.5/161
L142	6200005521	S.COL NLV25T-470J	B	66.5/161
L143	6140004110	COL LR-449		
L144	6140004120	COL LR-450		
L145	6140004120	COL LR-450		
L146	6140004120	COL LR-450		
L147	6140004110	COL LR-449		
L171	6200005521	S.COL NLV25T-470J	B	53/161
L172	6200005521	S.COL NLV25T-470J	B	47/161
L173	6140004140	COL LR-451		
L174	6140004150	COL LR-452		
L175	6140004150	COL LR-452		
L176	6140004150	COL LR-452		
L177	6140004140	COL LR-451		
L201	6200007021	S.COL NLV25T-270J	B	37.5/161
L202	6200007021	S.COL NLV25T-270J	B	31.5/161
L203	6140004160	COL LR-453		
L204	6140004180	COL LR-454		
L205	6140004180	COL LR-454		
L206	6140004180	COL LR-454		
L207	6140004160	COL LR-453		
L231	6200005011	S.COL NLV25T-100J	B	22.1/161
L232	6200005011	S.COL NLV25T-100J	B	16.1/161
L233	6140004190	COL LR-455		
L234	6140004210	COL LR-456		
L235	6140004210	COL LR-456		
L236	6140004210	COL LR-456		
L237	6140004190	COL LR-455		
L260	6200003281	S.COL NLV25T-2R2J	T	63.7/169
L261	6200009141	S.COL NLV25T-6R8J	B	8.1/160.4
L262	6200009141	S.COL NLV25T-6R8J	B	2.1/160.4
L263	6140004220	COL LR-457		
L264	6140004160	COL LR-453		
L265	6140004160	COL LR-453		
L266	6140004160	COL LR-453		
L267	6140004220	COL LR-457		
L268	6200003281	S.COL NLV25T-2R2J	T	63.2/220.8
L291	6200003281	S.COL NLV25T-2R2J	T	64.1/191.4
L292	6200003281	S.COL NLV25T-2R2J	T	63.8/217.7
L293	6200010180	S.COL LQW2BHN82NG03L	T	64.1/180.7
L294	6200002981	S.COL NLV32T-R56J	T	64.4/185.2
L295	6200010180	S.COL LQW2BHN82NG03L	T	64.1/195
L296	6200010870	S.COL C2520C-R33G-A (0.33U)	T	63.7/201.1
L320	6200001831	S.COL NLV32T-100J	T	64.2/158.2
L321	6200003281	S.COL NLV25T-2R2J	B	68/195.8
L322	6200003281	S.COL NLV25T-2R2J	B	62.8/220.7
L323	6200003011	S.COL NLV32T-R27J	B	64.4/179.8
L324	6200003001	S.COL NLV32T-R22J	B	63.5/188.2
L325	6200003011	S.COL NLV32T-R27J	B	63.8/196.3
L326	6200001831	S.COL NLV32T-100J	T	53.1/221.6
L391	6200005491	S.COL NLV32T-331J	B	102.6/231.2
L392	6200005491	S.COL NLV32T-331J	B	83.5/239.9
L393	6200003211	S.COL NLV32T-820J	B	92.6/229.7
L394	6200005491	S.COL NLV32T-331J	B	103.5/227.8
L395	6200005491	S.COL NLV32T-331J	B	108.2/224.7
L421	6200008641	S.COL NLV32T-391J	B	95.7/148.9
L501	6200003261	S.COL NLV32T-101J	B	124.7/42.6
L502	6200003261	S.COL NLV32T-101J	B	128.7/39.2
L503	6200003261	S.COL NLV32T-101J	B	128.7/42.6
L504	6200003520	S.COL ELJFB 102K-F	T	120.4/39.5
L505	6150004090	COL LS-469 (C-13969)		
L507	6140003530	COL LR-395		
L508	6140003210	S.COL LR-358	T	100.9/77.3
L509	6140003770	S.COL LR-414 4KBL (STP-01435)	T	112/78.4
L510	6140003770	S.COL LR-414 4KBL (STP-01435)	T	112/95.6
L511	6200003031	S.COL NLV32T-R47J	B	110.7/100.7
L512	6150004280	COL LS-484B (C-14927)		
L513	6140002551	S.COL #617DB-1919=P3	T	100.9/106.9
L514	6140002551	S.COL #617DB-1919=P3	T	100.9/119.1
L515	6200003001	S.COL NLV32T-R22J	B	92.5/123.6
L516	6200003021	S.COL NLV32T-R33J	B	94.8/117.7
L517	6200001831	S.COL NLV32T-100J	B	98.8/123.6
L518	6200010720	S.COL C2520C-56NG-A	T	106.5/126.4
L519	6200010860	S.COL C2520C-R10G-A (0.1U)	T	110/128.2
L521	6140003900	COL LR-489		
L522	6140003890	COL LR-488		
L523	6200010381	S.COL ELJRE R15JFA	B	96.2/97
L524	6180002971	S.COL NLV32T-068J	B	88.5/108.5
L525	6180002971	S.COL NLV32T-068J	B	90.7/112.5
L526	6180002971	S.COL NLV32T-068J	B	95/113.2
L527	6200010660	S.COL C2520C-R15G-A (0.15U)	T	115/127.4
L528	6200003261	S.COL NLV32T-101J	B	120.1/36.8
L529	6200010381	S.COL ELJRE R15JFA	B	96.2/93.8
L601	6200003101	S.COL NLV32T-3R9J	B	125/63.7
L602	6200003131	S.COL NLV32T-120J	B	128.5/60.2
L603	6200003131	S.COL NLV32T-120J	B	134.9/64.4
L604	6200003131	S.COL NLV32T-120J	B	140.7/60.2
L605	6200003101	S.COL NLV32T-3R9J	B	144.3/63.7
L606	6200002961	S.COL NLV32T-4R7J	B	125/74.5
L607	6200001851	S.COL NLV32T-5R6J	B	128.5/71
L608	6200001851	S.COL NLV32T-5R6J	B	134.6/75.2
L609	6200001851	S.COL NLV32T-5R6J	B	140.7/71
L610	6200002961	S.COL NLV32T-4R7J	B	144.3/74.5
L611	6200002991	S.COL NLV32T-2R2J	B	125/85.3
L612	6200003111	S.COL NLV32T-6R8J	B	128.5/81.8
L613	6200003111	S.COL NLV32T-6R8J	B	134.6/86
L614	6200003111	S.COL NLV32T-6R8J	B	140.7/81.8
L615	6200002991	S.COL NLV32T-2R2J	B	144.3/85.3
L616	6200002991	S.COL NLV32T-2R2J	B	125/96.2
L617	6200003321	S.COL NLV32T-3R3J	B	128.5/92.6

[RF UNIT]

REF NO.	ORDER NO.	DESCRIPTION	M.	H/V LOCATION
L618	6200003321	S.COL NLV32T-3R3J	B	134.6/96.8
L619	6200003321	S.COL NLV32T-3R3J	B	140.7/92.6
L620	6200002991	S.COL NLV32T-2R2J	B	144.3/96.1
L621	6200003061	S.COL NLV32T-1R2J	B	125/107
L622	6200003091	S.COL NLV32T-2R7J	B	128.5/103.5
L623	6200003091	S.COL NLV32T-2R7J	B	134.6/107.7
L624	6200003091	S.COL NLV32T-2R7J	B	140.7/103.5
L625	6200003061	S.COL NLV32T-1R2J	B	144.3/107
L626	6200003331	S.COL NLV32T-1R0J	T	128.1/63.3
L627	6200003081	S.COL NLV32T-1R8J	T	128.1/66.3
L628	6200003081	S.COL NLV32T-1R8J	T	134.6/65.7
L629	6200003081	S.COL NLV32T-1R8J	T	141.2/66.3
L630	6200003331	S.COL NLV32T-1R0J	T	141.2/63.3
L631	6200003041	S.COL NLV32T-R68J	T	128.1/72.3
L632	6200003071	S.COL NLV32T-1R5J	T	128.1/75.3
L633	6200003071	S.COL NLV32T-1R5J	T	134.6/74.7
L634	6200003071	S.COL NLV32T-1R5J	T	141.2/75.3
L635	6200003041	S.COL NLV32T-R68J	T	141.2/72.3
L636	6200002981	S.COL NLV32T-R56J	T	128.1/81.3
L637	6200003051	S.COL NLV32T-R82J	T	128.1/84.4
L638	6200003051	S.COL NLV32T-R82J	T	134.6/83.7
L639	6200003051	S.COL NLV32T-R82J	T	141.2/84.3
L640	6200002981	S.COL NLV32T-R56J	T	141.2/81.3
L641	6200003021	S.COL NLV32T-R33J	T	128.1/90.3
L642	6200003041	S.COL NLV32T-R68J	T	128.1/93.3
L643	6200003041	S.COL NLV32T-R68J	T	134.6/92.7
L644	6200003041	S.COL NLV32T-R68J	T	141.2/93.3
L645	6200003021	S.COL NLV32T-R33J	T	141.2/90.3
L646	6200005491	S.COL NLV32T-331J	T	128.1/105.3
L647	6200007810	S.COL LQH31HN95NK03L	T	126.8/98.7
L648	6200009810	S.COL LQH31HNR61J03L	T	128.1/102.3
L649	6200009810	S.COL LQH31HNR61J03L	T	134.4/101
L650	6200009810	S.COL LQH31HNR61J03L	T	141.2/102.3
L651	6200007810	S.COL LQH31HN95NK03L	T	142.6/98.7
L801	6200005491	S.COL NLV32T-331J	T	155.2/62.9
L802	6200003261	S.COL NLV32T-101J	B	151.1/62.1
L803	6140003970	COL LR-494		
L804	6200003241	S.COL NLV32T-221J	B	152.1/76.8
L904	6200001831	S.COL NLV32T-100J	B	76.7/140.7
L905	6140004380	COL LR-498		
L906	6200009690	S.COL LQH43CN101K03L	B	77.6/137
L1004	6140003890	COL LR-488		
L1005	6180001000	COL LAL 04NA 102K		
L1006	6140003900	COL LR-489		
L1007	6140003800	COL LR-439		
L1008	6190001650	COL ELC06D102E		
L1009	6190001650	COL ELC06D102E		
L1010	6140003880	COL LR-486		
L1011	6140003880	COL LR-486		
L1012	6140003800	COL LR-439		
L1013	6200010680	S.COL C2520C-R22G-A (0.22U)	T	21.8/139.4
L1015	6200007790	S.COL LQW2BHN15J03L	T	47.6/117.6
L1052	6200010740	S.COL C2520C-R27G-A	T	6.7/139.9
L1053	6200010740	S.COL C2520C-R27G-A	T	6/136.1
L1054	6200010740	S.COL C2520C-R27G-A	T	6.7/132.3
L1055	6140003960	COL LR-495		
L1056	6200010730	S.COL C2520C-68NG-A	T	13/116.3
L1058	6190001631	COL #E544EN-100021		
L1060	6200010730	S.COL C2520C-68NG-A	T	51.2/87.5
L1062	6200011450	S.COL C2520C-R39G-A	T	53.4/83.7
L1063	6200010650	S.COL C2520C-R12G-A (0.12U)	T	53/79.9
L1071	6200007780	S.COL LQW2BHN12J03L	T	2.7/128
L1072	6200007780	S.COL LQW2BHN12J03L	T	3.3/130.8
L1101	6140003920	COL LR-491		
L1102	6200010650	S.COL C2520C-R12G-A (0.12U)	T	7.1/82.2
L1103	6180001250	COL LAL 04NA 3R3K		
L1104	6200010870	S.COL C2520C-R33G-A (0.33U)	T	5.6/64.2
L1105	6140003910	COL LR-490		
L1151	6140004640	COL LR-519		
L1201	6200007780	S.COL LQW2BHN12J03L	T	58.4/121
L1208	6140003800	COL LR-439		
L1209	6200001831	S.COL NLV32T-100J	B	56.9/115.2
L1210	6140004440	COL LR-503		
L1211	6200009690	S.COL LQH43CN101K03L	T	56.8/102.1
L1212	6200001831	S.COL NLV32T-100J	B	71.4/115.2
L1213	6140004440	COL LR-503		
L1214	6200009690	S.COL LQH43CN101K03L	T	71.4/102.1
L1216	6140003800	COL LR-439		
L1217	6200007750	S.COL LQW2BHN56NJ03L	T	49.7/94
L1218	6200007770	S.COL LQW2BHN10J03L	T	48.9/99.4
L1219	6200007790	S.COL LQW2BHN15J03L	T	44.9/100.3
L1220	6140000930	COL LR-116		
L1221	6200003261	S.COL NLV32T-101J	B	38.1/76.3
L1222	6150001770	COL LS-198		
L1223	6200007750	S.COL LQW2BHN56NJ03L	T	33.8/78.6
L1228	6200010870	S.COL C2520C-R33G-A (0.33U)	T	44.9/104.9
L1301	6200008090	S.COL LQW2BHN68NJ03L	T	30.3/75.1
L1302	6200008090	S.COL LQW2BHN68NJ03L	T	31/71.5
L1303	6200007790	S.COL LQW2BHN15J03L	T	34.1/69.5
L1304	6200010870	S.COL C2520C-R33G-A (0.33U)	T	33.8/64.2
L1305	6200003001	S.COL NLV32T-R22J	T	28.2/61.3
L1306	6200001831	S.COL NLV32T-100J	B	34.7/68.3
L1307	6200003001	S.COL NLV32T-R22J	T	34.2/75
L1351	6200001831	S.COL NLV32T-100J	B	69.1/77.9
L1353	6200010740	S.COL C2520C-R27G-A	T	65.1/76.1
L1405	6200007770	S.COL LQW2BHN10J03L	T	52.4/6
L1406	6200007750	S.COL LQW2BHN56NJ03L	T	52.4/9.6
L1407	6140003930	COL LR-492		
L1408	6190001621			

[RF UNIT]

REF NO.	ORDER NO.	DESCRIPTION	M.	H/V LOCATION
L1655	6200001831	S.COL NLV32T-100J	B	97.5/46.3
L1701	6200001831	S.COL NLV32T-100J	B	121.8/148.2
L1902	6200001831	S.COL NLV32T-100J	T	151.5/137.7
L2001	6200009790	S.COL BLM31PG121SN1	B	123.5/238.5
L2003	6200003261	S.COL NLV32T-101J	B	142/241.8
L2004	6200003261	S.COL NLV32T-101J	B	154.5/237.6
R1	7030003640	S.RES ERJ3GEYJ 473 V (47 k)	T	148.7/177.3
R3	7030003860	S.RES ERJ3GE JPW V	T	146.5/178.8
R101	7030003320	S.RES ERJ3GEYJ 101 V (100)	T	150/158.2
R102	7030003320	S.RES ERJ3GEYJ 101 V (100)	T	138/153.3
R103	7030003320	S.RES ERJ3GEYJ 101 V (100)	T	140.9/154.1
R104	7030003320	S.RES ERJ3GEYJ 101 V (100)	T	138/154.9
R105	7030003320	S.RES ERJ3GEYJ 101 V (100)	T	140.9/155.7
R106	7030003320	S.RES ERJ3GEYJ 101 V (100)	T	138/148.5
R107	7030003320	S.RES ERJ3GEYJ 101 V (100)	T	140.9/147.7
R108	7030003320	S.RES ERJ3GEYJ 101 V (100)	T	140.9/149.3
R117	7030003320	S.RES ERJ3GEYJ 101 V (100)	T	138/150.1
R118	7030003320	S.RES ERJ3GEYJ 101 V (100)	T	140.9/150.9
R119	7030003320	S.RES ERJ3GEYJ 101 V (100)	T	138/151.7
R120	7030003320	S.RES ERJ3GEYJ 101 V (100)	T	140.9/152.5
R121	7030003320	S.RES ERJ3GEYJ 101 V (100)	T	154.7/160.6
R122	7030003320	S.RES ERJ3GEYJ 101 V (100)	T	153.4/160.6
R123	7030003320	S.RES ERJ3GEYJ 101 V (100)	T	152.1/160.6
R133	7030003560	S.RES ERJ3GEYJ 103 V (10 k)	T	151.2/145.8
R134	7030003320	S.RES ERJ3GEYJ 101 V (100)	T	152.5/145.8
R135	7030003320	S.RES ERJ3GEYJ 101 V (100)	T	153.8/145.8
R260	7030003320	S.RES ERJ3GEYJ 101 V (100)	T	63.2/204.1
R261	7030003440	S.RES ERJ3GEYJ 102 V (1 k)	T	63.8/166.5
R262	7030003440	S.RES ERJ3GEYJ 102 V (1 k)	T	65.8/222
R263	7030003680	S.RES ERJ3GEYJ 104 V (100 k)	T	63.2/206.9
R264	7030003480	S.RES ERJ3GEYJ 222 V (2.2 k)	T	70/222.6
R320	7030008180	S.RES ERJ12YJ331U (330)	T	64.2/162.8
R321	7030003320	S.RES ERJ3GEYJ 101 V (100)	B	63.2/204.9
R322	7030008180	S.RES ERJ12YJ331U (330)	T	58.3/222
R323	7030003680	S.RES ERJ3GEYJ 104 V (100 k)	B	63.2/208.1
R351	7030003340	S.RES ERJ3GEYJ 151 V (150)	B	73.8/233.5
R352	7030003300	S.RES ERJ3GEYJ 680 V (68)	B	76.9/233.5
R354	7030003280	S.RES ERJ3GEYJ 470 V (47)	B	66.7/227.1
R355	7030003320	S.RES ERJ3GEYJ 101 V (100)	B	69.8/227.1
R381	7030003520	S.RES ERJ3GEYJ 472 V (4.7 k)	B	108.2/227.9
R382	7030003360	S.RES ERJ3GEYJ 221 V (220)	B	75.3/240.7
R383	7030003680	S.RES ERJ3GEYJ 104 V (100 k)	B	106.6/227.9
R384	7030003420	S.RES ERJ3GEYJ 681 V (680)	B	99.9/228.7
R385	7030003420	S.RES ERJ3GEYJ 681 V (680)	B	99/232.1
R386	7030003480	S.RES ERJ3GEYJ 222 V (2.2 k)	B	99.9/225.1
R387	7030003560	S.RES ERJ3GEYJ 103 V (10 k)	B	98.4/236.2
R388	7540000130	ABS 2P-50A-301		
R389	7030003420	S.RES ERJ3GEYJ 681 V (680)	B	87.4/239.2
R390	7030003560	S.RES ERJ3GEYJ 103 V (10 k)	B	101.4/237.8
R391	7030003680	S.RES ERJ3GEYJ 104 V (100 k)	B	101.5/236.2
R392	7030003420	S.RES ERJ3GEYJ 681 V (680)	B	99.9/227.1
R393	7030003420	S.RES ERJ3GEYJ 681 V (680)	B	99/230.5
R394	7030003420	S.RES ERJ3GEYJ 681 V (680)	B	87.4/240.8
R395	7030003420	S.RES ERJ3GEYJ 681 V (680)	B	98.4/239.4
R396	7030003420	S.RES ERJ3GEYJ 681 V (680)	B	98.4/237.8
R401	7030003360	S.RES ERJ3GEYJ 221 V (220)	B	55.3/230.7
R402	7030003680	S.RES ERJ3GEYJ 104 V (100 k)	B	50.9/231.7
R403	7030003480	S.RES ERJ3GEYJ 222 V (2.2 k)	B	48.3/236.5
R404	7030003860	S.RES ERJ3GE JPW V	B	48.3/233.7
R405	7540000130	ABS 2P-50A-301		
R421	7030003440	S.RES ERJ3GEYJ 102 V (1 k)	B	87.9/139.5
R422	7030003440	S.RES ERJ3GEYJ 102 V (1 k)	B	93.1/139.5
R423	7030003440	S.RES ERJ3GEYJ 102 V (1 k)	B	86.1/139.5
R424	7030003440	S.RES ERJ3GEYJ 102 V (1 k)	B	94.9/139.5
R425	7030003410	S.RES ERJ3GEYJ 561 V (560)	B	95.6/145.7
R426	7030003410	S.RES ERJ3GEYJ 561 V (560)	B	92.2/135
R427	7030003320	S.RES ERJ3GEYJ 101 V (100)	B	89.7/142.6
R428	7030003400	S.RES ERJ3GEYJ 471 V (470)	B	89.7/139.5
R429	7030003400	S.RES ERJ3GEYJ 471 V (470)	B	91.3/139.5
R501	7030003440	S.RES ERJ3GEYJ 102 V (1 k)	T	162.7/36.4
R502	7030003560	S.RES ERJ3GEYJ 103 V (10 k)	T	162.7/35.1
R503	7030003440	S.RES ERJ3GEYJ 102 V (1 k)	T	162.7/39
R504	7030003440	S.RES ERJ3GEYJ 102 V (1 k)	T	162.7/42.9
R505	7030003320	S.RES ERJ3GEYJ 101 V (100)	T	162.7/45.5
R506	7030003320	S.RES ERJ3GEYJ 101 V (100)	T	150.5/37.7
R507	7030003440	S.RES ERJ3GEYJ 102 V (1 k)	T	150.5/39
R508	7030003440	S.RES ERJ3GEYJ 102 V (1 k)	T	150.5/42.9
R509	7030003320	S.RES ERJ3GEYJ 101 V (100)	T	150.5/45.5
R510	7030003320	S.RES ERJ3GEYJ 101 V (100)	T	138.3/37.7
R511	7030003320	S.RES ERJ3GEYJ 101 V (100)	B	132.9/37.5
R513	7030003860	S.RES ERJ3GE JPW V	B	85.3/113.7
R514	7030003440	S.RES ERJ3GEYJ 102 V (1 k)	B	128.7/36.7
R515	7030003410	S.RES ERJ3GEYJ 561 V (560)	B	128.7/45.1
R516	7030003440	S.RES ERJ3GEYJ 102 V (1 k)	T	138.3/42.8
R517	7030009591	S.RES ERA3YED 472V (4.7 k)	T	138.3/41.5
R518	7030003400	S.RES ERJ3GEYJ 471 V (470)	T	126.6/44.5
R519	7030003560	S.RES ERJ3GEYJ 103 V (10 k)	T	126.6/43.2
R520	7030003630	S.RES ERJ3GEYJ 393 V (39 k)	B	124/38.4
R521	7030003600	S.RES ERJ3GEYJ 223 V (22 k)	B	125.6/38.4
R523	7030003360	S.RES ERJ3GEYJ 221 V (220)	T	123.7/39.3
R524	7030003560	S.RES ERJ3GEYJ 103 V (10 k)	T	117.8/39.5
R525	7030003480	S.RES ERJ3GEYJ 222 V (2.2 k)	T	118/43.2
R526	7030003440	S.RES ERJ3GEYJ 102 V (1 k)	T	118.1/35.8
R527	7030003560	S.RES ERJ3GEYJ 103 V (10 k)	T	116/36.6
R528	7030003560	S.RES ERJ3GEYJ 103 V (10 k)	B	106.3/44.5
R529	7030003560	S.RES ERJ3GEYJ 103 V (10 k)	B	114.3/44.5
R530	7030003560	S.RES ERJ3GEYJ 103 V (10 k)	B	107.9/52.2
R531	7030003560	S.RES ERJ3GEYJ 103 V (10 k)	B	115.9/52.2
R532	7030003440	S.RES ERJ3GEYJ 102 V (1 k)	B	115.9/54.7
R533	7030003560	S.RES ERJ3GEYJ 103 V (10 k)	B	114.3/55.7
R534	7030003560	S.RES ERJ3GEYJ 103 V (10 k)	T	118.9/55.7
R535	7030003480	S.RES ERJ3GEYJ 222 V (2.2 k)	B	103.8/58

[RF UNIT]

REF NO.	ORDER NO.	DESCRIPTION	M.	H/V LOCATION
R536	7030003490	S.RES ERJ3GEYJ 272 V (2.7 k)	B	107/58.4
R537	7030003320	S.RES ERJ3GEYJ 101 V (100)	T	115.8/59.4
R538	7310005400	S.TRI EVM-3VXS0 BE4 (223)	T	108.6/55.5
R539	7030003380	S.RES ERJ3GEYJ 331 V (330)	B	113/59
R540	7030003220	S.RES ERJ3GEYJ 150 V (15)	B	94.7/65.9
R541	7030003380	S.RES ERJ3GEYJ 331 V (330)	B	92.3/65.2
R543	7030003380	S.RES ERJ3GEYJ 331 V (330)	B	97.1/65.2
R545	7030004030	S.RES ERJ3GEYJ 5R6 V (5.6)	B	100.9/64.5
R546	7030003430	S.RES ERJ3GEYJ 821 V (820)	B	100.9/61.2
R547	7030003430	S.RES ERJ3GEYJ 821 V (820)	B	98.7/60.6
R548	7030004030	S.RES ERJ3GEYJ 5R6 V (5.6)	B	101/77.3
R550	7030003860	S.RES ERJ3GE JPW V	B	108.3/70.3
R552	7030004040	S.RES ERJ3GEYJ 4R7 V (4.7)	B	113.8/99
R553	7030003560	S.RES ERJ3GEYJ 103 V (10 k)	B	112.8/105.5
R554	7030003440	S.RES ERJ3GEYJ 102 V (1 k)	B	108.1/104
R556	7030003400	S.RES ERJ3GEYJ 471 V (470)	B	109.8/96.1
R558	7030003320	S.RES ERJ3GEYJ 101 V (100)	B	105.8/92.1
R562	7030003320	S.RES ERJ3GEYJ 101 V (100)	T	102.9/125.6
R563	7030003300	S.RES ERJ3GEYJ 680 V (68)	B	94.7/120.8
R564	7030003620	S.RES ERJ3GEYJ 333 V (33 k)	B	92.3/116.9
R566	7030003330	S.RES ERJ3GEYJ 121 V (120)	B	97.3/120
R567	7030003230	S.RES ERJ3GEYJ 180 V (180)	B	98.8/110.7
R568	7030009851	S.RES ERA3YED 271V (270)	B	98.1/108.2
R569	7030009851	S.RES ERA3YED 271V (270)	B	99.7/108.2
R570	7030003520	S.RES ERJ3GEYJ 472 V (4.7 k)	B	118.4/125.7
R571	7030003560	S.RES ERJ3GEYJ 103 V (10 k)	B	115.3/124.1
R572	7030004040	S.RES ERJ3GEYJ 4R7 V (4.7)	B	121.7/115.8
R573	7030003400	S.RES ERJ3GEYJ 471 V (470)	B	115.3/114.2
R574	7030003280	S.RES ERJ3GEYJ 470 V (47)	B	118.4/114.2
R575	7030009851	S.RES ERA3YED 271V (270)	T	119.2/113
R576	7030003230	S.RES ERJ3GEYJ 180 V (18)	T	120.5/113
R577	7030009851	S.RES ERA3YED 271V (270)	T	119.7/110.9
R578	7030003230	S.RES ERJ3GEYJ 180 V (18)	T	117.9/124.7
R579	7030009851	S.RES ERA3YED 271V (270)	T	118.6/126.6
R580	7030009851	S.RES ERA3YED 271V (270)	T	119.9/126.6
R581	7030003430	S.RES ERJ3GEYJ 821 V (820)	B	92/97.8
R582	7030004030	S.RES ERJ3GEYJ 5R6 V (5.6)	B	96.2/100.1
R583	7030003430	S.RES ERJ3GEYJ 821 V (820)	B	93.9/99.4
R585	7030003600	S.RES ERJ3GEYJ 223 V (22 k)	T	126.6/41.9
R587	7030003200	S.RES ERJ3GEYJ 100 V (10)	B	120.9/123
R589	7030003400	S.RES ERJ3GEYJ 471 V (470)	B	118.4/124.1
R590	7030003430	S.RES ERJ3GEYJ 821 V (820)	B	98.6/78.1
R591	7030003430	S.RES ERJ3GEYJ 821 V (820)	B	103.4/78.1
R592	7030000300	S.RES MCR10EZHJ 220 (221)	B	126.6/124.3
R601	7030000260	S.RES MCR10EZHJ 100 (101)	B	134.6/68.2
R602	7030000260	S.RES MCR10EZHJ 100 (101)	B	134.6/79
R603	7030000260	S.RES MCR10EZHJ 100 (101)	B	134.6/89.8
R604	7030000260	S.RES MCR10EZHJ 100 (101)	B	134.6/100.7
R605	7030000260	S.RES MCR10EZHJ 100 (101)	B	134.6/111.5
R606	7030000260	S.RES MCR10EZHJ 100 (101)	T	134.6/60
R607	7030000260	S.RES MCR10EZHJ 100 (101)	T	134.6/69
R608	7030000260	S.RES MCR10EZHJ 100 (101)	T	134.6/78
R609	7030000260	S.RES MCR10EZHJ 100 (101)	T	134.6/87
R610	7030003400	S.RES ERJ3GEYJ 471 V (470)	T	124.1/105.3
R611	7030000260	S.RES MCR10EZHJ 100 (101)	T	134.6/97
R612	7030009851	S.RES ERA3YED 271V (270)	T	124/69.5
R613	7030003230	S.RES ERJ3GEYJ 180 V (18)	T	124.7/71.7
R614	7030009851	S.RES ERA3YED 271V (270)	T	125.3/69.5
R801	7030003380	S.RES ERJ3GEYJ 331 V (330)	T	152.4/62.9
R802	7030003340	S.RES ERJ3GEYJ 151 V (150)	B	155.2/61.4
R803	7030003440	S.RES ERJ3GEYJ 102 V (1 k)	B	159.4/76.1
R804	7030003490	S.RES ERJ3GEYJ 272 V (2.7 k)	B	157/75.3
R805	7030003280	S.RES ERJ3GEYJ 470 V (47 k)	B	154.1/84.4
R806	7030003300	S.RES ERJ3GEYJ 680 V (68)	B	154.1/84.4
R806	7030003320	S.RES ERJ3GEYJ 101 V (100)	B	156.5/83.4
R806	7030003330	S.RES ERJ3GEYJ 121 V (120)	B	156.5/83.4
R807	7030003320	S.RES ERJ3GEYJ 101 V (100)	B	156.5/85.2
R807	7030003330	S.RES ERJ3GEYJ 121 V (120)	B	156.5/85.2
R808	7030003640	S.RES ERJ3GEYJ 473 V (4.7 k)	B	162.8/96.7
R809	7030003460	S.RES ERJ3GEYJ 152 V (15 k)	B	164.4/96.7
R810	7030003680	S.RES ERJ3GEYJ 104 V (100 k)	T	156.5/59.4
R811	7030003560	S.RES ERJ3GEYJ 103 V (10 k)	T	159.5/56.6
R812	7030009851	S.RES ERA3YED 271V (270)	T	151.1/59.4
R813	7030003230	S.RES ERJ3GEYJ 180 V (18)	T	152.4/59.4
R814	7030009851	S.RES ERA3YED 271V (270)	T	153.7/59.4
R815	7030003320	S		

[RF UNIT]

REF NO.	ORDER NO.	DESCRIPTION	M.	H/V LOCATION
R1019	7030003560	S.RES ERJ3GEYJ 103 V (10 k)	T	15.4/133.9
R1023	7030010980	S.RES ERA3YHD 470V (47)	B	32.6/137.7
R1024	7030003200	S.RES ERJ3GEYJ 100 V (10)	T	27.3/142.6
R1027	7030003200	S.RES ERJ3GEYJ 100 V (10)	B	38.9/133.8
R1028	7030003200	S.RES ERJ3GEYJ 100 V (10)	B	38.9/119.9
R1029	7030010980	S.RES ERA3YHD 470V (47)	B	28.9/133.8
R1030	7030010980	S.RES ERA3YHD 470V (47)	B	28.9/120
R1051	7030003800	S.RES ERJ3GEYJ 105 V (1 M)	B	3.1/103.2
R1054	7030011500	S.RES ERA3YHD 270V (27)	T	48.9/88.3
R1055	7030000010	S.RES MCR10EZHZ JPW (000)	T	7.3/128
R1056	7030000010	S.RES MCR10EZHZ JPW (000)	T	6.5/144
R1071	7030010980	S.RES ERA3YHD 470V (47)	T	3.6/132.5
R1072	7030000010	S.RES MCR10EZHZ JPW (000)	T	3.6/45.2
R1073	7030000010	S.RES MCR10EZHZ JPW (000)	T	5.4/45.2
R1074	7030000010	S.RES MCR10EZHZ JPW (000)	B	1.9/45.3
R1075	7030000010	S.RES MCR10EZHZ JPW (000)	B	4.3/45.3
R1101	7310004860	S.TRI EVM-3YSX50 B53 (502)	T	3.9/109.9
R1102	7030005871	S.RES ERA3YKD 104V (100 k)	B	3.8/99.5
R1103	7030007680	S.RES ERJ8ENF 47R0V (47)	T	2.3/95.4
R1104	7030007680	S.RES ERJ8ENF 47R0V (47)	T	10.4/92.9
R1105	7030003500	S.RES ERJ3GEYJ 332 V (3.3 k)	T	7.3/112.4
R1106	7030009620	S.RES ERJ12YJ120U (12)	B	4.4/82.2
R1107	7030010980	S.RES ERA3YHD 470V (47)	T	8.4/79.8
R1109	7030007180	S.RES ERJ12YJ150U (15)	B	7.4/74.4
R1110	7030003480	S.RES ERJ3GEYJ 222 V (2.2 k)	B	15.5/68.5
R1111	7030003480	S.RES ERJ3GEYJ 222 V (2.2 k)	T	17.8/69.7
R1113	7030003480	S.RES ERJ3GEYJ 222 V (2.2 k)	T	17.8/68.4
R1114	7030004040	S.RES ERJ3GEYJ 4R7 V (4.7)	T	4.7/74.8
R1115	7030006240	S.RES ERJ12YJ181U (180)	B	7.4/70.2
R1116	7030007230	S.RES ERA3YED 102V (1 k)	T	8.3/64.8
R1117	7030004040	S.RES ERJ3GEYJ 4R7 V (4.7)	T	8.3/66.1
R1118	7030003480	S.RES ERJ3GEYJ 222 V (2.2 k)	T	8.6/68.1
R1119	7030003470	S.RES ERJ3GEYJ 182 V (1.8 k)	T	6/68.1
R1120	7030006070	S.RES ERJ12YJ101U (100)	B	6.6/59.1
R1121	7030003240	S.RES ERJ3GEYJ 220 V (22)	T	5.4/60.5
R1122	7030010980	S.RES ERA3YHD 470V (47)	T	12/69
R1123	7030003480	S.RES ERJ3GEYJ 222 V (2.2 k)	T	18.3/62.7
R1124	7030003460	S.RES ERJ3GEYJ 152 V (1.5 k)	T	18.3/60.1
R1125	7030003420	S.RES ERJ3GEYJ 681 V (680)	B	13/57.2
R1126	7030003200	S.RES ERJ3GEYJ 100 V (10)	T	15.6/57.9
R1127	7030010980	S.RES ERA3YHD 470V (47)	T	9.4/57.2
R1128	7030003470	S.RES ERJ3GEYJ 182 V (1.8 k)	T	10.6/52.1
R1129	7030003470	S.RES ERJ3GEYJ 182 V (1.8 k)	T	26.6/52.1
R1130	7030003480	S.RES ERJ3GEYJ 222 V (2.2 k)	T	16.5/1.8
R1131	7030003640	S.RES ERJ3GEYJ 473 V (47 k)	B	6.6/109.4
R1132	7310004860	S.TRI EVM-3YSX50 B53 (502)	T	4.6/115.8
R1133	7030003500	S.RES ERJ3GEYJ 332 V (3.3 k)	T	8.5/117.6
R1134	7030003640	S.RES ERJ3GEYJ 473 V (47 k)	T	8.5/116.3
R1135	7030005871	S.RES ERA3YKD 104V (100 k)	T	1.8/102.3
R1151	7030010980	S.RES ERA3YHD 470V (47)	T	55/74.2
R1152	7030010980	S.RES ERA3YHD 470V (47)	B	48.3/65
R1203	7030000010	S.RES MCR10EZHZ JPW (000)	T	41.6/103
R1208	7030003480	S.RES ERJ3GEYJ 222 V (2.2 k)	T	49.4/91.7
R1209	7030003560	S.RES ERJ3GEYJ 103 V (10 k)	T	52.8/91.7
R1210	7030003650	S.RES ERJ3GEYJ 563 V (56 k)	T	54.1/91.7
R1211	7030003860	S.RES ERJ3GE JPW V	T	58.8/124.7
R1212	7030003860	S.RES ERJ3GE JPW V	B	64.1/97.4
R1213	7030003200	S.RES ERJ3GEYJ 100 V (10)	B	57.1/111.7
R1214	7030003200	S.RES ERJ3GEYJ 100 V (10)	B	71.1/111.7
R1216	7030003280	S.RES ERJ3GEYJ 470 V (47)	B	55.3/109.5
R1217	7030003280	S.RES ERJ3GEYJ 470 V (47)	B	69.3/109.5
R1220	7030003280	S.RES ERJ3GEYJ 470 V (47)	B	57.8/119.1
R1221	7030003440	S.RES ERJ3GEYJ 102 V (1 k)	B	51.7/106
R1222	7030003530	S.RES ERJ3GEYJ 562 V (5.6 k)	B	54.9/104.5
R1223	7030003280	S.RES ERJ3GEYJ 470 V (47)	B	70.5/119.1
R1224	7030003440	S.RES ERJ3GEYJ 102 V (1 k)	B	65.7/106
R1225	7030003530	S.RES ERJ3GEYJ 562 V (5.6 k)	B	68.9/104.5
R1226	7030003410	S.RES ERJ3GEYJ 561 V (560)	T	28.5/94.3
R1227	7030003410	S.RES ERJ3GEYJ 561 V (560)	T	33.5/94.3
R1228	7310004860	S.TRI EVM-3YSX50 B53 (502)	T	31/94.3
R1229	7030003480	S.RES ERJ3GEYJ 222 V (2.2 k)	B	31.3/69.5
R1230	7030003480	S.RES ERJ3GEYJ 222 V (2.2 k)	B	31.3/67.7
R1231	7030003480	S.RES ERJ3GEYJ 222 V (2.2 k)	B	31.3/65.9
R1232	7030003600	S.RES ERJ3GEYJ 223 V (22 k)	T	31/89.5
R1233	7030010980	S.RES ERA3YHD 470V (47)	B	34.9/77.8
R1301	7030010980	S.RES ERA3YHD 470V (47)	B	31/89.5
R1302	7030003860	S.RES ERJ3GE JPW V	T	28.8/69.3
R1304	7030003620	S.RES ERJ3GEYJ 333 V (33 k)	T	31/62.9
R1306	7030006230	S.RES ERJ12YJ151U (150)	B	33.4/61.9
R1307	7030003300	S.RES ERJ3GEYJ 680 V (68)	T	32.1/57.3
R1314	7030000010	S.RES MCR10EZHZ JPW (000)	T	38.5/74
R1315	7030000010	S.RES MCR10EZHZ JPW (000)	T	45.1/89
R1316	7030000010	S.RES MCR10EZHZ JPW (000)	T	43/92
R1357	7030007230	S.RES ERA3YED 102V (1 k)	B	66/77.8
R1358	7030003530	S.RES ERJ3GEYJ 562 V (5.6 k)	B	66.7/75.4
R1359	7030010980	S.RES ERA3YHD 470V (47)	B	57.4/77.8
R1360	7030007230	S.RES ERA3YED 102V (1 k)	T	64.5/73.8
R1401	7030003200	S.RES ERJ3GEYJ 100 V (10)	B	59.6/10.9
R1402	7030003300	S.RES ERJ3GEYJ 680 V (68)	T	62.8/15
R1403	7030007230	S.RES ERA3YED 102V (1 k)	B	62.2/13.4
R1404	7030009861	S.RES ERA3YED 471V (470)	B	62.2/16.5
R1405	7030003340	S.RES ERJ3GEYJ 151 V (150)	B	62.2/19.6
R1406	7030009591	S.RES ERA3YED 472V (4.7 k)	B	58.1/18.4
R1407	7030003550	S.RES ERJ3GEYJ 822 V (8.2 k)	B	54.1/19.9
R1408	7030003200	S.RES ERJ3GEYJ 100 V (10)	T	64.1/15
R1409	7030009591	S.RES ERA3YED 472V (4.7 k)	T	69.3/15
R1410	7030006091	S.RES ERA3YED 822V (8.2 k)	B	68/13.6
R1411	7030005871	S.RES ERA3YKD 104V (100 k)	T	66.7/12.4
R1412	7030003200	S.RES ERJ3GEYJ 100 V (10)	T	67.3/17.1
R1413	7030003200	S.RES ERJ3GEYJ 100 V (10)	T	64.7/8.1
R1414	7030005871	S.RES ERA3YKD 104V (100 k)	B	69.6/13.6
R1415	7030010980	S.RES ERA3YHD 470V (47)	T	65.4/4.9
R1416	7030003320	S.RES ERJ3GEYJ 101 V (100)	B	70.7/5.4
R1419	7030003860	S.RES ERJ3GE JPW V	B	80.2/15

[RF UNIT]

REF NO.	ORDER NO.	DESCRIPTION	M.	H/V LOCATION
R1501	7030010980	S.RES ERA3YHD 470V (47)	T	88.7/10
R1502	7030009841	S.RES ERA3YHD 330V (33)	T	104/5.1
R1503	7030009851	S.RES ERA3YED 271V (270)	T	113.1/5.4
R1504	7030011050	S.RES ERA3YHD 100V (10)	T	110/6.7
R1505	7030006091	S.RES ERA3YED 822V (8.2 k)	B	106.5/23.5
R1506	7030007230	S.RES ERA3YED 102V (1 k)	T	113/12.7
R1507	7030007230	S.RES ERA3YED 102V (1 k)	T	113.1/8
R1508	7030007230	S.RES ERA3YED 102V (1 k)	T	113.1/9.3
R1509	7030007230	S.RES ERA3YED 102V (1 k)	T	118/3.8
R1510	7030005321	S.RES ERA3YED 103V (10 k)	T	124.4/3.8
R1511	7030007230	S.RES ERA3YED 102V (1 k)	T	125/6.2
R1512	7030003380	S.RES ERJ3GEYJ 331 V (330)	T	116.9/15.8
R1513	7030003380	S.RES ERJ3GEYJ 331 V (330)	T	125.2/15.8
R1514	7030005321	S.RES ERA3YED 103V (10 k)	T	129/15.8
R1515	7030005321	S.RES ERA3YED 103V (10 k)	T	129/11.9
R1516	7310005380	S.TRI EVM-3VSX50 B13 (102)	T	125.3/26
R1517	7030005321	S.RES ERA3YED 103V (10 k)	T	124.3/29.6
R1518	7030005321	S.RES ERA3YED 103V (10 k)	T	129/10.6
R1519	7030005321	S.RES ERA3YED 103V (10 k)	T	141/13.7
R1520	7030005321	S.RES ERA3YED 103V (10 k)	T	129/9.3
R1521	7030010980	S.RES ERA3YHD 470V (47)	T	96.5/9.9
R1522	7030009841	S.RES ERA3YHD 330V (33)	T	103.9/17.3
R1523	7030009851	S.RES ERA3YED 271V (270)	T	113.1/17.6
R1524	7030011050	S.RES ERA3YHD 100V (10)	T	110/18.9
R1525	7030007230	S.RES ERJ3GEYJ 152 V (1.5 k)	T	113/24.9
R1526	7030003460	S.RES ERJ3GEYJ 152 V (1.5 k)	B	106.5/21.5
R1527	7030007230	S.RES ERA3YED 102V (1 k)	T	113.1/21.5
R1528	7030007230	S.RES ERA3YED 102V (1 k)	T	113.1/20.2
R1529	7030007230	S.RES ERA3YED 102V (1 k)	T	117.9/29.6
R1530	7030003380	S.RES ERJ3GEYJ 331 V (330)	T	116.9/17.6
R1531	7030003380	S.RES ERJ3GEYJ 331 V (330)	T	125.2/17.6
R1532	7030005321	S.RES ERA3YED 103V (10 k)	T	129/21.5
R1533	7030005321	S.RES ERA3YED 103V (10 k)	T	129/17.6
R1534	7030005321	S.RES ERA3YED 103V (10 k)	T	129/22.8
R1535	7030005321	S.RES ERA3YED 103V (10 k)	T	129/24.1
R1536	7030005321	S.RES ERA3YED 103V (10 k)	T	141/16.5
R1537	7030003320	S.RES ERJ3GEYJ 101 V (100)	B	133.9/22.7
R1538	7030003320	S.RES ERJ3GEYJ 101 V (100)	B	139.1/22.7
R1539	7030008601	S.RES ERA3YED 222V (2.2 k)	T	146/14.5
R1540	7030010390	S.RES ERA3YED 821V (820)	T	144.2/19.5
R1541	7030003320	S.RES ERJ3GEYJ 101 V (100)	T	151.5/12.8
R1542	7030003320	S.RES ERJ3GEYJ 101 V (100)	B	145.5/22.7
R1543	7030009691	S.RES ERA3YED 101V (100)	T	151.5/19.5
R1544	7030007230	S.RES ERA3YED 102V (1 k)	T	126.3/6.2
R1651	7030003380	S.RES ERJ3GEYJ 331 V (330)	B	91.5/36.8
R1652	7030003220	S.RES ERJ3GEYJ 150 V (15)	B	92.4/34.4
R1653	7030003380	S.RES ERJ3GEYJ 331 V (330)	B	93.1/36.8
R1654	7030003280	S.RES ERJ3GEYJ 470 V (47)	B	95.6/38.3
R1655	7030003400	S.RES ERJ3GEYJ 471 V (470)	B	100.5/36.8
R1656	7030003630	S.RES ERJ3GEYJ 393 V (39 k)	B	95.7/34.3
R1657	7030003680	S.RES ERJ3GEYJ 104 V (100 k)	T	96.6/28.5
R1658	7030003320	S.RES ERJ3GEYJ 101 V (100)	T	96.6/25.9
R1659	7030009691	S.RES ERA3YED 101V (100)	T	87.8/20.6
R1660	7030009691	S.RES ERA3YED 101V (100)	T	92.2/20.6
R1661	7030003560	S.RES ERJ3GEYJ 103 V (10 k)	T	148.8/13.2
R1662	7030003560	S.RES ERJ3GEYJ 103 V (10 k)	T	143.3/13.2
R1663	7030003560	S.RES ERJ3GEYJ 103 V (10 k)	T	147.5/4.2
R1664	7030003560	S.RES ERJ3GEYJ 103 V (10 k)	B	146.9/8.7
R1665	7030003320	S.RES ERJ3GEYJ 101 V (100)	T	96.6/27.2
R1667	7030003360	S.RES ERJ3GEYJ 221 V (220)	B	149.3/9.5
R1668	7030003360	S.RES ERJ3GEYJ 221 V (220)	B	149.3/7.9
R1670	7030003800	S.RES ERJ3GEYJ 105 V (1 M)	B	152.3/10.3
R1673	7030003440	S.RES ERJ3GEYJ 102 V (1 k)	B	159.7/11.4
R1674	7030009851	S.RES ERA3YED 271V (270)	B	159.7/14.5
R1675	7030009591	S.RES ERA3YED 472V (4.7 k)	T	143.3/9.3
R1677	7030009591	S.RES ERA3YED 472V (4.7 k)	T	144.7/4.2
R1702	7030003320	S.RES ERJ3GEYJ 101 V (100)	B	108.7/138.6
R1703	7030003320	S.RES ERJ3GEYJ 101 V (100)	B	108.7/140.2
R1704	7030003320	S.RES ERJ3GEYJ 101 V (100)	B	108.7/141.8
R1705	7030003320	S.RES ERJ3GEYJ 101 V (100)	B	108.7/143.4
R1706	7030003320	S.RES ERJ3GEYJ 101 V (100)	T	108.7/145
R1707	7030003320	S.RES ERJ3GEYJ 101 V (100)	B	108.7/145
R1709	7030003480	S.RES ERJ3GEYJ 222 V (2.2 k)	T	121.9/130.2
R1710	7030003480	S.RES ERJ3GEYJ 222 V (2.2 k)	T	121.9/131.5
R1711	7030003540	S.RES ERJ3GEYJ 682 V (6.8 k)	T	121.

[RF UNIT]

REF NO.	ORDER NO.	DESCRIPTION	M.	H/V LOCATION
R1923	7030003560	S.RES ERJ3GEYJ 103 V (10 k)	B	140.9/115
R1924	7030003560	S.RES ERJ3GEYJ 103 V (10 k)	B	154.2/115
R1925	7030003560	S.RES ERJ3GEYJ 103 V (10 k)	B	142.5/115
R1926	7030003560	S.RES ERJ3GEYJ 103 V (10 k)	B	155.8/115
R1927	7030003560	S.RES ERJ3GEYJ 103 V (10 k)	B	144.1/115
R1928	7030003560	S.RES ERJ3GEYJ 103 V (10 k)	B	157.4/115
R1929	7030003560	S.RES ERJ3GEYJ 103 V (10 k)	B	145.7/115
R1930	7030003560	S.RES ERJ3GEYJ 103 V (10 k)	B	159/115
R1932	7030003560	S.RES ERJ3GEYJ 103 V (10 k)	B	160.6/115
R2001	7030003480	S.RES ERJ3GEYJ 222 V (2.2 k)	B	166.5/237.4
R2002	7030003520	S.RES ERJ3GEYJ 472 V (4.7 k)	B	155.8/231.4
R2003	7030003480	S.RES ERJ3GEYJ 222 V (2.2 k)	B	164.9/237.4
R2004	7030003620	S.RES ERJ3GEYJ 333 V (33 k)	B	156.6/233.8
R2005	7030003580	S.RES ERJ3GEYJ 153 V (15 k)	B	158.2/233.8
R2006	7030003520	S.RES ERJ3GEYJ 472 V (4.7 k)	B	158.9/231.4
R2007	7030003860	S.RES ERJ3GE JPW V	T	161.9/169.2
R2008	7030003860	S.RES ERJ3GE JPW V	T	161.9/167.9
R2009	7030003860	S.RES ERJ3GE JPW V	T	161.9/166.6
R2010	7030003860	S.RES ERJ3GE JPW V	T	161.9/165.3
R2011	7030003860	S.RES ERJ3GE JPW V	T	161.9/164
R2012	7030003860	S.RES ERJ3GE JPW V	T	161.9/162.7
C1	4030006880	S.CER C1608 JB 1H 472K-T	B	146.9/161.6
C2	4030006880	S.CER C1608 JB 1H 472K-T	B	146.1/159.2
C3	4030006880	S.CER C1608 JB 1H 472K-T	B	147.7/159.2
C4	4030006880	S.CER C1608 JB 1H 472K-T	B	147/222
C5	4030006880	S.CER C1608 JB 1H 472K-T	B	150/218.8
C6	4030006880	S.CER C1608 JB 1H 472K-T	B	147/220.4
C7	4030018620	S.CER C1608 CH 1H 222J-T	T	148.6/181.5
C8	4030018590	S.CER C1608 CH 1H 122J-T	T	148.6/192.3
C9	4030018590	S.CER C1608 CH 1H 122J-T	T	148.6/193.6
C10	4030018620	S.CER C1608 CH 1H 222J-T	T	148.6/203.1
C11	4030018600	S.CER C1608 CH 1H 152J-T	T	148.6/191
C21	4030006880	S.CER C1608 JB 1H 472K-T	B	131.4/161.6
C22	4030006880	S.CER C1608 JB 1H 472K-T	B	130.6/159.2
C23	4030006880	S.CER C1608 JB 1H 472K-T	B	132.2/159.2
C24	4030006880	S.CER C1608 JB 1H 472K-T	B	131.5/222
C25	4030006880	S.CER C1608 JB 1H 472K-T	B	134.5/218.8
C26	4030006880	S.CER C1608 JB 1H 472K-T	B	131.5/220.4
C27	4030017810	S.CER C1608 CH 1H 102J-T	B	139.2/170.3
C28	4030017810	S.CER C1608 CH 1H 102J-T	B	139.2/171.9
C29	4030010760	S.CER C1608 CH 1H 331J-T	B	138.6/185.4
C30	4030007140	S.CER C1608 CH 1H 121J-T	B	140.2/185.4
C31	4030007160	S.CER C1608 CH 1H 181J-T	B	130.9/185.4
C32	4030007060	S.CER C1608 CH 1H 270J-T	B	129.3/185.4
C33	4030010760	S.CER C1608 CH 1H 331J-T	B	134.1/190.1
C34	4030007090	S.CER C1608 CH 1H 470J-T	B	132.5/190.1
C35	4030007160	S.CER C1608 CH 1H 181J-T	B	130.9/190.1
C36	4030007060	S.CER C1608 CH 1H 270J-T	B	129.3/190.1
C37	4030010760	S.CER C1608 CH 1H 331J-T	B	138.6/195
C38	4030007140	S.CER C1608 CH 1H 121J-T	B	140.2/195
C39	4030017810	S.CER C1608 CH 1H 102J-T	B	139.2/209.9
C40	4030017810	S.CER C1608 CH 1H 102J-T	B	139.2/208.3
C51	4030006880	S.CER C1608 JB 1H 472K-T	B	115.9/161.6
C52	4030006880	S.CER C1608 JB 1H 472K-T	B	115.1/159.2
C53	4030006880	S.CER C1608 JB 1H 472K-T	B	116.7/159.2
C54	4030006880	S.CER C1608 JB 1H 472K-T	B	116/222
C55	4030006880	S.CER C1608 JB 1H 472K-T	B	119.2/18.8
C56	4030006880	S.CER C1608 JB 1H 472K-T	B	116/220.4
C57	4030017800	S.CER C1608 CH 1H 561J-T	B	123.7/170.3
C58	4030010760	S.CER C1608 CH 1H 331J-T	B	123.7/171.9
C59	4030010760	S.CER C1608 CH 1H 331J-T	B	123.1/185.4
C60	4030007080	S.CER C1608 CH 1H 390J-T	B	124.7/185.4
C61	4030007100	S.CER C1608 CH 1H 560J-T	B	115.4/185.4
C62	4030010760	S.CER C1608 CH 1H 331J-T	B	113.8/185.4
C63	4030010760	S.CER C1608 CH 1H 331J-T	B	118.6/190.1
C64	4030007090	S.CER C1608 CH 1H 470J-T	B	117/190.1
C65	4030010760	S.CER C1608 CH 1H 331J-T	B	115.4/190.1
C66	4030007100	S.CER C1608 CH 1H 560J-T	B	113.8/190.1
C67	4030010760	S.CER C1608 CH 1H 331J-T	B	123.1/195
C68	4030007080	S.CER C1608 CH 1H 390J-T	B	124.7/195
C69	4030017800	S.CER C1608 CH 1H 561J-T	B	123.7/209.9
C70	4030010760	S.CER C1608 CH 1H 331J-T	B	123.7/208.3
C81	4030006880	S.CER C1608 JB 1H 472K-T	B	100.5/161.6
C82	4030006880	S.CER C1608 JB 1H 472K-T	B	99.7/159.2
C83	4030006880	S.CER C1608 JB 1H 472K-T	B	101.3/159.2
C84	4030006880	S.CER C1608 JB 1H 472K-T	B	100.6/222
C85	4030006880	S.CER C1608 JB 1H 472K-T	B	103.7/218.8
C86	4030006880	S.CER C1608 JB 1H 472K-T	B	100.6/220.4
C87	4030017800	S.CER C1608 CH 1H 561J-T	B	108.3/170.3
C88	4030011330	S.CER C1608 CH 1H 391J-T	B	108.3/171.9
C89	4030007160	S.CER C1608 CH 1H 181J-T	B	107.7/185.4
C90	4030007070	S.CER C1608 CH 1H 330J-T	B	109.3/185.4
C91	4030007030	S.CER C1608 CH 1H 150J-T	B	100/185.4
C92	4030007120	S.CER C1608 CH 1H 820J-T	B	98.4/185.4
C93	4030007140	S.CER C1608 CH 1H 121J-T	B	103.2/190.1
C94	4030007100	S.CER C1608 CH 1H 560J-T	B	101.6/190.1
C95	4030007120	S.CER C1608 CH 1H 820J-T	B	100/190.1
C96	4030007030	S.CER C1608 CH 1H 150J-T	B	98.4/190.1
C97	4030007160	S.CER C1608 CH 1H 181J-T	B	107.7/195
C98	4030007070	S.CER C1608 CH 1H 330J-T	B	109.3/195
C99	4030017800	S.CER C1608 CH 1H 561J-T	B	108.3/209.9
C100	4030011330	S.CER C1608 CH 1H 391J-T	B	108.3/208.3
C111	4030006880	S.CER C1608 JB 1H 472K-T	B	85/161.6
C112	4030006880	S.CER C1608 JB 1H 472K-T	B	84.2/159.2
C113	4030006880	S.CER C1608 JB 1H 472K-T	B	85.8/159.2
C114	4030006880	S.CER C1608 JB 1H 472K-T	B	85/222
C115	4030006880	S.CER C1608 JB 1H 472K-T	B	87.1/219.6
C116	4030006880	S.CER C1608 JB 1H 472K-T	B	85/220.4
C117	4030010760	S.CER C1608 CH 1H 331J-T	B	92.8/170.3
C118	4030007150	S.CER C1608 CH 1H 151J-T	B	92.8/171.9
C119	4030007150	S.CER C1608 CH 1H 151J-T	B	93.7/185.4
C120	4030007060	S.CER C1608 CH 1H 270J-T	B	92.1/185.4

[RF UNIT]

REF NO.	ORDER NO.	DESCRIPTION	M.	H/V LOCATION
C121	4030007060	S.CER C1608 CH 1H 270J-T	B	84.4/185.4
C122	4030007140	S.CER C1608 CH 1H 121J-T	B	82.8/185.4
C123	4030007150	S.CER C1608 CH 1H 151J-T	B	87.6/190.1
C124	4030007010	S.CER C1608 CH 1H 100D-T	B	86/190.1
C125	4030007140	S.CER C1608 CH 1H 121J-T	B	84.4/190.1
C126	4030007060	S.CER C1608 CH 1H 270J-T	B	82.8/190.1
C127	4030007150	S.CER C1608 CH 1H 151J-T	B	92.1/195
C128	4030007060	S.CER C1608 CH 1H 270J-T	B	93.7/195
C129	4030010760	S.CER C1608 CH 1H 331J-T	B	92.8/209.9
C130	4030007150	S.CER C1608 CH 1H 151J-T	B	92.8/208.3
C141	4030006880	S.CER C1608 JB 1H 472K-T	B	69.5/161.6
C142	4030006880	S.CER C1608 JB 1H 472K-T	B	68.7/159.2
C143	4030006880	S.CER C1608 JB 1H 472K-T	B	70.3/159.2
C144	4030006880	S.CER C1608 JB 1H 472K-T	B	66.4/220.4
C145	4030006880	S.CER C1608 JB 1H 472K-T	B	72.6/218.8
C146	4030006880	S.CER C1608 JB 1H 472K-T	B	69.5/220.4
C147	4030007170	S.CER C1608 CH 1H 221J-T	B	77.2/170.3
C148	4030007170	S.CER C1608 CH 1H 221J-T	B	77.2/171.9
C149	4030007130	S.CER C1608 CH 1H 101J-T	B	78.2/185.4
C150	4030007050	S.CER C1608 CH 1H 220J-T	B	76.8/185.4
C151	4030007070	S.CER C1608 CH 1H 330J-T	B	68.8/185.4
C152	4030007080	S.CER C1608 CH 1H 390J-T	B	67.2/185.4
C153	4030007120	S.CER C1608 CH 1H 820J-T	B	72.1/190.1
C154	4030007050	S.CER C1608 CH 1H 220J-T	B	70.5/190.1
C155	4030007080	S.CER C1608 CH 1H 390J-T	B	68.8/190.1
C156	4030007070	S.CER C1608 CH 1H 330J-T	B	67.2/190.1
C157	4030007130	S.CER C1608 CH 1H 101J-T	B	76.6/195
C158	4030007050	S.CER C1608 CH 1H 220J-T	B	78.2/195
C159	4030007170	S.CER C1608 CH 1H 221J-T	B	77.2/209.9
C160	4030007170	S.CER C1608 CH 1H 221J-T	B	77.2/208.3
C171	4030006880	S.CER C1608 JB 1H 472K-T	B	50/161.6
C172	4030006880	S.CER C1608 JB 1H 472K-T	B	49.2/159.2
C173	4030006880	S.CER C1608 JB 1H 472K-T	B	50.8/159.2
C174	4030006880	S.CER C1608 JB 1H 472K-T	B	50/222
C175	4030006880	S.CER C1608 JB 1H 472K-T	B	53.1/218.8
C176	4030006880	S.CER C1608 JB 1H 472K-T	B	50/220.4
C177	4030007110	S.CER C1608 CH 1H 221J-T	B	57.8/170.3
C178	4030007110	S.CER C1608 CH 1H 680J-T	B	57.8/171.9
C179	4030007090	S.CER C1608 CH 1H 470J-T	B	58.7/185.4
C180	4030007090	S.CER C1608 CH 1H 470J-T	B	57.1/185.4
C181	4030007070	S.CER C1608 CH 1H 330J-T	B	49.4/185.4
C182	4030007070	S.CER C1608 CH 1H 330J-T	B	47.8/185.4
C183	4030007120	S.CER C1608 CH 1H 820J-T	B	52.6/190.1
C185	4030007070	S.CER C1608 CH 1H 330J-T	B	49.4/190.1
C186	4030007070	S.CER C1608 CH 1H 330J-T	B	47.8/190.1
C187	4030007090	S.CER C1608 CH 1H 470J-T	B	57.1/195
C188	4030007090	S.CER C1608 CH 1H 470J-T	B	58.7/195
C189	4030007170	S.CER C1608 CH 1H 221J-T	B	57.7/209.9
C190	4030007110	S.CER C1608 CH 1H 680J-T	B	57.7/208.3
C201	4030006880	S.CER C1608 JB 1H 472K-T	B	34.5/161.6
C202	4030006880	S.CER C1608 JB 1H 472K-T	B	33.7/159.2
C203	4030006880	S.CER C1608 JB 1H 472K-T	B	35.3/159.2
C204	4030006880	S.CER C1608 JB 1H 472K-T	B	34.5/222
C205	4030006880	S.CER C1608 JB 1H 472K-T	B	36.8/219.6
C206	4030006880	S.CER C1608 JB 1H 472K-T	B	34.5/220.4
C207	4030007160	S.CER C1608 CH 1H 181J-T	B	42.3/170.3
C208	4030007090	S.CER C1608 CH 1H 470J-T	B	42.3/171.9
C209	4030007090	S.CER C1608 CH 1H 470J-T	B	43.2/185.4
C210	4030007040	S.CER C1608 CH 1H 180J-T	B	41.6/185.4
C211	4030007030	S.CER C1608 CH 1H 150J-T	B	33.9/185.4
C212	4030007050	S.CER C1608 CH 1H 220J-T	B	32.3/185.4
C213	4030007090	S.CER C1608 CH 1H 470J-T	B	37.1/190.1
C214	4030006990	S.CER C1608 CH 1H 080D-T	B	35.5/190.1
C215	4030007050	S.CER C1608 CH 1H 220J-T	B	33.9/190.1
C216	4030007030	S.CER C1608 CH 1H 150J-T	B	32.3/190.1
C217	4030007090	S.CER C1608 CH 1H 470J-T	B	41.6/195
C218	4030007040	S.CER C1608 CH 1H 180J-T	B	43.2/195
C219	4030007160	S.CER C1608 CH 1H 181J-T	B	42.2/209.9
C220	4030007090	S.CER C1608 CH 1H 470J-T	B	42.2/208.3
C231	4030006880	S.CER C1608 JB 1H 472K-T	B	19.1/161.6
C232	4030006880	S.CER C1608 JB 1H 472K-T	B	18.3/159.2
C233	4030006880	S.CER C1608 JB 1H 472K-T	B	19.9/159.2
C234	4030006880	S.C		

[RF UNIT]

REF NO.	ORDER NO.	DESCRIPTION	M.	H/V LOCATION
C276	4030006880	S.CER C1608 JB 1H 472K-T	T	65.6/169.4
C277	4030007050	S.CER C1608 CH 1H 220J-T	B	10.9/195
C278	4030007020	S.CER C1608 CH 1H 120J-T	B	12.5/195
C279	4030007130	S.CER C1608 CH 1H 101J-T	B	11.5/209.9
C280	4030007030	S.CER C1608 CH 1H 150J-T	B	11.5/208.3
C283	4030011600	S.CER C1608 JB 1E 104K-T	T	63.8/193.3
C285	4030006880	S.CER C1608 JB 1H 472K-T	T	63.5/215.2
C286	4030006880	S.CER C1608 JB 1H 472K-T	T	63.5/213.4
C287	4030006880	S.CER C1608 JB 1H 472K-T	T	67.9/221.2
C297	4030007140	S.CER C1608 CH 1H 121J-T	T	64.5/182.4
C302	4030007040	S.CER C1608 CH 1H 180J-T	T	65.2/188.8
C303	4030007120	S.CER C1608 CH 1H 820J-T	T	63.9/197.5
C304	4030007040	S.CER C1608 CH 1H 180J-T	T	65.2/197.5
C320	4030011600	S.CER C1608 JB 1E 104K-T	B	63.5/185.8
C321	4030011600	S.CER C1608 JB 1E 104K-T	B	64.5/198.8
C322	4030006880	S.CER C1608 JB 1H 472K-T	B	63.2/217.7
C323	4030006880	S.CER C1608 JB 1H 472K-T	B	63.2/214.6
C324	4030011770	S.CER C1608 CH 1H 060B-T	B	63.7/190.7
C327	4030007100	S.CER C1608 CH 1H 560J-T	B	63.5/184.2
C329	4030007110	S.CER C1608 CH 1H 680J-T	B	63.7/193.9
C331	4030007100	S.CER C1608 CH 1H 560J-T	B	64.5/200.4
C353	4030006880	S.CER C1608 JB 1H 472K-T	B	87.1/225.4
C354	4030006880	S.CER C1608 JB 1H 472K-T	B	89.8/224.1
C355	4030006880	S.CER C1608 JB 1H 472K-T	B	84.5/225.4
C356	4030006880	S.CER C1608 JB 1H 472K-T	B	83.1/235.1
C357	4030006880	S.CER C1608 JB 1H 472K-T	B	83.2/236.7
C358	4030006880	S.CER C1608 JB 1H 472K-T	B	80/233.5
C359	4030006880	S.CER C1608 JB 1H 472K-T	B	69.8/225.4
C360	4030006880	S.CER C1608 JB 1H 472K-T	B	72.6/225.4
C361	4030006880	S.CER C1608 JB 1H 472K-T	B	75.4/225.4
C388	4030006880	S.CER C1608 JB 1H 472K-T	B	78.5/240.7
C389	4030010210	S.CER C3216 JB 1C 105M-T	B	92/240.3
C390	4030011600	S.CER C1608 JB 1E 104K-T	B	105.7/234.1
C391	4030011600	S.CER C1608 JB 1E 104K-T	B	98.4/241
C392	4030011600	S.CER C1608 JB 1E 104K-T	B	83.5/242.2
C393	4030008860	S.CER C1608 JB 1H 153K-T	B	96.2/229.5
C394	4030010210	S.CER C3216 JB 1C 105M-T	B	92.2/234.1
C395	4030008860	S.CER C1608 JB 1H 153K-T	B	95.5/224.2
C396	4030011600	S.CER C1608 JB 1E 104K-T	B	109.8/227.9
C397	4550006470	S.TAN TEESVB2 1D 106M8R	T	108.3/228.8
C398	4030011600	S.CER C1608 JB 1E 104K-T	T	158/152.3
C399	4030011600	S.CER C1608 JB 1E 104K-T	T	147.3/147.6
C401	4030006880	S.CER C1608 JB 1H 472K-T	B	50.9/230.1
C402	4030010210	S.CER C3216 JB 1C 105M-T	B	41.9/235.1
C403	4030009520	S.CER C1608 CH 1H 020B-T	B	43.9/233.7
C404	4030007050	S.CER C1608 CH 1H 220J-T	B	43.9/236.5
C405	4030010760	S.CER C1608 CH 1H 331J-T	B	46.1/237.3
C410	4030006880	S.CER C1608 JB 1H 472K-T	B	38.6/224.9
C411	4030006880	S.CER C1608 JB 1H 472K-T	B	40.2/224.9
C421	4030006880	S.CER C1608 JB 1H 472K-T	B	84.5/139.5
C422	4030006880	S.CER C1608 JB 1H 472K-T	B	96.5/139.5
C423	4030006880	S.CER C1608 JB 1H 472K-T	B	86/135.7
C424	4030006880	S.CER C1608 JB 1H 472K-T	B	95.2/135.7
C425	4030006880	S.CER C1608 JB 1H 472K-T	B	89/135
C426	4030006880	S.CER C1608 JB 1H 472K-T	B	91.3/142.6
C427	4030006880	S.CER C1608 JB 1H 472K-T	B	93.1/142.6
C428	4030006880	S.CER C1608 JB 1H 472K-T	B	87.9/142.6
C431	4030006880	S.CER C1608 JB 1H 472K-T	B	32.5/224.9
C432	4030006880	S.CER C1608 JB 1H 472K-T	B	34.1/224.9
C501	4030011600	S.CER C1608 JB 1E 104K-T	T	162.7/33.8
C502	4030018590	S.CER C1608 CH 1H 122J-T	T	162.7/37.7
C503	4030018600	S.CER C1608 CH 1H 152J-T	T	162.7/41.6
C505	4030011330	S.CER C1608 CH 1H 391J-T	T	162.7/44.2
C506	4030011600	S.CER C1608 JB 1E 104K-T	T	157.9/44.8
C507	4510008540	S.ELE EEE1CA100SR	T	156.6/47.9
C508	4510008540	S.ELE EEE1CA100SR	T	156.6/33.9
C509	4030011600	S.CER C1608 JB 1E 104K-T	T	155.3/37
C510	4030008470	S.CER C1608 JB 1H 272K-T	T	150.5/41.6
C511	4030011280	S.CER C1608 CH 1H 271J-T	T	150.5/44.2
C512	4030011600	S.CER C1608 JB 1E 104K-T	T	145.7/44.8
C513	4510008540	S.ELE EEE1CA100SR	T	144.4/47.9
C514	4030011600	S.CER C1608 JB 1E 104K-T	T	143.1/37
C515	4510008540	S.ELE EEE1CA100SR	T	144.4/33.9
C516	4030017810	S.CER C1608 CH 1H 102J-T	B	132.9/39.1
C517	4030011600	S.CER C1608 JB 1E 104K-T	T	133.6/38
C518	4030011600	S.CER C1608 JB 1E 104K-T	T	133.6/43.8
C519	4030011600	S.CER C1608 JB 1E 104K-T	T	133.6/45.1
C520	4510008540	S.ELE EEE1CA100SR	T	133.6/48.2
C521	4030011600	S.CER C1608 JB 1E 104K-T	T	138.3/40.2
C522	4030011600	S.CER C1608 JB 1E 104K-T	T	126.6/45.8
C523	4030011600	S.CER C1608 JB 1E 104K-T	T	126.6/38
C524	4510008540	S.ELE EEE1CA100SR	T	126.9/34.9
C525	4030006880	S.CER C1608 JB 1H 472K-T	T	129.4/41.9
C526	4030011600	S.CER C1608 JB 1E 104K-T	T	123.7/40.6
C527	4030006880	S.CER C1608 JB 1H 472K-T	T	120.8/43.2
C528	4030011600	S.CER C1608 JB 1E 104K-T	T	118.1/34.4
C529	4030011600	S.CER C1608 JB 1E 104K-T	T	115.9/44.5
C530	4030011600	S.CER C1608 JB 1E 104K-T	T	107.9/44.5
C531	4030006880	S.CER C1608 JB 1H 472K-T	B	104.7/42
C532	4030006880	S.CER C1608 JB 1H 472K-T	B	112.7/42
C533	4030006880	S.CER C1608 JB 1H 472K-T	B	106.3/52.2
C534	4030006880	S.CER C1608 JB 1H 472K-T	B	114.3/52.2
C535	4030006880	S.CER C1608 JB 1H 472K-T	B	108.5/55.7
C536	4030011600	S.CER C1608 JB 1E 104K-T	B	115.9/58.8
C538	4030008920	S.CER C1608 JB 1H 473K-T	B	105.4/58.4
C539	4030011600	S.CER C1608 JB 1E 104K-T	T	116.5/55.7
C540	4510008540	S.ELE EEE1CA100SR	T	113.4/55.7
C541	4030011600	S.CER C1608 JB 1E 104K-T	B	111.4/59
C544	4030009530	S.CER C1608 CH 1H 030B-T	B	112/81.2
C546	4030011340	S.CER C1608 CH 1H 471J-T	B	100.9/70.2
C551	4030006880	S.CER C1608 JB 1H 472K-T	B	111.2/98.2
C552	4030017810	S.CER C1608 CH 1H 102J-T	B	111.2/105.5
C553	4030011770	S.CER C1608 CH 1H 060B-T	B	110.5/103.2
C554	4030011600	S.CER C1608 JB 1E 104K-T	B	108.2/96.1

[RF UNIT]

REF NO.	ORDER NO.	DESCRIPTION	M.	H/V LOCATION
C555	4030007030	S.CER C1608 CH 1H 150J-T	B	105/96.1
C556	4030006880	S.CER C1608 JB 1H 472K-T	B	105.8/93.7
C558	4030007040	S.CER C1608 CH 1H 180J-T	B	100.9/116.7
C559	4030006880	S.CER C1608 JB 1H 472K-T	B	90/124.4
C560	4030007080	S.CER C1608 CH 1H 390J-T	B	92.3/119.5
C561	4030006880	S.CER C1608 JB 1H 472K-T	B	97.3/116.9
C562	4030011810	S.CER C1608 CH 1H 102J-T	B	87/111.7
C563	4030007600	S.CER C1608 JB 1E 104K-T	B	98.8/126.7
C564	4030007080	S.CER C1608 CH 1H 390J-T	T	104.2/125.6
C565	4030007130	S.CER C1608 CH 1H 101J-T	T	108.8/125.4
C566	4030007120	S.CER C1608 CH 1H 820J-T	T	106.6/129.1
C567	4030007090	S.CER C1608 CH 1H 470J-T	T	110.8/125.9
C568	4030007130	S.CER C1608 CH 1H 101J-T	T	112.7/128.2
C569	4030011600	S.CER C1608 JB 1E 104K-T	T	120.7/124.7
C570	4030006900	S.CER C1608 JB 1H 103K-T	B	115.3/125.7
C571	4030011600	S.CER C1608 JB 1E 104K-T	B	128/126.2
C572	4030006900	S.CER C1608 JB 1H 103K-T	B	124.9/126.2
C573	4030011600	S.CER C1608 JB 1E 104K-T	B	115.3/115.8
C574	4030011600	S.CER C1608 JB 1E 104K-T	T	121.8/111.6
C576	4610001590	S.TRI TZC3R100A110R00	T	106.6/87
C577	4030011600	S.CER C1608 JB 1E 104K-T	T	121.8/114.4
C578	4030007100	S.CER C1608 CH 1H 560J-T	B	92/96.2
C579	4030006980	S.CER C1608 CH 1H 070D-T	B	94.6/97
C580	4030007100	S.CER C1608 CH 1H 560J-T	B	93.8/94.6
C581	4030007050	S.CER C1608 CH 1H 220J-T	B	153.5/40.9
C582	4030007050	S.CER C1608 CH 1H 220J-T	B	141.3/40.9
C584	4030009650	S.CER C1608 CH 1H 240J-T	B	91.6/108.2
C585	4030006980	S.CER C1608 CH 1H 070D-T	B	93.2/109.9
C586	4030007070	S.CER C1608 CH 1H 330J-T	B	94.9/108.2
C587	4030007010	S.CER C1608 CH 1H 100D-T	B	95.7/110.7
C588	4030007060	S.CER C1608 CH 1H 270J-T	B	96.5/108.2
C589	4030007020	S.CER C1608 CH 1H 120J-T	T	113.5/124.7
C590	4030007100	S.CER C1608 CH 1H 560J-T	T	117.3/126.6
C595	4030006860	S.CER C1608 JB 1H 102K-T	B	116.3/106
C601	4030017810	S.CER C1608 CH 1H 102J-T	B	125.7/66.4
C602	4030017810	S.CER C1608 CH 1H 102J-T	B	125.7/68.2
C603	4030011600	S.CER C1608 JB 1E 104K-T	B	129/66.4
C604	4030007140	S.CER C1608 CH 1H 121J-T	B	128.3/63.6
C605	4030010760	S.CER C1608 CH 1H 331J-T	B	130.1/63.6
C606	4030007160	S.CER C1608 CH 1H 181J-T	B	132.6/59.3
C607	4030007060	S.CER C1608 CH 1H 270J-T	B	132.6/61.1
C608	4030010760	S.CER C1608 CH 1H 331J-T	B	131.9/63.6
C609	4030007090	S.CER C1608 CH 1H 470J-T	B	137.3/63.6
C610	4030007160	S.CER C1608 CH 1H 181J-T	B	136.6/61.1
C611	4030007060	S.CER C1608 CH 1H 270J-T	B	136.6/59.3
C612	4030007140	S.CER C1608 CH 1H 121J-T	B	141/63.6
C613	4030010760	S.CER C1608 CH 1H 331J-T	B	139.1/63.6
C614	4030017810	S.CER C1608 CH 1H 102J-T	B	143.6/66.4
C615	4030011600	S.CER C1608 JB 1E 104K-T	B	140.3/66.4
C616	4030017810	S.CER C1608 CH 1H 102J-T	B	143.6/68.2
C617	4030017800	S.CER C1608 CH 1H 561J-T	B	125.7/77.2
C618	4030010760	S.CER C1608 CH 1H 331J-T	B	125.7/79
C619	4030011600	S.CER C1608 JB 1E 104K-T	B	129/77.2
C620	4030010760	S.CER C1608 CH 1H 331J-T	B	128.3/74.4
C621	4030007080	S.CER C1608 CH 1H 390J-T	B	130.1/74.4
C622	4030007080	S.CER C1608 CH 1H 390J-T	B	132.6/70
C623	4030010760	S.CER C1608 CH 1H 331J-T	B	132.6/71.9
C624	4030007090	S.CER C1608 CH 1H 470J-T	B	131.9/74.4
C625	4030010760	S.CER C1608 CH 1H 331J-T	B	137.3/74.4
C626	4030007080	S.CER C1608 CH 1H 390J-T	B	136.6/71.9
C627	4030010760	S.CER C1608 CH 1H 331J-T	B	136.6/70.1
C628	4030007080	S.CER C1608 CH 1H 390J-T	B	141/74.4
C629	4030010760	S.CER C1608 CH 1H 331J-T	B	139.1/74.4
C630	4030010760	S.CER C1608 CH 1H 331J-T	B	143.6/77.2
C631	4030011600	S.CER C1608 JB 1E 104K-T	B	140.3/77.2
C632	4030017800	S.CER C1608 CH 1H 561J-T	B	143.6/79
C633	4030017800	S.CER C1608 CH 1H 561J-T	B	125.7/88
C634	4030011330	S.CER C1608 CH 1H 391J-T	B	125.7/89.8
C635	4030011600	S.CER C1608 JB 1E 104K-T	B	129/88
C636	4030007160	S.CER C1608 CH 1H 181J-T	B	128.3/85.2

[RF UNIT]

REF NO.	ORDER NO.	DESCRIPTION	M.	H/V LOCATION
C671	4030007070	S.CER C1608 CH 1H 330J-T	B	132.6/104.4
C672	4030007050	S.CER C1608 CH 1H 220J-T	B	137.3/106.9
C673	4030007120	S.CER C1608 CH 1H 820J-T	B	131.9/106.9
C674	4030007080	S.CER C1608 CH 1H 390J-T	B	136.6/104.4
C675	4030007070	S.CER C1608 CH 1H 330J-T	B	136.6/102.6
C676	4030007050	S.CER C1608 CH 1H 220J-T	B	141/106.9
C677	4030007130	S.CER C1608 CH 1H 101J-T	B	139.1/106.9
C678	4030007170	S.CER C1608 CH 1H 221J-T	B	143.6/109.7
C679	4030011600	S.CER C1608 JB 1E 104K-T	B	140.3/109.7
C680	4030007170	S.CER C1608 CH 1H 221J-T	B	143.6/111.5
C681	4030007170	S.CER C1608 CH 1H 221J-T	T	127.4/59.8
C682	4030007110	S.CER C1608 CH 1H 680J-T	T	127.4/61.1
C683	4030011600	S.CER C1608 JB 1E 104K-T	T	130.2/61.1
C684	4030007090	S.CER C1608 CH 1H 470J-T	T	131/63.8
C685	4030007090	S.CER C1608 CH 1H 470J-T	T	132.3/63.8
C686	4030007070	S.CER C1608 CH 1H 330J-T	T	131.7/65.9
C687	4030007070	S.CER C1608 CH 1H 330J-T	T	131.7/67.2
C688	4030007010	S.CER C1608 CH 1H 100D-T	T	134.6/61.6
C689	4030007120	S.CER C1608 CH 1H 820J-T	T	134.6/62.9
C690	4030007070	S.CER C1608 CH 1H 330J-T	T	137.6/67.2
C691	4030007070	S.CER C1608 CH 1H 330J-T	T	137.6/65.9
C692	4030007090	S.CER C1608 CH 1H 470J-T	T	137.1/63.3
C693	4030007090	S.CER C1608 CH 1H 470J-T	T	138.4/63.3
C694	4030007110	S.CER C1608 CH 1H 680J-T	T	141.9/59.8
C695	4030011600	S.CER C1608 JB 1E 104K-T	T	139.1/61.1
C696	4030007050	S.CER C1608 CH 1H 220J-T	T	141.9/61.1
C697	4030007160	S.CER C1608 CH 1H 181J-T	T	126.6/69.5
C698	4030007090	S.CER C1608 CH 1H 470J-T	T	127.9/69.5
C699	4030011600	S.CER C1608 JB 1E 104K-T	T	130.2/70.1
C700	4030007090	S.CER C1608 CH 1H 470J-T	T	131/72.3
C701	4030007040	S.CER C1608 CH 1H 180J-T	T	132.3/72.3
C702	4030007030	S.CER C1608 CH 1H 150J-T	T	131.7/74.8
C703	4030007050	S.CER C1608 CH 1H 220J-T	T	131.7/76.2
C704	4030006990	S.CER C1608 CH 1H 080D-T	T	134.6/71.9
C705	4030007090	S.CER C1608 CH 1H 470J-T	T	134.6/70.6
C706	4030007030	S.CER C1608 CH 1H 150J-T	T	137.6/74.8
C707	4030007050	S.CER C1608 CH 1H 220J-T	T	137.6/76.2
C708	4030007040	S.CER C1608 CH 1H 180J-T	T	137.1/72.3
C709	4030007090	S.CER C1608 CH 1H 470J-T	T	138.4/72.3
C710	4030007090	S.CER C1608 CH 1H 470J-T	T	141.9/68.8
C711	4030011600	S.CER C1608 JB 1E 104K-T	T	139.1/70.1
C712	4030007160	S.CER C1608 CH 1H 181J-T	T	141.9/70.1
C713	4030007140	S.CER C1608 CH 1H 121J-T	T	127.4/79.1
C714	4030007040	S.CER C1608 CH 1H 180J-T	T	127.4/77.8
C715	4030011600	S.CER C1608 JB 1E 104K-T	T	130.2/79.1
C716	4030007070	S.CER C1608 CH 1H 330J-T	T	131/81.3
C717	4030007040	S.CER C1608 CH 1H 180J-T	T	132.3/81.3
C718	4030007010	S.CER C1608 CH 1H 100D-T	T	131.7/83.9
C719	4030007070	S.CER C1608 CH 1H 330J-T	T	131.7/85.2
C720	4030007010	S.CER C1608 CH 1H 100D-T	T	134.6/79.6
C721	4030007090	S.CER C1608 CH 1H 470J-T	T	134.6/80.9
C722	4030007010	S.CER C1608 CH 1H 100D-T	T	137.6/83.9
C723	4030007070	S.CER C1608 CH 1H 330J-T	T	137.6/85.2
C724	4030007040	S.CER C1608 CH 1H 180J-T	T	137.1/81.3
C725	4030007070	S.CER C1608 CH 1H 330J-T	T	138.4/81.3
C726	4030007040	S.CER C1608 CH 1H 180J-T	T	141.9/77.8
C727	4030011600	S.CER C1608 JB 1E 104K-T	T	139.1/79.1
C728	4030007140	S.CER C1608 CH 1H 121J-T	T	141.9/79.1
C729	4030007130	S.CER C1608 CH 1H 101J-T	T	127.4/88.1
C730	4030007030	S.CER C1608 CH 1H 150J-T	T	127.4/86.8
C731	4030011600	S.CER C1608 JB 1E 104K-T	T	130.2/88.1
C732	4030007050	S.CER C1608 CH 1H 220J-T	T	131/90.3
C733	4030007020	S.CER C1608 CH 1H 120J-T	T	132.3/90.3
C734	4030009500	S.CER C1608 CH 1H 0R5B-T	T	131.7/92.9
C735	4030007050	S.CER C1608 CH 1H 220J-T	T	131.7/94.2
C736	4030006980	S.CER C1608 CH 1H 070D-T	T	134.6/88.6
C737	4030007050	S.CER C1608 CH 1H 220J-T	T	134.6/89.9
C738	4030009500	S.CER C1608 CH 1H 0R5B-T	T	137.6/92.9
C739	4030007050	S.CER C1608 CH 1H 220J-T	T	137.6/94.2
C740	4030007020	S.CER C1608 CH 1H 120J-T	T	131.7/90.3
C741	4030007050	S.CER C1608 CH 1H 220J-T	T	138.4/90.3
C742	4030007030	S.CER C1608 CH 1H 150J-T	T	141.9/86.8
C743	4030011600	S.CER C1608 JB 1E 104K-T	T	139.1/88.1
C744	4030007130	S.CER C1608 CH 1H 101J-T	T	141.9/88.1
C745	4030007140	S.CER C1608 CH 1H 121J-T	T	128.5/99
C747	4030011600	S.CER C1608 JB 1E 104K-T	T	129.3/97
C749	4030009550	S.CER C1608 CH 1H 2R5B-T	T	131.9/101.4
C750	4030011770	S.CER C1608 CH 1H 060B-T	T	131.2/99.3
C751	4030007010	S.CER C1608 CH 1H 100D-T	T	132.6/99.3
C755	4030009550	S.CER C1608 CH 1H 2R5B-T	T	137.1/101.4
C756	4030011770	S.CER C1608 CH 1H 060B-T	T	137.9/99.3
C758	4030011600	S.CER C1608 JB 1E 104K-T	T	140/97
C759	4030007140	S.CER C1608 CH 1H 121J-T	T	140.8/99
C760	4030011770	S.CER C1608 CH 1H 060B-T	T	129.9/99.3
C761	4030011770	S.CER C1608 CH 1H 060B-T	T	136.3/99.3
C801	4030006880	S.CER C1608 JB 1H 472K-T	T	158/62.9
C802	4030011600	S.CER C1608 JB 1E 104K-T	T	151.1/62.9
C803	4030011600	S.CER C1608 JB 1E 104K-T	B	153.6/61.4
C804	4030011600	S.CER C1608 JB 1E 104K-T	T	159.1/73.1
C805	4030011600	S.CER C1608 JB 1E 104K-T	B	153.8/79.6
C806	4030006900	S.CER C1608 JB 1H 103K-T	B	154.6/76.1
C807	4030011600	S.CER C1608 JB 1E 104K-T	T	153.4/74.7
C812	4030006900	S.CER C1608 JB 1H 103K-T	B	163.6/99.1
C813	4030006880	S.CER C1608 JB 1H 472K-T	T	150.6/56.5
C814	4030012600	S.CER C2012 JB 1A 105M-T	T	152.2/56.2
C815	4030006990	S.CER C1608 CH 1H 080D-T	B	158/70.1
C816	4030012600	S.CER C2012 JB 1A 105M-T	T	149/56.1
C839	4030006880	S.CER C1608 JB 1H 472K-T	B	89.1/98
C840	4030011600	S.CER C1608 JB 1E 104K-T	B	85/96.5
C841	4030006880	S.CER C1608 JB 1H 472K-T	B	87.4/92.6
C871	4030006880	S.CER C1608 JB 1H 472K-T	B	27.7/224.5
C872	4030006880	S.CER C1608 JB 1H 472K-T	B	24.6/225
C904	4030006900	S.CER C1608 JB 1H 103K-T	B	71/142.3
C906	4030006880	S.CER C1608 JB 1H 472K-T	B	62.2/135.6

[RF UNIT]

REF NO.	ORDER NO.	DESCRIPTION	M.	H/V LOCATION
C907	4030011600	S.CER C1608 JB 1E 104K-T	B	80.5/139.8
C909	4030011600	S.CER C1608 JB 1E 104K-T	B	65.7/135
C910	4030006880	S.CER C1608 JB 1H 472K-T	T	79.7/143.5
C911	4030009920	S.CER C1608 CH 1H 050B-T	B	60.3/139.3
C912	4030006900	S.CER C1608 JB 1H 103K-T	B	81.7/137
C913	4030011600	S.CER C1608 JB 1E 104K-T	B	75.1/134.2
C914	4030006880	S.CER C1608 JB 1H 472K-T	T	79.7/140.8
C915	4030006900	S.CER C1608 JB 1H 103K-T	B	68.8/134.2
C917	4030007010	S.CER C1608 CH 1H 100D-T	B	68.6/128.1
C919	4030006880	S.CER C1608 JB 1H 472K-T	B	60.3/145.6
C920	4030006880	S.CER C1608 JB 1H 472K-T	B	60.6/131
C1001	4030007170	S.CER C1608 CH 1H 221J-T	T	16.6/137.1
C1008	4030006880	S.CER C1608 JB 1H 472K-T	B	50.7/134.3
C1009	4030006880	S.CER C1608 JB 1H 472K-T	B	49.9/119.8
C1010	4030012600	S.CER C2012 JB 1A 105M-T	B	38.1/139.5
C1011	4030012600	S.CER C2012 JB 1A 105M-T	T	38.1/144.4
C1012	4030010210	S.CER C3216 JB 1C 105M-T	B	38.8/145.6
C1013	4030012600	S.CER C2012 JB 1A 105M-T	T	38.1/138.6
C1014	4030018810	S.CER C3216 CH 1H 333J-T	T	25.5/147.7
C1016	4030012600	S.CER C2012 JB 1A 105M-T	B	41.4/129.2
C1017	4030012600	S.CER C2012 JB 1A 105M-T	B	41.4/118.2
C1020	4030012600	S.CER C2012 JB 1A 105M-T	B	33.5/126.1
C1021	4030012600	S.CER C2012 JB 1A 105M-T	B	33.5/112.2
C1024	4030010210	S.CER C3216 JB 1C 105M-T	B	29.7/125.5
C1025	4030010210	S.CER C3216 JB 1C 105M-T	B	29.6/111.6
C1026	4030010210	S.CER C3216 JB 1C 105M-T	B	22.1/132.5
C1027	4030010210	S.CER C3216 JB 1C 105M-T	B	22.1/119.9
C1028	4030006880	S.CER C1608 JB 1H 472K-T	B	11.5/122.4
C1029	4030006880	S.CER C1608 JB 1H 472K-T	B	12.2/136.9
C1032	4030011600	S.CER C1608 JB 1E 104K-T	T	15.4/131.3
C1033	4550006470	S.TAN TEESVB2 1D 106M8R	B	38.2/150.2
C1034	4550006470	S.TAN TEESVB2 1D 106M8R	T	19.5/131.4
C1037	4030007090	S.CER C1608 CH 1H 470J-T	T	24.3/144.5
C1038	4030017810	S.CER C1608 CH 1H 102J-T	T	37.7/141.5
C1039	4030017810	S.CER C1608 CH 1H 102J-T	B	39.9/147.3
C1040	4030017810	S.CER C1608 CH 1H 102J-T	B	35.7/137.7
C1041	4030006990	S.CER C1608 CH 1H 080D-T	T	27.3/141.3
C1046	4030007010	S.CER C1608 CH 1H 100D-T	B	18.7/125.9
C1048	4030017810	S.CER C1608 CH 1H 102J-T	B	31.3/129.8
C1049	4030017810	S.CER C1608 CH 1H 102J-T	B	31.3/116
C1050	4030017810	S.CER C1608 CH 1H 102J-T	B	28.8/127.5
C1051	4030017810	S.CER C1608 CH 1H 102J-T	B	28.8/113.6
C1052	4030007100	S.CER C1608 CH 1H 560J-T	B	44.9/119.3
C1053	4030007110	S.CER C1608 CH 1H 680J-T	T	3.1/141.7
C1054	4030007010	S.CER C1608 CH 1H 100D-T	T	4.4/141.7
C1055	4030007140	S.CER C1608 CH 1H 121J-T	T	3.6/139.6
C1056	4030007050	S.CER C1608 CH 1H 220J-T	T	3.6/138.3
C1057	4030007130	S.CER C1608 CH 1H 101J-T	T	3.1/136.1
C1060	4030017810	S.CER C1608 CH 1H 102J-T	B	3.1/109
C1061	4030007090	S.CER C1608 CH 1H 470J-T	T	49.2/83.9
C1062	4030007170	S.CER C1608 CH 1H 221J-T	T	50.5/83.9
C1064	4030007090	S.CER C1608 CH 1H 470J-T	T	50/81.8
C1066	4030007010	S.CER C1608 CH 1H 100D-T	T	50/77.8
C1067	4030007010	S.CER C1608 CH 1H 100D-T	T	3.6/133.8
C1068	4030009510	S.CER C1608 CH 1H 010B-T	B	28.9/132.2
C1069	4030009510	S.CER C1608 CH 1H 010B-T	B	28.9/118.4
C1070	4030006990	S.CER C1608 CH 1H 070D-T	T	50/79.2
C1071	4030007100	S.CER C1608 CH 1H 560J-T	T	5.7/128.3
C1072	4030007170	S.CER C1608 CH 1H 221J-T	T	3.6/125.6
C1073	4030007080	S.CER C1608 CH 1H 390J-T	T	4.4/128.3
C1074	4030007060	S.CER C1608 CH 1H 270J-T	T	50/80.5
C1081	4030006900	S.CER C1608 JB 1H 103K-T	B	38.3/96.1
C1082	4030006900	S.CER C1608 JB 1H 103K-T	B	39.7/91.8
C1083	4030006900	S.CER C1608 JB 1H 103K-T	T	42.6/90.3
C1084	4030006880	S.CER C1608 JB 1H 472K-T	T	41/88.2
C1085	4030006880	S.CER C1608 JB 1H 472K-T	T	39.7/88.2
C1091	4030006880	S.CER C1608 JB 1H 472K-T	T	51.8/51.9
C1092	4030006880	S.CER C1608 JB 1H 472K-T	T	51.8/54.6
C1093	4030006880	S.CER C1608 JB 1H 472K-T	T	

[RF UNIT]

REF NO.	ORDER NO.	DESCRIPTION	M.	H/V LOCATION
C1228	4030009920	S.CER C1608 CH 1H 050B-T	B	64.1/101.5
C1231	4030006900	S.CER C1608 JB 1H 103K-T	B	59.4/114.4
C1232	4030006900	S.CER C1608 JB 1H 103K-T	B	68.9/114.4
C1234	4030006900	S.CER C1608 JB 1H 103K-T	B	48.6/106
C1235	4030006880	S.CER C1608 JB 1H 472K-T	B	59.4/104.6
C1236	4030006900	S.CER C1608 JB 1H 103K-T	B	58.5/104.6
C1238	4030006900	S.CER C1608 JB 1H 103K-T	B	62.6/106
C1239	4030006880	S.CER C1608 JB 1H 472K-T	B	73.4/104.6
C1240	4030006900	S.CER C1608 JB 1H 103K-T	T	69.7/104.6
C1241	4030006900	S.CER C1608 JB 1H 103K-T	T	69.7/98.3
C1244	4030007040	S.CER C1608 CH 1H 180J-T	T	52.2/97
C1245	4030007130	S.CER C1608 CH 1H 101J-T	T	49.4/97
C1246	4030007120	S.CER C1608 CH 1H 820J-T	T	50.6/99.8
C1247	4030007090	S.CER C1608 CH 1H 470J-T	T	47.2/99.8
C1248	4030007130	S.CER C1608 CH 1H 101J-T	T	48/102
C1249	4030007020	S.CER C1608 CH 1H 120J-T	T	44.9/102
C1250	4030007040	S.CER C1608 CH 1H 180J-T	T	47.2/104.2
C1251	4030006900	S.CER C1608 JB 1H 103K-T	T	27.2/94.3
C1252	4030006900	S.CER C1608 JB 1H 103K-T	T	34.8/94.3
C1253	4030006900	S.CER C1608 JB 1H 103K-T	B	34.9/76
C1255	4030017810	S.CER C1608 CH 1H 102J-T	B	31/87.9
C1256	4030007010	S.CER C1608 CH 1H 100D-T	T	31/88.2
C1257	4030011600	S.CER C1608 JB 1E 104K-T	B	31/83.6
C1258	4030007080	S.CER C1608 CH 1H 390J-T	B	37/89.5
C1264	4030007110	S.CER C1608 CH 1H 680J-T	B	64.1/99.2
C1265	4610001830	S.TRI TZB4S100AB10R00	T	41/107.4
C1266	4030007020	S.CER C1608 CH 1H 120J-T	T	44.9/107.8
C1267	4030006880	S.CER C1608 JB 1H 472K-T	B	29.9/60.5
C1268	4030006980	S.CER C1608 CH 1H 070D-T	T	49.4/95.7
C1302	4030007060	S.CER C1608 CH 1H 270J-T	T	28.1/76.1
C1303	4030006980	S.CER C1608 CH 1H 070D-T	T	28.1/74.1
C1304	4030007070	S.CER C1608 CH 1H 330J-T	T	28.1/72.8
C1305	4030007010	S.CER C1608 CH 1H 100D-T	T	34/72.4
C1306	4030009650	S.CER C1608 CH 1H 240J-T	T	28.1/71.5
C1307	4030007030	S.CER C1608 CH 1H 150J-T	T	34/66.9
C1308	4030006900	S.CER C1608 JB 1H 103K-T	T	33.6/60.4
C1309	4030007080	S.CER C1608 CH 1H 390J-T	T	31/59.9
C1310	4030007080	S.CER C1608 CH 1H 390J-T	T	29.5/57.3
C1311	4030006900	S.CER C1608 JB 1H 103K-T	B	37.3/69
C1312	4030007060	S.CER C1608 CH 1H 270J-T	T	32/75.3
C1313	4030007060	S.CER C1608 CH 1H 270J-T	T	29.5/58.6
C1314	4030007030	S.CER C1608 CH 1H 150J-T	T	31.4/69.3
C1355	4030006880	S.CER C1608 JB 1H 472K-T	B	68.1/73.8
C1357	4030007000	S.CER C1608 CH 1H 090D-T	T	64.5/72.5
C1358	4030011600	S.CER C1608 JB 1E 104K-T	B	64.4/77.8
C1360	4030011600	S.CER C1608 JB 1E 104K-T	T	68/75.2
C1361	4030007020	S.CER C1608 CH 1H 120J-T	B	60.2/82.2
C1403	4030017810	S.CER C1608 CH 1H 102J-T	T	34.3/52.7
C1404	4030017810	S.CER C1608 CH 1H 102J-T	B	34.7/2.9
C1405	4030006900	S.CER C1608 JB 1H 103K-T	T	42.1/57.7
C1406	4030017810	S.CER C1608 CH 1H 102J-T	T	32.1/46.3
C1407	4030017810	S.CER C1608 CH 1H 102J-T	T	27.3/46.3
C1418	4030017810	S.CER C1608 CH 1H 102J-T	T	27.1/4.6
C1419	4030017810	S.CER C1608 CH 1H 102J-T	B	34.7/6.1
C1420	4030007120	S.CER C1608 CH 1H 820J-T	T	55.1/5
C1421	4030007150	S.CER C1608 CH 1H 151J-T	T	55.1/7.8
C1423	4030010750	S.CER C1608 CH 1H 201J-T	T	52.4/12.8
C1424	4030007010	S.CER C1608 CH 1H 100D-T	B	56.5/10.9
C1425	4030011600	S.CER C1608 JB 1E 104K-T	B	58.1/21.6
C1426	4030011600	S.CER C1608 JB 1E 104K-T	B	58.1/20
C1427	4030006900	S.CER C1608 JB 1H 103K-T	B	55.7/19.9
C1428	4030006980	S.CER C1608 CH 1H 070D-T	T	65.4/15
C1429	4030006900	S.CER C1608 JB 1H 103K-T	T	68/15
C1430	4030007040	S.CER C1608 CH 1H 180J-T	B	79.6/12.6
C1431	4030017810	S.CER C1608 CH 1H 102J-T	T	65.4/6.2
C1432	4030018600	S.CER C1608 CH 1H 152J-T	B	79.6/9.8
C1433	4030011600	S.CER C1608 JB 1E 104K-T	T	67.5/6.7
C1434	4030009920	S.CER C1608 CH 1H 050B-T	B	98.1/13.9
C1435	4030009920	S.CER C1608 CH 1H 050B-T	B	94.9/13.9
C1436	4030011600	S.CER C1608 JB 1E 104K-T	B	72.3/5.4
C1437	4030007170	S.CER C1608 CH 1H 221J-T	B	77.8/9.8
C1441	4030006880	S.CER C1608 JB 1H 472K-T	T	66.7/15
C1501	4030018640	S.CER C2012 CH 1H 103J-T	T	88/5.4
C1502	4550003220	S.TAN TEESVA 1E 105M8R	T	106/7.6
C1503	4030006900	S.CER C1608 JB 1H 103K-T	T	107.2/21.5
C1504	4030012610	S.CER C2012 JB 1C 474K-T	T	107/23.1
C1505	4030007010	S.CER C1608 CH 1H 100D-T	T	110/5.4
C1506	4030010760	S.CER C1608 CH 1H 331J-T	T	113.1/6.7
C1507	4510008540	S.ELE EEE1CA100SR	T	111.8/28.7
C1508	4030011600	S.CER C1608 JB 1E 104K-T	T	108.7/30.5
C1509	4030018800	S.CER C3216 CH 1H 223J-T	T	112/11
C1510	4030007110	S.CER C1608 CH 1H 680J-T	T	121.2/3.8
C1511	4510008540	S.ELE EEE1CA100SR	T	118.1/12.7
C1512	4030011600	S.CER C1608 JB 1E 104K-T	T	119.7/15.8
C1513	4030011600	S.CER C1608 JB 1E 104K-T	T	122.4/15.8
C1514	4510008540	S.ELE EEE1CA100SR	T	124/12.7
C1515	4030007160	S.CER C1608 CH 1H 181J-T	T	129/13.2
C1516	4030009350	S.CER C1608 CH 1H 3R5B-T	T	129/14.5
C1517	4030007110	S.CER C1608 CH 1H 680J-T	T	121.1/29.6
C1518	4030018640	S.CER C2012 CH 1H 103J-T	T	96.5/5.4
C1519	4550003220	S.TAN TEESVA 1E 105M8R	T	105.9/19.8
C1520	4030006900	S.CER C1608 JB 1H 103K-T	T	107.2/9.3
C1521	4030012610	S.CER C2012 JB 1C 474K-T	T	107/10.9
C1522	4030007010	S.CER C1608 CH 1H 100D-T	T	110/17.6
C1523	4030010760	S.CER C1608 CH 1H 331J-T	T	113.1/18.9
C1524	4030018800	S.CER C3216 CH 1H 223J-T	T	111.9/23.2
C1525	4510008540	S.ELE EEE1CA100SR	T	118.1/20.7
C1526	4030011600	S.CER C1608 JB 1E 104K-T	T	119.7/17.6
C1527	4030011600	S.CER C1608 JB 1E 104K-T	T	122.4/17.6
C1528	4510008540	S.ELE EEE1CA100SR	T	124/20.7
C1529	4030017870	S.CER C1608 CH 1H 681J-T	T	129/20.2
C1530	4030011330	S.CER C1608 CH 1H 391J-T	T	129/18.9
C1531	4510008500	S.ELE EEE1CA101WP	T	141.4/26.5
C1532	4030011600	S.CER C1608 JB 1E 104K-T	B	137.5/24.2

[RF UNIT]

REF NO.	ORDER NO.	DESCRIPTION	M.	H/V LOCATION
C1533	4030011600	S.CER C1608 JB 1E 104K-T	B	135.5/24.2
C1534	4510008500	S.ELE EEE1CA101WP	T	134.3/26.5
C1535	4030011600	S.CER C1608 JB 1E 104K-T	T	143.3/14.5
C1536	4030017870	S.CER C1608 CH 1H 681J-T	T	142.9/19.5
C1537	4510008500	S.ELE EEE1CA101WP	T	156.5/14.7
C1538	4030011600	S.CER C1608 JB 1E 104K-T	T	154.7/10.2
C1539	4030011600	S.CER C1608 JB 1E 104K-T	T	151.5/24.2
C1540	4510008500	S.ELE EEE1CA101WP	T	156.5/21.8
C1541	4030007050	S.CER C1608 CH 1H 220J-T	T	147.7/25.2
C1651	4030006880	S.CER C1608 JB 1H 472K-T	B	95.7/35.9
C1652	4030006880	S.CER C1608 JB 1H 472K-T	B	97.9/37.6
C1653	4030006880	S.CER C1608 JB 1H 472K-T	B	102.1/36.8
C1654	4030017810	S.CER C1608 CH 1H 102J-T	B	98.3/31.8
C1655	4030009530	S.CER C1608 CH 1H 030B-T	T	100.3/28.9
C1656	4610001970	S.TRI TZC3P200A110R00	T	99.7/25.6
C1657	4030017810	S.CER C1608 CH 1H 102J-T	T	85.9/19.9
C1658	4030017810	S.CER C1608 CH 1H 102J-T	T	94.1/19.9
C1659	4030011600	S.CER C1608 JB 1E 104K-T	T	83.5/28.7
C1660	4030011600	S.CER C1608 JB 1E 104K-T	B	158/14.5
C1661	4030011600	S.CER C1608 JB 1E 104K-T	B	153.4/3.6
C1662	4030011600	S.CER C1608 JB 1E 104K-T	T	150.3/4.2
C1663	4030011600	S.CER C1608 JB 1E 104K-T	T	143.3/11.9
C1665	4030006900	S.CER C1608 JB 1H 103K-T	B	152.3/7.1
C1666	4030006880	S.CER C1608 JB 1H 472K-T	B	82.9/35
C1701	4030006880	S.CER C1608 JB 1H 472K-T	B	75/100
C1702	4030006880	S.CER C1608 JB 1H 472K-T	B	75.8/104
C1703	4510004601	ELE 16 ME 1000 HC	T	66.9/24.1
C1704	4030011600	S.CER C1608 JB 1E 104K-T	T	64/24.1
C1705	4030011600	S.CER C1608 JB 1E 104K-T	T	58.1/27.8
C1706	4510009150	S.ELE EEE1EA470WP	T	117.3/148.2
C1707	4030011600	S.CER C1608 JB 1E 104K-T	T	104.9/138.6
C1717	4030006880	S.CER C1608 JB 1H 472K-T	T	104.9/140.2
C1718	4030006880	S.CER C1608 JB 1H 472K-T	T	104.9/143.4
C1720	4030006880	S.CER C1608 JB 1H 472K-T	T	104.9/141.8
C1721	4030006880	S.CER C1608 JB 1H 472K-T	T	104.9/145
C1722	4030006880	S.CER C1608 JB 1H 472K-T	T	104.9/146.6
C1723	4030006880	S.CER C1608 JB 1H 472K-T	T	126.6/147.5
C1724	4030011600	S.CER C1608 JB 1E 104K-T	B	121.3/137.3
C1725	4030011600	S.CER C1608 JB 1E 104K-T	T	136/126.9
C1901	4030011600	S.CER C1608 JB 1E 104K-T	T	149.6/126.9
C1902	4030011600	S.CER C1608 JB 1E 104K-T	T	143.7/137.7
C1903	4030011600	S.CER C1608 JB 1E 104K-T	T	157.1/137.7
C1904	4030011600	S.CER C1608 JB 1E 104K-T	B	129.3/242.3
C2001	4030007130	S.CER C1608 CH 1H 101J-T	B	142/238.7
C2002	4030006880	S.CER C1608 JB 1H 472K-T	B	146.5/139.7
C2003	4030006880	S.CER C1608 JB 1H 472K-T	T	159/173.7
C2004	4030011340	S.CER C1608 CH 1H 471J-T	T	172.8/171.6
C2006	4030011340	S.CER C1608 CH 1H 471J-T	T	167/189.7
C2007	4510009150	S.ELE EEE1EA470WP	T	159.1/175.2
C2009	4030011340	S.CER C1608 CH 1H 471J-T	T	167/218.4
C2010	4510009150	S.ELE EEE1EA470WP	T	172.8/178.8
C2012	4030011340	S.CER C1608 CH 1H 471J-T	T	163.5/209.3
C2013	4030006880	S.CER C1608 JB 1H 472K-T	T	163.5/206.7
C2015	4030006880	S.CER C1608 JB 1H 472K-T	T	163.5/204.1
C2016	4030006880	S.CER C1608 JB 1H 472K-T	T	163.5/201.5
C2017	4030006880	S.CER C1608 JB 1H 472K-T	T	172.8/156.9
C2018	4030006880	S.CER C1608 JB 1H 472K-T	T	163.5/198.9
C2019	4030006880	S.CER C1608 JB 1H 472K-T	T	172.8/161.5
C2020	4030006880	S.CER C1608 JB 1H 472K-T	T	172.8/168.9
C2021	4030011340	S.CER C1608 CH 1H 471J-T	T	159/170.7
C2022	4030011340	S.CER C1608 CH 1H 471J-T	T	159/172.2
C2023	4030011340	S.CER C1608 CH 1H 471J-T	T	
RL1	6330001860	RLY UA2-12NU		
RL2	6330001860	RLY UA2-12NU		
RL21	6330001860	RLY UA2-12NU		
RL22	6330001860	RLY UA2-12NU		
RL51	6330001860	RLY UA2-12NU		
RL52	6330001860	RLY UA2-12NU		
RL81	6330001860	RLY UA2-12NU		
RL82	6330001860	RLY UA2-12NU		
RL111	6330001860	RLY UA2-12NU		
RL112	6330001860	RLY UA2-12NU		
RL141	6330001860	RLY UA2-12NU		
RL142	6330001860</			

[RF UNIT]

REF NO.	ORDER NO.	DESCRIPTION	M.	H/V LOCATION
J103	6510023750	CNR 01K1971-10		
J104	6510023750	CNR 01K1971-10		
J105	6510023750	CNR 01K1971-10		
J106	6510007020	CNR TMP-J01X-V6		
J108	6510007020	CNR TMP-J01X-V6		
J351	6510007020	CNR TMP-J01X-V6		
J352	6510007020	CNR TMP-J01X-V6		
J391	6510007020	CNR TMP-J01X-V6		
J501	6510007020	CNR TMP-J01X-V6		
J502	6510007020	CNR TMP-J01X-V6		
J503	6510007020	CNR TMP-J01X-V6		
J801	6510007020	CNR TMP-J01X-V6		
J808	6510007020	CNR TMP-J01X-V6		
J810	6510007020	CNR TMP-J01X-V6		
J1001	6510007020	CNR TMP-J01X-V6		
J1101	6510007020	CNR TMP-J01X-V6		
J1301	6510007020	CNR TMP-J01X-V6		
J1401	6910004741	CNR IMSA-9202B-1-03Z041-PT1		
J1402	6910004741	CNR IMSA-9202B-1-03Z041-PT1		
J1403	6910004741	CNR IMSA-9202B-1-03Z041-PT1		
J1404	6910004741	CNR IMSA-9202B-1-03Z041-PT1		
J1405	6910004741	CNR IMSA-9202B-1-03Z041-PT1		
J1406	6910004741	CNR IMSA-9202B-1-03Z041-PT1		
J1501	6510015541	S.CNR B4B-ZR-SM4-TF (LF) (SN)		168.2/21.6
J1651	6510007020	CNR TMP-J01X-V6		
J2001	6510024940	CNR HEC2305-016250		
J2002	6510023730	CNR LGY6502-0600C		
J2003	6510023730	CNR LGY6502-0600C		
J2004	6510007020	CNR TMP-J01X-V6		
J2006	6510019991	S.CNR 52808-2271 (2291)		168.3/166.7
J2007	6510018921	S.CNR B8B-PH-SM4-TB (LF) (SN)		168.2/204.1
F3	5210000041	FUS FGB 2A PBF (FGB0 125V)		
F2001	5220000230	HOL S-N5054 #01		
F2002	5220000230	HOL S-N5054 #01		
W1	8970024311	WIR 1.5D COAXIAL TUBE/C31		
W3	9030090170	WIR OPC-1805		
W1411	7120000480	S.JMP MJP-0.4-T		67.2/15
EP902	6910012350	S.BEA MMZ1608Y 102BT	B	60.6/134.1
EP903	6910012350	S.BEA MMZ1608Y 102BT	B	60.6/148.7
EP904	6910012350	S.BEA MMZ1608Y 102BT	B	104.9/141.8
EP1091	6910014690	S.BEA MPZ1608S221A-T	T	49/51.9
EP1092	6910014690	S.BEA MPZ1608S221A-T	T	49/53.2
EP1093	6910014690	S.BEA MPZ1608S221A-T	T	49/54.5
EP1201	6910012350	S.BEA MMZ1608Y 102BT	B	59/124.9
EP1202	6910012350	S.BEA MMZ1608Y 102BT	B	59/94.2
EP1210	6910012350	S.BEA MMZ1608Y 102BT	B	59/128
EP1229	6910014690	S.BEA MPZ1608S221A-T	B	28.2/69.2
EP1309	6910014690	S.BEA MPZ1608S221A-T	B	38.1/72.4
EP1504	6910014690	S.BEA MPZ1608S221A-T	B	132.3/22.7
EP1505	6910014690	S.BEA MPZ1608S221A-T	T	143.3/10.6
EP1654	6910012350	S.BEA MMZ1608Y 102BT	B	84.5/35
EP1801	6910012350	S.BEA MMZ1608Y 102BT	B	78.9/102.4
EP1802	6910012350	S.BEA MMZ1608Y 102BT	T	41.6/139.1
EP1803	6910014690	S.BEA MPZ1608S221A-T	B	75.8/102.4
EP1805	6910012350	S.BEA MMZ1608Y 102BT	B	104.9/143.4
EP1806	6910012350	S.BEA MMZ1608Y 102BT	B	78.9/105.6
EP1807	6910012350	S.BEA MMZ1608Y 102BT	B	75.8/105.6
EP1808	6910012350	S.BEA MMZ1608Y 102BT	B	154.1/14.5
EP1809	6910012350	S.BEA MMZ1608Y 102BT	B	104.9/145
EP1810	6910012350	S.BEA MMZ1608Y 102BT	T	23.1/132.8
EP1811	6910012350	S.BEA MMZ1608Y 102BT	T	23.1/135.6
EP1812	6910012350	S.BEA MMZ1608Y 102BT	B	104.9/146.6
EP1813	6910012350	S.BEA MMZ1608Y 102BT	T	55.2/131.7
EP1814	6910012350	S.BEA MMZ1608Y 102BT	T	55.2/130.4
EP1815	6910012350	S.BEA MMZ1608Y 102BT	T	6.8/124
EP1816	6910012350	S.BEA MMZ1608Y 102BT	T	55.2/133
EP1817	6910012350	S.BEA MMZ1608Y 102BT	B	15.4/140.2
EP1818	6910012350	S.BEA MMZ1608Y 102BT	B	104.9/138.6
EP1826	6910012350	S.BEA MMZ1608Y 102BT	B	104.9/140.2
EP1828	6910014690	S.BEA MPZ1608S221A-T	B	172.1/100
EP1830	6910012350	S.BEA MMZ1608Y 102BT	B	69.6/10.5
EP1831	6910012350	S.BEA MMZ1608Y 102BT	T	38.4/88.2
EP1832	6910012350	S.BEA MMZ1608Y 102BT	T	42.3/88.2
EP1833	6910012350	S.BEA MMZ1608Y 102BT	T	49/50.6
EP1834	6910012350	S.BEA MMZ1608Y 102BT	B	27.5/2.9
EP1835	6910012350	S.BEA MMZ1608Y 102BT	T	49/48
EP1836	6910012350	S.BEA MMZ1608Y 102BT	B	27.5/6.1
EP1837	6910012350	S.BEA MMZ1608Y 102BT	T	49/49.3
EP1838	6910012350	S.BEA MMZ1608Y 102BT	B	27.5/4.5
EP1901	6910014690	S.BEA MPZ1608S221A-T	T	136.8/137.7
EP2001	6910012350	S.BEA MMZ1608Y 102BT	B	166.5/245.8
EP2002	6910014690	S.BEA MPZ1608S221A-T	T	115.4/235.4
EP2003	6910012350	S.BEA MMZ1608Y 102BT	B	142.1/245.8
EP2004	6910012350	S.BEA MMZ1608Y 102BT	T	172.8/177.5
EP2005	6910012350	S.BEA MMZ1608Y 102BT	T	161.9/175.2
EP2006	6910012350	S.BEA MMZ1608Y 102BT	T	172.8/172.9
EP2007	6910012350	S.BEA MMZ1608Y 102BT	T	161.9/173.7
EP2008	6910012350	S.BEA MMZ1608Y 102BT	T	161.9/172.2
EP2009	6910012350	S.BEA MMZ1608Y 102BT	T	161.9/170.7
EP2010	6910012350	S.BEA MMZ1608Y 102BT	T	172.8/170.2
EP2011	6910012350	S.BEA MMZ1608Y 102BT	T	172.8/160.2
EP2012	6910012350	S.BEA MMZ1608Y 102BT	T	172.8/158.2
EP2013	6910014690	S.BEA MPZ1608S221A-T	T	163.5/208
EP2014	6910014690	S.BEA MPZ1608S221A-T	T	163.5/205.4
EP2015	6910014690	S.BEA MPZ1608S221A-T	T	163.5/202.8
EP2016	6910014690	S.BEA MPZ1608S221A-T	T	163.5/200.2
EP2017	6910014690	S.BEA MPZ1608S221A-T	T	163.5/197.6
EP2018	6910014690	S.BEA MPZ1608S221A-T	T	163.5/210.6

[MCF-W BOARD]

REF NO.	ORDER NO.	DESCRIPTION	M.	H/V LOCATION
F11401	2030000281	S.MLH FL-364A (64.455 MHz)	T	19.9/6.5
L1401	6150004280	COL LS-484B (C-14927)		
L1402	6150004280	COL LS-484B (C-14927)		
C1401	4030006900	S.CER C1608 JB 1H 103K-T	T	4.3/6.5
C1402	4030007030	S.CER C1608 CH 1H 150J-T	T	14.6/6.5
C1404	4030006990	S.CER C1608 CH 1H 080D-T	T	18.5/2.1
C1406	4030007030	S.CER C1608 CH 1H 150J-T	T	25.3/6.5
C1408	4030006900	S.CER C1608 JB 1H 103K-T	T	35.6/6.5

[MCF-M BOARD]

REF NO.	ORDER NO.	DESCRIPTION	M.	H/V LOCATION
F11401	2030000331	S.MLH FL-358A (64.455 MHz)	T	19.9/6.5
L1401	6150004280	COL LS-484B (C-14927)		
L1402	6150004280	COL LS-484B (C-14927)		
C1401	4030006900	S.CER C1608 JB 1H 103K-T	T	4.3/6.5
C1402	4030009920	S.CER C1608 CH 1H 050B-T	T	14.6/6.5
C1403	4030007020	S.CER C1608 CH 1H 120J-T	T	13.3/6.5
C1404	4030006990	S.CER C1608 CH 1H 080D-T	T	18.5/2.1
C1405	4030009920	S.CER C1608 CH 1H 050B-T	T	21.3/2.1
C1406	4030007020	S.CER C1608 CH 1H 120J-T	T	25.3/6.5
C1407	4030009920	S.CER C1608 CH 1H 050B-T	T	26.6/6.5
C1408	4030006900	S.CER C1608 JB 1H 103K-T	T	35.6/6.5

[MCF-N BOARD]

REF NO.	ORDER NO.	DESCRIPTION	M.	H/V LOCATION
F11401	2030000510	S.MLH FL-396 (64.455 MHz)	T	19.9/6.5
L1401	6150004280	COL LS-484B (C-14927)		
L1402	6150004280	COL LS-484B (C-14927)		
C1401	4030006900	S.CER C1608 JB 1H 103K-T	T	4.3/6.5
C1402	4030007020	S.CER C1608 CH 1H 120J-T	T	14.6/6.5
C1403	4030007020	S.CER C1608 CH 1H 120J-T	T	13.3/6.5
C1404	4030007030	S.CER C1608 CH 1H 150J-T	T	18.5/2.1
C1405	4030007030	S.CER C1608 CH 1H 150J-T	T	21.3/2.1
C1406	4030007020	S.CER C1608 CH 1H 120J-T	T	25.3/6.5
C1407	4030007020	S.CER C1608 CH 1H 120J-T	T	26.6/6.5
C1408	4030006900	S.CER C1608 JB 1H 103K-T	T	35.6/6.5

M.=Mounted side (T: Mounted on the Top side B: Mounted on the Bottom side)
S.=Surface mount

[MAIN UNIT]

REF NO.	ORDER NO.	DESCRIPTION	M.	H/V LOCATION
IC171	1110006300	S.IC NJM2172V-TE1	T	48.8/40.6
IC191	1110006300	S.IC NJM2172V-TE1	B	60.8/75.6
IC201	1130005641	S.IC TC4W53F (TE12L,F)	T	47/33.2
IC211	1130005641	S.IC TC4W53F (TE12L,F)	B	47/26.4
IC221	1110001901	S.IC uPC4570G2-E1-A	T	41.9/27.2
IC231	1110006300	S.IC NJM2172V-TE1	T	39.7/75.7
IC241	1110001901	S.IC uPC4570G2-E1-A	B	41.4/65
IC281	1110006141	S.IC LA4485-E	T	
IC311	1110006300	S.IC NJM2172V-TE1	T	24.6/29.1
IC331	1110001901	S.IC uPC4570G2-E1-A	B	24.5/22.6
IC361	1120002830	S.IC NJM2125F-TE1-#FZZB	T	33.6/18.4
IC701	1130011990	S.IC SN74LVC1G08DCKR	T	131.8/95.3
IC721	1190001930	S.IC PS7122AL-1A-E3	B	81.5/89.5
IC741	1180001541	S.IC TA78L08F (TE12L,F)	B	27.2/81.9
IC1001	1140014340	S.IC TMS320C672BZDH275	T	131.5/32.1
IC1101	1130014253	S.IC AT29LV040A-15TU [FRA], [ITR], [ESP], [KOR] only	T	133.5/12.2
IC1111	1130010461	S.IC TC7SH08FU (TE85L,JF)	T	142.6/32.4
IC1112	1110006411	S.IC R3111N111A-TR-F	T	147.9/32
IC1131	1130008361	S.IC TC7SH04FU (TE85L,JF)	T	134.3/43.2
IC1132	1130008041	S.IC TC7SH04FU (TE85L,JF)	T	125.3/43.2
IC1201	1130009981	S.IC TC7W53FK (TE85L,F)	T	84.7/18.2
IC1211	1110006100	S.IC NJM5534MD-TE1	T	89.3/7.6
IC1221	1110006100	S.IC NJM5534MD-TE1	T	91.3/16.9
IC1231	1110006100	S.IC NJM5534MD-TE1	T	102.2/7.6
IC1251	1110006111	S.IC AK5394AVSP/P	T	107.4/20.7
IC1311	1110006100	S.IC NJM5534MD-TE1	T	92/25.8
IC1321	1110006100	S.IC NJM5534MD-TE1	T	109.2/33.9
IC1331	1110006100	S.IC NJM5534MD-TE1	T	97.3/37.7
IC1351	1110001901	S.IC uPC4570G2-E1-A	T	77/17.4
IC1361	1180001771	S.IC TA79L05F (TE12L,F)	B	73.5/7.1
IC1401	1110007190	S.IC AK5383VFP-E2/P	T	76.5/29.4
IC1431	1130006891	S.IC TC7S04FU (TE85R,F)	T	122.5/45
IC1441	1130012160	S.IC SN74LVC1GU04DCKR	T	119.4/46.3
IC1451	1110005610	S.IC NJM2058V-TE1	T	66/26.9
IC1501	1190002090	S.IC AD1854JRSZRL	T	108.4/42.5
IC1511	1110006100	S.IC NJM5534MD-TE1	T	96.5/40.4
IC1521	1110006100	S.IC NJM5534MD-TE1	T	96.5/47.2
IC1531	1110006100	S.IC NJM5534MD-TE1	T	87.3/34.7
IC1571	1110006100	S.IC NJM5534MD-TE1	T	106/55.3
IC1601	1130012580	S.IC AK4355-VF-E2	T	84.7/43.8
IC1611	1110005420	S.IC BA15532F-E2	B	81.2/44
IC1651	1180003110	S.REG TLV1117CDCYR	B	156.2/7.7
IC1801	1130011530	S.IC CD74HC4094M96	B	173.1/56.9
IC1841	1130011530	S.IC CD74HC4094M96	B	173.1/68.7
IC1921	1130012000	S.IC M62352AGP C60Q	T	81.9/75.6
IC1931	1110005610	S.IC NJM2058V-TE1	T	96.9/77.7
IC2001	1110005610	S.IC NJM2058V-TE1	T	115.5/78.5
IC2051	1110005610	S.IC NJM2058V-TE1	T	134.4/86.2
Q11	1530002060	S.TR 2SC4081 T106 R	B	35.9/73.4
Q11	1530002060	S.TR 2SC4081 T106 R	B	50.8/74.4
Q21	1540000441	S.TR 2SD1619T-TD-E	B	39.1/82.1
Q22	1590001330	S.TR DTA114EUA T106	B	43.6/86.1
Q31	1530002060	S.TR 2SC4081 T106 R	B	31.9/77.9
Q201	1590000680	S.TR DTC114EUA T106	B	39.5/36.9
Q211	1590000680	S.TR DTC114EUA T106	B	40.1/30.2
Q261	1530002060	S.TR 2SC4081 T106 R	B	14.8/75.9
Q281	1590001050	S.TR DTC114TUA T106	B	4.4/57.6
Q282	1540000471	S.TR 2SD1801S-TL-E	B	18.4/49.9
Q291	1560001131	S.FET CPH3403-TL-E	B	20.1/35.5
Q301	1560001131	S.FET CPH3403-TL-E	B	28.9/28.2
Q351	1550000010	S.FET 2SC364-Q (TX)	B	23.2/13.6
Q721	1590001050	S.TR DTC114TUA T106	B	97.2/92.9
Q722	1590001050	S.TR DTC114TUA T106	B	82/80.8
Q731	1590001050	S.TR DTC114TUA T106	B	47/79.7
Q761	1530002060	S.TR 2SC4081 T106 R	T	50.4/78.2
Q810	1530002060	S.TR 2SC4081 T106 R	B	40.8/56.1
Q1201	1590000680	S.TR DTC114EUA T106	T	117.3/35.5
Q2001	1510000510	S.TR 2SA1576A T106R	T	106.9/72.4
Q2002	1560001260	S.FET 2SK3018 T106	B	116.5/76.1
Q2003	1590002430	S.FET DTA144EE TL	B	119.3/72.9
Q2051	1510000510	S.TR 2SA1576A T106R	B	145/83.1
Q2052	1590001050	S.FET DTC114TUA T106	B	141.9/83.1
Q2055	1530003091	S.TR 2SC4213-B (TE85R,F)	T	137.3/70.7
Q2056	1590002430	S.FET DTA144EE TL	T	136.4/73
Q2057	1590002150	S.FET DTC114TE TL	T	134.4/73
Q2058	1560001260	S.FET 2SK3018 T106	T	140.6/77.1
Q2059	1530002060	S.TR 2SC4081 T106 R	T	143.5/77.7
Q2060	1590002710	S.TR UMH11NTN	T	136/77.1
D1	1750000550	S.DIO 1SS355 TE-17	B	36.8/78.5
D11	1750000550	S.DIO 1SS355 TE-17	B	50.7/80.1
D161	1730002280	S.ZEN MA8091-M (TX)	B	46/58.4
D261	1750000550	S.DIO 1SS355 TE-17	B	14.9/79.8
D361	1750000550	S.DIO 1SS355 TE-17	B	23.4/11.4
D721	1750000550	S.DIO 1SS355 TE-17	B	92.5/90.4
D1351	1730002320	S.ZEN MA8051-M (TX)	B	71.7/16.3
D2001	1750000550	S.DIO 1SS355 TE-17	T	109.1/72.9
D2002	1750000550	S.DIO 1SS355 TE-17	T	107.3/81.1
D2003	1730002340	S.ZEN MA8047-M (TX)	B	113.2/75.2
D2004	1750000550	S.DIO 1SS355 TE-17	T	105.9/74.8
D2005	1750000550	S.DIO 1SS355 TE-17	T	105.9/78.6
D2041	1750000550	S.DIO 1SS355 TE-17	T	142.8/82.6
D2051	1750000550	S.DIO 1SS355 TE-17	T	136.9/82.5
D2052	1790001240	S.DIO MA25728-(TX)	B	144.2/77.5
D2053	1790001260	S.DIO MA25077-(TX)	T	140.7/75.2
D2054	1790001250	S.DIO MA25111-(TX)	B	147/78.5
D2091	1750000550	S.DIO 1SS355 TE-17	T	128.5/90.6
FI1121	2040000790	S.LC EXCCE1103U	T	119.7/39.2

[MAIN UNIT]

REF NO.	ORDER NO.	DESCRIPTION	M.	H/V LOCATION
X1141	6050011660	S.XTL CR-754 (30.000 MHz)	T	132.7/47.5
L171	6200003261	S.COL NLV32T-101J	B	45.9/41.2
L191	6200003261	S.COL NLV32T-101J	B	60.4/77.2
L231	6200003261	S.COL NLV32T-101J	B	43.6/76
L311	6200003261	S.COL NLV32T-101J	B	36.1/26.1
L701	6200003191	S.COL NLV32T-470J	B	141.5/93.6
L702	6200003191	S.COL NLV32T-470J	B	138.1/93.6
L711	6200003261	S.COL NLV32T-101J	B	163.7/81.4
L721	6200003261	S.COL NLV32T-101J	B	55.7/80.6
L731	6200003261	S.COL NLV32T-101J	B	47.9/85.3
L732	6200003261	S.COL NLV32T-101J	B	51.9/85.3
L733	6200003261	S.COL NLV32T-101J	B	55.7/85.3
L734	6200003261	S.COL NLV32T-101J	B	51.4/95.2
L735	6200003261	S.COL NLV32T-101J	B	60.1/87.7
L741	6200003261	S.COL NLV32T-101J	B	31.6/87.5
L742	6200003261	S.COL NLV32T-101J	B	34.2/90.8
L1001	6180003501	S.COL SLF6028T-100M1R3-PF	T	145.9/24.7
R1	7030003520	S.RES ERJ3GEYJ 472 V (4.7 k)	B	40.1/78.6
R2	7030003620	S.RES ERJ3GEYJ 333 V (33 k)	B	36.1/75.7
R3	7030003580	S.RES ERJ3GEYJ 153 V (15 k)	B	38.4/73.3
R4	7030003520	S.RES ERJ3GEYJ 472 V (4.7 k)	B	32.6/73.4
R11	7030003520	S.RES ERJ3GEYJ 472 V (4.7 k)	B	51/78.2
R12	7030003620	S.RES ERJ3GEYJ 333 V (33 k)	B	51/76.7
R13	7030003580	S.RES ERJ3GEYJ 153 V (15 k)	B	53.2/74.3
R14	7030003520	S.RES ERJ3GEYJ 472 V (4.7 k)	B	47.7/74.2
R21	7030003560	S.RES ERJ3GEYJ 103 V (10 k)	B	43.6/82
R22	7030009891	S.RES ERA3YED 151V (150)	B	43.7/83.8
R31	7030003640	S.RES ERJ3GEYJ 473 V (47 k)	B	31.7/75.6
R32	7030003560	S.RES ERJ3GEYJ 103 V (10 k)	B	31.5/84.3
R161	7030003360	S.RES ERJ3GEYJ 221 V (220)	B	38.6/60.3
R162	7030003440	S.RES ERJ3GEYJ 102 V (1 k)	B	41.8/60.3
R163	7030003420	S.RES ERJ3GEYJ 681 V (680)	B	40.9/53.9
R171	7030003860	S.RES ERJ3GE JPW V	T	37/61.5
R172	7030003520	S.RES ERJ3GEYJ 472 V (4.7 k)	T	47.6/51.7
R173	7030003860	S.RES ERJ3GE JPW V	B	52.7/41.9
R174	7030003560	S.RES ERJ3GEYJ 103 V (10 k)	B	50/43.7
R175	7030003720	S.RES ERJ3GEYJ 224 V (220 k)	B	49.8/45.9
R176	7030003560	S.RES ERJ3GEYJ 103 V (10 k)	T	50.9/46.6
R177	7030003550	S.RES ERJ3GEYJ 822 V (8.2 k)	T	49.6/46.6
R178	7030003640	S.RES ERJ3GEYJ 473 V (47 k)	T	47/46.6
R179	7030003620	S.RES ERJ3GEYJ 333 V (33 k)	T	48.3/46.6
R180	7030003560	S.RES ERJ3GEYJ 103 V (10 k)	T	52.2/42.3
R181	7030003560	S.RES ERJ3GEYJ 103 V (10 k)	T	52.2/39.7
R182	7030003440	S.RES ERJ3GEYJ 102 V (1 k)	T	57.7/33
R192	7030003560	S.RES ERJ3GEYJ 103 V (10 k)	T	60.8/70.4
R193	7030003520	S.RES ERJ3GEYJ 472 V (4.7 k)	B	61.7/74.4
R194	7030003440	S.RES ERJ3GEYJ 102 V (1 k)	T	64.2/73.7
R195	7030003580	S.RES ERJ3GEYJ 153 V (15 k)	T	55.6/66.5
R196	7030003600	S.RES ERJ3GEYJ 223 V (22 k)	B	61.2/80
R198	7030003620	S.RES ERJ3GEYJ 333 V (33 k)	B	61.2/81.8
R201	7030003320	S.RES ERJ3GEYJ 101 V (100)	B	48.8/40.6
R202	7030003320	S.RES ERJ3GEYJ 101 V (100)	B	42.7/36.6
R203	7030003440	S.RES ERJ3GEYJ 102 V (1 k)	B	43/32.9
R208	7030003620	S.RES ERJ3GEYJ 473 V (47 k)	B	41.2/34.9
R211	7030003560	S.RES ERJ3GEYJ 103 V (10 k)	B	51.6/27.6
R212	7030003560	S.RES ERJ3GEYJ 103 V (10 k)	B	51.6/25.8
R213	7030003580	S.RES ERJ3GEYJ 153 V (15 k)	T	39.2/30.7
R214	7030003320	S.RES ERJ3GEYJ 101 V (100)	B	41.2/32.9
R215	7030003520	S.RES ERJ3GEYJ 472 V (4.7 k)	B	43/26.1
R216	7030003620	S.RES ERJ3GEYJ 333 V (33 k)	B	41.2/26.1
R217	7030003860	S.RES ERJ3GE JPW V	B	44.4/16.3
R218	7030003640	S.RES ERJ3GEYJ 473 V (47 k)	B	40/28.2
R221	7030003680	S.RES ERJ3GEYJ 104 V (100 k)	T	49/25.8
R222	7030003560	S.RES ERJ3GEYJ 103 V (10 k)	T	50.3/25.8
R223	7030003440	S.RES ERJ3GEYJ 102 V (1 k)	T	46.5/28.4
R224	7030003320	S.RES ERJ3GEYJ 101 V (100)	T	51.6/28.4
R225	7030003320	S.RES ERJ3GEYJ 101 V (100)	T	48.4/23.9
R226	7030003320	S.RES ERJ3GEYJ 101 V (100)	T	38.6/23.6
R231	7030003440	S.RES ERJ3GEYJ 102 V (1 k)	T	52.5/75.5
R232	7030003620	S.RES ERJ3GEYJ 333 V (33 k)	T	45.5/77.3
R233	7030003560	S.RES ERJ3GEYJ 103 V (10 k)	T	45.7/76
R234	7030003620	S.RES ERJ3GEYJ 333 V (33 k)	T	42.5/80
R235	7030003560	S.RES ERJ3GEYJ 103 V (10 k)	B	39.9/76.9
R236	7030003560	S.RES ERJ3GEYJ 103 V (10 k)	T	35.1/76.3
R241	7030003440	S.RES ERJ3GEYJ 102 V (1 k)	B	33.2/67.5
R242	7030003660	S.RES ERJ3GEYJ 683 V (68 k)	B	34.6/64.7
R243	7030003560	S.RES ERJ3GEYJ 103 V (10 k)	B	32.2/63.9
R244	7030003560	S.RES ERJ3GEYJ 103 V (10 k)	B	35.6/62.3
R245	7030003320	S.RES ERJ3GEYJ 101 V (100)	T	40.7/66
R246	7030003320	S.RES ERJ3GEYJ 101 V (100)	T	46.2/70.7
R251	7030003680	S.RES ERJ3GEYJ 104 V (100 k)	B	48/65.9
R252	7030003680	S.RES ERJ3GEYJ 104 V (100 k)	B	46.4/65.9
R253	7030003470	S.RES ERJ3GEYJ 471 V (470)	B	47.1/68.2
R254	7030003440	S.RES ERJ3GEYJ 102 V (1 k)	B	11.2/93
R255	7030003480	S.RES ERJ3GEYJ 222 V (2.2 k)	B	11.2/90.1
R256	7030003680	S.RES ERJ3GEYJ 104 V (100 k)	B	47.1/63.5
R257	7030003570	S.RES ERJ3GEYJ 123 V (12 k		

[MAIN UNIT]

REF NO.	ORDER NO.	DESCRIPTION	M.	H/V LOCATION
R311	7030003520	S.RES ERJ3GEYJ 472 V (4.7 k)	B	28.7/33.4
R312	7030003440	S.RES ERJ3GEYJ 102 V (1 k)	B	32/32.7
R313	7030003560	S.RES ERJ3GEYJ 103 V (10 k)	B	26.2/26.2
R314	7030003560	S.RES ERJ3GEYJ 103 V (10 k)	B	23.1/26.2
R315	7030003520	S.RES ERJ3GEYJ 472 V (4.7 k)	B	14/35
R316	7030003480	S.RES ERJ3GEYJ 222 V (2.2 k)	B	31.3/36.9
R317	7030003470	S.RES ERJ3GEYJ 182 V (1.8 k)	B	35.3/35.5
R318	7030003470	S.RES ERJ3GEYJ 182 V (1.8 k)	B	35.2/37.2
R319	7030003470	S.RES ERJ3GEYJ 182 V (1.8 k)	B	34.6/33.2
R320	7030003470	S.RES ERJ3GEYJ 182 V (1.8 k)	B	35.9/33.2
R321	7030003480	S.RES ERJ3GEYJ 222 V (2.2 k)	B	36/31.2
R331	7030003580	S.RES ERJ3GEYJ 153 V (15 k)	B	30.4/22.1
R335	7030003640	S.RES ERJ3GEYJ 473 V (47 k)	B	33.5/22.9
R336	7030003440	S.RES ERJ3GEYJ 102 V (1 k)	B	20.6/19.3
R337	7030003560	S.RES ERJ3GEYJ 103 V (10 k)	B	17.9/21.4
R338	7030003440	S.RES ERJ3GEYJ 102 V (1 k)	B	16.3/21.4
R339	7030003560	S.RES ERJ3GEYJ 103 V (10 k)	B	22.5/16.6
R340	7030003320	S.RES ERJ3GEYJ 101 V (100)	B	26.7/18.4
R341	7030003320	S.RES ERJ3GEYJ 101 V (100)	B	19.5/25.3
R351	7030003560	S.RES ERJ3GEYJ 103 V (10 k)	B	20.7/16.6
R353	7030003440	S.RES ERJ3GEYJ 102 V (1 k)	B	24.3/16.6
R354	7030003500	S.RES ERJ3GEYJ 332 V (3.3 k)	B	26.6/15.8
R361	7030003600	S.RES ERJ3GEYJ 223 V (22 k)	B	20.7/12.9
R362	7030003700	S.RES ERJ3GEYJ 154 V (150 k)	B	23.4/9.7
R363	7030003460	S.RES ERJ3GEYJ 152 V (1.5 k)	B	28.5/11.4
R364	7030003320	S.RES ERJ3GEYJ 101 V (100)	B	35.9/19.1
R365	7030003640	S.RES ERJ3GEYJ 473 V (47 k)	B	38.9/19.7
R366	7030003560	S.RES ERJ3GEYJ 103 V (10 k)	B	32.5/11.4
R401	7030003320	S.RES ERJ3GEYJ 101 V (100)	T	147.3/7.7
R402	7030003320	S.RES ERJ3GEYJ 101 V (100)	T	147.3/12.6
R403	7030003320	S.RES ERJ3GEYJ 101 V (100)	B	65.1/44.3
R404	7030003320	S.RES ERJ3GEYJ 101 V (100)	T	147.3/11.3
R405	7030003320	S.RES ERJ3GEYJ 101 V (100)	B	147.6/35.3
R406	7030003320	S.RES ERJ3GEYJ 101 V (100)	B	65.1/39.5
R407	7030003320	S.RES ERJ3GEYJ 101 V (100)	B	65.1/42.7
R408	7030003320	S.RES ERJ3GEYJ 101 V (100)	B	65.1/33.1
R409	7030003320	S.RES ERJ3GEYJ 101 V (100)	B	65.1/41.1
R410	7030003320	S.RES ERJ3GEYJ 101 V (100)	B	65.1/34.7
R411	7030003320	S.RES ERJ3GEYJ 101 V (100)	B	65.1/37.9
R412	7030003320	S.RES ERJ3GEYJ 101 V (100)	B	65.1/36.3
R413	7030003320	S.RES ERJ3GEYJ 101 V (100)	B	122.6/50.8
R414	7030003320	S.RES ERJ3GEYJ 101 V (100)	B	147.6/36.9
R415	7030003320	S.RES ERJ3GEYJ 101 V (100)	T	147.3/8.9
R416	7030003320	S.RES ERJ3GEYJ 101 V (100)	B	144.5/36.3
R417	7030003320	S.RES ERJ3GEYJ 101 V (100)	T	147.3/10.1
R418	7030003320	S.RES ERJ3GEYJ 101 V (100)	T	147.3/16.5
R419	7030003320	S.RES ERJ3GEYJ 101 V (100)	T	147.3/13.9
R420	7030003320	S.RES ERJ3GEYJ 101 V (100)	T	147.3/15.2
R421	7030003320	S.RES ERJ3GEYJ 101 V (100)	B	147.6/42.9
R422	7030003320	S.RES ERJ3GEYJ 101 V (100)	B	147.6/40.9
R424	7030003320	S.RES ERJ3GEYJ 101 V (100)	B	144.5/39.8
R425	7030003320	S.RES ERJ3GEYJ 101 V (100)	B	147.6/38.9
R426	7030003320	S.RES ERJ3GEYJ 101 V (100)	T	147.3/5.1
R427	7030003320	S.RES ERJ3GEYJ 101 V (100)	T	147.3/6.4
R428	7030003320	S.RES ERJ3GEYJ 101 V (100)	B	132.8/20.9
R473	7030003860	S.RES ERJ3GE JPW V	T	55.6/32.2
R560	7030003680	S.RES ERJ3GEYJ 104 V (100 k)	B	10/32.8
R721	7310003820	TRI EVN-D2AA03 B14		
R722	7030003560	S.RES ERJ3GEYJ 103 V (10 k)	B	112/100.7
R723	7540000270	S.ASB ERZVF2M201	B	69.5/97.9
R724	7030003200	S.RES ERJ3GEYJ 100 V (10)	B	91.7/87.6
R725	7030003390	S.RES ERJ3GEYJ 391 V (390)	B	88/91.3
R741	7030003550	S.RES ERJ3GEYJ 822 V (8.2 k)	B	47.1/81.9
R745	7030006230	S.RES ERJ12YJ151U (150)	B	28.4/75
R761	7030003320	S.RES ERJ3GEYJ 101 V (100)	T	48.4/77.7
R762	7030003580	S.RES ERJ3GEYJ 153 V (15 k)	T	50.6/76.3
R763	7030003390	S.RES ERJ3GEYJ 391 V (390)	T	50.7/80.2
R764	7030003580	S.RES ERJ3GEYJ 153 V (15 k)	T	52.5/78.2
R801	7030003410	S.RES ERJ3GEYJ 561 V (560)	B	125.8/52.7
R802	7030007860	S.RES ERJ3GEYJ 8R2V (8.2)	B	123.9/52.3
R803	7030003410	S.RES ERJ3GEYJ 561 V (560)	B	125.8/50.5
R841	7030003860	S.RES ERJ3GE JPW V	B	21.3/72.2
R890	7030003320	S.RES ERJ3GEYJ 101 V (100)	T	157.7/17.1
R891	7030003320	S.RES ERJ3GEYJ 101 V (100)	T	166/18
R892	7030003320	S.RES ERJ3GEYJ 101 V (100)	T	157.7/15
R893	7030003320	S.RES ERJ3GEYJ 101 V (100)	T	166.2/16
R901	7030003320	S.RES ERJ3GEYJ 101 V (100)	B	117.1/95.1
R902	7030003320	S.RES ERJ3GEYJ 101 V (100)	B	115.5/95.1
R911	7030003320	S.RES ERJ3GEYJ 101 V (100)	T	157.7/19
R912	7030003320	S.RES ERJ3GEYJ 101 V (100)	T	166/20
R913	7030003320	S.RES ERJ3GEYJ 101 V (100)	T	157.7/21
R914	7030003320	S.RES ERJ3GEYJ 101 V (100)	T	166/22
R915	7030003320	S.RES ERJ3GEYJ 101 V (100)	T	157.7/23
R916	7030003320	S.RES ERJ3GEYJ 101 V (100)	T	166/24
R917	7030003320	S.RES ERJ3GEYJ 101 V (100)	T	157.7/25
R918	7030003320	S.RES ERJ3GEYJ 101 V (100)	T	166/26
R919	7030003320	S.RES ERJ3GEYJ 101 V (100)	T	157.7/27
R920	7030003320	S.RES ERJ3GEYJ 101 V (100)	T	157.7/31
R921	7030003320	S.RES ERJ3GEYJ 101 V (100)	T	166.1/30
R922	7030003320	S.RES ERJ3GEYJ 101 V (100)	T	166/32
R923	7030003320	S.RES ERJ3GEYJ 101 V (100)	T	157.7/33
R924	7030003320	S.RES ERJ3GEYJ 101 V (100)	T	166/34
R925	7030003320	S.RES ERJ3GEYJ 101 V (100)	T	157.7/35
R926	7030003320	S.RES ERJ3GEYJ 101 V (100)	T	166/36
R927	7030003320	S.RES ERJ3GEYJ 101 V (100)	T	157.7/37
R945	7030003860	S.RES ERJ3GE JPW V	B	10/27
R946	7030003860	S.RES ERJ3GE JPW V	T	4.8/26
R947	7030003860	S.RES ERJ3GE JPW V	B	10/25
R948	7030003860	S.RES ERJ3GE JPW V	T	4.8/24
R949	7030003860	S.RES ERJ3GE JPW V	B	10/23
R950	7030003860	S.RES ERJ3GE JPW V	T	4.8/22
R951	7030003320	S.RES ERJ3GEYJ 101 V (100)	T	4.8/20
R952	7030003320	S.RES ERJ3GEYJ 101 V (100)	B	10/20.9
R953	7030003320	S.RES ERJ3GEYJ 101 V (100)	T	4.8/18

[MAIN UNIT]

REF NO.	ORDER NO.	DESCRIPTION	M.	H/V LOCATION
R956	7030003860	S.RES ERJ3GE JPW V	B	10/17.5
R961	7030003320	S.RES ERJ3GEYJ 101 V (100)	T	172.1/13
R962	7030003320	S.RES ERJ3GEYJ 101 V (100)	T	180.4/14
R963	7030003320	S.RES ERJ3GEYJ 101 V (100)	T	172.1/15
R964	7030003320	S.RES ERJ3GEYJ 101 V (100)	T	180.4/16
R965	7030003320	S.RES ERJ3GEYJ 101 V (100)	T	172.1/17
R966	7030003860	S.RES ERJ3GE JPW V	T	180.4/18
R967	7030003860	S.RES ERJ3GE JPW V	T	172.1/19
R968	7030003860	S.RES ERJ3GE JPW V	T	180.4/20
R969	7030003320	S.RES ERJ3GEYJ 101 V (100)	T	172.1/21
R970	7030003320	S.RES ERJ3GEYJ 101 V (100)	T	180.4/22
R971	7030003320	S.RES ERJ3GEYJ 101 V (100)	T	172.1/23
R972	7030003320	S.RES ERJ3GEYJ 101 V (100)	T	180.4/24
R973	7030003320	S.RES ERJ3GEYJ 101 V (100)	T	172.1/25
R974	7030003320	S.RES ERJ3GEYJ 101 V (100)	T	180.4/26
R975	7030003320	S.RES ERJ3GEYJ 101 V (100)	T	172.1/27
R976	7030003320	S.RES ERJ3GEYJ 101 V (100)	T	180.4/28
R977	7030003320	S.RES ERJ3GEYJ 101 V (100)	T	172.1/29
R978	7030003320	S.RES ERJ3GEYJ 101 V (100)	T	180.4/30
R979	7030003320	S.RES ERJ3GEYJ 101 V (100)	T	172.1/31
R981	7030003320	S.RES ERJ3GEYJ 101 V (100)	T	172.1/33
R982	7030003320	S.RES ERJ3GEYJ 101 V (100)	T	180.4/34
R983	7030003320	S.RES ERJ3GEYJ 101 V (100)	T	172.1/35
R984	7030003860	S.RES ERJ3GE JPW V	T	180.4/36
R985	7030003860	S.RES ERJ3GE JPW V	T	172.1/37
R986	7030003860	S.RES ERJ3GE JPW V	T	180.4/38
R992	7030003320	S.RES ERJ3GEYJ 101 V (100)	T	157.7/39
R1001	7030003640	S.RES ERJ3GEYJ 473 V (47 k)	B	140.6/23.8
R1002	7030003640	S.RES ERJ3GEYJ 473 V (47 k)	B	136.4/21.6
R1003	7030003640	S.RES ERJ3GEYJ 473 V (47 k)	B	142.6/25.2
R1004	7030003640	S.RES ERJ3GEYJ 473 V (47 k)	B	141.6/32.6
R1005	7030003640	S.RES ERJ3GEYJ 473 V (47 k)	B	143.8/37.9
R1006	7030003640	S.RES ERJ3GEYJ 473 V (47 k)	B	147.5/30.5
R1007	7030003640	S.RES ERJ3GEYJ 473 V (47 k)	B	147.3/26.2
R1008	7030003640	S.RES ERJ3GEYJ 473 V (47 k)	B	147.3/24.6
R1009	7030003640	S.RES ERJ3GEYJ 473 V (47 k)	B	147.5/32.3
R1010	7030008240	S.RES ERJ12Y0R00U	T	117.4/55.1
R1011	7030003860	S.RES ERJ3GE JPW V	T	114.2/57
R1012	7030008240	S.RES ERJ12Y0R00U	T	123.2/60.3
R1013	7030008240	S.RES ERJ12Y0R00U	B	150/18.4
R1014	7030003640	S.RES ERJ3GEYJ 473 V (47 k)	B	120.5/24.3
R1015	7030003640	S.RES ERJ3GEYJ 473 V (47 k)	B	120.5/26.9
R1016	7030003640	S.RES ERJ3GEYJ 473 V (47 k)	B	120.5/25.6
R1017	7030003640	S.RES ERJ3GEYJ 473 V (47 k)	B	120.5/29.5
R1018	7030003640	S.RES ERJ3GEYJ 473 V (47 k)	B	117.9/30.2
R1019	7030003640	S.RES ERJ3GEYJ 473 V (47 k)	B	120.5/31.5
R1020	7030003640	S.RES ERJ3GEYJ 473 V (47 k)	B	117.9/32.4
R1021	7030003640	S.RES ERJ3GEYJ 473 V (47 k)	B	120.5/33
R1111	7030003640	S.RES ERJ3GEYJ 473 V (47 k)	T	145.4/33.2
R1112	7030003640	S.RES ERJ3GEYJ 473 V (47 k)	B	143.4/32.6
R1113	7030003640	S.RES ERJ3GEYJ 473 V (47 k)	T	147.4/35.4
R1131	7030003320	S.RES ERJ3GEYJ 101 V (100)	T	137.5/43.2
R1132	7030003320	S.RES ERJ3GEYJ 101 V (100)	T	128.5/43.2
R1141	7030003800	S.RES ERJ3GEYJ 105 V (1 M)	T	130.4/44
R1151	7030004040	S.RES ERJ3GEYJ 4R7 V (4.7)	B	133.5/42.3
R1152	7030003520	S.RES ERJ3GEYJ 472 V (4.7 k)	B	127.3/41.5
R1153	7030003520	S.RES ERJ3GEYJ 472 V (4.7 k)	B	126/41.5
R1201	7030003500	S.RES ERJ3GEYJ 332 V (3.3 k)	B	97.5/11.9
R1202	7030003480	S.RES ERJ3GEYJ 222 V (2.2 k)	B	95.3/9.2
R1203	7030003640	S.RES ERJ3GEYJ 473 V (47 k)	T	86.6/18.5
R1204	7030003860	S.RES ERJ3GE JPW V	T	82/14.2
R1211	7030009591	S.RES ERA3YED 472V (4.7 k)	T	83.9/4.8
R1212	7030009591	S.RES ERA3YED 472V (4.7 k)	T	85.9/4.8
R1213	7030003860	S.RES ERJ3GE JPW V	T	85.9/5.7
R1214	7030003320	S.RES ERJ3GEYJ 101 V (100)	T	83.1/11
R1215	7030003320	S.RES ERJ3GEYJ 101 V (100)	T	92.7/5.6
R1221	7030003320	S.RES ERJ3GEYJ 101 V (100)	T	87.9/17.7
R1222	7030003320	S.RES ERJ3GEYJ 101 V (100)	T	94.7/14.4
R1223	7030006601	S.RES ERA3YED 272V (2.7 k)	T	87.9/14.3
R1224	7030010390	S.RES ERA3YED 821V (820)	T	96/18.1
R1225	7030009691	S.RES ERA3YED 101V (100)	T	95.4/20
R1231	7030003320	S.RES ERJ3GEYJ 101 V (100)	T	98.4/7.9
R1232	7030003320	S.RES ERJ3GEYJ 101 V (100)	T	106.3/5.4
R1233	7030006601	S.RES ERA3YED 272V (2.7 k)	T	98.2/6.1
R1234	7030010390	S.RES ERA3YED 821V (820)	T	107.2/9.9
R1235	7030009691	S.RES ERA3YED 101V (100)	T	105.6/12
R1241	7030009591	S.RES ERA3YED 472V (4.7 k)	T	1

[MAIN UNIT]

REF NO.	ORDER NO.	DESCRIPTION	M.	H/V LOCATION
R1351	7030006521	S.RES ERA3YED 561V (560)	B	74.5/12.2
R1352	7030003360	S.RES ERJ3GEYJ 221 V (220)	B	77.3/13.6
R1353	7030003680	S.RES ERJ3GEYJ 104 V (100 k)	T	78.2/13.4
R1354	7030003680	S.RES ERJ3GEYJ 104 V (100 k)	T	72/13.9
R1355	7030003680	S.RES ERJ3GEYJ 104 V (100 k)	B	77.8/17.1
R1356	7030003380	S.RES ERJ3GEYJ 331 V (330)	B	76.6/17.9
R1361	7030003560	S.RES ERJ3GEYJ 103 V (10 k)	B	77.6/12
R1362	7030003560	S.RES ERJ3GEYJ 103 V (10 k)	T	76.5/9.4
R1363	7030003410	S.RES ERJ3GEYJ 561 V (560)	B	77.9/8.5
R1401	7030003520	S.RES ERJ3GEYJ 472 V (4.7 k)	B	76.2/32.3
R1402	7030003520	S.RES ERJ3GEYJ 472 V (4.7 k)	B	80.7/29.9
R1407	7030003640	S.RES ERJ3GEYJ 473 V (47 k)	T	82.3/27.7
R1408	7030003200	S.RES ERJ3GEYJ 100 V (10)	T	85/27.4
R1409	7030003320	S.RES ERJ3GEYJ 101 V (100)	T	82.3/30.6
R1410	7030003640	S.RES ERJ3GEYJ 473 V (47 k)	T	82.3/31.8
R1411	7030003640	S.RES ERJ3GEYJ 473 V (47 k)	T	82.7/33.7
R1421	7030003640	S.RES ERJ3GEYJ 473 V (47 k)	T	70.6/30.9
R1422	7030003640	S.RES ERJ3GEYJ 473 V (47 k)	T	70.6/32.1
R1423	7030003640	S.RES ERJ3GEYJ 473 V (47 k)	T	71.2/34
R1441	7030003800	S.RES ERJ3GEYJ 105 V (1 M)	T	119.4/44.4
R1451	7030009691	S.RES ERA3YED 101V (100)	T	62.8/20.4
R1452	7030009591	S.RES ERA3YED 472V (4.7 k)	T	64/20.4
R1453	7030003520	S.RES ERJ3GEYJ 472 V (4.7 k)	B	69.2/20.6
R1454	7030003520	S.RES ERJ3GEYJ 472 V (4.7 k)	B	69.3/16.8
R1455	7030005321	S.RES ERA3YED 103V (10 k)	B	69.2/34.9
R1461	7030009691	S.RES ERA3YED 101V (100)	T	69/20.4
R1462	7030009591	S.RES ERA3YED 472V (4.7 k)	T	67.8/20.4
R1463	7030005321	S.RES ERA3YED 103V (10 k)	B	69.2/23.8
R1471	7030009591	S.RES ERA3YED 472V (4.7 k)	T	67.8/32.3
R1472	7030009591	S.RES ERA3YED 472V (4.7 k)	B	70.8/34.9
R1481	7030003320	S.RES ERJ3GEYJ 101 V (100)	B	69.2/22.2
R1482	7030003320	S.RES ERJ3GEYJ 101 V (100)	T	73.5/38.2
R1491	7030003860	S.RES ERJ3GE JPW V	T	63.7/32.3
R1492	7030003860	S.RES ERJ3GE JPW V	T	66/33.9
R1501	7030003360	S.RES ERJ3GEYJ 221 V (220)	T	102.6/38.9
R1511	7030005351	S.RES ERA3YED 182V (1.8 k)	B	102/39.6
R1512	7030007230	S.RES ERA3YED 102V (1 k)	B	98.9/39.6
R1513	7030007230	S.RES ERA3YED 102V (1 k)	B	99/37.2
R1514	7030010770	S.RES ERA3YED 681V (680)	B	94.5/40.6
R1521	7030005351	S.RES ERA3YED 182V (1.8 k)	B	101.6/45.7
R1522	7030007230	S.RES ERA3YED 102V (1 k)	B	98.5/45.7
R1523	7030007230	S.RES ERA3YED 102V (1 k)	B	98.5/44.1
R1524	7030010770	S.RES ERA3YED 681V (680)	B	94.4/44.3
R1525	7030007230	S.RES ERA3YED 102V (1 k)	B	97.5/41.7
R1531	7030006461	S.RES ERA3YED 152V (1.5 k)	B	90.6/40.2
R1532	7030007230	S.RES ERA3YED 102V (1 k)	B	87.4/36.3
R1533	7030006461	S.RES ERA3YED 152V (1.5 k)	B	90.6/41.8
R1534	7030007230	S.RES ERA3YED 102V (1 k)	T	92/35
R1535	7030009691	S.RES ERA3YED 101V (100)	B	83.1/33.3
R1541	7030003320	S.RES ERJ3GEYJ 101 V (100)	B	90.6/38.6
R1542	7030003320	S.RES ERJ3GEYJ 101 V (100)	B	107/36.1
R1551	7030003320	S.RES ERJ3GEYJ 101 V (100)	B	96.4/50.6
R1552	7030003320	S.RES ERJ3GEYJ 101 V (100)	B	103.8/47.3
R1561	7030003320	S.RES ERJ3GEYJ 101 V (100)	B	90.1/36.2
R1562	7030003320	S.RES ERJ3GEYJ 101 V (100)	T	88.8/38.8
R1571	7030003520	S.RES ERJ3GEYJ 472 V (4.7 k)	T	104.9/44.4
R1572	7030003520	S.RES ERJ3GEYJ 472 V (4.7 k)	T	103.7/48.8
R1573	7030003360	S.RES ERJ3GEYJ 221 V (220)	B	108.1/52.1
R1574	7030003520	S.RES ERJ3GEYJ 472 V (4.7 k)	T	111.5/48.5
R1575	7030003360	S.RES ERJ3GEYJ 221 V (220)	B	107.8/54.3
R1576	7030003520	S.RES ERJ3GEYJ 472 V (4.7 k)	B	107.8/55.9
R1577	7030003320	S.RES ERJ3GEYJ 101 V (100)	B	109.8/52.1
R1578	7030003320	S.RES ERJ3GEYJ 101 V (100)	B	99.6/57.1
R1579	7030009691	S.RES ERA3YED 101V (100)	T	101.9/52
R1601	7030003320	S.RES ERJ3GEYJ 101 V (100)	B	86/41.8
R1605	7030007230	S.RES ERA3YED 102V (1 k)	B	97.4/37.2
R1611	7030009591	S.RES ERA3YED 472V (4.7 k)	T	78.6/41.1
R1612	7030009591	S.RES ERA3YED 472V (4.7 k)	B	76.9/38.7
R1613	7030009961	S.RES ERA3YED 221V (220)	B	76.9/40.5
R1614	7030009591	S.RES ERA3YED 472V (4.7 k)	T	78.6/39.8
R1615	7030009591	S.RES ERA3YED 472V (4.7 k)	T	74.4/39.9
R1616	7030009961	S.RES ERA3YED 221V (220)	B	81.6/37
R1617	7030009691	S.RES ERA3YED 101V (100)	B	74.6/39.4
R1621	7030005321	S.RES ERA3YED 103V (10 k)	T	78.6/43.6
R1622	7030005321	S.RES ERA3YED 103V (10 k)	T	78.6/42.4
R1623	7030005341	S.RES ERA3YED 332V (3.3 k)	T	74.7/42
R1624	7030007661	S.RES ERA3YED 331V (3.3 k)	B	75.2/45.7
R1625	7030006521	S.RES ERA3YED 561V (560)	B	72.2/47.3
R1626	7030006461	S.RES ERA3YED 152V (1.5 k)	B	72.2/44.2
R1627	7030007661	S.RES ERA3YED 331V (330)	B	75.5/49.5
R1628	7030005341	S.RES ERA3YED 332V (3.3 k)	B	75.5/51.1
R1631	7030003320	S.RES ERJ3GEYJ 101 V (100)	B	84.2/47.5
R1641	7030003320	S.RES ERJ3GEYJ 101 V (100)	B	83.9/40
R1651	7030003330	S.RES ERJ3GEYJ 121 V (120)	B	160.5/4.9
R1652	7030011740	S.RES ERJ12YJ1R5U	B	170.6/10.3
R1653	7030011740	S.RES ERJ12YJ1R5U	B	166.6/10.3
R1701	7030003860	S.RES ERJ3GE JPW V	B	114.8/23.6
R1822	7030003320	S.RES ERJ3GEYJ 101 V (100)	B	165.9/56.7
R1823	7030003320	S.RES ERJ3GEYJ 101 V (100)	B	166.9/58.2
R1824	7030003320	S.RES ERJ3GEYJ 101 V (100)	B	165.9/59.7
R1833	7030003320	S.RES ERJ3GEYJ 101 V (100)	B	166.8/61.2
R1834	7030003320	S.RES ERJ3GEYJ 101 V (100)	B	179.1/54.4
R1835	7030003320	S.RES ERJ3GEYJ 101 V (100)	B	179.9/56.1
R1859	7030003320	S.RES ERJ3GEYJ 101 V (100)	B	166/67.5
R1860	7030003320	S.RES ERJ3GEYJ 101 V (100)	B	166.8/69.1
R1861	7030003320	S.RES ERJ3GEYJ 101 V (100)	B	165.9/70.7
R1863	7030003320	S.RES ERJ3GEYJ 101 V (100)	B	179.8/65.9
R1881	7030003860	S.RES ERJ3GE JPW V	B	178.7/62.8
R1882	7030003860	S.RES ERJ3GE JPW V	B	172.6/47.1
R1883	7030003860	S.RES ERJ3GE JPW V	B	174.5/47.2
R1884	7030003860	S.RES ERJ3GE JPW V	B	170.6/47.1
R1885	7030003860	S.RES ERJ3GE JPW V	T	82.3/80.4
R1886	7030003860	S.RES ERJ3GE JPW V	B	176.8/47.2
R1887	7030003860	S.RES ERJ3GE JPW V	B	163.8/61.2

[MAIN UNIT]

REF NO.	ORDER NO.	DESCRIPTION	M.	H/V LOCATION
R1888	7030003860	S.RES ERJ3GE JPW V	B	182.3/54.4
R1889	7030003860	S.RES ERJ3GE JPW V	B	182.7/56.1
R1890	7030003860	S.RES ERJ3GE JPW V	B	162.8/67.5
R1891	7030003860	S.RES ERJ3GE JPW V	B	166.7/72.3
R1892	7030003320	S.RES ERJ3GEYJ 101 V (100)	T	93.2/81.8
R1893	7030003320	S.RES ERJ3GEYJ 101 V (100)	T	100.1/82.1
R1894	7030003320	S.RES ERJ3GEYJ 101 V (100)	T	100.5/72.1
R1895	7030003320	S.RES ERJ3GEYJ 101 V (100)	T	93.2/72.1
R1896	7030003860	S.RES ERJ3GE JPW V	T	82.5/70
R1897	7030003860	S.RES ERJ3GE JPW V	T	81.3/70
R1898	7030003860	S.RES ERJ3GE JPW V	T	80.1/70
R1899	7030003860	S.RES ERJ3GE JPW V	T	78.9/70
R1900	7030003860	S.RES ERJ3GE JPW V	T	79.3/80.7
R1901	7030003860	S.RES ERJ3GE JPW V	T	81.7/81.6
R1902	7030003860	S.RES ERJ3GE JPW V	B	135.8/69.3
R1903	7030003860	S.RES ERJ3GE JPW V	B	107.9/72.3
R1904	7030003860	S.RES ERJ3GE JPW V	B	110.6/72.8
R1905	7030003860	S.RES ERJ3GE JPW V	B	135.9/81.5
R1906	7030003860	S.RES ERJ3GE JPW V	B	125.4/71.7
R1907	7030003860	S.RES ERJ3GE JPW V	B	104.8/72.4
R1908	7030003860	S.RES ERJ3GE JPW V	B	136.9/71.8
R1909	7030003860	S.RES ERJ3GE JPW V	B	124.9/75.6
R1910	7030003860	S.RES ERJ3GE JPW V	B	127.7/86.6
R1911	7030003860	S.RES ERJ3GE JPW V	T	143.5/89.8
R1912	7030003860	S.RES ERJ3GE JPW V	B	123.5/80.3
R1913	7030003860	S.RES ERJ3GE JPW V	B	123.3/72.7
R1914	7030003860	S.RES ERJ3GE JPW V	B	76.1/78.5
R1921	7030009851	S.RES ERA3YED 271V (270)	T	87.3/73.4
R1922	7030009891	S.RES ERA3YED 151V (150)	T	86.1/70
R1930	7030003320	S.RES ERJ3GEYJ 101 V (100)	T	100.5/79.1
R1931	7030003320	S.RES ERJ3GEYJ 101 V (100)	T	100.5/76
R1932	7030003560	S.RES ERJ3GEYJ 103 V (10 k)	T	95/83.5
R1933	7030003560	S.RES ERJ3GEYJ 103 V (10 k)	T	98.6/83.5
R1934	7030003560	S.RES ERJ3GEYJ 103 V (10 k)	T	98.7/72.1
R1935	7030003560	S.RES ERJ3GEYJ 103 V (10 k)	T	95.1/72.1
R2001	7030003440	S.RES ERJ3GEYJ 102 V (1 k)	T	108.6/70.6
R2002	7030003440	S.RES ERJ3GEYJ 102 V (1 k)	T	104.9/71.7
R2003	7030003620	S.RES ERJ3GEYJ 333 V (33 k)	T	120.2/85
R2004	7030003680	S.RES ERJ3GEYJ 104 V (100 k)	T	118/86.1
R2005	7030003520	S.RES ERJ3GEYJ 472 V (4.7 k)	T	116.5/82.7
R2006	7310005390	S.TRI EVM-3VXS50 BQ3 (472)	T	113.5/86.6
R2007	7030003320	S.RES ERJ3GEYJ 101 V (100)	T	110.7/72.6
R2008	7030003450	S.RES ERJ3GEYJ 122 V (1.2 k)	T	113.3/82.6
R2009	7030003520	S.RES ERJ3GEYJ 472 V (4.7 k)	T	109.9/79.8
R2010	7030003720	S.RES ERJ3GEYJ 224 V (220 k)	T	110.7/75.2
R2011	7030003640	S.RES ERJ3GEYJ 473 V (47 k)	T	116.1/76.6
R2012	7030003720	S.RES ERJ3GEYJ 224 V (220 k)	T	110.7/81.8
R2013	7030003480	S.RES ERJ3GEYJ 222 V (2.2 k)	T	108.8/77.2
R2014	7030003380	S.RES ERJ3GEYJ 331 V (330)	T	109.5/81.8
R2015	7030000340	S.RES MCR10EZHJ 470 (471)	T	112.2/71.6
R2016	7030000340	S.RES MCR10EZHJ 470 (471)	T	114/71.6
R2017	7030003560	S.RES ERJ3GEYJ 103 V (10 k)	T	108.8/76
R2018	7030003660	S.RES ERJ3GEYJ 683 V (68 k)	T	110.7/77.9
R2019	7030003680	S.RES ERJ3GEYJ 104 V (100 k)	T	106.9/76.7
R2020	7510001511	S.TMR NTCG16 4LH 223JT	T	108.8/78.6
R2021	7030003320	S.RES ERJ3GEYJ 101 V (100)	B	120.1/80.3
R2022	7030003740	S.RES ERJ3GEYJ 334 V (330 k)	T	120.3/81.2
R2023	7030003320	S.RES ERJ3GEYJ 101 V (100)	T	140.8/87.8
R2024	7030005681	S.RES ERA3YKD 473V (47 k)	T	122.1/81.7
R2025	7030008121	S.RES ERA3YED 682V (6.8 k)	T	122.1/80.5
R2026	7030003320	S.RES ERJ3GEYJ 101 V (100)	T	125.8/86
R2027	7030009861	S.RES ERA3YED 471V (470)	T	125/81.5
R2028	7310005370	S.TRI EVM-3VXS50 BQ2 (471)	T	125.3/78.5
R2029	7030008121	S.RES ERA3YED 682V (6.8 k)	T	121.8/79.3
R2030	7030005681	S.RES ERA3YKD 473V (47 k)	T	121.8/78.1
R2041	7030003860	S.RES ERJ3GE JPW V	T	118.1/87.8
R2042	7310005420	S.TRI EVM-3VXS50 B15 (104)	T	122.3/88.2
R2043	7030003560	S.RES ERJ3GEYJ 103 V (10 k)	T	129.1/84.3
R2044	7030003560	S.RES ERJ3GEYJ 103 V (10 k)	T	128.9/86.1
R2045	7030003660	S.RES ERJ3GEYJ 474 V (470 k)	T	130.6/83
R2046	7030003380	S.RES ERJ3GEYJ 331 V (330)	T	139.9/81
R2048	7030003660	S.RES ERJ3GEYJ 683 V (68 k)	B	118.3/80.3
R2051	7030009920	S.RES ERJ3GEYJ 335 V (3.3 M)	T	140.4/83.4
R2052	7030003600	S.RES ERJ3GEYJ 223 V (22 k)	B	145.1/85.3
R2053	7030003720	S.RES ERJ3GEYJ 155 V (1.5 M)	T	142.3/84.1
R2054	7030003840	S.RES ERJ3GEYJ 225 V (2.2 M		

[MAIN UNIT]

REF NO.	ORDER NO.	DESCRIPTION	M.	H/V LOCATION
C11	4030006880	S.CER C1608 JB 1H 472K-T	B	50.8/72.2
C21	4030006880	S.CER C1608 JB 1H 472K-T	B	43.6/80.2
C31	4030006880	S.CER C1608 JB 1H 472K-T	B	32.2/80.2
C101	4030011600	S.CER C1608 JB 1E 104K-T	T	131.6/93.4
C161	4510008510	S.ELE EEE1CA471P	T	44.7/59.5
C162	4510008540	S.ELE EEE1CA100SR	T	47.9/67.5
C163	4030011600	S.CER C1608 JB 1E 104K-T	B	44/55
C164	4510008500	S.ELE EEE1CA101WP	T	53.8/54.7
C171	4510008550	S.ELE EEE1HA010SR	T	43.3/51.7
C172	4030011600	S.CER C1608 JB 1E 104K-T	B	52.3/44.4
C173	4030007120	S.CER C1608 CH 1H 820J-T	B	49.8/47.7
C174	4510008550	S.ELE EEE1HA010SR	T	43.5/46.9
C175	4510008550	S.ELE EEE1HA010SR	T	54/47.6
C176	4510008540	S.ELE EEE1CA100SR	T	43.2/42.1
C177	4510008540	S.ELE EEE1CA100SR	T	55.3/40.7
C178	4510008550	S.ELE EEE1HA010SR	T	54.6/35.4
C179	4510008550	S.ELE EEE1HA010SR	T	49.3/32.6
C191	4510008550	S.ELE EEE1HA010SR	T	65.1/69.8
C192	4030017840	S.CER C2012 CH 1H 222J-T	B	61.6/72.6
C193	4030019090	S.CER C2012 JB 1C 225M-T	T	66.9/76
C194	4510008540	S.ELE EEE1CA100SR	T	55.4/70.6
C195	4510008550	S.ELE EEE1HA010SR	T	60.2/67.3
C196	4510008540	S.ELE EEE1CA100SR	T	55.6/76.1
C197	4510008550	S.ELE EEE1HA010SR	T	63/82.8
C198	4510008540	S.ELE EEE1CA100SR	T	58.2/82.8
C201	4510008550	S.ELE EEE1HA010SR	T	43.2/37.3
C202	4030011600	S.CER C1608 JB 1E 104K-T	B	45.8/36.6
C211	4030011600	S.CER C1608 JB 1E 104K-T	B	51.6/24
C212	4030011600	S.CER C1608 JB 1E 104K-T	B	46.3/29.8
C213	4030012600	S.CER C2012 JB 1A 105M-T	B	41.2/22.6
C221	4030007170	S.CER C1608 CH 1H 221J-T	T	47.7/25.8
C222	4030011600	S.CER C1608 JB 1E 104K-T	T	51.6/25.8
C223	4510008500	S.ELE EEE1CA101WP	T	56.1/25.9
C224	4510008540	S.ELE EEE1CA100SR	T	49.8/20.4
C225	4510008500	S.ELE EEE1CA101WP	T	43.3/20.7
C226	4030011600	S.CER C1608 JB 1E 104K-T	T	51.5/23.9
C231	4510008540	S.ELE EEE1CA100SR	T	39.9/70.5
C232	4030012600	S.CER C2012 JB 1A 105M-T	T	45.9/74.5
C233	4030012600	S.CER C2012 JB 1A 105M-T	T	45.8/78.9
C234	4510008540	S.ELE EEE1CA100SR	T	40.3/83.3
C235	4030012600	S.CER C2012 JB 1A 105M-T	T	40.1/79.3
C236	4510008540	S.ELE EEE1CA100SR	T	30.7/83.2
C237	4510008540	S.ELE EEE1CA100SR	T	35.5/81.2
C241	4030010760	S.CER C1608 CH 1H 331J-T	B	36.4/64.7
C242	4510008540	S.ELE EEE1CA100SR	T	37.2/65.2
C243	4510008540	S.ELE EEE1CA100SR	T	50.1/72.4
C261	4030006880	S.CER C1608 JB 1H 472K-T	B	19/80.5
C262	4030006880	S.CER C1608 JB 1H 472K-T	B	14.7/778
C271	4510008180	ELE EUUFC1E102S	B	18.6/58.4
C272	4030011600	S.CER C1608 JB 1E 104K-T	B	18.6/58.4
C281	4510008180	ELE EUUFC1E102S	B	18.6/58.4
C282	4030009000	S.CER C2012 JB 1C 224K-T	T	5.3/58.3
C283	4510008500	S.ELE EEE1CA101WP	T	9.8/43.9
C284	4510008550	S.ELE EEE1HA010SR	T	5.2/37.8
C285	4510008550	S.ELE EEE1HA010SR	T	10.6/37.5
C286	4510008550	S.ELE EEE1HA010SR	T	16.8/43
C287	4510008190	ELE EUUFC1E222S	B	18.7/69.5
C288	4030011600	S.CER C1608 JB 1E 104K-T	B	22.7/35.7
C291	4030011600	S.CER C1608 JB 1E 104K-T	B	16.8/37.3
C292	4030008950	S.CER C2012 JB 1C 823K-T	B	16.8/37.3
C293	4030008880	S.CER C1608 JB 1H 223K-T	B	16.6/33.9
C301	4030008950	S.CER C2012 JB 1C 823K-T	B	28.9/30.8
C302	4030011600	S.CER C1608 JB 1E 104K-T	B	32.2/28.6
C311	4510008500	S.ELE EEE1CA101WP	T	32.6/31.8
C313	4510008550	S.ELE EEE1HA010SR	T	24.4/34.3
C314	4510008540	S.ELE EEE1CA100SR	T	26.1/23
C315	4510008540	S.ELE EEE1CA100SR	T	21.3/23
C316	4510008540	S.ELE EEE1CA100SR	T	17.6/32.8
C317	4510008550	S.ELE EEE1HA010SR	T	17.3/26.9
C318	4510008540	S.ELE EEE1CA100SR	T	20.2/38.1
C319	4030012600	S.CER C2012 JB 1A 105M-T	B	33/37.8
C320	4030012600	S.CER C2012 JB 1A 105M-T	B	36.2/29.5
C331	4030008650	S.CER C1608 JB 1H 332K-T	B	19.5/21.4
C332	4030019090	S.CER C2012 JB 1C 225M-T	T	18.9/18.3
C333	4510008540	S.ELE EEE1CA100SR	T	24.3/17.7
C334	4510008540	S.ELE EEE1CA100SR	T	15.8/21.5
C351	4030011600	S.CER C1608 JB 1E 104K-T	B	18.9/14.4
C354	4550007480	S.TAN F930J106MAABMA	B	32.8/15.7
C355	4550007480	S.TAN F930J106MAABMA	B	29/13.7
C361	4030011600	S.CER C1608 JB 1E 104K-T	T	36/18.6
C400	4030006880	S.CER C1608 JB 1H 472K-T	T	19.2/4.5
C426	4510008800	S.ELE EEE1EA100SR	T	65.1/46.5
C427	4030011600	S.CER C1608 JB 1E 104K-T	B	64.7/49.8
C428	4030006880	S.CER C1608 JB 1H 472K-T	B	66.3/49.8
C429	4030006880	S.CER C1608 JB 1H 472K-T	B	67.9/49.8
C430	4030006880	S.CER C1608 JB 1H 472K-T	B	67.9/49.8
C464	4510008540	S.ELE EEE1CA100SR	T	43.2/32.5
C701	4030011600	S.CER C1608 JB 1E 104K-T	B	139/99.5
C702	4030011600	S.CER C1608 JB 1E 104K-T	B	124/99.5
C703	4030011600	S.CER C1608 JB 1E 104K-T	T	131.6/92.1
C711	4030006880	S.CER C1608 JB 1H 472K-T	B	163.7/77.8
C721	4030006880	S.CER C1608 JB 1H 472K-T	B	54.9/77.5
C722	4010005380	CER HMI3SJ YB 472K 500V	B	90.6/90.5
C723	4030006880	S.CER C1608 JB 1H 472K-T	B	90.6/90.5
C724	4030006880	S.CER C1608 JB 1H 472K-T	B	90.6/90.5
C731	4030006880	S.CER C1608 JB 1H 472K-T	B	63.8/90.8
C732	4030006880	S.CER C1608 JB 1H 472K-T	B	62.8/85.2
C733	4030006880	S.CER C1608 JB 1H 472K-T	B	52.1/98.6
C734	4030006880	S.CER C1608 JB 1H 472K-T	B	42.2/97.7
C735	4030006880	S.CER C1608 JB 1H 472K-T	B	53.4/81.2
C736	4030006880	S.CER C1608 JB 1H 472K-T	B	50.9/81.9
C737	4030006880	S.CER C1608 JB 1H 472K-T	B	47.1/77.5
C741	4030006880	S.CER C1608 JB 1H 472K-T	B	36.4/88.6
C742	4030006880	S.CER C1608 JB 1H 472K-T	B	28.7/97.8

[MAIN UNIT]

REF NO.	ORDER NO.	DESCRIPTION	M.	H/V LOCATION
C743	4030006880	S.CER C1608 JB 1H 472K-T	B	33.1/84.3
C745	4510008540	S.ELE EEE1CA100SR	T	25.9/83.3
C746	4030011600	S.CER C1608 JB 1E 104K-T	B	28.2/85.2
C747	4030011600	S.CER C1608 JB 1E 104K-T	B	28.1/78.6
C748	4510008540	S.ELE EEE1CA100SR	T	21.1/83.3
C761	4510008500	S.ELE EEE1CA101WP	T	46.8/83.4
C762	4510008540	S.ELE EEE1CA100SR	T	53.3/81.5
C842	4030006880	S.CER C1608 JB 1H 472K-T	T	35.7/61.5
C843	4030006880	S.CER C1608 JB 1H 472K-T	T	35/56.3
C844	4030006880	S.CER C1608 JB 1H 472K-T	T	37/58.5
C851	4030006880	S.CER C1608 JB 1H 472K-T	B	72.1/71.7
C852	4030006880	S.CER C1608 JB 1H 472K-T	B	72.1/73.5
C853	4030006880	S.CER C1608 JB 1H 472K-T	B	72.1/75.3
C854	4030006880	S.CER C1608 JB 1H 472K-T	B	72.1/77.1
C855	4030006880	S.CER C1608 JB 1H 472K-T	B	72.2/79.8
C911	4030006880	S.CER C1608 JB 1H 472K-T	B	159/19.6
C912	4030006880	S.CER C1608 JB 1H 472K-T	B	168.2/21
C913	4030006880	S.CER C1608 JB 1H 472K-T	B	158/21
C914	4030006880	S.CER C1608 JB 1H 472K-T	B	168.2/23
C915	4030006880	S.CER C1608 JB 1H 472K-T	B	154.4/24.3
C916	4030006880	S.CER C1608 JB 1H 472K-T	B	168.2/25
C917	4030006880	S.CER C1608 JB 1H 472K-T	B	154.4/26.1
C918	4030006880	S.CER C1608 JB 1H 472K-T	B	168.2/27
C919	4030006880	S.CER C1608 JB 1H 472K-T	B	154.4/27.9
C921	4030006880	S.CER C1608 JB 1H 472K-T	B	168.3/31
C922	4030006880	S.CER C1608 JB 1H 472K-T	B	168.2/33
C923	4030006880	S.CER C1608 JB 1H 472K-T	B	154.8/34.1
C924	4030006880	S.CER C1608 JB 1H 472K-T	B	168.2/35
C925	4030006880	S.CER C1608 JB 1H 472K-T	B	154.8/35.9
C928	4030006880	S.CER C1608 JB 1H 472K-T	T	166.1/41.9
C943	4030006880	S.CER C1608 JB 1H 472K-T	B	12.9/28.1
C944	4030006880	S.CER C1608 JB 1H 472K-T	B	3.2/29.1
C974	4030006880	S.CER C1608 JB 1H 472K-T	B	180.4/26
C975	4030006880	S.CER C1608 JB 1H 472K-T	B	172.1/27
C978	4030006880	S.CER C1608 JB 1H 472K-T	B	180.4/30
C979	4030006880	S.CER C1608 JB 1H 472K-T	B	172.1/31
C981	4030006880	S.CER C1608 JB 1H 472K-T	B	172.1/33
C982	4030006880	S.CER C1608 JB 1H 472K-T	B	172.1/35
C987	4030006880	S.CER C1608 JB 1H 472K-T	B	172.1/39
C991	4030006880	S.CER C1608 JB 1H 472K-T	T	166.1/39.3
C1001	4510007130	S.ELE EEFCD OJ 470R	B	142.2/14.7
C1002	4510007130	S.ELE EEFCD OJ 470R	B	137.4/14.7
C1003	4030011600	S.CER C1608 JB 1E 104K-T	B	120.5/23
C1004	4030011600	S.CER C1608 JB 1E 104K-T	B	119.7/39
C1005	4030011600	S.CER C1608 JB 1E 104K-T	B	124.5/21.6
C1006	4030011600	S.CER C1608 JB 1E 104K-T	B	123.7/41.1
C1007	4030011600	S.CER C1608 JB 1E 104K-T	B	120.5/34.7
C1008	4030011600	S.CER C1608 JB 1E 104K-T	B	120.5/28.2
C1009	4030011600	S.CER C1608 JB 1E 104K-T	B	120.5/36
C1010	4030011600	S.CER C1608 JB 1E 104K-T	B	127.4/21.6
C1011	4030011600	S.CER C1608 JB 1E 104K-T	B	128.6/41.5
C1012	4030011600	S.CER C1608 JB 1E 104K-T	B	130/21
C1013	4030011600	S.CER C1608 JB 1E 104K-T	B	134.8/21.5
C1014	4030011600	S.CER C1608 JB 1E 104K-T	B	134.9/42.3
C1015	4030011600	S.CER C1608 JB 1E 104K-T	B	140.6/26.8
C1016	4030011600	S.CER C1608 JB 1E 104K-T	B	140.5/28.4
C1017	4030011600	S.CER C1608 JB 1E 104K-T	B	145.3/33
C1018	4030011600	S.CER C1608 JB 1E 104K-T	B	136.4/42.3
C1019	4030011600	S.CER C1608 JB 1E 104K-T	B	138/21.5
C1020	4030011600	S.CER C1608 JB 1E 104K-T	B	138/42.3
C1021	4030011600	S.CER C1608 JB 1E 104K-T	B	140.6/25.2
C1022	4030011600	S.CER C1608 JB 1E 104K-T	B	140.5/39.5
C1023	4030016930	S.CER ECJ0EB1A104K	B	128.5/29.1
C1024	4030016930	S.CER ECJ0EB1A104K	B	128.5/30.1
C1025	4030016930	S.CER ECJ0EB1A104K	B	128.5/31.1
C1026	4030016930	S.CER ECJ0EB1A104K	B	128.5/32.1
C1027	4030016930	S.CER ECJ0EB1A104K	B	128.5/33.1
C1028	4030016930	S.CER ECJ0EB1A104K	B	128.5/34.1
C1029	4030016930	S.CER ECJ0EB1A104K	B	133.4/29.1
C1030	4030016930	S.CER ECJ0EB1A104K	B	133.4/30.1
C1031	4030016930	S.CER ECJ0EB1A104K	B	133.4/31.1
C1032	4030016930	S.CER ECJ0EB1A104K	B	133.4/32.1
C1033	4030016930	S.CER ECJ0EB1A104K	B	133.4/33.1
C1034	4030016930	S.CER ECJ0EB1A104K	B	133.4/34.1
C1035	4030016930	S.CER ECJ0EB1A104K	B	132.2/29.1
C1036	4030016930	S.CER ECJ0EB1A104K	B	131.3/30.7
C1037	4030016930	S.CER ECJ0EB1A104K	B	130.3/29.1
C1038				

[MAIN UNIT]

REF NO.	ORDER NO.	DESCRIPTION	M.	H/V LOCATION
C1223	4550007500	S.TAN F931D106MBABMA	B	88.4/13.6
C1224	4030011600	S.CER C1608 JB 1E 104K-T	T	96/14.4
C1225	4030018580	S.CER C1608 CH 1H 821J-T	T	94.7/18.1
C1226	4030007050	S.CER C1608 CH 1H 220J-T	T	90.5/22.4
C1227	4030011600	S.CER C1608 JB 1E 104K-T	T	95.5/16.2
C1231	4550007500	S.TAN F931D106MBABMA	B	102.6/11.2
C1232	4030011600	S.CER C1608 JB 1E 104K-T	T	98.4/9.1
C1233	4550007500	S.TAN F931D106MBABMA	B	110.8/9.7
C1234	4030011600	S.CER C1608 JB 1E 104K-T	T	108.2/6.2
C1235	4030018580	S.CER C1608 CH 1H 821J-T	T	105.6/8.6
C1236	4030007050	S.CER C1608 CH 1H 220J-T	B	101.5/6.8
C1237	4030011600	S.CER C1608 JB 1E 104K-T	T	106.3/6.7
C1241	4550007520	S.TAN F931A106MAABMA	B	106.7/7.8
C1251	4550007480	S.TAN F930J106MAABMA	B	97.5/16.4
C1252	4550007480	S.TAN F930J106MAABMA	B	103.3/17.1
C1253	4030011810	S.CER C1608 JB 1A 224K-T	B	99.9/16.8
C1254	4030011810	S.CER C1608 JB 1A 224K-T	T	98.1/15
C1255	4030017840	S.CER C2012 CH 1H 222J-T	T	103.5/14.1
C1256	4550007480	S.TAN F930J106MAABMA	B	111.2/15.6
C1257	4030011600	S.CER C1608 JB 1E 104K-T	T	107.5/14.3
C1261	4550007480	S.TAN F930J106MAABMA	B	98.5/23.3
C1262	4550007480	S.TAN F930J106MAABMA	B	103.3/22.6
C1263	4030009000	S.CER C2012 JB 1C 224K-T	T	99.5/27.5
C1264	4030009000	S.CER C2012 JB 1C 224K-T	T	100.8/29.2
C1265	4030017840	S.CER C2012 CH 1H 222J-T	T	103.6/27.4
C1266	4030011600	S.CER C1608 JB 1E 104K-T	T	107.4/27.2
C1267	4550007520	S.TAN F931A106MAABMA	B	108.6/25.2
C1301	4550007480	S.TAN F930J106MAABMA	B	108.6/27.7
C1311	4030017810	S.CER C1608 CH 1H 102J-T	B	92.7/26.5
C1312	4030007050	S.CER C1608 CH 1H 220J-T	T	96.2/22.8
C1313	4030011600	S.CER C1608 JB 1E 104K-T	T	87.1/24.5
C1314	4550007520	S.TAN F931A106MAABMA	B	86.2/25.4
C1315	4030011600	S.CER C1608 JB 1E 104K-T	T	97/25.4
C1316	4550007500	S.TAN F931D106MBABMA	B	95.6/24.1
C1317	4030011600	S.CER C1608 JB 1E 104K-T	T	87.9/22.4
C1318	4550007500	S.TAN F931D106MBABMA	B	90/25.1
C1321	4030017810	S.CER C1608 CH 1H 102J-T	T	109.5/30.5
C1322	4030007050	S.CER C1608 CH 1H 220J-T	T	113.8/32.4
C1323	4030011600	S.CER C1608 JB 1E 104K-T	T	103.4/30.5
C1324	4550007520	S.TAN F931A106MAABMA	B	104.2/32.1
C1325	4030011600	S.CER C1608 JB 1E 104K-T	T	113.8/35.2
C1326	4550007500	S.TAN F931D106MBABMA	B	113.7/32.1
C1327	4030011600	S.CER C1608 JB 1E 104K-T	T	104.6/30.5
C1328	4550007500	S.TAN F931D106MBABMA	B	107.2/32.1
C1330	4030007170	S.CER C1608 CH 1H 221J-T	B	83.7/26.6
C1331	4030007050	S.CER C1608 CH 1H 220J-T	T	101.9/35.5
C1333	4030011600	S.CER C1608 JB 1E 104K-T	T	101.9/31.9
C1334	4550007500	S.TAN F931D106MBABMA	B	100/34.1
C1335	4030011600	S.CER C1608 JB 1E 104K-T	T	92.7/32.4
C1336	4550007500	S.TAN F931D106MBABMA	B	97.7/30.1
C1351	4030011600	S.CER C1608 JB 1E 104K-T	T	75.1/13.9
C1352	4550007500	S.TAN F931D106MBABMA	B	74.3/16.1
C1353	4030011600	S.CER C1608 JB 1E 104K-T	T	79/21.3
C1354	4550007500	S.TAN F931D106MBABMA	B	81.8/16.2
C1355	4030007090	S.CER C1608 CH 1H 470J-T	B	77.3/15.2
C1361	4030011600	S.CER C1608 JB 1E 104K-T	B	79.5/7
C1362	4510008540	S.ELE EEE1CA100SR	T	79.6/7.9
C1363	4030011600	S.CER C1608 JB 1E 104K-T	B	73.4/10.6
C1401	4550007480	S.TAN F930J106MAABMA	B	81.8/26.3
C1402	4030011600	S.CER C1608 JB 1E 104K-T	T	82.3/24.8
C1403	4030011810	S.CER C1608 JB 1A 224K-T	T	82.3/26.4
C1404	4550007520	S.TAN F931A106MAABMA	B	79.5/32.8
C1405	4030011600	S.CER C1608 JB 1E 104K-T	B	80.7/31.1
C1406	4030017840	S.CER C2012 CH 1H 222J-T	B	79.8/27.6
C1407	4030011600	S.CER C1608 JB 1E 104K-T	T	82.3/29
C1408	4550007480	S.TAN F930J106MAABMA	B	76.7/27.5
C1421	4550007480	S.TAN F930J106MAABMA	B	74.4/22.9
C1422	4030011600	S.CER C1608 JB 1E 104K-T	T	72.2/23.9
C1423	4030011810	S.CER C1608 JB 1A 224K-T	T	70.7/25.1
C1424	4030017840	S.CER C2012 CH 1H 222J-T	B	71.9/27.1
C1425	4030011600	S.CER C1608 JB 1E 104K-T	T	70.5/29.3
C1426	4550007520	S.TAN F931A106MAABMA	B	74.2/26.4
C1431	4030011600	S.CER C1608 JB 1E 104K-T	T	122.5/46.9
C1441	4030011600	S.CER C1608 JB 1E 104K-T	T	119.4/48.2
C1442	4030006860	S.CER C1608 JB 1H 102K-T	B	121.2/47
C1451	4030006860	S.CER C1608 JB 1H 102K-T	T	63.5/22.4
C1453	4030011600	S.CER C1608 JB 1E 104K-T	T	65.4/21.7
C1454	4550007480	S.TAN F930J106MAABMA	B	65.7/16.9
C1455	4030011600	S.CER C1608 JB 1E 104K-T	B	64.4/23.3
C1456	4550007480	S.TAN F930J106MAABMA	B	69.4/38.9
C1461	4030006860	S.CER C1608 JB 1H 102K-T	T	68.5/22.4
C1463	4030011600	S.CER C1608 JB 1E 104K-T	T	66.6/21.7
C1464	4550007480	S.TAN F930J106MAABMA	B	69.5/27.4
C1472	4550007660	S.TAN F931E105MAABMA	B	71.8/38.9
C1481	4030011600	S.CER C1608 JB 1E 104K-T	T	69.4/27.4
C1482	4550007520	S.TAN F931A106MAABMA	B	66.4/22.1
C1483	4030011600	S.CER C1608 JB 1E 104K-T	T	66/32.3
C1484	4550007500	S.TAN F931D106MBABMA	T	70.2/38.3
C1501	4030011600	S.CER C1608 JB 1E 104K-T	T	113.6/45.9
C1502	4550007520	S.TAN F931A106MAABMA	B	108.9/48.4
C1503	4030011600	S.CER C1608 JB 1E 104K-T	T	102.1/43.7
C1504	4550007520	S.TAN F931A106MAABMA	B	108.9/46
C1505	4550007520	S.TAN F931A106MAABMA	B	105.1/43.1
C1506	4030011600	S.CER C1608 JB 1E 104K-T	T	102.3/44.9
C1507	4030011600	S.CER C1608 JB 1E 104K-T	T	102.9/41.9
C1512	4030018610	S.CER C1608 CH 1H 182J-T	B	94.8/42.5
C1513	4030018610	S.CER C1608 CH 1H 182J-T	B	101.7/37.7
C1514	4030007050	S.CER C1608 CH 1H 220J-T	T	90.6/39.5
C1522	4030018610	S.CER C1608 CH 1H 182J-T	B	94.8/46.4
C1523	4030018610	S.CER C1608 CH 1H 182J-T	B	101.6/43.9
C1524	4030007050	S.CER C1608 CH 1H 220J-T	T	90.6/45.9
C1531	4030017800	S.CER C1608 CH 1H 561J-T	B	87.5/38
C1532	4030017800	S.CER C1608 CH 1H 561J-T	B	92/36.1
C1533	4030007050	S.CER C1608 CH 1H 220J-T	B	84.7/36.6

[MAIN UNIT]

REF NO.	ORDER NO.	DESCRIPTION	M.	H/V LOCATION
C1541	4030011600	S.CER C1608 JB 1E 104K-T	T	91.9/38.7
C1542	4550007500	S.TAN F931D106MBABMA	B	94.8/36.6
C1543	4030011600	S.CER C1608 JB 1E 104K-T	T	97.9/43.8
C1544	4550007500	S.TAN F931D106MBABMA	B	108.1/38.7
C1551	4030011600	S.CER C1608 JB 1E 104K-T	T	91.9/45.3
C1552	4550007500	S.TAN F931D106MBABMA	B	93.8/51.5
C1553	4030011600	S.CER C1608 JB 1E 104K-T	T	101.4/48.3
C1554	4550007500	S.TAN F931D106MBABMA	B	103.8/51.2
C1561	4030011600	S.CER C1608 JB 1E 104K-T	B	87.4/34.7
C1562	4550007500	S.TAN F931D106MBABMA	B	88.5/32.1
C1563	4030011600	S.CER C1608 JB 1E 104K-T	T	92.7/36.9
C1564	4550007500	S.TAN F931D106MBABMA	T	89.2/30.2
C1571	4030019130	S.CER C2012 CH 1H 562JT-NS	T	108.5/48.7
C1572	4030018580	S.CER C1608 CH 1H 821J-T	B	107.8/57.5
C1573	4030018580	S.CER C1608 CH 1H 821J-T	B	105.3/56
C1574	4030011600	S.CER C1608 JB 1E 104K-T	B	111.6/53.7
C1575	4510008540	S.ELE EEE1CA100SR	T	111.9/55.2
C1576	4030011600	S.CER C1608 JB 1E 104K-T	T	102.6/56.8
C1577	4510008540	S.ELE EEE1CA100SR	T	99.5/55.2
C1578	4030007050	S.CER C1608 CH 1H 220J-T	T	106/60
C1601	4510008540	S.ELE EEE1CA100SR	T	94.2/54.3
C1602	4030011600	S.CER C1608 JB 1E 104K-T	T	89.7/48.4
C1603	4030011600	S.CER C1608 JB 1E 104K-T	T	90.5/42.1
C1604	4030011600	S.CER C1608 JB 1E 104K-T	T	78.6/38.4
C1605	4510008540	S.ELE EEE1CA100SR	T	87.8/53.9
C1611	4030019130	S.CER C2012 CH 1H 562JT-NS	T	76.5/39.5
C1612	4030018580	S.CER C1608 CH 1H 821J-T	B	81.5/38.7
C1613	4030018580	S.CER C1608 CH 1H 821J-T	B	79.1/39.7
C1621	4030018620	S.CER C1608 CH 1H 222J-T	T	76.7/43.2
C1622	4030011600	S.CER C1608 JB 1E 104K-T	B	70.8/47.3
C1623	4510008540	S.ELE EEE1CA101WP	T	71.6/46.1
C1624	4030017870	S.CER C1608 CH 1H 681J-T	B	73.8/47.3
C1625	4030017870	S.CER C1608 CH 1H 681J-T	B	77.6/50.3
C1631	4510008540	S.ELE EEE1CA100SR	T	81.5/53.9
C1632	4030011600	S.CER C1608 JB 1E 104K-T	B	84.2/49.1
C1641	4030011600	S.CER C1608 JB 1E 104K-T	B	81.8/40.5
C1642	4510008540	S.ELE EEE1CA100SR	T	77.8/47.2
C1651	4030011600	S.CER C1608 JB 1E 104K-T	B	162.6/12.9
C1652	4510008540	S.ELE EEE1CA100SR	T	153.8/3.4
C1653	4030011600	S.CER C1608 JB 1E 104K-T	B	152.5/3.9
C1654	4030017490	S.CER C1608 JB 1A 105K-T	B	161.8/4.9
C1655	4550007460	S.TAN F930G107MBABMA	B	149.6/11.8
C1801	4030011600	S.CER C1608 JB 1E 104K-T	B	175.5/50.1
C1841	4030011600	S.CER C1608 JB 1E 104K-T	B	175/62.8
C1921	4030011600	S.CER C1608 JB 1E 104K-T	T	86.1/77.8
C1922	4030011600	S.CER C1608 JB 1E 104K-T	T	86.1/73.4
C1930	4030011600	S.CER C1608 JB 1E 104K-T	T	101.9/79
C1931	4030011600	S.CER C1608 JB 1E 104K-T	T	101.9/76
C2001	4030011600	S.CER C1608 JB 1E 104K-T	B	112.9/72.6
C2002	4030011600	S.CER C1608 JB 1E 104K-T	T	118.2/73.2
C2003	4030011600	S.CER C1608 JB 1E 104K-T	T	140.8/86.6
C2004	4030011600	S.CER C1608 JB 1E 104K-T	T	127/85.9
C2045	4030006860	S.CER C1608 JB 1H 102K-T	T	130.6/81.8
C2051	4030006860	S.CER C1608 JB 1H 102K-T	T	139.2/83.4
C2053	4030012600	S.CER C2012 JB 1A 105M-T	B	143.8/74.3
C2056	4030012600	S.CER C2012 JB 1A 105M-T	B	139.2/74.2
C2057	4030012600	S.CER C2012 JB 1A 105M-T	B	139.9/72.3
C2058	4510008540	S.ELE EEE1CA100SR	T	142.3/72
C2059	4030009530	S.CER C1608 CH 1H 030B-T	T	121.4/75
C2060	4030011600	S.CER C1608 JB 1E 104K-T	T	138.6/77.2
C2061	4030012600	S.CER C2012 JB 1A 105M-T	B	139.6/76.2
RL261	6330001860	RLY UA2-12NU		
RL721	6330000540	RLY 2-1419131-2 (OMR-109F)		
CP2041	6910009670	S.CHK HK3-S-T	T	150.7/72.8
CP2051	6910009670	S.CHK HK3-S-T	T	123.6/71
J701	6510026830	CNR AT29LV040A-15TU		
J702	6510026830	CNR AT29LV040A-15TU		
J711	6510023740	CNR LGR4609-7000		
J721	6450001130	CNR JJP2042-01-110		
J731	6510023671	CNR TCS4480-0141577		
J741	6510023661	CNR TCS4470-0141577		
J751	6510023720	CNR LGY6501-0600C		
J761	6510023750	CNR 01K1971-10		
J762	6510007020	CNR TMP-J01X-V6		
J801	6510007020	CNR TMP		

[MAIN UNIT]

REF NO.	ORDER NO.	DESCRIPTION	M.	H/V LOCATION
EP752	6910014730	S.BEA MPZ2012S331A-T	T	8.9/95.9
EP811	6910014690	S.BEA MPZ1608S221A-T	T	32.2/5.3
EP812	6910014690	S.BEA MPZ1608S221A-T	T	30.8/5.4
EP813	6910014690	S.BEA MPZ1608S221A-T	T	26.2/5.3
EP814	6910012350	S.BEA MMZ1608Y 102BT	T	24.2/5.3
EP815	6910014690	S.BEA MPZ1608S221A-T	T	22.2/5.4
EP816	6910014690	S.BEA MPZ1608S221A-T	T	19.4/16.6
EP842	6910014690	S.BEA MPZ1608S221A-T	T	35/59.6
EP843	6910014690	S.BEA MPZ1608S221A-T	T	35/57.6
EP851	6910012350	S.BEA MMZ1608Y 102BT	B	75.3/71.7
EP852	6910012350	S.BEA MMZ1608Y 102BT	B	75.3/73.5
EP853	6910012350	S.BEA MMZ1608Y 102BT	B	75.3/75.3
EP854	6910014690	S.BEA MPZ1608S221A-T	B	75.3/77.1
EP855	6910012350	S.BEA MMZ1608Y 102BT	B	75.3/80.1
EP941	6910012350	S.BEA MMZ1608Y 102BT	B	10/31
EP942	6910012350	S.BEA MMZ1608Y 102BT	T	4.8/30
EP943	6910012350	S.BEA MMZ1608Y 102BT	B	9.9/29
EP944	6910012350	S.BEA MMZ1608Y 102BT	T	4.8/28
EP954	6910012350	S.BEA MMZ1608Y 102BT	B	10/19.3
EP987	6910012350	S.BEA MMZ1608Y 102BT	T	172.1/39
EP991	6910012350	S.BEA MMZ1608Y 102BT	T	166.1/38
EP992	6910012350	S.BEA MMZ1608Y 102BT	T	166.1/40.6
EP1001	6910014690	S.BEA MPZ1608S221A-T	B	119.2/17
EP1251	6910014690	S.BEA MPZ1608S221A-T	T	112.3/8.1
EP1401	6910014690	S.BEA MPZ1608S221A-T	T	85/31
EP1498	6910014690	S.BEA MPZ1608S221A-T	T	103.6/71.7
EP1651	6910014690	S.BEA MPZ1608S221A-T	B	162.6/11.1
EP1911	6910014690	S.BEA MPZ1608S221A-T	B	120.1/83.4

[PLL UNIT]

REF NO.	ORDER NO.	DESCRIPTION	M.	H/V LOCATION
IC1	1130011530	S.IC CD74HC4094M96	B	151.5/16.9
IC2	1130009691	S.IC TC74HCT7007AF (F)	T	152.7/17.7
IC51	1180001251	S.IC TA7808F (TE16L,Q)	T	164.8/92.2
IC61	1180000421	S.IC TA78L05F (TE12R,F)	B	168.5/68.5
IC101	1190002101	S.IC AD9951YSVZ	T	101.2/27.2
IC102	1130010560	S.IC SN74AHC244PWR	T	113/33
IC103	1180003190	S.REG uPD120N33TA-E1-A	T	111.4/40.1
IC104	1180003200	S.REG uPD120N18TA-E1-A	T	103.2/40.1
IC201	1130013270	S.IC ADF4116BRUZ	T	149.5/36.7
IC501	1140007881	S.IC TC190G08EFG0046JDZ/SC1246A	T	50.1/42.7
IC503	1130003831	S.IC TC7S04F (TE85R,F)	T	38.5/43.1
IC602	1130006441	S.IC TC7S08F (TE85R,F)	T	98.2/50.6
IC651	1140007881	S.IC TC190G08EFG0046JDZ/SC1246A	T	12.7/71
IC652	1130003831	S.IC TC7S04F (TE85R,F)	T	10.2/58.4
IC1651	1130003831	S.IC TC7S04F (TE85R,F)	T	30.7/26.5
IC1652	1140007881	S.IC TC190G08EFG0046JDZ/SC1246A	T	16.7/22.8
IC1701	1130006441	S.IC TC7S08F (TE85R,F)	T	30.4/20.3
Q1	1590001050	S.TR DTC114TUA T106	B	158.2/17.2
Q30	1530002060	S.TR 2SC4081 T106 R	B	74.5/32.1
Q41	1590000680	S.TR DTC114EUA T106	T	142.8/8.9
Q101	1530003151	S.TR 2SC4673D-TD-E	T	89.7/30.3
Q151	1530002060	S.TR 2SC4081 T106 R	B	130.9/43.8
Q201	1590000680	S.TR DTC114EUA T106	T	154.3/38.1
Q220	1560000331	S.FET 2SK210-GR (TE85R,F)	T	150.8/83
Q230	1560000331	S.FET 2SK210-GR (TE85R,F)	T	138.3/83
Q240	1560000331	S.FET 2SK210-GR (TE85R,F)	T	125.8/83
Q250	1560000331	S.FET 2SK210-GR (TE85R,F)	T	113.3/83
Q260	1560000331	S.FET 2SK210-GR (TE85R,F)	T	100.8/83
Q270	1560000331	S.FET 2SK210-GR (TE85R,F)	T	88.9/83
Q280	1590000680	S.TR DTC114EUA T106	T	150.3/92.8
Q281	1590000680	S.TR DTC114EUA T106	T	137.8/92.8
Q282	1590000680	S.TR DTC114EUA T106	T	125.3/92.8
Q283	1590000680	S.TR DTC114EUA T106	T	112.8/92.8
Q284	1590000680	S.TR DTC114EUA T106	T	100.3/92.8
Q285	1590000680	S.TR DTC114EUA T106	T	88.3/92.8
Q301	1530003431	S.TR 2SC5226-4-TL-E	T	154.6/102.6
Q302	1530003431	S.TR 2SC5226-4-TL-E	B	141.5/99.6
Q303	1530003431	S.TR 2SC5226-4-TL-E	B	158/101.7
Q341	1590000680	S.TR DTC114EUA T106	T	148/96.8
Q351	1580000751	S.FET 3SK294 (TE85L,F)	T	127.8/103.2
Q352	1530003431	S.TR 2SC5226-4-TL-E	B	121/99.6
Q441	1590000680	S.TR DTC114EUA T106	T	111/97
Q502	1590000680	S.TR DTC114EUA T106	T	63.3/52.9
Q540	1530002060	S.TR 2SC4081 T106 R	T	57.7/75.9
Q541	1560000331	S.FET 2SK210-GR (TE85R,F)	T	41.1/73.5
Q561	1530003431	S.TR 2SC5226-4-TL-E	T	41.4/82.4
Q580	1530003431	S.TR 2SC5226-4-TL-E	T	45.2/53.1
Q591	1530003151	S.TR 2SC4673D-TD-E	B	64.9/84.2
Q592	1520000561	S.TR 2SB1123 T-TD-E	B	73/87.3
Q593	1590000680	S.TR DTC114EUA T106	B	72.8/97.5
Q680	1530002060	S.TR 2SC4081 T106 R	T	8.5/85.5
Q702	1530002601	S.TR 2SC4215-O (TE85R,F)	B	78.1/38.7
Q801	1560000561	S.FET 2SK882-GR (TE85L,F)	T	61.1/92.1
Q811	1560000561	S.FET 2SK882-GR (TE85L,F)	T	18.3/92.7
Q831	1560000561	S.FET 2SK882-GR (TE85L,F)	T	22.1/102.6
Q832	1520000561	S.TR 2SB1123 T-TD-E	T	53/99.4
Q833	1590000680	S.TR DTC114EUA T106	B	51.7/106.6
Q1601	1530002601	S.TR 2SC4215-O (TE85R,F)	T	80.7/56.2
Q1680	1530002060	S.TR 2SC4081 T106 R	T	15.9/51.6
D201	1750000520	S.DIO DAN222TL	T	144.7/6.6
D205	1790001250	S.DIO MA2S111-(TX)	T	154.3/30.7
D220	1720000590	S.VCP MA357 (TX)	T	152.9/61.3
D221	1720000590	S.VCP MA357 (TX)	T	152.9/63.4
D222	1790000620	S.DIO MA77 (TX)	T	154.9/93.4
D230	1720000590	S.VCP MA357 (TX)	T	140.5/61.3
D231	1720000590	S.VCP MA357 (TX)	T	140.5/63.4
D232	1790000620	S.DIO MA77 (TX)	T	142.5/93.1
D240	1720000590	S.VCP MA357 (TX)	T	128/61.3
D242	1790000620	S.DIO MA77 (TX)	T	129.9/93.4
D250	1720000590	S.VCP MA357 (TX)	T	115.5/61.3
D252	1790000620	S.DIO MA77 (TX)	T	117.4/93.4
D261	1720000590	S.VCP MA357 (TX)	T	103/63.4
D262	1790000620	S.DIO MA77 (TX)	T	104.9/93.4
D263	1720000590	S.VCP MA357 (TX)	T	100.3/62.9
D270	1720000590	S.VCP MA357 (TX)	T	90.5/61.3
D271	1720000590	S.VCP MA357 (TX)	T	88/62.9
D272	1790000620	S.DIO MA77 (TX)	T	92.7/93.4
D341	1790000620	S.DIO MA77 (TX)	T	147.5/100.5
D342	1160000070	S.DIO DAN202K T146	B	136/91.6
D441	1790000620	S.DIO MA77 (TX)	T	110.3/100.1
D501	1750000520	S.DIO DAN222TL	T	60.5/53.4
D542	1720000590	S.VCP MA357 (TX)	T	45.5/62.1
D821	1750000431	S.DIO HSB88WSTR-E	T	43.4/97.3
FI101	2020001820	S.CER SFECV10M5FA00-R0	T	112.2/22.2
FI831	2030000300	S.MLH FL-356 (64.491 MHz)	T	27/103
L1	6200003261	S.COL NLV32T-101J	B	156.6/23.9
L2	6200003261	S.COL NLV32T-101J	T	155.8/24.7
L20	6200003321	S.COL NLV32T-3R3J	T	79.6/102.1
L30	6200005491	S.COL NLV32T-331J	T	73.1/27.7
L101	6200001831	S.COL NLV32T-100J	T	114.6/39.5
L102	6200002641	S.COL NLV25T-R15J	T	90.4/23.4
L103	6140002810	S.COL LR-317 (T	104/15.2
L123	6200004951	S.COL NLV25T-1R8J	T	113.7/16.7
L161	6200001981	S.COL NLV25T-1R0J	B	123.4/35.6
L201	6200005011	S.COL NLV25T-100J	T	143.3/31
L211	6200003661	S.COL NLV25T-R68J	B	153/54.3

M.=Mounted side (T: Mounted on the Top side B: Mounted on the Bottom side)
S.=Surface mount

[PLL UNIT]

REF NO.	ORDER NO.	DESCRIPTION	M.	H/V LOCATION
L220	6200010790	S.COL C2520C-3R9G-A	T	147.2/62.4
L221	6190001421	COL #E526GN-110502		
L222	6200010790	S.COL C2520C-3R9G-A	T	147/86.7
L230	6200010830	S.COL C2520C-3R3G-A	T	134.7/62.4
L231	6190001421	COL #E526GN-110502		
L232	6200010830	S.COL C2520C-3R3G-A	T	134.5/86.7
L240	6200010830	S.COL C2520C-3R3G-A	T	122.3/62.4
L241	6190001421	COL #E526GN-110502		
L242	6200010830	S.COL C2520C-3R3G-A	T	122/86.7
L250	6200010820	S.COL C2520C-2R7G-A	T	109.8/62.4
L251	6190001421	COL #E526GN-110502		
L252	6200010820	S.COL C2520C-2R7G-A	T	109.5/86.7
L260	6200010820	S.COL C2520C-2R7G-A	T	97.3/62.4
L261	6190001411	COL #E526GN-110501		
L262	6200010820	S.COL C2520C-2R7G-A	T	97/86.7
L270	6200010810	S.COL C2520C-2R2G-A	T	84.9/62.4
L271	6190001411	COL #E526GN-110501		
L272	6200010810	S.COL C2520C-2R2G-A	T	85.8/86.6
L280	6200005011	S.COL NLV25T-100J	T	160/74.6
L302	6200001831	S.COL NLV32T-100J	T	142.1/99.8
L331	6200002641	S.COL NLV25T-F15J	T	150.6/105.6
L332	6200002411	S.COL NLV25T-056J	T	149/102.7
L341	6200003261	S.COL NLV32T-101J	T	145.1/97.5
L351	6200001831	S.COL NLV32T-100J	T	122.7/101.8
L441	6200002601	S.COL NLV25T-047J	T	112.4/102.4
L442	6200010730	S.COL C2520C-68NG-A	T	106.5/101
L451	6200002641	S.COL NLV25T-F15J	T	103.7/105.5
L452	6200003261	S.COL NLV32T-101J	T	106.3/97.9
L501	6200001831	S.COL NLV32T-100J	T	66.8/42.4
L530	6200003171	S.COL NLV32T-330J	T	57.7/26
L531	6200003171	S.COL NLV32T-330J	T	61.8/26
L532	6200003171	S.COL NLV32T-330J	T	65.5/26.9
L541	6200010790	S.COL C2520C-3R9G-A	T	46.9/65.3
L542	6190001421	COL #E526GN-110502		
L543	6200010790	S.COL C2520C-3R9G-A	T	39.8/76.6
L544	6200003261	S.COL NLV32T-101J	B	45.2/66.1
L545	6200003261	S.COL NLV32T-101J	B	55.4/78.2
L561	6200003261	S.COL NLV32T-101J	B	76/92
L562	6200001831	S.COL NLV32T-100J	T	51.6/105.4
L565	6150004250	COL LS-471A (C-14922)		
L566	6150004250	COL LS-471A (C-14922)		
L591	6200007790	S.COL LQW2BHN1R15J03L	B	69/81.9
L651	6200001831	S.COL NLV32T-100J	B	4.4/60.7
L681	6200005491	S.COL NLV32T-331J	T	30.2/78.1
L682	6200008641	S.COL NLV32T-391J	T	29.2/81.5
L683	6200008641	S.COL NLV32T-391J	T	18.7/85.7
L701	6200003261	S.COL NLV32T-101J	T	73.1/31.8
L702	6150004971	S.COL LS-522-LF	T	77.2/38.1
L703	6150004971	S.COL LS-522-LF	T	77.2/48.2
L801	6150004280	COL LS-484B (C-14927)		
L812	6200003231	S.COL NLV32T-181J	T	22.8/92.2
L821	6140003530	COL LR-395		
L822	6140003530	COL LR-395		
L831	6140003770	S.COL LR-414 4KBL (STP-01435)	T	34.4/104.5
L834	6150004280	COL LS-484B (C-14927)		
L1601	6200001831	S.COL NLV32T-100J	B	87.4/55.3
L1602	6200002641	S.COL NLV25T-R15J	T	76.9/57.8
L1603	6200002841	S.COL NLV25T-R22J	T	77.2/63.4
L1651	6200001831	S.COL NLV32T-100J	B	29.1/11.5
L1681	6200002981	S.COL NLV32T-R56J	T	12.3/40.5
L1682	6200003041	S.COL NLV32T-R68J	T	8.7/39.7
L1683	6200003051	S.COL NLV32T-R82J	B	21.3/44.1
R1	7030003680	S.RES ERJ3GEYJ 104 V (100 k)	B	160.9/17.1
R2	7030003560	S.RES ERJ3GEYJ 103 V (10 k)	B	158.1/19.4
R3	7030003550	S.RES ERJ3GEYJ 822 V (8.2 k)	T	153.3/10.3
R4	7030003550	S.RES ERJ3GEYJ 822 V (8.2 k)	T	149.3/10.3
R5	7030003550	S.RES ERJ3GEYJ 822 V (8.2 k)	T	148/10.3
R6	7030003550	S.RES ERJ3GEYJ 822 V (8.2 k)	T	146.7/10.3
R7	7030003500	S.RES ERJ3GEYJ 332 V (3.3 k)	B	162.3/22.3
R9	7030003680	S.RES ERJ3GEYJ 104 V (100 k)	B	164.7/23.1
R10	7030003360	S.RES ERJ3GEYJ 221 V (220)	T	160/16.8
R11	7030003360	S.RES ERJ3GEYJ 221 V (220)	T	160/18.1
R13	7030003360	S.RES ERJ3GEYJ 221 V (220)	T	160/20.7
R14	7030003360	S.RES ERJ3GEYJ 221 V (220)	T	160/22
R15	7030003360	S.RES ERJ3GEYJ 221 V (220)	T	160/23.3
R16	7030003360	S.RES ERJ3GEYJ 221 V (220)	T	160/26.1
R17	7030003360	S.RES ERJ3GEYJ 221 V (220)	T	160/28.2
R18	7030003550	S.RES ERJ3GEYJ 822 V (8.2 k)	B	152.8/22
R19	7030003550	S.RES ERJ3GEYJ 822 V (8.2 k)	T	152/10.3
R30	7030003240	S.RES ERJ3GEYJ 220 V (22)	B	78/29.7
R31	7030003600	S.RES ERJ3GEYJ 223 V (22 k)	B	74.7/27.9
R32	7030003320	S.RES ERJ3GEYJ 101 V (100)	B	74.7/34.5
R33	7030003340	S.RES ERJ3GEYJ 151 V (150)	B	78/26.1
R51	7030011030	S.RES ERJ1TYJ 270U (27)	T	172.7/91.9
R52	7030010550	S.RES ERJ1TYJ 820U (82)	B	169.5/91.9
R61	7030011030	S.RES ERJ1TYJ 270U (27)	T	169.9/73.2
R101	7030003290	S.RES ERJ3GEYJ 560 V (56)	T	87.5/34.1
R102	7030003360	S.RES ERJ3GEYJ 221 V (220)	T	90.3/34.1
R103	7030003290	S.RES ERJ3GEYJ 560 V (56)	T	94.3/34.1
R104	7030003560	S.RES ERJ3GEYJ 103 V (10 k)	T	93.6/32.1
R105	7030003480	S.RES ERJ3GEYJ 222 V (2.2 k)	T	94.9/32.1
R106	7030003320	S.RES ERJ3GEYJ 101 V (100)	T	91.5/27.1
R107	7030003320	S.RES ERJ3GEYJ 101 V (100)	T	93.6/21.2
R108	7030003440	S.RES ERJ3GEYJ 102 V (1 k)	T	96.6/32
R109	7030003440	S.RES ERJ3GEYJ 102 V (1 k)	T	101.8/34.1
R110	7030003440	S.RES ERJ3GEYJ 102 V (1 k)	T	103.1/34.1
R111	7030003440	S.RES ERJ3GEYJ 102 V (1 k)	T	104.4/34.1
R112	7030003440	S.RES ERJ3GEYJ 102 V (1 k)	T	107.4/31.1
R113	7030003510	S.RES ERJ3GEYJ 392 V (3.9 k)	T	105.1/21.4
R114	7030003320	S.RES ERJ3GEYJ 101 V (100)	B	103.5/22.6
R115	7030003320	S.RES ERJ3GEYJ 101 V (100)	B	101.3/22.6
R131	7030003320	S.RES ERJ3GEYJ 101 V (100)	T	114.3/27.9

[PLL UNIT]

REF NO.	ORDER NO.	DESCRIPTION	M.	H/V LOCATION
R132	7030003410	S.RES ERJ3GEYJ 561 V (560)	T	111.5/27.9
R133	7030003320	S.RES ERJ3GEYJ 101 V (100)	T	111.5/26.6
R138	7030003860	S.RES ERJ3GE JPW V	T	108.7/15.1
R159	7030003200	S.RES ERJ3GEYJ 100 V (10)	B	126.4/43.2
R160	7030003370	S.RES ERJ3GEYJ 271 V (270)	B	128.2/43.2
R161	7030003640	S.RES ERJ3GEYJ 473 V (47 k)	B	133.6/43.2
R201	7030003520	S.RES ERJ3GEYJ 472 V (4.7 k)	T	154.4/40
R202	7030003440	S.RES ERJ3GEYJ 102 V (1 k)	B	146.8/30
R203	7030003440	S.RES ERJ3GEYJ 102 V (1 k)	B	148.8/30
R204	7030003360	S.RES ERJ3GEYJ 221 V (220)	B	150.4/30
R205	7030003560	S.RES ERJ3GEYJ 103 V (10 k)	T	154.3/32
R206	7030003860	S.RES ERJ3GE JPW V	T	142.6/39.9
R210	7030003860	S.RES ERJ3GE JPW V	T	150.8/46
R217	7030009861	S.RES ERA3YED 471V (470)	B	147.3/49.2
R219	7030009861	S.RES ERA3YED 471V (470)	B	152.6/48.9
R220	7030003680	S.RES ERJ3GEYJ 104 V (100 k)	T	147.1/83.7
R221	7030003680	S.RES ERJ3GEYJ 104 V (100 k)	T	153.8/82.8
R222	7030003360	S.RES ERJ3GEYJ 221 V (220)	T	146.4/92.4
R223	7030003440	S.RES ERJ3GEYJ 102 V (1 k)	T	152.8/92.4
R224	7030003320	S.RES ERJ3GEYJ 101 V (100)	T	144.5/83.7
R230	7030003680	S.RES ERJ3GEYJ 104 V (100 k)	T	134.6/83.7
R231	7030003680	S.RES ERJ3GEYJ 104 V (100 k)	T	141.4/82.8
R232	7030003360	S.RES ERJ3GEYJ 221 V (220)	T	133.9/92.4
R233	7030003440	S.RES ERJ3GEYJ 102 V (1 k)	T	140.3/92.4
R234	7030003320	S.RES ERJ3GEYJ 101 V (100)	T	132/83.7
R240	7030003680	S.RES ERJ3GEYJ 104 V (100 k)	T	122.1/83.7
R241	7030003680	S.RES ERJ3GEYJ 104 V (100 k)	T	128.9/82.8
R242	7030003360	S.RES ERJ3GEYJ 221 V (220)	T	121.4/92.4
R243	7030003440	S.RES ERJ3GEYJ 102 V (1 k)	T	127.8/92.4
R244	7030003320	S.RES ERJ3GEYJ 101 V (100)	T	119.5/83.7
R250	7030003680	S.RES ERJ3GEYJ 104 V (100 k)	T	109.6/83.7
R251	7030003680	S.RES ERJ3GEYJ 104 V (100 k)	T	116.3/82.8
R252	7030003360	S.RES ERJ3GEYJ 221 V (220)	T	108.9/92.4
R253	7030003440	S.RES ERJ3GEYJ 102 V (1 k)	T	115.3/92.4
R254	7030003320	S.RES ERJ3GEYJ 101 V (100)	T	107/83.7
R260	7030003680	S.RES ERJ3GEYJ 104 V (100 k)	T	97.1/83.7
R261	7030003680	S.RES ERJ3GEYJ 104 V (100 k)	T	103.8/82.8
R262	7030003360	S.RES ERJ3GEYJ 221 V (220)	T	96.4/92.4
R263	7030003440	S.RES ERJ3GEYJ 102 V (1 k)	T	102.8/92.4
R264	7030003320	S.RES ERJ3GEYJ 101 V (100)	T	94.5/83.7
R270	7030003680	S.RES ERJ3GEYJ 104 V (100 k)	T	85.2/83.5
R271	7030003680	S.RES ERJ3GEYJ 104 V (100 k)	T	91.9/82.8
R272	7030003360	S.RES ERJ3GEYJ 221 V (220)	T	83.9/93.4
R273	7030003440	S.RES ERJ3GEYJ 102 V (1 k)	T	90.8/92.4
R274	7030003320	S.RES ERJ3GEYJ 101 V (100)	T	82.6/83.7
R281	7030003440	S.RES ERJ3GEYJ 102 V (1 k)	B	76.1/68.8
R282	7030003440	S.RES ERJ3GEYJ 102 V (1 k)	B	73/67.9
R283	7030003440	S.RES ERJ3GEYJ 102 V (1 k)	B	76.1/67
R284	7030003440	S.RES ERJ3GEYJ 102 V (1 k)	B	73/66.1
R285	7030003440	S.RES ERJ3GEYJ 102 V (1 k)	B	76.1/65.2
R286	7030003440	S.RES ERJ3GEYJ 102 V (1 k)	B	73/64.3
R301	7030003200	S.RES ERJ3GEYJ 100 V (10)	T	154.1/97
R302	7030003440	S.RES ERJ3GEYJ 102 V (1 k)	T	155.4/97
R303	7030003360	S.RES ERJ3GEYJ 221 V (220)	T	156.7/102.6
R304	7030003490	S.RES ERJ3GEYJ 272 V (2.7 k)	T	154.6/104.5
R305	7030003510	S.RES ERJ3GEYJ 392 V (3.9 k)	T	154.6/105.8
R306	7030003360	S.RES ERJ3GEYJ 221 V (220)	T	152.5/105.2
R307	7030003260	S.RES ERJ3GEYJ 330 V (33)	T	152.5/102.6
R308	7030003370	S.RES ERJ3GEYJ 271 V (270)	B	141.2/102.1
R309	7030003540	S.RES ERJ3GEYJ 682 V (6.8 k)	B	136.2/99.6
R310	7030003500	S.RES ERJ3GEYJ 332 V (3.3 k)	B	136.6/101.9
R311	7030003350	S.RES ERJ3GEYJ 181 V (180)	B	138.1/98.8
R312	7030003360	S.RES ERJ3GEYJ 221 V (220)	B	155.4/102.9
R313	7030003490	S.RES ERJ3GEYJ 272 V (2.7 k)	B	160.4/101.6
R314	7030003510	S.RES ERJ3GEYJ 392 V (3.9 k)	B	160.4/98.9
R315	7030003360	S.RES ERJ3GEYJ 221 V (220)	B	158.2/98.1
R316	7030003280	S.RES ERJ3GEYJ 470 V (47)	B	159.3/85.5
R317	7030006220	S.RES ERJ12YJ470U (47)	B	151.2/100.5
R318	7030003260	S.RES ERJ3GEYJ 330 V (33)	B	144.1/102.1
R341	7030003440	S.RES ERJ3GEYJ 102 V (1 k)	T	144.6/102.6
R342	7030003560	S.RES ERJ3GEYJ 103 V (10 k)	T	152.5/97
R343	7030003440	S.RES ERJ3GEYJ 102 V (1 k)	T	149.9/99.8
R351	7030003200	S.RES ERJ3GEYJ 100 V (10)	B	131.2/101.1
R352	7030003280	S.RES ERJ3GEYJ 470 V (47)	T	128.9/99.8
R353	7030003520	S.RES ERJ3GEYJ 472 V (4.7 k)	T	130.2/99.8
R354	7030003520	S.RES ERJ3GEYJ 472 V (4.7 k)	T	134.3/99.8
R355	7030003520	S.RES ERJ3GEYJ 472 V (4.7 k)	T	131.5/99.8
R356	7030003320	S.RES ERJ3GEYJ 101 V (100)	T	127.6/99.8
R357	7310005390	S.TRI EVM-3V5X50 BQ3 (472)	T	132/104.1
R358	7030003280	S.RES ERJ3GEYJ 470 V (47)	T	128.2/105.7
R359	7030003320	S.RES ERJ3GEYJ 101 V (100)	T	125.6/105.7
R360	7030003320	S.RES ERJ3GEYJ 10		

[PLL UNIT]

REF NO.	ORDER NO.	DESCRIPTION	M.	H/V LOCATION
R544	7030003680	S.RES ERJ3GEYJ 104 V (100 k)	T	41.3/71.2
R545	7030003680	S.RES ERJ3GEYJ 104 V (100 k)	T	41.3/69.9
R546	7030003400	S.RES ERJ3GEYJ 471 V (470)	T	38.4/79.4
R548	7030009591	S.RES ERA3YED 472V (4.7 k)	T	56.6/64.4
R550	7030009691	S.RES ERA3YED 101V (100)	T	55.3/64.4
R554	7030009891	S.RES ERA3YED 151V (150)	T	52.5/65.1
R555	7030003380	S.RES ERJ3GEYJ 331 V (330)	T	60.1/75
R556	7030006561	S.RES ERA3YED 223V (22 k)	T	49.8/62.3
R561	7030003200	S.RES ERJ3GEYJ 100 V (10)	T	43.5/78.5
R562	7030003360	S.RES ERJ3GEYJ 221 V (220)	B	45.5/81.5
R563	7030003490	S.RES ERJ3GEYJ 272 V (2.7 k)	T	41.5/80.5
R564	7030003510	S.RES ERJ3GEYJ 392 V (3.9 k)	T	41.5/79.2
R565	7030003360	S.RES ERJ3GEYJ 221 V (220)	T	39.2/83.6
R570	7030003230	S.RES ERJ3GEYJ 180 V (18)	T	45.6/81.8
R571	7030003230	S.RES ERJ3GEYJ 180 V (18)	T	46.4/79.9
R572	7030003290	S.RES ERJ3GEYJ 560 V (56)	T	48.2/79.2
R573	7030003260	S.RES ERJ3GEYJ 330 V (33)	T	48.2/81.8
R574	7030003300	S.RES ERJ3GEYJ 680 V (68)	T	50.1/79.9
R575	7030003220	S.RES ERJ3GEYJ 150 V (15)	T	50.1/82.5
R580	7030003380	S.RES ERJ3GEYJ 331 V (330)	T	38.9/53.3
R581	7030003360	S.RES ERJ3GEYJ 221 V (220)	T	47.1/53.3
R582	7030003600	S.RES ERJ3GEYJ 223 V (22 k)	T	43.1/53.3
R583	7030000010	S.RES MCR10EZHZ JPW (000)	B	56.1/39.6
R584	7030000010	S.RES MCR10EZHZ JPW (000)	B	56/47.4
R587	7030003370	S.RES ERJ3GEYJ 271 V (270)	B	57/81.8
R588	7030003230	S.RES ERJ3GEYJ 180 V (18)	B	59.6/83.3
R589	7030003370	S.RES ERJ3GEYJ 271 V (270)	B	60.6/88.6
R591	7030003320	S.RES ERJ3GEYJ 101 V (100)	B	70.4/79.7
R592	7030003560	S.RES ERJ3GEYJ 103 V (10 k)	B	61.7/83.4
R593	7030003480	S.RES ERJ3GEYJ 222 V (2.2 k)	B	62.4/88.6
R594	7030003320	S.RES ERJ3GEYJ 101 V (100)	B	69/85.9
R595	7030003640	S.RES ERJ3GEYJ 473 V (47 k)	B	71.9/91.2
R596	7030003540	S.RES ERJ3GEYJ 682 V (6.8 k)	B	72.8/94
R603	7030003480	S.RES ERJ3GEYJ 222 V (2.2 k)	T	101.6/49.5
R604	7030003440	S.RES ERJ3GEYJ 102 V (1 k)	T	94.9/50.6
R605	7030003320	S.RES ERJ3GEYJ 101 V (100)	B	103.5/47.3
R651	7030003440	S.RES ERJ3GEYJ 102 V (1 k)	B	12.5/81.9
R652	7030003360	S.RES ERJ3GEYJ 221 V (220)	B	12.9/58.3
R653	7030003440	S.RES ERJ3GEYJ 102 V (1 k)	B	14.7/58.3
R654	7030003440	S.RES ERJ3GEYJ 102 V (1 k)	B	16.5/58.3
R655	7030007220	S.RES ERA3YED 202V (2 k)	T	30.1/58.6
R656	7030003800	S.RES ERJ3GEYJ 105 V (1 M)	T	12.5/58.8
R657	7030003400	S.RES ERJ3GEYJ 471 V (470)	T	17.5/58.1
R658	7030007220	S.RES ERA3YED 202V (2 k)	T	27.5/58.6
R659	7030007220	S.RES ERA3YED 202V (2 k)	T	27.5/59.9
R660	7030007230	S.RES ERA3YED 102V (1 k)	T	30.1/59.9
R661	7030007220	S.RES ERA3YED 202V (2 k)	T	27.5/61.2
R662	7030007230	S.RES ERA3YED 102V (1 k)	T	30.1/61.2
R663	7030007220	S.RES ERA3YED 202V (2 k)	T	27.5/62.5
R664	7030007230	S.RES ERA3YED 102V (1 k)	T	30.1/62.5
R665	7030007220	S.RES ERA3YED 202V (2 k)	T	27.5/63.8
R666	7030007230	S.RES ERA3YED 102V (1 k)	T	30.1/63.8
R667	7030007220	S.RES ERA3YED 202V (2 k)	T	27.5/65.1
R668	7030007230	S.RES ERA3YED 102V (1 k)	T	30.1/65.1
R669	7030007220	S.RES ERA3YED 202V (2 k)	T	27.5/66.4
R670	7030007230	S.RES ERA3YED 102V (1 k)	T	30.1/66.4
R671	7030007200	S.RES ERA3YED 202V (2 k)	T	27.5/67.7
R672	7030007210	S.RES ERA3YEB 102V (1 k)	T	30.1/67.7
R673	7030007200	S.RES ERA3YEB 202V (2 k)	T	27.5/70.3
R674	7030007210	S.RES ERA3YEB 102V (1 k)	T	30.1/70.3
R675	7030007200	S.RES ERA3YEB 202V (2 k)	T	27.5/71.6
R676	7030007210	S.RES ERA3YEB 102V (1 k)	T	30.1/71.6
R677	7030007200	S.RES ERA3YEB 202V (2 k)	T	27.5/72.9
R678	7030007210	S.RES ERA3YEB 102V (1 k)	T	30.1/72.9
R679	7030007200	S.RES ERA3YEB 202V (2 k)	T	27.5/74.2
R680	7030007210	S.RES ERA3YEB 102V (1 k)	T	30.1/74.2
R682	7030003860	S.RES ERJ3GE JPW V	B	74/100.9
R685	7030003460	S.RES ERJ3GEYJ 152 V (1.5 k)	T	16.1/85.4
R686	7030003320	S.RES ERJ3GEYJ 101 V (100)	T	4.5/83.5
R687	7030003470	S.RES ERJ3GEYJ 182 V (1.8 k)	T	8.7/83.5
R688	7030003480	S.RES ERJ3GEYJ 222 V (2.2 k)	T	11.3/84.8
R689	7030003360	S.RES ERJ3GEYJ 221 V (220)	T	11.3/86.1
R690	7030003370	S.RES ERJ3GEYJ 271 V (270)	T	2.6/91.7
R691	7030003230	S.RES ERJ3GEYJ 180 V (18)	T	4.5/92.4
R692	7030003370	S.RES ERJ3GEYJ 271 V (270)	T	2.6/93.2
R693	7030003500	S.RES ERJ3GEYJ 332 V (3.3 k)	T	15.4/83.5
R704	7030003260	S.RES ERJ3GEYJ 330 V (33)	T	72.7/37.3
R705	7030003600	S.RES ERJ3GEYJ 223 V (22 k)	B	78/36.3
R706	7030003560	S.RES ERJ3GEYJ 103 V (10 k)	B	78/32.7
R707	7030003400	S.RES ERJ3GEYJ 471 V (470)	B	78/41.1
R708	7030003410	S.RES ERJ3GEYJ 561 V (560)	T	82.4/47.6
R709	7030007860	S.RES ERJ3GEYJ 8R2V (8.2)	T	83.2/49.6
R710	7030003410	S.RES ERJ3GEYJ 561 V (560)	T	83.2/45.5
R711	7030003400	S.RES ERJ3GEYJ 471 V (470)	T	38.9/50.1
R712	7030000010	S.RES MCR10EZHZ JPW (000)	T	73.3/52.1
R802	7030003400	S.RES ERJ3GEYJ 471 V (470)	T	59.6/87.3
R803	7030003560	S.RES ERJ3GEYJ 103 V (10 k)	T	59.6/88.6
R804	7030003320	S.RES ERJ3GEYJ 101 V (100)	B	58.7/90.5
R805	7030003370	S.RES ERJ3GEYJ 271 V (270)	B	50.6/91
R806	7030003230	S.RES ERJ3GEYJ 180 V (18)	B	48/91.7
R807	7030003370	S.RES ERJ3GEYJ 271 V (270)	B	44.8/91.7
R812	7030003440	S.RES ERJ3GEYJ 102 V (1 k)	T	14.1/93.6
R814	7030003560	S.RES ERJ3GEYJ 103 V (10 k)	T	16.4/92.9
R815	7030003320	S.RES ERJ3GEYJ 101 V (100)	B	23.3/90.6
R831	7030003320	S.RES ERJ3GEYJ 101 V (100)	B	37.2/103.9
R832	7030003300	S.RES ERJ3GEYJ 680 V (68)	B	38.3/101.3
R833	7030003320	S.RES ERJ3GEYJ 101 V (100)	B	39/103.9
R834	7030003380	S.RES ERJ3GEYJ 331 V (330)	T	22.7/99.8
R835	7030003320	S.RES ERJ3GEYJ 101 V (100)	T	22.7/97
R836	7030003320	S.RES ERJ3GEYJ 101 V (100)	B	15.3/99.8
R837	7030003320	S.RES ERJ3GEYJ 101 V (100)	B	13.4/100.6
R838	7030003320	S.RES ERJ3GEYJ 101 V (100)	B	12.6/98.7
R839	7030003560	S.RES ERJ3GEYJ 103 V (10 k)	T	52.3/102.7
R840	7030003540	S.RES ERJ3GEYJ 682 V (6.8 k)	B	51.7/103.4

[PLL UNIT]

REF NO.	ORDER NO.	DESCRIPTION	M.	H/V LOCATION
R1601	7030003370	S.RES ERJ3GEYJ 271 V (270)	B	81.5/55.3
R1602	7030003470	S.RES ERJ3GEYJ 182 V (1.8 k)	T	82.6/56.4
R1606	7030003360	S.RES ERJ3GEYJ 221 V (220)	T	82.6/53.6
R1607	7030003480	S.RES ERJ3GEYJ 222 V (2.2 k)	T	85.2/56.4
R1608	7030003440	S.RES ERJ3GEYJ 102 V (1 k)	T	78.5/54.6
R1651	7030003400	S.RES ERJ3GEYJ 471 V (470)	T	30.2/30.5
R1652	7030003800	S.RES ERJ3GEYJ 105 V (1 M)	T	28.3/26.6
R1653	7030003360	S.RES ERJ3GEYJ 221 V (220)	B	28.9/23.6
R1654	7030003440	S.RES ERJ3GEYJ 102 V (1 k)	B	28.9/25.2
R1655	7030003440	S.RES ERJ3GEYJ 102 V (1 k)	B	28.9/26.8
R1656	7030007220	S.RES ERA3YED 202V (2 k)	T	30.5/40.4
R1657	7030007220	S.RES ERA3YED 202V (2 k)	T	30.5/37.8
R1658	7030007220	S.RES ERA3YED 202V (2 k)	T	29.2/37.8
R1659	7030007230	S.RES ERA3YED 102V (1 k)	T	29.2/40.4
R1660	7030007220	S.RES ERA3YED 202V (2 k)	T	27.9/37.8
R1661	7030007230	S.RES ERA3YED 102V (1 k)	T	27.9/40.4
R1662	7030007220	S.RES ERA3YED 202V (2 k)	T	26.6/37.8
R1663	7030007230	S.RES ERA3YED 102V (1 k)	T	26.6/40.4
R1664	7030007220	S.RES ERA3YED 202V (2 k)	T	25.3/37.8
R1665	7030007230	S.RES ERA3YED 102V (1 k)	T	25.3/40.4
R1666	7030007220	S.RES ERA3YED 202V (2 k)	T	24/37.8
R1667	7030007230	S.RES ERA3YED 102V (1 k)	T	24/40.4
R1668	7030007220	S.RES ERA3YED 202V (2 k)	T	22.7/37.8
R1669	7030007230	S.RES ERA3YED 102V (1 k)	T	22.7/40.4
R1670	7030007200	S.RES ERA3YEB 202V (2 k)	T	21.4/37.8
R1671	7030007210	S.RES ERA3YEB 102V (1 k)	T	21.4/40.4
R1672	7030007200	S.RES ERA3YEB 202V (2 k)	T	18.8/37.8
R1673	7030007210	S.RES ERA3YEB 102V (1 k)	T	20.1/40.4
R1674	7030007200	S.RES ERA3YEB 202V (2 k)	T	17.5/37.8
R1675	7030007210	S.RES ERA3YEB 102V (1 k)	T	18.8/40.4
R1676	7030007200	S.RES ERA3YEB 202V (2 k)	T	16.2/37.8
R1677	7030007210	S.RES ERA3YEB 102V (1 k)	T	17.5/40.4
R1678	7030007200	S.RES ERA3YEB 202V (2 k)	T	14.9/37.8
R1679	7030007210	S.RES ERA3YEB 102V (1 k)	T	16.2/40.4
R1680	7030003440	S.RES ERJ3GEYJ 102 V (1 k)	T	5.4/27.9
R1685	7030003460	S.RES ERJ3GEYJ 152 V (1.5 k)	T	20.6/47.8
R1686	7030003320	S.RES ERJ3GEYJ 101 V (100)	T	17.1/48.6
R1687	7030003470	S.RES ERJ3GEYJ 182 V (1.8 k)	T	17.8/51.5
R1688	7030003480	S.RES ERJ3GEYJ 222 V (2.2 k)	T	19.1/50.4
R1689	7030003360	S.RES ERJ3GEYJ 221 V (220)	T	15/46.8
R1690	7030003370	S.RES ERJ3GEYJ 271 V (270)	T	13.5/46.8
R1691	7030003230	S.RES ERJ3GEYJ 180 V (18)	T	12.8/49.9
R1692	7030003370	S.RES ERJ3GEYJ 271 V (270)	T	12/48.1
R1693	7030003360	S.RES ERJ3GEYJ 221 V (220)	T	20.6/50.4
R1694	7030003360	S.RES ERJ3GEYJ 221 V (220)	T	29/23.4
R1703	7030003440	S.RES ERJ3GEYJ 102 V (1 k)	B	30.9/18.6
R1705	7030003860	S.RES ERJ3GE JPW V	T	28.1/19.2
R1706	7030003860	S.RES ERJ3GE JPW V	T	6.1/17.4
R1707	7030003860	S.RES ERJ3GE JPW V	T	6.1/18.7
R1708	7030003360	S.RES ERJ3GEYJ 221 V (220)	B	12.1/11.8
C2	4030006880	S.CER C1608 JB 1H 472K-T	T	148.9/23.7
C3	4030011600	S.CER C1608 JB 1E 104K-T	B	153.2/23.9
C14	4030006880	S.CER C1608 JB 1H 472K-T	T	164/43.9
C15	4030006880	S.CER C1608 JB 1H 472K-T	T	172.3/26
C16	4030006880	S.CER C1608 JB 1H 472K-T	T	172.3/28
C17	4030006880	S.CER C1608 JB 1H 472K-T	T	172.3/16.8
C18	4030006880	S.CER C1608 JB 1H 472K-T	T	172.3/18.1
C19	4030006880	S.CER C1608 JB 1H 472K-T	T	173.6/39
C20	4030006880	S.CER C1608 JB 1H 472K-T	T	72.8/106.7
C21	4030006880	S.CER C1608 JB 1H 472K-T	T	74.1/106.7
C22	4030006880	S.CER C1608 JB 1H 472K-T	T	75.4/106.7
C30	4030011600	S.CER C1608 JB 1E 104K-T	B	74.7/26.1
C31	4030011600	S.CER C1608 JB 1E 104K-T	B	74.7/29.7
C32	4030011600	S.CER C1608 JB 1E 104K-T	B	78/34.5
C51	4510008520	S.ELE EEE1CA470SP	T	170.5/101.2
C52	4030011600	S.CER C1608 JB 1E 104K-T	T	165.9/99.2
C53	4030011600	S.CER C1608 JB 1E 104K-T	T	163.3/99.2
C54	4510008500	S.ELE EEE1CA101WP	T	162.5/103.9
C61	4510008520	S.ELE EEE1CA470SP	T	164.1/62
C62	4030011600	S.CER C1608 JB 1E 104K-T	B	167.2/64.3
C63	4030011600	S.CER C1608 JB 1E 104K-T	B	169.8/64.3
C64	4510008500	S.ELE EEE1CA101WP	T	171.2/62
C101	4030006880	S.CER C1608 JB 1H 472K-T	T	92.3/33.4
C102	4030006880	S.CER C1608 JB 1H 472K-T	T	91.5/25.8
C103	4030007110	S.CER C1608 CH 1H 680J-T	T	92.3/33.4
C104	4030007070	S.CER C1608 CH 1H 330J-T	T	94.3/24.5
C105	4030006880	S.CER C1608 JB 1H 47		

[PLL UNIT]

REF NO.	ORDER NO.	DESCRIPTION	M.	H/V LOCATION
C202	4510009280	S.ELE EEE1EA4R7SR	T	144.3/35.3
C203	4030006900	S.CER C1608 JB 1H 103K-T	T	150/41.3
C204	4030006880	S.CER C1608 JB 1H 472K-T	T	153/34.2
C205	4030006880	S.CER C1608 JB 1H 472K-T	T	154.3/34.2
C206	4030006880	S.CER C1608 JB 1H 472K-T	T	145.3/39.9
C207	4030007030	S.CER C1608 CH 1H 150J-T	B	155.9/56.4
C208	4030007030	S.CER C1608 CH 1H 150J-T	T	147.3/41.3
C209	4030011340	S.CER C1608 CH 1H 471J-T	T	157.2/57
C210	4550000510	S.TAN TEESVA 1V 473M8R	T	159/58.8
C211	4550002960	S.TAN TEESVA 1C 155M8R	B	146.7/55.4
C212	4030011810	S.CER C1608 JB 1A 224K-T	T	154.3/36.2
C219	4550000510	S.TAN TEESVA 1V 473M8R	T	150/44.3
C220	4030007130	S.CER C1608 CH 1H 101J-T	T	147.1/65.2
C221	4030009520	S.CER C1608 CH 1H 020B-T	T	152.7/65.2
C222	4610001830	S.TRI TZB4S100AB10R00	T	152.1/78.6
C223	4030007080	S.CER C1608 CH 1H 390J-T	T	148.4/83.7
C224	4030009920	S.CER C1608 CH 1H 050B-T	T	145.8/83.7
C225	4030007020	S.CER C1608 CH 1H 120J-T	T	153.8/84.1
C226	4030006880	S.CER C1608 JB 1H 472K-T	T	153.8/81.5
C227	4030009920	S.CER C1608 CH 1H 050B-T	T	152.1/85.6
C228	4550006250	S.TAN TEESVA 1A 106M8R	T	146.9/79.3
C229	4030006990	S.CER C1608 CH 1H 080D-T	T	152.1/88.3
C230	4030007070	S.CER C1608 CH 1H 330J-T	T	134.7/65.2
C232	4610001830	S.TRI TZB4S100AB10R00	T	139.6/78.6
C233	4030007070	S.CER C1608 CH 1H 330J-T	T	135.9/83.7
C234	4030009920	S.CER C1608 CH 1H 050B-T	T	133.3/83.7
C235	4030009920	S.CER C1608 CH 1H 050B-T	T	141.4/84.1
C236	4030006880	S.CER C1608 JB 1H 472K-T	T	141.4/81.5
C237	4030009520	S.CER C1608 CH 1H 020B-T	T	139.7/85.6
C238	4550006250	S.TAN TEESVA 1A 106M8R	T	134.4/79.3
C239	4030009910	S.CER C1608 CH 1H 040B-T	T	139.7/88.3
C240	4030007100	S.CER C1608 CH 1H 560J-T	T	122.2/65.2
C241	4030009520	S.CER C1608 CH 1H 020B-T	T	127.6/65.2
C242	4610001830	S.TRI TZB4S100AB10R00	T	127.1/78.6
C243	4030007070	S.CER C1608 CH 1H 330J-T	T	123.4/83.7
C244	4030009520	S.CER C1608 CH 1H 020B-T	T	120.8/83.7
C245	4030011770	S.CER C1608 CH 1H 060B-T	T	129.9/84.1
C246	4030006880	S.CER C1608 JB 1H 472K-T	T	128.8/81.5
C247	4030007040	S.CER C1608 CH 1H 180J-T	T	127.2/85.6
C248	4550006250	S.TAN TEESVA 1A 106M8R	T	121.8/79.3
C250	4030007100	S.CER C1608 CH 1H 560J-T	T	109.7/65.2
C252	4610001860	S.TRI TZB4Z060AB10R00	T	114.6/78.6
C253	4030007080	S.CER C1608 CH 1H 390J-T	T	110.9/83.7
C254	4030009530	S.CER C1608 CH 1H 030B-T	T	108.3/83.7
C255	4030006980	S.CER C1608 CH 1H 070D-T	T	116.3/84.1
C256	4030006880	S.CER C1608 JB 1H 472K-T	T	116.3/81.5
C257	4030007050	S.CER C1608 CH 1H 220J-T	T	114.7/85.6
C258	4550006250	S.TAN TEESVA 1A 106M8R	T	109.3/79.3
C259	4030006880	S.CER C1608 JB 1H 472K-T	T	160.4/51.7
C260	4030007090	S.CER C1608 CH 1H 470J-T	T	97.2/65.2
C262	4610001860	S.TRI TZB4Z060AB10R00	T	102.1/78.6
C263	4030007080	S.CER C1608 CH 1H 390J-T	T	98.4/83.7
C264	4030009530	S.CER C1608 CH 1H 030B-T	T	95.8/83.7
C265	4030006980	S.CER C1608 CH 1H 070D-T	T	103.8/84.1
C266	4030006880	S.CER C1608 JB 1H 472K-T	T	103.8/81.5
C267	4030007050	S.CER C1608 CH 1H 220J-T	T	102.2/85.6
C268	4550006250	S.TAN TEESVA 1A 106M8R	T	96.8/79.3
C272	4610001860	S.TRI TZB4Z060AB10R00	T	89.6/78.6
C273	4030007050	S.CER C1608 CH 1H 220J-T	T	86.5/83.5
C274	4030009530	S.CER C1608 CH 1H 030B-T	T	83.9/83.5
C275	4030009530	S.CER C1608 CH 1H 030B-T	T	91.9/84.1
C276	4030006880	S.CER C1608 JB 1H 472K-T	T	91.9/81.5
C277	4030007050	S.CER C1608 CH 1H 220J-T	T	89.7/85.6
C278	4550006250	S.TAN TEESVA 1A 106M8R	T	84.3/79.3
C283	4030017810	S.CER C1608 CH 1H 102J-T	T	148.4/92.6
C284	4030006880	S.CER C1608 JB 1H 472K-T	T	150.4/95
C285	4030017810	S.CER C1608 CH 1H 102J-T	T	135.9/92.6
C286	4030006880	S.CER C1608 JB 1H 472K-T	T	137.8/95
C287	4030017810	S.CER C1608 CH 1H 102J-T	T	123.4/92.6
C288	4030006880	S.CER C1608 JB 1H 472K-T	T	127.2/94.4
C289	4030017810	S.CER C1608 CH 1H 102J-T	T	110.9/92.6
C290	4030006880	S.CER C1608 JB 1H 472K-T	T	114.3/94.8
C291	4030017810	S.CER C1608 CH 1H 102J-T	T	98.4/92.6
C292	4030006880	S.CER C1608 JB 1H 472K-T	T	100.3/94.9
C293	4030017810	S.CER C1608 CH 1H 102J-T	T	86.9/92.6
C294	4030006880	S.CER C1608 JB 1H 472K-T	T	90.8/93.7
C296	4030007060	S.CER C1608 CH 1H 270J-T	T	137.7/63.1
C301	4030006880	S.CER C1608 JB 1H 472K-T	T	153.8/99.8
C302	4030006880	S.CER C1608 JB 1H 472K-T	T	156.7/105.4
C303	4030006880	S.CER C1608 JB 1H 472K-T	B	147.2/102.1
C304	4030006880	S.CER C1608 JB 1H 472K-T	B	138.7/101.2
C305	4030006880	S.CER C1608 JB 1H 472K-T	B	134.4/99.6
C306	4030006880	S.CER C1608 JB 1H 472K-T	B	132.6/99.6
C308	4030006880	S.CER C1608 JB 1H 472K-T	T	156.2/99.1
C309	4030017810	S.CER C1608 CH 1H 102J-T	T	142/105.4
C310	4030011600	S.CER C1608 JB 1E 104K-T	T	142.6/103.3
C311	4510008520	S.ELE EEE1CA470SP	T	137.3/103.9
C312	4030006880	S.CER C1608 JB 1H 472K-T	B	155/98.3
C313	4030006880	S.CER C1608 JB 1H 472K-T	B	160.4/104.2
C314	4030006880	S.CER C1608 JB 1H 472K-T	B	161.1/95.7
C331	4030007110	S.CER C1608 CH 1H 680J-T	T	152.5/99.8
C332	4030007160	S.CER C1608 CH 1H 181J-T	T	151.2/102.6
C333	4030007110	S.CER C1608 CH 1H 680J-T	T	151.2/99.8
C334	4030007050	S.CER C1608 CH 1H 220J-T	T	148.7/105.4
C335	4030006980	S.CER C1608 CH 1H 070D-T	T	147.3/105.4
C336	4030007030	S.CER C1608 CH 1H 150J-T	T	146.7/102.6
C337	4030007050	S.CER C1608 CH 1H 220J-T	T	145.9/105.4
C341	4030006880	S.CER C1608 JB 1H 472K-T	T	144.6/105.4
C342	4030006880	S.CER C1608 JB 1H 472K-T	T	151.2/97
C344	4030011600	S.CER C1608 JB 1E 104K-T	T	143.3/105.4
C351	4030017810	S.CER C1608 CH 1H 102J-T	T	123.5/105.4
C352	4030011600	S.CER C1608 JB 1E 104K-T	T	122.2/105.4
C353	4510008520	S.ELE EEE1CA470SP	T	117.6/103.9
C354	4030006880	S.CER C1608 JB 1H 472K-T	T	133/99.8

[PLL UNIT]

REF NO.	ORDER NO.	DESCRIPTION	M.	H/V LOCATION
C355	4030006880	S.CER C1608 JB 1H 472K-T	T	129.5/105.7
C356	4030006880	S.CER C1608 JB 1H 472K-T	T	126.3/99.7
C357	4030006880	S.CER C1608 JB 1H 472K-T	T	126.9/105.7
C358	4030006880	S.CER C1608 JB 1H 472K-T	B	126/100.5
C359	4030006880	S.CER C1608 JB 1H 472K-T	B	122.8/103.1
C360	4030006880	S.CER C1608 JB 1H 472K-T	B	117.1/100.1
C361	4030006880	S.CER C1608 JB 1H 472K-T	T	100.5/100.5
C441	4030007040	S.CER C1608 CH 1H 180J-T	T	113.4/105.4
C442	4030007040	S.CER C1608 CH 1H 180J-T	T	112.1/105.4
C443	4030007020	S.CER C1608 CH 1H 120J-T	T	110.5/102.6
C444	4030007080	S.CER C1608 CH 1H 390J-T	T	110.8/105.4
C445	4030011770	S.CER C1608 CH 1H 060B-T	T	109.5/105.4
C446	4030007060	S.CER C1608 CH 1H 270J-T	T	105.6/105.4
C447	4030007110	S.CER C1608 CH 1H 680J-T	T	105.8/103.3
C448	4030006880	S.CER C1608 JB 1H 472K-T	T	108.2/105.4
C449	4030006880	S.CER C1608 JB 1H 472K-T	T	115.6/98.6
C451	4030007110	S.CER C1608 CH 1H 680J-T	T	102.6/102.5
C452	4030007160	S.CER C1608 CH 1H 181J-T	T	103.9/102.5
C453	4030011600	S.CER C1608 JB 1E 104K-T	T	106.9/105.4
C501	4030006880	S.CER C1608 JB 1H 472K-T	T	61.4/50.3
C502	4030011600	S.CER C1608 JB 1E 104K-T	T	62.7/50.3
C503	4510008540	S.ELE EEE1CA100SR	T	65.9/48
C504	4030011600	S.CER C1608 JB 1E 104K-T	T	44/32.9
C505	4550007470	S.TAN F931A107MNM8MA	B	46/31
C506	4030011600	S.CER C1608 JB 1E 104K-T	T	46.8/32.9
C507	4030011600	S.CER C1608 JB 1E 104K-T	T	55.5/32.8
C509	4030011600	S.CER C1608 JB 1E 104K-T	T	60/37.2
C510	4030011600	S.CER C1608 JB 1E 104K-T	T	60/39.8
C511	4030011600	S.CER C1608 JB 1E 104K-T	T	60/43.6
C512	4030011600	S.CER C1608 JB 1E 104K-T	T	60/46.2
C513	4030011600	S.CER C1608 JB 1E 104K-T	T	60/48.8
C514	4030011600	S.CER C1608 JB 1E 104K-T	T	56.6/52.6
C515	4030011600	S.CER C1608 JB 1E 104K-T	T	52.9/52.7
C516	4030011600	S.CER C1608 JB 1E 104K-T	T	50.3/52.7
C517	4030011600	S.CER C1608 JB 1E 104K-T	T	40.8/49
C518	4030011600	S.CER C1608 JB 1E 104K-T	T	40.8/46.2
C519	4030011600	S.CER C1608 JB 1E 104K-T	T	40.8/42.6
C520	4030011600	S.CER C1608 JB 1E 104K-T	T	42/35.2
C521	4030011600	S.CER C1608 JB 1E 104K-T	T	58.6/53
C522	4550007220	S.TAN F931A476MCM8MA	B	47.6/52
C525	4030006880	S.CER C1608 JB 1H 472K-T	T	38.1/46.8
C526	4030011600	S.CER C1608 JB 1E 104K-T	T	38.1/48.1
C532	4030007070	S.CER C1608 CH 1H 330J-T	T	55.1/28.6
C533	4030007110	S.CER C1608 CH 1H 680J-T	T	59.2/28.7
C534	4030007110	S.CER C1608 CH 1H 680J-T	T	62.5/28.2
C535	4030007070	S.CER C1608 CH 1H 330J-T	T	64.8/29.5
C540	4030006880	S.CER C1608 JB 1H 472K-T	T	57.8/73.8
C541	4510008540	S.ELE EEE1CA100SR	T	58.7/69.5
C542	4340000260	S.MLR ECU1C104MA5	T	48.2/62
C543	4030007060	S.CER C1608 CH 1H 270J-T	T	42.2/63.1
C545	4030008560	S.CER C1608 CH 1H 300J-T	T	40/63.8
C546	4610001830	S.TRI TZB4S100AB10R00	T	40.2/66.8
C547	4030007130	S.CER C1608 CH 1H 101J-T	T	43.5/69.1
C548	4030007010	S.CER C1608 CH 1H 100D-T	T	43.5/73.3
C549	4030007050	S.CER C1608 CH 1H 220J-T	T	38.8/73.8
C550	4030006880	S.CER C1608 JB 1H 472K-T	T	38.4/70.5
C551	4030009520	S.CER C1608 CH 1H 020B-T	T	43.5/75.9
C552	4030017810	S.CER C1608 CH 1H 102J-T	T	60.1/76.8
C553	4030006880	S.CER C1608 JB 1H 472K-T	T	52.6/80.6
C554	4510008500	S.ELE EEE1CA101WP	T	57.5/81.2
C555	4030006880	S.CER C1608 JB 1H 472K-T	B	62.6/76.2
C556	4550007220	S.TAN F931A476MCM8MA	B	39.8/66.4
C558	4550007520	S.TAN F931A106MA8BMA	T	53.6/62
C559	4550007400	S.TAN F931A225MA8BMA	T	51.5/62
C561	4550007520	S.TAN F931A106MA8BMA	B	41.4/79.9
C562	4030006880	S.CER C1608 JB 1H 472K-T	B	43.1/80.7
C563	4030017810	S.CER C1608 CH 1H 102J-T	B	75.3/94.8
C564	4030006880	S.CER C1608 JB 1H 472K-T	B	75.3/96.3
C565	4510008520	S.ELE EEE1CA470SP	T	75/89
C566	4030006880	S.CER C1608 JB 1H 472K-T	T	44.1/83.1
C571	4030006880	S.CER C1608 JB 1H 472K-T	B	60.7/85.9
C573	4030007040			

[PLL UNIT]

REF NO.	ORDER NO.	DESCRIPTION	M.	H/V LOCATION
C671	4030011600	S.CER C1608 JB 1E 104K-T	T	14.5/80.9
C672	4030011600	S.CER C1608 JB 1E 104K-T	T	18.4/80.9
C680	4030006880	S.CER C1608 JB 1H 472K-T	T	30.1/75.5
C681	4030011340	S.CER C1608 CH 1H 471J-T	T	27.5/76.6
C682	4030007120	S.CER C1608 CH 1H 820J-T	T	28.1/78.8
C683	4030017870	S.CER C1608 CH 1H 681J-T	T	26.8/78.8
C684	4030007070	S.CER C1608 CH 1H 330J-T	T	30.1/83.6
C685	4030017800	S.CER C1608 CH 1H 561J-T	T	27.5/83.6
C686	4030011280	S.CER C1608 CH 1H 271J-T	T	23.2/83.5
C687	4030017810	S.CER C1608 CH 1H 102J-T	T	21.3/84.3
C688	4030011280	S.CER C1608 CH 1H 271J-T	T	18.9/83.5
C689	4030011600	S.CER C1608 JB 1E 104K-T	T	12.8/83.5
C690	4030011600	S.CER C1608 JB 1E 104K-T	T	6.4/84.3
C691	4030011600	S.CER C1608 JB 1E 104K-T	T	6.2/90.8
C692	4030006880	S.CER C1608 JB 1H 472K-T	T	4.5/85.1
C693	4030006880	S.CER C1608 JB 1H 472K-T	B	72.2/104.2
C694	4030006880	S.CER C1608 JB 1H 472K-T	B	74/104.2
C703	4030017810	S.CER C1608 CH 1H 102J-T	T	72.4/35.2
C704	4030006880	S.CER C1608 JB 1H 472K-T	T	72.4/33.9
C705	4510008500	S.ELE EEE1CA101WP	T	79.3/29.7
C707	4030011600	S.CER C1608 JB 1E 104K-T	B	74.7/36.3
C708	4030011600	S.CER C1608 JB 1E 104K-T	B	75.4/40.7
C709	4030007070	S.CER C1608 CH 1H 330J-T	T	77.2/42.4
C710	4030006880	S.CER C1608 JB 1H 472K-T	T	75.2/43.2
C711	4030009540	S.CER C1608 CH 1H 1R5B-T	T	79.3/43.2
C712	4030007070	S.CER C1608 CH 1H 330J-T	T	77.2/43.9
C713	4030006880	S.CER C1608 JB 1H 472K-T	T	81.7/50.9
C801	4030006880	S.CER C1608 JB 1H 472K-T	T	62.4/87.3
C802	4030007030	S.CER C1608 CH 1H 150J-T	T	58.9/92
C803	4030006900	S.CER C1608 JB 1H 103K-T	T	59.6/89.9
C811	4030011600	S.CER C1608 JB 1E 104K-T	T	9.8/90.8
C812	4030011600	S.CER C1608 JB 1E 104K-T	T	19.4/90.6
C813	4030017800	S.CER C1608 CH 1H 561J-T	T	25.4/93.6
C831	4030009910	S.CER C1608 CH 1H 040B-T	T	30.4/106.8
C832	4030009510	S.CER C1608 CH 1H 010B-T	T	26.5/98.1
C834	4030007030	S.CER C1608 CH 1H 150J-T	T	21.4/99.8
C835	4030006900	S.CER C1608 JB 1H 103K-T	T	21.4/97
C836	4510008540	S.ELE EEE1CA100SR	T	59.5/97.3
C837	4030006880	S.CER C1608 JB 1H 472K-T	T	57.6/100.3
C838	4030007020	S.CER C1608 CH 1H 120J-T	T	30.4/100.9
C1601	4030006880	S.CER C1608 JB 1H 472K-T	T	83.9/56.4
C1602	4030006880	S.CER C1608 JB 1H 472K-T	B	84.1/56.1
C1607	4030006880	S.CER C1608 JB 1H 472K-T	T	80.6/54
C1608	4030006880	S.CER C1608 JB 1H 472K-T	T	78.8/57.4
C1609	4030007100	S.CER C1608 CH 1H 560J-T	T	77.2/54.6
C1610	4030008750	S.CER C1608 CH 1H 360J-T	T	78.8/60.2
C1611	4030007140	S.CER C1608 CH 1H 121J-T	T	76.8/60.2
C1612	4030007020	S.CER C1608 CH 1H 120J-T	T	76.8/61.5
C1613	4030007110	S.CER C1608 CH 1H 680J-T	T	74.7/62.3
C1651	4030006880	S.CER C1608 JB 1H 472K-T	T	30.2/29
C1652	4030011600	S.CER C1608 JB 1E 104K-T	T	31/24.2
C1653	4030006880	S.CER C1608 JB 1H 472K-T	B	26.3/12.3
C1654	4030011600	S.CER C1608 JB 1E 104K-T	B	24.5/12.3
C1655	4030011600	S.CER C1608 JB 1E 104K-T	T	26.6/17.2
C1656	4030011600	S.CER C1608 JB 1E 104K-T	T	26.6/20.2
C1658	4510008540	S.ELE EEE1CA100SR	T	29.2/14.2
C1659	4030011600	S.CER C1608 JB 1E 104K-T	T	26.6/22.8
C1660	4030011600	S.CER C1608 JB 1E 104K-T	T	26.6/28.1
C1661	4030011600	S.CER C1608 JB 1E 104K-T	T	22.8/32.7
C1662	4550007470	S.TAN F931A107MNBMA	B	19/33
C1663	4550007220	S.TAN F931A476MCBMA	B	15.2/14.6
C1664	4030011600	S.CER C1608 JB 1E 104K-T	T	20.1/12.9
C1665	4030011600	S.CER C1608 JB 1E 104K-T	T	14.5/12.9
C1666	4030011600	S.CER C1608 JB 1E 104K-T	T	12.7/33.5
C1667	4030011600	S.CER C1608 JB 1E 104K-T	T	11.5/12.9
C1668	4030011600	S.CER C1608 JB 1E 104K-T	T	10/32.7
C1669	4030011600	S.CER C1608 JB 1E 104K-T	T	6.4/15.9
C1670	4030011600	S.CER C1608 JB 1E 104K-T	T	6.1/20.2
C1671	4030011600	S.CER C1608 JB 1E 104K-T	T	6.8/22
C1672	4030011600	S.CER C1608 JB 1E 104K-T	T	6.8/24.6
C1673	4030011600	S.CER C1608 JB 1E 104K-T	T	6.8/28.6
C1680	4030006880	S.CER C1608 JB 1H 472K-T	T	14.9/40.4
C1681	4030007160	S.CER C1608 CH 1H 181J-T	T	13.6/37.8
C1682	4030007140	S.CER C1608 CH 1H 121J-T	T	11.5/38.4
C1683	4030011330	S.CER C1608 CH 1H 391J-T	T	11.5/37.1
C1684	4030007080	S.CER C1608 CH 1H 390J-T	T	6.4/40.5
C1685	4030011280	S.CER C1608 CH 1H 271J-T	T	6.4/37.9
C1686	4030010760	S.CER C1608 CH 1H 331J-T	B	19.4/47
C1687	4030018580	S.CER C1608 CH 1H 821J-T	B	23.7/46.3
C1688	4030010760	S.CER C1608 CH 1H 331J-T	B	21.9/47.8
C1689	4030011600	S.CER C1608 JB 1E 104K-T	T	19.9/52.2
C1690	4030011600	S.CER C1608 JB 1E 104K-T	T	17.8/46.8
C1691	4030011600	S.CER C1608 JB 1E 104K-T	T	14.3/48.6
C1692	4030006880	S.CER C1608 JB 1H 472K-T	T	16.3/46.8
C1701	4030006880	S.CER C1608 JB 1H 472K-T	B	20.2/25.9
C1702	4030006880	S.CER C1608 JB 1H 472K-T	B	18.4/25.9
C1703	4030006880	S.CER C1608 JB 1H 472K-T	B	16.6/25.9
C1704	4030006880	S.CER C1608 JB 1H 472K-T	B	15.4/23.7
C1705	4030006880	S.CER C1608 JB 1H 472K-T	B	15.4/21.9
C1706	4030006880	S.CER C1608 JB 1H 472K-T	B	15.4/20.1
C1707	4030006880	S.CER C1608 JB 1H 472K-T	B	15.4/18.3
C1709	4030006880	S.CER C1608 JB 1H 472K-T	B	9.9/18.3
C1710	4030006880	S.CER C1608 JB 1H 472K-T	B	29.1/18.6
C1711	4030011600	S.CER C1608 JB 1E 104K-T	T	30.1/18
C1751	4030006880	S.CER C1608 JB 1H 472K-T	T	70/16.9
C1752	4030006880	S.CER C1608 JB 1H 472K-T	T	70/15.6
C1753	4030006880	S.CER C1608 JB 1H 472K-T	T	70/14.3
C1754	4030006880	S.CER C1608 JB 1H 472K-T	T	70/13
C1755	4030006880	S.CER C1608 JB 1H 472K-T	T	70/11.7
C1756	4030006880	S.CER C1608 JB 1H 472K-T	T	71.2/10.4
C1757	4030006880	S.CER C1608 JB 1H 472K-T	T	72/9.1
J31	6510007020	CNR TMP-J01X-V6		

[PLL UNIT]

REF NO.	ORDER NO.	DESCRIPTION	M.	H/V LOCATION
J351	6510007020	CNR TMP-J01X-V6		
J561	6510007020	CNR TMP-J01X-V6		
J601	6510007020	CNR TMP-J01X-V6		
J681	6510007020	CNR TMP-J01X-V6		
J831	6510007020	CNR TMP-J01X-V6		
J1601	6510007020	CNR TMP-J01X-V6		
J1681	6510007020	CNR TMP-J01X-V6		
J2018	6510019981	S.CNR 52808-1671 (1690)	T	167.7/22.5
J2019	6510018971	S.CNR B4B-PH-SM4-TB (LF) (SN)	T	167.7/40.8
EP10	6910014690	S.BEA MPZ1608S221A-T	T	173.8/45.7
EP11	6910014690	S.BEA MPZ1608S221A-T	T	160/14.2
EP12	6910014690	S.BEA MPZ1608S221A-T	T	160/15.5
EP13	6910014690	S.BEA MPZ1608S221A-T	T	163.2/39.8
EP20	6910012350	S.BEA MMZ1608Y 102BT	T	78.8/104.9
EP21	6910012350	S.BEA MMZ1608Y 102BT	T	78.8/106.2
EP22	6910012350	S.BEA MMZ1608Y 102BT	T	78.8/107.5
EP101	6910012350	S.BEA MMZ1608Y 102BT	B	94.7/35
EP102	6910012350	S.BEA MMZ1608Y 102BT	B	96.6/35
EP1701	6910012350	S.BEA MMZ1608Y 102BT	T	43.2/18.4
EP1702	6910012350	S.BEA MMZ1608Y 102BT	T	43.2/17
EP1703	6910012350	S.BEA MMZ1608Y 102BT	T	43.2/15.6
EP1704	6910012350	S.BEA MMZ1608Y 102BT	T	43.2/14.2
EP1705	6910012350	S.BEA MMZ1608Y 102BT	T	43.2/12.5
EP1706	6910012350	S.BEA MMZ1608Y 102BT	T	43.2/11.4
EP1707	6910012350	S.BEA MMZ1608Y 102BT	T	43.2/10
EP1708	6910012350	S.BEA MMZ1608Y 102BT	T	43.2/19.8
EP1709	6910012350	S.BEA MMZ1608Y 102BT	T	43.2/8.6

M.=Mounted side (T: Mounted on the Top side B: Mounted on the Bottom side)
S.=Surface mount

[SCOPE UNIT]

REF NO.	ORDER NO.	DESCRIPTION	M.	H/V LOCATION
IC2	1180001771	S.IC TA79L05F (TE12L,F)	T	52.1/75.5
IC31	1110006180	S.IC UPG2009TB-E3	T	20.7/72.8
IC201	1180003110	S.REG TLV1117CDCYR	T	155.7/69.2
IC401	1110006131	S.IC uPC4094G2-E1-A	T	41.6/68.1
IC403	1110006131	S.IC uPC4094G2-E1-A	T	54.5/69.7
IC404	1110006131	S.IC uPC4094G2-E1-A	T	71.6/69
IC405	1110002700	S.IC NJM2904M-TE1-#FMZB	T	29.3/11.7
IC501	1190002031	S.IC AD7650ASTZ	T	83.1/60.3
IC502	1130006891	S.IC TC7S04FU (TE85R,F)	T	85.3/69.1
IC505	1180003030	S.REG S-812C25AJA-C2FT2G	T	84.2/77.1
IC601	1140014320	S.IC TMS320C6720BRFP200	T	118.4/57.7
IC602	1130011930	S.IC SN74LVC1G04DCKR	T	96.1/53.5
IC603	1130011930	S.IC SN74LVC1G04DCKR	T	98.6/56.4
IC607	1110006411	S.IC R3111N111A-TR-F	T	104.9/70.3
IC671	1130014240	S.IC AT49BV040B-TU (SX-3009D)	T	140.4/62
IC801	1130013270	S.IC ADF4116BRUZ	T	109.2/15.1
IC803	1130009691	S.IC TC74HCT7007AF (F)	T	166.3/18.2
IC820	1190001961	S.IC AD9857ASTZ	T	138.7/17.1
IC821	1130010461	S.IC TC7SH08FU (TE85L,JF)	T	105.3/60.9
Q1	1530002060	S.TR 2SC4081 T106 R	T	26.9/54.1
Q2	1530003851	S.TR 2SC5551F-TD-E	T	30.9/23.4
Q101	1530003151	S.TR 2SC4673D-TD-E	T	56.7/5.4
Q201	1560000561	S.FET 2SK882-GR (TE85L,F)	T	47.7/29.5
Q202	1560000561	S.FET 2SK882-GR (TE85L,F)	T	45.7/37.2
Q301	1530003151	S.TR 2SC4673D-TD-E	T	65.3/51.5
Q701	1530003221	S.TR 2SC4406-4-TL-E	T	130.9/33.3
Q720	1530003221	S.TR 2SC4406-4-TL-E	T	146.9/27.2
Q810	1530003221	S.TR 2SC4406-4-TL-E	T	116.8/16.3
Q821	1560000331	S.FET 2SK210-GR (TE85R,F)	T	86.9/24.3
Q841	1530002060	S.TR 2SC4081 T106 R	T	85.1/15.8
Q842	1530003431	S.TR 2SC5226-4-TL-E	T	72.8/15.5
Q843	1530003431	S.TR 2SC5226-4-TL-E	T	71.2/21.9
Q872	1590000680	S.TR DTC114EUA T106	T	70.5/12.4
D1	1750000971	S.DIO CPH5513-TL-E	T	19.9/66.1
D2	1750000971	S.DIO CPH5513-TL-E	T	17.3/59.2
D3	1750000441	S.DIO 1SV263-TL-E	T	20.4/58.8
D4	1750000431	S.DIO HSB88WSTR-E	T	54.2/51.8
D101	1750000431	S.DIO HSB88WSTR-E	T	51.1/19.3
D821	1750000681	S.VCP 1SV232 (TPH2,F)	T	101.5/21.8
D822	1750000681	S.VCP 1SV232 (TPH2,F)	T	101.5/23.5
FI201	2030000290	S.MLH FL-357 (45 MHz)	T	53.1/33
FI501	2040000790	S.LC EXCCET103U	T	97.2/49.4
L1	6200001831	S.COL NLV32T-100J	T	20.4/62.9
L2	6200001831	S.COL NLV32T-100J	T	14.1/61.8
L3	6200001831	S.COL NLV32T-100J	T	10.8/60.2
L4	6200001831	S.COL NLV32T-100J	T	21.1/54
L5	6150004280	COL LS-484B (C-14927)		
L6	6150004280	COL LS-484B (C-14927)		
L7	6200003261	S.COL NLV32T-101J	T	36.4/32.8
L8	6140003790	COL LR-442		
L9	6200001831	S.COL NLV32T-100J	T	25.9/30.5
L10	6200001831	S.COL NLV32T-100J	T	34.9/17.3
L11	6200001831	S.COL NLV32T-100J	T	29.6/45.9
L12	6200010450	S.COL C2520C-R82G-A (0.82U)	T	17.7/44.3
L13	6200010940	S.COL C2520C-39NG-A	T	13.2/55
L14	6200010860	S.COL C2520C-R10G-A (0.1U)	T	14/50.8
L51	6200001831	S.COL NLV32T-100J	T	143/32.4
L52	6200001831	S.COL NLV32T-100J	T	174.5/43.3
L53	6200001831	S.COL NLV32T-100J	T	74.5/44.9
L54	6200001831	S.COL NLV32T-100J	T	78/44.9
L101	6140003530	COL LR-395		
L102	6140003530	COL LR-395		
L103	6200003021	S.COL NLV32T-R33J	T	50.8/6.9
L104	6200001920	S.COL ELJNC R15K-F	T	51.1/10.6
L201	6150004250	COL LS-471A (C-14922)		
L202	6150004280	COL LS-484B (C-14927)		
L203	6150004280	COL LS-484B (C-14927)		
L204	6200001831	S.COL NLV32T-100J	T	38.4/47.7
L205	6200002431	S.COL NLV25T-082J	T	55.4/27.2
L301	6140003530	COL LR-395		
L302	6140003530	COL LR-395		
L303	6200003041	S.COL NLV32T-R68J	T	64.8/56.2
L304	6200001831	S.COL NLV32T-100J	T	64.8/59.2
L401	6200003171	S.COL NLV32T-330J	T	45/61.5
L501	6200001831	S.COL NLV32T-100J	T	81.3/44.9
L502	6200001831	S.COL NLV32T-100J	T	84.3/48.1
L551	6180003501	S.COL SLF6028T-100M1R3-PF	T	144.3/40.7
L552	6200001831	S.COL NLV32T-100J	T	141.6/45.5
L671	6200001831	S.COL NLV32T-100J	T	145.8/47.5
L701	6200005491	S.COL NLV32T-331J	T	138/34.6
L720	6200011610	S.COL NLC453232T-100K-PF	T	126.7/15.4
L721	6200011610	S.COL NLC453232T-100K-PF	T	153.7/22.4
L722	6200001831	S.COL NLV32T-100J	T	152/25.8
L761	6200003011	S.COL NLV32T-R27J	T	152.4/11.1
L762	6200003021	S.COL NLV32T-R33J	T	155.8/9.6
L763	6200003251	S.COL NLV32T-R39J	T	151.5/5.9
L764	6200003251	S.COL NLV32T-R39J	T	131.5/4.1
L801	6200005491	S.COL NLV32T-331J	T	113.3/19.5
L802	6200005491	S.COL NLV32T-331J	T	169/11.1
L821	6200001831	S.COL NLV32T-100J	T	105.4/24.3
L822	6190001441	COL #E526GN-110504		
L823	6200001851	S.COL NLV32T-5R6J	T	84.4/20.8
L825	6200003261	S.COL NLV32T-101J	T	93.5/31.9
L841	6200003261	S.COL NLV32T-101J	T	81/31.4
L842	6200003031	S.COL NLV32T-R47J	T	68.8/16.8
L851	6200003431	S.COL NLV32T-R10J	T	71/25.7

[SCOPE UNIT]

REF NO.	ORDER NO.	DESCRIPTION	M.	H/V LOCATION
L852	6200001471	S.COL NLV32T-R12J	T	70.6/29.5
R1	7030003360	S.RES ERJ3GEYJ 221 V (220)	T	22.3/65.9
R2	7030003440	S.RES ERJ3GEYJ 222 V (220 k)	T	22.4/57.4
R3	7030003480	S.RES ERJ3GEYJ 102 V (1 k)	T	23.7/57.4
R4	7030003460	S.RES ERJ3GEYJ 152 V (1.5 k)	T	29/54.5
R5	7030003520	S.RES ERJ3GEYJ 472 V (4.7 k)	T	25.6/54
R5	7030003580	S.RES ERJ3GEYJ 153 V (15 k)	T	29.6/54
R6	7030003440	S.RES ERJ3GEYJ 102 V (1 k)	T	28.2/56.1
R7	7030003290	S.RES ERJ3GEYJ 560 V (56)	T	31.2/35.4
R8	7030003440	S.RES ERJ3GEYJ 102 V (1 k)	T	31/19.8
R9	7030003500	S.RES ERJ3GEYJ 332 V (3.3 k)	T	33.4/19.8
R11	7310005400	S.TRI EVM-3VSX50 BE4 (223)	T	29.9/49.6
R12	7030003320	S.RES ERJ3GEYJ 101 V (100)	T	32.4/26.5
R36	7030003520	S.RES ERJ3GEYJ 472 V (4.7 k)	T	18.1/71.7
R38	7030003520	S.RES ERJ3GEYJ 472 V (4.7 k)	T	20.9/68.4
R53	7030003320	S.RES ERJ3GEYJ 101 V (100)	T	163.3/41.8
R60	7030003320	S.RES ERJ3GEYJ 101 V (100)	T	163.3/59.8
R61	7030003320	S.RES ERJ3GEYJ 101 V (100)	T	152.4/60.8
R62	7030003320	S.RES ERJ3GEYJ 101 V (100)	T	152.4/54.8
R63	7030003320	S.RES ERJ3GEYJ 101 V (100)	T	163.3/55.8
R64	7030003320	S.RES ERJ3GEYJ 101 V (100)	T	152.4/56.8
R65	7030003320	S.RES ERJ3GEYJ 101 V (100)	T	163.3/49.8
R66	7030003320	S.RES ERJ3GEYJ 101 V (100)	T	152.4/48.8
R71	7030003320	S.RES ERJ3GEYJ 101 V (100)	T	152.4/42.8
R72	7030003320	S.RES ERJ3GEYJ 101 V (100)	T	163.3/53.8
R73	7030003320	S.RES ERJ3GEYJ 101 V (100)	T	153.7/50.3
R74	7030003320	S.RES ERJ3GEYJ 101 V (100)	T	152.4/52.8
R75	7030003320	S.RES ERJ3GEYJ 101 V (100)	T	163.3/51.8
R76	7030003320	S.RES ERJ3GEYJ 101 V (100)	T	152.4/47.6
R77	7030003320	S.RES ERJ3GEYJ 101 V (100)	T	163.3/48.6
R78	7030003320	S.RES ERJ3GEYJ 101 V (100)	T	163.3/45.8
R79	7030003320	S.RES ERJ3GEYJ 101 V (100)	T	163.3/57.8
R81	7030010520	S.RES ERJ1TYJ 101U (100)	T	52.3/79.9
R103	7030003480	S.RES ERJ3GEYJ 222 V (2.2 k)	T	60.6/49
R104	7030003320	S.RES ERJ3GEYJ 101 V (100)	T	51.1/4.3
R105	7030003370	S.RES ERJ3GEYJ 271 V (270)	T	51.3/14.9
R106	7030003230	S.RES ERJ3GEYJ 180 V (18)	T	53.4/15.8
R107	7030003370	S.RES ERJ3GEYJ 271 V (270)	T	51.3/16.1
R108	7030003370	S.RES ERJ3GEYJ 271 V (270)	T	52.4/26.2
R109	7030003230	S.RES ERJ3GEYJ 180 V (18)	T	55.8/25.3
R110	7030003370	S.RES ERJ3GEYJ 271 V (270)	T	52.4/27.4
R111	7030003550	S.RES ERJ3GEYJ 822 V (8.2 k)	T	54.1/3.6
R112	7030003320	S.RES ERJ3GEYJ 101 V (100)	T	60.6/6.3
R113	7030003860	S.RES ERJ3GE JPW V	T	53.3/13.2
R201	7030003430	S.RES ERJ3GEYJ 821 V (820)	T	47.5/32.6
R202	7030003430	S.RES ERJ3GEYJ 821 V (820)	T	47.5/31.4
R203	7030003280	S.RES ERJ3GEYJ 470 V (47)	T	47.5/26.4
R204	7030003560	S.RES ERJ3GEYJ 103 V (10 k)	T	43.6/36.2
R205	7030003280	S.RES ERJ3GEYJ 470 V (47)	T	39.9/37.1
R206	7030003380	S.RES ERJ3GEYJ 331 V (330)	T	46/48.7
R207	7030003220	S.RES ERJ3GEYJ 150 V (15)	T	46.7/46.8
R208	7030003380	S.RES ERJ3GEYJ 331 V (330)	T	47.5/48.7
R209	7030003640	S.RES ERJ3GEYJ 473 V (47 k)	T	41.7/36.6
R210	7030003330	S.RES ERJ3GEYJ 121 V (120)	T	152.1/65.5
R211	7030011130	S.RES ERJ1TYJ 1R0U (1)	T	163.7/65.8
R301	7030003320	S.RES ERJ3GEYJ 101 V (100)	T	47/64.1
R302	7030003370	S.RES ERJ3GEYJ 271 V (270)	T	59.2/52.2
R303	7030003230	S.RES ERJ3GEYJ 180 V (18)	T	60/54
R304	7030003370	S.RES ERJ3GEYJ 271 V (270)	T	60.7/52.2
R305	7030003320	S.RES ERJ3GEYJ 101 V (100)	T	67.6/57.5
R306	7030003480	S.RES ERJ3GEYJ 222 V (2.2 k)	T	65.2/47
R307	7030003550	S.RES ERJ3GEYJ 822 V (8.2 k)	T	62.1/50.5
R308	7030003340	S.RES ERJ3GEYJ 151 V (150)	T	68.2/47
R402	7030003440	S.RES ERJ3GEYJ 102 V (1 k)	T	45/67
R403	7030003440	S.RES ERJ3GEYJ 102 V (1 k)	T	44.1/72.6
R404	7030003440	S.RES ERJ3GEYJ 102 V (1 k)	T	45.4/71.4
R405	7030003440	S.RES ERJ3GEYJ 102 V (1 k)	T	46.9/70.2
R410	7030003560	S.RES ERJ3GEYJ 103 V (10 k)	T	49.9/68.5
R411	7030003560	S.RES ERJ3GEYJ 103 V (10 k)	T	40.9/60.6
R412	7030003560	S.RES ERJ3GEYJ 103 V (10 k)	T	38.1/66
R413	7030003730	S.RES ERJ3GEYJ 274 V (270 k)	T	41.6/62.4
R414	7030003560	S.RES ERJ3GEYJ 103 V (10 k)	T	55.3/66.3
R415	7030003560	S.RES ERJ3GEYJ 103 V (10 k)	T	59/71.1
R416	7310005410	S.TRI EVM-3VSX50 BQ4 (473)	T	62.1/68.1
R417	7030003630	S.RES ERJ3GEYJ 104 V (100 k)	T	66.4/67.3
R418	7030003570	S.RES ERJ3GEYJ 123 V (12 k)	T	73.1/73.6
R419	7030003220	S.RES ERJ3GEYJ 150 V (15)	T	75.5/73.7
R421	7030003860	S.RES ERJ3GE JPW V	T	68.1/66.9
R422	7030003560	S.RES ERJ3GEYJ 103 V (10 k)	T	69.9/73.6
R423	7030003540	S.RES ERJ3GEYJ 682 V (6.8 k)	T	70.7/75.5
R424	7030003860	S.RES ERJ3GE JPW V	T	72.8/64.1
R429	7030003860	S.RES ERJ3GE JPW V	T	24.7/9
R431	7030003860	S.RES ERJ3GE JPW V	T	26.3/15.1
R433	7030005631	S.RES ERA3YKD 154V (150 k)	T	28.9/7.6
R435	7030005501	S.RES ERA3YKD 124V (120 k)	T	30.2/7.6
R436	7030005501	S.RES ERA3YKD 124V (120 k)	T	27/8.2
R437	7030003680	S.RES ERJ3GEYJ 104 V (100 k)	T	33.9/9
R438	7030003680	S.RES ERJ3GEYJ 104 V (100 k)	T	33.9/11.7
R500	7030003860	S.RES ERJ3GE JPW V	T	89.5/66.4
R501	7030003320	S.RES ERJ3GEYJ 101 V (100)	T	82.7/54.1
R502	7030003560	S.RES ERJ3GEYJ 103 V (10 k)	T	83.2/51.6
R503				

[SCOPE UNIT]

REF NO.	ORDER NO.	DESCRIPTION	M.	H/V LOCATION
R607	7030003560	S.RES ERJ3GEYJ 103 V (10 k)	T	127/70.7
R610	7030003800	S.RES ERJ3GEYJ 105 V (1 M)	T	98/53.7
R611	7030004040	S.RES ERJ3GEYJ 4R7 V (4.7)	T	94.2/56.4
R612	7030004040	S.RES ERJ3GEYJ 4R7 V (4.7)	T	95.4/57.9
R615	7030003320	S.RES ERJ3GEYJ 101 V (100)	T	99.2/53.6
R616	7030003520	S.RES ERJ3GEYJ 472 V (4.7 k)	T	103.9/43.1
R617	7030003520	S.RES ERJ3GEYJ 472 V (4.7 k)	T	105.1/43.1
R618	7030003520	S.RES ERJ3GEYJ 472 V (4.7 k)	T	105.9/45.1
R620	7030003560	S.RES ERJ3GEYJ 103 V (10 k)	T	125.4/73.4
R621	7030003560	S.RES ERJ3GEYJ 103 V (10 k)	T	122.6/73.8
R622	7030003860	S.RES ERJ3GE JPW V	T	108.8/45
R623	7030003860	S.RES ERJ3GE JPW V	T	103.9/66.9
R624	7030003560	S.RES ERJ3GEYJ 103 V (10 k)	T	122.6/72.5
R625	7030003560	S.RES ERJ3GEYJ 103 V (10 k)	T	123.1/70.7
R626	7030003560	S.RES ERJ3GEYJ 103 V (10 k)	T	121.7/70.7
R627	7030003560	S.RES ERJ3GEYJ 103 V (10 k)	T	105.5/47.9
R628	7030003560	S.RES ERJ3GEYJ 103 V (10 k)	T	123.2/40.6
R629	7030003560	S.RES ERJ3GEYJ 103 V (10 k)	T	122.6/43.2
R630	7030003560	S.RES ERJ3GEYJ 103 V (10 k)	T	121.1/43.2
R631	7030003560	S.RES ERJ3GEYJ 103 V (10 k)	T	120.5/39.2
R632	7030003560	S.RES ERJ3GEYJ 103 V (10 k)	T	119.7/41.8
R633	7030003560	S.RES ERJ3GEYJ 103 V (10 k)	T	118.7/39.5
R634	7030003860	S.RES ERJ3GE JPW V	T	101.9/58.5
R635	7030003560	S.RES ERJ3GEYJ 103 V (10 k)	T	118/42.1
R636	7030003560	S.RES ERJ3GEYJ 103 V (10 k)	T	105.1/66.9
R701	7030003240	S.RES ERJ3GEYJ 220 V (22)	T	134.7/34.3
R702	7030003560	S.RES ERJ3GEYJ 103 V (10 k)	T	129/34.3
R703	7030003320	S.RES ERJ3GEYJ 101 V (100)	T	132.8/34.3
R704	7030003280	S.RES ERJ3GEYJ 470 V (47)	T	136/32.4
R705	7030003340	S.RES ERJ3GEYJ 151 V (150)	T	128.5/32.4
R720	7030003370	S.RES ERJ3GEYJ 271 V (270)	T	148.9/28.3
R721	7030003560	S.RES ERJ3GEYJ 103 V (10 k)	T	150.1/28.3
R722	7030003340	S.RES ERJ3GEYJ 151 V (150)	T	152.5/28.3
R723	7030003440	S.RES ERJ3GEYJ 102 V (1 k)	T	141.6/6.6
R724	7030003440	S.RES ERJ3GEYJ 102 V (1 k)	T	141.6/5.4
R725	7030003440	S.RES ERJ3GEYJ 102 V (1 k)	T	138.4/4.8
R726	7030003440	S.RES ERJ3GEYJ 102 V (1 k)	T	141.6/4
R727	7030003440	S.RES ERJ3GEYJ 102 V (1 k)	T	137/28.6
R729	7030003280	S.RES ERJ3GEYJ 470 V (47)	T	144.5/26.3
R730	7030003560	S.RES ERJ3GEYJ 103 V (10 k)	T	145/29
R731	7030003460	S.RES ERJ3GEYJ 152 V (1.5 k)	T	150.2/20
R732	7030003510	S.RES ERJ3GEYJ 392 V (3.9 k)	T	151.5/15.7
R734	7030003510	S.RES ERJ3GEYJ 392 V (3.9 k)	T	147.6/24.2
R735	7030003280	S.RES ERJ3GEYJ 470 V (47)	T	151.1/13.2
R736	7030003280	S.RES ERJ3GEYJ 470 V (47)	T	151.5/14.4
R737	7030003440	S.RES ERJ3GEYJ 102 V (1 k)	T	138.2/6.6
R738	7030003640	S.RES ERJ3GEYJ 473 V (47 k)	T	133.2/27.6
R739	7030003510	S.RES ERJ3GEYJ 392 V (3.9 k)	T	151.5/17
R742	7030003860	S.RES ERJ3GE JPW V	T	131.9/27.5
R745	7030003860	S.RES ERJ3GE JPW V	T	130.9/9
R764	7030003370	S.RES ERJ3GEYJ 271 V (270)	T	121.7/2
R765	7030003230	S.RES ERJ3GEYJ 180 V (18)	T	119.9/1.2
R766	7030003370	S.RES ERJ3GEYJ 271 V (270)	T	118/2
R771	7030003860	S.RES ERJ3GE JPW V	T	110.8/1.2
R801	7030003440	S.RES ERJ3GEYJ 102 V (1 k)	T	113.6/16.5
R802	7030003440	S.RES ERJ3GEYJ 102 V (1 k)	T	114.8/13.1
R803	7030003440	S.RES ERJ3GEYJ 102 V (1 k)	T	114.7/14.6
R806	7030003520	S.RES ERJ3GEYJ 472 V (4.7 k)	T	106.1/18.7
R808	7030003600	S.RES ERJ3GEYJ 223 V (22 k)	T	105.3/21.2
R809	7030003840	S.RES ERJ3GEYJ 225 V (2.2 M)	T	107.6/20.2
R810	7030003370	S.RES ERJ3GEYJ 271 V (270)	T	117.7/13.8
R811	7030003560	S.RES ERJ3GEYJ 103 V (10 k)	T	117.5/18.8
R812	7030003280	S.RES ERJ3GEYJ 470 V (47)	T	114.6/10.2
R813	7030003340	S.RES ERJ3GEYJ 151 V (150)	T	117.5/24
R814	7030003500	S.RES ERJ3GEYJ 332 V (3.3 k)	T	103.9/19.7
R821	7030003680	S.RES ERJ3GEYJ 104 V (100 k)	T	83/24.5
R822	7030003680	S.RES ERJ3GEYJ 104 V (100 k)	T	90.5/23.2
R823	7030003370	S.RES ERJ3GEYJ 271 V (270)	T	87.1/20.3
R841	7030003200	S.RES ERJ3GEYJ 100 V (10)	T	81.6/18.5
R842	7030003360	S.RES ERJ3GEYJ 221 V (220)	T	85.8/13.6
R843	7030003500	S.RES ERJ3GEYJ 332 V (3.3 k)	T	83.8/17.7
R844	7030003540	S.RES ERJ3GEYJ 682 V (6.8 k)	T	82.3/16.4
R845	7030003360	S.RES ERJ3GEYJ 221 V (220)	T	82.3/15.1
R846	7030003380	S.RES ERJ3GEYJ 331 V (330)	T	84/10.6
R847	7030003370	S.RES ERJ3GEYJ 271 V (270)	T	74.7/15.5
R848	7030003540	S.RES ERJ3GEYJ 682 V (6.8 k)	T	70.2/14.6
R849	7030003500	S.RES ERJ3GEYJ 332 V (3.3 k)	T	73/12
R850	7030003390	S.RES ERJ3GEYJ 391 V (390)	T	72.4/17.7
R851	7030003360	S.RES ERJ3GEYJ 221 V (220)	T	68.8/18.9
R852	7030003490	S.RES ERJ3GEYJ 272 V (2.7 k)	T	74.4/21.1
R853	7030003510	S.RES ERJ3GEYJ 392 V (3.9 k)	T	74.4/24
R854	7030003360	S.RES ERJ3GEYJ 221 V (220)	T	68.8/21.5
R855	7030008180	S.RES ERJ12VJ331U (330)	T	87.5/32.2
R856	7030003370	S.RES ERJ3GEYJ 271 V (270)	T	66.8/43.9
R857	7030003230	S.RES ERJ3GEYJ 180 V (18)	T	64.5/43.1
R858	7030003320	S.RES ERJ3GEYJ 101 V (100)	T	64.5/44.6
R859	7030003260	S.RES ERJ3GEYJ 330 V (33)	T	68/24.7
R860	7030003400	S.RES ERJ3GEYJ 471 V (470)	T	86.1/10.6
R861	7030003860	S.RES ERJ3GE JPW V	T	68.2/43.9
R862	7030003320	S.RES ERJ3GEYJ 101 V (100)	T	1.7/25.1
R863	7030003320	S.RES ERJ3GEYJ 101 V (100)	T	12.7/30.9
R864	7030003320	S.RES ERJ3GEYJ 101 V (100)	T	21/29.9
R865	7030003320	S.RES ERJ3GEYJ 101 V (100)	T	10/24.1
R866	7030003320	S.RES ERJ3GEYJ 101 V (100)	T	1.7/23.1
R867	7030003320	S.RES ERJ3GEYJ 101 V (100)	T	1.7/27.1
R868	7030003320	S.RES ERJ3GEYJ 101 V (100)	T	10/28.1
R869	7030003860	S.RES ERJ3GE JPW V	T	10/22.1
R870	7030003320	S.RES ERJ3GEYJ 101 V (100)	T	12.7/26.9
R871	7030003320	S.RES ERJ3GEYJ 101 V (100)	T	21/27.9
R872	7030003320	S.RES ERJ3GEYJ 101 V (100)	T	21/31.9
R873	7030003320	S.RES ERJ3GEYJ 101 V (100)	T	12.7/32.9
R874	7030003320	S.RES ERJ3GEYJ 101 V (100)	T	21/33.9
R876	7030003320	S.RES ERJ3GEYJ 101 V (100)	T	12.7/28.9
R877	7030003860	S.RES ERJ3GE JPW V	T	12.7/34.9

[SCOPE UNIT]

REF NO.	ORDER NO.	DESCRIPTION	M.	H/V LOCATION
R878	7030003320	S.RES ERJ3GEYJ 101 V (100)	T	165.9/46.8
R879	7030003320	S.RES ERJ3GEYJ 101 V (100)	T	174.2/47.8
R880	7030003320	S.RES ERJ3GEYJ 101 V (100)	T	174.2/49.8
R881	7030003320	S.RES ERJ3GEYJ 101 V (100)	T	165.9/50.8
R882	7030003320	S.RES ERJ3GEYJ 101 V (100)	T	174.2/51.8
R883	7030003320	S.RES ERJ3GEYJ 101 V (100)	T	174.2/53.8
R884	7030003320	S.RES ERJ3GEYJ 101 V (100)	T	165.9/54.8
R885	7030003320	S.RES ERJ3GEYJ 101 V (100)	T	174.2/55.8
R886	7030003320	S.RES ERJ3GEYJ 101 V (100)	T	165.9/56.8
R887	7030003320	S.RES ERJ3GEYJ 101 V (100)	T	174.2/57.8
R888	7030003320	S.RES ERJ3GEYJ 101 V (100)	T	165.9/58.8
R889	7030003320	S.RES ERJ3GEYJ 101 V (100)	T	174.2/59.8
R890	7030003860	S.RES ERJ3GE JPW V	T	165.9/60.8
R891	7030003860	S.RES ERJ3GE JPW V	T	174.2/45.9
C1	4030006880	S.CER C1608 JB 1H 472K-T	T	23.5/72.1
C3	4030006880	S.CER C1608 JB 1H 472K-T	T	19/69.1
C4	4030011340	S.CER C1608 CH 1H 471J-T	T	17.1/63.3
C5	4030011340	S.CER C1608 CH 1H 471J-T	T	20.3/60.8
C6	4030006880	S.CER C1608 JB 1H 472K-T	T	17.1/61.6
C7	4030006880	S.CER C1608 JB 1H 472K-T	T	20.4/56.8
C8	4030006880	S.CER C1608 JB 1H 472K-T	T	13.2/58
C9	4030006880	S.CER C1608 JB 1H 472K-T	T	17.5/56.7
C10	4030011600	S.CER C1608 JB 1E 104K-T	T	23.7/54.5
C11	4030009510	S.CER C1608 CH 1H 010B-T	T	16.9/47.4
C12	4030007040	S.CER C1608 CH 1H 180J-T	T	22.4/44.1
C13	4030007040	S.CER C1608 CH 1H 180J-T	T	18.2/40.9
C14	4030011340	S.CER C1608 CH 1H 471J-T	T	28.2/35.4
C15	4030006880	S.CER C1608 JB 1H 472K-T	T	26.4/33.2
C16	4030006880	S.CER C1608 JB 1H 472K-T	T	32.2/19.8
C17	4030006880	S.CER C1608 JB 1H 472K-T	T	36.4/25.2
C18	4030006960	S.CER C1608 CH 1H 050C-T	T	29.8/26.5
C21	4030006880	S.CER C1608 JB 1H 472K-T	T	125.9/32.4
C22	4030006880	S.CER C1608 JB 1H 472K-T	T	23.5/73.6
C23	4030011600	S.CER C1608 JB 1E 104K-T	T	152.4/44.8
C24	4030011600	S.CER C1608 JB 1E 104K-T	T	23.5/70.9
C39	4030011600	S.CER C1608 JB 1E 104K-T	T	20.8/74.7
C40	4030011600	S.CER C1608 JB 1E 104K-T	T	20.9/70.9
C41	4610001830	S.TRI TZB4S100AB10R00	T	13.9/44.2
C42	4030007030	S.CER C1608 CH 1H 150J-T	T	17.5/55.4
C43	4030007120	S.CER C1608 CH 1H 820J-T	T	15.5/54.6
C44	4030007100	S.CER C1608 CH 1H 560J-T	T	17.5/53.7
C45	4030007400	S.CER C1608 CH 1H 180J-T	T	16.8/51.6
C46	4030008750	S.CER C1608 CH 1H 360J-T	T	18.3/51.6
C53	4510008540	S.ELE EEE1CA100SR	T	59.3/76.9
C54	4510008540	S.ELE EEE1CA100SR	T	74.4/50.4
C55	4030011600	S.CER C1608 JB 1E 104K-T	T	48/75.9
C56	4510008540	S.ELE EEE1CA100SR	T	44.2/76.9
C57	4030011600	S.CER C1608 JB 1E 104K-T	T	55.3/76.3
C101	4030006880	S.CER C1608 JB 1H 472K-T	T	60.6/37.7
C102	4030007150	S.CER C1608 CH 1H 151J-T	T	53/5.4
C103	4030011600	S.CER C1608 JB 1E 104K-T	T	48.7/6.5
C106	4030006880	S.CER C1608 JB 1H 472K-T	T	60.6/7.5
C107	4030007100	S.CER C1608 CH 1H 560J-T	T	53/8
C108	4030007110	S.CER C1608 CH 1H 680J-T	T	54.8/9.9
C109	4030007110	S.CER C1608 CH 1H 121J-T	T	53/10.6
C110	4030007140	S.CER C1608 CH 1H 680J-T	T	54.8/11.4
C201	4030007040	S.CER C1608 CH 1H 180J-T	T	58.4/35.2
C202	4030007040	S.CER C1608 CH 1H 180J-T	T	53.7/37.6
C204	4030006880	S.CER C1608 JB 1H 472K-T	T	47.5/33.8
C205	4030007070	S.CER C1608 CH 1H 330J-T	T	44/25.2
C206	4030006880	S.CER C1608 JB 1H 472K-T	T	47.5/27.6
C207	4030006960	S.CER C1608 CH 1H 050C-T	T	44.8/34.8
C208	4030007070	S.CER C1608 CH 1H 330J-T	T	41.7/37.8
C209	4030006880	S.CER C1608 JB 1H 472K-T	T	39.2/39.7
C210	4030011600	S.CER C1608 JB 1E 104K-T	T	37.7/44.8
C211	4030009550	S.CER C1608 CH 1E 2R5B-T	T	59.6/35.3
C212	4030006940	S.CER C1608 CH 1H 030C-T	T	52.5/37.6
C213	4550007460	S.TAN F930G107MBABMA	T	155.7/74.6
C214	4510009270	S.ELE EEEH1C220UR	T	162.4/70.5
C215	4030011600	S.CER C1608 JB 1E 104K-T	T	157/64.7
C216	4030011600	S.CER C1608 JB 1A 104K-T	T	154.3/64.7
C301	4030007040	S.CER C1608 CH 1H 180J-T	T	62.6/54
C302	4030006880	S.CER C1608 JB 1H 472K-T	T	67.6/54.7
C303	4030006880	S.CER C1608 JB 1H 472K-T	T	63.8/47
C304	4030006880	S.CER C1608 JB 1H 472K-T	T	66.8/47
C401	4030008850	S.CER		

[RF-B UNIT]

REF NO.	ORDER NO.	DESCRIPTION	M.	H/V LOCATION
C506	4030011600	S.CER C1608 JB 1E 104K-T	T	89.1/62.9
C507	4510008580	S.ELE EEE0JA470SR	T	78.6/68.5
C508	4030017490	S.CER C1608 JB 1A 105K-T	T	76.9/64
C509	4030011600	S.CER C1608 JB 1E 104K-T	T	87.2/69
C521	4510008540	S.ELE EEE1CA100SR	T	91.4/79.3
C522	4030011600	S.CER C1608 JB 1E 104K-T	T	87.3/79.4
C523	4550006250	S.TAN TEESVA 1A 106M8R	T	79.4/77.2
C524	4030011600	S.CER C1608 JB 1E 104K-T	T	81.1/77.6
C551	4550007460	S.TAN F930G107MBA BMA	T	126.8/41.6
C601	4030011600	S.CER C1608 JB 1E 104K-T	T	113.7/70.6
C602	4030011600	S.CER C1608 JB 1E 104K-T	T	115.5/70.8
C603	4030011600	S.CER C1608 JB 1E 104K-T	T	117.8/70.6
C604	4030011600	S.CER C1608 JB 1E 104K-T	T	119.1/70.6
C605	4030011600	S.CER C1608 JB 1E 104K-T	T	120.5/70.7
C606	4030011600	S.CER C1608 JB 1E 104K-T	T	125.7/70.8
C607	4030011600	S.CER C1608 JB 1E 104K-T	T	131.4/64.5
C608	4030011600	S.CER C1608 JB 1E 104K-T	T	131.4/62.9
C609	4030011600	S.CER C1608 JB 1E 104K-T	T	130.6/59.2
C610	4030011600	S.CER C1608 JB 1E 104K-T	T	131.4/57.1
C611	4030011600	S.CER C1608 JB 1E 104K-T	T	131.4/54.9
C612	4030011600	S.CER C1608 JB 1E 104K-T	T	131.4/52.9
C613	4030011600	S.CER C1608 JB 1E 104K-T	T	130.6/50.2
C614	4030011600	S.CER C1608 JB 1E 104K-T	T	129.4/47.4
C615	4030011600	S.CER C1608 JB 1E 104K-T	T	125.6/44.5
C616	4030011600	S.CER C1608 JB 1E 104K-T	T	124.4/44.7
C617	4030011600	S.CER C1608 JB 1E 104K-T	T	121.9/45.1
C618	4030011600	S.CER C1608 JB 1E 104K-T	T	119.4/44.4
C619	4030011600	S.CER C1608 JB 1E 104K-T	T	117/44.7
C620	4030011600	S.CER C1608 JB 1E 104K-T	T	115.8/44.7
C621	4030011600	S.CER C1608 JB 1E 104K-T	T	113.9/45.5
C622	4030011600	S.CER C1608 JB 1E 104K-T	T	111.3/45.5
C623	4030011600	S.CER C1608 JB 1E 104K-T	T	105.2/50.2
C624	4030011600	S.CER C1608 JB 1E 104K-T	T	105.2/51.6
C625	4030011600	S.CER C1608 JB 1E 104K-T	T	105.1/56.6
C626	4030011600	S.CER C1608 JB 1E 104K-T	T	105.5/58.9
C627	4030011600	S.CER C1608 JB 1E 104K-T	T	105/63.7
C628	4030011600	S.CER C1608 JB 1E 104K-T	T	106.2/63.7
C629	4030011600	S.CER C1608 JB 1E 104K-T	T	105.5/54.7
C660	4510008540	S.ELE EEE1CA100SR	T	96.5/45.9
C661	4030011600	S.CER C1608 JB 1E 104K-T	T	98/51.5
C662	4030011600	S.CER C1608 JB 1E 104K-T	T	127.2/44.7
C663	4030011600	S.CER C1608 JB 1E 104K-T	T	96.7/56.4
C664	4030011600	S.CER C1608 JB 1E 104K-T	T	94.2/53.8
C666	4550007310	S.TAN F930J227MNM BMA	T	132.5/43.7
C667	4550007310	S.TAN F930J227MNM BMA	T	137.3/43.7
C671	4030011600	S.CER C1608 JB 1E 104K-T	T	148/48.2
C672	4030006880	S.CER C1608 JB 1H 472K-T	T	100.4/53.6
C702	4030011600	S.CER C1608 JB 1E 104K-T	T	130.9/35.3
C703	4030011600	S.CER C1608 JB 1E 104K-T	T	133.4/32.4
C720	4030006880	S.CER C1608 JB 1H 472K-T	T	127.9/19.6
C721	4030011600	S.CER C1608 JB 1E 104K-T	T	128.3/21.7
C722	4510008540	S.ELE EEE1CA100SR	T	127.6/25.6
C723	4030006880	S.CER C1608 JB 1H 472K-T	T	155/18.7
C724	4030011600	S.CER C1608 JB 1E 104K-T	T	155/19.9
C725	4510008540	S.ELE EEE1CA100SR	T	155.2/15.2
C726	4030006880	S.CER C1608 JB 1H 472K-T	T	149.4/25.7
C727	4030006880	S.CER C1608 JB 1H 472K-T	T	151.3/28.3
C730	4030011600	S.CER C1608 JB 1E 104K-T	T	129.2/16.8
C731	4030011600	S.CER C1608 JB 1E 104K-T	T	129.2/19.6
C733	4030011600	S.CER C1608 JB 1E 104K-T	T	138.5/7.8
C734	4030011600	S.CER C1608 JB 1E 104K-T	T	148.2/11.4
C736	4030011600	S.CER C1608 JB 1E 104K-T	T	141.9/26.3
C737	4030011600	S.CER C1608 JB 1E 104K-T	T	148.1/22.3
C738	4030011600	S.CER C1608 JB 1E 104K-T	T	141.8/7.8
C739	4030011600	S.CER C1608 JB 1E 104K-T	T	144.6/7.8
C740	4030011600	S.CER C1608 JB 1E 104K-T	T	148.1/18.9
C741	4030011600	S.CER C1608 JB 1E 104K-T	T	137.7/26.6
C742	4030011600	S.CER C1608 JB 1E 104K-T	T	135/26.6
C750	4030006900	S.CER C1608 JB 1H 103K-T	T	148.2/16
C751	4030006900	S.CER C1608 JB 1H 103K-T	T	150.2/18.8
C761	4030007150	S.CER C1608 CH 1H 151J-T	T	149.8/11.4
C762	4030007110	S.CER C1608 CH 1H 680J-T	T	151.8/8.9
C763	4030011280	S.CER C1608 CH 1H 271J-T	T	149.1/8.9
C764	4030007080	S.CER C1608 CH 1H 390J-T	T	153.6/8.4
C765	4030011830	S.CER C1608 CH 1H 301J-T	T	148.9/7.7
C766	4030007020	S.CER C1608 CH 1H 120J-T	T	149.3/5.9
C767	4030007170	S.CER C1608 CH 1H 221J-T	T	148.1/5.9
C768	4030011280	S.CER C1608 CH 1H 271J-T	T	137.1/1.9
C769	4030006860	S.CER C1608 JB 1H 102K-T	T	134.1/2.7
C770	4030011280	S.CER C1608 CH 1H 271J-T	T	132.2/2
C801	4030006880	S.CER C1608 JB 1H 472K-T	T	109.9/18.6
C802	4510008540	S.ELE EEE1CA100SR	T	112.7/23.4
C803	4030006900	S.CER C1608 JB 1H 103K-T	T	104/15.7
C805	4550003220	S.TAN TEESVA 1E 105M8R	T	102.1/17.3
C806	4340000240	S.MLR ECHU 1C 682JX5	T	107.8/21.9
C807	4030006880	S.CER C1608 JB 1H 472K-T	T	113.2/11.9
C808	4030006880	S.CER C1608 JB 1H 472K-T	T	160.9/15.2
C809	4510008540	S.ELE EEE1CA100SR	T	164/10.1
C810	4030006880	S.CER C1608 JB 1H 472K-T	T	117.5/21.4
C811	4030006880	S.CER C1608 JB 1H 472K-T	T	117/11.5
C812	4030006880	S.CER C1608 JB 1H 472K-T	T	117.5/9.5
C813	4030011600	S.CER C1608 JB 1E 104K-T	T	109.6/10.4
C821	4030007060	S.CER C1608 CH 1H 270J-T	T	101.4/25.1
C822	4030007100	S.CER C1608 CH 1H 560J-T	T	98/24.3
C823	4030006960	S.CER C1608 CH 1H 050C-T	T	99.3/24.3
C824	4610001850	S.TRI TZB4R200AB10R00	T	94.3/23.3
C825	4030007130	S.CER C1608 CH 1H 101J-T	T	90.6/25.4
C826	4030007060	S.CER C1608 CH 1H 270J-T	T	84.5/24.5
C827	4030007020	S.CER C1608 CH 1H 120J-T	T	89.1/23.2
C828	4030006880	S.CER C1608 JB 1H 472K-T	T	87.1/21.7
C829	4030009500	S.CER C1608 CH 1H 0R5B-T	T	81.6/21.5
C830	4030006860	S.CER C1608 JB 1H 102K-T	T	83.2/35.1
C831	4030006880	S.CER C1608 JB 1H 472K-T	T	83.2/33.9
C832	4510008500	S.ELE EEE1CA101WP	T	87.6/38.1

[SCOPE UNIT]

REF NO.	ORDER NO.	DESCRIPTION	M.	H/V LOCATION
C833	4510008540	S.ELE EEE1CA100SR	T	81.6/39.2
C842	4030006880	S.CER C1608 JB 1H 472K-T	T	83.1/13.6
C843	4030006880	S.CER C1608 JB 1H 472K-T	T	67.3/12.4
C844	4030006880	S.CER C1608 JB 1H 472K-T	T	68.6/12.4
C845	4510008520	S.ELE EEE1CA470SP	T	75.7/37.8
C846	4030006880	S.CER C1608 JB 1H 472K-T	T	82.1/19.9
C847	4030006880	S.CER C1608 JB 1H 472K-T	T	73/13.3
C848	4030006880	S.CER C1608 JB 1H 472K-T	T	73.1/19
C849	4030006880	S.CER C1608 JB 1H 472K-T	T	73.1/21.1
C850	4030006880	S.CER C1608 JB 1H 472K-T	T	68.8/20.2
C851	4030006880	S.CER C1608 JB 1H 472K-T	T	68.8/22.8
C852	4030007120	S.CER C1608 CH 1H 820J-T	T	68/26.5
C853	4030007070	S.CER C1608 CH 1H 330J-T	T	67.9/28.4
C854	4030007140	S.CER C1608 CH 1H 121J-T	T	73.7/26.5
C855	4030007020	S.CER C1608 CH 1H 120J-T	T	73.7/28.8
C856	4030007090	S.CER C1608 CH 1H 470J-T	T	73.8/31
C862	4030006880	S.CER C1608 JB 1H 472K-T	T	104/13.1
J1	6510007020	CNR TMP-J01X-V6		
J3	6510007020	CNR TMP-J01X-V6		
J11	6510007020	CNR TMP-J01X-V6		
J601	6510019971	S.CNR 52808-1071	T	102.1/32.4
J2013	6510023261	S.CNR B6B-PH-SM4-TB (LF) (SN)	T	173.1/32.6
J2016	6510020091	S.CNR 52808-0871 (0890)	T	5.9/25.6
J2017	6510019971	S.CNR 52808-1071	T	16.9/30.4
J2020	6510019991	S.CNR 52808-2271 (2291)	T	157.8/50.3
J2021	6510019981	S.CNR 52808-1671 (1690)	T	170.1/53.3
EP54	6910014690	S.BEA MPZ1608S221A-T	T	166.6/32.2
EP55	6910014690	S.BEA MPZ1608S221A-T	T	171.4/13.5
EP56	6910014690	S.BEA MPZ1608S221A-T	T	141.4/34.8
EP57	6910014690	S.BEA MPZ1608S221A-T	T	166.6/29.6
EP58	6910014690	S.BEA MPZ1608S221A-T	T	157.5/23.6
EP59	6910014690	S.BEA MPZ1608S221A-T	T	166.6/33.6
EP60	6910014690	S.BEA MPZ1608S221A-T	T	166.6/31

M.=Mounted side (T: Mounted on the Top side B: Mounted on the Bottom side)
S.=Surface mount

[LOGIC UNIT]

REF NO.	ORDER NO.	DESCRIPTION	M.	H/V LOCATION
IC1	1130014630	S.IC MT48LC16M16A2P IT	T	94.7/50.3
IC2	1130014630	S.IC MT48LC16M16A2P IT	T	94.7/34.2
IC51	1130011591	S.IC IDT70V24L15PFG	B	168/84.3
IC52	1140009781	S.IC XC9572XL-10TQG100C	B	139.7/86.9
IC53	1110005821	S.IC R3112N281A-TR-F	B	15/60.9
IC54	1130007431	S.IC TC7S14FU (TE85R,F)	B	19.8/61.9
IC55	1130008041	S.IC TC7SH04FU (TE85L,JF)	B	22.7/62.6
IC56	1130010111	S.IC TC7WH04FU (TE12L,F)	T	265/70.9
IC101	1130011010	S.IC SN74CBLTV3257PWR <ACE>	T	206.5/48.9
IC102	1130006441	S.IC TC7S08F (TE85R,F)	B	148.2/67.8
IC103	1140011561	S.IC HD6417751RBP200V	T	132.4/39.2
IC104	1130008361	S.IC TC7SHU04FU (TE85L,JF)	T	161.4/46.2
IC105	1130012241	S.IC CY2292FXC (SX-2590J)	B	158.2/43.8
IC106	1130011110	S.IC TC74VCX04FT (EL)	T	159.2/39.9
IC201	1130014630	S.IC MT48LC16M16A2P IT	T	78.8/82.8
IC202	1130014630	S.IC MT48LC16M16A2P IT	T	62.7/82.8
IC203	1140011571	S.IC HD64404BTDV	T	61/51.6
IC204	1140011581	S.IC ADV7123KSTZ50	B	77/9.2
IC205	1130011941	S.IC TC7SZ04F (TE85L,F)	B	82.1/16.3
IC206	1130012150	S.IC SN74ACT04PWR	B	104.5/4.8
IC208	1130014030	S.IC BD6516F-E2	T	22.3/73.4
IC209	1190001920	S.IC AK5355-VT-E2	B	94.3/78.7
IC210	1190001920	S.IC AK5355-VT-E2	B	104/78.7
IC211	1190001910	S.IC AK4384-VT-E2	B	110.7/78.7
IC212	1190001910	S.IC AK4384-VT-E2	B	116.6/78.7
IC403	1130009570	S.IC BR93LC46F-WE2	T	169/40.2
IC404	1130010990	S.IC RTL8139C <GMI>	B	180.9/41.9
IC601	1130008041	S.IC TC7SH04FU (TE85L,JF)	T	251.7/64
IC602	1130008711	S.IC TC7SET04FU (T5L,JF)	T	256.5/65
IC603	1110004770	S.IC BU9480F-E2	B	219.6/69.9
IC604	1140011590	S.IC HD64F2377VQ33V	B	198.4/77.7
IC605	1140009781	S.IC XC9572XL-10TQG100C	T	175.5/104
IC607	1130006441	S.IC TC7S08F (TE85R,F)	B	206.9/63
IC608	1130006441	S.IC TC7S08F (TE85R,F)	B	212.6/63.3
IC609	1130005252	S.IC TC74HC08AF (EL,F)	T	178/63.5
IC610	1140008650	S.IC HN58X2464T1	T	194.9/63.8
IC801	1180003170	S.REG uPC2933BT-E1-AZ	T	21.9/42.4
IC802	1180001541	S.IC TA78L08F (TE12L,F)	T	21.9/56.4
IC821	1110002700	S.IC NJM2904M-TE1-#FMZB	T	253.4/33.2
IC851	1110003870	S.IC NJM2058M-TE1	B	235.6/63.4
IC852	1110003870	S.IC NJM2058M-TE1	B	114.6/96.2
IC853	1110003870	S.IC NJM2058M-TE1	B	97.8/94.3
IC854	1130005721	S.IC TC7W04F (TE12L,F)	T	51.2/102.5
IC2051	1130009831	S.IC TC74VHCT04AF (F)	T	264.9/88.4
IC2052	1130005252	S.IC TC74HC08AF (EL,F)	B	264.9/94.7
IC2053	1130005721	S.IC TC7W04F (TE12L,F)	T	265/99.2
IC2054	1120002921	S.IC ADM202EARNZ	T	275.1/94.6
Q601	1530002060	S.TR 2SC4081 T106 R	T	256.8/71.4
Q602	1510000510	S.TR 2SA1576A T106R	T	251.7/67
Q802	1530002060	S.TR 2SC4081 T106 R	T	242.6/83.7
Q803	1540000441	S.TR 2SD1619T-TD-E	T	238.6/85.5
Q804	1540000441	S.TR 2SD1619T-TD-E	T	238.6/78.3
Q805	1530002060	S.TR 2SC4081 T106 R	T	242.6/76.5
Q810	1540000550	S.TR 2SD1664 T100Q	T	238.6/91.3
Q821	1520000651	S.TR 2SB1201S-TL-E	T	242.2/34.9
Q822	1530002060	S.TR 2SC4081 T106 R	T	247.8/38
Q901	1590001960	S.TR XP4311 (TX)	B	15.6/100.9
Q902	1590001960	S.TR XP4311 (TX)	B	5.7/100.2
Q2051	1510000510	S.TR 2SA1576A T106R	T	258.9/85.5
Q2052	1530002280	S.TR 2SC4081 T106 S	T	254.9/79.4
D51	1750000550	S.DIO 1SS355 TE-17	T	143.6/99.8
D52	1750000550	S.DIO 1SS355 TE-17	T	141.9/99.8
D53	1750000550	S.DIO 1SS355 TE-17	T	140.3/99.8
D54	1750000550	S.DIO 1SS355 TE-17	T	138.6/99.8
D55	1750000550	S.DIO 1SS355 TE-17	T	137/99.8
D56	1750000550	S.DIO 1SS355 TE-17	T	135.3/99.8
D57	1750000550	S.DIO 1SS355 TE-17	T	133.7/99.8
D58	1750000550	S.DIO 1SS355 TE-17	T	132/99.8
D59	1750000550	S.DIO 1SS355 TE-17	T	130.4/99.8
D60	1750000550	S.DIO 1SS355 TE-17	T	143.6/103.6
D61	1750000550	S.DIO 1SS355 TE-17	T	141.9/103.6
D62	1750000550	S.DIO 1SS355 TE-17	T	140.3/103.6
D63	1750000550	S.DIO 1SS355 TE-17	T	138.6/103.6
D64	1750000550	S.DIO 1SS355 TE-17	T	137/103.6
D65	1750000550	S.DIO 1SS355 TE-17	T	135.3/103.6
D66	1750000550	S.DIO 1SS355 TE-17	T	133.7/103.6
D67	1750000550	S.DIO 1SS355 TE-17	T	132/103.6
D68	1750000550	S.DIO 1SS355 TE-17	T	130.4/103.6
D201	1790000980	S.DIO MA742 (TX)	B	91.7/11.1
D202	1790000980	S.DIO MA742 (TX)	B	91.7/11.1
D203	1790000980	S.DIO MA742 (TX)	B	91.7/16.8
D204	1790000980	S.DIO MA742 (TX)	B	110.1/7.9
D205	1790000980	S.DIO MA742 (TX)	B	110.1/3
D206	1790000980	S.DIO MA742 (TX)	B	16/71.7
D207	1790000980	S.DIO MA742 (TX)	B	16/68.2
D208	1790000980	S.DIO MA742 (TX)	B	16/79.3
D209	1790000980	S.DIO MA742 (TX)	B	16/75.8
D601	1750000550	S.DIO 1SS355 TE-17	T	254.7/71.3
D801	1750000370	S.DIO DA221 TL	B	238.7/89.2
D802	1750000370	S.DIO DA221 TL	B	238.7/82
D805	1790001611	S.DIO 1SS385 (TE85L,F)	B	194.1/113.5
D821	1730002340	S.ZEN MA8047-M (TX)	T	247.9/35.1
D851	1750000550	S.DIO 1SS355 TE-17	B	241.9/67.6

[LOGIC UNIT]

REF NO.	ORDER NO.	DESCRIPTION	M.	H/V LOCATION
D852	1750000550	S.DIO 1SS355 TE-17	B	230.4/67.6
D853	1790000980	S.DIO MA742 (TX)	T	99.2/94
D854	1790000980	S.DIO MA742 (TX)	B	104.9/92.7
D855	1790000980	S.DIO MA742 (TX)	B	88.4/86.7
D856	1790000980	S.DIO MA742 (TX)	T	99.1/89.3
D857	1750000550	S.DIO 1SS355 TE-17	B	230.8/57.3
D858	1750000550	S.DIO 1SS355 TE-17	B	239.3/57.1
D860	1790000980	S.DIO MA742 (TX)	B	188.2/108.2
D861	1790000980	S.DIO MA742 (TX)	B	188.2/110.7
D862	1790000980	S.DIO MA742 (TX)	B	188.2/113.2
D863	1790000980	S.DIO MA742 (TX)	B	188.2/115.7
D864	1790000980	S.DIO MA742 (TX)	B	194.4/101.2
D865	1790000980	S.DIO MA742 (TX)	B	194.4/106.2
D866	1790000980	S.DIO MA742 (TX)	B	194.4/103.7
D867	1790000980	S.DIO MA742 (TX)	B	194.4/108.7
D901	1790000980	S.DIO MA742 (TX)	B	194.4/115.9
D2051	1750000550	S.DIO 1SS355 TE-17	T	257.1/79.5
X101	6050011610	S.XTL CR-751 (25.000 MHz)	T	160.6/52.4
X201	6050010690	S.XTL CR-628 (24.576 MHz)	T	42.9/56.6
X202	6050011910	S.XTL CR-780 (48 MHz)	T	79.6/52.9
X601	6050011810	S.XTL CR-755 (15.9744 MHz)	T	201.3/94.5
L203	6200002631	S.COL NLV25T-R10J	B	96/10.8
L204	6200002631	S.COL NLV25T-R10J	B	96/13.7
L205	6200002631	S.COL NLV25T-R10J	B	96/16.5
L801	6200003261	S.COL NLV32T-101J	T	223.7/32.2
L803	6180003321	S.COL SLF6028T-150M1R0-PF	T	200.8/35.7
L804	6180003321	S.COL SLF6028T-150M1R0-PF	T	198.2/27.6
L805	6180003321	S.COL SLF6028T-150M1R0-PF	T	191.7/27.7
L806	6180003321	S.COL SLF6028T-150M1R0-PF	T	176.6/16.1
L807	6180003321	S.COL SLF6028T-150M1R0-PF	T	200.8/5.9
L808	6200013300	S.COL SLF1255T-150M2R8-PF	T	197.8/16.4
L811	6200001831	S.COL NLV32T-100J	T	203.5/27.5
L826	6180003321	S.COL SLF6028T-150M1R0-PF	T	21.2/14.6
L2051	6200003241	S.COL NLV32T-221J	T	257.7/101.6
R1	7030003520	S.RES ERJ3GEYJ 472 V (4.7 k)	T	89.5/69.8
R51	7030003520	S.RES ERJ3GEYJ 472 V (4.7 k)	B	129.4/93.4
R52	7030003560	S.RES ERJ3GEYJ 103 V (10 k)	B	17.6/61.1
R55	7030003440	S.RES ERJ3GEYJ 102 V (1 k)	B	144.1/96.4
R56	7030003440	S.RES ERJ3GEYJ 102 V (1 k)	B	147.1/95.6
R57	7030003680	S.RES ERJ3GEYJ 104 V (100 k)	T	260.7/71.9
R58	7030003680	S.RES ERJ3GEYJ 104 V (100 k)	T	260.7/70.6
R101	7030003680	S.RES ERJ3GEYJ 104 V (100 k)	T	266.3/68.6
R102	7030003520	S.RES ERJ3GEYJ 472 V (4.7 k)	T	201.1/50.5
R103	7030003520	S.RES ERJ3GEYJ 472 V (4.7 k)	T	201.2/48.6
R104	7030003520	S.RES ERJ3GEYJ 472 V (4.7 k)	T	211.2/50.7
R105	7030003520	S.RES ERJ3GEYJ 472 V (4.7 k)	T	212/49.7
R106	7030003560	S.RES ERJ3GEYJ 103 V (10 k)	B	137.2/40.3
R107	7030003560	S.RES ERJ3GEYJ 103 V (10 k)	B	137.2/35.1
R108	7030003560	S.RES ERJ3GEYJ 103 V (10 k)	B	148.1/36.1
R109	7030003560	S.RES ERJ3GEYJ 103 V (10 k)	B	138.5/37.7
R110	7030003560	S.RES ERJ3GEYJ 103 V (10 k)	T	148/38.1
R111	7030003560	S.RES ERJ3GEYJ 103 V (10 k)	B	138.5/40.3
R112	7030003560	S.RES ERJ3GEYJ 103 V (10 k)	T	148/36.8
R113	7030003560	S.RES ERJ3GEYJ 103 V (10 k)	B	138.5/35.1
R114	7030003560	S.RES ERJ3GEYJ 103 V (10 k)	B	148.1/33.5
R115	7030003560	S.RES ERJ3GEYJ 103 V (10 k)	B	134.6/35.1
R116	7030003560	S.RES ERJ3GEYJ 103 V (10 k)	B	135.9/35.1
R117	7030003260	S.RES ERJ3GEYJ 330 V (33)	B	148.1/29.7
R118	7030003560	S.RES ERJ3GEYJ 103 V (10 k)	B	133.3/35.1
R119	7030003560	S.RES ERJ3GEYJ 103 V (10 k)	B	147.5/27.6
R120	7030003560	S.RES ERJ3GEYJ 103 V (10 k)	B	132/35.1
R121	7030003560	S.RES ERJ3GEYJ 103 V (10 k)	B	152/29.7
R122	7030003560	S.RES ERJ3GEYJ 103 V (10 k)	B	150.7/29.7
R123	7030003560	S.RES ERJ3GEYJ 103 V (10 k)	B	142.2/25
R124	7030003680	S.RES ERJ3GEYJ 104 V (100 k)	T	148/34.2
R125	7030003520	S.RES ERJ3GEYJ 472 V (4.7 k)	T	148/35.5
R126	7030003560	S.RES ERJ3GEYJ 103 V (10 k)	B	135.9/37.7
R127	7030003560	S.RES ERJ3GEYJ 103 V (10 k)	B	137.2/37.7
R128	7030003560	S.RES ERJ3GEYJ 103 V (10 k)	T	151.4/36.8
R129	7030003560	S.RES ERJ3GEYJ 103 V (10 k)	T	151.4/38.1
R130	7030003560	S.RES ERJ3GEYJ 103 V (10 k)	B	146.8/42
R131	7030003560	S.RES ERJ3GEYJ 103 V (10 k)	B	135.9/40.3
R132	7030003560	S.RES ERJ3GEYJ 103 V (10 k)	T	148/39.4
R133	7030003560	S.RES ERJ3GEYJ 103 V (10 k)	T	151.4/39.4
R134	7030003200	S.RES ERJ3GEYJ 100 V (10)	B	138.5/42.9
R135	7030003200	S.RES ERJ3GEYJ 100 V (10)	B	137.2/42.9
R136	7030003200	S.RES ERJ3GEYJ 100 V (10)	B	146.8/55.3
R137	7030004050	S.RES ERJ3GEYJ 1R0 V (1)	B	129.3/35.1
R138	7030003560	S.RES ERJ3GEYJ 103 V (10 k)	B	128/35.1
R139	7030003560	S.RES ERJ3GEYJ 103 V (10 k)	B	119.2/34.2
R140	7410000990	S.ARY EXB-V8V 470JV (47)	T	114.6/33.1
R141	7410000990	S.ARY EXB-V8V 470JV (47)	T	114.6/29.5
R142	7410000990	S.ARY EXB-V8V 470JV (47)	T	114.6/40.3
R143	7410000990	S.ARY EXB-V8V 470JV (47)	T	114.6/47.5
R144	7410000990	S.ARY EXB-V8V 470JV (47)	T	114.6/36.7
R145	7410000990	S.ARY EXB-V8V 470JV (47)	T	114.6/43.9
R146	7030003280	S.RES ERJ3GEYJ 470 V (47)	T	116/56.9
R147	7030003280	S.RES ERJ3GEYJ 470 V (47)	T	117.2/56.9
R148	7410000990	S.ARY EXB-V8V 470JV (47)	T	114.6/51.1
R149	7410000990	S.ARY EXB-V8V 470JV (47)	T	142.4/57
R150	7410000990	S.ARY EXB-V8V 470JV (47)	T	138.8/57

[LOGIC UNIT]

REF NO.	ORDER NO.	DESCRIPTION	M.	H/V LOCATION
R158	7030003560	S.RES ERJ3GEYJ 103 V (10 k)	T	147.8/67.9
R159	7030003560	S.RES ERJ3GEYJ 103 V (10 k)	T	147.8/69.2
R161	7030003250	S.RES ERJ3GEYJ 270 V (27)	B	160.2/49.5
R162	7030003800	S.RES ERJ3GEYJ 105 V (1 M)	T	159.9/48
R163	7030003320	S.RES ERJ3GEYJ 101 V (100)	T	154.5/40.3
R164	7030003250	S.RES ERJ3GEYJ 270 V (27)	B	162.7/42.6
R165	7030003340	S.RES ERJ3GEYJ 151 V (150)	T	159.9/49.2
R166	7030003860	S.RES ERJ3GE JPW V	T	159.4/35.9
R167	7030003860	S.RES ERJ3GE JPW V	T	158.2/35.9
R170	7030003600	S.RES ERJ3GEYJ 223 V (22 k)	T	134.5/23.5
R171	7030003600	S.RES ERJ3GEYJ 223 V (22 k)	T	133.2/23.5
R172	7030003600	S.RES ERJ3GEYJ 223 V (22 k)	T	128/23.5
R173	7030003600	S.RES ERJ3GEYJ 223 V (22 k)	T	129.3/23.5
R174	7030003600	S.RES ERJ3GEYJ 223 V (22 k)	T	130.6/23.5
R175	7030003600	S.RES ERJ3GEYJ 223 V (22 k)	T	131.9/23.5
R176	7030003600	S.RES ERJ3GEYJ 223 V (22 k)	T	126.7/23.5
R201	7030003560	S.RES ERJ3GEYJ 103 V (10 k)	T	50.4/68.8
R202	7030003560	S.RES ERJ3GEYJ 103 V (10 k)	T	50.4/65.6
R203	7030003560	S.RES ERJ3GEYJ 103 V (10 k)	T	49.1/72.7
R204	7030003560	S.RES ERJ3GEYJ 103 V (10 k)	T	50.4/72.7
R205	7030003560	S.RES ERJ3GEYJ 103 V (10 k)	T	53/68.8
R206	7030003560	S.RES ERJ3GEYJ 103 V (10 k)	T	51.7/65.6
R207	7030003560	S.RES ERJ3GEYJ 103 V (10 k)	T	51.7/72.7
R208	7030003560	S.RES ERJ3GEYJ 103 V (10 k)	T	53/72.7
R209	7030003560	S.RES ERJ3GEYJ 103 V (10 k)	T	51.7/68.8
R212	7030003640	S.RES ERJ3GEYJ 473 V (47 k)	T	56.9/37.3
R213	7030003640	S.RES ERJ3GEYJ 473 V (47 k)	T	54.3/37.3
R218	7030003520	S.RES ERJ3GEYJ 472 V (4.7 k)	T	80.8/63.5
R219	7030003520	S.RES ERJ3GEYJ 472 V (4.7 k)	T	82/64.8
R220	7030003520	S.RES ERJ3GEYJ 472 V (4.7 k)	B	64.9/48.4
R221	7030003560	S.RES ERJ3GEYJ 103 V (10 k)	T	67.2/38
R225	7030003560	S.RES ERJ3GEYJ 103 V (10 k)	B	59.7/48.4
R226	7030003560	S.RES ERJ3GEYJ 103 V (10 k)	B	58.4/48.4
R227	7030003560	S.RES ERJ3GEYJ 103 V (10 k)	T	41.4/44.6
R228	7030003560	S.RES ERJ3GEYJ 103 V (10 k)	T	44.4/44.6
R229	7030003560	S.RES ERJ3GEYJ 103 V (10 k)	T	47.5/43.9
R230	7030003560	S.RES ERJ3GEYJ 103 V (10 k)	T	44.4/45.9
R231	7030003560	S.RES ERJ3GEYJ 103 V (10 k)	T	47.5/45.2
R232	7030003560	S.RES ERJ3GEYJ 103 V (10 k)	B	56.1/47.6
R233	7030003560	S.RES ERJ3GEYJ 103 V (10 k)	T	41.4/45.9
R234	7030003560	S.RES ERJ3GEYJ 103 V (10 k)	T	47.5/46.5
R235	7030003560	S.RES ERJ3GEYJ 103 V (10 k)	T	44.4/47.2
R236	7030003560	S.RES ERJ3GEYJ 103 V (10 k)	T	41.4/47.2
R237	7030003560	S.RES ERJ3GEYJ 103 V (10 k)	B	56.1/48.9
R238	7030003560	S.RES ERJ3GEYJ 103 V (10 k)	T	47.5/47.8
R239	7030003560	S.RES ERJ3GEYJ 103 V (10 k)	T	44.4/48.5
R240	7030003560	S.RES ERJ3GEYJ 103 V (10 k)	T	41.4/48.5
R241	7030003560	S.RES ERJ3GEYJ 103 V (10 k)	B	50/51.9
R242	7030003560	S.RES ERJ3GEYJ 103 V (10 k)	T	47.5/49.2
R243	7030003560	S.RES ERJ3GEYJ 103 V (10 k)	B	56.1/50.2
R244	7030003560	S.RES ERJ3GEYJ 103 V (10 k)	T	74.6/49.2
R245	7030003560	S.RES ERJ3GEYJ 103 V (10 k)	T	74.6/42.7
R246	7030003560	S.RES ERJ3GEYJ 103 V (10 k)	T	78.3/41.4
R247	7030003560	S.RES ERJ3GEYJ 103 V (10 k)	B	64.9/51
R248	7030003560	S.RES ERJ3GEYJ 103 V (10 k)	T	74.6/44
R249	7030003560	S.RES ERJ3GEYJ 103 V (10 k)	T	74.6/38.8
R250	7030003560	S.RES ERJ3GEYJ 103 V (10 k)	T	74.6/40.1
R251	7030003560	S.RES ERJ3GEYJ 103 V (10 k)	T	78.3/42.7
R252	7030003560	S.RES ERJ3GEYJ 103 V (10 k)	T	78.3/40.1
R253	7030003560	S.RES ERJ3GEYJ 103 V (10 k)	T	68.4/38
R254	7030003560	S.RES ERJ3GEYJ 103 V (10 k)	T	74.6/41.4
R255	7030003560	S.RES ERJ3GEYJ 103 V (10 k)	T	78.3/38.8
R256	7030003560	S.RES ERJ3GEYJ 103 V (10 k)	B	62.3/51
R257	7030003560	S.RES ERJ3GEYJ 103 V (10 k)	T	74.6/45.3
R258	7030003560	S.RES ERJ3GEYJ 103 V (10 k)	B	61/51
R259	7030003560	S.RES ERJ3GEYJ 103 V (10 k)	T	78.3/45.3
R260	7030003560	S.RES ERJ3GEYJ 103 V (10 k)	B	59.7/51
R261	7030003560	S.RES ERJ3GEYJ 103 V (10 k)	T	78.3/46.6
R262	7030003560	S.RES ERJ3GEYJ 103 V (10 k)	B	58.4/51
R263	7030003560	S.RES ERJ3GEYJ 103 V (10 k)	B	72.9/47.4
R264	7030003560	S.RES ERJ3GEYJ 103 V (10 k)	B	66.8/52.3
R265	7030003560	S.RES ERJ3GEYJ 103 V (10 k)	T	80.9/46.6
R266	7030003560	S.RES ERJ3GEYJ 103 V (10 k)	T	80.9/45.3
R267	7030003560	S.RES ERJ3GEYJ 103 V (10 k)	T	74.6/47.9
R268	7030003560	S.RES ERJ3GEYJ 103 V (10 k)	B	72.9/44.8
R269	7030003560	S.RES ERJ3GEYJ 103 V (10 k)	T	74.6/46.6
R270	7030003560	S.RES ERJ3GEYJ 103 V (10 k)	T	78.3/44
R271	7030003560	S.RES ERJ3GEYJ 103 V (10 k)	T	80.9/44
R272	7030003560	S.RES ERJ3GEYJ 103 V (10 k)	T	77.4/62
R273	7030003560	S.RES ERJ3GEYJ 103 V (10 k)	T	77.4/60.8
R274	7030003560	S.RES ERJ3GEYJ 103 V (10 k)	B	59.7/54.1
R275	7030003560	S.RES ERJ3GEYJ 103 V (10 k)	T	74.6/63.2
R276	7030003560	S.RES ERJ3GEYJ 103 V (10 k)	T	74.6/60.8
R277	7030003560	S.RES ERJ3GEYJ 103 V (10 k)	T	74.6/59.6
R278	7030003560	S.RES ERJ3GEYJ 103 V (10 k)	T	74.6/58.4
R279	7030003560	S.RES ERJ3GEYJ 103 V (10 k)	B	58.4/54.1
R280	7030003560	S.RES ERJ3GEYJ 103 V (10 k)	T	77.4/63.2
R281	7030003560	S.RES ERJ3GEYJ 103 V (10 k)	B	64.2/54.9
R282	7030003560	S.RES ERJ3GEYJ 103 V (10 k)	B	64.2/53.6
R283	7030003560	S.RES ERJ3GEYJ 103 V (10 k)	B	73.7/59.7
R284	7030003560	S.RES ERJ3GEYJ 103 V (10 k)	B	73.7/58.4
R285	7030003560	S.RES ERJ3GEYJ 103 V (10 k)	B	61/54.1
R286	7030003560	S.RES ERJ3GEYJ 103 V (10 k)	T	77.4/59.6
R287	7030003560	S.RES ERJ3GEYJ 103 V (10 k)	T	74.6/56
R288	7030003560	S.RES ERJ3GEYJ 103 V (10 k)	T	77.4/57.2
R289	7030003560	S.RES ERJ3GEYJ 103 V (10 k)	T	74.6/54.8
R290	7030003560	S.RES ERJ3GEYJ 103 V (10 k)	B	62.3/54.1
R291	7030003560	S.RES ERJ3GEYJ 103 V (10 k)	T	74.6/57.2
R292	7030003560	S.RES ERJ3GEYJ 103 V (10 k)	B	63.6/48.4
R293	7030003560	S.RES ERJ3GEYJ 103 V (10 k)	B	62.3/48.4
R294	7030003560	S.RES ERJ3GEYJ 103 V (10 k)	B	61/48.4
R295	7030003640	S.RES ERJ3GEYJ 473 V (47 k)	B	63.6/51
R296	7030003560	S.RES ERJ3GEYJ 103 V (10 k)	T	47.8/65.6
R297	7030003560	S.RES ERJ3GEYJ 103 V (10 k)	T	43.9/65.6

[LOGIC UNIT]

REF NO.	ORDER NO.	DESCRIPTION	M.	H/V LOCATION
R298	7030003560	S.RES ERJ3GEYJ 103 V (10 k)	T	43.9/72.7
R299	7030003560	S.RES ERJ3GEYJ 103 V (10 k)	T	45.2/65.6
R300	7030003560	S.RES ERJ3GEYJ 103 V (10 k)	T	45.2/68.8
R301	7030003560	S.RES ERJ3GEYJ 103 V (10 k)	T	45.2/72.7
R302	7030003560	S.RES ERJ3GEYJ 103 V (10 k)	T	43.9/68.8
R303	7030003560	S.RES ERJ3GEYJ 103 V (10 k)	T	46.5/72.7
R304	7030003560	S.RES ERJ3GEYJ 103 V (10 k)	T	46.5/68.8
R305	7030003560	S.RES ERJ3GEYJ 103 V (10 k)	T	46.5/65.6
R306	7030003560	S.RES ERJ3GEYJ 103 V (10 k)	T	49.1/65.6
R307	7030003560	S.RES ERJ3GEYJ 103 V (10 k)	T	49.1/68.8
R308	7030003560	S.RES ERJ3GEYJ 103 V (10 k)	T	47.8/72.7
R309	7030003560	S.RES ERJ3GEYJ 103 V (10 k)	T	47.8/68.8
R310	7030003560	S.RES ERJ3GEYJ 103 V (10 k)	T	74.6/62
R311	7030003560	S.RES ERJ3GEYJ 103 V (10 k)	T	77.4/58.4
R313	7030003410	S.RES ERJ3GEYJ 561 V (560)	B	79/3.2
R314	7030003340	S.RES ERJ3GEYJ 151 V (150)	B	88.5/11.3
R315	7030003340	S.RES ERJ3GEYJ 151 V (150)	B	89.8/11.3
R316	7030003340	S.RES ERJ3GEYJ 151 V (150)	B	88.5/13.9
R317	7030003340	S.RES ERJ3GEYJ 151 V (150)	B	89.8/13.9
R318	7030003340	S.RES ERJ3GEYJ 151 V (150)	B	88.5/16.5
R319	7030003340	S.RES ERJ3GEYJ 151 V (150)	B	93.6/16.7
R320	7030003240	S.RES ERJ3GEYJ 220 V (22)	B	110/6.1
R321	7030003240	S.RES ERJ3GEYJ 220 V (22)	B	110/4.8
R322	7030003250	S.RES ERJ3GEYJ 270 V (27)	B	13.2/70.6
R323	7030003250	S.RES ERJ3GEYJ 270 V (27)	B	13.2/69.3
R324	7030003580	S.RES ERJ3GEYJ 153 V (15 k)	B	12.5/72.4
R325	7030003580	S.RES ERJ3GEYJ 153 V (15 k)	B	12.5/67.4
R326	7030003250	S.RES ERJ3GEYJ 270 V (27)	B	13.2/78.2
R327	7030003250	S.RES ERJ3GEYJ 270 V (27)	B	13.2/76.9
R328	7030003580	S.RES ERJ3GEYJ 153 V (15 k)	B	12.5/80
R329	7030003580	S.RES ERJ3GEYJ 153 V (15 k)	B	12.5/75
R330	7030003560	S.RES ERJ3GEYJ 103 V (10 k)	B	21.6/70.6
R331	7030003560	S.RES ERJ3GEYJ 103 V (10 k)	B	22.9/70.6
R332	7030003640	S.RES ERJ3GEYJ 473 V (47 k)	B	96.9/84.2
R333	7030003640	S.RES ERJ3GEYJ 473 V (47 k)	B	93.7/73.3
R334	7030003640	S.RES ERJ3GEYJ 473 V (47 k)	T	94/78.7
R335	7030003280	S.RES ERJ3GEYJ 470 V (47)	B	95.5/73.3
R336	7030003640	S.RES ERJ3GEYJ 473 V (47 k)	B	106.4/84.2
R337	7030003640	S.RES ERJ3GEYJ 473 V (47 k)	B	103.4/73.3
R338	7030003640	S.RES ERJ3GEYJ 473 V (47 k)	T	103.5/78.7
R339	7030003280	S.RES ERJ3GEYJ 470 V (47)	B	105.2/73.3
R340	7030003280	S.RES ERJ3GEYJ 470 V (47)	B	113/73.3
R341	7030003640	S.RES ERJ3GEYJ 473 V (47 k)	B	110.1/73.3
R342	7030003280	S.RES ERJ3GEYJ 470 V (47)	B	118.9/73.3
R343	7030003640	S.RES ERJ3GEYJ 473 V (47 k)	B	116.1/73.3
R344	7030003520	S.RES ERJ3GEYJ 472 V (4.7 k)	B	108.2/84.2
R345	7030003520	S.RES ERJ3GEYJ 472 V (4.7 k)	B	113.7/84.2
R346	7030003560	S.RES ERJ3GEYJ 103 V (10 k)	B	109.4/84.2
R347	7030003860	S.RES ERJ3GE JPW V	T	20.4/66.7
R348	7030003860	S.RES ERJ3GE JPW V	T	24.2/67.6
R350	7030003860	S.RES ERJ3GE JPW V	T	80.7/62.1
R351	7030003860	S.RES ERJ3GE JPW V	B	56.1/54.9
R353	7030003860	S.RES ERJ3GE JPW V	T	60.7/28.5
R355	7030003860	S.RES ERJ3GE JPW V	T	59.3/28.5
R356	7030003860	S.RES ERJ3GE JPW V	T	62/25.4
R357	7030003860	S.RES ERJ3GE JPW V	B	99.8/11.4
R358	7030003860	S.RES ERJ3GE JPW V	B	99.8/14.4
R359	7030003860	S.RES ERJ3GE JPW V	B	99.8/17.4
R360	7030003860	S.RES ERJ3GE JPW V	B	117.6/3.2
R361	7030003320	S.RES ERJ3GEYJ 101 V (100)	B	79.7/16.6
R371	7030003200	S.RES ERJ3GEYJ 100 V (10)	B	46.5/47.7
R372	7030003200	S.RES ERJ3GEYJ 100 V (10)	B	43.2/44.5
R373	7030003200	S.RES ERJ3GEYJ 100 V (10)	B	44.3/47.7
R374	7030003200	S.RES ERJ3GEYJ 100 V (10)	B	42.1/47.7
R375	7030003200	S.RES ERJ3GEYJ 100 V (10)	B	37.7/47.7
R376	7030003200	S.RES ERJ3GEYJ 100 V (10)	B	41/44.5
R377	7030003200	S.RES ERJ3GEYJ 100 V (10)	B	39.9/47.7
R378	7030003200	S.RES ERJ3GEYJ 100 V (10)	B	36.6/44.5
R379	7030003200	S.RES ERJ3GEYJ 100 V (10)	B	38.8/44.5
R380	7030003200	S.RES ERJ3GEYJ 100 V (10)	B	35.5/47.7
R381	7030003200	S.RES ERJ3GEYJ 100 V (10)	B	45.4/44.5
R382	7030003200	S.RES ERJ3GEYJ 100 V (10)	B	52.8/37.1
R383	7030003200	S.RES ERJ3GEYJ 100 V (10)	B	49.6/34.1
R384	7030003200	S.RES ERJ3GEYJ 100 V (10)	B	50.6/37.1
R385	7030003200	S.RES ERJ3GEYJ 100 V (10)	B	47.4/34.1
R386	7030003200	S.RES ERJ3GEYJ 100 V (10)	B	48.4/37.1

[LOGIC UNIT]

REF NO.	ORDER NO.	DESCRIPTION	M.	H/V LOCATION
R601	7030003620	S.RES ERJ3GEYJ 333 V (33 k)	T	254.7/68.3
R602	7030003590	S.RES ERJ3GEYJ 183 V (18 k)	T	257.1/67.9
R603	7030003540	S.RES ERJ3GEYJ 682 V (6.8 k)	T	253.5/66.8
R604	7030003640	S.RES ERJ3GEYJ 473 V (47 k)	T	249.9/65.4
R605	7030003680	S.RES ERJ3GEYJ 104 V (100 k)	T	255.8/62.8
R606	7030003680	S.RES ERJ3GEYJ 104 V (100 k)	T	251.8/61.6
R607	7030003350	S.RES ERJ3GEYJ 181 V (180)	B	198.6/92
R608	7030003520	S.RES ERJ3GEYJ 472 V (4.7 k)	B	196/92
R609	7030003440	S.RES ERJ3GEYJ 102 V (1 k)	B	216.6/85.1
R610	7030003440	S.RES ERJ3GEYJ 102 V (1 k)	B	216.6/83.9
R611	7030003440	S.RES ERJ3GEYJ 102 V (1 k)	B	216.6/82.7
R612	7030003440	S.RES ERJ3GEYJ 102 V (1 k)	B	216.6/81.5
R613	7030003440	S.RES ERJ3GEYJ 102 V (1 k)	B	216.6/80.4
R614	7030003440	S.RES ERJ3GEYJ 102 V (1 k)	B	216.6/79.1
R615	7030003440	S.RES ERJ3GEYJ 102 V (1 k)	B	216.6/77.9
R616	7030003440	S.RES ERJ3GEYJ 102 V (1 k)	B	216.6/76.7
R617	7030003800	S.RES ERJ3GEYJ 105 V (1 M)	T	217.9/76.7
R618	7030003800	S.RES ERJ3GEYJ 105 V (1 M)	T	217.9/77.9
R619	7030003800	S.RES ERJ3GEYJ 105 V (1 M)	T	217.9/79.1
R620	7030003800	S.RES ERJ3GEYJ 105 V (1 M)	T	217.9/80.3
R621	7030003800	S.RES ERJ3GEYJ 105 V (1 M)	T	217.9/81.5
R622	7030003800	S.RES ERJ3GEYJ 105 V (1 M)	T	217.9/82.7
R623	7030003800	S.RES ERJ3GEYJ 105 V (1 M)	T	217.9/83.9
R624	7030003800	S.RES ERJ3GEYJ 105 V (1 M)	T	217.9/85.1
R625	7030003640	S.RES ERJ3GEYJ 223 V (22 k)	B	212.5/77.3
R626	7030003600	S.RES ERJ3GEYJ 223 V (22 k)	B	212.5/76
R627	7030003640	S.RES ERJ3GEYJ 473 V (47 k)	T	205.3/73.2
R628	7030003640	S.RES ERJ3GEYJ 473 V (47 k)	T	205.3/74.6
R629	7030003640	S.RES ERJ3GEYJ 473 V (47 k)	B	212.4/72.5
R630	7030003520	S.RES ERJ3GEYJ 472 V (4.7 k)	T	229.2/86.5
R631	7030003520	S.RES ERJ3GEYJ 472 V (4.7 k)	T	229.2/85.3
R632	7030003520	S.RES ERJ3GEYJ 472 V (4.7 k)	T	229.2/84.1
R633	7030003520	S.RES ERJ3GEYJ 472 V (4.7 k)	T	229.2/82.9
R634	7030003520	S.RES ERJ3GEYJ 472 V (4.7 k)	T	229.2/81.7
R635	7030003520	S.RES ERJ3GEYJ 472 V (4.7 k)	T	229.2/80.5
R636	7030003640	S.RES ERJ3GEYJ 473 V (47 k)	B	209.2/62.9
R637	7030003640	S.RES ERJ3GEYJ 473 V (47 k)	B	214.9/62.9
R639	7030003640	S.RES ERJ3GEYJ 473 V (47 k)	T	211.8/59.2
R640	7030003640	S.RES ERJ3GEYJ 473 V (47 k)	T	216.7/52.2
R641	7030003640	S.RES ERJ3GEYJ 473 V (47 k)	T	218/52.2
R642	7030003640	S.RES ERJ3GEYJ 473 V (47 k)	T	219.2/52.2
R643	7030003600	S.RES ERJ3GEYJ 223 V (22 k)	T	200.7/64.2
R644	7030003560	S.RES ERJ3GEYJ 103 V (10 k)	T	201.9/64.2
R645	7030003520	S.RES ERJ3GEYJ 472 V (4.7 k)	B	190.4/63.5
R646	7030003720	S.RES ERJ3GEYJ 224 V (220 k)	B	183.7/88.4
R647	7030003720	S.RES ERJ3GEYJ 224 V (220 k)	B	183.7/86.5
R648	7030003720	S.RES ERJ3GEYJ 224 V (220 k)	B	183.7/85.2
R649	7030003720	S.RES ERJ3GEYJ 224 V (220 k)	B	183.7/83.9
R650	7030003720	S.RES ERJ3GEYJ 224 V (220 k)	B	183.7/82.6
R651	7030003720	S.RES ERJ3GEYJ 224 V (220 k)	B	183.7/81.3
R652	7030003720	S.RES ERJ3GEYJ 224 V (220 k)	B	183.7/80
R653	7030003720	S.RES ERJ3GEYJ 224 V (220 k)	B	183.7/78.7
R654	7030003520	S.RES ERJ3GEYJ 472 V (4.7 k)	B	183.7/67.3
R655	7030003520	S.RES ERJ3GEYJ 472 V (4.7 k)	B	183.7/66.6
R656	7030003520	S.RES ERJ3GEYJ 472 V (4.7 k)	T	181.9/114.5
R657	7030003720	S.RES ERJ3GEYJ 224 V (220 k)	B	212.5/78.6
R658	7030003640	S.RES ERJ3GEYJ 473 V (47 k)	T	195.4/71.3
R660	7030003640	S.RES ERJ3GEYJ 473 V (47 k)	T	193.7/79.4
R661	7030003640	S.RES ERJ3GEYJ 473 V (47 k)	T	205.3/77.4
R662	7030003640	S.RES ERJ3GEYJ 473 V (47 k)	T	195.9/83.2
R663	7030003640	S.RES ERJ3GEYJ 473 V (47 k)	T	207.7/84.2
R665	7030003560	S.RES ERJ3GEYJ 103 V (10 k)	T	194.3/83.2
R666	7030003560	S.RES ERJ3GEYJ 103 V (10 k)	T	206.3/84.2
R668	7030003640	S.RES ERJ3GEYJ 473 V (47 k)	B	200.5/92
R669	7030003640	S.RES ERJ3GEYJ 473 V (47 k)	T	205.3/76
R670	7030003640	S.RES ERJ3GEYJ 473 V (47 k)	B	189.1/63.5
R671	7030003640	S.RES ERJ3GEYJ 473 V (47 k)	B	187.8/63.5
R672	7030003640	S.RES ERJ3GEYJ 473 V (47 k)	B	206.6/92
R674	7030003640	S.RES ERJ3GEYJ 473 V (47 k)	B	194.3/63.5
R675	7030003640	S.RES ERJ3GEYJ 473 V (47 k)	B	193/63.5
R676	7030003640	S.RES ERJ3GEYJ 473 V (47 k)	B	193.4/92
R677	7030003520	S.RES ERJ3GEYJ 472 V (4.7 k)	T	171.5/115
R678	7030003720	S.RES ERJ3GEYJ 224 V (220 k)	B	212.5/79.9
R679	7030003640	S.RES ERJ3GEYJ 473 V (47 k)	B	194.7/92
R680	7030003520	S.RES ERJ3GEYJ 472 V (4.7 k)	T	172.8/115
R681	7030003520	S.RES ERJ3GEYJ 472 V (4.7 k)	T	169.9/115
R687	7030003520	S.RES ERJ3GEYJ 472 V (4.7 k)	T	164.5/101.7
R689	7030003520	S.RES ERJ3GEYJ 472 V (4.7 k)	T	164.5/105.1
R690	7030003520	S.RES ERJ3GEYJ 472 V (4.7 k)	T	164.5/103.8
R691	7030003640	S.RES ERJ3GEYJ 473 V (47 k)	T	172.7/64.1
R692	7030003520	S.RES ERJ3GEYJ 472 V (4.7 k)	T	164.5/108.5
R693	7030003520	S.RES ERJ3GEYJ 472 V (4.7 k)	T	164.5/109.8
R694	7030003640	S.RES ERJ3GEYJ 473 V (47 k)	T	28.3/87.7
R695	7030003640	S.RES ERJ3GEYJ 473 V (47 k)	T	19.5/88.7
R696	7030003520	S.RES ERJ3GEYJ 472 V (4.7 k)	T	164.5/100.2
R697	7030003520	S.RES ERJ3GEYJ 472 V (4.7 k)	T	166.2/112.8
R701	7030003860	S.RES ERJ3GE JPW V	B	191.7/63.5
R703	7030003640	S.RES ERJ3GEYJ 473 V (47 k)	B	197.5/63.9
R801	7030003560	S.RES ERJ3GEYJ 103 V (10 k)	T	245.6/83
R802	7030006210	S.RES ERJ12YJ4R7U (4.7)	B	236.9/85.2
R803	7030003440	S.RES ERJ3GEYJ 102 V (1 k)	B	238.6/87.6
R804	7030006210	S.RES ERJ12YJ4R7U (4.7)	B	236.9/78
R805	7030003440	S.RES ERJ3GEYJ 102 V (1 k)	B	238.6/80.4
R806	7030003560	S.RES ERJ3GEYJ 103 V (10 k)	T	242.7/74.7
R808	7030003860	S.RES ERJ3GE JPW V	T	196.1/6.6
R811	7030008240	S.RES ERJ12Y0R00U	T	41.7/30.8
R812	7030010440	S.RES ERJ1TYJ 680U (68)	T	30/44.2
R813	7030003560	S.RES ERJ3GEYJ 103 V (10 k)	T	10.4/12.6
R814	7030003440	S.RES ERJ3GEYJ 102 V (1 k)	T	209.1/34.6
R816	7030003560	S.RES ERJ3GEYJ 103 V (10 k)	T	242.5/93.1
R817	7030003560	S.RES ERJ3GEYJ 103 V (10 k)	T	242.5/91.9
R818	7030000140	S.RES MCR10EZJH 10 (100)	T	235.3/90.1
R819	7030007190	S.RES ERJ12YJ220U (22)	T	28.9/51.6
R821	7030003370	S.RES ERJ3GEYJ 271 V (270)	T	258.7/37.2

[LOGIC UNIT]

REF NO.	ORDER NO.	DESCRIPTION	M.	H/V LOCATION
R822	7030009720	S.RES ERJ12YJ102U (1 k)	T	258.7/32.5
R823	7030003810	S.RES ERJ3GEYJ 125 V (1.2 M)	T	254.5/28
R824	7030003810	S.RES ERJ3GEYJ 125 V (1.2 M)	T	250/33.4
R825	7030008170	S.RES ERJ12YJ1R0U (1)	T	247.5/29.9
R826	7030003610	S.RES ERJ3GEYJ 273 V (27 k)	T	251.9/28
R827	7030003610	S.RES ERJ3GEYJ 273 V (27 k)	T	250/30.7
R828	7030003560	S.RES ERJ3GEYJ 103 V (10 k)	T	257.1/38.8
R829	7030000340	S.RES MCR10EZJH 470 (47)	T	247.8/40.1
R830	7030003600	S.RES ERJ3GEYJ 223 V (22 k)	T	255.2/38.1
R832	7030003600	S.RES ERJ3GEYJ 223 V (22 k)	T	254.4/39.9
R833	7030003560	S.RES ERJ3GEYJ 103 V (10 k)	T	252.6/38.1
R841	7030003480	S.RES ERJ3GEYJ 222 V (2.2 k)	B	113.3/101.9
R842	7030003640	S.RES ERJ3GEYJ 473 V (47 k)	B	111.4/101.2
R843	7030003380	S.RES ERJ3GEYJ 331 V (330)	B	110.2/102.7
R850	7030003860	S.RES ERJ3GE JPW V	B	239.9/68.4
R851	7030003680	S.RES ERJ3GEYJ 104 V (100 k)	B	235.3/55.9
R854	7030003770	S.RES ERJ3GEYJ 564 V (560 k)	B	233.8/57.3
R855	7030003520	S.RES ERJ3GEYJ 472 V (4.7 k)	B	230.5/55.8
R857	7030003560	S.RES ERJ3GEYJ 103 V (10 k)	B	111.1/87.7
R858	7030003460	S.RES ERJ3GEYJ 152 V (1.5 k)	B	111.1/88.9
R859	7030003470	S.RES ERJ3GEYJ 182 V (1.8 k)	B	112.6/90.1
R860	7030003500	S.RES ERJ3GEYJ 332 V (3.3 k)	B	108.8/94.9
R861	7030003480	S.RES ERJ3GEYJ 222 V (2.2 k)	B	111.4/91.3
R862	7030003480	S.RES ERJ3GEYJ 222 V (2.2 k)	B	108.8/91.3
R863	7030003560	S.RES ERJ3GEYJ 103 V (10 k)	B	118.1/87.7
R864	7030003460	S.RES ERJ3GEYJ 152 V (1.5 k)	B	118.1/88.9
R865	7030003470	S.RES ERJ3GEYJ 182 V (1.8 k)	B	116.6/90.1
R866	7030003500	S.RES ERJ3GEYJ 332 V (3.3 k)	B	120.4/94.9
R867	7030003480	S.RES ERJ3GEYJ 222 V (2.2 k)	B	117.9/91.3
R868	7030003380	S.RES ERJ3GEYJ 331 V (330)	B	120.5/91.3
R869	7030003560	S.RES ERJ3GEYJ 103 V (10 k)	B	114.9/84.2
R871	7030003680	S.RES ERJ3GEYJ 104 V (100 k)	B	236.9/57.8
R872	7030003770	S.RES ERJ3GEYJ 564 V (560 k)	B	238.9/58.5
R873	7030003520	S.RES ERJ3GEYJ 472 V (4.7 k)	B	241.5/56.3
R874	7030003540	S.RES ERJ3GEYJ 682 V (6.8 k)	B	240.3/55.1
R876	7030003410	S.RES ERJ3GEYJ 561 V (560)	B	91.8/97.8
R877	7030003700	S.RES ERJ3GEYJ 154 V (150 k)	B	94.5/99.2
R878	7030003520	S.RES ERJ3GEYJ 472 V (4.7 k)	B	95.3/101.1
R879	7030003550	S.RES ERJ3GEYJ 822 V (8.2 k)	B	103.7/99.2
R880	7030003690	S.RES ERJ3GEYJ 124 V (120 k)	B	101.1/99.2
R881	7030003520	S.RES ERJ3GEYJ 472 V (4.7 k)	B	101.1/101.6
R882	7030003410	S.RES ERJ3GEYJ 561 V (560)	B	91.6/87.2
R883	7030003550	S.RES ERJ3GEYJ 822 V (8.2 k)	B	92.1/89.3
R884	7030003520	S.RES ERJ3GEYJ 472 V (4.7 k)	B	92.9/87.2
R885	7030003410	S.RES ERJ3GEYJ 561 V (560)	B	103.7/89.4
R886	7030003550	S.RES ERJ3GEYJ 822 V (8.2 k)	B	101.1/89.4
R887	7030003520	S.RES ERJ3GEYJ 472 V (4.7 k)	B	101.1/87.9
R888	7030003360	S.RES ERJ3GEYJ 221 V (220)	B	241.1/69.8
R889	7030003640	S.RES ERJ3GEYJ 473 V (47 k)	B	241.4/71.8
R890	7030003360	S.RES ERJ3GEYJ 221 V (220)	B	231.2/69.8
R891	7030003560	S.RES ERJ3GEYJ 103 V (10 k)	B	231.9/71.6
R892	7030003730	S.RES ERJ3GEYJ 274 V (270 k)	B	232.4/68.3
R893	7030003680	S.RES ERJ3GEYJ 104 V (100 k)	B	239.1/70.2
R894	7030003200	S.RES ERJ3GEYJ 100 V (10)	B	237.9/69.1
R895	7030003680	S.RES ERJ3GEYJ 104 V (100 k)	B	233.1/70.2
R896	7030003200	S.RES ERJ3GEYJ 100 V (10)	B	234.3/69.1
R901	7030003200	S.RES ERJ3GEYJ 100 V (10)	T	230.7/110.6
R902	7030003200	S.RES ERJ3GEYJ 100 V (10)	B	229.7/116.4
R903	7030003200	S.RES ERJ3GEYJ 100 V (10)	T	228.7/110.6
R904	7030003200	S.RES ERJ3GEYJ 100 V (10)	T	227.7/116.4
R905	7030003200	S.RES ERJ3GEYJ 100 V (10)	T	226.7/110.6
R906	7030003200	S.RES ERJ3GEYJ 100 V (10)	B	225.7/116.4
R907	7030003200	S.RES ERJ3GEYJ 100 V (10)	T	224.7/110.6
R908	7030003200	S.RES ERJ3GEYJ 100 V (10)	B	223.7/116.4
R910	7030003200	S.RES ERJ3GEYJ 100 V (10)	B	221.7/116.4
R911	7030003200	S.RES ERJ3GEYJ 100 V (10)	T	220.7/110.6
R912	7030003200	S.RES ERJ3GEYJ 100 V (10)	T	219.7/116.4
R913	7030003200	S.RES ERJ3GEYJ 100 V (10)	T	218.7/110.6
R914	7030003200	S.RES ERJ3GEYJ 100 V (10)	T	217.7/116.4
R915	7030003200	S.RES ERJ3GEYJ 100 V (10)	T	216.7/110.6
R916	7030003200	S.RES ERJ3GEYJ 100 V (10)	B	215.7/116.4
R917	7030003200	S.RES ERJ3GEYJ 100 V		

[LOGIC UNIT]

REF NO.	ORDER NO.	DESCRIPTION	M.	H/V LOCATION
R972	7030003860	S.RES ERJ3GE JPW V	B	59.1/11
R973	7030003860	S.RES ERJ3GE JPW V	B	58.1/5.1
R974	7030003860	S.RES ERJ3GE JPW V	B	52/14
R975	7030003200	S.RES ERJ3GEYJ 100 V (10)	T	59.9/13.4
R976	7030003200	S.RES ERJ3GEYJ 100 V (10)	T	58.6/13.4
R982	7030003200	S.RES ERJ3GEYJ 100 V (10)	T	49.5/13.4
R983	7030003200	S.RES ERJ3GEYJ 100 V (10)	T	46.9/13.4
R996	7030003200	S.RES ERJ3GEYJ 100 V (10)	T	44.3/13.4
R997	7030003860	S.RES ERJ3GE JPW V	T	33.5/8
R1016	7030003200	S.RES ERJ3GEYJ 100 V (10)	T	52.8/107.5
R1017	7030003200	S.RES ERJ3GEYJ 100 V (10)	T	54.1/107.5
R1018	7030003200	S.RES ERJ3GEYJ 100 V (10)	T	55.4/107.5
R1019	7030003200	S.RES ERJ3GEYJ 100 V (10)	T	56.7/107.5
R1020	7030003200	S.RES ERJ3GEYJ 100 V (10)	T	58/107.5
R1021	7030003200	S.RES ERJ3GEYJ 100 V (10)	T	59.3/107.5
R1022	7030003200	S.RES ERJ3GEYJ 100 V (10)	T	60.6/107.5
R1023	7030003200	S.RES ERJ3GEYJ 100 V (10)	T	61.9/107.5
R1025	7030003320	S.RES ERJ3GEYJ 101 V (100)	T	114.6/90.5
R1026	7030003320	S.RES ERJ3GEYJ 101 V (100)	B	116.4/101.2
R1027	7030003320	S.RES ERJ3GEYJ 101 V (100)	T	98.9/97.1
R1028	7030003320	S.RES ERJ3GEYJ 101 V (100)	B	95.9/88.6
R1029	7030003520	S.RES ERJ3GEYJ 472 V (4.7 k)	B	96.5/100
R1030	7030003520	S.RES ERJ3GEYJ 472 V (4.7 k)	B	99.1/100
R1031	7030003520	S.RES ERJ3GEYJ 472 V (4.7 k)	B	94.2/88.6
R1032	7030003520	S.RES ERJ3GEYJ 472 V (4.7 k)	B	99.1/88.6
R1033	7030003860	S.RES ERJ3GE JPW V	T	238.5/55.1
R1035	7030003540	S.RES ERJ3GEYJ 682 V (6.8 k)	B	229.8/59.3
R1041	7030003520	S.RES ERJ3GEYJ 472 V (4.7 k)	B	206.5/113.3
R1042	7030003550	S.RES ERJ3GEYJ 822 V (8.2 k)	B	104.7/96.8
R1052	7030008240	S.RES ERJ12Y0R00U	T	102.3/73.2
R1053	7030008240	S.RES ERJ12Y0R00U	T	269.3/36.4
R1054	7030008240	S.RES ERJ12Y0R00U	T	156.3/112.5
R1056	7030003860	S.RES ERJ3GE JPW V	T	230.7/97.2
R1057	7030003860	S.RES ERJ3GE JPW V	B	101.1/102.8
R1101	7030003200	S.RES ERJ3GEYJ 100 V (10)	T	28.3/89
R1102	7030003200	S.RES ERJ3GEYJ 100 V (10)	T	19.5/90
R1103	7030003200	S.RES ERJ3GEYJ 100 V (10)	T	19.5/92.2
R1104	7030003200	S.RES ERJ3GEYJ 100 V (10)	T	28.3/93
R1105	7030003200	S.RES ERJ3GEYJ 100 V (10)	T	19.5/94.6
R1106	7030003200	S.RES ERJ3GEYJ 100 V (10)	T	28.2/95
R1107	7030003200	S.RES ERJ3GEYJ 100 V (10)	T	19.5/96
R1108	7030003200	S.RES ERJ3GEYJ 100 V (10)	T	28.2/97
R1109	7030003200	S.RES ERJ3GEYJ 100 V (10)	T	19.5/98
R1110	7030003200	S.RES ERJ3GEYJ 100 V (10)	T	28.2/99
R1111	7030003200	S.RES ERJ3GEYJ 100 V (10)	T	19.5/100
R1112	7030003200	S.RES ERJ3GEYJ 100 V (10)	T	28.2/101
R1113	7030003200	S.RES ERJ3GEYJ 100 V (10)	T	19.5/103.4
R1115	7030003200	S.RES ERJ3GEYJ 100 V (10)	T	28.2/107.3
R1118	7030003440	S.RES ERJ3GEYJ 102 V (1 k)	T	5.6/94.5
R1119	7030003440	S.RES ERJ3GEYJ 102 V (1 k)	T	14.4/95.5
R1120	7030003440	S.RES ERJ3GEYJ 102 V (1 k)	T	5.6/96.5
R1121	7030003440	S.RES ERJ3GEYJ 102 V (1 k)	T	14.4/97.5
R1122	7030003440	S.RES ERJ3GEYJ 102 V (1 k)	T	5.6/98.5
R1125	7030003200	S.RES ERJ3GEYJ 100 V (10)	T	5.6/104.5
R1126	7030003200	S.RES ERJ3GEYJ 100 V (10)	T	14.4/103.5
R1127	7030003200	S.RES ERJ3GEYJ 100 V (10)	T	5.6/102.8
R1128	7030003200	S.RES ERJ3GEYJ 100 V (10)	T	5.6/106.5
R1129	7030003200	S.RES ERJ3GEYJ 100 V (10)	T	14.3/107.5
R1151	7030003290	S.RES ERJ3GEYJ 560 V (56)	B	11.2/30.4
R1152	7030003320	S.RES ERJ3GEYJ 101 V (100)	B	14.3/30.4
R1153	7030003320	S.RES ERJ3GEYJ 101 V (100)	B	16.9/29.6
R1154	7030003320	S.RES ERJ3GEYJ 101 V (100)	B	14.3/28.9
R1155	7030003320	S.RES ERJ3GEYJ 101 V (100)	B	16.9/28.1
R1156	7030003320	S.RES ERJ3GEYJ 101 V (100)	B	14.3/27.4
R1157	7030003320	S.RES ERJ3GEYJ 101 V (100)	B	16.9/26.6
R1158	7030003320	S.RES ERJ3GEYJ 101 V (100)	B	14.3/25.9
R1159	7030003320	S.RES ERJ3GEYJ 101 V (100)	B	16.9/25.1
R1160	7030003320	S.RES ERJ3GEYJ 101 V (100)	B	14.3/24.4
R1161	7030003320	S.RES ERJ3GEYJ 101 V (100)	B	16.9/23.6
R1162	7030003320	S.RES ERJ3GEYJ 101 V (100)	B	14.3/22.9
R1163	7030003320	S.RES ERJ3GEYJ 101 V (100)	B	16.9/22.1
R1164	7030003320	S.RES ERJ3GEYJ 101 V (100)	B	14.3/21.4
R1165	7030003320	S.RES ERJ3GEYJ 101 V (100)	B	16.9/20.6
R1166	7030003320	S.RES ERJ3GEYJ 101 V (100)	B	14.3/19.9
R1167	7030003320	S.RES ERJ3GEYJ 101 V (100)	B	16.9/19.1
R1168	7030003320	S.RES ERJ3GEYJ 101 V (100)	B	14.3/18.4
R1169	7030003320	S.RES ERJ3GEYJ 101 V (100)	B	16.9/17.6
R1170	7030003320	S.RES ERJ3GEYJ 101 V (100)	B	11.2/17.4
R2001	7030003860	S.RES ERJ3GE JPW V	T	278.3/72.9
R2051	7030003200	S.RES ERJ3GEYJ 100 V (10)	T	257.1/76.4
R2052	7030003620	S.RES ERJ3GEYJ 333 V (33 k)	T	257.1/82.6
R2053	7030003540	S.RES ERJ3GEYJ 682 V (6.8 k)	T	259/83.3
R2054	7030003640	S.RES ERJ3GEYJ 473 V (47 k)	T	258.2/87.5
R2055	7030003580	S.RES ERJ3GEYJ 153 V (15 k)	T	255.6/82.6
R2057	7030003860	S.RES ERJ3GE JPW V	T	274/84.6
R2058	7030003860	S.RES ERJ3GE JPW V	B	281.7/97.1
R2059	7030003860	S.RES ERJ3GE JPW V	B	281.7/103.8
R2101	7030003860	S.RES ERJ3GE JPW V	T	274.1/54.8
R2102	7030003860	S.RES ERJ3GE JPW V	T	274.1/52.4
R2201	7030003860	S.RES ERJ3GE JPW V	T	274.2/26.8
R2202	7030003860	S.RES ERJ3GE JPW V	T	274.2/24.4
R2203	7030003860	S.RES ERJ3GE JPW V	T	274.2/25.6
R2204	7030003860	S.RES ERJ3GE JPW V	T	274.2/22
R2205	7030003860	S.RES ERJ3GE JPW V	T	274.2/23.2
R2206	7030003860	S.RES ERJ3GE JPW V	T	274.2/20.8
R2207	7030003860	S.RES ERJ3GE JPW V	T	274.2/19.6
R2208	7030003860	S.RES ERJ3GE JPW V	T	274.2/18.4
R2209	7030003860	S.RES ERJ3GE JPW V	T	274.2/17.2
C1	4030011600	S.CER C1608 JB 1E 104K-T	T	84.8/42.4
C2	4030011600	S.CER C1608 JB 1E 104K-T	T	86.6/43.1
C3	4030011600	S.CER C1608 JB 1E 104K-T	T	91.4/43.1
C4	4030011600	S.CER C1608 JB 1E 104K-T	T	94/43.1

[LOGIC UNIT]

REF NO.	ORDER NO.	DESCRIPTION	M.	H/V LOCATION
C5	4030011600	S.CER C1608 JB 1E 104K-T	T	105.8/43.1
C6	4030011600	S.CER C1608 JB 1E 104K-T	T	93.8/57.5
C7	4030011600	S.CER C1608 JB 1E 104K-T	T	89/57.5
C8	4030011600	S.CER C1608 JB 1E 104K-T	T	84/27
C9	4030011600	S.CER C1608 JB 1E 104K-T	T	86.6/27
C10	4030011600	S.CER C1608 JB 1E 104K-T	T	91.4/27
C11	4030011600	S.CER C1608 JB 1E 104K-T	T	94/27
C12	4030011600	S.CER C1608 JB 1E 104K-T	T	105.8/27
C13	4030011600	S.CER C1608 JB 1E 104K-T	T	93.8/41.4
C14	4030011600	S.CER C1608 JB 1E 104K-T	T	89/41.4
C51	4030011600	S.CER C1608 JB 1E 104K-T	B	168.5/73.1
C52	4030011600	S.CER C1608 JB 1E 104K-T	B	178.2/84.3
C53	4030011600	S.CER C1608 JB 1E 104K-T	B	167.5/95.5
C54	4030011600	S.CER C1608 JB 1E 104K-T	T	143.7/78.8
C55	4030011600	S.CER C1608 JB 1E 104K-T	B	129.1/80.9
C56	4030011600	S.CER C1608 JB 1E 104K-T	B	129.9/87.6
C57	4030011600	S.CER C1608 JB 1E 104K-T	T	133.7/91.6
C58	4030011600	S.CER C1608 JB 1E 104K-T	T	136.7/91.6
C59	4030011600	S.CER C1608 JB 1E 104K-T	B	149.6/87.6
C60	4030011600	S.CER C1608 JB 1E 104K-T	B	150.3/81.9
C61	4030009990	S.CER C1608 CH 1H 200J-T	B	129.4/92.1
C62	4030011600	S.CER C1608 JB 1E 104K-T	B	17/58.8
C63	4030008890	S.CER C1608 JB 1H 273K-T	B	14.7/63.2
C64	4030011600	S.CER C1608 JB 1E 104K-T	B	19.9/60
C65	4030011600	S.CER C1608 JB 1E 104K-T	B	22.9/60.8
C66	4030011600	S.CER C1608 JB 1E 104K-T	T	263.7/68.6
C101	4030011600	S.CER C1608 JB 1E 104K-T	T	208.7/52.4
C102	4030011600	S.CER C1608 JB 1E 104K-T	B	149.4/29.7
C103	4030011600	S.CER C1608 JB 1E 104K-T	B	119.2/31.6
C104	4030011600	S.CER C1608 JB 1E 104K-T	B	138.5/32.5
C105	4030011600	S.CER C1608 JB 1E 104K-T	B	126.3/35.1
C106	4030011600	S.CER C1608 JB 1E 104K-T	B	139.8/32.5
C107	4030011600	S.CER C1608 JB 1E 104K-T	B	139.8/37.7
C108	4030011600	S.CER C1608 JB 1E 104K-T	B	139.8/42.9
C109	4030011600	S.CER C1608 JB 1E 104K-T	B	136.5/45.3
C110	4030011600	S.CER C1608 JB 1E 104K-T	B	129.3/32.5
C111	4550007520	S.TAN F931A106MAABMA	B	148.4/43.3
C112	4030011600	S.CER C1608 JB 1E 104K-T	B	146.8/44.6
C113	4550007520	S.TAN F931A106MAABMA	B	148.4/48.9
C114	4030011600	S.CER C1608 JB 1E 104K-T	B	146.8/47.7
C115	4550007520	S.TAN F931A106MAABMA	B	148.4/54
C116	4030011600	S.CER C1608 JB 1E 104K-T	B	146.8/50.8
C117	4030011600	S.CER C1608 JB 1E 104K-T	B	126.3/32.5
C118	4030011600	S.CER C1608 JB 1E 104K-T	B	135.9/32.5
C119	4030011600	S.CER C1608 JB 1E 104K-T	B	128/32.5
C120	4030011600	S.CER C1608 JB 1E 104K-T	B	127.9/45.3
C121	4030011600	S.CER C1608 JB 1E 104K-T	B	127.1/43.5
C122	4030011600	S.CER C1608 JB 1E 104K-T	B	127.1/42.2
C123	4030006860	S.CER C1608 JB 1H 102K-T	B	119.2/43.1
C124	4030011600	S.CER C1608 JB 1E 104K-T	B	126.3/37.7
C125	4030011600	S.CER C1608 JB 1E 104K-T	B	126.3/40.3
C126	4030011600	S.CER C1608 JB 1E 104K-T	B	130.6/32.5
C127	4030011600	S.CER C1608 JB 1E 104K-T	B	146.8/29.7
C128	4030011600	S.CER C1608 JB 1E 104K-T	B	146.8/38.5
C129	4030011600	S.CER C1608 JB 1E 104K-T	B	132.5/31.8
C130	4030011600	S.CER C1608 JB 1E 104K-T	B	130.5/45.3
C131	4030011600	S.CER C1608 JB 1E 104K-T	B	127.9/52.2
C132	4030011600	S.CER C1608 JB 1E 104K-T	B	133.7/45.3
C133	4030011600	S.CER C1608 JB 1E 104K-T	B	146.8/33.5
C134	4030011600	S.CER C1608 JB 1E 104K-T	B	139.5/25
C135	4030011600	S.CER C1608 JB 1E 104K-T	B	137.2/32.5
C136	4030011600	S.CER C1608 JB 1E 104K-T	B	139.8/40.3
C137	4030011600	S.CER C1608 JB 1E 104K-T	B	139.8/35.1
C138	4030011600	S.CER C1608 JB 1E 104K-T	B	128/40.3
C139	4030011600	S.CER C1608 JB 1E 104K-T	B	139.1/45.3
C140	4030006900	S.CER C1608 JB 1H 103K-T	B	139.1/52.2
C141	4030011600	S.CER C1608 JB 1E 104K-T	B	147.8/71.3
C142	4030011600	S.CER C1608 JB 1E 104K-T	T	147.1/71.9
C144	4030011600	S.CER C1608 JB 1E 104K-T	T	161.3/44.4
C145	4030007100	S.CER C1608 CH 1H 560J-T	T	158/46.2
C146	4030008560	S.CER C1608 CH 1H 300J-T	T	162.5/48
C147	4030007060	S.CER C1608 CH 1H 270J-T	T	162.5/49.2
C148	4030011600	S.CER C1608 JB 1E 104K-T	B	153.7/47.5
C149	4030011600	S.CER C1608 JB 1E 104K-T	T	161.3/43.2
C201	4030011600	S.CER C1608 JB 1E 104K-T	T	71.6/93.4
C202	4030011600	S.CER C1608 JB 1E 104K-T	T	71.6/90.8
C203	4030011600	S.CER C1608 JB 1E 104		

[LOGIC UNIT]

REF NO.	ORDER NO.	DESCRIPTION	M.	H/V LOCATION
C231	4030011600	S.CER C1608 JB 1E 104K-T	B	55.8/56.7
C232	4030011600	S.CER C1608 JB 1E 104K-T	B	58.4/45.8
C233	4030011600	S.CER C1608 JB 1E 104K-T	B	62.3/56.7
C234	4030011600	S.CER C1608 JB 1E 104K-T	B	66.8/53.6
C235	4030011600	S.CER C1608 JB 1E 104K-T	B	72.7/55.7
C236	4030011600	S.CER C1608 JB 1E 104K-T	B	57.1/56.7
C237	4030011600	S.CER C1608 JB 1E 104K-T	B	58.4/56.7
C238	4030011600	S.CER C1608 JB 1E 104K-T	B	59.7/56.7
C239	4030011600	S.CER C1608 JB 1E 104K-T	B	57.2/39.2
C240	4030011600	S.CER C1608 JB 1E 104K-T	B	63.6/56.7
C241	4030011600	S.CER C1608 JB 1E 104K-T	B	64.9/56.7
C242	4030011600	S.CER C1608 JB 1E 104K-T	B	66.8/57.5
C243	4030011600	S.CER C1608 JB 1E 104K-T	B	66.8/56.2
C244	4030011600	S.CER C1608 JB 1E 104K-T	B	61/45.8
C245	4030011600	S.CER C1608 JB 1E 104K-T	B	56.1/46.3
C246	4030011600	S.CER C1608 JB 1E 104K-T	B	61/56.7
C247	4030011600	S.CER C1608 JB 1E 104K-T	B	56.1/53.6
C248	4030011600	S.CER C1608 JB 1E 104K-T	B	66.8/54.9
C249	4030011600	S.CER C1608 JB 1E 104K-T	B	66.8/47.6
C250	4030007050	S.CER C1608 CH 1H 220J-T	T	46.1/55.4
C251	4030007050	S.CER C1608 CH 1H 220J-T	T	46.1/52.8
C252	4030006990	S.CER C1608 CH 1H 080D-T	T	77.1/51
C253	4030006990	S.CER C1608 CH 1H 080D-T	T	77.1/53.6
C254	4030006900	S.CER C1608 JB 1H 103K-T	T	51.8/37.3
C255	4510008520	S.ELE EEE1CA470SP	T	44.4/38
C256	4030006900	S.CER C1608 JB 1H 103K-T	T	72.6/37.1
C257	4510007130	S.ELE EEFCD 0J 470R	T	75/33.9
C258	4030011600	S.CER C1608 JB 1E 104K-T	T	78.3/37.5
C259	4030011600	S.CER C1608 JB 1E 104K-T	B	61.3/39.8
C260	4030011600	S.CER C1608 JB 1E 104K-T	B	83.1/5.5
C261	4030011600	S.CER C1608 JB 1E 104K-T	B	84.3/5.5
C262	4030011600	S.CER C1608 JB 1E 104K-T	B	82/14
C263	4030011600	S.CER C1608 JB 1E 104K-T	B	82/12.8
C264	4030011600	S.CER C1608 JB 1E 104K-T	B	75/15.2
C265	4510008540	S.ELE EEE1CA100SR	T	80.8/4.8
C266	4030011600	S.CER C1608 JB 1E 104K-T	B	81.7/18.6
C267	4030007100	S.CER C1608 CH 1H 560J-T	B	93.6/11
C268	4030007100	S.CER C1608 CH 1H 560J-T	B	93.6/13.8
C269	4030007100	S.CER C1608 CH 1H 560J-T	B	89.8/16.5
C270	4030007050	S.CER C1608 CH 1H 220J-T	B	98.5/10.7
C271	4030007050	S.CER C1608 CH 1H 220J-T	B	98.5/13.8
C272	4030007050	S.CER C1608 CH 1H 220J-T	B	98.5/16.7
C273	4030011600	S.CER C1608 JB 1E 104K-T	B	103.3/8.2
C274	4030007170	S.CER C1608 CH 1H 221J-T	B	115.5/6.6
C275	4030007170	S.CER C1608 CH 1H 221J-T	B	116.4/4
C276	4030007050	S.CER C1608 CH 1H 220J-T	B	147/2.4
C277	4030007050	S.CER C1608 CH 1H 220J-T	B	14/67.4
C278	4510008500	S.ELE EEE1CA101WP	T	15.4/68.7
C279	4030007050	S.CER C1608 CH 1H 220J-T	B	14/80
C280	4030007050	S.CER C1608 CH 1H 220J-T	B	14/75
C281	4510008500	S.ELE EEE1CA101WP	T	15.4/77.3
C283	4510008550	S.ELE EEE1HA010SR	T	22.4/80.6
C284	4030011600	S.CER C1608 JB 1E 104K-T	B	92/84.2
C285	4510008540	S.ELE EEE1CA100SR	T	92.3/83.6
C286	4510008540	S.ELE EEE1CA100SR	T	97/83.6
C287	4030011600	S.CER C1608 JB 1E 104K-T	B	95.7/84.2
C288	4510008540	S.ELE EEE1CA100SR	T	97/77.6
C289	4030011600	S.CER C1608 JB 1E 104K-T	B	94.5/84.2
C290	4030011600	S.CER C1608 JB 1E 104K-T	B	101.7/84.2
C291	4510008540	S.ELE EEE1CA100SR	T	101.7/83.6
C292	4510008540	S.ELE EEE1CA100SR	T	106.4/83.6
C293	4030011600	S.CER C1608 JB 1E 104K-T	B	104/84.2
C294	4510008540	S.ELE EEE1CA100SR	T	106.6/77.6
C295	4030011600	S.CER C1608 JB 1E 104K-T	B	105.2/84.2
C296	4030011600	S.CER C1608 JB 1E 104K-T	B	112.5/84.2
C297	4510008540	S.ELE EEE1CA100SR	T	111.6/77.6
C298	4030011600	S.CER C1608 JB 1E 104K-T	B	110.6/84.2
C299	4510008540	S.ELE EEE1CA100SR	T	111.1/83.6
C300	4030011600	S.CER C1608 JB 1E 104K-T	B	118/84.2
C301	4510008540	S.ELE EEE1CA100SR	T	116.6/77.6
C302	4030011600	S.CER C1608 JB 1E 104K-T	B	116.4/84.2
C303	4510008540	S.ELE EEE1CA100SR	T	115.8/83.6
C422	4030011600	S.CER C1608 JB 1E 104K-T	T	168.9/44.8
C423	4030011600	S.CER C1608 JB 1E 104K-T	B	184.6/30.6
C424	4030011600	S.CER C1608 JB 1E 104K-T	B	178.1/30.6
C425	4030011600	S.CER C1608 JB 1E 104K-T	B	173.1/30.6
C426	4030011600	S.CER C1608 JB 1E 104K-T	B	166.8/38.9
C427	4030011600	S.CER C1608 JB 1E 104K-T	B	166.8/44.8
C428	4030011600	S.CER C1608 JB 1E 104K-T	B	166.8/46
C429	4030011600	S.CER C1608 JB 1E 104K-T	T	191.3/57.8
C430	4030011600	S.CER C1608 JB 1E 104K-T	T	192.5/57.8
C431	4030011600	S.CER C1608 JB 1E 104K-T	B	177.5/53.7
C432	4030011600	S.CER C1608 JB 1E 104K-T	B	184.1/53.7
C433	4030011600	S.CER C1608 JB 1E 104K-T	B	186.5/53.7
C434	4030011600	S.CER C1608 JB 1E 104K-T	B	195.3/46.7
C435	4030011600	S.CER C1608 JB 1E 104K-T	B	195.3/45.2
C436	4030011600	S.CER C1608 JB 1E 104K-T	B	195.3/40.2
C437	4030011600	S.CER C1608 JB 1E 104K-T	T	262.6/42.2
C438	4030011600	S.CER C1608 JB 1E 104K-T	T	268/43.1
C439	4030011600	S.CER C1608 JB 1E 104K-T	T	249.4/51.6
C440	4010008500	CER DEBB3D102KA2B		
C601	4030011600	S.CER C1608 JB 1E 104K-T	T	254.7/65.1
C602	4030011600	S.CER C1608 JB 1E 104K-T	T	253.5/63.9
C603	4030011600	S.CER C1608 JB 1E 104K-T	B	212.4/69.5
C604	4030011600	S.CER C1608 JB 1E 104K-T	B	202.7/92
C605	4030011600	S.CER C1608 JB 1E 104K-T	B	183.7/89.7
C606	4030011600	S.CER C1608 JB 1E 104K-T	B	183.7/71.9
C607	4030011600	S.CER C1608 JB 1E 104K-T	B	183.7/70.5
C608	4510008540	S.ELE EEE1CA100SR	T	210.1/89.7
C609	4510008540	S.ELE EEE1CA100SR	T	214.8/89.7
C610	4030006900	S.CER C1608 JB 1H 103K-T	B	211.9/88.1
C611	4030006900	S.CER C1608 JB 1H 103K-T	B	213.2/88.1
C612	4030007010	S.CER C1608 CH 1H 100D-T	T	202.7/91.3
C613	4030007010	S.CER C1608 CH 1H 100D-T	T	200.1/91.3

[LOGIC UNIT]

REF NO.	ORDER NO.	DESCRIPTION	M.	H/V LOCATION
C614	4030011600	S.CER C1608 JB 1E 104K-T	B	197.3/92
C615	4030006880	S.CER C1608 JB 1H 472K-T	T	215.3/76.7
C616	4030006880	S.CER C1608 JB 1H 472K-T	T	215.3/77.9
C617	4030006880	S.CER C1608 JB 1H 472K-T	T	215.3/79.1
C618	4030006880	S.CER C1608 JB 1H 472K-T	T	215.3/80.3
C619	4030006880	S.CER C1608 JB 1H 472K-T	T	215.3/81.5
C620	4030006880	S.CER C1608 JB 1H 472K-T	T	215.3/82.7
C621	4030006880	S.CER C1608 JB 1H 472K-T	T	215.3/83.9
C622	4030006880	S.CER C1608 JB 1H 472K-T	T	215.3/85.1
C623	4510008540	S.ELE EEE1CA100SR	T	226/67.5
C624	4030011600	S.CER C1608 JB 1E 104K-T	B	223.4/69.9
C625	4510008540	S.ELE EEE1CA100SR	T	221.2/67.5
C626	4030011600	S.CER C1608 JB 1E 104K-T	B	210.4/62.9
C627	4030011600	S.CER C1608 JB 1E 104K-T	B	216.1/62.9
C628	4030011600	S.CER C1608 JB 1E 104K-T	T	175.1/57.2
C629	4030011600	S.CER C1608 JB 1E 104K-T	T	199.5/64.3
C630	4030011600	S.CER C1608 JB 1E 104K-T	T	170.8/92.8
C631	4030011600	S.CER C1608 JB 1E 104K-T	T	186.6/98
C632	4030011600	S.CER C1608 JB 1E 104K-T	T	186.6/104
C633	4030011600	S.CER C1608 JB 1E 104K-T	T	183.1/114.5
C634	4030011600	S.CER C1608 JB 1E 104K-T	T	178.5/114.5
C635	4030011600	S.CER C1608 JB 1E 104K-T	T	164.5/106.4
C636	4030011600	S.CER C1608 JB 1E 104K-T	T	164.5/99
C801	4510008540	S.ELE EEE1CA100SR	T	28.3/39.3
C802	4030011600	S.CER C1608 JB 1E 104K-T	T	23.4/48.3
C803	4030011600	S.CER C1608 JB 1E 104K-T	T	20.4/48.3
C804	4510008520	S.ELE EEE1CA470SP	T	14.3/40.3
C805	4510008870	S.ELE EEE1AA471UP	T	191.2/37
C806	4510008870	S.ELE EEE1AA471UP	T	182.4/25.4
C807	4510008870	S.ELE EEE1AA471UP	T	168.9/17.9
C808	4510008870	S.ELE EEE1AA471UP	T	189.2/5.6
C809	4510008560	S.ELE EEE1HAR47SR	T	244.1/87.2
C810	4510008560	S.ELE EEE1HAR47SR	T	244.1/80.1
C811	4510008870	S.ELE EEE1AA471UP	T	185.3/16.4
C816	4030006860	S.CER C1608 JB 1H 102K-T	T	205/31.1
C817	4030006860	S.CER C1608 JB 1H 102K-T	T	203/24.1
C818	4030006860	S.CER C1608 JB 1H 102K-T	T	205.4/18
C819	4030006860	S.CER C1608 JB 1H 102K-T	T	218.5/17.5
C820	4030006860	S.CER C1608 JB 1H 102K-T	T	218.5/14.8
C821	4510008520	S.ELE EEE1CA470SP	T	14.5/14.3
C822	4510008500	S.ELE EEE1CA101WP	T	255.9/23.7
C823	4030006880	S.CER C1608 JB 1H 472K-T	T	250/27.3
C825	4030011600	S.CER C1608 JB 1E 104K-T	T	240.8/40.3
C826	4030006860	S.CER C1608 JB 1H 102K-T	T	2.5/54.5
C827	4030006860	S.CER C1608 JB 1H 102K-T	T	2.5/57.1
C828	4030007130	S.CER C1608 CH 1H 101J-T	T	2.5/58.4
C829	4030006860	S.CER C1608 JB 1H 102K-T	T	2.5/51.5
C830	4030007130	S.CER C1608 CH 1H 101J-T	T	2.5/52.8
C831	4030006860	S.CER C1608 JB 1H 102K-T	T	2.5/48.9
C832	4030007130	S.CER C1608 CH 1H 101J-T	T	2.5/50.2
C833	4030006860	S.CER C1608 JB 1H 102K-T	T	2.5/45
C834	4030007130	S.CER C1608 CH 1H 101J-T	T	2.5/46.3
C835	4030011600	S.CER C1608 JB 1E 104K-T	T	20.4/52.6
C836	4510008540	S.ELE EEE1CA100SR	T	16.5/56.6
C837	4030011600	S.CER C1608 JB 1E 104K-T	T	23.4/52.6
C838	4510008540	S.ELE EEE1CA100SR	T	27.4/56.5
C850	4030011600	S.CER C1608 JB 1E 104K-T	T	54.9/102.5
C851	4510008540	S.ELE EEE1CA100SR	T	110.9/90.3
C852	4030009490	S.CER C1608 JB 1H 821K-T	B	113.3/88.2
C853	4030009490	S.CER C1608 JB 1H 821K-T	B	110/90.1
C855	4510008540	S.ELE EEE1CA100SR	T	118.3/90.2
C856	4030009490	S.CER C1608 JB 1H 821K-T	B	115.8/88.2
C857	4030009490	S.CER C1608 JB 1H 821K-T	B	119.2/90.1
C865	4510008540	S.ELE EEE1CA100SR	T	95.2/96.6
C866	4030007160	S.CER C1608 CH 1H 181J-T	B	101.1/100.4
C867	4030009880	S.CER C1608 JB 1H 682K-T	B	104/95
C868	4030008880	S.CER C1608 JB 1H 223K-T	B	104.7/98
C869	4510008540	S.ELE EEE1CA100SR	T	88.9/91.2
C871	4510008540	S.ELE EEE1CA100SR	T	103.2/91.2
C873	4030011600	S.CER C1608 JB 1E 104K-T	B	114.6/90.5
C874	4030011600	S.CER C1608 JB 1E 104K-T	B	114.5/101.9
C875	4510008540	S.ELE EEE1CA100SR	T	112.2/95.8
C876	4510008540	S.ELE EEE1CA100SR	T	116.9/95.8
C877	4030011600	S.CER C1608 JB 1E 104K-T	B	97.8/100
C878	4030011600	S.CER C1608 JB 1E 104K-T	B	97.2/88.6
C879</				

[LOGIC UNIT]

REF NO.	ORDER NO.	DESCRIPTION	M.	H/V LOCATION
C936	4030006860	S.CER C1608 JB 1H 102K-T	B	223.7/106.1
C937	4030006860	S.CER C1608 JB 1H 102K-T	T	222.7/94.6
C938	4030006860	S.CER C1608 JB 1H 102K-T	B	217.7/106.1
C939	4030006860	S.CER C1608 JB 1H 102K-T	T	216.7/94.6
C940	4030006860	S.CER C1608 JB 1H 102K-T	B	215.7/106.1
C941	4030006860	S.CER C1608 JB 1H 102K-T	T	214.7/94.6
C942	4030006860	S.CER C1608 JB 1H 102K-T	B	213.7/106.1
C943	4030006860	S.CER C1608 JB 1H 102K-T	T	212.8/94.6
C944	4030006860	S.CER C1608 JB 1H 102K-T	B	211.7/106.1
C945	4030006860	S.CER C1608 JB 1H 102K-T	T	211.5/94.6
C946	4030006860	S.CER C1608 JB 1H 102K-T	B	209.7/106.1
C947	4030006860	S.CER C1608 JB 1H 102K-T	T	59.9/16.2
C948	4030006860	S.CER C1608 JB 1H 102K-T	T	58.6/16.2
C949	4030006860	S.CER C1608 JB 1H 102K-T	T	57.3/16.2
C950	4030006860	S.CER C1608 JB 1H 102K-T	T	49.5/16.2
C951	4030006860	S.CER C1608 JB 1H 102K-T	T	46.9/16.2
C952	4030006860	S.CER C1608 JB 1H 102K-T	T	68.2/5.3
C953	4030006860	S.CER C1608 JB 1H 102K-T	B	59.5/8.7
C954	4030006860	S.CER C1608 JB 1H 102K-T	B	58/2.5
C955	4030006860	S.CER C1608 JB 1H 102K-T	B	49.6/13.3
C963	4030006860	S.CER C1608 JB 1H 102K-T	T	28.2/103.4
C964	4030006860	S.CER C1608 JB 1H 102K-T	T	19.5/104.7
C965	4030006860	S.CER C1608 JB 1H 102K-T	T	28.2/106
C966	4030006860	S.CER C1608 JB 1H 102K-T	T	19.5/109.3
C967	4030006860	S.CER C1608 JB 1H 102K-T	T	28.2/110.3
C968	4030006860	S.CER C1608 JB 1H 102K-T	T	16.5/101.1
C969	4030006860	S.CER C1608 JB 1H 102K-T	T	5.6/101.5
C970	4030006860	S.CER C1608 JB 1H 102K-T	T	5.6/107.8
C971	4030006860	S.CER C1608 JB 1H 102K-T	T	14.3/106.2
C977	4030006860	S.CER C1608 JB 1H 102K-T	T	51.5/107.5
C979	4030006860	S.CER C1608 JB 1H 102K-T	T	71.4/117.1
C980	4030006860	S.CER C1608 JB 1H 102K-T	T	71.4/112.1
C991	4030006880	S.CER C1608 JB 1H 472K-T	T	43.5/2.7
C998	4030006880	S.CER C1608 JB 1H 472K-T	T	33.4/4.9
C999	4030006860	S.CER C1608 JB 1H 102K-T	T	33.7/10.2
C1001	4030006880	S.CER C1608 JB 1H 472K-T	T	15.1/100.9
C1002	4030006880	S.CER C1608 JB 1H 472K-T	T	98.9/100.4
C2051	4030011600	S.CER C1608 JB 1E 104K-T	T	262/82.3
C2052	4030011600	S.CER C1608 JB 1E 104K-T	B	264.9/101.4
C2053	4030011600	S.CER C1608 JB 1E 104K-T	T	265/95.7
C2054	4030008680	S.CER C2012 JF 1C 105Z-T	T	270.5/89.5
C2055	4030008680	S.CER C2012 JF 1C 105Z-T	T	273.6/88.5
C2056	4030008680	S.CER C2012 JF 1C 105Z-T	T	279.9/91.2
C2057	4030008680	S.CER C2012 JF 1C 105Z-T	T	279.9/95
C2058	4030008680	S.CER C2012 JF 1C 105Z-T	T	274.6/100.7
J1	6510022490	S.CNR AXK5S30045P	T	94/19.9
J2	6510019870	S.CNR AXK5S40045P	T	94/64.9
J52	6510023261	S.CNR B6B-PH-SM4-TB (LF) (SN)	T	153.9/103.6
J102	6510019981	S.CNR 52808-1671 (1690)	T	153.6/65
J602	6510019971	S.CNR 52808-1071	T	218.9/57
J604	6510019971	S.CNR 52808-1071	T	224.1/82
J804	6510022031	S.CNR B10B-ZR-SM4-TF (LF) (SN)	T	6.2/72
J805	6510020081	S.CNR 52808-2071 (2090)	T	6.8/48
J806	6510022471	S.CNR 40FLT-SM2-TB (LF) (SN)	T	6.9/21.1
J808	6510020001	S.CNR 52808-3071 (3090)	T	217.2/114.8
J809	6510020001	S.CNR 52808-3071 (3090)	T	217.2/101.7
J810	6510020251	S.CNR B9B-PH-SM4-TB (LF) (SN)	T	113.9/115.9
J811	6510021561	S.CNR 52808-2470 (2490)	T	50/6.8
J813	6510019991	S.CNR 52808-2271 (2291)	T	23.9/99.5
J814	6510019981	S.CNR 52808-1671 (1690)	T	10/101
J816	6510019981	S.CNR 52808-1671 (1690)	T	60.2/112.4
J820	6510022801	S.CNR B10B-PH-SM4-TB (LF) (SN)	T	232.5/23.3
J821	6510020251	S.CNR B9B-PH-SM4-TB (LF) (SN)	T	214.8/22.3
J824	6510018971	S.CNR B4B-PH-SM4-TB (LF) (SN)	T	244.6/21.7
J826	6510015541	S.CNR B4B-ZR-SM4-TF (LF) (SN)	T	81.6/115.8
J2001	6510023720	CNR LGY6501-0600C		
J2052	6510023120	CNR CD6109SA1J0 <CVI>		
J2101	6510024040	CNR TM11R-5M2-88-LP		
J2201	6450001941	CNR KEY-15S-2A3A (LF) (SN)		
DS403	5040002930	S.LED SML-512MW T86	T	187.7/53.7
DS491	5040002930	S.LED SML-512MW T86	T	282.5/46.4
DS492	5040002930	S.LED SML-512MW T86	T	282.5/57.5
S51	2260002740	S.SW LS8J2M-T	T	15.9/62.2
T401	5920000841	S.TSM H1102NL	T	259.2/49.4
EP102	6910013310	S.BEA MMZ1608D121B	T	159.4/33.3
EP103	6910013310	S.BEA MMZ1608D121B	T	158.2/33.3
EP201	6910012350	S.BEA MMZ1608Y 102BT	B	81.7/21.3
EP202	6910012350	S.BEA MMZ1608Y 102BT	B	81.7/19.8
EP203	6910012350	S.BEA MMZ1608Y 102BT	T	50.6/37.3
EP204	6910012350	S.BEA MMZ1608Y 102BT	T	69.6/35.4
EP401	6910013310	S.BEA MMZ1608D121B	T	184.1/53.7
EP402	6910013310	S.BEA MMZ1608D121B	T	177.5/53.7
EP403	6910013310	S.BEA MMZ1608D121B	T	186.5/53.7
EP801	6910013310	S.BEA MMZ1608D121B	B	5.7/30.4
EP802	6910013310	S.BEA MMZ1608D121B	B	8/29.4
EP803	6910013310	S.BEA MMZ1608D121B	B	11.2/28.9
EP804	6910013310	S.BEA MMZ1608D121B	B	5.7/28.4
EP805	6910013310	S.BEA MMZ1608D121B	B	8/27.4
EP806	6910013310	S.BEA MMZ1608D121B	B	11.2/26.9
EP807	6910013310	S.BEA MMZ1608D121B	B	5.7/26.4
EP808	6910013310	S.BEA MMZ1608D121B	B	8/25.4
EP809	6910013310	S.BEA MMZ1608D121B	B	11.2/24.9
EP810	6910013310	S.BEA MMZ1608D121B	B	5.7/24.4
EP811	6910013310	S.BEA MMZ1608D121B	B	8/23.4

[LOGIC UNIT]

REF NO.	ORDER NO.	DESCRIPTION	M.	H/V LOCATION
EP812	6910013310	S.BEA MMZ1608D121B	B	11.2/22.9
EP813	6910013310	S.BEA MMZ1608D121B	B	5.7/22.4
EP814	6910013310	S.BEA MMZ1608D121B	B	8/21.4
EP815	6910013310	S.BEA MMZ1608D121B	B	11.2/20.9
EP816	6910013310	S.BEA MMZ1608D121B	B	5.7/20.4
EP817	6910013310	S.BEA MMZ1608D121B	B	8/19.4
EP818	6910013310	S.BEA MMZ1608D121B	B	11.2/18.9
EP819	6910013310	S.BEA MMZ1608D121B	B	5.7/18.4
EP820	6910013310	S.BEA MMZ1608D121B	B	8/17.4
EP821	6910015980	S.BEA MMZ1608S 181CT-AS	T	224.4/28.9
EP822	6910015980	S.BEA MMZ1608S 181CT-AS	T	224.4/27.7
EP824	6910014730	S.BEA MPZ2012S331A-T	T	12/50.5
EP825	6910014730	S.BEA MPZ2012S331A-T	T	12/46.5
EP826	6910012350	S.BEA MMZ1608Y 102BT	B	12.5/44.5
EP827	6910012350	S.BEA MMZ1608Y 102BT	B	12.5/41.8
EP828	6910012350	S.BEA MMZ1608Y 102BT	B	12.5/40.5
EP829	6910012350	S.BEA MMZ1608Y 102BT	B	12.5/43.2
EP832	6910014730	S.BEA MPZ2012S331A-T	T	224.1/25.6
EP833	6910014730	S.BEA MPZ2012S331A-T	T	224.1/23.9
EP834	6910014730	S.BEA MPZ2012S331A-T	T	208.5/15.8
EP835	6910014730	S.BEA MPZ2012S331A-T	T	206.8/15.8
EP836	6910014730	S.BEA MPZ2012S331A-T	T	224.1/20.3
EP837	6910014730	S.BEA MPZ2012S331A-T	T	224.1/16.2
EP838	6910014730	S.BEA MPZ2012S331A-T	T	12/57.5
EP839	6910014730	S.BEA MPZ2012S331A-T	T	12/53.5
EP840	6910014730	S.BEA MPZ2012S331A-T	T	12/55.7
EP851	6910015970	S.BEA MMZ1608B 301CT-AS	T	107.9/109.4
EP852	6910015970	S.BEA MMZ1608B 301CT-AS	T	111.9/109.4
EP853	6910015970	S.BEA MMZ1608B 301CT-AS	T	115.9/109.4
EP854	6910015970	S.BEA MMZ1608B 301CT-AS	T	119.9/109.4
EP901	6910014730	S.BEA MPZ2012S331A-T	T	65.6/7.9
EP902	6910014730	S.BEA MPZ2012S331A-T	B	57.1/11.1
EP903	6910014730	S.BEA MPZ2012S331A-T	B	55.1/15.1
EP904	6910014730	S.BEA MPZ2012S331A-T	B	54.2/11.9
EP905	6910014730	S.BEA MPZ2012S331A-T	T	35.4/5.9
EP907	6910015980	S.BEA MMZ1608S 181CT-AS	T	57.3/13.4
EP908	6910015980	S.BEA MMZ1608S 181CT-AS	T	56/13.4
EP909	6910015980	S.BEA MMZ1608S 181CT-AS	T	54.7/13.4
EP910	6910015980	S.BEA MMZ1608S 181CT-AS	T	53.4/13.4
EP911	6910015980	S.BEA MMZ1608S 181CT-AS	T	52.1/13.4
EP912	6910015980	S.BEA MMZ1608S 181CT-AS	T	50.8/13.4
EP918	6910014730	S.BEA MPZ2012S331A-T	T	71.8/115.5
EP919	6910014730	S.BEA MPZ2012S331A-T	T	71.8/113.7
EP920	6910014730	S.BEA MPZ2012S331A-T	T	64.7/107.7
EP932	6910014690	S.BEA MPZ1608S221A-T	T	229.7/106.1
EP933	6910014690	S.BEA MPZ1608S221A-T	T	228.7/97.2
EP972	6910015970	S.BEA MMZ1608B 301CT-AS	T	79.3/110.1
EP973	6910015970	S.BEA MMZ1608B 301CT-AS	T	82.1/109.9
EP1113	6910014690	S.BEA MPZ1608S221A-T	T	28.2/104.7
EP1114	6910014690	S.BEA MPZ1608S221A-T	T	19.5/106
EP1116	6910014690	S.BEA MPZ1608S221A-T	T	19.5/108
EP1117	6910014690	S.BEA MPZ1608S221A-T	T	28.2/109
EP1123	6910015970	S.BEA MMZ1608B 301CT-AS	T	14.4/98.8
EP1124	6910015970	S.BEA MMZ1608B 301CT-AS	T	5.6/100.2
EP2001	6910012350	S.BEA MMZ1608Y 102BT	T	276.2/70.7
EP2002	6910012350	S.BEA MMZ1608Y 102BT	T	276.2/72.1
EP2051	6910014730	S.BEA MPZ2012S331A-T	T	256.3/98.1

[MEMORY BOARD]

REF NO.	ORDER NO.	DESCRIPTION	M.	H/V LOCATION
IC1	1130014294	S.IC JS28F128J3D-75(SX-3009A-5)		
IC2	1130013480	S.IC JS28F128J3D-75		
C1	4030011600	S.CER C1608 JB 1E 104K-T		
C2	4030011600	S.CER C1608 JB 1E 104K-T		
C3	4030011600	S.CER C1608 JB 1E 104K-T		
C4	4030011600	S.CER C1608 JB 1E 104K-T		
C5	4030011600	S.CER C1608 JB 1E 104K-T		
C6	4030011600	S.CER C1608 JB 1E 104K-T		
J1	6510024410	S.CNR AXK6S30545		
J2	6510020120	S.CNR AXK6S40545P		

M.=Mounted side (T: Mounted on the Top side B: Mounted on the Bottom side)
S.=Surface mount

[PA200W BOARD]

REF NO.	ORDER NO.	DESCRIPTION	M.	H/V LOCATION
IC2	1180001541	S.IC TA78L08F (TE12L,F)	T	58.8/15.1
Q1	1520000531	S.TR 2SB1119S-TD-E	T	42.8/19.2
Q2	1590000680	S.TR DTC114EUA T106	T	45.8/13.5
Q101	1560001241	S.FET RD01MUS1-T113	T	5.9/66.4
Q201	1590003051	S.FET PDS5003-E	T	20.5/53.1
Q301	1590003840	FET MRF148A	T	64/45.8
Q401	1560001211	FET MRF150 (SRFJ150MP) M/A		
D1	1730000561	S.ZEN RD2.7M-T2B-A B1	T	100.6/22.8
D401	1750000271	S.DIO 1SS301 (TE85L,F)	T	116.8/99.1
D402	1750000271	S.DIO 1SS301 (TE85L,F)	T	118.3/35.9
D403	1750000271	S.DIO 1SS301 (TE85L,F)	T	104/98.3
D404	1750000271	S.DIO 1SS301 (TE85L,F)	T	104/35.7
D551	1790000491	S.DIO HSM88ASTR-E	T	150.1/35.3
L1	6200005011	S.COL NLV25T-100J	T	14.7/18
L2	6200005011	S.COL NLV25T-100J	T	14.7/20.5
L3	6200005011	S.COL NLV25T-100J	T	14.7/23
L4	6200005011	S.COL NLV25T-100J	T	14.7/29
L6	6200005011	S.COL NLV25T-100J	T	14.7/25.5
L7	6200010881	S.COL CDRH124NP-330MC	T	77.3/11
L101	6200005131	S.COL NLC453232T-101K-PF	T	5.6/59.6
L102	6200007220	S.COL EXCLL4532U1	T	6/38.4
L201	6180001240	COL LAL 04NA 820K		
L202	6140004350	COL LR-475		
L301	6200003261	S.COL NLV32T-101J	T	46.1/36.4
L303	6200001831	S.COL NLV32T-100J	T	86.9/26.2
L304	2040000490	COL EXC-ELDR25C		
L305	2040000490	COL EXC-ELDR25C		
L306	6140004340	COL LR-474		
L307	6200001831	S.COL NLV32T-100J	T	75.7/100.2
L401	6200003261	S.COL NLV32T-101J	T	100.4/98.3
L402	6200003261	S.COL NLV32T-101J	T	100.1/35.8
L403	6140002590	COL LR-296 (TR18X8X8 D12A)		
L404	6140000720	COL LR-95	T	166.4/67
L501	6140002030	COL LR-230 (SK-10M-15Y 120)		
R1	7030003440	S.RES ERJ3GEYJ 102 V (1 k)	T	42.8/12.8
R2	7030003560	S.RES ERJ3GEYJ 103 V (10 k)	T	42.8/14.2
R3	7510001740	TMR DTN-C103F3H-STS-40		
R4	7030000380	S.RES MCR10EZHHJ 1 k	T	39.7/22.5
R5	7030008061	S.RES ERA3YED 222V (2.2 k)	T	104.3/23.1
R6	7030007210	S.RES ERA3YEB 102V (1 k)	T	103.6/16.5
R7	7030007210	S.RES ERA3YEB 102V (1 k)	T	103.6/17.8
R101	7030003370	S.RES ERJ3GEYJ 271 V (270)	T	6/87.2
R102	7030003220	S.RES ERJ3GEYJ 150 V (15)	T	3.9/86.1
R103	7030003370	S.RES ERJ3GEYJ 271 V (270)	T	6/85
R104	7030003360	S.RES ERJ3GEYJ 221 V (220)	T	4.8/71.3
R105	7030003430	S.RES ERJ3GEYJ 821 V (820)	T	6/73.3
R106	7030003480	S.RES ERJ3GEYJ 222 V (2.2 k)	T	9.2/73.8
R107	7030003440	S.RES ERJ3GEYJ 102 V (1 k)	T	2.2/64.7
R108	7030003200	S.RES ERJ3GEYJ 100 V (10)	T	9.2/68.3
R110	7030000230	S.RES MCR10EZHHJ 56 (560)	T	11.3/56.6
R111	7030003420	S.RES ERJ3GEYJ 681 V (680)	T	13.3/58.6
R112	7030003510	S.RES ERJ3GEYJ 392 V (3.9 k)	T	12.6/60.6
R113	7030003500	S.RES ERJ3GEYJ 332 V (3.3 k)	T	6.8/75.2
R115	7030003520	S.RES ERJ3GEYJ 472 V (4.7 k)	T	13.1/40.8
R117	7030003530	S.RES ERJ3GEYJ 562 V (5.6 k)	T	7.7/76.5
R118	7030003550	S.RES ERJ3GEYJ 822 V (8.2 k)	T	11.7/40.8
R119	7030008240	S.RES ERJ12Y0R00U	T	5/49.6
R201	7030004050	S.RES ERJ3GEYJ 1R0 V (1)	T	13.8/48.6
R202	7030003410	S.RES ERJ3GEYJ 561 V (560)	T	23.1/43.1
R203	7030010800	S.RES ERJ1TYJ 2R7U (2.7)	T	18.4/65.5
R205	7030006260	S.RES ERJ12YJ471U (470)	T	30.3/55.7
R301	7310005210	TRI VM5CK-PVB 20 k		
R302	7030008180	S.RES ERJ12YJ331U (330)	T	48.3/40.6
R305	7030003530	S.RES ERJ3GEYJ 562 V (5.6 k)	T	49.6/43.5
R307	7070000830	RES ERG3SJ 101 (100)		
R309	7030010570	S.RES ERJ1TYJ 4R7U (4.7)	T	80/45.8
R310	7310005200	TRI VM5CK-PVB 2 k		
R312	7070000830	RES ERG3SJ 101 (100)		
R401	7030010960	S.RES ERJ1TYJ 120U (12)	T	89.8/90.7
R402	7030010960	S.RES ERJ1TYJ 120U (12)	T	93.5/90.7
R403	7030010960	S.RES ERJ1TYJ 120U (12)	T	97.2/90.7
R404	7030010960	S.RES ERJ1TYJ 120U (12)	T	90.8/43.3
R405	7030010960	S.RES ERJ1TYJ 120U (12)	T	94.5/43.3
R406	7030010960	S.RES ERJ1TYJ 120U (12)	T	98.2/43.3
R407	7310005230	TRI VM5CK-PVB 10 k		
R408	7030000420	S.RES MCR10EZHHJ 2.2 k	T	116.3/96
R409	7030000420	S.RES MCR10EZHHJ 2.2 k	T	116.3/38
R410	7310005230	TRI VM5CK-PVB 10 k		
R411	7030010520	S.RES ERJ1TYJ 101U (100)	T	107.6/93.9
R412	7030010520	S.RES ERJ1TYJ 101U (100)	T	107.5/40.2
R413	7030010520	S.RES ERJ1TYJ 101U (100)	T	111.3/93.9
R414	7030010520	S.RES ERJ1TYJ 101U (100)	T	111.2/40.2
R416	7070000890	RES ERG3SJ 150 (15)		
R418	7070001190	RES ERG3SJ180 (18)		
R420	7070000890	RES ERG3SJ 150 (15)		
R422	7070001190	RES ERG3SJ180 (18)		
R423	7030003460	S.RES ERJ3GEYJ 152 V (1.5 k)	T	95.9/98.4
R424	7030003460	S.RES ERJ3GEYJ 152 V (1.5 k)	T	99.4/33.6
R425	7310005200	TRI VM5CK-PVB 2 k		
R426	7310005200	TRI VM5CK-PVB 2 k		
R427	7070001200	RES ERG3SJ100P (10)		
R501	7070000890	RES ERG3SJ 150 (15)		
R502	7070000890	RES ERG3SJ 150 (15)		
R503	7030003500	S.RES ERJ3GEYJ 332 V (3.3 k)	T	171.8/16.7
R504	7030003500	S.RES ERJ3GEYJ 332 V (3.3 k)	T	169.9/15.9
R507	7030003500	S.RES ERJ3GEYJ 332 V (3.3 k)	T	139.1/17.9
R508	7030003500	S.RES ERJ3GEYJ 332 V (3.3 k)	T	137.3/19.2
R511	7070000890	RES ERG3SJ 150 (15)		
R512	7070000890	RES ERG3SJ 150 (15)		
R513	7070001000	RES ERG3SJ 821 (820)		

[PA200W BOARD]

REF NO.	ORDER NO.	DESCRIPTION	M.	H/V LOCATION
R514	7070001000	RES ERG3SJ 821 (820)		
R521	7030011160	S.RES RL7520WT-R010-F	T	165.2/20.2
R522	7030011160	S.RES RL7520WT-R010-F	T	159.6/20.2
R523	7030011160	S.RES RL7520WT-R010-F	T	154/20.2
R551	7030010650	S.RES ERJ12YJ823U (82 k)	T	144.5/34.2
R552	7030008020	S.RES ERJ12YJ472U (4.7 k)	T	141.2/28.3
R554	7030003560	S.RES ERJ3GEYJ 103 V (10 k)	T	154.5/34.2
R563	7030008240	S.RES ERJ12Y0R00U	T	137.5/28.9
R564	7030008240	S.RES ERJ12Y0R00U	T	156.6/30
R565	7030008240	S.RES ERJ12Y0R00U	T	146/29.4
C1	4030011600	S.CER C1608 JB 1E 104K-T	T	18.9/18
C2	4030006880	S.CER C1608 JB 1H 472K-T	T	18.9/20.5
C3	4030006880	S.CER C1608 JB 1H 472K-T	T	18.9/23
C4	4030006880	S.CER C1608 JB 1H 472K-T	T	18.9/29
C6	4030006880	S.CER C1608 JB 1H 472K-T	T	18.9/25.5
C7	4030006900	S.CER C1608 JB 1H 103K-T	T	70/6.8
C8	4030006880	S.CER C1608 JB 1H 472K-T	T	42.8/15.6
C9	4030011600	S.CER C1608 JB 1E 104K-T	T	57.6/11.4
C10	4510008520	S.ELE EEE1CA470SP	T	52/15.5
C11	4030006900	S.CER C1608 JB 1H 103K-T	T	60.4/11.4
C12	4510008520	S.ELE EEE1CA470SP	T	64.9/15.5
C15	4030006880	S.CER C1608 JB 1H 472K-T	T	104.3/20.4
C16	4030006880	S.CER C1608 JB 1H 472K-T	T	103/23.1
C17	4510008550	S.ELE EEE1HA010SR	T	95.9/22.8
C102	4030017810	S.CER C1608 CH 1H 102J-T	T	4.1/76.2
C103	4030011600	S.CER C1608 JB 1E 104K-T	T	9.2/72.5
C104	4030011600	S.CER C1608 JB 1E 104K-T	T	9.5/75.2
C106	4030017320	S.CER GRM21BB11H104KA01L	T	2.2/67.7
C107	4030011600	S.CER C1608 JB 1E 104K-T	T	9.2/70.9
C108	4030017810	S.CER C1608 CH 1H 102J-T	T	9.2/69.6
C109	4030017320	S.CER GRM21BB11H104KA01L	T	8.1/62.6
C110	4030017810	S.CER C1608 CH 1H 102J-T	T	9/64.2
C111	4030017810	S.CER C1608 CH 1H 102J-T	T	9/56.4
C112	4030017320	S.CER GRM21BB11H104KA01L	T	8.7/54.8
C113	4030011600	S.CER C1608 JB 1E 104K-T	T	5.3/102.4
C114	4030011600	S.CER C1608 JB 1E 104K-T	T	13.9/60.6
C201	4030017320	S.CER GRM21BB11H104KA01L	T	18.2/43.1
C202	4030017810	S.CER C1608 CH 1H 102J-T	T	15.7/61.3
C204	4030008490	S.CER C2012 JB 1H 682K-T	T	31.2/61.6
C206	4030008700	S.CER GRM21BB11H473KA01L	T	29.3/61.6
C207	4030008700	S.CER GRM21BB11H473KA01L	T	34.4/36.7
C301	4030004760	S.CER C2012 JF 1H 104Z-T	T	49.4/45.5
C303	4030011600	S.CER C1608 JB 1E 104K-T	T	43.4/35.4
C305	4030004760	S.CER C2012 JF 1H 104Z-T	T	44.4/42.6
C307	4030017810	S.CER C1608 CH 1H 102J-T	T	39.7/31.7
C309	4030011600	S.CER C1608 JB 1E 104K-T	T	41.1/31.7
C311	4030018750	S.CER C3225 CH 2J 682K-T	T	54.1/58.9
C313	4030011600	S.CER C1608 JB 1E 104K-T	T	89.1/26.9
C314	4510008050	ELE 63 ME 220 CZ		
C317	4030018790	S.CER C3225 JB 2E 104K-T	T	76.8/34
C318	4030011600	S.CER C1608 JB 1E 104K-T	T	77.2/96.7
C319	4030018790	S.CER C3225 JB 2E 104K-T	T	70.4/79
C401	4030011790	S.CER GRM55RF52A684ZD01L	T	92.4/82.2
C402	4030011790	S.CER GRM55RF52A684ZD01L	T	92.4/51.8
C403	4030011600	S.CER C1608 JB 1E 104K-T	T	79.9/100.1
C404	4030011600	S.CER C1608 JB 1E 104K-T	T	88.6/30.3
C405	4030006900	S.CER C1608 JB 1H 103K-T	T	79.9/98.0
C406	4030006900	S.CER C1608 JB 1H 103K-T	T	88.6/31.6
C407	4030017810	S.CER C1608 CH 1H 102J-T	T	79.9/97.5
C408	4030017810	S.CER C1608 CH 1H 102J-T	T	88.6/32.9
C409	4030018790	S.CER C3225 JB 2E 104K-T	T	111.3/100.2
C410	4030018790	S.CER C3225 JB 2E 104K-T	T	111.2/33.9
C411	4030006880	S.CER C1608 JB 1H 472K-T	T	114.9/99.1
C412	4030006880	S.CER C1608 JB 1H 472K-T	T	116.3/35
C413	4030011600	S.CER C1608 JB 1E 104K-T	T	97.8/99.1
C414	4030011600	S.CER C1608 JB 1E 104K-T	T	97.4/36.5
C415	4030011790	S.CER GRM55RF52A684ZD01L	T	102.8/88.8
C416	4030011790	S.CER GRM55RF52A684ZD01L	T	103.8/49
C417	4030018760	S.CER C4532 CH 2A 104K-T	T	190.2/82.6
C418	4030018760	S.CER C4532 CH 2A 104K-T	T	193.9/82.6

[FILTER UNIT]

REF NO.	ORDER NO.	DESCRIPTION	M.	H/V LOCATION
D402	1750000271	S.DIO 1SS301 (TE85L,F)	T	11.8/24.3
D452	1750000271	S.DIO 1SS301 (TE85L,F)	T	32/20.5
D502	1750000271	S.DIO 1SS301 (TE85L,F)	T	54.8/30.3
D552	1750000271	S.DIO 1SS301 (TE85L,F)	T	155.6/29.1
D602	1750000271	S.DIO 1SS301 (TE85L,F)	T	130.1/20.3
D652	1750000271	S.DIO 1SS301 (TE85L,F)	T	93.8/33
D702	1750000271	S.DIO 1SS301 (TE85L,F)	T	69.6/20.3
D752	1750000271	S.DIO 1SS301 (TE85L,F)	T	113.1/33
D802	1750000271	S.DIO 1SS301 (TE85L,F)	T	173.6/25.9
L401	6200005131	S.COL NLC453232T-101K-PF	T	25.4/136.7
L402	6140004310	COL LR-471		
L403	6140004300	COL LR-470		
L404	6140004300	COL LR-470		
L405	6200005131	S.COL NLC453232T-101K-PF	T	7.3/24.6
L451	6200005131	S.COL NLC453232T-101K-PF	T	4.4/143.9
L452	6140004270	COL LR-467		
L453	6140004290	COL LR-469		
L454	6140004290	COL LR-469		
L455	6200005131	S.COL NLC453232T-101K-PF	T	28.4/29.9
L501	6200005131	S.COL NLC453232T-101K-PF	T	46.3/133.8
L502	6140004280	COL LR-468		
L503	6140004270	COL LR-467		
L504	6140004270	COL LR-467		
L505	6200005131	S.COL NLC453232T-101K-PF	T	50.2/29.6
L551	6200005131	S.COL NLC453232T-101K-PF	T	150.7/133.8
L552	6140004260	COL LR-466		
L553	6140004280	COL LR-468		
L554	6140004280	COL LR-468		
L555	6200005131	S.COL NLC453232T-101K-PF	T	151/29.7
L601	6200005131	S.COL NLC453232T-101K-PF	T	129.9/133.8
L602	6140004250	COL LR-465		
L603	6140004240	COL LR-464		
L604	6140004240	COL LR-464		
L605	6200005131	S.COL NLC453232T-101K-PF	T	130.1/14.2
L651	6200005131	S.COL NLC453232T-101K-PF	T	88.2/133.8
L652	6140004200	COL LR-463		
L653	6140004170	COL LR-462		
L654	6140004170	COL LR-462		
L655	6200005131	S.COL NLC453232T-101K-PF	T	92.3/29.8
L701	6200005131	S.COL NLC453232T-101K-PF	T	67.2/133.8
L702	6140004130	COL LR-461		
L703	6140004070	COL LR-460		
L704	6140004070	COL LR-460		
L705	6200005131	S.COL NLC453232T-101K-PF	T	69.6/14.1
L751	6200005131	S.COL NLC453232T-101K-PF	T	109.1/133.8
L752	6110003900	COL LA-592		
L753	6110003890	COL LA-591		
L754	6110003890	COL LA-591		
L755	6200005131	S.COL NLC453232T-101K-PF	T	111.4/29.8
L801	6200001831	S.COL NLV32T-100J	T	165.9/163.4
L802	6110003880	COL LA-590		
L803	6110003870	COL LA-589		
L804	6110003870	COL LA-589		
L805	6200001831	S.COL NLV32T-100J	T	173.9/22.8
C401	4030006880	S.CER C1608 JB 1H 472K-T	T	25.4/130.4
C402	4010008200	CER HM11TJ SL 331J 500V		
C403	4010008200	CER HM11TJ SL 331J 500V		
C404	4010008300	CER HM11TJ SL 391J 500V		
C405	4010008300	CER HM11TJ SL 391J 500V		
C406	4010008210	CER HM60TJ SL 560J 500V		
C407	4010007590	CER HM15SJ SL 681J 500V		
C408	4010007590	CER HM15SJ SL 681J 500V		
C409	4010007590	CER HM15SJ SL 681J 500V		
C410	4010005870	CER HM95TJ SL 221J 500V		
C411	4010008280	CER HM95TJ SL 221J 500V		
C412	4010008370	CER HM60TJ SL 150J 500V		
C413	4010007590	CER HM15SJ SL 681J 500V		
C414	4010007590	CER HM15SJ SL 681J 500V		
C415	4010007590	CER HM15SJ SL 681J 500V		
C416	4010008300	CER HM11TJ SL 391J 500V		
C417	4010008230	CER HM60TJ SL 820J 500V		
C418	4010007590	CER HM15SJ SL 681J 500V		
C419	4010007590	CER HM15SJ SL 681J 500V		
C420	4030006880	S.CER C1608 JB 1H 472K-T	T	11.6/26.3
C451	4030006880	S.CER C1608 JB 1H 472K-T	T	26.6/127.9
C452	4010008290	CER HM95TJ SL 271J 500V		
C453	4010008280	CER HM95TJ SL 221J 500V		
C454	4010008240	CER HM60TJ SL 101J 500V		
C455	4010005810	CER HM74SJ SL 111J 500V		
C456	4010007490	CER HM15SJ SL 561J 500V		
C457	4010006410	CER HM13SJ SL 471J 500V		
C458	4010008250	CER HM74TJ SL 121J 500V		
C459	4010005810	CER HM74SJ SL 111J 500V		
C461	4010007490	CER HM15SJ SL 561J 500V		
C462	4010007490	CER HM15SJ SL 561J 500V		
C463	4010008340	CER HM60TJ SL 270J 500V		
C464	4010008320	CER HM60TJ SL 390J 500V		
C465	4010007490	CER HM15SJ SL 561J 500V		
C466	4010008220	CER HM60TJ SL 680J 500V		
C467	4030006880	S.CER C1608 JB 1H 472K-T	T	32.4/23.4
C468	4010008230	CER HM60TJ SL 820J 500V		
C501	4030006880	S.CER C1608 JB 1H 472K-T	T	47.6/127.3
C502	4010008280	CER HM95TJ SL 221J 500V		
C503	4010008260	CER HM74TJ SL 151J 500V		
C504	4010008280	CER HM95TJ SL 221J 500V		
C506	4010008200	CER HM11TJ SL 331J 500V		
C507	4010008280	CER HM95TJ SL 221J 500V		
C508	4010008280	CER HM95TJ SL 221J 500V		
C509	4010005810	CER HM74SJ SL 111J 500V		
C511	4010008300	CER HM11TJ SL 391J 500V		
C512	4010008300	CER HM11TJ SL 391J 500V		
C513	4010008260	CER HM74TJ SL 151J 500V		
C514	4010008320	CER HM60TJ SL 390J 500V		
C515	4010008280	CER HM95TJ SL 221J 500V		
C516	4010008280	CER HM95TJ SL 221J 500V		
C517	4030006880	S.CER C1608 JB 1H 472K-T	T	54.7/28.4
C518	4010008340	CER HM60TJ SL 270J 500V		
C551	4030006880	S.CER C1608 JB 1H 472K-T	T	149.9/122.5
C552	4010005860	CER HM95SJ SL 201J 500V		
C554	4010008230	CER HM60TJ SL 820J 500V		

[FILTER UNIT]

REF NO.	ORDER NO.	DESCRIPTION	M.	H/V LOCATION
C555	4010008370	CER HM60TJ SL 150J 500V		
C556	4010008290	CER HM95TJ SL 271J 500V		
C557	4010008290	CER HM95TJ SL 271J 500V		
C558	4010008320	CER HM60TJ SL 390J 500V		
C559	4010008330	CER HM60TJ SL 330J 500V		
C560	4010008340	CER HM60TJ SL 270J 500V		
C561	4010008200	CER HM11TJ SL 331J 500V		
C562	4010008290	CER HM95TJ SL 271J 500V		
C563	4010008330	CER HM60TJ SL 330J 500V		
C564	4010005650	CER HM60SJ SL 200J 500V		
C565	4010008280	CER HM95TJ SL 221J 500V		
C566	4010008350	CER HM60TJ SL 220J 500V		
C567	4030006880	S.CER C1608 JB 1H 472K-T	T	152.2/32.2
C601	4030006880	S.CER C1608 JB 1H 472K-T	T	130.2/125
C604	4010008230	CER HM60TJ SL 820J 500V		
C605	4010008370	CER HM60TJ SL 150J 500V		
C606	4010008280	CER HM95TJ SL 221J 500V		
C607	4010008220	CER HM60TJ SL 680J 500V		
C608	4010008350	CER HM60TJ SL 220J 500V		
C609	4010008340	CER HM60TJ SL 270J 500V		
C610	4010008200	CER HM11TJ SL 331J 500V		
C611	4010008230	CER HM60TJ SL 820J 500V		
C612	4010008360	CER HM60TJ SL 180J 500V		
C613	4010008260	CER HM74TJ SL 151J 500V		
C614	4010008230	CER HM60TJ SL 820J 500V		
C615	4030006880	S.CER C1608 JB 1H 472K-T	T	130.2/18.3
C651	4030006880	S.CER C1608 JB 1H 472K-T	T	88.3/124.9
C654	4010008360	CER HM60TJ SL 180J 500V		
C655	4010008320	CER HM60TJ SL 390J 500V		
C656	4010008280	CER HM95TJ SL 221J 500V		
C657	4010008220	CER HM60TJ SL 680J 500V		
C658	4010008360	CER HM60TJ SL 180J 500V		
C659	4010008380	CER HM60TJ SL 120J 500V		
C660	4010008280	CER HM95TJ SL 221J 500V		
C661	4010008240	CER HM60TJ SL 101J 500V		
C662	4010008390	CER HM60TJ SL 100D 500V		
C663	4010008250	CER HM74TJ SL 121J 500V		
C664	4010008320	CER HM60TJ SL 390J 500V		
C665	4030006880	S.CER C1608 JB 1H 472K-T	T	96.6/28.6
C701	4030006880	S.CER C1608 JB 1H 472K-T	T	68.6/127.5
C703	4010008370	CER HM60TJ SL 150J 500V		
C704	4010008350	CER HM60TJ SL 220J 500V		
C705	4010005650	CER HM60SJ SL 200J 500V		
C706	4010005860	CER HM95SJ SL 201J 500V		
C707	4010008310	CER HM60TJ SL 470J 500V		
C708	4010008370	CER HM60TJ SL 150J 500V		
C709	4010008280	CER HM95TJ SL 221J 500V		
C710	4010008350	CER HM60TJ SL 220J 500V		
C712	4010008330	CER HM60TJ SL 330J 500V		
C713	4010008310	CER HM60TJ SL 470J 500V		
C714	4030006880	S.CER C1608 JB 1H 472K-T	T	69.6/18.3
C715	4010008360	CER HM60TJ SL 180J 500V		
C751	4030006880	S.CER C1608 JB 1H 472K-T	T	109.1/125
C755	4010008240	CER HM60TJ SL 101J 500V		
C756	4010008210	CER HM60TJ SL 560J 500V		
C757	4010008230	CER HM60TJ SL 820J 500V		
C757	4010008360	CER HM60TJ SL 180J 500V		
C758	4010008210	CER HM60TJ SL 560J 500V		
C759	4010008240	CER HM60TJ SL 101J 500V		
C760	4010008400	CER HM60TJ SL 060D 500V		
C761	4010008310	CER HM60TJ SL 470J 500V		
C763	4030006880	S.CER C1608 JB 1H 472K-T	T	115.6/28.6
C764	4010005650	CER HM60SJ SL 200J 500V		
C765	4010008370	CER HM60TJ SL 150J 500V		
C801	4030006880	S.CER C1608 JB 1H 472K-T	T	168.6/158.6
C804	4010008360	CER HM60TJ SL 180J 500V		
C805	4010008320	CER HM60TJ SL 390J 500V		
C806	4010008310	CER HM60TJ SL 470J 500V		
C807	4010005600	CER HM60SJ SL 090D 500V		
C808	4010008330	CER HM60TJ SL 330J 500V		
C809	4010008320	CER HM60TJ SL 390J 500V		
C810	4010008410	CER HM60TJ SL 030C 500V		
C811	4010005650	CER HM60SJ SL 050C 500V		
C813	4030006880	S.CER C1608 JB 1H 472K-T	T	175.6/26
RL401	6330001471	RLY AJS1311F-K2		
RL402	6330001471	RLY AJS1311F-K2		
RL451	6330001471	RLY AJS1311F-K2		
RL452	6330001471	RLY AJS1311F-K2		
RL501	6330001471	RLY AJS1311F-K2		
RL502	6330001471	RLY AJS1311F-K2		
RL551	6330001471	RLY AJS1311F-K2		
RL552	6330001471	RLY AJS1311F-K2		
RL601	6330001471	RLY AJS1311F-K2		
RL602	6330001471	RLY AJS1311F-K2		
RL651	6330001471	RLY AJS1311F-K2		
RL652	6330001471	RLY AJS1311F-K2		
RL701	6330001471	RLY AJS1311F-K2		
RL702	6330001471	RLY AJS1311F-K2		
RL751	6330001471	RLY AJS1311F-K2		
RL752	6330001471	RLY AJS1311F-K2		
RL801	6330001460	RLY FTR-F1CA012V		
RL802	6330001460	RLY FTR-F1CA012V		
J901	6510017930	CNR 1771P145-20		
J902	6510022031	S.CNR B10B-ZR-SM4-TF (LF) (SN)	T	145.3/165.2
J903	6510019971	S.CNR 52808-1071	T	4/156
J904	6510017930	CNR 1771P145-20		
J905	6510019421	S.CNR B8B-ZR-SM4-TF (LF) (SN)	T	

[DC-DC UNIT]

REF NO.	ORDER NO.	DESCRIPTION	M.	H/V LOCATION
IC201	1180003100	S.REG BD9302FP-E2	T	124.4/52.7
IC401	1180003100	S.REG BD9302FP-E2	T	51.4/52.3
IC601	1180003100	S.REG BD9302FP-E2	T	87.9/52.3
IC801	1180002530	S.REG LM2594M-12	T	160.2/59.4
Q141	1590003310	S.TR DTD113ZK T146	T	28.4/79.8
D141	1750000520	S.DIO DAN222TL	T	26.2/77.8
D201	1750000960	S.DIO RB081L-20	T	122.8/61.3
D301	1750000960	S.DIO RB081L-20	T	124.7/44.2
D401	1750000960	S.DIO RB081L-20	T	49.8/61.9
D501	1750000960	S.DIO RB081L-20	T	53.8/43.6
D601	1750000960	S.DIO RB081L-20	T	86.4/60.8
D801	1710000840	S.DIO 1SR154-400 TE25	T	149.2/41.5
D802	1750001011	S.DIO MBRD835LT4G	T	150.5/57.5
D803	1750000960	S.DIO RB081L-20	T	156.8/67.5
L141	6200001831	S.COL NLV32T-100J	T	30.4/74.4
L201	6200013280	S.COL SLF10145T-330M1R6-PF	T	118.5/68.1
L211	6200010881	S.COL CDRH124NP-330MC	T	132.7/66.9
L301	6200013280	S.COL SLF10145T-330M1R6-PF	T	132.2/37.6
L302	6200010901	S.COL CDRH104RNP-100NC	T	116.7/37.5
L401	6200013280	S.COL SLF10145T-330M1R6-PF	T	45.8/68.9
L411	6200010881	S.COL CDRH124NP-330MC	T	59.6/66.2
L501	6200013280	S.COL SLF10145T-330M1R6-PF	T	46.2/37
L601	6200013280	S.COL SLF10145T-330M1R6-PF	T	82.4/67.6
L611	6200010881	S.COL CDRH124NP-330MC	T	96.2/65.9
L801	6190001640	S.COL SLF12555T-101M1R1-PF	T	159/47.5
L802	6190001191	S.COL D10F-#A814AY-101K	T	166.3/33
L803	6200013280	S.COL SLF10145T-330M1R6-PF	T	147.2/30.8
R141	7030008190	S.RES ERJ12YJ330U (33)	T	27/73.6
R201	7030003680	S.RES ERJ3GEYJ 104 V (100 k)	T	114.1/59.1
R202	7030003600	S.RES ERJ3GEYJ 223 V (22 k)	T	116.9/59.1
R204	7030003610	S.RES ERJ3GEYJ 273 V (27 k)	T	117.6/57.2
R205	7030005451	S.RES ERA3YED 153V (15 k)	T	118/55.4
R301	7030003670	S.RES ERJ3GEYJ 823 V (82 k)	T	113.4/47.4
R302	7030003530	S.RES ERJ3GEYJ 562 V (5.6 k)	T	116.4/47.4
R303	7030003530	S.RES ERJ3GEYJ 562 V (5.6 k)	T	118.3/46.5
R304	7030003610	S.RES ERJ3GEYJ 273 V (27 k)	T	117.6/48.4
R401	7030003670	S.RES ERJ3GEYJ 823 V (82 k)	T	41.3/58.8
R402	7030003530	S.RES ERJ3GEYJ 562 V (5.6 k)	T	43.3/58.1
R403	7030003530	S.RES ERJ3GEYJ 562 V (5.6 k)	T	44/60
R404	7030003610	S.RES ERJ3GEYJ 273 V (27 k)	T	44.6/57.2
R405	7030005451	S.RES ERA3YED 153V (15 k)	T	45/55
R501	7030003610	S.RES ERJ3GEYJ 273 V (27 k)	T	41.5/46
R502	7030003590	S.RES ERJ3GEYJ 183 V (18 k)	T	44.3/46
R504	7030003610	S.RES ERJ3GEYJ 273 V (27 k)	T	44.9/47.8
R601	7030003680	S.RES ERJ3GEYJ 104 V (100 k)	T	78.1/58.7
R602	7030003600	S.RES ERJ3GEYJ 223 V (22 k)	T	80.8/58.7
R604	7030003610	S.RES ERJ3GEYJ 273 V (27 k)	T	81.3/56.8
R605	7030005451	S.RES ERA3YED 153V (15 k)	T	81.9/54.9
R706	7030003860	S.RES ERJ3GE JPW V	T	81.8/49.6
R801	7030003640	S.RES ERJ3GEYJ 473 V (47 k)	T	155.9/61.4
R802	7030003640	S.RES ERJ3GEYJ 473 V (47 k)	T	158.1/62.8
C8	4030006880	S.CER C1608 JB 1H 472K-T	T	112.7/17.9
C9	4510008700	S.ELE 25 CV 330 BS	T	111.6/11.9
C141	4030011600	S.CER C1608 JB 1E 104K-T	T	30.7/79.6
C201	4030011280	S.CER C1608 CH 1H 271J-T	T	114.1/57.9
C202	4030006860	S.CER C1608 JB 1H 102K-T	T	116.1/57.2
C203	4030011600	S.CER C1608 JB 1E 104K-T	T	118/54.2
C204	4030011600	S.CER C1608 JB 1E 104K-T	T	129.8/57.3
C205	4030018970	S.CER C3225 JB 1C 226MT-N	T	114.9/61.3
C206	4030007130	S.CER C1608 CH 1H 101J-T	T	118.9/57.4
C207	4030018970	S.CER C3225 JB 1C 226MT-N	T	114.4/54
C211	4030011600	S.CER C1608 JB 1E 104K-T	T	129.9/54.5
C212	4550007140	S.TAN TEESVD 1C 107M12R	T	134.1/49.5
C213	4030018970	S.CER C3225 JB 1C 226MT-N	T	133.1/56.6
C214	4030011600	S.CER C1608 JB 1E 104K-T	T	137.3/74.4
C301	4030011280	S.CER C1608 CH 1H 271J-T	T	114.7/47.4
C302	4030006860	S.CER C1608 JB 1H 102K-T	T	115.5/49.4
C303	4030011600	S.CER C1608 JB 1E 104K-T	T	118.5/50.3
C304	4030011600	S.CER C1608 JB 1E 104K-T	T	129.6/48.1
C305	4030018970	S.CER C3225 JB 1C 226MT-N	T	125.3/39.7
C306	4030007130	S.CER C1608 CH 1H 101J-T	T	119/48.4
C307	4030018970	S.CER C3225 JB 1C 226MT-N	T	116.3/44.4
C308	4030011600	S.CER C1608 JB 1E 104K-T	T	106.9/36.2
C401	4030011280	S.CER C1608 CH 1H 271J-T	T	41.3/60
C402	4030006860	S.CER C1608 JB 1H 102K-T	T	41.9/56.9
C403	4030011600	S.CER C1608 JB 1E 104K-T	T	45/53.8
C404	4030011600	S.CER C1608 JB 1E 104K-T	T	56.8/56.6
C405	4030018970	S.CER C3225 JB 1C 226MT-N	T	41.9/62.1
C406	4030007130	S.CER C1608 CH 1H 101J-T	T	46/57.2
C408	4030011600	S.CER C1608 JB 1E 104K-T	T	34.6/60
C411	4030011600	S.CER C1608 JB 1E 104K-T	T	56.8/53.8
C412	4550007140	S.TAN TEESVD 1C 107M12R	T	61/45.3
C413	4030018970	S.CER C3225 JB 1C 226MT-N	T	59.6/54.3
C501	4030011280	S.CER C1608 CH 1H 271J-T	T	41.5/47.3
C502	4030006860	S.CER C1608 JB 1H 102K-T	T	43.5/47.8
C503	4030011600	S.CER C1608 JB 1E 104K-T	T	45.3/49.8
C504	4030011600	S.CER C1608 JB 1E 104K-T	T	56.7/47.6
C505	4030018970	S.CER C3225 JB 1C 226MT-N	T	43.6/43.8
C506	4030007130	S.CER C1608 CH 1H 101J-T	T	46.1/47.8
C508	4030011600	S.CER C1608 JB 1E 104K-T	T	35.4/47.1
C601	4030011280	S.CER C1608 CH 1H 271J-T	T	78.1/57.4
C602	4030006860	S.CER C1608 JB 1H 102K-T	T	80.1/56.8
C603	4030011600	S.CER C1608 JB 1E 104K-T	T	82.2/52.9
C604	4030011600	S.CER C1608 JB 1E 104K-T	T	93.2/56.6

[DC-DC UNIT]

REF NO.	ORDER NO.	DESCRIPTION	M.	H/V LOCATION
C605	4030018970	S.CER C3225 JB 1C 226MT-N	T	78.9/60.8
C606	4030007130	S.CER C1608 CH 1H 101J-T	T	82.5/56.8
C607	4030018970	S.CER C3225 JB 1C 226MT-N	T	77.3/55.3
C608	4030018970	S.CER C3225 JB 1C 226MT-N	T	79/52.3
C611	4030011600	S.CER C1608 JB 1E 104K-T	T	93.2/54
C612	4550007140	S.TAN TEESVD 1C 107M12R	T	97.7/45.3
C613	4030018970	S.CER C3225 JB 1C 226MT-N	T	95.9/54.4
C801	4510008910	S.ELE EEEFC1C101P	T	148.1/48.1
C802	4030011600	S.CER C1608 JB 1E 104K-T	T	160.7/62.8
C803	4510008940	S.ELE EEEFC1V470P	T	147.6/66.3
C805	4030018970	S.CER C3225 JB 1C 226MT-N	T	150/23.5
RL142	6330001760	RLY AW3023		
J1	6510022801	S.CNR B10B-PH-SM4-TB (LF) (SN)	T	24.5/23.9
J2	6510020251	S.CNR B9B-PH-SM4-TB (LF) (SN)	T	24.5/54.1
J3	6510018941	S.CNR B13B-PH-SM4-TB (LF) (SN)	T	60.2/24.5
J5	6510018951	S.CNR B7B-PH-SM4-TB (LF) (SN)	T	55.9/10.2
J6	6510023261	S.CNR B6B-PH-SM4-TB (LF) (SN)	T	80.3/10.2
J7	6510018921	S.CNR B8B-PH-SM4-TB (LF) (SN)	T	91/24.5
J8	6510018971	S.CNR B4B-PH-SM4-TB (LF) (SN)	T	112.9/24.5
W1	9030090150	WIR OPC-1803		
EP201	6910014730	S.BEA MPZ2012S331A-T	T	112/57.1
EP211	6910014730	S.BEA MPZ2012S331A-T	T	128.3/74.2
EP301	6910014730	S.BEA MPZ2012S331A-T	T	124.8/33.2
EP302	6910014730	S.BEA MPZ2012S331A-T	T	103.6/28.4
EP401	6910014730	S.BEA MPZ2012S331A-T	T	38.9/60.3
EP402	6910014730	S.BEA MPZ2012S331A-T	T	33.4/57.6
EP501	6910014730	S.BEA MPZ2012S331A-T	T	40/48.8
EP502	6910014730	S.BEA MPZ2012S331A-T	T	34.3/49.3
EP601	6910014730	S.BEA MPZ2012S331A-T	T	75.7/58.3
EP602	6910014730	S.BEA MPZ2012S331A-T	T	75.7/52.2

[TUNER UNIT]

REF NO.	ORDER NO.	DESCRIPTION	M.	H/V LOCATION
MF1	2710000780	MTR MP24Z (STEPPING MOTOR)		
MF2	2710000780	MTR MP24Z (STEPPING MOTOR)		
MF3	2710000470	FAN MF60B-12H901		
W1	8900012901	CBL OPC-1345R		
W2	8900012901	CBL OPC-1345R		
W3	8900017140	CBL OPC-927A (P1,N24,L100)		
W51	8600037090	CBL SX2590 P51*P52*P53TU		

M.=Mounted side (T: Mounted on the Top side B: Mounted on the Bottom side)
S.=Surface mount

[CTRL BOARD]

REF NO.	ORDER NO.	DESCRIPTION	M.	H/V LOCATION
IC1	1140004120	S.IC M38022M2-138FP	T	65.7/81.8
IC2	1130010390	S.IC HN58X2416TI	T	54/86.9
IC3	1130003921	S.IC TC4S69F (TE85R,F)	T	62/59.5
IC4	1180001071	S.IC TA7805F (TE16L,Q)	B	71.5/47.5
IC5	1130009691	S.IC TC74HCT7007AF (F)	B	92.5/91.6
IC6	1130006441	S.IC TC7S08F (TE85R,F)	T	81.7/70.3
IC51	1130011530	S.IC CD74HC4094M96	T	42.2/72.4
IC52	1130007690	S.IC BU4066BFC-E2	B	12.5/76.9
IC55	1130011530	S.IC CD74HC4094M96	B	100.2/76.1
IC56	1130011530	S.IC CD74HC4094M96	B	114.3/76.1
IC57	1160000131	S.IC TD62783AFG (S,EL)	T	99.6/73.1
IC58	1160000131	S.IC TD62783AFG (S,EL)	T	113.7/73.1
IC101	1110000960	S.IC NJM4558M-TE1-#FMZB	T	18.3/47.8
IC151	1120002301	S.IC TC74AC04F (F)	B	32.8/53.1
IC153	1130012011	S.IC TC7S232F (TE85L,F)	T	27.8/48.6
IC154	1130012011	S.IC TC7S232F (TE85L,F)	T	40.4/48.6
IC155	1130012011	S.IC TC7S232F (TE85L,F)	T	34.2/51.9
IC156	1130012021	S.IC TC74ACT112F (EL,F)	T	35.4/58.9
IC201	1110000960	S.IC NJM4558M-TE1-#FMZB	B	61.3/58.2
IC301	1110002690	S.IC NJM2903M-TE1-#FMZB	T	80/59
IC401	1160000131	S.IC TD62783AFG (S,EL)	T	13.6/86.1
IC402	1160000131	S.IC TD62783AFG (S,EL)	T	31.6/84.7
IC403	1160000131	S.IC TD62783AFG (S,EL)	B	24.7/88
Q1	1590001330	S.TR DTA114EUA T106	T	78.5/75.2
Q2	1590000680	S.TR DTC114EUA T106	T	77.8/71.2
Q3	1590000680	S.TR DTC114EUA T106	T	128.4/74.5
Q4	1590000680	S.TR DTC114EUA T106	T	128.4/77
Q5	1590000680	S.TR DTC114EUA T106	T	128.4/81.3
Q6	1590000680	S.TR DTC114EUA T106	T	128.4/83.8
Q7	1590000680	S.TR DTC114EUA T106	T	128.4/88.5
Q8	1590000680	S.TR DTC114EUA T106	T	128.4/91
Q9	1590000680	S.TR DTC114EUA T106	T	128.4/95.7
Q10	1590000680	S.TR DTC114EUA T106	T	128.4/100.5
Q11	1590000680	S.TR DTC114EUA T106	B	85.7/99.8
Q51	1590000680	S.TR DTC114EUA T106	B	6.1/78.6
Q52	1590000680	S.TR DTC114EUA T106	T	12.5/78.6
Q53	1590000680	S.TR DTC114EUA T106	B	6.6/72.8
Q54	1560001260	S.FET 2SK3018 T106	B	121.8/80.4
Q55	1590000680	S.TR DTC114EUA T106	B	130.2/68.9
Q59	1590000680	S.TR DTC114EUA T106	T	56.8/69.5
Q151	1590000680	S.TR DTC114EUA T106	B	39.8/42.3
Q152	1590000680	S.TR DTC114EUA T106	B	39.8/39.5
Q153	1590001330	S.TR DTA114EUA T106	B	39.8/45.1
Q201	1560000871	S.FET 2SK515-T1B-A (X33)	B	50.4/51.8
Q252	1520000561	S.TR 2SB1123 T-TD-E	T	18.8/6.7
Q253	1540000441	S.TR 2SD1619T-TD-E	B	26.6/6.7
Q254	1590000680	S.TR DTC114EUA T106	T	24.9/5.4
Q255	1590002420	S.TR UMD3N TR	T	97.4/12.1
Q256	1590000680	S.TR DTC114EUA T106	T	101.4/12.4
D1	1730000411	S.ZEN RD5.1M-T2B-A B2	T	69.8/58.7
D2	1710000780	S.DIO MA114 (TX)	T	73.8/58.7
D3	1750000201	S.DIO 1SS319 (TE85R,F)	B	129.5/98.1
D4	1750000201	S.DIO 1SS319 (TE85R,F)	B	129.5/90
D5	1750000201	S.DIO 1SS319 (TE85R,F)	B	129.5/82.8
D6	1750000201	S.DIO 1SS319 (TE85R,F)	B	129.5/76
D7	1730000031	S.ZEN RD5.6M-T2B-A B2	T	69.8/55.3
D101	1790000491	S.DIO HSM88ASTR-E	B	16.5/37.1
D102	1790000491	S.DIO HSM88ASTR-E	B	20.5/37.1
D103	1750000201	S.DIO 1SS319 (TE85R,F)	B	18.5/57
D151	1790000491	S.DIO HSM88ASTR-E	B	33.5/45.3
D152	1790000491	S.DIO HSM88ASTR-E	T	37/44.2
D153	1790000491	S.DIO HSM88ASTR-E	B	27.6/61.1
D154	1790000491	S.DIO HSM88ASTR-E	B	39.4/61.1
D201	1790000491	S.DIO HSM88ASTR-E	B	50.3/45.6
D202	1790000491	S.DIO HSM88ASTR-E	T	44.9/45.5
D203	1750000201	S.DIO 1SS319 (TE85R,F)	B	54.5/58.2
D301	1790000491	S.DIO HSM88ASTR-E	B	82.8/52.5
D302	1790000491	S.DIO HSM88ASTR-E	B	89.2/58
D303	1710000140	DIO U05G		
D304	1750000271	S.DIO 1SS301 (TE85L,F)	T	94.6/12.3
X1	6050009890	S.XTL CR-569 (6.144 MHz)	T	83.2/79.5
L1	6200003261	S.COL NLV32T-101J	T	51.1/76.5
L2	6200003261	S.COL NLV32T-101J	T	54.5/77.8
L5	6200005131	S.COL NLC453232T-101K-PF	T	121.6/100.3
L51	6200003261	S.COL NLV32T-101J	T	106.3/86.9
L52	6200005131	S.COL NLC453232T-101K-PF	T	114.9/88.1
L101	6140004410	COL LR-502		
L102	6200001831	S.COL NLV32T-100J	T	26.7/56.3
L103	6200003261	S.COL NLV32T-101J	T	14/56.3
L104	6200005190	S.COL MLF1608D R56K 0.56U	T	19.5/40.5
L151	6140004410	COL LR-502		
L152	6200001831	S.COL NLV32T-100J	T	43.1/62.7
L201	6140004410	COL LR-502		
L202	6180003300	COL T6-222J (2.2M)		
L301	6140004410	COL LR-502		
L302	6200003261	S.COL NLV32T-101J	B	76.9/60.8
L403	6140004670	COL LR-527 (CH160808TR271)		
L404	6140004670	COL LR-527 (CH160808TR271)		
R2	7030003680	S.RES ERJ3GEYJ 104 V (100 k)	T	63/71
R3	7030003680	S.RES ERJ3GEYJ 104 V (100 k)	T	64.3/71
R4	7030003680	S.RES ERJ3GEYJ 104 V (100 k)	T	65.6/71
R5	7030003680	S.RES ERJ3GEYJ 104 V (100 k)	T	66.9/71
R6	7030003560	S.RES ERJ3GEYJ 103 V (10 k)	T	74.7/71
R7	7030003440	S.RES ERJ3GEYJ 102 V (1 k)	T	73.4/71
R8	7030003680	S.RES ERJ3GEYJ 104 V (100 k)	T	55.4/72.8
R9	7030003680	S.RES ERJ3GEYJ 104 V (100 k)	T	54.7/74.7
R10	7030003680	S.RES ERJ3GEYJ 104 V (100 k)	T	57.3/72.9
R11	7030003680	S.RES ERJ3GEYJ 104 V (100 k)	T	53.4/74.7
R12	7030003440	S.RES ERJ3GEYJ 102 V (1 k)	T	78.3/83.9
R13	7030003680	S.RES ERJ3GEYJ 104 V (100 k)	T	76.6/75.6
R14	7030003680	S.RES ERJ3GEYJ 104 V (100 k)	T	78.5/78.2
R15	7030003440	S.RES ERJ3GEYJ 102 V (1 k)	T	61.7/62
R16	7030003320	S.RES ERJ3GEYJ 101 V (100)	T	62.2/55.8
R17	7030003560	S.RES ERJ3GEYJ 103 V (10 k)	T	54.1/82.2
R18	7030003560	S.RES ERJ3GEYJ 103 V (10 k)	T	54.1/80.9
R19	7030003680	S.RES ERJ3GEYJ 104 V (100 k)	T	64.7/59
R20	7030003570	S.RES ERJ3GEYJ 123 V (12 k)	T	67.7/61.1
R21	7030003650	S.RES ERJ3GEYJ 563 V (56 k)	T	66/59
R22	7030003450	S.RES ERJ3GEYJ 122 V (12.2 k)	T	73.3/61.1
R23	7030003400	S.RES ERJ3GEYJ 471 V (470)	B	105.1/100
R24	7030003440	S.RES ERJ3GEYJ 102 V (1 k)	B	102.9/98.8
R25	7030003380	S.RES ERJ3GEYJ 331 V (330)	B	126/99.1
R26	7030003380	S.RES ERJ3GEYJ 331 V (330)	B	126/97.1
R27	7030003380	S.RES ERJ3GEYJ 331 V (330)	B	126/91
R28	7030003380	S.RES ERJ3GEYJ 331 V (330)	B	126/89
R29	7030003380	S.RES ERJ3GEYJ 331 V (330)	B	126/83.8
R30	7030003380	S.RES ERJ3GEYJ 331 V (330)	B	126/81.8
R31	7030003380	S.RES ERJ3GEYJ 331 V (330)	B	126/77
R32	7030003380	S.RES ERJ3GEYJ 331 V (330)	B	126/75
R40	7030003440	S.RES ERJ3GEYJ 102 V (1 k)	T	61.2/99.9
R42	7030003860	S.RES ERJ3GE JPW V	T	60.4/71
R43	7030003860	S.RES ERJ3GE JPW V	T	60.7/69
R44	7030003860	S.RES ERJ3GE JPW V	T	68.2/71
R45	7030003860	S.RES ERJ3GE JPW V	T	65.7/68.5
R46	7030003860	S.RES ERJ3GE JPW V	T	70.6/68.9
R51	7030003440	S.RES ERJ3GEYJ 102 V (1 k)	T	35.5/77.3
R52	7030003440	S.RES ERJ3GEYJ 102 V (1 k)	T	34.2/77.3
R53	7030003860	S.RES ERJ3GE JPW V	T	32.9/77.3
R54	7030003860	S.RES ERJ3GE JPW V	T	31.6/77.3
R55	7030003860	S.RES ERJ3GE JPW V	B	29.6/80.1
R56	7030003860	S.RES ERJ3GE JPW V	B	28/80.1
R57	7030003860	S.RES ERJ3GE JPW V	B	26.4/80.1
R58	7030003860	S.RES ERJ3GE JPW V	B	24.8/80.1
R59	7030003860	S.RES ERJ3GE JPW V	T	18.3/78.7
R60	7030003860	S.RES ERJ3GE JPW V	T	17/76
R61	7030003860	S.RES ERJ3GE JPW V	T	15.7/76
R62	7030003860	S.RES ERJ3GE JPW V	T	14.4/78.7
R63	7030003860	S.RES ERJ3GE JPW V	T	10.6/78.7
R64	7030003860	S.RES ERJ3GE JPW V	T	9.3/74.8
R65	7030003860	S.RES ERJ3GE JPW V	T	8/74.8
R66	7030003520	S.RES ERJ3GEYJ 472 V (4.7 k)	B	15.6/81.6
R67	7030003200	S.RES ERJ3GEYJ 100 V (10)	T	99.8/90.4
R68	7030003200	S.RES ERJ3GEYJ 100 V (10)	T	98.5/90.4
R69	7030003200	S.RES ERJ3GEYJ 100 V (10)	T	97.2/90.4
R70	7030004040	S.RES ERJ3GEYJ 4R7 V (4.7)	T	104.8/65.9
R71	7030004040	S.RES ERJ3GEYJ 4R7 V (4.7)	T	103.5/65.9
R72	7030004040	S.RES ERJ3GEYJ 4R7 V (4.7)	T	102.2/65.9
R73	7030004040	S.RES ERJ3GEYJ 4R7 V (4.7)	T	100.9/65.9
R74	7030004040	S.RES ERJ3GEYJ 4R7 V (4.7)	T	99.6/65.9
R75	7030004040	S.RES ERJ3GEYJ 4R7 V (4.7)	T	98.3/65.9
R76	7030004040	S.RES ERJ3GEYJ 4R7 V (4.7)	T	97/65.9
R77	7030004040	S.RES ERJ3GEYJ 4R7 V (4.7)	T	95.7/65.9
R78	7030004040	S.RES ERJ3GEYJ 4R7 V (4.7)	B	120.1/64.6
R84	7030003240	S.RES ERJ3GEYJ 220 V (22)	B	110.5/64.6
R85	7030003240	S.RES ERJ3GEYJ 220 V (22)	B	108.9/64.6
R86	7030003560	S.RES ERJ3GEYJ 103 V (10 k)	B	116.1/83.6
R87	7030003440	S.RES ERJ3GEYJ 102 V (1 k)	T	71.8/94.4
R88	7030003440	S.RES ERJ3GEYJ 102 V (1 k)	T	75.7/88.1
R89	7030003440	S.RES ERJ3GEYJ 102 V (1 k)	T	73.3/94.4
R90	7030003440	S.RES ERJ3GEYJ 102 V (1 k)	T	77.2/88.1
R91	7030003440	S.RES ERJ3GEYJ 102 V (1 k)	T	74.8/94.4
R92	7030003440	S.RES ERJ3GEYJ 102 V (1 k)	T	78.7/88.1
R93	7030003440	S.RES ERJ3GEYJ 102 V (1 k)	T	76.3/94.4
R95	7030003860	S.RES ERJ3GE JPW V	T	15.7/78.7
R97	7030003860	S.RES ERJ3GE JPW V	T	8/78.7
R101	7030010950	S.RES ERJ1TYJ 100U (10)	T	16.4/39.4
R102	7030010950	S.RES ERJ1TYJ 100U (10)	T	20.2/39.4
R103	7030003560	S.RES ERJ3GEYJ 103 V (10 k)	B	16.7/42.9
R104	7030003510	S.RES ERJ3GEYJ 392 V (3.9 k)	B	20.3/42.9
R105	7030003720	S.RES ERJ3GEYJ 224 V (220 k)	B	15.1/44.5
R106	7030003720	S.RES ERJ3GEYJ 224 V (220 k)	B	21.9/44.5
R107	7030003660	S.RES ERJ3GEYJ 683 V (68 k)	T	12.4/45.8
R108	7030003660	S.RES ERJ3GEYJ 683 V (68 k)	T	24.1/45.8
R109	7030003720	S.RES ERJ3GEYJ 224 V (220 k)	T	12.4/47.1
R110	7030003720	S.RES ERJ3GEYJ 224 V (220 k)	T	24.1/47.1
R111	7030003440	S.RES ERJ3GEYJ 275V (2.7 M)	T	12.4/48.4
R112	7030003810	S.RES ERJ3GEYJ 125 V (1.2 M)	T	24.1/48.4
R113	7030003440	S.RES ERJ3GEYJ 102 V (1 k)	B	14.5/51.4
R114	7030003440	S.RES ERJ3GEYJ 102 V (1 k)	B	22.4/51.4
R115	7030009340	S.RES ERJ3GEYJ 275V (2.7 M)	T	12.4/49.7
R118	7030003860	S.RES ERJ3GE JPW V	B	17.5/40.5
R131	7030003440	S.RES ERJ3GEYJ 102 V (1 k)	B	73.1/81
R132	7030003440	S.RES ERJ3GEYJ 102 V (1 k)	B	70.1/81.9
R133	7030003440	S.RES ERJ3GEYJ 102 V (1 k)	B	73.2/82.8
R134	7030003440	S.RES ERJ3GEYJ 102 V (1 k)	B	70.1/83.7
R135	7030003440	S.RES ERJ3GEYJ 102 V (1 k)	B	73.2/84.6
R136	7030003440	S.RES ERJ3GEYJ 102 V (1 k)	B	70.1/85.5
R137	7030003440	S.RES ERJ3GEYJ 102 V (1 k)	B	73.1/86.4
R138	7030003440	S.RES ERJ3GEYJ 102 V (1 k)	B	70.1/87.5
R139	7030003440	S.RES ERJ3GEYJ 102 V (1 k)	T	63.8/94.4
R140	7030003440	S.RES ERJ3GEYJ 102 V (1 k)	T	65.1/94.4
R141	7030			

[CTRL BOARD]

REF NO.	ORDER NO.	DESCRIPTION	M.	H/V LOCATION
R153	7030007190	S.RES ERJ12YJ220U (22)	T	32.8/41.4
R154	7030010620	S.RES ERJ12YJ180U (18)	B	33.2/41.4
R155	7030003320	S.RES ERJ3GEYJ 101 V (100)	T	33.9/45.5
R157	7030003320	S.RES ERJ3GEYJ 101 V (100)	B	27.9/47.4
R158	7030003560	S.RES ERJ3GEYJ 103 V (10 k)	B	27.1/49.8
R159	7030003560	S.RES ERJ3GEYJ 103 V (10 k)	B	38.5/51.2
R160	7030003280	S.RES ERJ3GEYJ 470 V (47)	B	27.1/52.9
R161	7030003280	S.RES ERJ3GEYJ 470 V (47)	B	38.5/54.3
R162	7030003440	S.RES ERJ3GEYJ 102 V (1 k)	B	25.5/56
R163	7030003440	S.RES ERJ3GEYJ 102 V (1 k)	B	40.1/54.3
R164	7030003280	S.RES ERJ3GEYJ 470 V (47)	T	30.5/48.6
R165	7030003280	S.RES ERJ3GEYJ 470 V (47)	T	37.9/48.6
R166	7030003440	S.RES ERJ3GEYJ 102 V (1 k)	T	31.8/48.6
R167	7030003440	S.RES ERJ3GEYJ 102 V (1 k)	T	36.6/48.6
R168	7030003280	S.RES ERJ3GEYJ 470 V (47)	T	37.3/53
R169	7030003440	S.RES ERJ3GEYJ 102 V (1 k)	T	37.3/51.7
R170	7030003280	S.RES ERJ3GEYJ 470 V (47)	B	31.9/60.8
R171	7030003280	S.RES ERJ3GEYJ 470 V (47)	B	33.5/60.8
R172	7030003480	S.RES ERJ3GEYJ 222 V (2.2 k)	B	36.7/60.8
R173	7030003500	S.RES ERJ3GEYJ 332 V (3.3 k)	B	30.3/63.9
R174	7030003360	S.RES ERJ3GEYJ 221 V (220)	B	44.2/61.6
R201	7030010420	S.RES ERJ1TYJ 560U (56)	T	47.3/37.5
R202	7030010420	S.RES ERJ1TYJ 560U (56)	B	47.9/37.2
R203	7030010420	S.RES ERJ1TYJ 560U (56)	T	47.3/41.5
R204	7030010420	S.RES ERJ1TYJ 560U (56)	B	47.9/41.8
R205	7030003560	S.RES ERJ3GEYJ 103 V (10 k)	T	47.8/49.1
R206	7030003560	S.RES ERJ3GEYJ 103 V (10 k)	B	51.5/48.4
R207	7030003800	S.RES ERJ3GEYJ 105 V (1 M)	T	50.2/49.1
R208	7030003560	S.RES ERJ3GEYJ 103 V (10 k)	B	53.1/51.5
R209	7030003520	S.RES ERJ3GEYJ 472 V (4.7 k)	B	54.8/48.1
R210	7030003360	S.RES 220 ERJ3GE	B	55.5/50.6
R211	7030003480	S.RES ERJ3GEYJ 222 V (2.2 k)	B	60.7/67.4
R212	7030003560	S.RES ERJ3GEYJ 103 V (10 k)	B	59.1/49
R213	7030005331	S.RES ERA3YED 562V (5.6 k)	B	63.8/64.2
R214	7030005331	S.RES ERA3YED 562V (5.6 k)	B	62.2/64.2
R215	7030005871	S.RES ERA3YKD 104V (100 k)	B	59.8/65
R216	7030005331	S.RES ERA3YED 562V (5.6 k)	B	62.2/52.3
R216	7030008121	S.RES ERA3YED 682V (6.8 k)	B	62.2/52.3
R217	7030008121	S.RES ERA3YED 682V (6.8 k)	B	63.8/52
R218	7030005871	S.RES ERA3YKD 104V (100 k)	B	59.8/51.4
R221	7030003670	S.RES ERJ3GEYJ 823 V (82 k)	B	57.4/58.2
R222	7030003680	S.RES ERJ3GEYJ 104 V (100 k)	B	65.4/52.7
R223	7030003820	S.RES ERJ3GEYJ 155 V (1.5 M)	B	59.8/63.4
R224	7030003820	S.RES ERJ3GEYJ 155 V (1.5 M)	B	59.8/53
R225	7030003560	S.RES ERJ3GEYJ 103 V (10 k)	B	57.6/61.9
R226	7030003560	S.RES ERJ3GEYJ 103 V (10 k)	B	57.6/54.5
R227	7030003560	S.RES ERJ3GEYJ 103 V (10 k)	B	54.4/61.7
R228	7030003560	S.RES ERJ3GEYJ 103 V (10 k)	B	52.8/61.7
R251	7540000100	ABS SRYH-350L		
R301	7030003560	S.RES ERJ3GEYJ 103 V (10 k)	B	82.8/49.8
R302	7030003670	S.RES ERJ3GEYJ 823 V (82 k)	B	83.4/55.9
R302	7030003680	S.RES ERJ3GEYJ 104 V (100 k)	B	83.4/55.9
R303	7030010910	S.RES ERJ1TYJ 150U (15)	B	95.9/60.6
R304	7030003670	S.RES ERJ3GEYJ 823 V (82 k)	B	84.1/59.9
R305	7030003720	S.RES ERJ3GEYJ 224 V (220 k)	B	81.7/57.8
R306	7030003660	S.RES ERJ3GEYJ 683 V (68 k)	T	85.2/60.5
R307	7030003660	S.RES ERJ3GEYJ 683 V (68 k)	B	80.1/55.1
R308	7030003840	S.RES ERJ3GEYJ 225 V (2.2 M)	T	81.6/55.1
R309	7030003720	S.RES ERJ3GEYJ 224 V (220 k)	T	88.6/59.8
R310	7030003840	S.RES ERJ3GEYJ 225 V (2.2 M)	T	87.8/57.7
R311	7030003440	S.RES ERJ3GEYJ 102 V (1 k)	T	85.2/57.7
R311	7030003560	S.RES ERJ3GEYJ 103 V (10 k)	T	85.2/57.7
R312	7030003560	S.RES ERJ3GEYJ 103 V (10 k)	T	86.5/57.7
R312	7030003680	S.RES ERJ3GEYJ 104 V (100 k)	T	86.5/57.7
R313	7030003700	S.RES ERJ3GEYJ 154 V (150 k)	T	81.7/55.1
R345	7030003560	S.RES ERJ3GEYJ 103 V (10 k)	T	88.3/82.8
R346	7030003630	S.RES ERJ3GEYJ 393 V (39 k)	B	105.1/96.5
R351	7030003440	S.RES ERJ3GEYJ 102 V (1 k)	B	103.2/9.9
R401	7030003240	S.RES ERJ3GEYJ 220 V (22)	T	17.5/93.4
R402	7030003240	S.RES ERJ3GEYJ 220 V (22)	T	16.2/93.4
R403	7030003240	S.RES ERJ3GEYJ 220 V (22)	T	14.9/93.4
R404	7030003240	S.RES ERJ3GEYJ 220 V (22)	T	13.6/93.4
R405	7030003240	S.RES ERJ3GEYJ 220 V (22)	T	12.3/93.4
R406	7030003240	S.RES ERJ3GEYJ 220 V (22)	T	11/93.4
R407	7030003240	S.RES ERJ3GEYJ 220 V (22)	T	9.7/93.4
R408	7030003240	S.RES ERJ3GEYJ 220 V (22)	T	8.4/93.4
R409	7030003240	S.RES ERJ3GEYJ 220 V (22)	B	36.6/86.7
R410	7030003240	S.RES ERJ3GEYJ 220 V (22)	B	35.1/86.7
R411	7030003240	S.RES ERJ3GEYJ 220 V (22)	B	33.6/86.7
R412	7030003240	S.RES ERJ3GEYJ 220 V (22)	B	32/86.7
R413	7030003240	S.RES ERJ3GEYJ 220 V (22)	B	33.2/93
R414	7030003240	S.RES ERJ3GEYJ 220 V (22)	B	36.9/92.2
R415	7030003240	S.RES ERJ3GEYJ 220 V (22)	B	33.2/91.3
R416	7030003240	S.RES ERJ3GEYJ 220 V (22)	B	36.8/90.5
R417	7030003480	S.RES ERJ3GEYJ 222 V (2.2 k)	B	30.8/98.5
R418	7030003480	S.RES ERJ3GEYJ 222 V (2.2 k)	B	46.4/98.5
R419	7030003480	S.RES ERJ3GEYJ 222 V (2.2 k)	B	32.0/98.5
R420	7030003480	S.RES ERJ3GEYJ 222 V (2.2 k)	B	48/98.5
R421	7030003480	S.RES ERJ3GEYJ 222 V (2.2 k)	B	34/98.5
R422	7030003480	S.RES ERJ3GEYJ 222 V (2.2 k)	B	49.6/98.5
R423	7030003480	S.RES ERJ3GEYJ 222 V (2.2 k)	B	35.6/98.5
R424	7030003480	S.RES ERJ3GEYJ 222 V (2.2 k)	B	51.2/98.5
R425	7030003480	S.RES ERJ3GEYJ 222 V (2.2 k)	B	37.2/98.5
R426	7030003480	S.RES ERJ3GEYJ 222 V (2.2 k)	B	52.8/98.5
R427	7030003480	S.RES ERJ3GEYJ 222 V (2.2 k)	B	38.8/98.5
R428	7030003480	S.RES ERJ3GEYJ 222 V (2.2 k)	B	54.4/98.5
R429	7030003480	S.RES ERJ3GEYJ 222 V (2.2 k)	B	40.4/98.5
R430	7030003480	S.RES ERJ3GEYJ 222 V (2.2 k)	B	56/98.5
R431	7030003480	S.RES ERJ3GEYJ 222 V (2.2 k)	B	42/98.5
R432	7030003480	S.RES ERJ3GEYJ 222 V (2.2 k)	B	57.6/98.5
R433	7030003720	S.RES ERJ3GEYJ 224 V (220 k)	B	46.5/7.9
R434	7030010580	S.RES ERJ1TYJ 1R5U (1.5)	T	31/4.6
R434	7030011130	S.RES ERJ1TYJ 1R0U (1)	T	31/4.6
R435	7030010580	S.RES ERJ1TYJ 1R5U (1.5)	T	31/8.8

[CTRL BOARD]

REF NO.	ORDER NO.	DESCRIPTION	M.	H/V LOCATION
R435	7030011130	S.RES ERJ1TYJ 1R0U (1)	T	31/8.8
R436	7030010580	S.RES ERJ1TYJ 1R5U (1.5)	B	38.8/8.8
R436	7030011130	S.RES ERJ1TYJ 1R0U (1)	B	38.8/8.8
R437	7030010580	S.RES ERJ1TYJ 1R5U (1.5)	B	38.8/4.6
R437	7030011130	S.RES ERJ1TYJ 1R0U (1)	B	38.8/4.6
R438	7030003640	S.RES ERJ3GEYJ 473 V (47 k)	T	22.7/8.3
R439	7030003340	S.RES ERJ3GEYJ 151 V (150)	T	22.7/5.2
R439	7030003400	S.RES ERJ3GEYJ 471 V (470)	T	22.7/5.2
R440	7030003400	S.RES ERJ3GEYJ 471 V (470)	B	30.5/8.3
R440	7030003440	S.RES ERJ3GEYJ 102 V (1 k)	B	30.5/8.3
R441	7030003560	S.RES ERJ3GEYJ 103 V (10 k)	B	30.5/5.2
R442	7030003640	S.RES ERJ3GEYJ 473 V (47 k)	B	32.1/8.3
R443	7030003640	S.RES ERJ3GEYJ 473 V (47 k)	T	99.5/13.5
C1	4510008540	S.ELE EEE1CA100SR	T	42.6/80.3
C2	4030011600	S.CER C1608 JB 1E 104K-T	T	45.8/82.3
C3	4030006880	S.CER C1608 JB 1H 472K-T	B	83.5/100
C4	4030006900	S.CER C1608 JB 1H 103K-T	T	56/74.7
C5	4030006900	S.CER C1608 JB 1H 103K-T	T	58.6/79.2
C7	4030017810	S.CER C1608 CH 1H 102J-T	T	75.3/76.6
C8	4030011600	S.CER C1608 JB 1E 104K-T	T	56/81.3
C9	4030009990	S.CER C1608 CH 1H 200J-T	T	75.3/80.5
C10	4030011600	S.CER C1608 JB 1E 104K-T	T	51.7/79.8
C11	4030006880	S.CER C1608 JB 1H 472K-T	T	76.6/78.2
C12	4030009990	S.CER C1608 CH 1H 200J-T	T	76.6/81.5
C13	4510008750	S.ELE EEE1AA471UP	T	48.6/56.5
C14	4030011600	S.CER C1608 JB 1E 104K-T	T	67.4/56.2
C15	4030011600	S.CER C1608 JB 1E 104K-T	T	72.9/56.3
C16	4510008500	S.ELE EEE1CA101WP	T	75.3/50.5
C17	4510008550	S.ELE EEE1HA010SR	T	133.3/100.5
C18	4510008550	S.ELE EEE1HA010SR	T	133.3/95.7
C19	4510008550	S.ELE EEE1HA010SR	T	138.4/91.9
C20	4510008550	S.ELE EEE1HA010SR	T	133.3/89.7
C21	4510008550	S.ELE EEE1HA010SR	T	138.4/85.3
C22	4510008550	S.ELE EEE1HA010SR	T	133.3/83.1
C23	4510008550	S.ELE EEE1HA010SR	T	138.4/78.6
C24	4510008550	S.ELE EEE1HA010SR	T	133.3/76.5
C25	4030011600	S.CER C1608 JB 1E 104K-T	T	62.2/57.1
C26	4030006880	S.CER C1608 JB 1H 472K-T	T	67.4/59
C40	4030011600	S.CER C1608 JB 1E 104K-T	T	84/70.6
C41	4030011600	S.CER C1608 JB 1E 104K-T	T	78.5/73.2
C43	4030006880	S.CER C1608 JB 1H 472K-T	B	85.7/97.3
C45	4030011600	S.CER C1608 JB 1E 104K-T	T	92.2/88.2
C46	4510008750	S.ELE EEE1AA471UP	T	66.9/49.2
C48	4030011600	S.CER C1608 JB 1E 104K-T	B	118.9/97.7
C66	4510008540	S.ELE EEE1CA100SR	T	106.6/81.6
C68	4030011600	S.CER C1608 JB 1E 104K-T	B	106.7/78.4
C69	4030011600	S.CER C1608 JB 1E 104K-T	T	118.4/79.9
C70	4030011600	S.CER C1608 JB 1E 104K-T	T	95.8/80.5
C71	4030011600	S.CER C1608 JB 1E 104K-T	T	106.9/77.6
C72	4510008540	S.ELE EEE1CA100SR	T	111.6/83.3
C88	4030011600	S.CER C1608 JB 1E 104K-T	B	6.9/78.2
C101	4030011070	S.CER GRM31M2C2H5R0CY21L	B	10.8/12.6
C102	4010005530	CER HM60SJ SL 020C 500V		
C103	4010005530	CER HM60SJ SL 020C 500V		
C105	4030007070	S.CER C1608 CH 1H 330J-T	B	11.4/35.6
C106	4030011540	S.CER C1608 CH 1H 750J-T	B	20.3/34
C107	4030017810	S.CER C1608 CH 1H 102J-T	B	13.6/42.9
C108	4030017810	S.CER C1608 CH 1H 102J-T	B	23.4/42.9
C109	4030006880	S.CER C1608 JB 1H 472K-T	B	20/47.9
C110	4030006880	S.CER C1608 JB 1H 472K-T	B	16.9/47.9
C111	4510008540	S.ELE EEE1CA100SR	T	22.8/54.1
C112	4510008540	S.ELE EEE1CA100SR	T	18/54.1
C113	4030006880	S.CER C1608 JB 1H 472K-T	B	16.9/50.7
C114	4030006880	S.CER C1608 JB 1H 472K-T	B	20/50.7
C115	4030007070	S.CER C1608 CH 1H 330J-T	B	11.4/34
C116	4030011540	S.CER C1608 CH 1H 750J-T	B	20.3/32.4
C119	4030007100	S.CER C1608 CH 1H 560J-T	B	14.7/34
C119	4030007110	S.CER C1608 CH 1H 680J-T	B	14.7/34
C120	4030007070	S.CER C1608 CH 1H 330J-T	B	11.4/32.4
C121	4030007070	S.CER C1608 CH 1H 330J-T	B	10.7/37
C122	4030009530	S.CER C1608 CH 1H 030B-T	B	10.6/38.6
C151	4010005540	CER HM60SJ SL 030C 500V		
C152	4030007070	S.CER C1608 CH 1H 330J-T	B	27.6/45
C153	4030007120	S.CER C1608 CH 1H 820J-T	B	29.2/45
C154	4030007070	S.CER C1608 CH 1H 330J-T	T	31.1/44.2
C155	4030007120	S.CER C1608 CH 1H 820J-T	T	33.9/44.2
C156	4030006880	S.CER C1608 JB 1H 472K-T	B	30.8/45
C157	4030006880	S.CER		

[CTRL BOARD]

REF NO.	ORDER NO.	DESCRIPTION	M.	H/V LOCATION
C212	4030006880	S.CER C1608 JB 1H 472K-T	B	60.7/49
C213	4030006880	S.CER C1608 JB 1H 472K-T	B	65.4/56.6
C214	4030007170	S.CER C1608 CH 1H 221J-T	B	56.7/64.1
C215	4030007170	S.CER C1608 CH 1H 221J-T	B	56.7/52.3
C216	4030011340	S.CER C1608 CH 1H 471J-T	B	56/61.9
C217	4030011340	S.CER C1608 CH 1H 471J-T	B	56/54.5
C218	4030006880	S.CER C1608 JB 1H 472K-T	B	65.4/59.7
C221	4030018400	S.CER 33P CM105 CH G	T	51.2/45.7
C222	4030018400	S.CER 33P CM105 CH G	T	49.9/45.7
C251	4030011020	S.CER GRM31M4C2H1R0CY21L	B	88.3/32.5
C253	4030006880	S.CER C1608 JB 1H 472K-T	B	76.3/25.9
C254	4030006880	S.CER C1608 JB 1H 472K-T	B	76.3/39.2
C255	4030011090	S.CER GRM31M2C2H7R0DV01L	B	107.7/49.3
C301	4010005520	CER HM60SJ SL 01C0 500V [USA], [EUR], [UK] 4030011020 S.CER GRM31M4C2H1R0CY21L [FRA], [ITR], [ESP], [KOR]		
C302	4030007030	S.CER C1608 CH 1H 150J-T	T	82.1/51.7
C303	4030007050	S.CER C1608 CH 1H 220J-T	T	82.1/49.1
C304	4030017810	S.CER C1608 CH 1H 102J-T	B	85.7/55.1
C305	4030017810	S.CER C1608 CH 1H 102J-T	B	86.5/57.7
C307	4030006880	S.CER C1608 JB 1H 472K-T	T	86.5/60.5
C308	4030011600	S.CER C1608 JB 1E 104K-T	B	78.5/55.1
C309	4030011600	S.CER C1608 JB 1E 104K-T	T	78.4/55.1
C310	4030009530	S.CER C1608 CH 1H 030B-T	T	82.1/50.4
C311	4030012600	S.CER C2012 JB 1A 105M-T	T	86.2/55.4
C417	4510008540	S.ELE EEE1CA100SR	T	22.6/77.6
C418	4510008540	S.ELE EEE1CA100SR	T	40.6/85.6
C419	4030011600	S.CER C1608 JB 1E 104K-T	T	19.6/78.7
C420	4030011600	S.CER C1608 JB 1E 104K-T	T	38.4/79.2
C425	4030018790	S.CER C3225 JB 2E 104K-T	B	77.4/12.1
C426	4030018790	S.CER C3225 JB 2E 104K-T	B	60.3/17
C427	4030006860	S.CER C1608 JB 1H 102K-T	B	67.1/7.9
C428	4030006860	S.CER C1608 JB 1H 102K-T	B	50.1/17.9
C429	4030011600	S.CER C1608 JB 1E 104K-T	B	68.9/7.9
C430	4030011600	S.CER C1608 JB 1E 104K-T	B	48.3/7.9
C431	4030006880	S.CER C1608 JB 1H 472K-T	B	70.7/7.9
C432	4030018790	S.CER C3225 JB 2E 104K-T	B	86/12.3
C433	4030018790	S.CER C3225 JB 2E 104K-T	B	82.7/11.7
C434	4030006880	S.CER C1608 JB 1H 472K-T	T	92.7/11.7
C435	4030011600	S.CER C1608 JB 1E 104K-T	B	20.5/80.1
C436	4030011600	S.CER C1608 JB 1E 104K-T	B	19.5/101.6
RL252	6330001460	RLY FTR-F1CA012V		
RL253	6330001460	RLY FTR-F1CA012V		
RL254	6330001770	RLY SIP-1A-12V		
CP1	6910009670	S.CHK HK3-S-T	T	67.7/100.1
CP101	6910009670	S.CHK HK3-S-T	T	5/83.4
J1	6510023771	S.CNR 52793-2470 (2490)	T	101.8/99.6
J2	6510023761	S.CNR S10B-PH-SM4-TB (LF) (SN)	T	148.3/82.8
J51	6510023771	S.CNR 52793-2470 (2490)	T	43.9/99.6
J52	6510022031	S.CNR B10B-ZR-SM4-TF (LF) (SN)	T	133/2.9
J53	6510021431	S.CNR S8B-ZR-SM4A-TF (LF) (SN)	T	134.6/65
J101	6510017920	CNR 1811P342		
J251	6510017920	CNR 1811P342		
J252	6510017920	CNR 1811P342		
J301	6510017920	CNR 1811P342		
J351	6510007020	CNR TMP-J01X-V6		
W1	9029804001	WIR 72/99/040/X98/X98		
EP1	9040902903	TUB IRRAX 0.7 (d) L=22 mm		
EP3	6910014690	S.BEA MPZ1608S221A-T	B	115.7/68.2
EP4	6910014690	S.BEA MPZ1608S221A-T	B	113.5/62.3
EP5	6910014730	S.BEA MPZ2012S331A-T	B	117.9/95.2
EP6	6910014730	S.BEA MPZ2012S331A-T	T	109.7/91.2
EP7	6910014730	S.BEA MPZ2012S331A-T	T	106.7/91.2
EP8	6910014730	S.BEA MPZ2012S331A-T	T	103.8/91.2
EP9	6910014690	S.BEA MPZ1608S221A-T	T	94/91.7
EP10	6910014730	S.BEA MPZ2012S331A-T	T	90.8/90.6
EP12	6910015970	S.BEA MMZ1608B 301CT-AS	B	95.2/63.3
EP13	6910015970	S.BEA MMZ1608B 301CT-AS	T	79.4/63.1
EP14	6910014730	S.BEA MPZ2012S331A-T	B	56.3/95.6
EP15	6910014730	S.BEA MPZ2012S331A-T	B	44.6/97.9
EP16	6910014730	S.BEA MPZ2012S331A-T	T	28.7/95.5
EP401	6910014690	S.BEA MPZ1608S221A-T	B	28.1/100.9
EP402	6910014690	S.BEA MPZ1608S221A-T	B	21.9/100.9

[NETWORK BOARD]

REF NO.	ORDER NO.	DESCRIPTION	M.	H/V LOCATION
Q300	1520000561	S.TR 2SB1123 T-TD-E	T	205.7/10.5
Q301	1590000680	S.TR DTC114EUA T106	T	201.4/9.1
L50	6110003950	COL LA-598		
L60	6110003910	COL LA-593		
L70	6110003050	COL LA-492		
L80	6110003050	COL LA-492		
L90	6110003060	COL LA-493		
L100	6110003070	COL LA-494		
L110	6110003920	COL LA-594		
L120	6140004460	COL LR-504		
L130	6140004470	COL LR-505		
L131	6140004470	COL LR-505		
L300	6180000990	COL LAL 04NA 101K		
R300	7030000420	S.RES MCR10EZHZJ 2.2 k	T	202.8/6.9
R301	7030000420	S.RES MCR10EZHZJ 2.2 k	T	201.5/11.3
R302	7030000420	S.RES MCR10EZHZJ 2.2 k	T	206.2/6.9
R303	7030009800	S.RES ERJ12YJ121U (120)	T	209.7/5
C1	4620000120	VAR KB-150-07 150P		
C2	4620000120	VAR KB-150-07 150P		
C3	4010007580	CER HT20SJ SL 201J 3KV		
C4	4010007580	CER HT20SJ SL 201J 3KV		
C5	4010007580	CER HT20SJ SL 201J 3KV		
C6	4010007580	CER HT20SJ SL 201J 3KV		
C7	4010007580	CER HT20SJ SL 201J 3KV		
C8	4010007580	CER HT20SJ SL 201J 3KV		
C9	4010007580	CER HT20SJ SL 201J 3KV		
C10	4010007580	CER HT20SJ SL 201J 3KV		
C18	4030006880	S.CER C1608 JB 1H 472K-T	T	92.6/102.4
C19	4030006880	S.CER C1608 JB 1H 472K-T	T	95.2/1.3
C20	4010007570	CER HT15SJ SL 151J 3KV		
C21	4010007570	CER HT15SJ SL 151J 3KV		
C22	4010007570	CER HT15SJ SL 151J 3KV		
C23	4010007570	CER HT15SJ SL 151J 3KV		
C24	4010007570	CER HT15SJ SL 151J 3KV		
C25	4010007570	CER HT15SJ SL 151J 3KV		
C26	4010007570	CER HT15SJ SL 151J 3KV		
C27	4010007570	CER HT15SJ SL 151J 3KV		
C28	4030006880	S.CER C1608 JB 1H 472K-T	T	84.3/102.4
C29	4030006880	S.CER C1608 JB 1H 472K-T	T	85.3/1.3
C30	4010007550	CER HT11SJ SL 820J 3KV		
C31	4010007550	CER HT11SJ SL 820J 3KV		
C32	4010007550	CER HT11SJ SL 820J 3KV		
C33	4010007550	CER HT11SJ SL 820J 3KV		
C34	4010007550	CER HT11SJ SL 820J 3KV		
C35	4010007550	CER HT11SJ SL 820J 3KV		
C36	4010007550	CER HT11SJ SL 820J 3KV		
C37	4010007550	CER HT11SJ SL 820J 3KV		
C38	4030006880	S.CER C1608 JB 1H 472K-T	T	65.7/102.4
C39	4030006880	S.CER C1608 JB 1H 472K-T	T	71.8/1.3
C40	4010008550	CER DEA1X3F390JC3B		
C41	4010008550	CER DEA1X3F390JC3B		
C42	4010008550	CER DEA1X3F390JC3B		
C43	4010008550	CER DEA1X3F390JC3B		
C44	4010008550	CER DEA1X3F390JC3B		
C45	4010008550	CER DEA1X3F390JC3B		
C46	4010008550	CER DEA1X3F390JC3B		
C47	4010008550	CER DEA1X3F390JC3B		
C48	4030006880	S.CER C1608 JB 1H 472K-T	T	106.1/102.4
C49	4030006880	S.CER C1608 JB 1H 472K-T	T	112.1/1.3
C50	4030006880	S.CER C1608 JB 1H 472K-T	T	140.7/12
C60	4030006880	S.CER C1608 JB 1H 472K-T	T	154.1/12
C70	4030006880	S.CER C1608 JB 1H 472K-T	T	167.5/16.1
C80	4030006880	S.CER C1608 JB 1H 472K-T	T	181.9/21.5
C90	4030006880	S.CER C1608 JB 1H 472K-T	T	195.3/21.3
C100	4030006880	S.CER C1608 JB 1H 472K-T	T	204.4/20.7
C110	4030006880	S.CER C1608 JB 1H 472K-T	T	205.8/20.7
C120	4030006880	S.CER C1608 JB 1H 472K-T	T	207.2/20.6
C211	4030006880	S.CER C1608 JB 1H 472K-T	T	196.2/16.4
C212	4030006880	S.CER C1608 JB 1H 472K-T	T	194.1/18.9
C213	4030006880	S.CER C1608 JB 1H 472K-T	T	192.1/19.6
C214	4030006880	S.CER C1608 JB 1H 472K-T	T	190.7/19.6
C301	4030006880	S.CER C1608 JB 1H 472K-T	T	210.5/10.1
C303	4030006880	S.CER C1608 JB 1H 472K-T	T	199.3/9
RL10	6330001200	RLY VS-12MBU-UC		
RL11	6330001200	RLY VS-12MBU-UC		
RL20	6330001200	RLY VS-12MBU-UC		
RL21	6330001200	RLY VS-12MBU-UC		
RL30	6330001200	RLY VS-12MBU-UC		
RL31	6330001200	RLY VS-12MBU-UC		
RL40	6330001200	RLY VS-12MBU-UC		
RL41	6330001200	RLY VS-12MBU-UC		
RL50	6330001460	RLY FTR-F1CA012V		
RL60	6330001200	RLY VS-12MBU-UC		
RL70	6330001200	RLY VS-12MBU-UC		
RL80	6330001200	RLY VS-12MBU-UC		
RL90	6330001200	RLY VS-12MBU-UC		
RL100	6330001200	RLY VS-12MBU-UC		
RL110	6330001200	RLY VS-12MBU-UC		
RL120	6330001200	RLY VS-12MBU-UC		
J1	6510022472	S.CNR 40FLT-SM2-TB(LF)(SN)(M)	T	184.9/7.4
J2	6510017930	CNR 1771P145-20		
J3	6510017930	CNR 1771P145-20		
J4	6510003521	CNR S04B-EH-S (LF) (SN)		

M.=Mounted side (T: Mounted on the Top side B: Mounted on the Bottom side)
S.=Surface mount

[NETWORK BOARD]

REF NO.	ORDER NO.	DESCRIPTION	M.	H/V LOCATION
EP2	6910014730	S.BEA MPZ2012S331A-T	T	198.2/3.3
EP3	6910014730	S.BEA MPZ2012S331A-T	T	183.9/2.7
EP4	6910014730	S.BEA MPZ2012S331A-T	T	170.7/4
EP202	6910015970	S.BEA MMZ1608B 301CT-AS	T	187.4/11.9
EP203	6910015970	S.BEA MMZ1608B 301CT-AS	T	188.4/14.6
EP204	6910015970	S.BEA MMZ1608B 301CT-AS	T	189.4/11.9
EP205	6910015970	S.BEA MMZ1608B 301CT-AS	T	190.4/14.6
EP206	6910015970	S.BEA MMZ1608B 301CT-AS	T	191.4/11.9
EP207	6910015970	S.BEA MMZ1608B 301CT-AS	T	192.4/14.6
EP208	6910015970	S.BEA MMZ1608B 301CT-AS	T	193.4/11.9
EP209	6910015970	S.BEA MMZ1608B 301CT-AS	T	194.4/14.6
EP252	6910015970	S.BEA MMZ1608B 301CT-AS	T	175.4/11.8
EP253	6910015970	S.BEA MMZ1608B 301CT-AS	T	176.4/14.2
EP254	6910015970	S.BEA MMZ1608B 301CT-AS	T	177.4/11.8
EP255	6910015970	S.BEA MMZ1608B 301CT-AS	T	178.4/14.2
EP256	6910015970	S.BEA MMZ1608B 301CT-AS	T	179.4/11.8
EP257	6910015970	S.BEA MMZ1608B 301CT-AS	T	180.4/14.2
EP258	6910015970	S.BEA MMZ1608B 301CT-AS	T	181.4/11.8
EP259	6910015970	S.BEA MMZ1608B 301CT-AS	T	182.4/14.2
EP300	6910015970	S.BEA MMZ1608B 301CT-AS	T	185/11.8

[ANT-SW BOARD]

REF NO.	ORDER NO.	DESCRIPTION	M.	H/V LOCATION
IC11	1130011510	S.IC BU2099FV-E2	T	160.6/33.6
IC12	1180002391	S.REG S-812C33AMC-C2N-G	T	152.4/28.7
Q11	1590001001	S.TR RN2427 (TE85L,F)	T	156.9/38.6
Q12	1590001001	S.TR RN2427 (TE85L,F)	T	152.3/36.9
Q13	1590001001	S.TR RN2427 (TE85L,F)	T	164.7/38.5
Q14	1590001001	S.TR RN2427 (TE85L,F)	T	164.7/17.5
D51	1750000550	S.DIO 1SS355 TE-17	T	161.9/13.3
D61	1750000550	S.DIO 1SS355 TE-17	T	118.9/19.7
D71	1750000550	S.DIO 1SS355 TE-17	T	68.7/21.4
D81	1750000550	S.DIO 1SS355 TE-17	T	36.9/19.7
D83	1750000550	S.DIO 1SS355 TE-17	T	28.2/45.3
D84	1750000550	S.DIO 1SS355 TE-17	T	25.8/43
L2	6110001670	COL LA-253		
R3	7540000130	ABS 2P-50A-301		
R11	7030003320	S.RES ERJ3GEYJ 101 V (100)	T	165.5/27.4
R12	7030003320	S.RES ERJ3GEYJ 101 V (100)	T	164.2/27.4
R13	7030003320	S.RES ERJ3GEYJ 101 V (100)	T	162.9/27.4
R14	7030003320	S.RES ERJ3GEYJ 101 V (100)	T	166.2/33.9
R15	7030003320	S.RES ERJ3GEYJ 101 V (100)	T	153.9/32.6
R17	7030003320	S.RES ERJ3GEYJ 101 V (100)	T	154.7/39.4
R18	7030003320	S.RES ERJ3GEYJ 101 V (100)	T	153.9/34
R20	7030003320	S.RES ERJ3GEYJ 101 V (100)	T	152.1/39.1
R21	7030003320	S.RES ERJ3GEYJ 101 V (100)	T	154.7/36.6
R23	7030003320	S.RES ERJ3GEYJ 101 V (100)	T	162.3/39.1
R24	7030003320	S.RES ERJ3GEYJ 101 V (100)	T	161/39.1
R26	7030003320	S.RES ERJ3GEYJ 101 V (100)	T	162.7/15.6
C1	4010005610	CER HM60SJ SL 100D 500V		
C2	4010005660	CER HM60SJ SL 220J 500V		
C11	4030011600	S.CER C1608 JB 1E 104K-T	T	160.7/29.4
C12	4030011600	S.CER C1608 JB 1E 104K-T	T	154.9/27.9
C51	4030006880	S.CER C1608 JB 1H 472K-T	T	163.5/13.6
C61	4030006880	S.CER C1608 JB 1H 472K-T	T	119.2/21.3
C71	4030006880	S.CER C1608 JB 1H 472K-T	T	69/19.9
C81	4030006880	S.CER C1608 JB 1H 472K-T	T	37.2/21.3
C83	4030006880	S.CER C1608 JB 1H 472K-T	T	26.6/45.6
C84	4030006880	S.CER C1608 JB 1H 472K-T	T	25/45.6
RL51	6330001460	RLY FTR-F1CA012V		
RL61	6330001460	RLY FTR-F1CA012V		
RL71	6330001460	RLY FTR-F1CA012V		
RL81	6330001460	RLY FTR-F1CA012V		
RL83	6330001780	RLY FTR-MYAA012D		
RL84	6330001780	RLY FTR-MYAA012D		
J1	6510017930	CNR 1771P145-20		
J3	6510007020	CNR TMP-J01X-V6		
J4	6510019971	S.CNR 52808-1071	T	153/22
J51	6510000410	CNR MR-DS-E 02		
J61	6510000410	CNR MR-DS-E 02		
J71	6510000410	CNR MR-DS-E 02		
J81	6510000410	CNR MR-DS-E 02		
EP2	6910014730	S.BEA MPZ2012S331A-T	T	151.5/26.1

[OSC UNIT]

REF NO.	ORDER NO.	DESCRIPTION	M.	H/V LOCATION
IC10	1180002610	S.REG BA12FP-E2	T	59.9/37.5
IC1091	1190002001	S.IC AD5260BRUZ50	T	26.8/12
IC1092	1130005721	S.IC TC7W04F (TE12L,F)	T	23.7/6.1
Q1010	1590000680	S.TR DTC114EUA T106	T	30.7/17.9
Q1011	1590000680	S.TR DTC114EUA T106	T	24.9/36.4
Q1012	1590000680	S.TR DTC114EUA T106	T	44.4/32.8
Q1013	1590000680	S.TR DTC114EUA T106	T	41.8/32.8
Q1021	1530002060	S.TR 2SC4081 T106 R	T	11.3/6.3
Q1022	1530002601	S.TR 2SC4215-O (TE85R,F)	T	10.4/17.8
Q1023	1590000680	S.TR DTC114EUA T106	T	13.1/11
Q1042	1530002601	S.TR 2SC4215-O (TE85R,F)	T	18.8/18.8
Q1043	1590000680	S.TR DTC114EUA T106	T	19.7/11.7
Q1061	1530002060	S.TR 2SC4081 T106 R	T	29.8/29.6
Q1062	1530002060	S.TR 2SC4081 T106 R	T	24/32
Q1070	1530002060	S.TR 2SC4081 T106 R	T	18.3/41.3
Q1101	1530002700	S.TR 2SC4097 T106Q	T	66.1/17.8
D1010	1790001250	S.DIO MA2S111-(TX)	T	30.5/16
D1011	1790001250	S.DIO MA2S111-(TX)	T	21.7/37.4
D1071	1750000381	S.DIO 1SS312 (TE85L,F)	T	32.4/27
D1072	1750000381	S.DIO 1SS312 (TE85L,F)	T	32.7/30.4
X10	6050012210	XTL CR-772.OCVXO-148A		
L1020	6200005491	S.COL NLV32T-331J	T	14.7/1.9
L1021	6200003261	S.COL NLV32T-101J	T	7.7/10.9
L1022	6200003261	S.COL NLV32T-101J	T	6.2/16
L1023	6200003051	S.COL NLV32T-R82J	T	6.9/20.3
L1024	6200003051	S.COL NLV32T-R82J	T	6.2/23.8
L1041	6200003261	S.COL NLV32T-101J	T	15.3/13.7
L1042	6200003261	S.COL NLV32T-101J	T	14.7/17.2
L1043	6200003051	S.COL NLV32T-R82J	T	15.3/22.4
L1044	6200003051	S.COL NLV32T-R82J	T	18.8/24.2
L1061	6150004170	COL LS-476		
L1062	6150004170	COL LS-476		
R1011	7030003200	S.RES ERJ3GEYJ 100 V (10)	T	32.7/17
R1012	7030003200	S.RES ERJ3GEYJ 100 V (10)	T	23.8/38.4
R1013	7030003440	S.RES ERJ3GEYJ 102 V (1)	T	16.9/11.6
R1020	7030003240	S.RES ERJ3GEYJ 220 V (22 k)	T	11.3/1.8
R1021	7030003560	S.RES ERJ3GEYJ 103 V (10 k)	T	11.1/4.4
R1022	7030003370	S.RES ERJ3GEYJ 271 V (270)	T	15.5/7.9
R1023	7030004040	S.RES ERJ3GEYJ 4R7 V (4.7)	T	11.4/14
R1024	7030003370	S.RES ERJ3GEYJ 271 V (270)	T	12.3/17.7
R1025	7030003500	S.RES ERJ3GEYJ 332 V (3.3 k)	T	10.1/14.2
R1026	7030003480	S.RES ERJ3GEYJ 222 V (2.2 k)	T	13/9.1
R1027	7030003360	S.RES ERJ3GEYJ 221 V (220)	T	8.8/14.3
R1028	7030003440	S.RES ERJ3GEYJ 102 V (1 k)	T	10.2/11.9
R1043	7030003240	S.RES ERJ3GEYJ 220 V (22)	T	19.7/14.2
R1044	7030003370	S.RES ERJ3GEYJ 271 V (270)	T	20.7/18.6
R1045	7030003500	S.RES ERJ3GEYJ 332 V (3.3 k)	T	17.9/15.1
R1046	7030003480	S.RES ERJ3GEYJ 222 V (2.2 k)	T	19.5/9.8
R1047	7030003290	S.RES ERJ3GEYJ 560 V (56)	T	16.8/17.9
R1061	7030003240	S.RES ERJ3GEYJ 220 V (22)	T	27.8/28.4
R1062	7030003560	S.RES ERJ3GEYJ 103 V (10 k)	T	29.6/27.7
R1063	7030003380	S.RES ERJ3GEYJ 331 V (330)	T	29.9/31.5
R1064	7030003280	S.RES ERJ3GEYJ 470 V (47)	T	25.2/34
R1065	7030003400	S.RES ERJ3GEYJ 471 V (470)	T	24.3/27.5
R1067	7030003560	S.RES ERJ3GEYJ 103 V (10 k)	T	24.3/30.1
R1068	7030003550	S.RES ERJ3GEYJ 822 V (8.2 k)	T	26/32.2
R1071	7030003340	S.RES ERJ3GEYJ 151 V (150)	T	32.9/33.7
R1072	7030003270	S.RES ERJ3GEYJ 390 V (39)	T	34.8/32.8
R1073	7030003340	S.RES ERJ3GEYJ 151 V (150)	T	32.9/32.4
R1074	7030003320	S.RES ERJ3GEYJ 101 V (100)	T	24.2/41.1
R1075	7030003280	S.RES ERJ3GEYJ 470 V (47)	T	26.2/41.8
R1077	7030003320	S.RES ERJ3GEYJ 101 V (100)	T	11.8/41.7
R1078	7030003480	S.RES ERJ3GEYJ 222 V (2.2 k)	T	16.4/41.2
R1079	7030003590	S.RES ERJ3GEYJ 183 V (18 k)	T	15.1/41.2
R1080	7030003360	S.RES ERJ3GEYJ 221 V (220)	T	21.6/41
R1091	7030006091	S.RES ERA3YED 822V (8.2 k)	T	19.4/7.2
R1092	7030005341	S.RES ERA3YED 332V (3.3 k)	T	19.5/8.5
R1093	7030003560	S.RES ERJ3GEYJ 103 V (10 k)	T	25.6/1.4
R1094	7030003540	S.RES ERJ3GEYJ 682 V (6.8 k)	T	25.6/2.7
R1095	7030003320	S.RES ERJ3GEYJ 101 V (100)	T	22.4/16.7
R1096	7030003440	S.RES ERJ3GEYJ 102 V (1 k)	T	32/13.6
R1097	7030003440	S.RES ERJ3GEYJ 102 V (1 k)	T	32/12.1
R1098	7030003640	S.RES ERJ3GEYJ 473 V (47 k)	T	27.4/16
R1099	7030003480	S.RES ERJ3GEYJ 222 V (2.2 k)	T	22.4/10.1
R1100	7030003640	S.RES ERJ3GEYJ 473 V (47 k)	T	27.2/6.4
R1101	7030003360	S.RES ERJ3GEYJ 221 V (220)	T	66/15.9
R1102	7030005981	S.RES ERA3YED 333V (33 k)	T	32/8.8
R2016	7030003440	S.RES ERJ3GEYJ 102 V (1 k)	T	48.5/36.1
R2017	7030003440	S.RES ERJ3GEYJ 102 V (1 k)	T	45.1/35.7
R2018	7030003440	S.RES ERJ3GEYJ 102 V (1 k)	T	42.5/35.7
C1004	4030006880	S.CER C1608 JB 1H 472K-T	T	29.9/8.4
C1005	4550007670	S.TAN F931C105MAABMA	T	29.2/3.2
C1006	4030006880	S.CER C1608 JB 1H 472K-T	T	33/4
C1007	4550007670	S.TAN F931C105MAABMA	T	31.3/3.2
C1008	4030011600	S.CER C1608 JB 1E 104K-T	T	17.3/2.1
C1010	4510008680	S.ELE EEE1EA220SP	T	52.8/35.2
C1011	4030011600	S.CER C1608 JB 1E 104K-T	T	58.3/32
C1012	4030011600	S.CER C1608 JB 1E 104K-T	T	65.1/34.7
C1013	4030006880	S.CER C1608 JB 1H 472K-T	T	63.8/34.7
C1014	4510008680	S.ELE EEE1EA220SP	T	69/31.2
C1015	4030006880	S.CER C1608 JB 1H 472K-T	T	60.9/32
C1016	4030011600	S.CER C1608 JB 1E 104K-T	T	28.7/16

M.=Mounted side (T: Mounted on the Top side B: Mounted on the Bottom side) S.=Surface mount

[OSC UNIT]

REF NO.	ORDER NO.	DESCRIPTION	M.	H/V LOCATION
C1017	4030011600	S.CER C1608 JB 1E 104K-T	T	21.7/34.8
C1018	4030011600	S.CER C1608 JB 1E 104K-T	T	23/36.6
C1019	4030011600	S.CER C1608 JB 1E 104K-T	T	32.3/14.9
C1020	4030011600	S.CER C1608 JB 1E 104K-T	T	13.3/5.2
C1021	4030011600	S.CER C1608 JB 1E 104K-T	T	11.3/3.1
C1022	4030011600	S.CER C1608 JB 1E 104K-T	T	15.1/11
C1023	4030011600	S.CER C1608 JB 1E 104K-T	T	11.9/15.8
C1024	4030011600	S.CER C1608 JB 1E 104K-T	T	12.7/14
C1025	4030011600	S.CER C1608 JB 1E 104K-T	T	10.2/19.8
C1026	4030011330	S.CER C1608 CH 1H 391J-T	T	10.2/21.1
C1027	4030007050	S.CER C1608 CH 1H 220J-T	T	7.7/18.2
C1028	4030017800	S.CER C1608 CH 1H 561J-T	T	8.9/22.5
C1030	4030007110	S.CER C1608 CH 1H 680J-T	T	8.4/24.5
C1031	4030010760	S.CER C1608 CH 1H 331J-T	T	10.2/25.1
C1032	4030011600	S.CER C1608 JB 1E 104K-T	T	11.1/9.1
C1033	4030011600	S.CER C1608 JB 1E 104K-T	T	9.8/10.1
C1042	4030011600	S.CER C1608 JB 1E 104K-T	T	22/12.7
C1043	4030011600	S.CER C1608 JB 1E 104K-T	T	20.1/16.8
C1044	4030011600	S.CER C1608 JB 1E 104K-T	T	19.9/15.5
C1045	4030011600	S.CER C1608 JB 1E 104K-T	T	13.2/20.6
C1046	4030011330	S.CER C1608 CH 1H 391J-T	T	15/19.8
C1047	4030007050	S.CER C1608 CH 1H 220J-T	T	13.2/23.2
C1048	4030017800	S.CER C1608 CH 1H 561J-T	T	17.5/21.5
C1050	4030007110	S.CER C1608 CH 1H 680J-T	T	20.6/22.1
C1051	4030010760	S.CER C1608 CH 1H 331J-T	T	21.7/24.4
C1052	4030011600	S.CER C1608 JB 1E 104K-T	T	17.7/8.8
C1053	4030011600	S.CER C1608 JB 1E 104K-T	T	16.4/9.7
C1062	4030011600	S.CER C1608 JB 1E 104K-T	T	27/30.3
C1063	4030011600	S.CER C1608 JB 1E 104K-T	T	29.9/32.8
C1064	4030011600	S.CER C1608 JB 1E 104K-T	T	24.3/28.8
C1066	4030007010	S.CER C1608 CH 1H 100D-T	T	12.8/25.1
C1067	4030011600	S.CER C1608 JB 1E 104K-T	T	26.5/28.4
C1069	4030006880	S.CER C1608 JB 1H 472K-T	T	66/21
C1070	4030006880	S.CER C1608 JB 1H 472K-T	T	66/22.3
C1071	4030006880	S.CER C1608 JB 1H 472K-T	T	36.6/32.8
C1072	4030006880	S.CER C1608 JB 1H 472K-T	T	28.8/41.8
C1073	4030006880	S.CER C1608 JB 1H 472K-T	T	13.8/41.2
C1074	4030006880	S.CER C1608 JB 1H 472K-T	T	20.2/41.1
C1075	4030006880	S.CER C1608 JB 1H 472K-T	T	22.9/41
C1077	4030011600	S.CER C1608 JB 1E 104K-T	T	11.8/40.4
C1091	4030006880	S.CER C1608 JB 1H 472K-T	T	25.6/15.5
C1092	4030006880	S.CER C1608 JB 1H 472K-T	T	18.9/5.3
C1093	4030006880	S.CER C1608 JB 1H 472K-T	T	22.1/2.7
C1094	4030006880	S.CER C1608 JB 1H 472K-T	T	27.9/8.6
C1101	4550006480	S.TAN TEESVA 1C 475M8R	T	65.4/12.7
C2016	4030006880	S.CER C1608 JB 1H 472K-T	T	43.8/35.7
C2017	4030006880	S.CER C1608 JB 1H 472K-T	T	41.2/35.7
C6110	4030011600	S.CER C1608 JB 1E 104K-T	T	28.7/26.1
RL1010	6330001860	R.LY UA2-12NU		
RL1011	6330001860	R.LY UA2-12NU		
J1071	6510007020	C.NR TMP-J01X-V6		
J1072	6510007020	C.NR TMP-J01X-V6		
J2016	6510020091	S.C.NR 52808-0871 (0890)	T	44.4/40.4
J2017	6510003401	C.NR B04B-EH-S (LF) (SN)		
EP1010	6910012350	S.BEA MMZ1608Y 102BT	T	63.5/32
EP1069	6910014690	S.BEA MPZ1608S221A-T	T	66/19.7
EP1070	6910014690	S.BEA MPZ1608S221A-T	T	66/23.6
EP1091	6910012350	S.BEA MMZ1608Y 102BT	T	20.2/5.3
EP1092	6910012350	S.BEA MMZ1608Y 102BT	T	25.6/16.8

[DIGISEL UNIT]

REF NO.	ORDER NO.	DESCRIPTION	M.	H/V LOCATION
IC1	1130011141	S.IC CAT24WC256X-1.8-T13		
		[USA], [EUR], [UK]	B	98/31.1
	1130014370	S.IC CAT24C256XI-T2		
		[FRA], [ITR], [ESP], [KOR]	B	98/31.1
IC4	1130011510	S.IC BU2099FV-E2	T	86/38.6
IC5	1130011510	S.IC BU2099FV-E2	T	85.9/30.3
Q201	1530003851	S.TR 2SC5551F-TD-E	T	72.2/60.4
D21	1750000550	S.DIO 1SS355 TE-17	B	79.5/8.5
D51	1750000550	S.DIO 1SS355 TE-17	B	60.2/48.3
D52	1750000550	S.DIO 1SS355 TE-17	B	69.4/51.8
D53	1750000550	S.DIO 1SS355 TE-17	B	47.8/48.3
D54	1750000550	S.DIO 1SS355 TE-17	B	54.7/40
D55	1750000550	S.DIO 1SS355 TE-17	T	32.6/42.1
D56	1750000550	S.DIO 1SS355 TE-17	B	78.1/38.1
D57	1750000550	S.DIO 1SS355 TE-17	B	54.7/36.2
D58	1750000550	S.DIO 1SS355 TE-17	B	53.4/18.4
D59	1750000550	S.DIO 1SS355 TE-17	B	53.1/25.3
D60	1750000550	S.DIO 1SS355 TE-17	B	51/25.3
D61	1750000550	S.DIO 1SS355 TE-17	B	50.7/18.5
D62	1750000550	S.DIO 1SS355 TE-17	B	77.9/12
D63	1750000550	S.DIO 1SS355 TE-17	B	77.9/25.3
D64	1750000550	S.DIO 1SS355 TE-17	B	28/27.7
D65	1750000550	S.DIO 1SS355 TE-17	B	28/20.7
D66	1750000550	S.DIO 1SS355 TE-17	B	77.9/18.6
D67	1750000550	S.DIO 1SS355 TE-17	T	51.7/13.6
D68	1750000550	S.DIO 1SS355 TE-17	B	28/13.7
D69	1750000550	S.DIO 1SS355 TE-17	B	24.6/64.7
D70	1750000550	S.DIO 1SS355 TE-17	B	25.3/41.8
D71	1750000550	S.DIO 1SS355 TE-17	B	19/41.8
D72	1750000550	S.DIO 1SS355 TE-17	B	28.1/40.3
D73	1750000550	S.DIO 1SS355 TE-17	B	21.8/40.2
D74	1750000550	S.DIO 1SS355 TE-17	B	24.5/11.7
D75	1750000550	S.DIO 1SS355 TE-17	B	21/28.7
D201	1710001240	DIO L204BBB		
D202	1710001240	DIO L204BBB		
D203	1750000550	S.DIO 1SS355 TE-17	T	42.6/62.4
D204	1750000550	S.DIO 1SS355 TE-17	T	42.6/60.7
D205	1750000550	S.DIO 1SS355 TE-17	B	77.5/46.3
L1	6200003261	S.COL NLV32T-101J	T	94/37.4
L2	6180000990	COL LAL 04NA 101K		
L3	6200003261	S.COL NLV32T-101J	T	94/29.9
L4	6200003261	S.COL NLV32T-101J	T	94/32.9
L101	6140003980	COL LR-476		
L102	6140003990	COL LR-477		
L103	6140004001	COL LR-478A		
L104	6140004010	COL LR-479		
L105	6140004020	COL LR-480		
L106	6140004030	COL LR-481		
L107	6110003930	COL LA-595		
L201	6180000920	COL LAL 03NA 221K		
L203	6140003940	COL LR-493		
R1	7030003680	S.RES ERJ3GEYJ 104 V (100 k)	T	92.3/14.1
R2	7030003680	S.RES ERJ3GEYJ 103 V (10 k)	B	96.6/24.1
R3	7030003680	S.RES ERJ3GEYJ 103 V (10 k)	B	96.6/22.5
R4	7030003440	S.RES ERJ3GEYJ 102 V (1 k)	T	93.2/25.1
R5	7030003440	S.RES ERJ3GEYJ 102 V (1 k)	T	93.2/26.4
R6	7030003440	S.RES ERJ3GEYJ 102 V (1 k)	T	93.2/27.7
R7	7030003440	S.RES ERJ3GEYJ 102 V (1 k)	B	99/24.9
R8	7030003440	S.RES ERJ3GEYJ 102 V (1 k)	B	100.6/24.9
R9	7030003360	S.RES ERJ3GEYJ 221 V (220)	B	82.3/7.6
R10	7030003360	S.RES ERJ3GEYJ 221 V (220)	B	86.7/46.3
R35	7030003360	S.RES ERJ3GEYJ 221 V (220)	B	84.3/39.2
R36	7030003360	S.RES ERJ3GEYJ 221 V (220)	B	83.5/42.6
R37	7030003360	S.RES ERJ3GEYJ 221 V (220)	B	83.5/41
R38	7030003360	S.RES ERJ3GEYJ 221 V (220)	B	86.6/41
R39	7030003360	S.RES ERJ3GEYJ 221 V (220)	B	86.6/42.6
R40	7030003360	S.RES ERJ3GEYJ 221 V (220)	T	80.1/42.6
R41	7030003360	S.RES ERJ3GEYJ 221 V (220)	T	79.9/39.6
R42	7030003360	S.RES ERJ3GEYJ 221 V (220)	T	79.9/38.4
R43	7030003360	S.RES ERJ3GEYJ 221 V (220)	T	79.9/37.2
R44	7030003360	S.RES ERJ3GEYJ 221 V (220)	T	80.2/35.6
R45	7030003360	S.RES ERJ3GEYJ 221 V (220)	T	80.2/34.3
R46	7030003360	S.RES ERJ3GEYJ 221 V (220)	T	79.5/40.8
R47	7030003360	S.RES ERJ3GEYJ 221 V (220)	T	78.7/25.8
R48	7030003360	S.RES ERJ3GEYJ 221 V (220)	T	79.4/23.2
R49	7030003360	S.RES ERJ3GEYJ 221 V (220)	T	80.1/26.2
R50	7030003360	S.RES ERJ3GEYJ 221 V (220)	T	80.8/23.6
R51	7030003360	S.RES ERJ3GEYJ 221 V (220)	T	81.5/26.5
R52	7030003360	S.RES ERJ3GEYJ 221 V (220)	T	86.8/25.4
R53	7030003360	S.RES ERJ3GEYJ 221 V (220)	T	86.1/22.8
R54	7030003360	S.RES ERJ3GEYJ 221 V (220)	T	85.4/25.4
R55	7030003360	S.RES ERJ3GEYJ 221 V (220)	T	84.7/22.8
R56	7030003360	S.RES ERJ3GEYJ 221 V (220)	T	84/25.4
R57	7030003360	S.RES ERJ3GEYJ 221 V (220)	T	83.3/22.8
R58	7030003360	S.RES ERJ3GEYJ 221 V (220)	T	88.4/25.4
R59	7030003440	S.RES ERJ3GEYJ 102 V (1 k)	T	93.2/23.8
R100	7030000010	S.RES MCR10EZJH JPW (000)	B	96.1/38
R104	7030003680	S.RES ERJ3GEYJ 103 V (10 k)	B	24.4/34.3
R105	7030003680	S.RES ERJ3GEYJ 103 V (10 k)	B	17.7/34
R201	7030000380	S.RES MCR10EZJH 1 k	T	57.6/62.7
R202	7030000290	S.RES MCR10EZJH 180 (181)	T	57.6/59.2
R203	7030000220	S.RES MCR10EZJH 47 (470)	T	57.6/60.9
R204	7030003360	S.RES ERJ3GEYJ 221 V (220)	B	80.6/45.3
R205	7030003350	S.RES ERJ3GEYJ 181 V (180)	T	47.3/60.7
R206	7030003370	S.RES ERJ3GEYJ 271 V (270)	T	45/61.4
R207	7030003680	S.RES ERJ3GEYJ 103 V (10 k)	T	48.1/62.7

M.=Mounted side (T: Mounted on the Top side B: Mounted on the Bottom side) S.=Surface mount

[DIGISEL UNIT]

REF NO.	ORDER NO.	DESCRIPTION	M.	H/V LOCATION
R208	703000200	S.RES MCR10EZHZ 33 (330)	T	79.8/60
R209	7030003240	S.RES ERJ3GEYJ 220 V (22)	T	76.8/59.7
R210	7030003370	S.RES ERJ3GEYJ 271 V (270)	T	71.5/56.6
R211	7030003370	S.RES ERJ3GEYJ 271 V (270)	T	72.7/56.5
R213	7030000220	S.RES MCR10EZHZ 47 (470)	T	64.6/56
R214	7030003460	S.RES ERJ3GEYJ 152 V (1.5 k)	T	60.2/59.3
R215	7030003460	S.RES ERJ3GEYJ 152 V (1.5 k)	T	73.3/53.9
R216	7030003680	S.RES ERJ3GEYJ 104 V (100 k)	T	92.6/52.8
C1	4030011600	S.CER C1608 JB 1E 104K-T	B	96.6/25.7
C4	4030011600	S.CER C1608 JB 1E 104K-T	T	87.7/34.4
C5	4030011600	S.CER C1608 JB 1E 104K-T	T	84.4/34.4
C21	4030006880	S.CER C1608 JB 1H 472K-T	B	79.6/6.8
C35	4030006880	S.CER C1608 JB 1H 472K-T	B	83.5/46.3
C51	4030006880	S.CER C1608 JB 1H 472K-T	T	60.5/47.6
C52	4030006880	S.CER C1608 JB 1H 472K-T	T	72.9/47.5
C53	4030006880	S.CER C1608 JB 1H 472K-T	T	48.1/47.6
C54	4030006880	S.CER C1608 JB 1H 472K-T	T	54.7/39.7
C55	4030006880	S.CER C1608 JB 1H 472K-T	T	32.6/43.7
C56	4030006880	S.CER C1608 JB 1H 472K-T	B	80/38.1
C57	4030006880	S.CER C1608 JB 1H 472K-T	T	54.7/36.5
C58	4030006880	S.CER C1608 JB 1H 472K-T	T	51.9/20.1
C59	4030006880	S.CER C1608 JB 1H 472K-T	T	52/27.2
C60	4030006880	S.CER C1608 JB 1H 472K-T	T	52/23.8
C61	4030006880	S.CER C1608 JB 1H 472K-T	T	52/16.8
C62	4030006880	S.CER C1608 JB 1H 472K-T	B	76.3/11.9
C63	4030006880	S.CER C1608 JB 1H 472K-T	B	76.2/25.3
C64	4030006880	S.CER C1608 JB 1H 472K-T	B	28/24.2
C65	4030006880	S.CER C1608 JB 1H 472K-T	B	28/17.2
C66	4030006880	S.CER C1608 JB 1H 472K-T	B	76.2/18.5
C67	4030006880	S.CER C1608 JB 1H 472K-T	T	53.3/13.9
C68	4030006880	S.CER C1608 JB 1H 472K-T	B	28/10.2
C69	4030006880	S.CER C1608 JB 1H 472K-T	B	20.9/64.7
C70	4030006880	S.CER C1608 JB 1H 472K-T	B	28.4/42.1
C71	4030006880	S.CER C1608 JB 1H 472K-T	B	18.6/39.9
C72	4030006880	S.CER C1608 JB 1H 472K-T	B	24.9/39.9
C73	4030006880	S.CER C1608 JB 1H 472K-T	B	22.1/42
C74	4030006880	S.CER C1608 JB 1H 472K-T	B	24.5/8.2
C75	4030006880	S.CER C1608 JB 1H 472K-T	B	16.9/25.5
C101	4030011340	S.CER C1608 CH 1H 471J-T	B	50.5/52.4
C102	4030011840	S.CER C1608 CH 1H 241J-T	B	38.1/52.4
C103	4030011280	S.CER C1608 CH 1H 271J-T	B	40.3/52.4
C104	4030007130	S.CER C1608 CH 1H 101J-T	B	65.1/52.4
C105	4030006940	S.CER C1608 CH 1H 030C-T	B	65.1/44
C106	4030007150	S.CER C1608 CH 1H 151J-T	B	40.4/44
C107	4030007150	S.CER C1608 CH 1H 151J-T	B	50.5/44
C108	4030007150	S.CER C1608 CH 1H 151J-T	B	52.3/44
C109	4030007150	S.CER C1608 CH 1H 151J-T	B	37.2/44
C110	4030009520	S.CER C1608 CH 1H 020B-T	B	62.5/34
C111	4030009550	S.CER C1608 CH 1H 2R5B-T	B	64.3/34
C113	4030007000	S.CER C1608 CH 1H 090D-T	B	40.3/34
C114	4030007040	S.CER C1608 CH 1H 180J-T	B	70.9/34
C115	4030007040	S.CER C1608 CH 1H 180J-T	B	46.9/34
C116	4030007040	S.CER C1608 CH 1H 180J-T	B	48.7/34
C117	4030007070	S.CER C1608 CH 1H 330J-T	B	65.9/31
C118	4030007090	S.CER C1608 CH 1H 470J-T	B	66.9/42.4
C119	4030007040	S.CER C1608 CH 1H 180J-T	B	45.1/42.4
C120	4030007040	S.CER C1608 CH 1H 180J-T	B	46.9/42.4
C121	4030007040	S.CER C1608 CH 1H 180J-T	B	70.9/42.4
C122	4030007000	S.CER C1608 CH 1H 090D-T	B	42/42.4
C124	4030009520	S.CER C1608 CH 1H 020B-T	B	60.7/42.4
C125	4030009550	S.CER C1608 CH 1H 2R5B-T	B	62.5/42.4
C126	4030008360	S.CER C1608 UJ 1H 101J-T	B	40.3/7.5
C128	4030009500	S.CER C1608 CH 1H 0R5B-T	B	60.5/14.4
C129	4030009510	S.CER C1608 CH 1H 010B-T	B	59.7/21.8
C130	4030009520	S.CER C1608 CH 1H 020B-T	B	44.3/21.8
C131	4030009910	S.CER C1608 CH 1H 040B-T	B	44.6/15.1
C132	4030006990	S.CER C1608 CH 1H 080D-T	B	68.6/7.6
C133	4030007040	S.CER C1608 CH 1H 180J-T	B	76/28.6
C134	4030008750	S.CER C1608 CH 1H 360J-T	B	31.4/15
C135	4030007110	S.CER C1608 CH 1H 680J-T	B	34.1/15.2
C136	4030007140	S.CER C1608 CH 1H 121J-T	B	76/21.8
C137	4030007140	S.CER C1608 CH 1H 121J-T	B	42.1/7.5
C138	4030007130	S.CER C1608 CH 1H 101J-T	B	43.9/7.5
C139	4030007160	S.CER C1608 CH 1H 181J-T	B	34.9/7.5
C140	4030007160	S.CER C1608 CH 1H 181J-T	B	36.7/7.5
C141	4030008330	S.CER C1608 UJ 1H 560J-T	B	17.7/59.1
C142	4030008330	S.CER C1608 UJ 1H 560J-T	B	13.7/43.7
C143	4030007090	S.CER C1608 CH 1H 470J-T	B	17.6/48
C201	4030011600	S.CER C1608 JB 1E 104K-T	T	60.2/62.1
C202	4030006900	S.CER C1608 JB 1H 103K-T	T	46.5/64.2
C203	4030011600	S.CER C1608 JB 1E 104K-T	T	45/64.2
C204	4030011600	S.CER C1608 JB 1E 104K-T	T	48/58.6
C205	4030011600	S.CER C1608 JB 1E 104K-T	B	61/63
C206	4030011600	S.CER C1608 JB 1E 104K-T	T	76.8/61
C207	4030006880	S.CER C1608 JB 1H 472K-T	B	59.2/63
C208	4030007010	S.CER C1608 CH 1H 100D-T	T	76.8/58.4
C209	4030006880	S.CER C1608 JB 1H 472K-T	T	62.9/56.3
C210	4030006900	S.CER C1608 JB 1H 103K-T	T	70.2/56.6
C211	4030009000	S.CER C2012 JB 1C 224K-T	T	68.6/56.1
C212	4030006880	S.CER C1608 JB 1H 472K-T	T	71.7/53.9
C213	4030006880	S.CER C1608 JB 1H 472K-T	T	46.5/58.6
C214	4030006880	S.CER C1608 JB 1H 472K-T	T	45/58.6
C215	4030006880	S.CER C1608 JB 1H 472K-T	B	77.8/44.4
RL2	6330001860	RLY UA2-12NU		
RL21	6330001860	RLY UA2-12NU		
RL51	6330001860	RLY UA2-12NU		
RL52	6330001860	RLY UA2-12NU		
RL53	6330001860	RLY UA2-12NU		
RL54	6330001860	RLY UA2-12NU		
RL55	6330001860	RLY UA2-12NU		

[DIGISEL UNIT]

REF NO.	ORDER NO.	DESCRIPTION	M.	H/V LOCATION
RL56	6330001860	RLY UA2-12NU		
RL57	6330001860	RLY UA2-12NU		
RL58	6330001860	RLY UA2-12NU		
RL59	6330001860	RLY UA2-12NU		
RL60	6330001860	RLY UA2-12NU		
RL61	6330001860	RLY UA2-12NU		
RL62	6330001860	RLY UA2-12NU		
RL63	6330001860	RLY UA2-12NU		
RL64	6330001860	RLY UA2-12NU		
RL65	6330001860	RLY UA2-12NU		
RL66	6330001860	RLY UA2-12NU		
RL67	6330001860	RLY UA2-12NU		
RL69	6330001860	RLY UA2-12NU		
RL70	6330001860	RLY UA2-12NU		
RL71	6330001860	RLY UA2-12NU		
RL72	6330001860	RLY UA2-12NU		
RL73	6330001860	RLY UA2-12NU		
RL74	6330001860	RLY UA2-12NU		
RL75	6330001860	RLY UA2-12NU		
RL76	6330001860	RLY UA2-12NU		
RL201	6330001860	RLY UA2-12NU		
J1	6510007020	CNR TMP-J01X-V6		
J2	6510007020	CNR TMP-J01X-V6		
J2017	6510019971	S.CNR 52808-1071	T	99.4/27.4
J2018	6510003391	CNR B03B-EH-S (LF) (SN)		
W11	8600037250	CBL SX3009 J11*J12DI		
EP2	6910014690	S.BEA MPZ1608S221A-T		

M.=Mounted side (T: Mounted on the Top side B: Mounted on the Bottom side)
S.=Surface mount

[FRONT UNIT]

REF NO.	ORDER NO.	DESCRIPTION	M.	H/V LOCATION
W1	8900017300	CBL OPC-1838 (P1,N16,L140)		
W2	8900015940	CBL OPC-875A (P1,N20,L70)		
W3	8900015930	CBL OPC-886A (P1,N10,L75)		
W4	8900017280	CBL OPC-1836 (P1,N10,L60)		
W5	8900014720	CBL OPC-909A (P1,N10,L110)		
W6	8900017290	CBL OPC-1837 (P1,N10,L170)		
W7	8900017100	CBL OPC-1825 (P1,N18,L70)		
W8	8900015930	CBL OPC-886A (P1,N10,L75)		
W9	8900014871	CBL OPC-1332A-1 (P0.5,N40,L100)		
W10	8900014720	CBL OPC-909A (P1,N10,L110)		
W11	8900015930	CBL OPC-886A (P1,N10,L75)		
W12	8900015930	CBL OPC-886A (P1,N10,L75)		
W13	8900014871	CBL OPC-1332A-1 (P0.5,N40,L100)		
EP1	6910015291	UBD LTA070B790F		
EP11	6910011090	SUT RMS20-250-201-P		
EP12	0880001460	UBD EX-2500 [EUR]		
EP101	6910015650	E.OTH S-G2218-3#01 (MOUNT PLATE)		
EP102	6910015650	E.OTH S-G2218-3#01 (MOUNT PLATE)		

[DISPLAY BOARD]

REF NO.	ORDER NO.	DESCRIPTION	M.	H/V LOCATION
IC1	1130009640	S.IC BU4051BCFV-E2	T	113/15
IC3	1130009640	S.IC BU4051BCFV-E2	T	85.2/18.4
IC4	1130009640	S.IC BU4051BCFV-E2	T	43.4/78.7
IC5	1130009640	S.IC BU4051BCFV-E2	T	44.7/68.7
IC6	1140014420	S.IC M30620FCMGP (SX-3009B)	T	52.4/39
IC7	1130011510	S.IC BU2099FV-E2	T	72.2/59.8
IC201	1130009301	S.IC TC7SET08FU (T5L,JF)	T	81/40.5
IC202	1130009301	S.IC TC7SET08FU (T5L,JF)	T	117.2/58.5
IC601	1130011551	S.IC RX-4581NB-F	T	35.5/29.3
IC651	1110005821	S.IC R3112N281A-TR-F	T	120.7/71.8
Q200	1590000430	S.TR DTC144EUA T106	T	117.7/80.1
Q201	1530003301	S.TR 2SC3647S-TD-E	T	100.7/47.1
Q202	1530003301	S.TR 2SC3647S-TD-E	T	98.1/26.5
Q203	1530002060	S.TR 2SC4081 T106 R	T	85.4/50.2
Q204	1520000651	S.TR 2SB1201S-TL-E	T	91/53.9
Q205	1590000680	S.TR DTC114EUA T106	T	82.3/45.9
Q206	1590000680	S.TR DTC114EUA T106	T	134.4/14.6
Q209	1520000651	S.TR 2SB1201S-TL-E	T	123.9/59.9
Q210	1530002060	S.TR 2SC4081 T106 R	T	117.3/55.3
Q211	1590001330	S.TR DTA114EUA T106	T	131.8/63.5
Q212	1590000680	S.TR DTC114EUA T106	T	84/43.1
Q501	1590000680	S.TR DTC114EUA T106	T	131.5/73.3
Q502	1590000680	S.TR DTC114EUA T106	T	29.6/46
Q503	1590000680	S.TR DTC114EUA T106	T	29.6/48.5
Q504	1590001330	S.TR DTA114EUA T106	T	131.5/68.3
Q505	1590000680	S.TR DTC114EUA T106	T	131.5/70.8
Q601	1510000501	S.TR 2SA1162-GR (TE85R,F)	T	113.6/80.4
D7	1750000520	S.DIO DAN222TL	T	130.4/18.3
D8	1160000140	S.DIO DAP222 TL	T	130.4/16.2
D9	1730002340	S.ZEN MA8047-H (TX)	T	85.8/48.1
D10	1730002590	S.ZEN MA8033-H (TX)	T	119.5/56.9
D11	1790001670	S.DIO RB706F-40T106	T	135.2/17.1
D12	1790001670	S.DIO RB706F-40T106	T	50.7/54
D601	1790001250	S.DIO MA2S111-(TX)	T	111.5/81.6
D602	1790001250	S.DIO MA2S111-(TX)	T	113.3/78
D603	1790001250	S.DIO MA2S111-(TX)	T	111.5/78.9
X1	6050009870	S.XTL CR-567 (9.8304 MHz)	T	35.6/40.5
L201	6200001831	S.COL NLV32T-100J	T	31.1/58.1
L204	6200001831	S.COL NLV32T-100J	T	25.9/73.2
L210	6190001191	S.COL D10F-#A814AY-101K	T	88.9/64.9
L211	6190001191	S.COL D10F-#A814AY-101K	T	89.6/30.2
L601	6200001831	S.COL NLV32T-100J	T	116.7/77.3
R200	7030003440	S.RES ERJ3GEYJ 102 V (1 k)	T	84.6/40.4
R201	7030003470	S.RES ERJ3GEYJ 182 V (1.8 k)	T	103.6/43.6
R202	7030003470	S.RES ERJ3GEYJ 182 V (1.8 k)	T	103.6/32.9
R203	7030003800	S.RES ERJ3GEYJ 105 V (1 M)	T	38.9/40.5
R208	7030003360	S.RES ERJ3GEYJ 221 V (220)	T	86.5/45.7
R209	7030003860	S.RES ERJ3GE JPW V	T	16.1/24.6
R210	7030003860	S.RES ERJ3GE JPW V	T	23.7/24
R212	7030003660	S.RES ERJ3GEYJ 683 V (68 k)	T	80.1/45.5
R213	7030003580	S.RES ERJ3GEYJ 153 V (15 k)	T	81.8/43.4
R214	7030003440	S.RES ERJ3GEYJ 102 V (1 k)	T	50.7/13.4
R215	7030003440	S.RES ERJ3GEYJ 102 V (1 k)	T	49.4/13.4
R216	7030003440	S.RES ERJ3GEYJ 102 V (1 k)	T	48.1/13.4
R217	7030003440	S.RES ERJ3GEYJ 102 V (1 k)	T	46.8/13.4
R218	7030003440	S.RES ERJ3GEYJ 102 V (1 k)	T	45.5/13.4
R219	7030003440	S.RES ERJ3GEYJ 102 V (1 k)	T	44.2/13.4
R220	7030003440	S.RES ERJ3GEYJ 102 V (1 k)	T	41.6/13.6
R221	7030003440	S.RES ERJ3GEYJ 102 V (1 k)	T	42.9/13.4
R222	7030003440	S.RES ERJ3GEYJ 102 V (1 k)	T	40.6/16.1
R223	7030003440	S.RES ERJ3GEYJ 102 V (1 k)	T	39.8/13.5
R224	7030003440	S.RES ERJ3GEYJ 102 V (1 k)	T	39.1/16.1
R225	7030003440	S.RES ERJ3GEYJ 102 V (1 k)	T	38.3/13.4
R226	7030003440	S.RES ERJ3GEYJ 102 V (1 k)	T	37.6/16.1
R227	7030003440	S.RES ERJ3GEYJ 102 V (1 k)	T	36.8/13.4
R228	7030003440	S.RES ERJ3GEYJ 102 V (1 k)	T	35.5/13.4
R229	7030003440	S.RES ERJ3GEYJ 102 V (1 k)	T	32.9/13.4
R230	7030003440	S.RES ERJ3GEYJ 102 V (1 k)	T	34.2/13.4
R232	7030003440	S.RES ERJ3GEYJ 102 V (1 k)	T	83.9/13.5
R233	7030003440	S.RES ERJ3GEYJ 102 V (1 k)	T	85.2/13.5
R234	7030003440	S.RES ERJ3GEYJ 102 V (1 k)	T	86.5/13.5
R235	7030003440	S.RES ERJ3GEYJ 102 V (1 k)	T	87.8/13.5
R236	7030003440	S.RES ERJ3GEYJ 102 V (1 k)	T	89.1/13.5
R237	7030003440	S.RES ERJ3GEYJ 102 V (1 k)	T	90.4/13.5
R238	7030003440	S.RES ERJ3GEYJ 102 V (1 k)	T	91.7/13.5
R239	7030003440	S.RES ERJ3GEYJ 102 V (1 k)	T	30.8/53.2
R240	7030003440	S.RES ERJ3GEYJ 102 V (1 k)	T	30.8/51.9
R241	7030003680	S.RES ERJ3GEYJ 104 V (100 k)	T	30.9/54.6
R242	7030003680	S.RES ERJ3GEYJ 104 V (100 k)	T	33.5/52.3
R246	7030003440	S.RES ERJ3GEYJ 102 V (1 k)	T	65.3/13.4
R247	7030003440	S.RES ERJ3GEYJ 102 V (1 k)	T	64/13.4
R248	7030003440	S.RES ERJ3GEYJ 102 V (1 k)	T	62.7/13.4
R249	7030003440	S.RES ERJ3GEYJ 102 V (1 k)	T	61.4/13.4
R250	7030003440	S.RES ERJ3GEYJ 102 V (1 k)	T	60.1/13.4
R251	7030003320	S.RES ERJ3GEYJ 101 V (100)	T	58.8/13.4
R252	7030003440	S.RES ERJ3GEYJ 102 V (1 k)	T	57.5/13.4
R253	7030003440	S.RES ERJ3GEYJ 102 V (1 k)	T	56.2/13.4
R254	7030003680	S.RES ERJ3GEYJ 104 V (100 k)	T	54.9/13.4
R255	7030003640	S.RES ERJ3GEYJ 473 V (47 k)	T	22.6/14.1
R256	7030003640	S.RES ERJ3GEYJ 473 V (47 k)	T	26.5/14.1
R257	7030003670	S.RES ERJ3GEYJ 823 V (82 k)	T	23.9/14.1
R258	7030003670	S.RES ERJ3GEYJ 823 V (82 k)	T	25.2/14.1
R259	7030003440	S.RES ERJ3GEYJ 102 V (1 k)	T	40.9/63.4
R260	7030003440	S.RES ERJ3GEYJ 102 V (1 k)	T	16.4/59.4
R261	7030003440	S.RES ERJ3GEYJ 102 V (1 k)	T	6.3/58.7
R262	7030003440	S.RES ERJ3GEYJ 102 V (1 k)	T	16/56
R263	7030003440	S.RES ERJ3GEYJ 102 V (1 k)	T	6.3/55.6
R264	7030003440	S.RES ERJ3GEYJ 102 V (1 k)	T	16/54.7
R265	7030003440	S.RES ERJ3GEYJ 102 V (1 k)	T	6.3/54.3
R266	7030003440	S.RES ERJ3GEYJ 102 V (1 k)	T	16/53.4
R267	7030003440	S.RES ERJ3GEYJ 102 V (1 k)	T	6.3/53
R268	7030003440	S.RES ERJ3GEYJ 102 V (1 k)	T	15.2/52.1
R270	7030003440	S.RES ERJ3GEYJ 102 V (1 k)	T	15.2/50.8
R272	7030003440	S.RES ERJ3GEYJ 102 V (1 k)	T	6.3/51.7
R273	7030003440	S.RES ERJ3GEYJ 102 V (1 k)	T	6.3/50.4
R274	7030003440	S.RES ERJ3GEYJ 102 V (1 k)	T	15.2/49.5
R275	7030003440	S.RES ERJ3GEYJ 102 V (1 k)	T	6.3/49.1
R276	7030003440	S.RES ERJ3GEYJ 102 V (1 k)	T	15.9/72.6
R278	7030003440	S.RES ERJ3GEYJ 102 V (1 k)	T	15.9/62.2
R279	7030003440	S.RES ERJ3GEYJ 102 V (1 k)	T	6.3/62
R280	7030003440	S.RES ERJ3GEYJ 102 V (1 k)	T	15.9/63.5
R281	7030003440	S.RES ERJ3GEYJ 102 V (1 k)	T	6.3/63.3
R282	7030003440	S.RES ERJ3GEYJ 102 V (1 k)	T	15.9/64.8
R295	7030003440	S.RES ERJ3GEYJ 102 V (1 k)	T	15.9/67.4
R296	7030003440	S.RES ERJ3GEYJ 102 V (1 k)	T	6.2/67.2
R297	7030003440	S.RES ERJ3GEYJ 102 V (1 k)	T	15.9/68.7
R298	7030003440	S.RES ERJ3GEYJ 102 V (1 k)	T	6.3/68.5
R299	7030003440	S.RES ERJ3GEYJ 102 V (1 k)	T	6.3/64.6
R300	7030003440	S.RES ERJ3GEYJ 102 V (1 k)	T	15.9/71.3
R301	7030003440	S.RES ERJ3GEYJ 102 V (1 k)	T	6.3/71.1
R302	7030003560	S.RES ERJ3GEYJ 103 V (10 k)	T	6.3/69.8
R303	7030003560	S.RES ERJ3GEYJ 103 V (10 k)	T	15.9/70
R304	7030003560	S.RES ERJ3GEYJ 103 V (10 k)	T	6.3/65.9
R305	7030003560	S.RES ERJ3GEYJ 103 V (10 k)	T	15.9/66.1
R310	7030003440	S.RES ERJ3GEYJ 102 V (1 k)	T	14.6/22.4
R311	7030003440	S.RES ERJ3GEYJ 102 V (1 k)	T	14.6/21.1
R312	7030003440	S.RES ERJ3GEYJ 102 V (1 k)	T	135/20.4
R313	7030003440	S.RES ERJ3GEYJ 102 V (1 k)	T	135/19.1
R320	7030003440	S.RES ERJ3GEYJ 102 V (1 k)	T	135/26.9
R321	7030003440	S.RES ERJ3GEYJ 102 V (1 k)	T	135/25.6
R322	7030003440	S.RES ERJ3GEYJ 102 V (1 k)	T	135/24.3
R323	7030003560	S.RES ERJ3GEYJ 103 V (10 k)	T	135/28.2
R326	7030003360	S.RES ERJ3GEYJ 221 V (220)	T	119.8/54.4
R327	7030003580	S.RES ERJ3GEYJ 153 V (15 k)	T	115.4/55.1
R328	7030003660	S.RES ERJ3GEYJ 683 V (68 k)	T	115/61.2
R329	7030003560	S.RES ERJ3GEYJ 103 V (10 k)	T	52/21.3
R330	7030003500	S.RES ERJ3GEYJ 332 V (3.3 k)	T	134.4/63
R333	7030003640	S.RES ERJ3GEYJ 473 V (47 k)	T	16/57.3
R334	7030003640	S.RES ERJ3GEYJ 473 V (47 k)	T	6.3/56.9
R337	7030003670	S.RES ERJ3GEYJ 823 V (82 k)	T	19.7/57.3
R338	7030003670	S.RES ERJ3GEYJ 823 V (82 k)	T	2.8/56.9
R339	7070000261	RES ERG2SJ 220 (22)	T	
R340	7070000261	RES ERG2SJ 220 (22)	T	
R342	7030003640	S.RES ERJ3GEYJ 473 V (47 k)	T	80.2/38.1
R343	7030003640	S.RES ERJ3GEYJ 473 V (47 k)	T	115.1/57.7
R351	7030003440	S.RES ERJ3GEYJ 102 V (1 k)	T	135.3/74.9
R352	7030003440	S.RES ERJ3GEYJ 102 V (1 k)	T	135.3/76.2
R353	7030003440	S.RES ERJ3GEYJ 102 V (1 k)	T	50/69.5
R354	7030003440	S.RES ERJ3GEYJ 102 V (1 k)	T	50/66.8
R355	7030003440	S.RES ERJ3GEYJ 102 V (1 k)	T	50/68.2
R356	7030003440	S.RES ERJ3GEYJ 102 V (1 k)	T	128.4/9.8
R357	7030003440	S.RES ERJ3GEYJ 102 V (1 k)	T	119.4/10
R358	7030003440	S.RES ERJ3GEYJ 102 V (1 k)	T	128.5/11.8
R359	7030003440	S.RES ERJ3GEYJ 102 V (1 k)	T	119.4/11.3
R360	7030003440	S.RES ERJ3GEYJ 102 V (1 k)	T	128.5/13.8
R361	7030003440	S.RES ERJ3GEYJ 102 V (1 k)	T	119.4/12.6
R362	7030003440	S.RES ERJ3GEYJ 102 V (1 k)	T	135/23
R363	7030003440	S.RES ERJ3GEYJ 102 V (1 k)	T	135/21.7
R364	7030003640	S.RES ERJ3GEYJ 473 V (47 k)	T	51.1/51.6
R365	7030004730	S.RES ERJ3GEYF 222 V (2.2 k)	T	49.8/51.6
R366	7030003440	S.RES ERJ3GEYJ 102 V (1 k)	T	134.4/70.6
R369	7030003860	S.RES ERJ3GE JPW V	T	44.8/51.7
R501	7030003640	S.RES ERJ3GEYJ 473 V (47 k)	T	52/22.6
R502	7030003640	S.RES ERJ3GEYJ 473 V (47 k)	T	52/23.9
R503	7030003640	S.RES ERJ3GEYJ 473 V (47 k)	T	54.7/20.6
R504	7030003440	S.RES ERJ3GEYJ 102 V (1 k)	T	134.4/69.3
R505	7030003330	S.RES ERJ3GEYJ 121 V (120)	T	134.4/68
R506	7030003640	S.RES ERJ3GEY		

[DISPLAY BOARD]

REF NO.	ORDER NO.	DESCRIPTION	M.	H/V LOCATION
R603	7030003640	S.RES ERJ3GEYJ 473 V (47 k)	T	30.3/28.6
R604	7030003560	S.RES ERJ3GEYJ 103 V (10 k)	T	30.3/30.1
R651	7030003650	S.RES ERJ3GEYJ 563 V (56 k)	T	117.9/74.4
R652	7030003620	S.RES ERJ3GEYJ 333 V (33 k)	T	116.6/71.8
R653	7030003520	S.RES ERJ3GEYJ 472 V (4.7 k)	T	116.6/74.4
R654	7030003540	S.RES ERJ3GEYJ 682 V (6.8 k)	T	134.2/78.4
R655	7030003540	S.RES ERJ3GEYJ 682 V (6.8 k)	T	144/77.2
R656	7030003540	S.RES ERJ3GEYJ 682 V (6.8 k)	T	144/75.9
R657	7030003540	S.RES ERJ3GEYJ 682 V (6.8 k)	T	144/74.6
C201	4310001170	MLR ECQE1A 124JBB		
C202	4030016880	S.CER C4520 CH 3F 150KT-A	T	134.5/44.3
C203	4030007020	S.CER C1608 CH 1H 120J-T	T	40.2/41.3
C204	4030007020	S.CER C1608 CH 1H 120J-T	T	40.1/38.7
C205	4030011600	S.CER C1608 JB 1E 104K-T	T	43.2/82.3
C206	4030011600	S.CER C1608 JB 1E 104K-T	T	43.4/65.2
C207	4030011600	S.CER C1608 JB 1E 104K-T	T	83.9/22
C209	4030011600	S.CER C1608 JB 1E 104K-T	T	115.2/18.5
C210	4030011600	S.CER C1608 JB 1E 104K-T	T	83/40.4
C211	4030011600	S.CER C1608 JB 1E 104K-T	T	117.6/61.2
C212	4510008800	S.ELE EEE1EA100SR	T	80.3/50
C213	4510009150	S.ELE EEE1EA470WP	T	89.3/40.8
C214	4510008800	S.ELE EEE1EA100SR	T	83.7/55.8
C215	4030011600	S.CER C1608 JB 1E 104K-T	T	32.4/62.7
C216	4030011600	S.CER C1608 JB 1E 104K-T	T	66.1/6.2
C217	4030011600	S.CER C1608 JB 1E 104K-T	T	34.2/54.3
C218	4510009150	S.ELE EEE1EA470WP	T	36.6/61.8
C219	4030006860	S.CER C1608 JB 1H 102K-T	T	34.2/55.7
C220	4030011600	S.CER C1608 JB 1E 104K-T	T	28.7/72.1
C221	4030011600	S.CER C1608 JB 1E 104K-T	T	113.2/55.1
C222	4030011600	S.CER C1608 JB 1E 104K-T	T	82.6/13.5
C223	4030011600	S.CER C1608 JB 1E 104K-T	T	144.6/33.9
C224	4030011600	S.CER C1608 JB 1E 104K-T	T	41.9/39
C225	4030011600	S.CER C1608 JB 1E 104K-T	T	70/55.6
C226	4030011600	S.CER C1608 JB 1E 104K-T	T	18.7/60.7
C227	4030011600	S.CER C1608 JB 1E 104K-T	T	33.1/66.2
C228	4510008800	S.ELE EEE1EA100SR	T	32.6/70.4
C229	4030011600	S.CER C1608 JB 1E 104K-T	T	6.3/73.7
C230	4030006880	S.CER C1608 JB 1H 472K-T	T	50.6/55.9
C231	4030011600	S.CER C1608 JB 1E 104K-T	T	64.6/38.9
C232	4030011600	S.CER C1608 JB 1E 104K-T	T	47.4/53
C241	4030011600	S.CER C1608 JB 1E 104K-T	T	106.5/17.3
C242	4030011600	S.CER C1608 JB 1E 104K-T	T	106.5/16
C243	4030011600	S.CER C1608 JB 1E 104K-T	T	106.5/14.7
C244	4030011600	S.CER C1608 JB 1E 104K-T	T	106.5/13.4
C245	4030011600	S.CER C1608 JB 1E 104K-T	T	119.4/17.8
C246	4030011600	S.CER C1608 JB 1E 104K-T	T	119.4/16.5
C247	4030011600	S.CER C1608 JB 1E 104K-T	T	119.4/15.2
C248	4030011600	S.CER C1608 JB 1E 104K-T	T	119.4/13.9
C254	4030011600	S.CER C1608 JB 1E 104K-T	T	50.2/79.6
C255	4030011600	S.CER C1608 JB 1E 104K-T	T	50.2/80.9
C257	4030011600	S.CER C1608 JB 1E 104K-T	T	79.2/19.4
C258	4030011600	S.CER C1608 JB 1E 104K-T	T	79.2/20.7
C259	4030011600	S.CER C1608 JB 1E 104K-T	T	79.2/16.8
C260	4030011600	S.CER C1608 JB 1E 104K-T	T	79.2/18.1
C261	4030011600	S.CER C1608 JB 1E 104K-T	T	93.1/16.8
C262	4030011600	S.CER C1608 JB 1E 104K-T	T	93.1/18.1
C263	4030011600	S.CER C1608 JB 1E 104K-T	T	93.1/19.4
C264	4030011600	S.CER C1608 JB 1E 104K-T	T	93.1/20.7
C265	4030011600	S.CER C1608 JB 1E 104K-T	T	50.2/77
C266	4030011600	S.CER C1608 JB 1E 104K-T	T	50.2/78.3
C601	4510008800	S.ELE EEE1EA100SR	T	113/73.1
C602	4030011600	S.CER C1608 JB 1E 104K-T	T	30.3/27.3
C651	4030008890	S.CER C1608 JB 1H 273K-T	T	123.3/72
C652	4030011600	S.CER C1608 JB 1E 104K-T	T	117.9/71.8
J1	6510022472	S.CNR 40FLT-SM2-TB(LF)(SN)(M)	T	11/59.6
J4	6510020531	S.CNR 52808-1871	T	40.8/8.8
J5	6510019971	S.CNR 52808-1071	T	87.7/8.8
J7	6510019971	S.CNR 52808-1071	T	60.7/8.8
J8	6510019971	S.CNR 52808-1071	T	124/12.3
J201	6510022472	S.CNR 40FLT-SM2-TB(LF)(SN)(M)	T	9.5/28.4
J202	6510022472	S.CNR 40FLT-SM2-TB(LF)(SN)(M)	T	19.9/28.4
J203	6510020081	S.CNR 52808-2071 (2090)	T	26/59.7
J205	6510003401	CNR B04B-EH-S (LF) (SN)		
J301	6510021181	S.CNR SM2 (8.0) B-BHS1TB(LF)(SN)	T	141.7/44.8
J601	6510021861	CNR BH-800.4GG <LTC>		
J602	6510020081	S.CNR 52808-2071 (2090)	T	139.7/70.5
J603	6510019971	S.CNR 52808-1071	T	102.7/8.8
J604	6510019981	S.CNR 52808-1671 (1690)	T	140.1/27.4
J605	6510018961	S.CNR B2B-PH-SM4-TB (LF) (SN)	T	87.5/81.9
J606	6510022191	S.CNR B3B-PH-SM4-TB (LF) (SN)	T	99.4/82.9
T201	5910000981	TSM 3319-T088-LF		
BT601	3020000110	LTM CR2032		
EP203	6910014690	S.BEA MPZ1608S221A-T	T	30.4/62.3
EP205	6910014690	S.BEA MPZ1608S221A-T	T	47.4/54.3
EP207	6910014690	S.BEA MPZ1608S221A-T	T	143.9/32
EP208	6910014690	S.BEA MPZ1608S221A-T	T	31/64.9
EP209	6910014690	S.BEA MPZ1608S221A-T	T	6.3/72.4

[VR-A BOARD]

REF NO.	ORDER NO.	DESCRIPTION	M.	H/V LOCATION
R1	7210002970	VAR RV-314 (RK0972210 10KB/10KB)		
R2	7210002970	VAR RV-314 (RK0972210 10KB/10KB)		
R3	7030003520	S.RES ERJ3GEYJ 472 V (4.7 k)	T	22.7/61.5
R4	7030003520	S.RES ERJ3GEYJ 472 V (4.7 k)	T	18.2/61.5
R5	7030003520	S.RES ERJ3GEYJ 472 V (4.7 k)	T	24.2/39
R6	7030003520	S.RES ERJ3GEYJ 472 V (4.7 k)	T	19.5/39
R101	7030003860	S.RES ERJ3GE JPW V	T	8.8/56.1
R102	7030003860	S.RES ERJ3GE JPW V	T	4.6/56.1
R103	7030003860	S.RES ERJ3GE JPW V	T	3.3/56
R104	7030003860	S.RES ERJ3GE JPW V	T	9.4/9
R105	7030003860	S.RES ERJ3GE JPW V	T	8.2/9
R106	7030003860	S.RES ERJ3GE JPW V	T	6.2/9
R107	7030003860	S.RES ERJ3GE JPW V	T	4.2/8.1
R108	7030003860	S.RES ERJ3GE JPW V	T	12/23.5
C1	4030006880	S.CER C1608 JB 1H 472K-T	T	20.7/39
C2	4030006880	S.CER C1608 JB 1H 472K-T	T	23/39
C3	4030006880	S.CER C1608 JB 1H 472K-T	T	19.5/61.5
C4	4030006880	S.CER C1608 JB 1H 472K-T	T	21.5/61.5
J103	6510019971	S.CNR 52808-1071	T	9.5/60.6
J104	6510020711	S.CNR 52793-1070 (1090)	T	9.7/2.4
J106	6510019981	S.CNR 52808-1671 (1690)	T	4.8/40.9
J107	6510025270	S.CNR S6B-PH-SM4-TB (LF) (SN)	T	3.7/18.5
EP107	6910012350	S.BEA MMZ1608Y 102BT	T	13.1/56.1
EP108	6910012350	S.BEA MMZ1608Y 102BT	T	14.4/56.1
EP111	6910012350	S.BEA MMZ1608Y 102BT	T	10.1/56.1
EP112	6910012350	S.BEA MMZ1608Y 102BT	T	7.4/56.1
EP113	6910012350	S.BEA MMZ1608Y 102BT	T	6/56.1
EP114	6910012350	S.BEA MMZ1608Y 102BT	T	16.1/83.9
EP115	6910012350	S.BEA MMZ1608Y 102BT	T	16.1/13.5
EP116	6910012350	S.BEA MMZ1608Y 102BT	T	14.8/13.5
EP117	6910012350	S.BEA MMZ1608Y 102BT	T	13.5/13.5
EP118	6910012350	S.BEA MMZ1608Y 102BT	T	12.2/13.5
EP119	6910012350	S.BEA MMZ1608Y 102BT	T	10.9/13.5
EP120	6910012350	S.BEA MMZ1608Y 102BT	T	15.5/21.7
EP121	6910012350	S.BEA MMZ1608Y 102BT	T	15.5/22.9
EP122	6910012350	S.BEA MMZ1608Y 102BT	T	15.5/20.5

[VR-B BOARD]

REF NO.	ORDER NO.	DESCRIPTION	M.	H/V LOCATION
R1	7210002970	VAR RV-314 (RK0972210 10KB/10KB)		
R2	7210002970	VAR RV-314 (RK0972210 10KB/10KB)		
R3	7210002970	VAR RV-314 (RK0972210 10KB/10KB)		
R4	7030003520	S.RES ERJ3GEYJ 472 V (4.7 k)	T	12.7/78
R5	7030003520	S.RES ERJ3GEYJ 472 V (4.7 k)	T	11.3/78
R6	7030003520	S.RES ERJ3GEYJ 472 V (4.7 k)	T	12.7/42.4
R7	7030003520	S.RES ERJ3GEYJ 472 V (4.7 k)	T	11.3/42.4
R8	7030003520	S.RES ERJ3GEYJ 472 V (4.7 k)	T	12.2/14
R9	7030003520	S.RES ERJ3GEYJ 472 V (4.7 k)	T	10.9/14
C1	4030006880	S.CER C1608 JB 1H 472K-T	T	10/42.4
C2	4030006880	S.CER C1608 JB 1H 472K-T	T	12.7/39.7
C3	4030006880	S.CER C1608 JB 1H 472K-T	T	10.1/78
C4	4030006880	S.CER C1608 JB 1H 472K-T	T	13.9/78
C5	4030006880	S.CER C1608 JB 1H 472K-T	T	9.7/14
C6	4030006880	S.CER C1608 JB 1H 472K-T	T	12.2/16.6
J1	6510019971	S.CNR 52808-1071	T	4/42.4

[VR-C BOARD]

REF NO.	ORDER NO.	DESCRIPTION	M.	H/V LOCATION
R1	7210001130	VAR RK097111T005A (10KB)		
R2	7210001130	VAR RK097111T005A (10KB)		
R3	7210001130	VAR RK097111T005A (10KB)		
R4	7210001130	VAR RK097111T005A (10KB)		
R5	7210001130	VAR RK097111T005A (10KB)		
R6	7210001130	VAR RK097111T005A (10KB)		
R7	7210001130	VAR RK097111T005A (10KB)		
R11	7030003520	S.RES ERJ3GEYJ 472 V (4.7 k)	B	139.3/11
R12	7030003520	S.RES ERJ3GEYJ 472 V (4.7 k)	B	117.2/11
R13	7030003520	S.RES ERJ3GEYJ 472 V (4.7 k)	B	95.1/11
R14	7030003520	S.RES ERJ3GEYJ 472 V (4.7 k)	B	74.5/11
R15	7030003520	S.RES ERJ3GEYJ 472 V (4.7 k)	B	8.2/11
R16	7030003520	S.RES ERJ3GEYJ 472 V (4.7 k)	B	30.3/11
R17	7030003520	S.RES ERJ3GEYJ 472 V (4.7 k)	B	52.4/11
C11	4030006880	S.CER C1608 JB 1H 472K-T	B	139.3/9.7
C12	4030006880	S.CER C1608 JB 1H 472K-T	B	117.2/9.7
C13	4030006880	S.CER C1608 JB 1H 472K-T	B	95.1/9.7
C14	4030006880	S.CER C1608 JB 1H 472K-T	B	74.5/9.7
C15	4030006880	S.CER C1608 JB 1H 472K-T	B	8.2/9.7
C16	4030006880	S.CER C1608 JB 1H 472K-T	B	30.3/9.7
C17	4030006880	S.CER C1608 JB 1H 472K-T	B	52.4/9.7
J1	6510019971	S.CNR 52808-1071	B	81.8/5.5

M.=Mounted side (T: Mounted on the Top side B: Mounted on the Bottom side)
S.=Surface mount

[SW-A BOARD]

REF NO.	ORDER NO.	DESCRIPTION	M.	H/V LOCATION
R2	7030003400	S.RES ERJ3GEYJ 471 V (470)	B	9.3/83.2
R3	7030003420	S.RES ERJ3GEYJ 681 V (680)	B	8.6/61.5
R4	7030003390	S.RES ERJ3GEYJ 391 V (390)	B	8.6/60.2
R12	7030003400	S.RES ERJ3GEYJ 471 V (470)	B	36.7/81.7
R13	7030003480	S.RES ERJ3GEYJ 222 V (2.2 k)	B	10.8/47
R14	7030003520	S.RES ERJ3GEYJ 472 V (4.7 k)	B	21.2/71
R22	7030003480	S.RES ERJ3GEYJ 222 V (2.2 k)	B	97.7/81.5
R23	7030003520	S.RES ERJ3GEYJ 472 V (4.7 k)	B	99.3/63.3
R24	7030003580	S.RES ERJ3GEYJ 153 V (15 k)	B	99.3/55
R25	7030003480	S.RES ERJ3GEYJ 222 V (2.2 k)	B	99.3/30.1
R26	7030003520	S.RES ERJ3GEYJ 472 V (4.7 k)	B	99.3/19.9
R27	7030003580	S.RES ERJ3GEYJ 153 V (15 k)	B	98.1/19.9
R29	7030003580	S.RES ERJ3GEYJ 153 V (15 k)	B	43/71
R30	7030003400	S.RES ERJ3GEYJ 471 V (470)	B	56.5/81.7
R31	7030003400	S.RES ERJ3GEYJ 471 V (470)	B	76.3/81.7
C2	4030011600	S.CER C1608 JB 1E 104K-T	B	91.2/72.7
C4	4030011600	S.CER C1608 JB 1E 104K-T	B	99.2/71.1
C5	4030011600	S.CER C1608 JB 1E 104K-T	B	90.5/69.9
C9	4030011600	S.CER C1608 JB 1E 104K-T	B	96.8/52.4
J1	6510020081	S.CNR 52808-2071 (2090)	B	95/65.4
DS5	5040002980	S.LED SML-512DW-T86	T	9.5/93.7
DS6	5040002930	S.LED SML-512MW T86	T	9/92.4
DS7	5040002930	S.LED SML-512MW T86	T	9.5/45.3
DS12	5040002930	S.LED SML-512MW T86	T	35.9/76.2
DS15	5040002990	S.LED SML-512UWT86	T	9/62.1
DS16	5040002930	S.LED SML-512MW T86	T	9/60.8
DS17	5040002930	S.LED SML-512MW T86	T	55.7/76.2
DS18	5040002930	S.LED SML-512MW T86	T	75.5/76.2
S1	2260002740	S.SW LS8J2M-T	T	8.3/85.2
S2	2260002740	S.SW LS8J2M-T	T	9.8/70.1
S3	2260002740	S.SW LS8J2M-T	T	8.3/54.7
S4	2260002740	S.SW LS8J2M-T	T	8.3/39.3
S11	2260002740	S.SW LS8J2M-T	T	35.7/70.8
S14	2260002740	S.SW LS8J2M-T	T	100.2/81.3
S15	2260002740	S.SW LS8J2M-T	T	100.2/69.3
S16	2260002740	S.SW LS8J2M-T	T	100.2/57.3
S17	2260002740	S.SW LS8J2M-T	T	100.2/45.3
S18	2260002740	S.SW LS8J2M-T	T	100.2/33.3
S19	2260002740	S.SW LS8J2M-T	T	100.2/21.3
S20	2260002740	S.SW LS8J2M-T	T	100.2/9.3
S21	2260002740	S.SW LS8J2M-T	T	55.5/70.8
S22	2260002740	S.SW LS8J2M-T	T	75.3/70.8

[SW-B BOARD]

REF NO.	ORDER NO.	DESCRIPTION	M.	H/V LOCATION
J1	6510020531	S.CNR 52808-1871	B	117/18.5
S1	2260002740	S.SW LS8J2M-T	T	22.1/22.8
S2	2260002740	S.SW LS8J2M-T	T	44.1/22.8
S3	2260002740	S.SW LS8J2M-T	T	66.1/22.8
S4	2260002740	S.SW LS8J2M-T	T	88.1/22.8
S5	2260002740	S.SW LS8J2M-T	T	110.1/22.8
S6	2260002740	S.SW LS8J2M-T	T	132.1/22.8
S7	2260002740	S.SW LS8J2M-T	T	154.1/22.8
S8	2260002740	S.SW LS8J2M-T	T	22.1/13.9
S9	2260002740	S.SW LS8J2M-T	T	44.1/13.9
S10	2260002740	S.SW LS8J2M-T	T	66.1/13.9
S11	2260002740	S.SW LS8J2M-T	T	88.1/13.9
S12	2260002740	S.SW LS8J2M-T	T	110.1/13.9
S13	2260002740	S.SW LS8J2M-T	T	132.1/13.9
S14	2260002740	S.SW LS8J2M-T	T	154.1/13.9
S15	2260002740	S.SW LS8J2M-T	T	146.3/2.3
S16	2260002740	S.SW LS8J2M-T	T	158.1/2.3
S17	2260002740	S.SW LS8J2M-T	T	175.6/4.5

[JACK BOARD]

REF NO.	ORDER NO.	DESCRIPTION	M.	H/V LOCATION
L4	6180000900	COL LAL 03NA 101K		
L5	6180000900	COL LAL 03NA 101K		
L6	6180000900	COL LAL 03NA 101K		
L101	6180000900	COL LAL 03NA 101K		
L102	6180000900	COL LAL 03NA 101K		
L103	6180000900	COL LAL 03NA 101K		
R1	7030006240	S.RES ERJ12YJ181U (180)	B	5.8/30.9
R2	7030006240	S.RES ERJ12YJ181U (180)	B	6.1/21.8
C1	4030006880	S.CER C1608 JB 1H 472K-T	T	18.9/41.2
C2	4030006880	S.CER C1608 JB 1H 472K-T	B	3.3/36.9
C101	4030006880	S.CER C1608 JB 1H 472K-T	T	3/19
C102	4030006880	S.CER C1608 JB 1H 472K-T	T	6.9/19
J1	6510020711	S.CNR 52793-1070 (1090)	T	9.2/42.6
J2	6510023891	CNR S-G4617#01F		
J102	6510023900	CNR LGR4619-7000		
EP1	6910014690	S.BEA MPZ1608S221A-T	B	27.5/30.8
EP2	6910014690	S.BEA MPZ1608S221A-T	B	4.3/28.4
EP3	6910014690	S.BEA MPZ1608S221A-T	B	4/24.3
EP101	6910012350	S.BEA MMZ1608Y 102BT	T	3/16.4
EP102	6910012350	S.BEA MMZ1608Y 102BT	T	6.9/16.4

[MIC BOARD]

REF NO.	ORDER NO.	DESCRIPTION	M.	H/V LOCATION
L1	6200003261	S.COL NLV32T-101J	B	4.5/17.8
L2	6200003261	S.COL NLV32T-101J	B	2.4/12.5
L3	6200003261	S.COL NLV32T-101J	B	4.5/2
C1	4030006880	S.CER C1608 JB 1H 472K-T	B	8.6/16.1
C2	4030006880	S.CER C1608 JB 1H 472K-T	B	2.8/5.5
C3	4030006880	S.CER C1608 JB 1H 472K-T	B	14.2/12.4
C4	4030007130	S.CER C1608 CH 1H 101J-T	B	10.1/11.2
C5	4030006880	S.CER C1608 JB 1H 472K-T	B	1.5/5.5
C6	4030006880	S.CER C1608 JB 1H 472K-T	B	9.6/9
C7	4030006880	S.CER C1608 JB 1H 472K-T	B	7.7/10.1
C8	4030007090	S.CER C1608 CH 1H 470J-T	B	9.4/13.9
J1	6510000191	CNR FM214-8SS (P) -1		
J2	6510019971	S.CNR 52808-1071	B	12.7/20.2
EP2	6910012350	S.BEA MMZ1608Y 102BT	B	4.1/6.3
EP3	6910012350	S.BEA MMZ1608Y 102BT	B	7.6/2
EP4	6910012350	S.BEA MMZ1608Y 102BT	B	10.5/16
EP5	6910012350	S.BEA MMZ1608Y 102BT	B	2.7/8.1
EP6	6910012350	S.BEA MMZ1608Y 102BT	B	7.7/7.7
EP7	6910015130	S.BEA MMZ1608D 301BT	B	17.2/10.8
EP8	6910015130	S.BEA MMZ1608D 301BT	B	15.9/10.8
EP9	6910015130	S.BEA MMZ1608D 301BT	B	10.2/6.9
EP10	6910015130	S.BEA MMZ1608D 301BT	B	11.5/9.1
EP11	6910012350	S.BEA MMZ1608Y 102BT	B	5.4/14.1
EP12	6910014690	S.BEA MPZ1608S221A-T	B	15.2/15

M.=Mounted side (T: Mounted on the Top side B: Mounted on the Bottom side)
S.=Surface mount

[USB BOARD]

REF NO.	ORDER NO.	DESCRIPTION	M.	H/V LOCATION
R1	7030003380	S.RES ERJ3GEYJ 331 V (330)	B	52/36.1
R2	7030003380	S.RES ERJ3GEYJ 331 V (330)	B	46.2/36.1
R3	7030003380	S.RES ERJ3GEYJ 331 V (330)	B	28/36.1
R4	7030003450	S.RES ERJ3GEYJ 122 V (1.2 k)	B	22.5/28.2
R5	7030003580	S.RES ERJ3GEYJ 153 V (15 k)	B	47.4/30.6
R6	7030003520	S.RES ERJ3GEYJ 472 V (4.7 k)	B	32.7/30.6
R7	7030003480	S.RES ERJ3GEYJ 222 V (2.2 k)	B	22.7/22.3
R103	7030003860	S.RES ERJ3GE JPW V	B	12.8/23.5
R104	7030003860	S.RES ERJ3GE JPW V	B	11.5/23.5
R113	7030003860	S.RES ERJ3GE JPW V	B	11.6/12.2
R114	7030003860	S.RES ERJ3GE JPW V	B	12.8/12.2
C1	4030011600	S.CER C1608 JB 1E 104K-T	B	33.4/25
J106	6510019971	S.CNR 52808-1071	B	27.2/22.5
J107	6510026080	CNR XM7A-0441		
J108	6510026080	CNR XM7A-0441		
J109	6510022031	S.CNR B10B-ZR-SM4-TF (LF) (SN)	B	2.6/27.8
DS8	5040002930	S.LED SML-512MW T86	T	12.4/36.1
DS9	5040002930	S.LED SML-512MW T86	T	39.1/36.1
DS10	5040002930	S.LED SML-512MW T86	T	58.6/36.1
DS11	5040002990	S.LED SML-512UWT86	T	12.4/23.8
S1	2260002740	S.SW LS8J2M-T	T	58.9/31.5
S2	2260002740	S.SW LS8J2M-T	T	38.9/31.5
S3	2260002740	S.SW LS8J2M-T	T	12.2/31.5
EP102	6910014730	S.BEA MPZ2012S331A-T	B	10/23.5
EP105	6910014730	S.BEA MPZ2012S331A-T	B	14.4/23.5
EP112	6910014730	S.BEA MPZ2012S331A-T	B	10/12.2
EP115	6910014730	S.BEA MPZ2012S331A-T	B	14.4/12.2

[TENKEY BOARD]

REF NO.	ORDER NO.	DESCRIPTION	M.	H/V LOCATION
IC1	1130011510	S.IC BU2099FV-E2	B	23.2/113.2
R1	7030003480	S.RES ERJ3GEYJ 222 V (2.2 k)	B	14.9/121.7
R2	7030003520	S.RES ERJ3GEYJ 472 V (4.7 k)	B	15.9/112
R3	7030003580	S.RES ERJ3GEYJ 153 V (15 k)	B	16/101.9
R4	7030003540	S.RES ERJ3GEYJ 682 V (6.8 k)	B	16.1/121.7
R5	7030003480	S.RES ERJ3GEYJ 222 V (2.2 k)	B	31.5/121.7
R6	7030003520	S.RES ERJ3GEYJ 472 V (4.7 k)	B	32.7/112.2
R7	7030003580	S.RES ERJ3GEYJ 153 V (15 k)	B	32.7/102.7
R8	7030003540	S.RES ERJ3GEYJ 682 V (6.8 k)	B	30.3/121.7
R9	7030003480	S.RES ERJ3GEYJ 222 V (2.2 k)	B	53/121.7
R10	7030003520	S.RES ERJ3GEYJ 472 V (4.7 k)	B	54.2/112.2
R11	7030003580	S.RES ERJ3GEYJ 153 V (15 k)	B	54.2/102.7
R12	7030003540	S.RES ERJ3GEYJ 682 V (6.8 k)	B	51.8/121.7
R51	7030003540	S.RES ERJ3GEYJ 682 V (6.8 k)	B	85.7/117.8
R52	7030003420	S.RES ERJ3GEYJ 681 V (680)	B	88.2/116.7
R53	7030003480	S.RES ERJ3GEYJ 222 V (2.2 k)	B	86.5/112
R54	7030003520	S.RES ERJ3GEYJ 472 V (4.7 k)	B	86.2/92.3
R55	7030003420	S.RES ERJ3GEYJ 681 V (680)	B	91/95.1
R56	7030003420	S.RES ERJ3GEYJ 681 V (680)	B	91/85.6
R57	7030003580	S.RES ERJ3GEYJ 153 V (15 k)	B	86.2/82.7
R58	7030003540	S.RES ERJ3GEYJ 682 V (6.8 k)	B	84.6/73.3
R59	7030003420	S.RES ERJ3GEYJ 681 V (680)	B	91/76.1
R60	7030003480	S.RES ERJ3GEYJ 222 V (2.2 k)	B	84.6/60.1
R61	7030003520	S.RES ERJ3GEYJ 472 V (4.7 k)	B	84.6/47.4
R62	7030003580	S.RES ERJ3GEYJ 153 V (15 k)	B	84.6/41.7
R63	7030003540	S.RES ERJ3GEYJ 682 V (6.8 k)	B	85.7/24
R65	7030003480	S.RES ERJ3GEYJ 222 V (2.2 k)	B	85.7/10
R66	7030003520	S.RES ERJ3GEYJ 472 V (4.7 k)	B	75.4/6.6
C1	4030011600	S.CER C1608 JB 1E 104K-T	B	13.7/121.7
C2	4030011600	S.CER C1608 JB 1E 104K-T	B	32.7/121.7
C3	4030011600	S.CER C1608 JB 1E 104K-T	B	54.3/121.7
C4	4030011600	S.CER C1608 JB 1E 104K-T	B	25.4/109
C51	4030011600	S.CER C1608 JB 1E 104K-T	B	87/10
C52	4030011600	S.CER C1608 JB 1E 104K-T	B	85.8/60.1
C53	4030011600	S.CER C1608 JB 1E 104K-T	B	87.2/119.2
J1	6510022471	S.CNR 40FLT-SM2-TB (LF) (SN)	B	9/93.8
J4	6510019971	S.CNR 52808-1071	B	98/101
J5	6510019971	S.CNR 52808-1071	B	6.5/120.5
J7	6510018971	S.CNR B4B-PH-SM4-TB (LF) (SN)	B	93.7/53.6
J8	6510019971	S.CNR 52808-1071	B	97.7/12.5
DS51	5040002930	S.LED SML-512MW T86	T	91/115.6
DS52	5040002930	S.LED SML-512MW T86	T	91/95.1
DS53	5040002930	S.LED SML-512MW T86	T	91/85.6
DS54	5040002930	S.LED SML-512MW T86	T	91/76.1
S1	2260002740	S.SW LS8J2M-T	T	12/86.7
S2	2260002740	S.SW LS8J2M-T	T	12/78.7
S3	2260002740	S.SW LS8J2M-T	T	55.5/78.7
S4	2260002740	S.SW LS8J2M-T	T	34/86.7
S5	2260002740	S.SW LS8J2M-T	T	34/78.7
S6	2260002740	S.SW LS8J2M-T	T	55.5/86.7
S7	2260002740	S.SW LS8J2M-T	T	12/66.3
S8	2260002740	S.SW LS8J2M-T	T	34/67.9
S11	2260002740	S.SW LS8J2M-T	T	12.5/126.6
S12	2260002740	S.SW LS8J2M-T	T	12.5/117.1
S13	2260002740	S.SW LS8J2M-T	T	12.5/107.6
S14	2260002740	S.SW LS8J2M-T	T	12.5/98.1
S15	2260002740	S.SW LS8J2M-T	T	34/126.6
S16	2260002740	S.SW LS8J2M-T	T	34/117.1
S17	2260002740	S.SW LS8J2M-T	T	34/107.6
S18	2260002740	S.SW LS8J2M-T	T	34/98.1
S19	2260002740	S.SW LS8J2M-T	T	55.5/126.6
S20	2260002740	S.SW LS8J2M-T	T	55.5/117.1
S21	2260002740	S.SW LS8J2M-T	T	55.5/107.6
S22	2260002740	S.SW LS8J2M-T	T	55.5/98.1
S23	2260002740	S.SW LS8J2M-T	T	55.5/67.9
S24	2260002740	S.SW LS8J2M-T	T	60.4/56.5
S51	2260002740	S.SW LS8J2M-T	T	90.8/122.7
S52	2260002740	S.SW LS8J2M-T	T	90.8/111.7
S53	2260002740	S.SW LS8J2M-T	T	90.8/91.2
S54	2260002740	S.SW LS8J2M-T	T	90.8/81.7
S55	2260002740	S.SW LS8J2M-T	T	90.8/72.2
S56	2260002740	S.SW LS8J2M-T	T	90.8/55.7
S57	2260002740	S.SW LS8J2M-T	T	90.8/46.2
S58	2260002740	S.SW LS8J2M-T	T	90.8/36.7
S59	2260002740	S.SW LS8J2M-T	T	90.8/22.8
S60	2260002740	S.SW LS8J2M-T	T	90.8/4.4
S61	2260002740	S.SW LS8J2M-T	T	69.7/4.2

M.=Mounted side (T: Mounted on the Top side B: Mounted on the Bottom side)
S.=Surface mount

[PBT BOARD]

REF NO.	ORDER NO.	DESCRIPTION	M.	H/V LOCATION
R1	7210003290	VAR RV-321 (RK0972210C1K 10KB/10KB)		
R2	7030003520	S.RES ERJ3GEYJ 472 V (4.7 k)	T	12.6/12.5
R3	7030003520	S.RES ERJ3GEYJ 472 V (4.7 k)	T	11.4/12.5
C1	4030006880	S.CER C1608 JB 1H 472K-T	T	10.2/12.5
C2	4030006880	S.CER C1608 JB 1H 472K-T	T	13.8/12.5
J1	6510019971	S.CNR 52808-1071	T	7/23
S1	2250000410	ECR TP90D96E20-30F-2178-1		

[PITCH BOARD]

REF NO.	ORDER NO.	DESCRIPTION	M.	H/V LOCATION
R1	7210003170	VAR RV-318 (RK09L1120CON)		
R2	7030003520	S.RES ERJ3GEYJ 472 V (4.7 k)	T	7.8/7.5
C1	4030006880	S.CER C1608 JB 1H 472K-T	T	7.8/4.9
J1	6510019971	S.CNR 52808-1071	T	4.1/7.5

[LED BOARD]

REF NO.	ORDER NO.	DESCRIPTION	M.	H/V LOCATION
R1	7030003450	S.RES ERJ3GEYJ 122 V (1.2 k)	T	124/2.9
R2	7030003420	S.RES ERJ3GEYJ 681 V (680)	T	100/2.9
R3	7030003460	S.RES ERJ3GEYJ 152 V (1.5 k)	T	19.9/2.9
R4	7030003400	S.RES ERJ3GEYJ 471 V (470)	T	59.9/2.9
J1	6510020711	S.CNR 52793-1070 (1090)	T	24/12.2
DS1	5040003000	S.LED SML-A12UT-T86	T	124/1.3
DS2	5040002961	S.LED SML-A12MT T86J	T	100/1.3
DS3	5040003010	S.LED SML-A12WT	T	19.9/1.3
DS4	5040002970	S.LED CL-270WB-D-TS	T	59.9/1.3

M.=Mounted side (T: Mounted on the Top side B: Mounted on the Bottom side)
S.=Surface mount

• SCOPE UNIT (TOP VIEW)

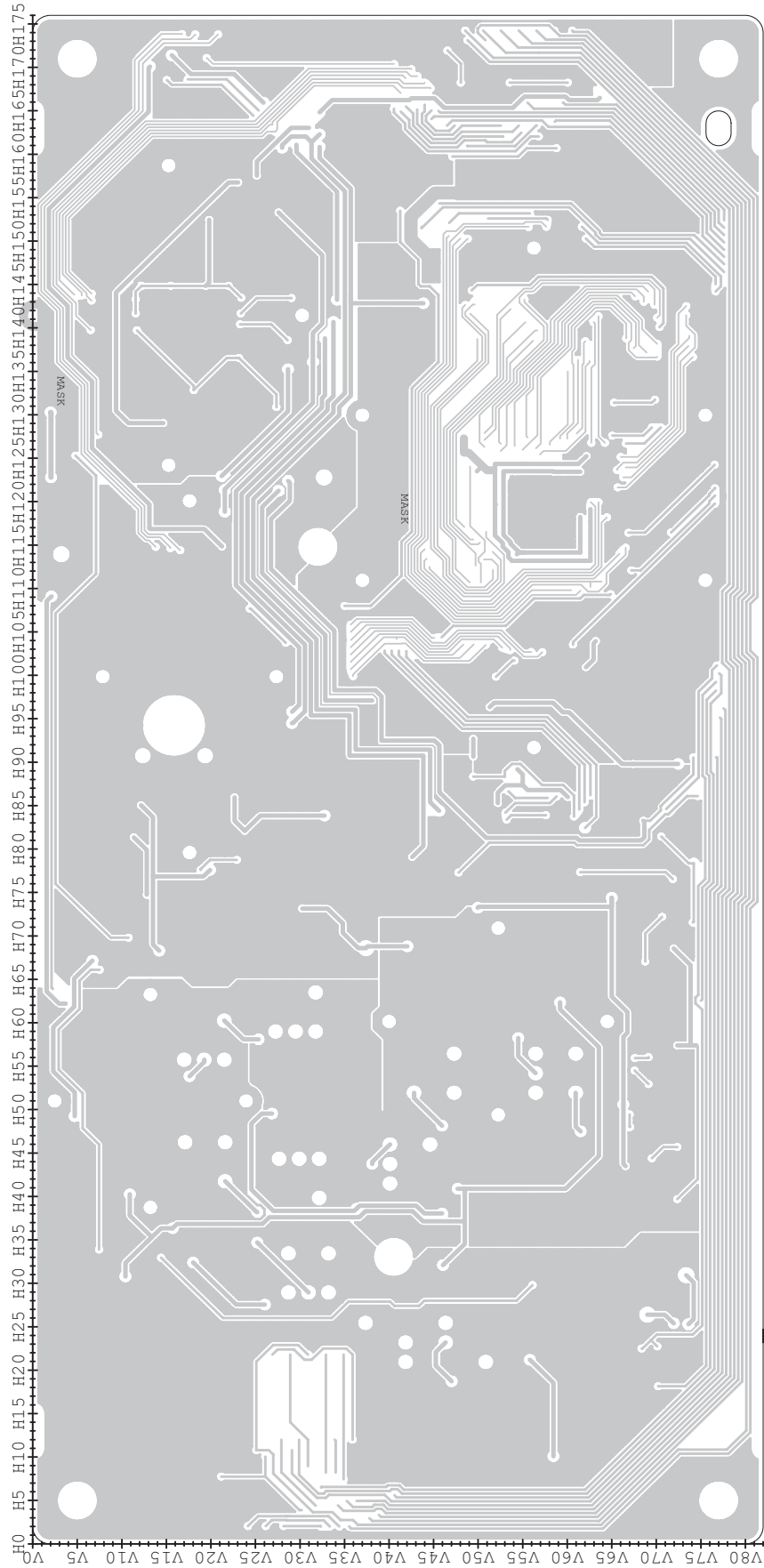

• MAIN UNIT (TOP VIEW)

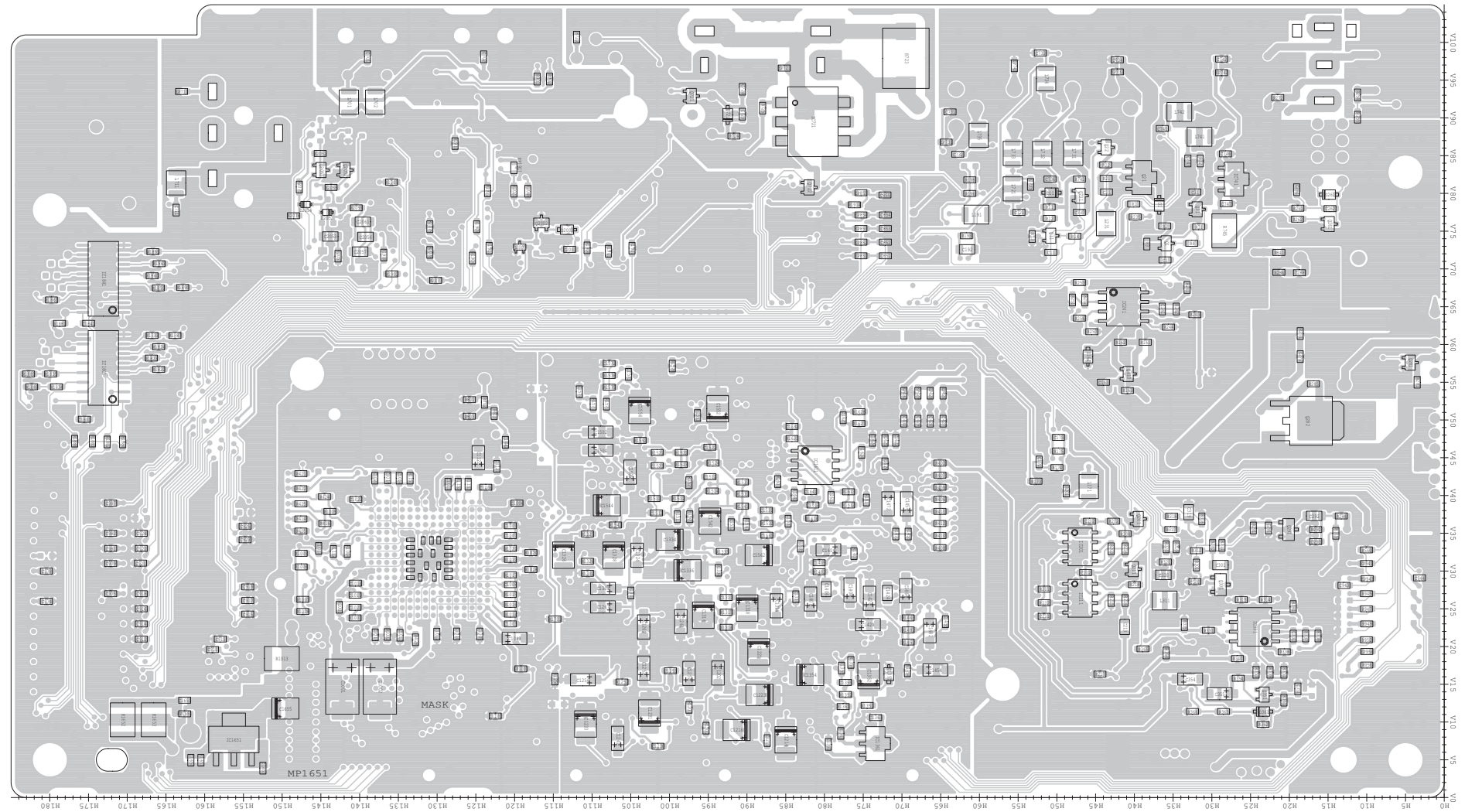

LOGIC UNIT (LOGIC-2)

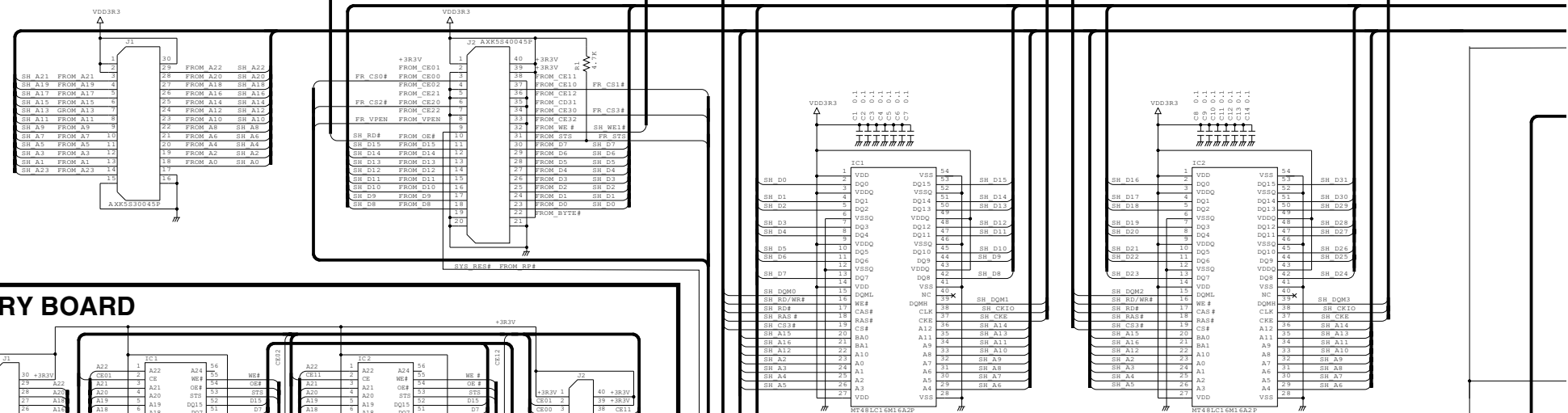

MEMORY BOARD

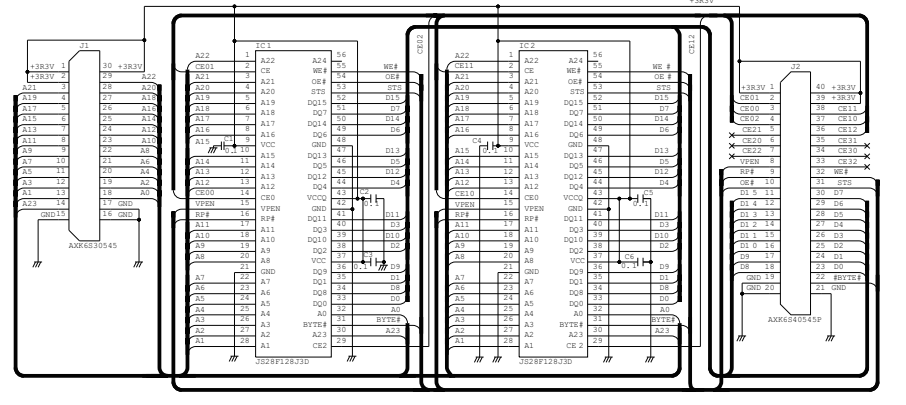

TO LOGIC-4

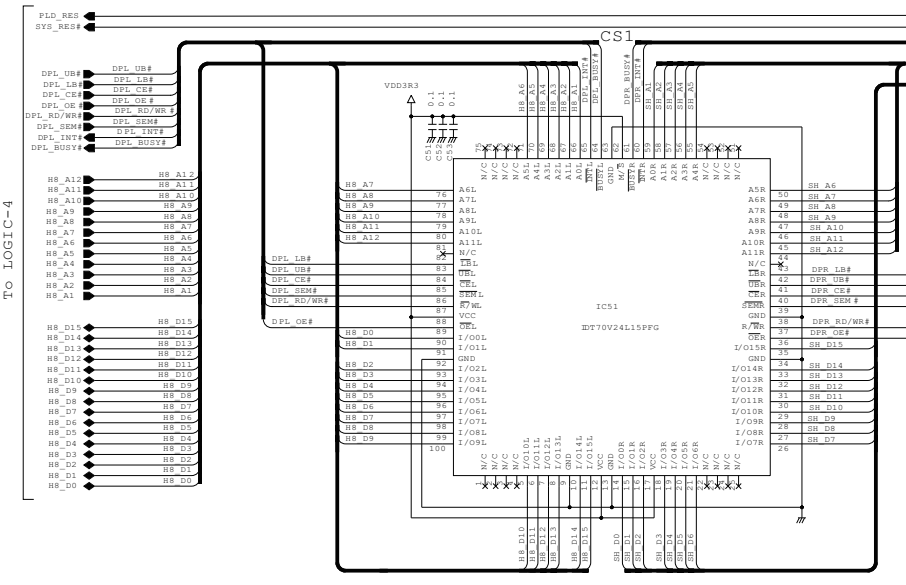

TO LOGIC-3

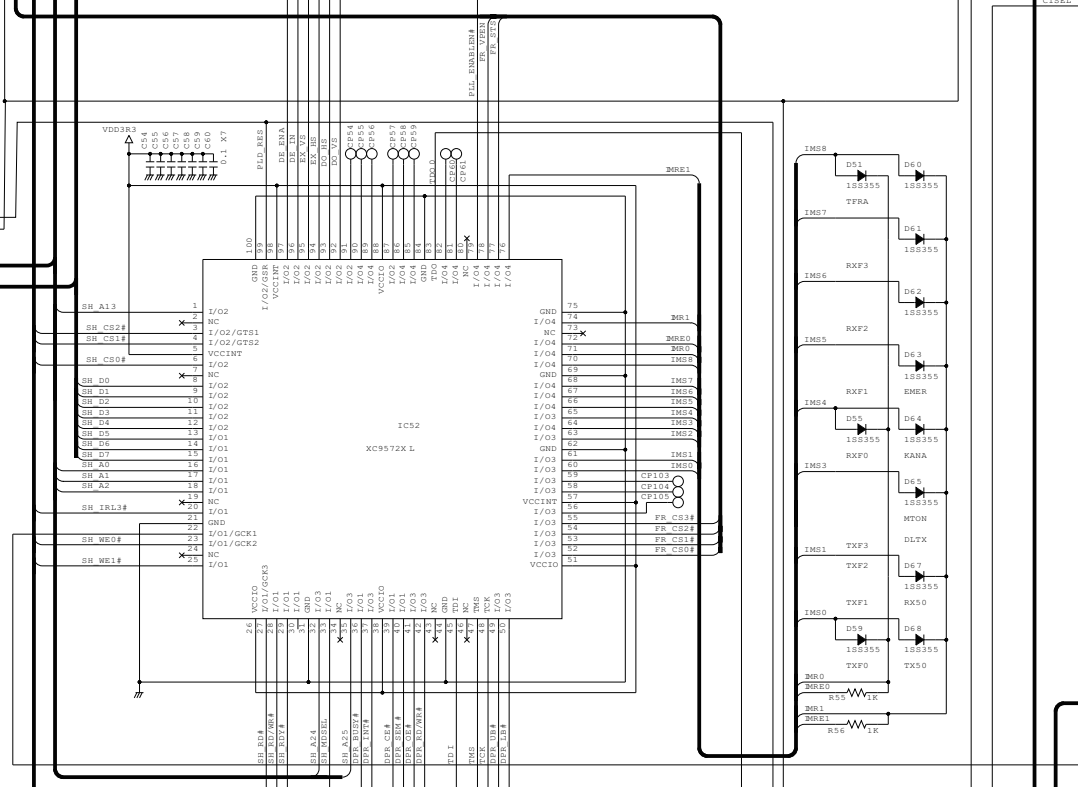

To LOGIC-4

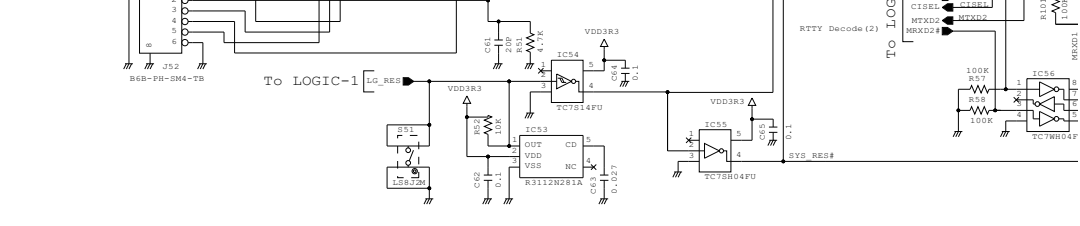

To LOGIC-1



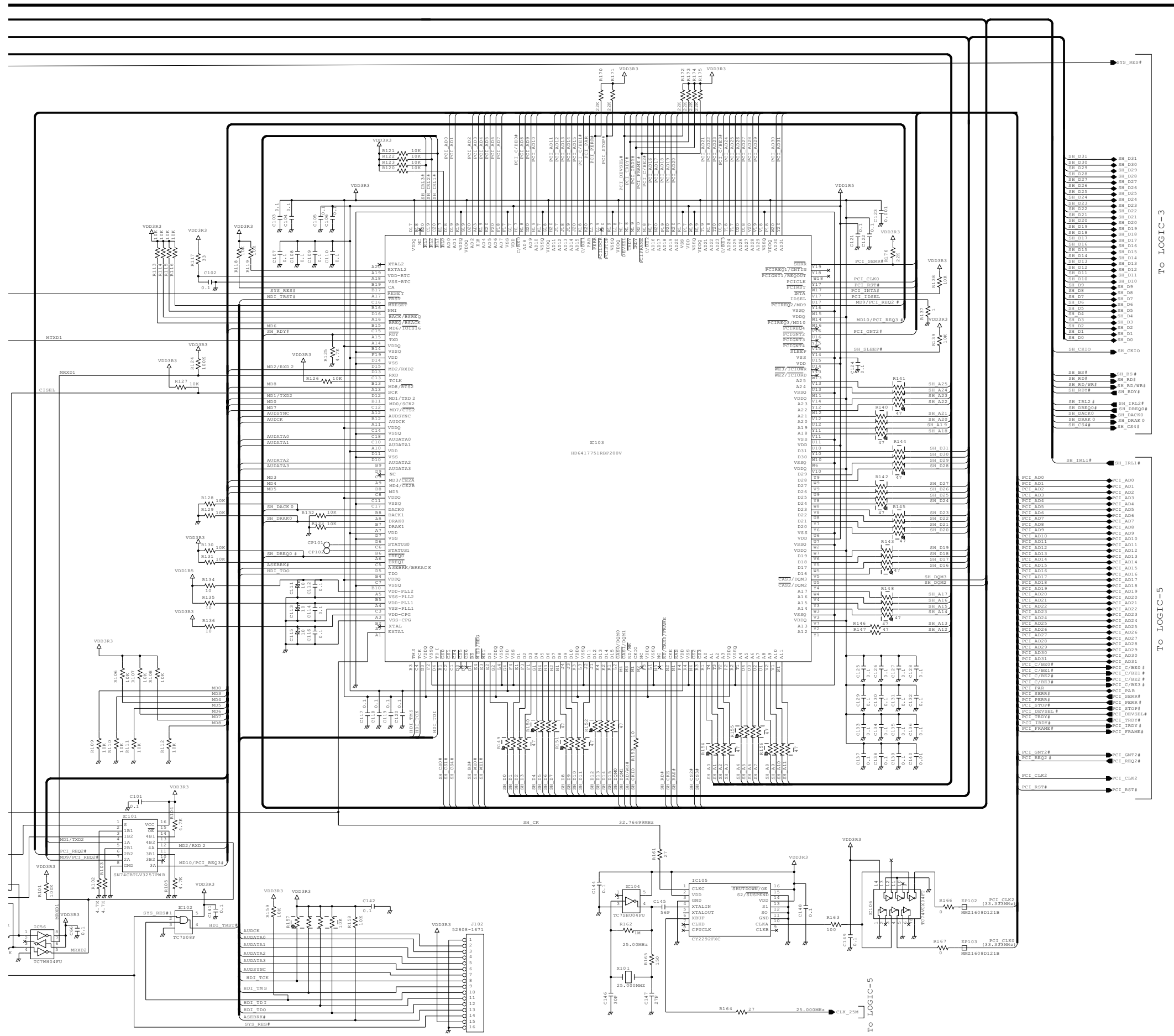

LOGIC UNIT (LOGIC-3)

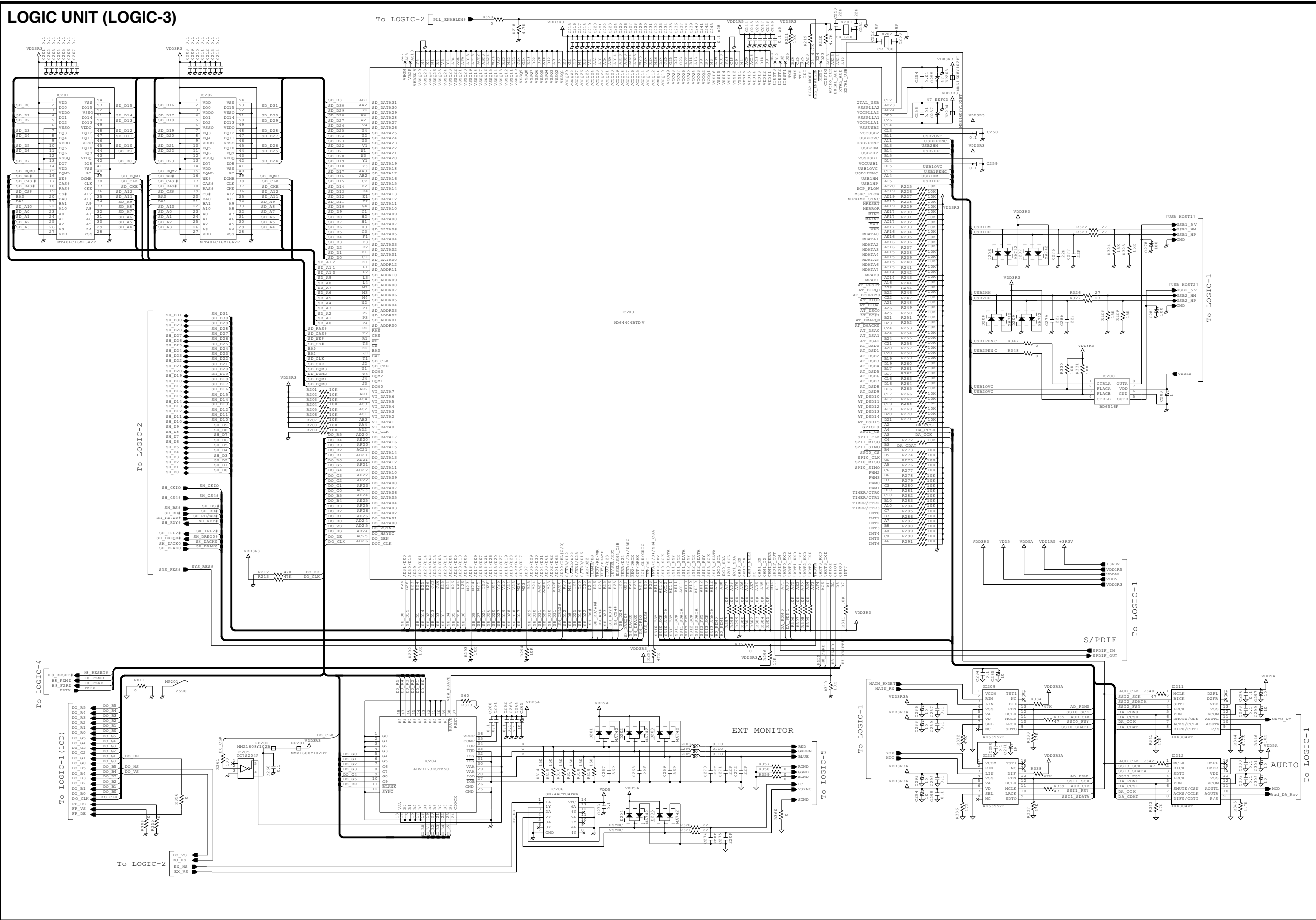

LOGIC UNIT (LOGIC-4)

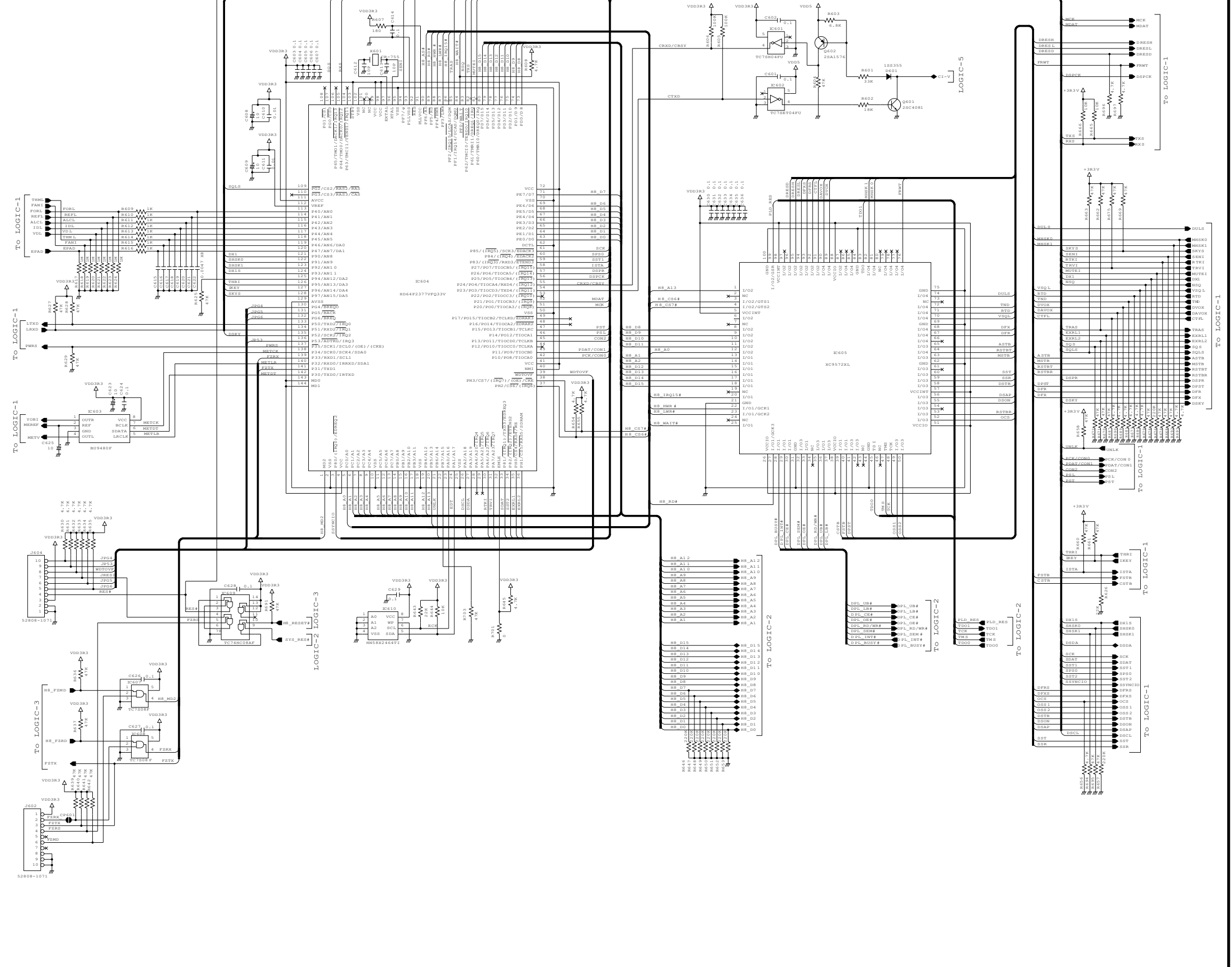

MAIN UNIT (MAIN-1)

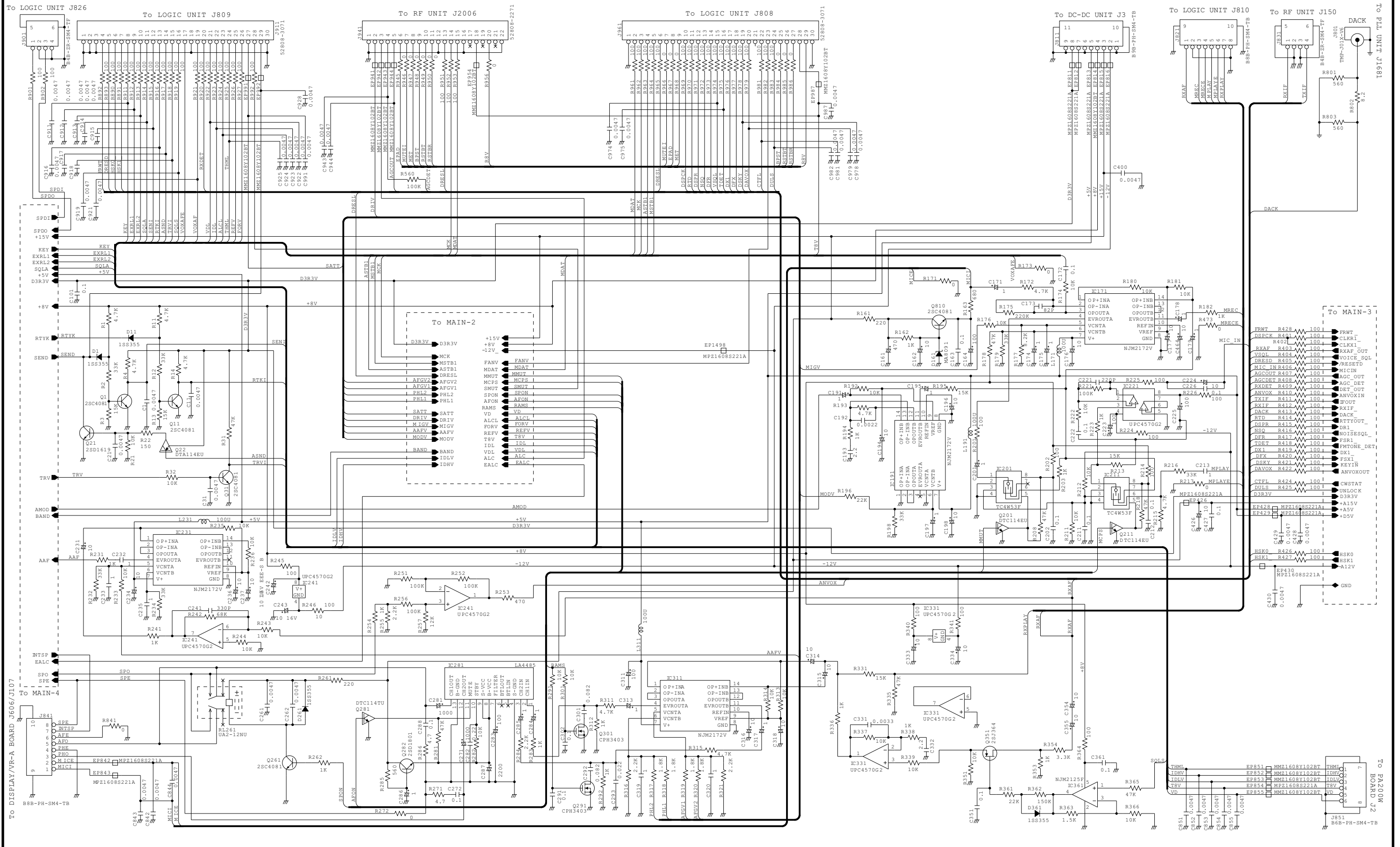

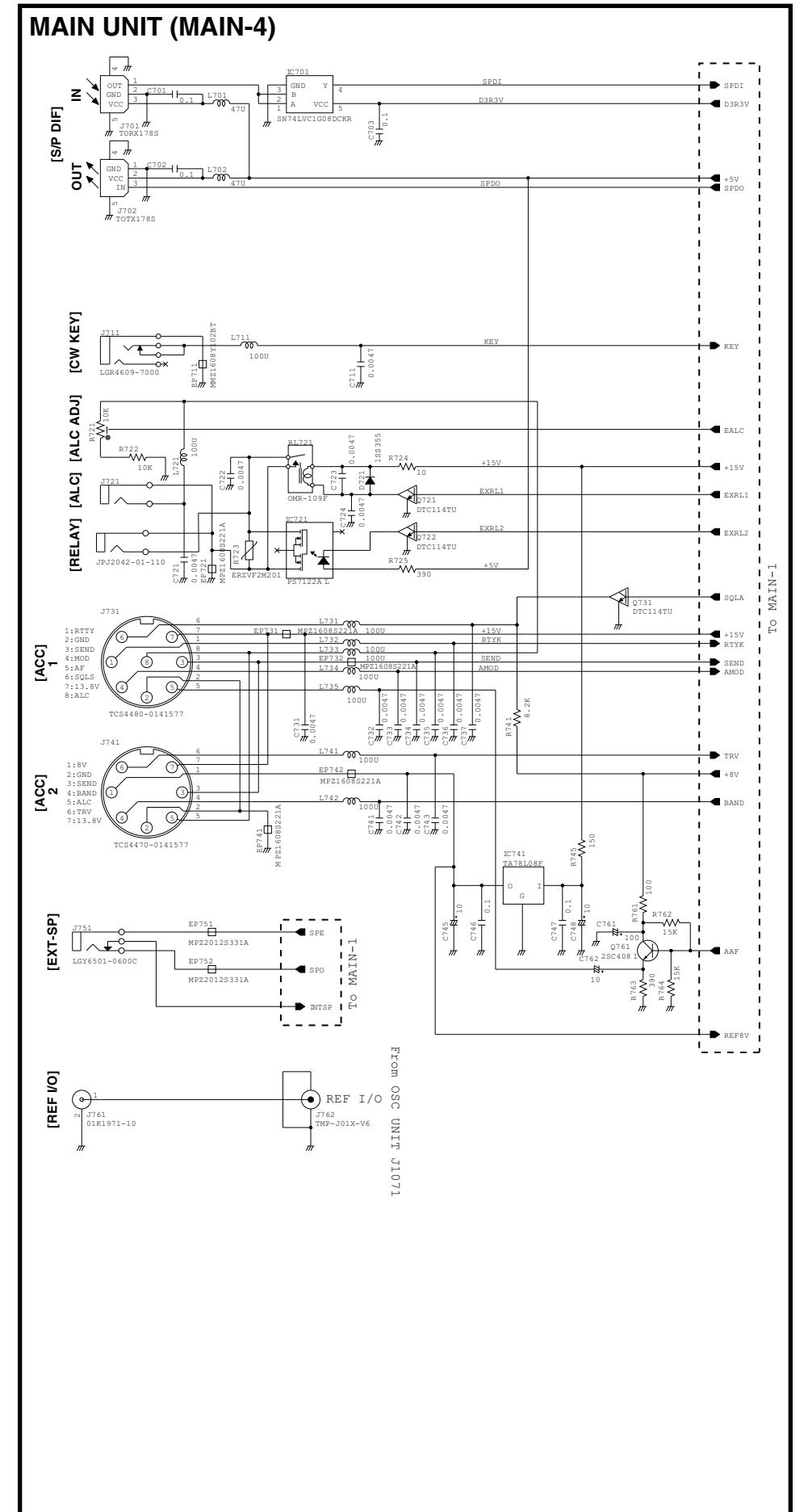
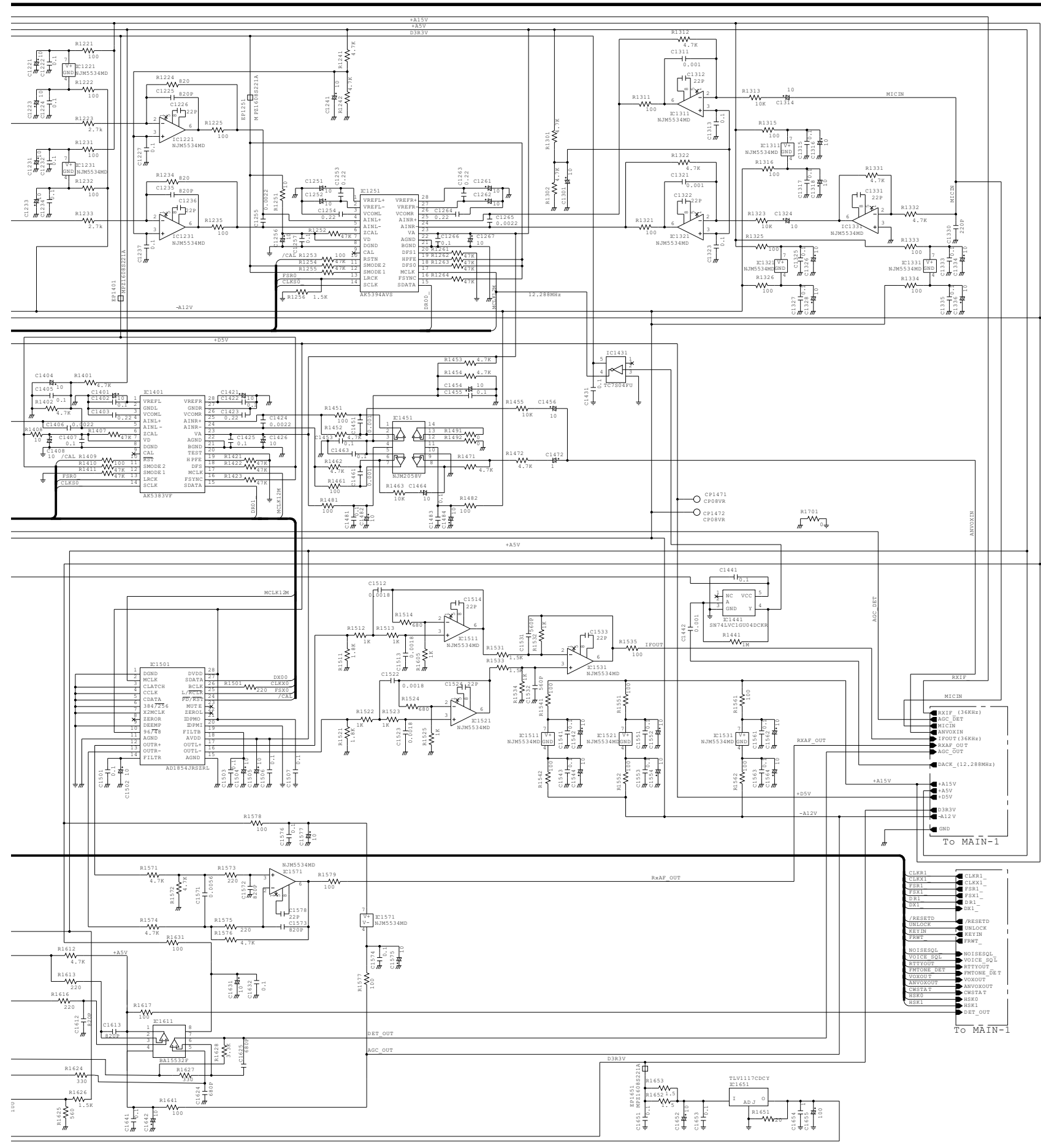

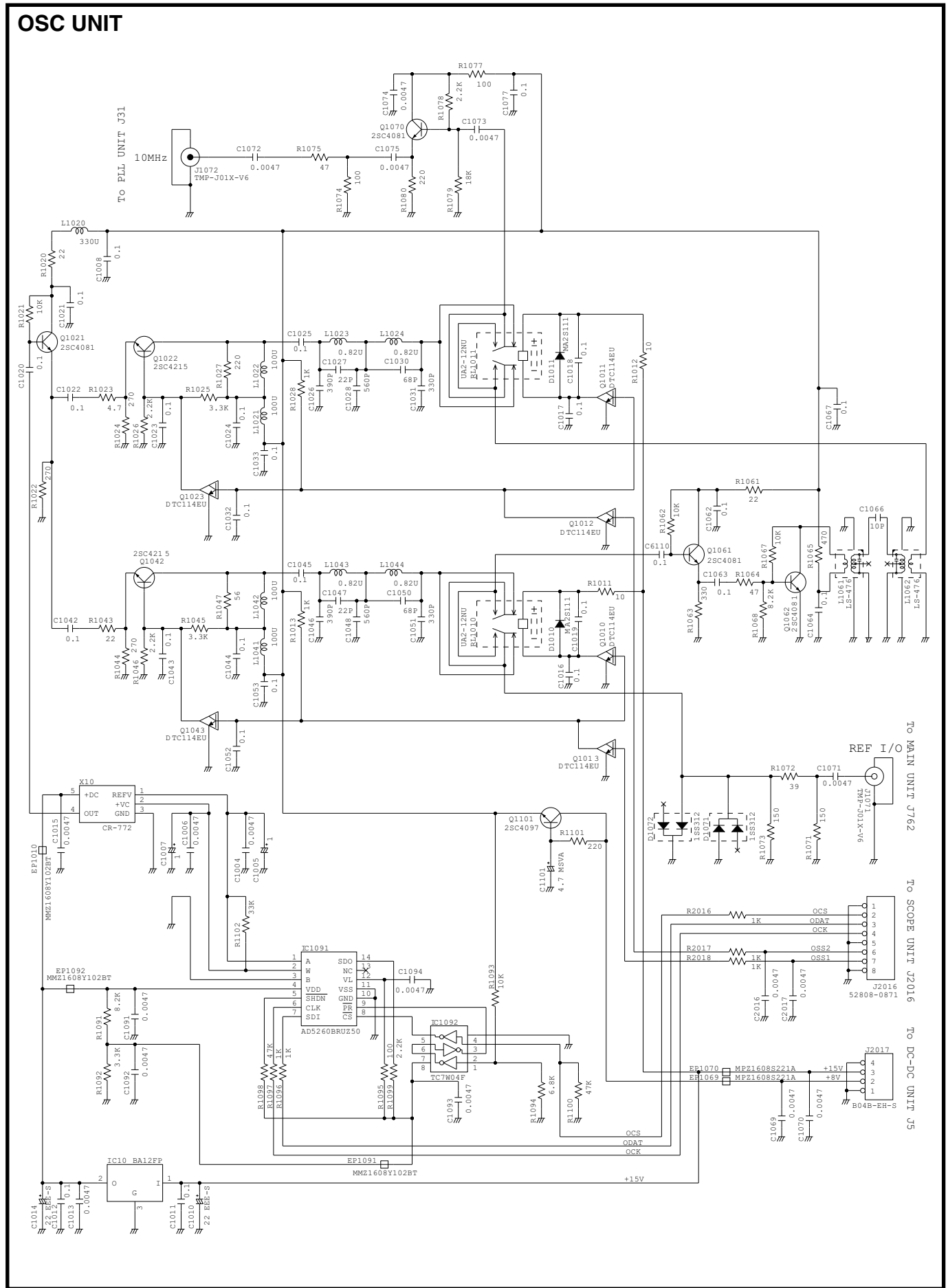
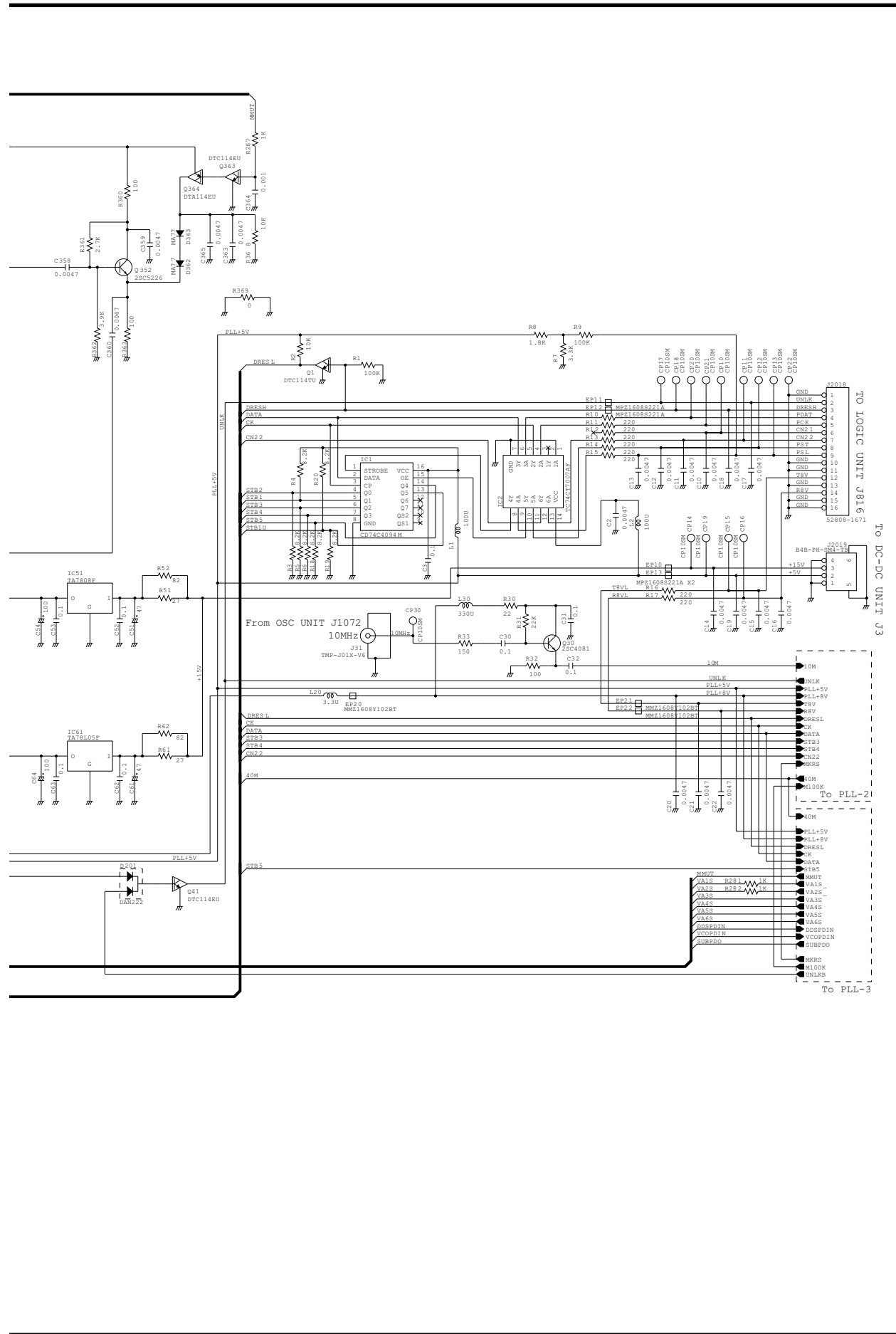

PLL UNIT (PLL-2)

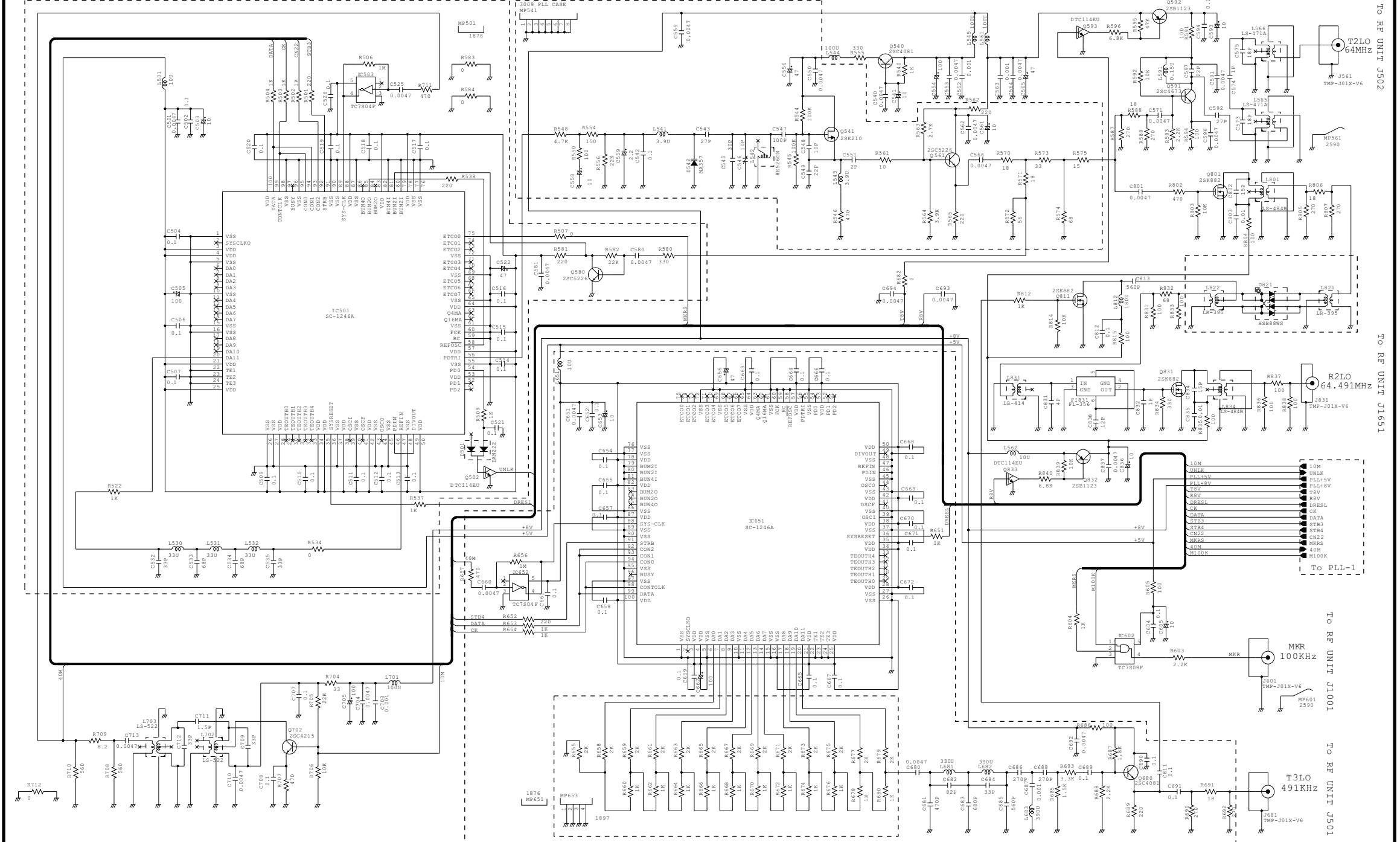

PLL UNIT (PLL-3)

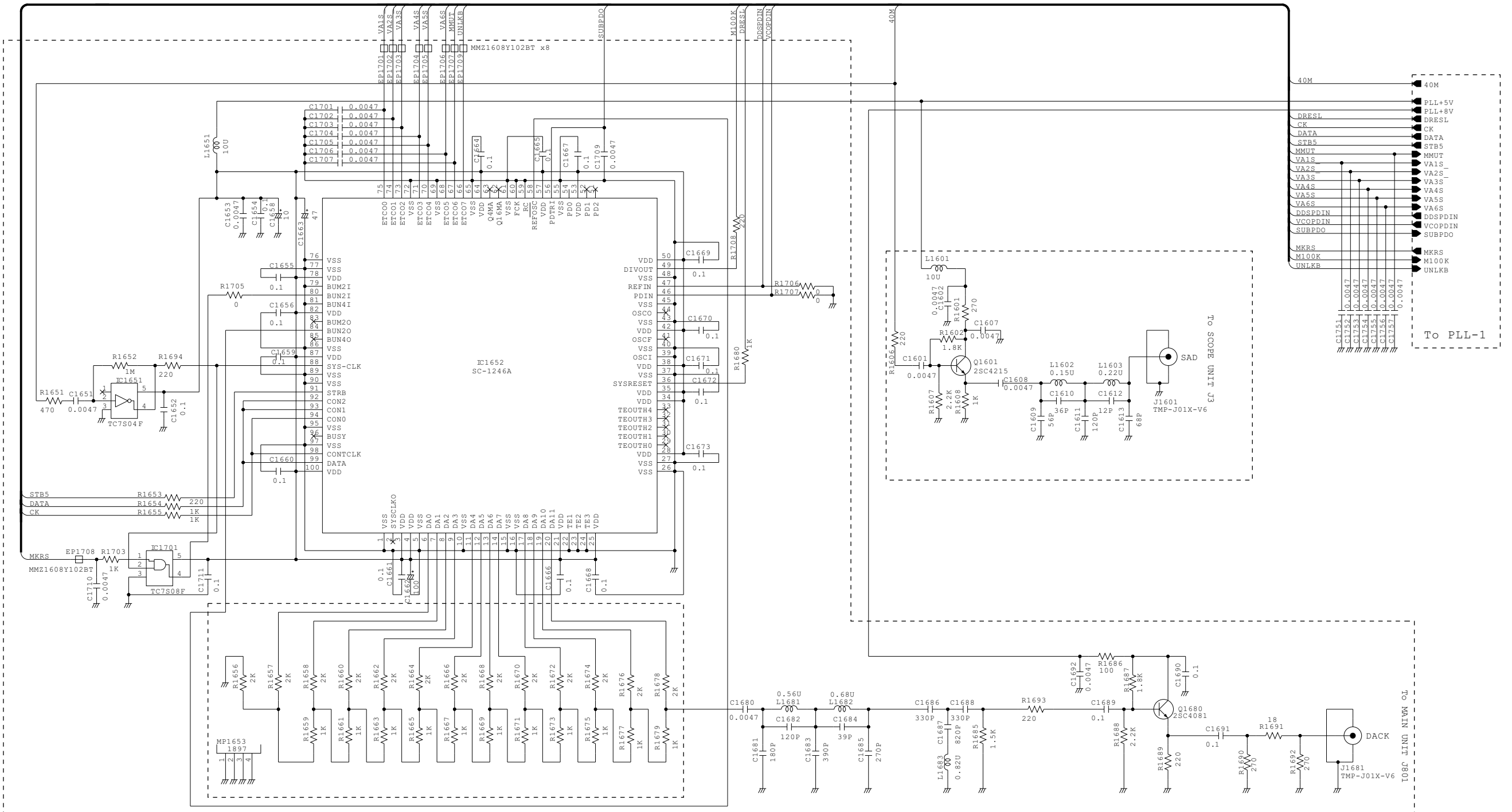

ANT-SW UNIT

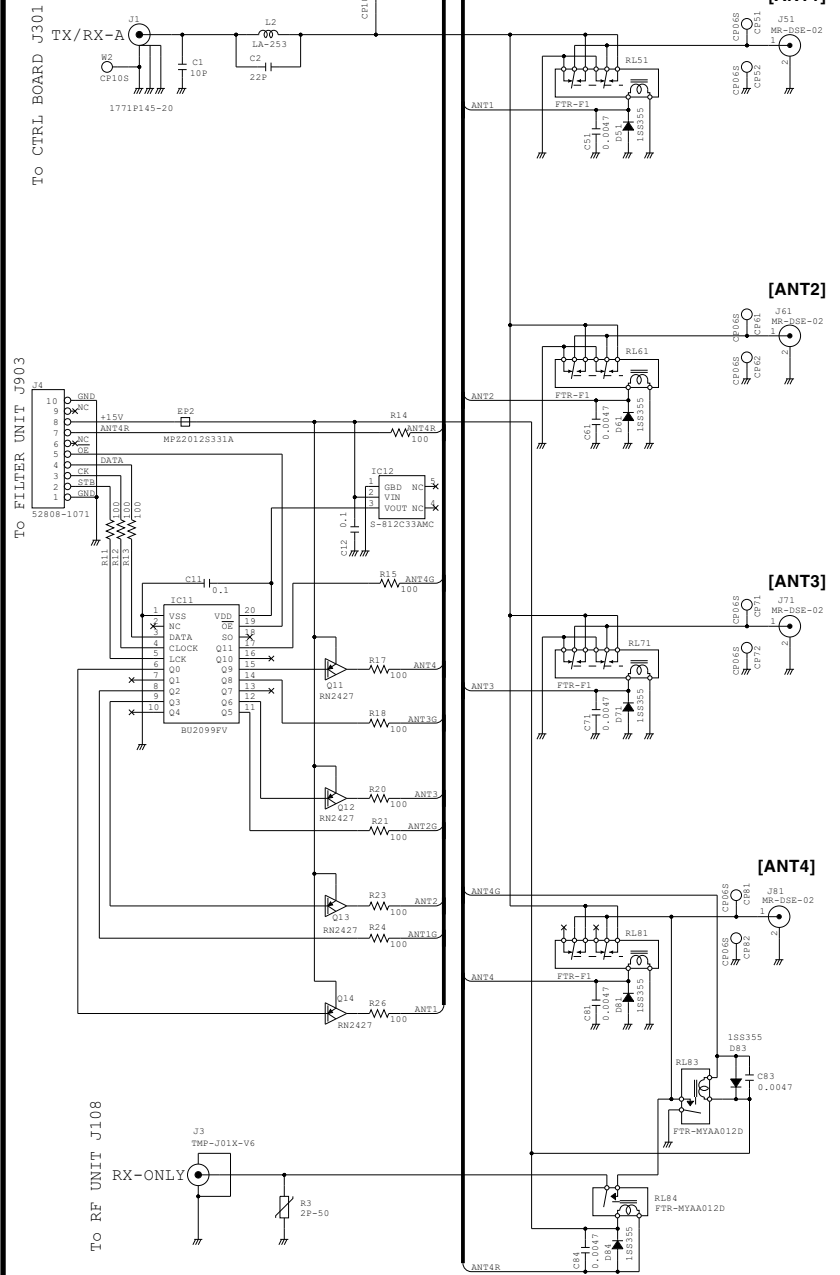

DIGISEL UNIT

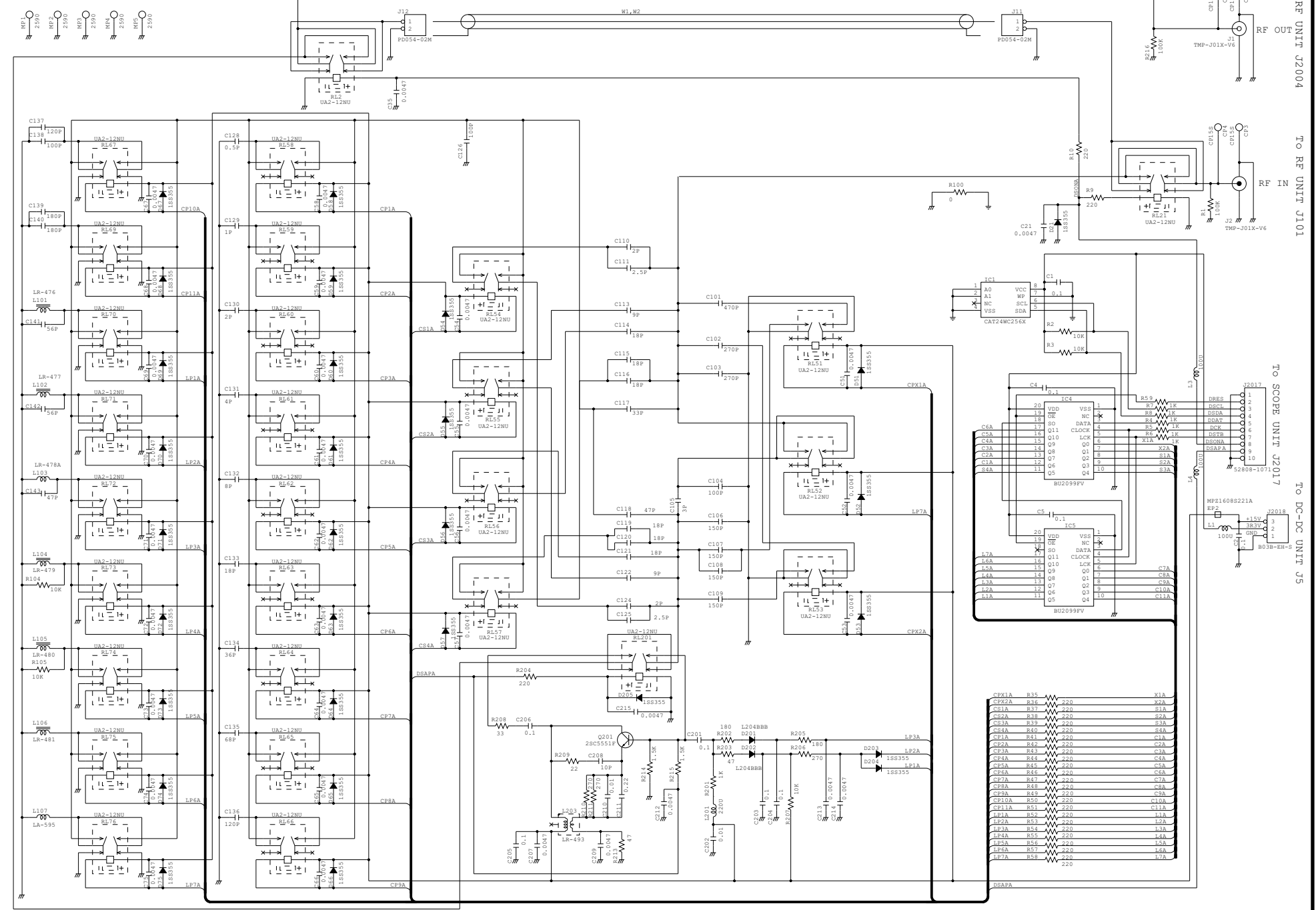

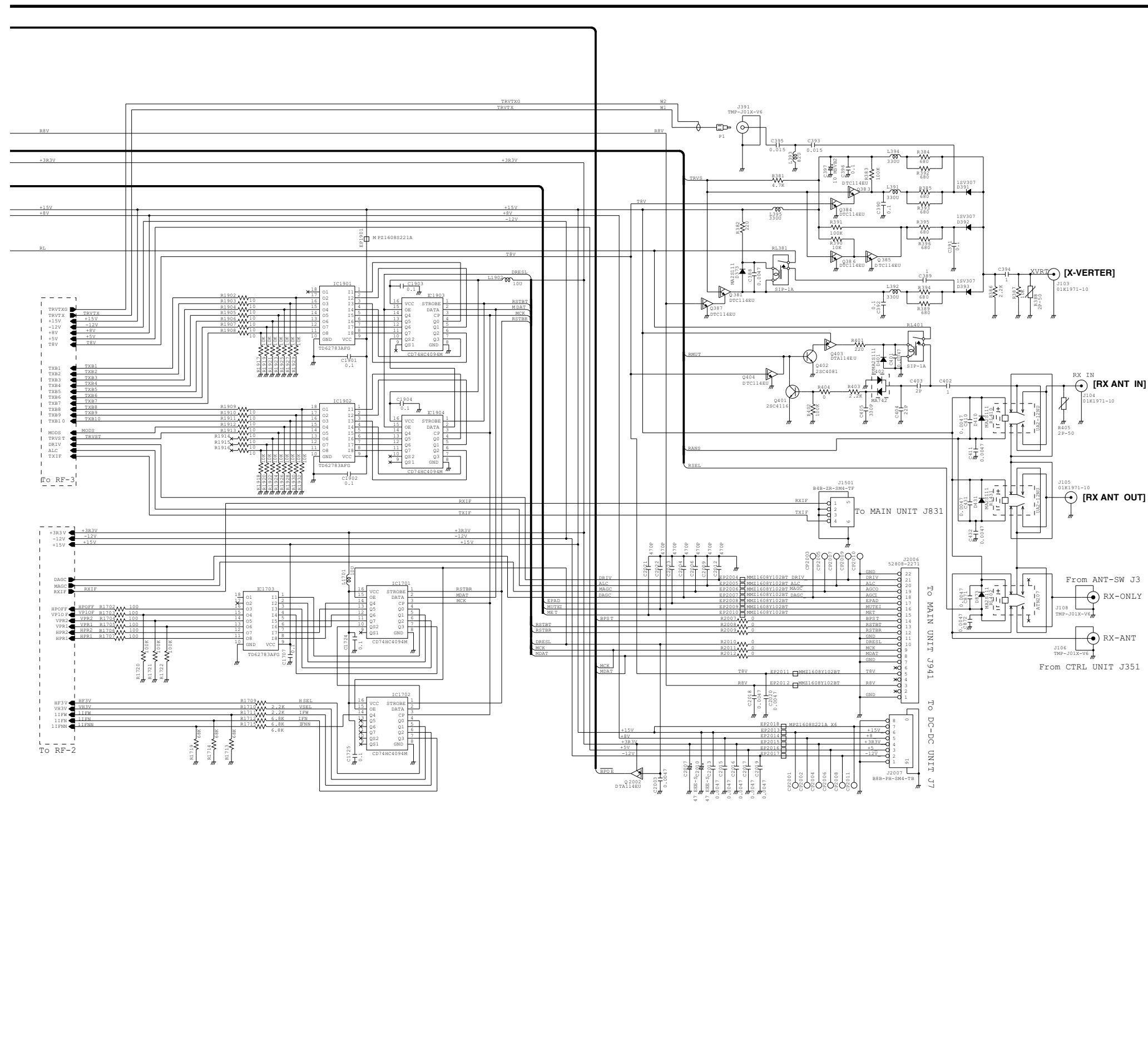

RF UNIT (RF-2)

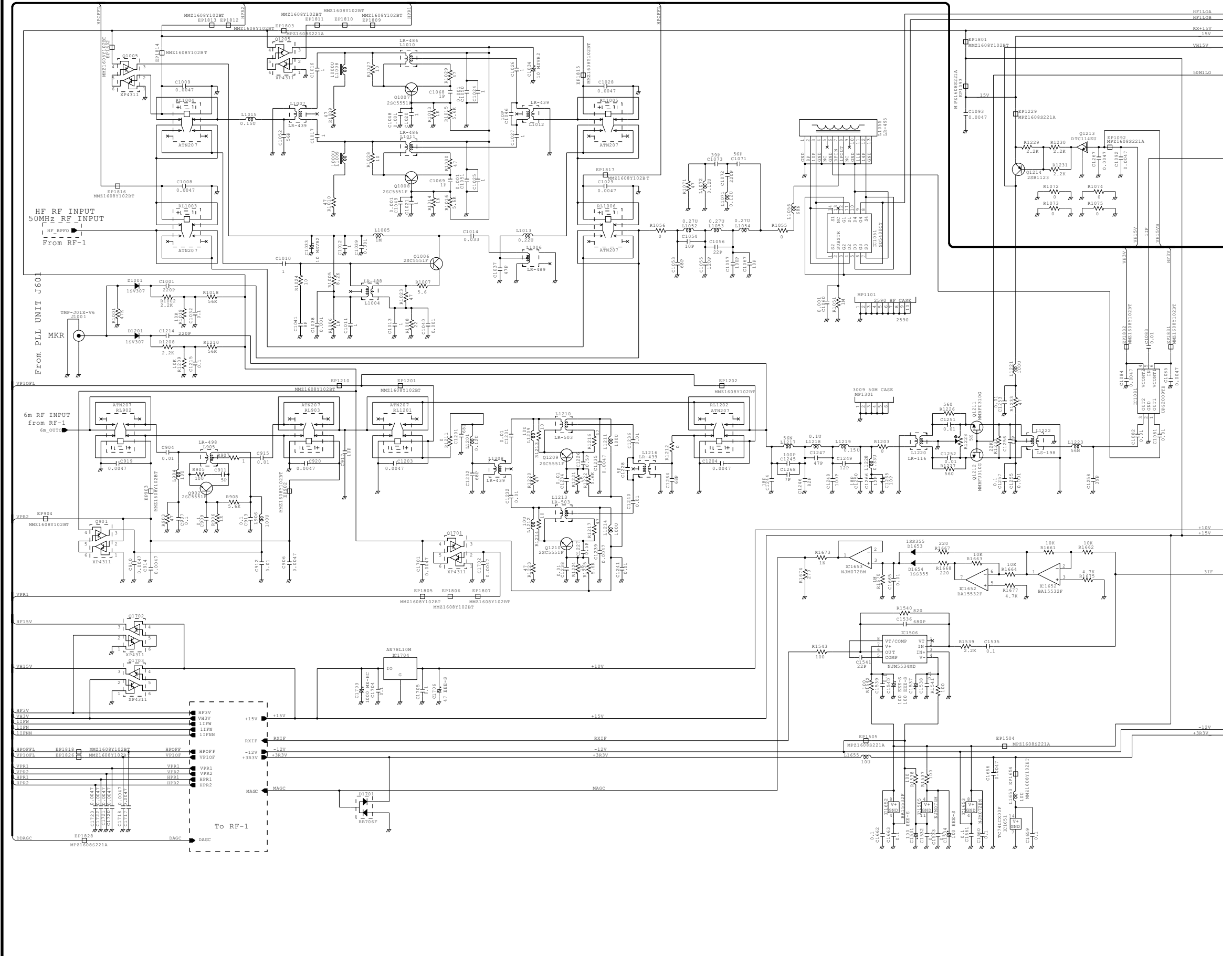

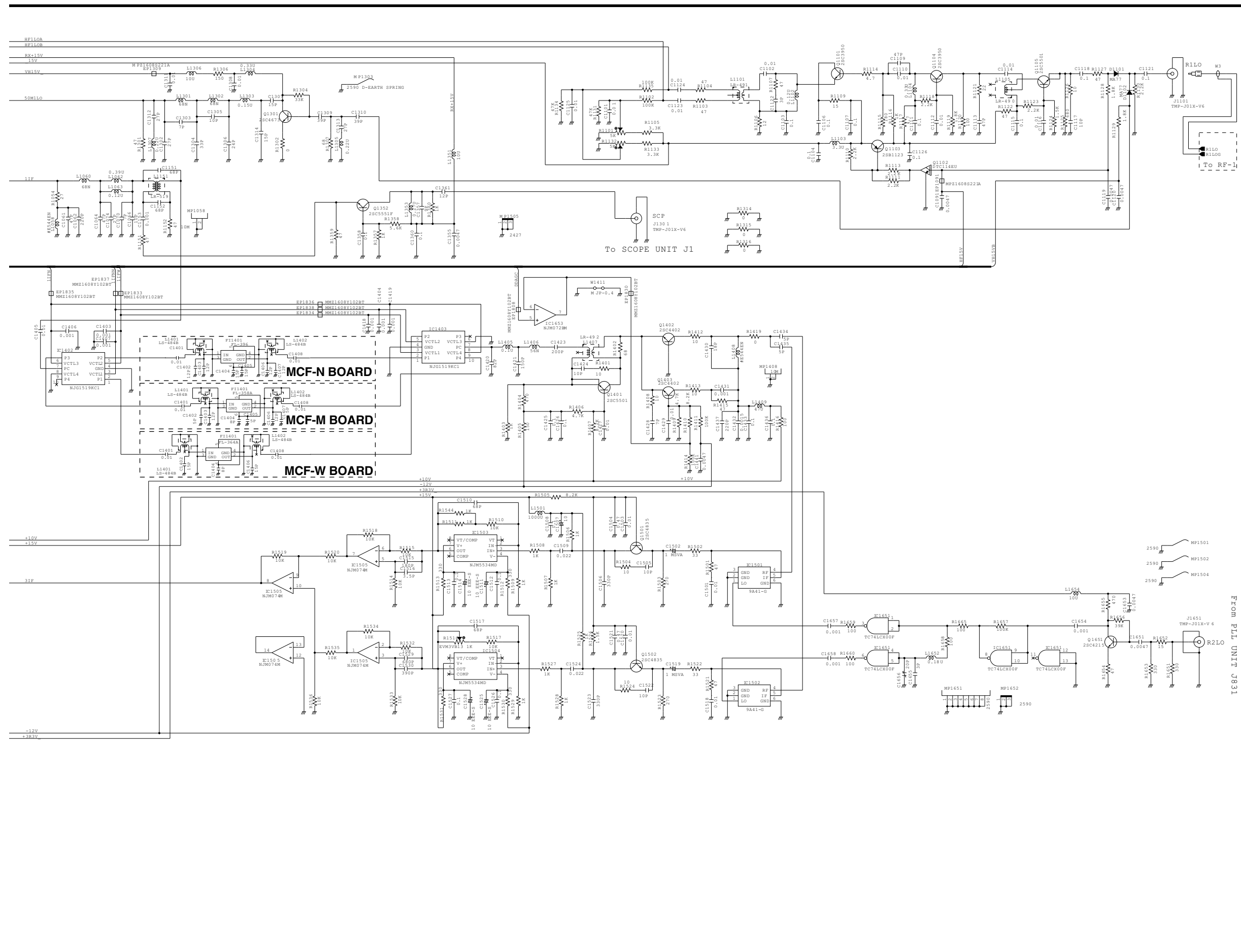

RF UNIT (RF-3)

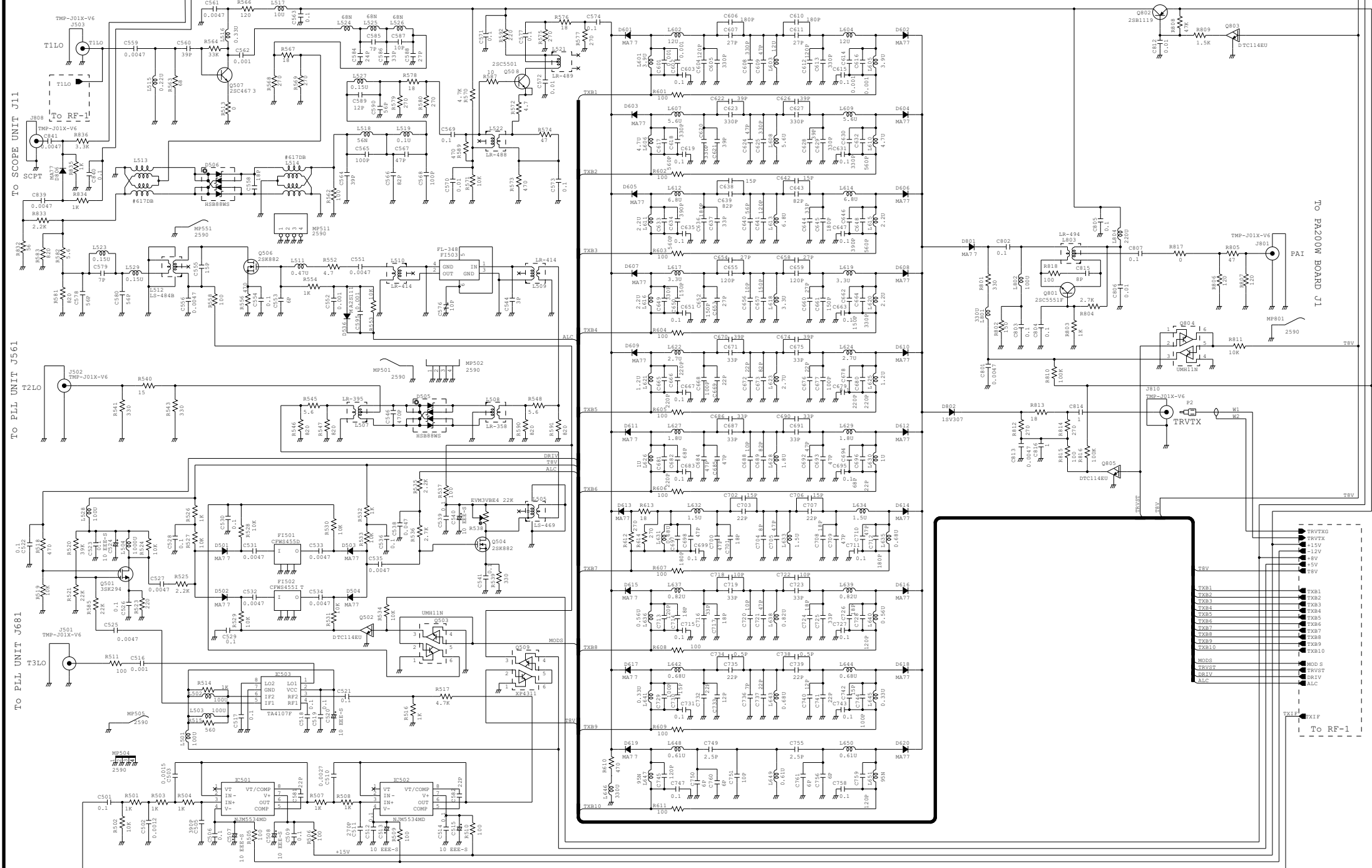

CTRL BOARD

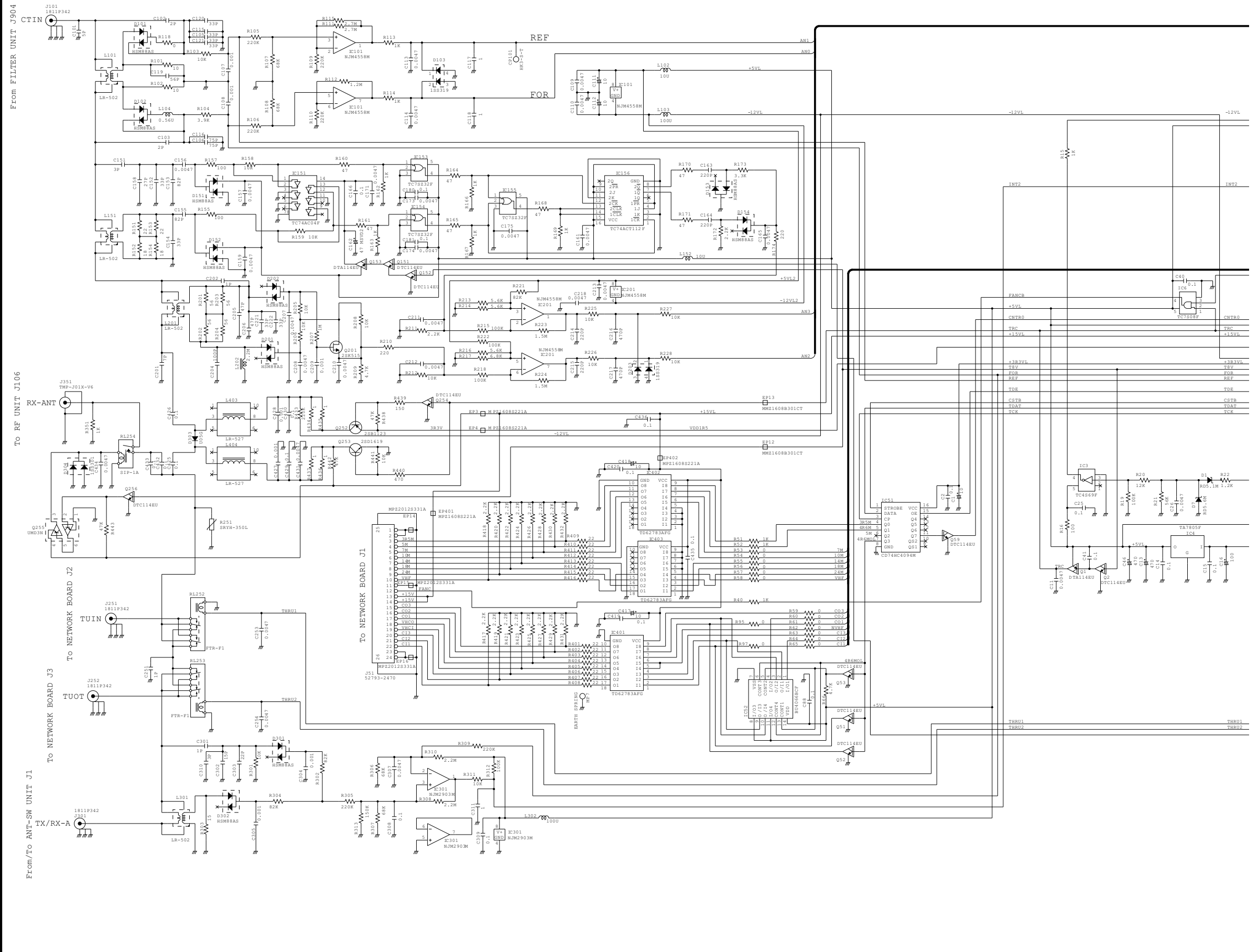

PA200W BOARD

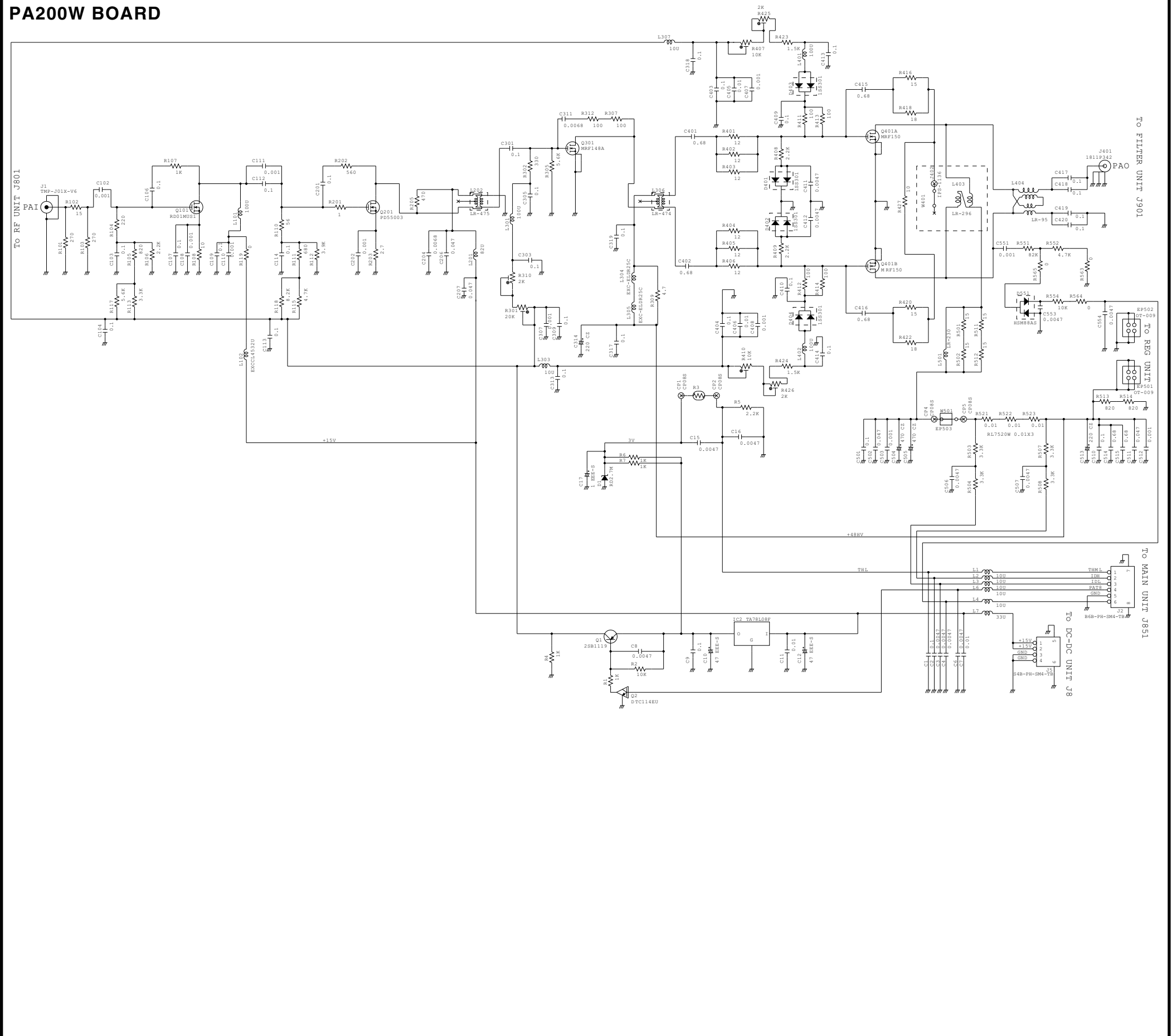

SCOPE UNIT (SCOPE-1)

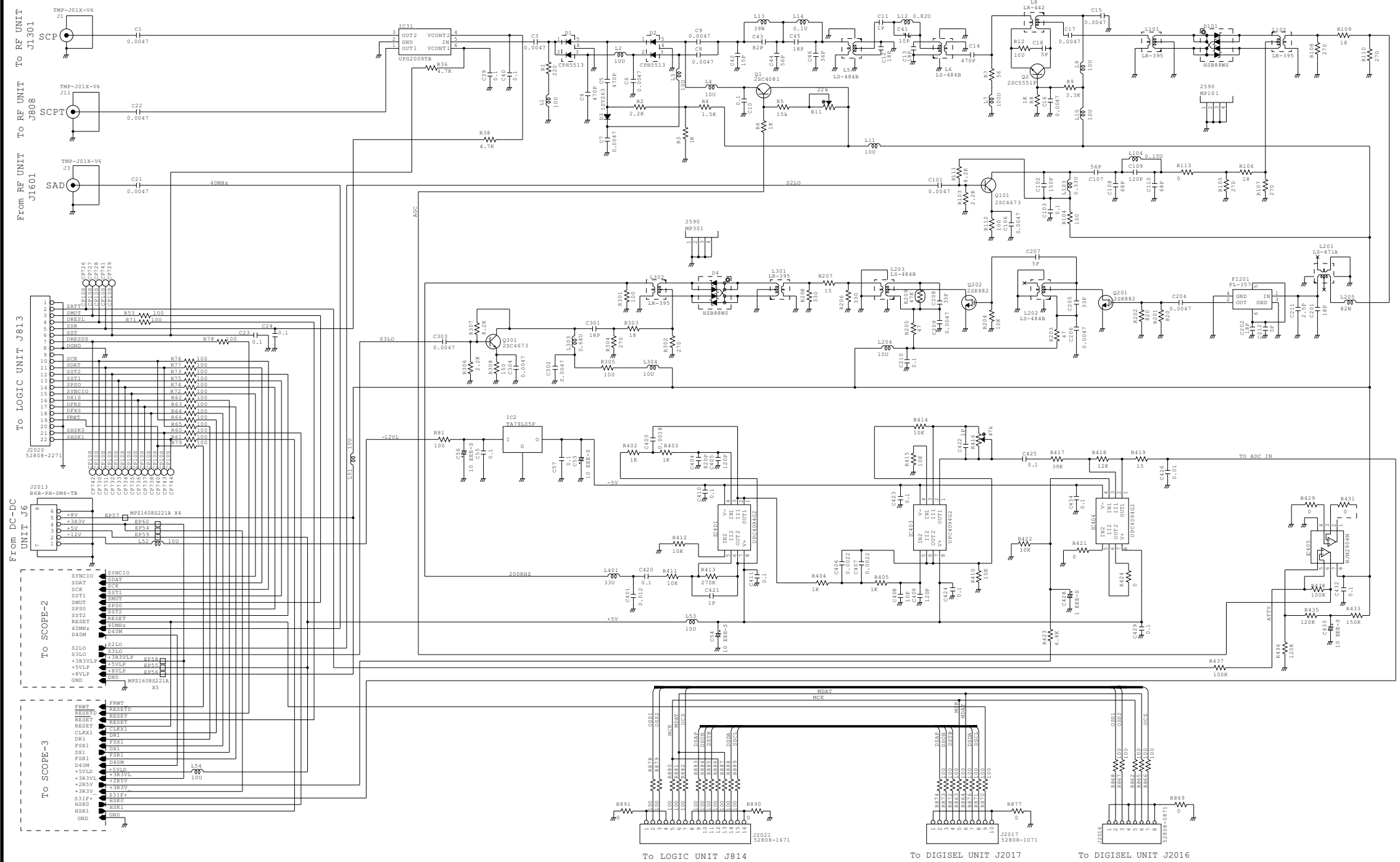

SCOPE UNIT (SCOPE-3)

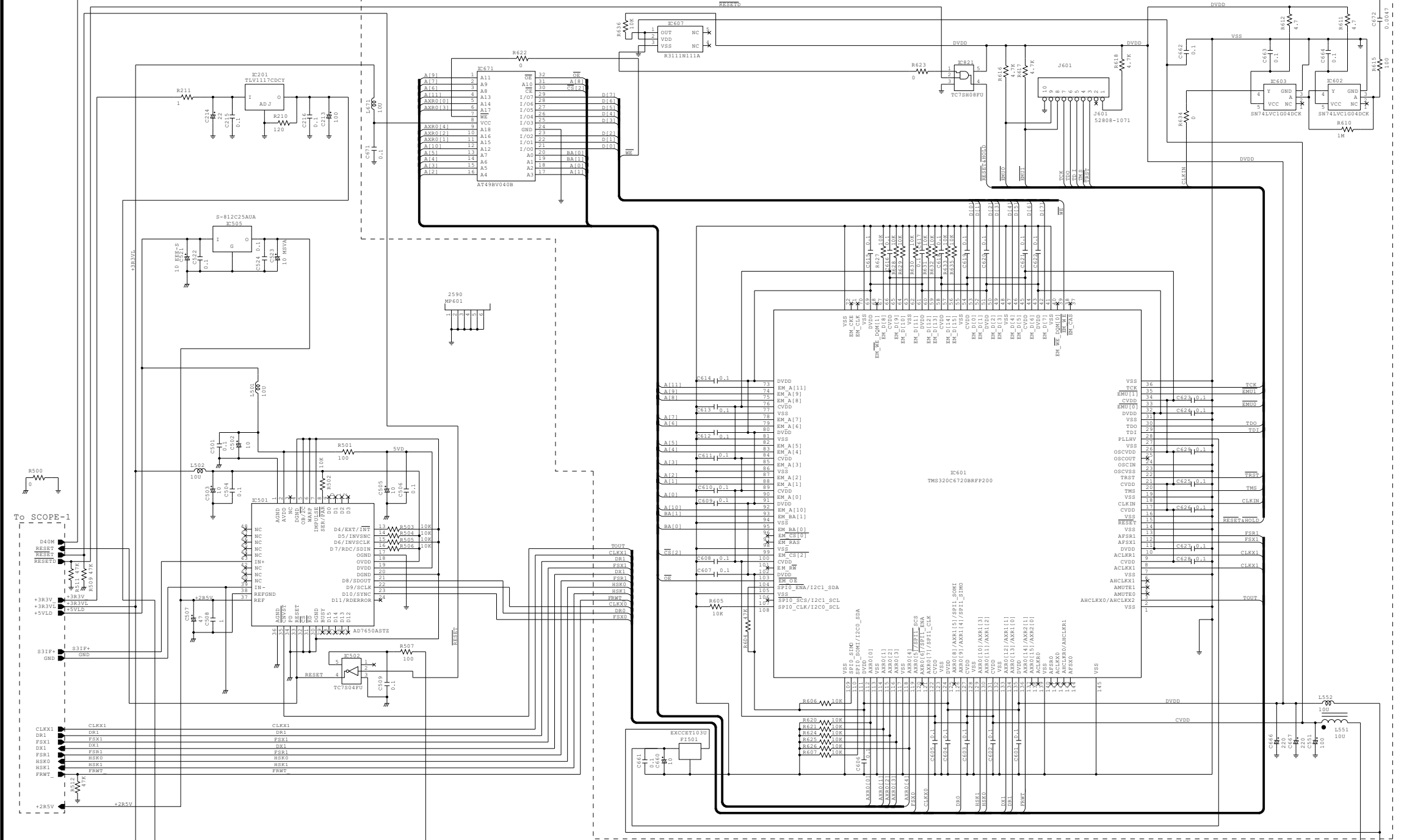

DC-DC UNIT

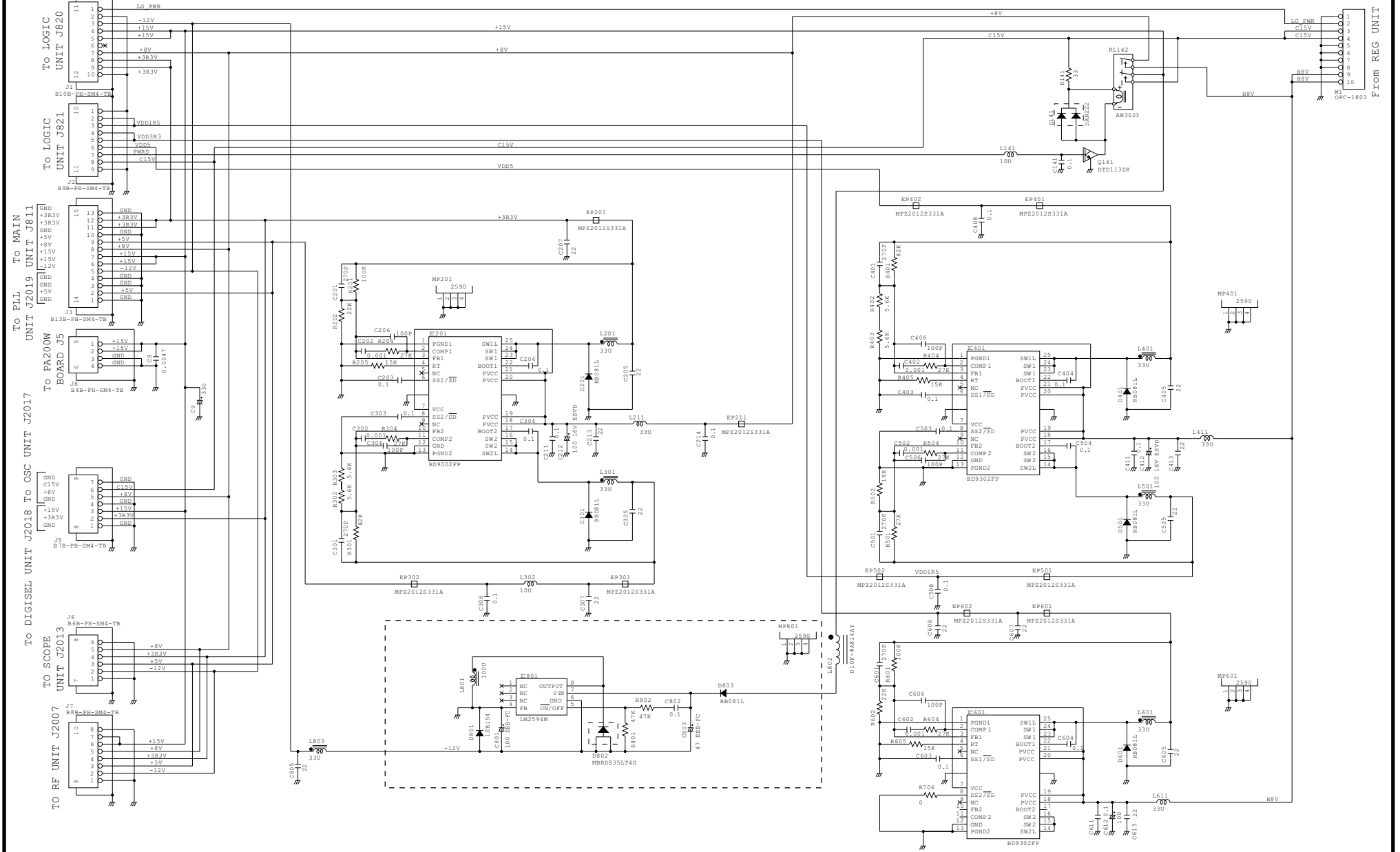

Jun. 2008



SERVICE MANUAL ADDENDUM

IC-7700

CONTENTS

PARTS LIST	1
BOARD LAYOUTS (MAIN AND SCOPE UNITS) ...	43
VOLTAGE DIAGRAM	45

SECTION 5 PARTS LIST

[RF UNIT]

REF NO.	ORDER NO.	DESCRIPTION	M.	H/V LOCATION
IC101	1130011510	S.IC BU2099FV-E2	T	146.4/152.3
IC102	1130011510	S.IC BU2099FV-E2	T	153.5/152.3
IC501	1110006100	S.IC NJM5534MD-TE1	T	156.6/40.9
IC502	1110006100	S.IC NJM5534MD-TE1	T	144.4/40.9
IC503	1110005461	S.IC TA4107F (TE12L,F)	T	133.6/40.9
IC1051	1190002010	S.IC SD5400CY <TOMO>	T	7.1/100.2
IC1081	1110006180	S.IC UPG2009TB-E3	T	39/91.7
IC1402	1190002110	S.IC NJG1519KC1-TE3	T	30.5/49.3
IC1403	1190002110	S.IC NJG1519KC1-TE3	T	30/4.2
IC1501	1110006121	S.IC DBM9A41-G-TR	T	88/15.3
IC1502	1110006121	S.IC DBM9A41-G-TR	T	96.5/15.3
IC1503	1110006100	S.IC NJM5534MD-TE1	T	119.2/7.5
IC1504	1110006100	S.IC NJM5534MD-TE1	T	119.2/25.9
IC1505	1110006190	S.IC NJM074M-TE1	T	136.2/16.7
IC1506	1110006100	S.IC NJM5534MD-TE1	T	147.6/19.3
IC1651	1130011921	S.IC TC74LXC00F (EL,F)	T	89.7/26.5
IC1652	1110005420	S.IC BA15532F-E2	T	147.6/8.7
IC1653	1110005100	S.IC NJM072BM-TE1	B	156/8.7
IC1701	1130011530	S.IC CD74HC4094M96	T	129/142.5
IC1702	1130011530	S.IC CD74HC4094M96	T	129/133
IC1703	1160000131	S.IC TD62783AFG (S,EL)	T	117.3/143.1
IC1704	1180000790	S.IC AN78L10M (E1)	T	65.4/27.8
IC1901	1160000131	S.IC TD62783AFG (S,EL)	T	140.9/119.5
IC1902	1160000131	S.IC TD62783AFG (S,EL)	T	154.5/119.5
IC1903	1130011530	S.IC CD74HC4094M96	T	143.7/131.5
IC1904	1130011530	S.IC CD74HC4094M96	T	157.3/131.5
Q260	1590001330	S.TR DTA114EUA T106	T	63.8/211.2
Q320	1590001330	S.TR DTA114EUA T106	B	63.8/211.4
Q381	1590000680	S.TR DTC114EUA T106	B	86.4/237
Q383	1590000680	S.TR DTC114EUA T106	B	106.6/231.2
Q384	1590000680	S.TR DTC114EUA T106	B	110/231.2
Q385	1590000680	S.TR DTC114EUA T106	B	101.5/240
Q386	1590000680	S.TR DTC114EUA T106	B	105.4/236.8
Q387	1590000680	S.TR DTC114EUA T106	B	86.4/234.1
Q401	1530002841	S.TR 2SC4116-Y (TE85R,F)	B	50.8/233.9
Q402	1530002060	S.TR 2SC4081 T106 R	B	54.2/236.2
Q403	1590001330	S.TR DTA114EUA T106	B	54.2/233.4
Q404	1590000680	S.TR DTC114EUA T106	B	50.8/236.7
Q421	1590000680	S.TR DTC114EUA T106	B	88.8/145.7
Q422	1590000680	S.TR DTC114EUA T106	B	92.3/145.6
Q501	1580000751	S.FET 3SK294 (TE85L,F)	T	123.7/42.5
Q502	1590000680	S.TR DTC114EUA T106	B	118.1/52.2
Q503	1590002710	S.TR UMH11NTN	T	118/52.5
Q504	1560000561	S.FET 2SK882-GR (TE85L,F)	B	109.2/59
Q506	1560000561	S.FET 2SK882-GR (TE85L,F)	B	106.7/99.1
Q507	1530003151	S.TR 2SC4673D-TD-E	B	87.2/118.2
Q508	1530003841	S.TR 2SC5501-4-TR-E	B	121.7/120
Q509	1590001960	S.TR XP4311 (TX)	T	123.2/51.3
Q801	1530003851	S.TR 2SC5551F-TD-E	B	162.2/68.6
Q802	1520000531	S.TR 2SB1119S-TD-E	B	159/97.5
Q803	1590000680	S.TR DTC114EUA T106	B	166.6/96.9
Q804	1590002710	S.TR UMH11NTN	T	158.9/59.4
Q805	1590000680	S.TR DTC114EUA T106	T	157.3/56.6
Q901	1590001960	S.TR XP4311 (TX)	T	77.5/142.3
Q902	1530003851	S.TR 2SC5551F-TD-E	B	65/139.3
Q1005	1590001960	S.TR XP4311 (TX)	T	41.6/141.6
Q1006	1530003851	S.TR 2SC5551F-TD-E	B	25.9/142.3
Q1007	1530003851	S.TR 2SC5551F-TD-E	B	35.4/130.6
Q1008	1530003851	S.TR 2SC5551F-TD-E	B	35.4/116.8
Q1101	1530003860	TR 2SC3950D		
Q1102	1590000680	S.TR DTC114EUA T106	T	18.5/66.3
Q1103	1520000561	S.TR 2SB1123 T-TD-E	B	15.4/72.3
Q1104	1530003860	TR 2SC3950D		
Q1105	1530003841	S.TR 2SC5501-4-TR-E	T	17.5/58
Q1205	1590001960	S.TR XP4311 (TX)	T	21.2/135.7
Q1209	1530003851	S.TR 2SC5551F-TD-E	B	50.3/109.5
Q1210	1530003851	S.TR 2SC5551F-TD-E	B	64.5/109.5
Q1211	1560001311	S.FET MMBFU310LT1G	T	28/90.6
Q1212	1560001311	S.FET MMBFU310LT1G	T	34/90.6
Q1213	1590000680	S.TR DTC114EUA T106	B	30/63.2
Q1214	1520000561	S.TR 2SB1123 T-TD-E	B	32/73.4
Q1301	1530003151	S.TR 2SC4673D-TD-E	T	29.7/66.1
Q1352	1530003851	S.TR 2SC5551F-TD-E	B	60.9/77.5
Q1401	1530003841	S.TR 2SC5501-4-TR-E	B	58.4/15
Q1402	1530003021	S.TR 2SC4402-3-TL-E	T	64.7/17.8
Q1403	1530003021	S.TR 2SC4402-3-TL-E	T	64.7/10.9
Q1501	1530003450	S.TR 2SC4835-R (TX)	T	110.2/8.6
Q1502	1530003450	S.TR 2SC4835-R (TX)	T	110.2/20.8
Q1651	1530002601	S.TR 2SC4215-O (TE85R,F)	B	98.3/35.1
Q1701	1590001960	S.TR XP4311 (TX)	T	72.7/98.9
Q1702	1590001960	S.TR XP4311 (TX)	T	54.7/52
Q1703	1590001960	S.TR XP4311 (TX)	T	54.7/54.5
Q2001	1530002060	S.TR 2SC4081 T106 R	B	160.7/233.8
Q2002	1590001330	S.TR DTA114EUA T106	B	146.5/142.6
D1	1790001250	S.DIO MA2S111-(TX)	B	147/218.8
D21	1790001250	S.DIO MA2S111-(TX)	B	131.5/218.8
D51	1790001250	S.DIO MA2S111-(TX)	B	116/218.8
D81	1790001250	S.DIO MA2S111-(TX)	B	100.6/218.8
D111	1790001250	S.DIO MA2S111-(TX)	B	85/218.8
D141	1790001250	S.DIO MA2S111-(TX)	B	69.5/218.8
D171	1790001250	S.DIO MA2S111-(TX)	B	50/218.8
D201	1790001250	S.DIO MA2S111-(TX)	B	34.5/218.8
D231	1790001250	S.DIO MA2S111-(TX)	B	19.1/218.8
D260	1750000581	S.DIO 1SV307 (TPH3,F)	T	65.1/175.7

[RF UNIT]

REF NO.	ORDER NO.	DESCRIPTION	M.	H/V LOCATION
D261	1790001250	S.DIO MA2S111-(TX)	B	3.8/218.8
D262	1750000581	S.DIO 1SV307 (TPH3,F)	T	65/204.5
D320	1750000581	S.DIO 1SV307 (TPH3,F)	B	65.1/175.7
D321	1750000581	S.DIO 1SV307 (TPH3,F)	B	65/204.5
D351	1790001250	S.DIO MA2S111-(TX)	B	87/227.1
D352	1790001250	S.DIO MA2S111-(TX)	B	83.1/233.5
D353	1790001250	S.DIO MA2S111-(TX)	B	72.6/227.1
D373	1790001250	S.DIO MA2S111-(TX)	B	78.5/242.3
D391	1750000581	S.DIO 1SV307 (TPH3,F)	B	95.7/233
D392	1750000581	S.DIO 1SV307 (TPH3,F)	B	95.7/236.5
D393	1750000581	S.DIO 1SV307 (TPH3,F)	B	92.7/236.5
D401	1790001250	S.DIO MA2S111-(TX)	B	50.9/228.5
D402	1790000980	S.DIO MA742 (TX)	B	46.1/235.1
D410	1790001250	S.DIO MA2S111-(TX)	B	37/224.9
D421	1790000620	S.DIO MA77 (TX)	B	86/143
D422	1790000620	S.DIO MA77 (TX)	B	95/143
D423	1790000620	S.DIO MA77 (TX)	B	88.7/136.9
D424	1790000620	S.DIO MA77 (TX)	B	92.5/136.9
D431	1790001250	S.DIO MA2S111-(TX)	B	30.9/224.9
D501	1790000620	S.DIO MA77 (TX)	B	107.1/41
D502	1790000620	S.DIO MA77 (TX)	B	115/41
D503	1790000620	S.DIO MA77 (TX)	B	104.5/53.9
D504	1790000620	S.DIO MA77 (TX)	B	112.4/53.9
D505	1750000431	S.DIO HSB88WSTR-E	T	100.9/71.4
D506	1750000431	S.DIO HSB88WSTR-E	T	100.9/113
D536	1790001250	S.DIO MA2S111-(TX)	B	114.6/105.5
D601	1790000620	S.DIO MA77 (TX)	B	124.1/60.2
D602	1790000620	S.DIO MA77 (TX)	B	145.1/60.2
D603	1790000620	S.DIO MA77 (TX)	B	124.1/71
D604	1790000620	S.DIO MA77 (TX)	B	145.1/71
D605	1790000620	S.DIO MA77 (TX)	B	124.1/81.8
D606	1790000620	S.DIO MA77 (TX)	B	145.1/81.8
D607	1790000620	S.DIO MA77 (TX)	B	124.1/92.6
D608	1790000620	S.DIO MA77 (TX)	B	145.1/92.6
D609	1790000620	S.DIO MA77 (TX)	B	124.1/103.5
D610	1790000620	S.DIO MA77 (TX)	B	145.1/103.5
D611	1790000620	S.DIO MA77 (TX)	T	124.1/66.3
D612	1790000620	S.DIO MA77 (TX)	T	145.1/66.3
D613	1790000620	S.DIO MA77 (TX)	T	124.1/74.2
D614	1790000620	S.DIO MA77 (TX)	T	145.1/75.3
D615	1790000620	S.DIO MA77 (TX)	T	124.1/84.4
D616	1790000620	S.DIO MA77 (TX)	T	145.1/84.3
D617	1790000620	S.DIO MA77 (TX)	T	124.1/93.3
D618	1790000620	S.DIO MA77 (TX)	T	145.1/93.3
D619	1790000620	S.DIO MA77 (TX)	T	124.1/102.3
D620	1790000620	S.DIO MA77 (TX)	T	145.1/102.3
D801	1790000620	S.DIO MA77 (TX)	T	148.2/62
D802	1750000581	S.DIO 1SV307 (TPH3,F)	T	148.2/60.2
D806	1790000620	S.DIO MA77 (TX)	B	89.3/94.5
D873	1790001250	S.DIO MA2S111-(TX)	B	27.7/226.1
D1001	1750000581	S.DIO 1SV307 (TPH3,F)	T	18.9/136
D1101	1790000620	S.DIO MA77 (TX)	T	10.6/53.7
D1102	1790000620	S.DIO MA77 (TX)	T	25.5/53.7
D1201	1750000581	S.DIO 1SV307 (TPH3,F)	T	46.3/92.3
D1653	1750000550	S.DIO 1SS355 TE-17	B	149.6/11.4
D1654	1750000550	S.DIO 1SS355 TE-17	B	149.7/6
D1701	1790001670	S.DIO RB706F-40T106	B	161.9/14.3
D2001	1790001750	S.DIO DSM3MA4	T	120.2/241.3
D2002	1790001750	S.DIO DSM3MA4	T	115.6/241.3
D2003	1790001670	S.DIO RB706F-40T106	B	165.6/240.3
D2004	1750000550	S.DIO 1SS355 TE-17	B	154.7/234
FI501	2020001070	CER CFWLA455KDF-A-B0 (CFWS455D)		
FI502	2020001510	CER CFWLA455KJFA-B0 (CFWS455IT)		
FI503	20100002580	S.FIL FL-348 (64.455 MHz)	T	112/87
L1	6200005521	S.COL NLV25T-470J	B	149.9/159.8
L2	6200005521	S.COL NLV25T-470J	B	143.9/159.8
L3	6200010830	S.COL C2520C-3R3G-A	T	147.8/183.8
L4	6200010830	S.COL C2520C-3R3G-A	T	147.8/195.9
L5	6200010830	S.COL C2520C-3R3G-A	T	147/188.1
L6	6200010830	S.COL C2520C-3R3G-A	T	147/200.2
L21	6200005521	S.COL NLV25T-470J	B	134.4/161
L22	6200005521	S.COL NLV25T-470J	B	128.4/161
L23	6140004040	COL LR-443		
L24	6140004050	COL LR-444		
L25	6140004050	COL LR-444		
L26	6140004050	COL LR-444		
L27	6140004040	COL LR-443		
L51	6200005521	S.COL NLV25T-470J	B	118.9/161
L52	6200005521	S.COL NLV25T-470J	B	112.9/161
L53	6140004060	COL LR-445		
L54	6140004080	COL LR-446		
L55	6140004080	COL LR-446		
L56	6140004080	COL LR-446		
L57	6140004060	COL LR-445		
L81	6200005521	S.COL NLV25T-470J	B	103.5/161
L82	6200005521	S.COL NLV25T-470J	B	97.5/161
L83	6140004090	COL LR-447		
L84	6140004230	COL LR-458		
L85	6140004230	COL LR-458		
L86	6140004230	COL LR-458		
L87	6140004090	COL LR-447		
L111	6200005521	S.COL NLV25T-470J	B	88/161
L112	6200005521	S.COL NLV25T-470J	B	82/161
L113	6140004090	COL LR-447		

M.=Mounted side (T: Mounted on the Top side B: Mounted on the Bottom side) S.=Surface mount

[RF UNIT]

REF NO.	ORDER NO.	DESCRIPTION	M.	H/V LOCATION
L114	6140004100	COL LR-448		
L115	6140004100	COL LR-448		
L116	6140004100	COL LR-448		
L117	6140004090	COL LR-447		
L141	6200005521	S.COL NLV25T-470J	B	72.5/161
L142	6200005521	S.COL NLV25T-470J	B	66.5/161
L143	6140004110	COL LR-449		
L144	6140004120	COL LR-450		
L145	6140004120	COL LR-450		
L146	6140004120	COL LR-450		
L147	6140004110	COL LR-449		
L171	6200005521	S.COL NLV25T-470J	B	53/161
L172	6200005521	S.COL NLV25T-470J	B	47/161
L173	6140004140	COL LR-451		
L174	6140004150	COL LR-452		
L175	6140004150	COL LR-452		
L176	6140004150	COL LR-452		
L177	6140004140	COL LR-451		
L201	6200007021	S.COL NLV25T-270J	B	37.5/161
L202	6200007021	S.COL NLV25T-270J	B	31.5/161
L203	6140004160	COL LR-453		
L204	6140004180	COL LR-454		
L205	6140004180	COL LR-454		
L206	6140004180	COL LR-454		
L207	6140004160	COL LR-453		
L231	6200005011	S.COL NLV25T-100J	B	22.1/161
L232	6200005011	S.COL NLV25T-100J	B	16.1/161
L233	6140004190	COL LR-455		
L234	6140004210	COL LR-456		
L235	6140004210	COL LR-456		
L236	6140004210	COL LR-456		
L237	6140004190	COL LR-455		
L260	6200003281	S.COL NLV25T-2R2J	T	63.7/169
L261	6200009141	S.COL NLV25T-6R8J	B	8.1/160.4
L262	6200009141	S.COL NLV25T-6R8J	B	2.1/160.4
L263	6140004220	COL LR-457		
L264	6140004160	COL LR-453		
L265	6140004160	COL LR-453		
L266	6140004160	COL LR-453		
L267	6140004220	COL LR-457		
L268	6200003281	S.COL NLV25T-2R2J	T	63.2/220.8
L291	6200003281	S.COL NLV25T-2R2J	T	64.1/191.4
L292	6200003281	S.COL NLV25T-2R2J	T	63.8/217.7
L293	6200010180	S.COL LQW2BHN82NG03L	T	64.1/180.7
L294	6200002981	S.COL NLV32T-R56J	T	64.4/185.2
L295	6200010180	S.COL LQW2BHN82NG03L	T	64.1/195
L296	6200010870	S.COL C2520C-R33G-A (0.33U)	T	63.7/201.1
L320	6200001831	S.COL NLV32T-100J	T	64.2/158.2
L321	6200003281	S.COL NLV25T-2R2J	B	68/195.8
L322	6200003281	S.COL NLV25T-2R2J	B	62.8/220.7
L323	6200003011	S.COL NLV32T-R27J	B	64.4/179.8
L324	6200003001	S.COL NLV32T-R22J	B	63.5/188.2
L325	6200003011	S.COL NLV32T-R27J	B	63.8/196.3
L326	6200001831	S.COL NLV32T-100J	T	53.1/221.6
L391	6200005491	S.COL NLV32T-331J	B	102.6/231.2
L392	6200005491	S.COL NLV32T-331J	B	83.5/239.9
L393	6200003211	S.COL NLV32T-820J	B	92.6/229.7
L394	6200005491	S.COL NLV32T-331J	B	103.5/227.8
L395	6200005491	S.COL NLV32T-331J	B	108.2/224.7
L421	6200008641	S.COL NLV32T-391J	B	95.7/148.9
L501	6200003261	S.COL NLV32T-101J	B	124.7/42.6
L502	6200003261	S.COL NLV32T-101J	B	128.7/39.2
L503	6200003261	S.COL NLV32T-101J	B	128.7/42.6
L504	6200003520	S.COL ELJFB 102K-F	T	120.4/39.5
L505	6150004090	COL LS-469 (C-13969)		
L507	6140003530	COL LR-395		
L508	6140003210	S.COL LR-358	T	100.9/77.3
L509	6140003770	S.COL LR-414 4KBL (STP-01435)	T	112/78.4
L510	6140003770	S.COL LR-414 4KBL (STP-01435)	T	112/95.6
L511	6200003031	S.COL NLV32T-R47J	B	110.7/100.7
L512	6150004280	COL LS-484B (C-14927)		
L513	6140002551	S.COL #617DB-1919=P3	T	100.9/106.9
L514	6140002551	S.COL #617DB-1919=P3	T	100.9/119.1
L515	6200003001	S.COL NLV32T-R22J	B	92.5/123.6
L516	6200003021	S.COL NLV32T-R33J	B	94.8/117.7
L517	6200001831	S.COL NLV32T-100J	B	98.8/123.6
L518	6200010720	S.COL C2520C-56NG-A	T	106.5/126.4
L519	6200010860	S.COL C2520C-R10G-A (0.1U)	T	110/128.2
L521	6140003900	COL LR-489		
L522	6140003890	COL LR-488		
L523	6200010381	S.COL ELJRE R15JFA	B	96.2/97
L524	6180002971	S.COL NLV32T-068J	B	88.5/108.5
L525	6180002971	S.COL NLV32T-068J	B	90.7/112.5
L526	6180002971	S.COL NLV32T-068J	B	95/113.2
L527	6200010660	S.COL C2520C-R15G-A (0.15U)	T	115/127.4
L528	6200003261	S.COL NLV32T-101J	B	120.1/36.8
L529	6200010381	S.COL ELJRE R15JFA	B	96.2/93.8
L601	6200003101	S.COL NLV32T-3R9J	B	125/63.7
L602	6200003131	S.COL NLV32T-120J	B	128.5/60.2
L603	6200003131	S.COL NLV32T-120J	B	134.9/64.4
L604	6200003131	S.COL NLV32T-120J	B	140.7/60.2
L605	6200003101	S.COL NLV32T-3R9J	B	144.3/63.7
L606	6200002961	S.COL NLV32T-4R7J	B	125/74.5
L607	6200001851	S.COL NLV32T-5R6J	B	128.5/71
L608	6200001851	S.COL NLV32T-5R6J	B	134.6/75.2
L609	6200001851	S.COL NLV32T-5R6J	B	140.7/71
L610	6200002961	S.COL NLV32T-4R7J	B	144.3/74.5
L611	6200002991	S.COL NLV32T-2R2J	B	125/85.3
L612	6200003111	S.COL NLV32T-6R8J	B	128.5/81.8
L613	6200003111	S.COL NLV32T-6R8J	B	134.6/86
L614	6200003111	S.COL NLV32T-6R8J	B	140.7/81.8
L615	6200002991	S.COL NLV32T-2R2J	B	144.3/85.3
L616	6200002991	S.COL NLV32T-2R2J	B	125/96.2
L617	6200003321	S.COL NLV32T-3R3J	B	128.5/92.6

[RF UNIT]

REF NO.	ORDER NO.	DESCRIPTION	M.	H/V LOCATION
L618	6200003321	S.COL NLV32T-3R3J	B	134.6/96.8
L619	6200003321	S.COL NLV32T-3R3J	B	140.7/92.6
L620	6200002991	S.COL NLV32T-2R2J	B	144.3/96.1
L621	6200003061	S.COL NLV32T-1R2J	B	125/107
L622	6200003091	S.COL NLV32T-2R7J	B	128.5/103.5
L623	6200003091	S.COL NLV32T-2R7J	B	134.6/107.7
L624	6200003091	S.COL NLV32T-2R7J	B	140.7/103.5
L625	6200003061	S.COL NLV32T-1R2J	B	144.3/107
L626	6200003331	S.COL NLV32T-1R0J	T	128.1/63.3
L627	6200003081	S.COL NLV32T-1R8J	T	128.1/66.3
L628	6200003081	S.COL NLV32T-1R8J	T	134.6/65.7
L629	6200003081	S.COL NLV32T-1R8J	T	141.2/66.3
L630	6200003331	S.COL NLV32T-1R0J	T	141.2/63.3
L631	6200003041	S.COL NLV32T-R68J	T	128.1/72.3
L632	6200003071	S.COL NLV32T-1R5J	T	128.1/75.3
L633	6200003071	S.COL NLV32T-1R5J	T	134.6/74.7
L634	6200003071	S.COL NLV32T-1R5J	T	141.2/75.3
L635	6200003041	S.COL NLV32T-R68J	T	141.2/72.3
L636	6200002981	S.COL NLV32T-R56J	T	128.1/81.3
L637	6200003051	S.COL NLV32T-R82J	T	128.1/84.4
L638	6200003051	S.COL NLV32T-R82J	T	134.6/83.7
L639	6200003051	S.COL NLV32T-R82J	T	141.2/84.3
L640	6200002981	S.COL NLV32T-R56J	T	141.2/81.3
L641	6200003021	S.COL NLV32T-R33J	T	128.1/90.3
L642	6200003041	S.COL NLV32T-R68J	T	128.1/93.3
L643	6200003041	S.COL NLV32T-R68J	T	134.6/92.7
L644	6200003041	S.COL NLV32T-R68J	T	141.2/93.3
L645	6200003021	S.COL NLV32T-R33J	T	141.2/90.3
L646	6200005491	S.COL NLV32T-331J	T	128.1/105.3
L647	6200007810	S.COL LQH31HN95NK03L	T	126.8/98.7
L648	6200009810	S.COL LQH31HNR61J03L	T	128.1/102.3
L649	6200009810	S.COL LQH31HNR61J03L	T	134.4/101
L650	6200009810	S.COL LQH31HNR61J03L	T	141.2/102.3
L651	6200007810	S.COL LQH31HN95NK03L	T	142.6/98.7
L801	6200005491	S.COL NLV32T-331J	T	155.2/62.9
L802	6200003261	S.COL NLV32T-101J	B	151.1/62.1
L803	6140003970	COL LR-494		
L804	6200003241	S.COL NLV32T-221J	B	152.1/76.8
L904	6200001831	S.COL NLV32T-100J	B	76.7/140.7
L905	6140004380	COL LR-498		
L906	6200009690	S.COL LQH43CN101K03L	B	77.6/137
L1004	6140003890	COL LR-488		
L1005	6180001000	COL LAL 04NA 102K		
L1006	6140003900	COL LR-489		
L1007	6140003800	COL LR-439		
L1008	6190001650	COL ELC06D102E		
L1009	6190001650	COL ELC06D102E		
L1010	6140003880	COL LR-486		
L1011	6140003880	COL LR-486		
L1012	6140003800	COL LR-439		
L1013	6200010680	S.COL C2520C-R22G-A (0.22U)	T	21.8/139.4
L1015	6200007790	S.COL LQW2BHN15J03L	T	47.6/117.6
L1052	6200010740	S.COL C2520C-R27G-A	T	6.7/139.9
L1053	6200010740	S.COL C2520C-R27G-A	T	6/136.1
L1054	6200010740	S.COL C2520C-R27G-A	T	6.7/132.3
L1055	6140003960	COL LR-495		
L1056	6200010730	S.COL C2520C-68NG-A	T	13/116.3
L1058	6190001631	COL #E544EN-100021		
L1060	6200010730	S.COL C2520C-68NG-A	T	51.2/87.5
L1062	6200011450	S.COL C2520C-R39G-A	T	53.4/83.7
L1063	6200010650	S.COL C2520C-R12G-A (0.12U)	T	53/79.9
L1071	6200007780	S.COL LQW2BHN12J03L	T	2.7/128
L1072	6200007780	S.COL LQW2BHN12J03L	T	3.3/130.8
L1101	6140003920	COL LR-491		
L1102	6200010650	S.COL C2520C-R12G-A (0.12U)	T	7.1/82.2
L1103	6180001250	COL LAL 04NA 3R3K		
L1104	6200010870	S.COL C2520C-R33G-A (0.33U)	T	5.6/64.2
L1105	6140003910	COL LR-490		
L1151	6140004640	COL LR-519		
L1201	6200007780	S.COL LQW2BHN12J03L	T	58.4/121
L1208	6140003800	COL LR-439		
L1209	6200001831	S.COL NLV32T-100J	B	56.9/115.2
L1210	6140004440	COL LR-503		
L1211	6200009690	S.COL LQH43CN101K03L	T	56.8/102.1
L1212	6200001831	S.COL NLV32T-100J	B	71.4/115.2
L1213	6140004440	COL LR-503		
L1214	6200009690	S.COL LQH43CN101K03L	T	71.4/102.1
L1216	6140003800	COL LR-439		
L1217	6200007750	S.COL LQW2BHN56NJ03L	T	49.7/94
L1218	6200007770	S.COL LQW2BHN10J03L	T	48.9/99.4
L1219	6200007790	S.COL LQW2BHN15J03L	T	44.9/100.3
L1220	6140000930	COL LR-116		
L1221	6200003261	S.COL NLV32T-101J	B	38.1/76.3
L1222	6150001770	COL LS-198		
L1223	6200007750	S.COL LQW2BHN56NJ03L	T	33.8/78.6
L1228	6200010870	S.COL C2520C-R33G-A (0.33U)	T	44.9/104.9
L1301	6200008090	S.COL LQW2BHN68NJ03L	T	30.3/75.1
L1302	6200008090	S.COL LQW2BHN68NJ03L	T	31/71.5
L1303	6200007790	S.COL LQW2BHN15J03L	T	34.1/69.5
L1304	6200010870	S.COL C2520C-R33G-A (0.33U)	T	33.8/64.2
L1305	6200003001	S.COL NLV32T-R22J	T	28.2/61.3
L1306	6200001831	S.COL NLV32T-100J	B	34.7/68.3
L1307	6200003001	S.COL NLV32T-R22J	T	34.2/75
L1351	6200001831	S.COL NLV32T-100J	B	69.1/77.9
L1353	6200010740	S.COL C2520C-R27G-A	T	65.1/76.1
L1405	6200007770	S.COL LQW2BHN10J03L	T	52.4/6
L1406	6200007750	S.COL LQW2BHN56NJ03L	T	52.4/9.6
L1407	6140003930	COL LR-492		
L1408	6190001621			

[RF UNIT]

REF NO.	ORDER NO.	DESCRIPTION	M.	H/V LOCATION
L1655	6200001831	S.COL NLV32T-100J	B	97.5/46.3
L1701	6200001831	S.COL NLV32T-100J	B	121.8/148.2
L1902	6200001831	S.COL NLV32T-100J	T	151.5/137.7
L2001	6200009790	S.COL BLM31PG121SN1	B	123.5/238.5
L2003	6200003261	S.COL NLV32T-101J	B	142/241.8
L2004	6200003261	S.COL NLV32T-101J	B	154.5/237.6
R1	7030003640	S.RES ERJ3GEYJ 473 V (47 k)	T	148.7/177.3
R3	7030003860	S.RES ERJ3GE JPW V	T	146.5/178.8
R101	7030003320	S.RES ERJ3GEYJ 101 V (100)	T	150/158.2
R102	7030003320	S.RES ERJ3GEYJ 101 V (100)	T	138/153.3
R103	7030003320	S.RES ERJ3GEYJ 101 V (100)	T	140.9/154.1
R104	7030003320	S.RES ERJ3GEYJ 101 V (100)	T	138/154.9
R105	7030003320	S.RES ERJ3GEYJ 101 V (100)	T	140.9/155.7
R106	7030003320	S.RES ERJ3GEYJ 101 V (100)	T	138/148.5
R107	7030003320	S.RES ERJ3GEYJ 101 V (100)	T	140.9/147.7
R108	7030003320	S.RES ERJ3GEYJ 101 V (100)	T	140.9/149.3
R117	7030003320	S.RES ERJ3GEYJ 101 V (100)	T	138/150.1
R118	7030003320	S.RES ERJ3GEYJ 101 V (100)	T	140.9/150.9
R119	7030003320	S.RES ERJ3GEYJ 101 V (100)	T	138/151.7
R120	7030003320	S.RES ERJ3GEYJ 101 V (100)	T	140.9/152.5
R121	7030003320	S.RES ERJ3GEYJ 101 V (100)	T	154.7/160.6
R122	7030003320	S.RES ERJ3GEYJ 101 V (100)	T	153.4/160.6
R123	7030003320	S.RES ERJ3GEYJ 101 V (100)	T	152.1/160.6
R133	7030003560	S.RES ERJ3GEYJ 103 V (10 k)	T	151.2/145.8
R134	7030003320	S.RES ERJ3GEYJ 101 V (100)	T	152.5/145.8
R135	7030003320	S.RES ERJ3GEYJ 101 V (100)	T	153.8/145.8
R260	7030003320	S.RES ERJ3GEYJ 101 V (100)	T	63.2/204.1
R261	7030003440	S.RES ERJ3GEYJ 102 V (1 k)	T	63.8/166.5
R262	7030003440	S.RES ERJ3GEYJ 102 V (1 k)	T	65.8/222
R263	7030003680	S.RES ERJ3GEYJ 104 V (100 k)	T	63.2/206.9
R264	7030003480	S.RES ERJ3GEYJ 222 V (2.2 k)	T	70/222.6
R320	7030008180	S.RES ERJ12YJ331U (330)	T	64.2/162.8
R321	7030003320	S.RES ERJ3GEYJ 101 V (100)	B	63.2/204.9
R322	7030008180	S.RES ERJ12YJ331U (330)	T	58.3/222
R323	7030003680	S.RES ERJ3GEYJ 104 V (100 k)	B	63.2/208.1
R351	7030003340	S.RES ERJ3GEYJ 151 V (150)	B	73.8/233.5
R352	7030003300	S.RES ERJ3GEYJ 680 V (68)	B	76.9/233.5
R354	7030003280	S.RES ERJ3GEYJ 470 V (47)	B	66.7/227.1
R355	7030003320	S.RES ERJ3GEYJ 101 V (100)	B	69.8/227.1
R381	7030003520	S.RES ERJ3GEYJ 472 V (4.7 k)	B	108.2/227.9
R382	7030003360	S.RES ERJ3GEYJ 221 V (220)	B	75.3/240.7
R383	7030003680	S.RES ERJ3GEYJ 104 V (100 k)	B	106.6/227.9
R384	7030003420	S.RES ERJ3GEYJ 681 V (680)	B	99.9/228.7
R385	7030003420	S.RES ERJ3GEYJ 681 V (680)	B	99/232.1
R386	7030003480	S.RES ERJ3GEYJ 222 V (2.2 k)	B	99.9/225.1
R387	7030003560	S.RES ERJ3GEYJ 103 V (10 k)	B	98.4/236.2
R388	7540000130	ABS 2P-50A-301		
R389	7030003420	S.RES ERJ3GEYJ 681 V (680)	B	87.4/239.2
R390	7030003560	S.RES ERJ3GEYJ 103 V (10 k)	B	101.4/237.8
R391	7030003680	S.RES ERJ3GEYJ 104 V (100 k)	B	101.5/236.2
R392	7030003420	S.RES ERJ3GEYJ 681 V (680)	B	99.9/227.1
R393	7030003420	S.RES ERJ3GEYJ 681 V (680)	B	99/230.5
R394	7030003420	S.RES ERJ3GEYJ 681 V (680)	B	87.4/240.8
R395	7030003420	S.RES ERJ3GEYJ 681 V (680)	B	98.4/239.4
R396	7030003420	S.RES ERJ3GEYJ 681 V (680)	B	98.4/237.8
R401	7030003360	S.RES ERJ3GEYJ 221 V (220)	B	55.3/230.7
R402	7030003680	S.RES ERJ3GEYJ 104 V (100 k)	B	50.9/231.7
R403	7030003480	S.RES ERJ3GEYJ 222 V (2.2 k)	B	48.3/236.5
R404	7030003860	S.RES ERJ3GE JPW V	B	48.3/233.7
R405	7540000130	ABS 2P-50A-301		
R421	7030003440	S.RES ERJ3GEYJ 102 V (1 k)	B	87.9/139.5
R422	7030003440	S.RES ERJ3GEYJ 102 V (1 k)	B	93.1/139.5
R423	7030003440	S.RES ERJ3GEYJ 102 V (1 k)	B	86.1/139.5
R424	7030003440	S.RES ERJ3GEYJ 102 V (1 k)	B	94.9/139.5
R425	7030003410	S.RES ERJ3GEYJ 561 V (560)	B	95.6/145.7
R426	7030003410	S.RES ERJ3GEYJ 561 V (560)	B	92.2/135
R427	7030003320	S.RES ERJ3GEYJ 101 V (100)	B	89.7/142.6
R428	7030003400	S.RES ERJ3GEYJ 471 V (470)	B	89.7/139.5
R429	7030003400	S.RES ERJ3GEYJ 471 V (470)	B	91.3/139.5
R501	7030003440	S.RES ERJ3GEYJ 102 V (1 k)	T	162.7/36.4
R502	7030003560	S.RES ERJ3GEYJ 103 V (10 k)	T	162.7/35.1
R503	7030003440	S.RES ERJ3GEYJ 102 V (1 k)	T	162.7/39
R504	7030003440	S.RES ERJ3GEYJ 102 V (1 k)	T	162.7/42.9
R505	7030003320	S.RES ERJ3GEYJ 101 V (100)	T	162.7/45.5
R506	7030003320	S.RES ERJ3GEYJ 101 V (100)	T	150.5/37.7
R507	7030003440	S.RES ERJ3GEYJ 102 V (1 k)	T	150.5/39
R508	7030003440	S.RES ERJ3GEYJ 102 V (1 k)	T	150.5/42.9
R509	7030003320	S.RES ERJ3GEYJ 101 V (100)	T	150.5/45.5
R510	7030003320	S.RES ERJ3GEYJ 101 V (100)	T	138.3/37.7
R511	7030003320	S.RES ERJ3GEYJ 101 V (100)	B	132.9/37.5
R513	7030003860	S.RES ERJ3GE JPW V	B	85.3/113.7
R514	7030003440	S.RES ERJ3GEYJ 102 V (1 k)	B	128.7/36.7
R515	7030003410	S.RES ERJ3GEYJ 561 V (560)	B	128.7/45.1
R516	7030003440	S.RES ERJ3GEYJ 102 V (1 k)	T	138.3/42.8
R517	7030009591	S.RES ERA3YED 472V (4.7 k)	T	138.3/41.5
R518	7030003400	S.RES ERJ3GEYJ 471 V (470)	T	126.6/44.5
R519	7030003560	S.RES ERJ3GEYJ 103 V (10 k)	T	126.6/43.2
R520	7030003630	S.RES ERJ3GEYJ 393 V (39 k)	B	124/38.4
R521	7030003600	S.RES ERJ3GEYJ 223 V (22 k)	B	125.6/38.4
R523	7030003360	S.RES ERJ3GEYJ 221 V (220)	T	123.7/39.3
R524	7030003560	S.RES ERJ3GEYJ 103 V (10 k)	T	117.8/39.5
R525	7030003480	S.RES ERJ3GEYJ 222 V (2.2 k)	T	118/43.2
R526	7030003440	S.RES ERJ3GEYJ 102 V (1 k)	T	118.1/35.8
R527	7030003560	S.RES ERJ3GEYJ 103 V (10 k)	T	116/36.6
R528	7030003560	S.RES ERJ3GEYJ 103 V (10 k)	B	106.3/44.5
R529	7030003560	S.RES ERJ3GEYJ 103 V (10 k)	B	114.3/44.5
R530	7030003560	S.RES ERJ3GEYJ 103 V (10 k)	B	107.9/52.2
R531	7030003560	S.RES ERJ3GEYJ 103 V (10 k)	B	115.9/52.2
R532	7030003440	S.RES ERJ3GEYJ 102 V (1 k)	B	115.9/54.7
R533	7030003560	S.RES ERJ3GEYJ 103 V (10 k)	B	114.3/55.7
R534	7030003560	S.RES ERJ3GEYJ 103 V (10 k)	T	118.9/55.7
R535	7030003480	S.RES ERJ3GEYJ 222 V (2.2 k)	B	103.8/58

[RF UNIT]

REF NO.	ORDER NO.	DESCRIPTION	M.	H/V LOCATION
R536	7030003490	S.RES ERJ3GEYJ 272 V (2.7 k)	B	107/58.4
R537	7030003320	S.RES ERJ3GEYJ 101 V (100)	T	115.8/59.4
R538	7310005400	S.TRI EVM-3VXS0 BE4 (223)	T	108.6/55.5
R539	7030003380	S.RES ERJ3GEYJ 331 V (330)	B	113/59
R540	7030003220	S.RES ERJ3GEYJ 150 V (15)	B	94.7/65.9
R541	7030003380	S.RES ERJ3GEYJ 331 V (330)	B	92.3/65.2
R543	7030003380	S.RES ERJ3GEYJ 331 V (330)	B	97.1/65.2
R545	7030004030	S.RES ERJ3GEYJ 5R6 V (5.6)	B	100.9/64.5
R546	7030003430	S.RES ERJ3GEYJ 821 V (820)	B	100.9/61.2
R547	7030003430	S.RES ERJ3GEYJ 821 V (820)	B	98.7/60.6
R548	7030004030	S.RES ERJ3GEYJ 5R6 V (5.6)	B	101/77.3
R550	7030003860	S.RES ERJ3GE JPW V	B	108.3/70.3
R552	7030004040	S.RES ERJ3GEYJ 4R7 V (4.7)	B	113.8/99
R553	7030003560	S.RES ERJ3GEYJ 103 V (10 k)	B	112.8/105.5
R554	7030003440	S.RES ERJ3GEYJ 102 V (1 k)	B	108.1/104
R556	7030003400	S.RES ERJ3GEYJ 471 V (470)	B	109.8/96.1
R558	7030003320	S.RES ERJ3GEYJ 101 V (100)	B	105.8/92.1
R562	7030003320	S.RES ERJ3GEYJ 101 V (100)	T	102.9/125.6
R563	7030003300	S.RES ERJ3GEYJ 680 V (68)	B	94.7/120.8
R564	7030003620	S.RES ERJ3GEYJ 333 V (33 k)	B	92.3/116.9
R566	7030003330	S.RES ERJ3GEYJ 121 V (120)	B	97.3/120
R567	7030003230	S.RES ERJ3GEYJ 180 V (180)	B	98.8/110.7
R568	7030009851	S.RES ERA3YED 271V (270)	B	98.1/108.2
R569	7030009851	S.RES ERA3YED 271V (270)	B	99.7/108.2
R570	7030003520	S.RES ERJ3GEYJ 472 V (4.7 k)	B	118.4/125.7
R571	7030003560	S.RES ERJ3GEYJ 103 V (10 k)	B	115.3/124.1
R572	7030004040	S.RES ERJ3GEYJ 4R7 V (4.7)	B	121.7/115.8
R573	7030003400	S.RES ERJ3GEYJ 471 V (470)	B	115.3/114.2
R574	7030003280	S.RES ERJ3GEYJ 470 V (470)	B	118.4/114.2
R575	7030009851	S.RES ERA3YED 271V (270)	T	119.2/113
R576	7030003230	S.RES ERJ3GEYJ 180 V (18)	T	120.5/113
R577	7030009851	S.RES ERA3YED 271V (270)	T	119.7/110.9
R578	7030003230	S.RES ERJ3GEYJ 180 V (18)	T	117.9/124.7
R579	7030009851	S.RES ERA3YED 271V (270)	T	118.6/126.6
R580	7030009851	S.RES ERA3YED 271V (270)	T	119.9/126.6
R581	7030003430	S.RES ERJ3GEYJ 821 V (820)	B	92/97.8
R582	7030004030	S.RES ERJ3GEYJ 5R6 V (5.6)	B	96.2/100.1
R583	7030003430	S.RES ERJ3GEYJ 821 V (820)	B	93.9/99.4
R585	7030003600	S.RES ERJ3GEYJ 223 V (22 k)	T	126.6/41.9
R587	7030003200	S.RES ERJ3GEYJ 100 V (10)	B	120.9/123
R589	7030003400	S.RES ERJ3GEYJ 471 V (470)	B	118.4/124.1
R590	7030003430	S.RES ERJ3GEYJ 821 V (820)	B	98.6/78.1
R591	7030003430	S.RES ERJ3GEYJ 821 V (820)	B	103.4/78.1
R592	7030000300	S.RES MCR10EZHJ 220 (221)	B	126.6/124.3
R601	7030000260	S.RES MCR10EZHJ 100 (101)	B	134.6/68.2
R602	7030000260	S.RES MCR10EZHJ 100 (101)	B	134.6/79
R603	7030000260	S.RES MCR10EZHJ 100 (101)	B	134.6/89.8
R604	7030000260	S.RES MCR10EZHJ 100 (101)	B	134.6/100.7
R605	7030000260	S.RES MCR10EZHJ 100 (101)	B	134.6/111.5
R606	7030000260	S.RES MCR10EZHJ 100 (101)	T	134.6/60
R607	7030000260	S.RES MCR10EZHJ 100 (101)	T	134.6/69
R608	7030000260	S.RES MCR10EZHJ 100 (101)	T	134.6/78
R609	7030000260	S.RES MCR10EZHJ 100 (101)	T	134.6/87
R610	7030003400	S.RES ERJ3GEYJ 471 V (470)	T	124.1/105.3
R611	7030000260	S.RES MCR10EZHJ 100 (101)	T	134.6/97
R612	7030009851	S.RES ERA3YED 271V (270)	T	124/69.5
R613	7030003230	S.RES ERJ3GEYJ 180 V (18)	T	124.7/71.7
R614	7030009851	S.RES ERA3YED 271V (270)	T	125.3/69.5
R801	7030003380	S.RES ERJ3GEYJ 331 V (330)	T	152.4/62.9
R802	7030003340	S.RES ERJ3GEYJ 151 V (150)	B	155.2/61.4
R803	7030003440	S.RES ERJ3GEYJ 102 V (1 k)	B	159.4/76.1
R804	7030003490	S.RES ERJ3GEYJ 272 V (2.7 k)	B	157/75.3
R805	7030003280	S.RES ERJ3GEYJ 470 V (47 k)	B	154.1/84.4
R806	7030003300	S.RES ERJ3GEYJ 680 V (68)	B	154.1/84.4
R806	7030003320	S.RES ERJ3GEYJ 101 V (100)	B	156.5/83.4
R806	7030003330	S.RES ERJ3GEYJ 121 V (120)	B	156.5/83.4
R807	7030003320	S.RES ERJ3GEYJ 101 V (100)	B	156.5/85.2
R807	7030003330	S.RES ERJ3GEYJ 121 V (120)	B	156.5/85.2
R808	7030003640	S.RES ERJ3GEYJ 473 V (4.7 k)	B	162.8/96.7
R809	7030003460	S.RES ERJ3GEYJ 152 V (15 k)	B	164.4/96.7
R810	7030003680	S.RES ERJ3GEYJ 104 V (100 k)	T	156.5/59.4
R811	7030003560	S.RES ERJ3GEYJ 103 V (10 k)	T	159.5/56.6
R812	7030009851	S.RES ERA3YED 271V (270)	T	151.1/59.4
R813	7030003230	S.RES ERJ3GEYJ 180 V (18)	T	152.4/59.4
R814	7030009851	S.RES ERA3YED 271V (270)	T	153.7/59.4
R815	7030003320			

[RF UNIT]

REF NO.	ORDER NO.	DESCRIPTION	M.	H/V LOCATION
R1019	7030003560	S.RES ERJ3GEYJ 103 V (10 k)	T	15.4/133.9
R1023	7030010980	S.RES ERA3YHD 470V (47)	B	32.6/137.7
R1024	7030003200	S.RES ERJ3GEYJ 100 V (10)	T	27.3/142.6
R1027	7030003200	S.RES ERJ3GEYJ 100 V (10)	B	38.9/133.8
R1028	7030003200	S.RES ERJ3GEYJ 100 V (10)	B	38.9/119.9
R1029	7030010980	S.RES ERA3YHD 470V (47)	B	28.9/133.8
R1030	7030010980	S.RES ERA3YHD 470V (47)	B	28.9/120
R1051	7030003800	S.RES ERJ3GEYJ 105 V (1 M)	B	3.1/103.2
R1054	7030011500	S.RES ERA3YHD 270V (27)	T	48.9/88.3
R1055	7030000010	S.RES MCR10EZHZ JPW (000)	T	7.3/128
R1056	7030000010	S.RES MCR10EZHZ JPW (000)	T	6.5/144
R1071	7030010980	S.RES ERA3YHD 470V (47)	T	3.6/132.5
R1072	7030000010	S.RES MCR10EZHZ JPW (000)	T	3.6/45.2
R1073	7030000010	S.RES MCR10EZHZ JPW (000)	T	5.4/45.2
R1074	7030000010	S.RES MCR10EZHZ JPW (000)	B	1.9/45.3
R1075	7030000010	S.RES MCR10EZHZ JPW (000)	B	4.3/45.3
R1101	7310004860	S.TRI EVM-3YSX50 B53 (502)	T	3.9/109.9
R1102	7030005871	S.RES ERA3YKD 104V (100 k)	B	3.8/99.5
R1103	7030007680	S.RES ERJ8ENF 47R0V (47)	T	2.3/95.4
R1104	7030007680	S.RES ERJ8ENF 47R0V (47)	T	10.4/92.9
R1105	7030003500	S.RES ERJ3GEYJ 332 V (3.3 k)	T	7.3/112.4
R1106	7030009620	S.RES ERJ12YJ120U (12)	B	4.4/82.2
R1107	7030010980	S.RES ERA3YHD 470V (47)	T	8.4/79.8
R1109	7030007180	S.RES ERJ12YJ150U (15)	B	7.4/74.4
R1110	7030003480	S.RES ERJ3GEYJ 222 V (2.2 k)	B	15.5/68.5
R1111	7030003480	S.RES ERJ3GEYJ 222 V (2.2 k)	T	17.8/69.7
R1113	7030003480	S.RES ERJ3GEYJ 222 V (2.2 k)	T	17.8/68.4
R1114	7030004040	S.RES ERJ3GEYJ 4R7 V (4.7)	T	4.7/74.8
R1115	7030006240	S.RES ERJ12YJ181U (180)	B	7.4/70.2
R1116	7030007230	S.RES ERA3YED 102V (1 k)	T	8.3/64.8
R1117	7030004040	S.RES ERJ3GEYJ 4R7 V (4.7)	T	8.3/66.1
R1118	7030003480	S.RES ERJ3GEYJ 222 V (2.2 k)	T	8.6/68.1
R1119	7030003470	S.RES ERJ3GEYJ 182 V (1.8 k)	T	6/68.1
R1120	7030006070	S.RES ERJ12YJ101U (100)	B	6.6/59.1
R1121	7030003240	S.RES ERJ3GEYJ 220 V (22)	T	5.4/60.5
R1122	7030010980	S.RES ERA3YHD 470V (47)	T	12/69
R1123	7030003480	S.RES ERJ3GEYJ 222 V (2.2 k)	T	18.3/62.7
R1124	7030003460	S.RES ERJ3GEYJ 152 V (1.5 k)	T	18.3/60.1
R1125	7030003420	S.RES ERJ3GEYJ 681 V (680)	B	13/57.2
R1126	7030003200	S.RES ERJ3GEYJ 100 V (10)	T	15.6/57.9
R1127	7030010980	S.RES ERA3YHD 470V (47)	T	9.4/57.2
R1128	7030003470	S.RES ERJ3GEYJ 182 V (1.8 k)	T	10.6/52.1
R1129	7030003470	S.RES ERJ3GEYJ 182 V (1.8 k)	T	26.6/52.1
R1130	7030003480	S.RES ERJ3GEYJ 222 V (2.2 k)	T	16.5/1.8
R1131	7030003640	S.RES ERJ3GEYJ 473 V (47 k)	B	6.6/109.4
R1132	7310004860	S.TRI EVM-3YSX50 B53 (502)	T	4.6/115.8
R1133	7030003500	S.RES ERJ3GEYJ 332 V (3.3 k)	T	8.5/117.6
R1134	7030003640	S.RES ERJ3GEYJ 473 V (47 k)	T	8.5/116.3
R1135	7030005871	S.RES ERA3YKD 104V (100 k)	T	1.8/102.3
R1151	7030010980	S.RES ERA3YHD 470V (47)	T	55/74.2
R1152	7030010980	S.RES ERA3YHD 470V (47)	B	48.3/65
R1203	7030000010	S.RES MCR10EZHZ JPW (000)	T	41.6/103
R1208	7030003480	S.RES ERJ3GEYJ 222 V (2.2 k)	T	49.4/91
R1209	7030003560	S.RES ERJ3GEYJ 103 V (10 k)	T	52.8/91.7
R1210	7030003650	S.RES ERJ3GEYJ 563 V (56 k)	T	54.1/91.7
R1211	7030003860	S.RES ERJ3GE JPW V	T	58.8/124.7
R1212	7030003860	S.RES ERJ3GE JPW V	B	64.1/97.4
R1213	7030003200	S.RES ERJ3GEYJ 100 V (10)	B	57.1/111.7
R1214	7030003200	S.RES ERJ3GEYJ 100 V (10)	B	71.1/111.7
R1216	7030003280	S.RES ERJ3GEYJ 470 V (47)	B	55.3/109.5
R1217	7030003280	S.RES ERJ3GEYJ 470 V (47)	B	69.3/109.5
R1220	7030003280	S.RES ERJ3GEYJ 470 V (47)	B	57.8/119.1
R1221	7030003440	S.RES ERJ3GEYJ 102 V (1 k)	B	51.7/106
R1222	7030003530	S.RES ERJ3GEYJ 562 V (5.6 k)	B	54.9/104.5
R1223	7030003280	S.RES ERJ3GEYJ 470 V (47)	B	70.5/119.1
R1224	7030003440	S.RES ERJ3GEYJ 102 V (1 k)	B	65.7/106
R1225	7030003530	S.RES ERJ3GEYJ 562 V (5.6 k)	B	68.9/104.5
R1226	7030003410	S.RES ERJ3GEYJ 561 V (560)	T	28.5/94.3
R1227	7030003410	S.RES ERJ3GEYJ 561 V (560)	T	33.5/94.3
R1228	7310004860	S.TRI EVM-3YSX50 B53 (502)	T	31/94.3
R1229	7030003480	S.RES ERJ3GEYJ 222 V (2.2 k)	B	31.3/69.5
R1230	7030003480	S.RES ERJ3GEYJ 222 V (2.2 k)	B	31.3/67.7
R1231	7030003480	S.RES ERJ3GEYJ 222 V (2.2 k)	B	31.3/65.9
R1232	7030003600	S.RES ERJ3GEYJ 223 V (22 k)	T	31/89.5
R1233	7030010980	S.RES ERA3YHD 470V (47)	B	34.9/77.8
R1301	7030010980	S.RES ERA3YHD 470V (47)	B	31/89.5
R1302	7030003860	S.RES ERJ3GE JPW V	T	28.8/69.3
R1304	7030003620	S.RES ERJ3GEYJ 333 V (33 k)	T	31/62.9
R1306	7030006230	S.RES ERJ12YJ151U (150)	B	33.4/61.9
R1307	7030003300	S.RES ERJ3GEYJ 680 V (68)	T	32.1/57.3
R1314	7030000010	S.RES MCR10EZHZ JPW (000)	T	38.5/74
R1315	7030000010	S.RES MCR10EZHZ JPW (000)	T	45.1/89
R1316	7030000010	S.RES MCR10EZHZ JPW (000)	T	43/92
R1357	7030007230	S.RES ERA3YED 102V (1 k)	B	66/77.8
R1358	7030003530	S.RES ERJ3GEYJ 562 V (5.6 k)	B	66.7/75.4
R1359	7030010980	S.RES ERA3YHD 470V (47)	B	57.4/77.8
R1360	7030007230	S.RES ERA3YED 102V (1 k)	T	64.5/73.8
R1401	7030003200	S.RES ERJ3GEYJ 100 V (10)	B	59.6/10.9
R1402	7030003300	S.RES ERJ3GEYJ 680 V (68)	T	62.8/15
R1403	7030007230	S.RES ERA3YED 102V (1 k)	B	62.2/13.4
R1404	7030009861	S.RES ERA3YED 471V (470)	B	62.2/16.5
R1405	7030003340	S.RES ERJ3GEYJ 151 V (150)	B	62.2/19.6
R1406	7030009591	S.RES ERA3YED 472V (4.7 k)	B	58.1/18.4
R1407	7030003550	S.RES ERJ3GEYJ 822 V (8.2 k)	B	54.1/19.9
R1408	7030003200	S.RES ERJ3GEYJ 100 V (10)	T	64.1/15
R1409	7030009591	S.RES ERA3YED 472V (4.7 k)	T	69.3/15
R1410	7030006091	S.RES ERA3YED 822V (8.2 k)	B	68/13.6
R1411	7030005871	S.RES ERA3YKD 104V (100 k)	T	66.7/12.4
R1412	7030003200	S.RES ERJ3GEYJ 100 V (10)	T	67.3/17.1
R1413	7030003200	S.RES ERJ3GEYJ 100 V (10)	T	64.7/8.1
R1414	7030005871	S.RES ERA3YKD 104V (100 k)	B	69.6/13.6
R1415	7030010980	S.RES ERA3YHD 470V (47)	T	65.4/4.9
R1416	7030003320	S.RES ERJ3GEYJ 101 V (100)	B	70.7/5.4
R1419	7030003860	S.RES ERJ3GE JPW V	B	80.2/15

[RF UNIT]

REF NO.	ORDER NO.	DESCRIPTION	M.	H/V LOCATION
R1501	7030010980	S.RES ERA3YHD 470V (47)	T	88.7/10
R1502	7030009841	S.RES ERA3YHD 330V (33)	T	104/5.1
R1503	7030009851	S.RES ERA3YED 271V (270)	T	113.1/5.4
R1504	7030011050	S.RES ERA3YHD 100V (10)	T	110/6.7
R1505	7030006091	S.RES ERA3YED 822V (8.2 k)	B	106.5/23.5
R1506	7030007230	S.RES ERA3YED 102V (1 k)	T	113/12.7
R1507	7030007230	S.RES ERA3YED 102V (1 k)	T	113.1/8
R1508	7030007230	S.RES ERA3YED 102V (1 k)	T	113.1/9.3
R1509	7030007230	S.RES ERA3YED 102V (1 k)	T	118/3.8
R1510	7030005321	S.RES ERA3YED 103V (10 k)	T	124.4/3.8
R1511	7030007230	S.RES ERA3YED 102V (1 k)	T	125/6.2
R1512	7030003380	S.RES ERJ3GEYJ 331 V (330)	T	116.9/15.8
R1513	7030003380	S.RES ERJ3GEYJ 331 V (330)	T	125.2/15.8
R1514	7030005321	S.RES ERA3YED 103V (10 k)	T	129/15.8
R1515	7030005321	S.RES ERA3YED 103V (10 k)	T	129/11.9
R1516	7310005380	S.TRI EVM-3VSX50 B13 (102)	T	125.3/26
R1517	7030005321	S.RES ERA3YED 103V (10 k)	T	124.3/29.6
R1518	7030005321	S.RES ERA3YED 103V (10 k)	T	129/10.6
R1519	7030005321	S.RES ERA3YED 103V (10 k)	T	141/13.7
R1520	7030005321	S.RES ERA3YED 103V (10 k)	T	129/9.3
R1521	7030010980	S.RES ERA3YHD 470V (47)	T	96.5/9.9
R1522	7030009841	S.RES ERA3YHD 330V (33)	T	103.9/17.3
R1523	7030009851	S.RES ERA3YED 271V (270)	T	113.1/17.6
R1524	7030011050	S.RES ERA3YHD 100V (10)	T	110/18.9
R1525	7030007230	S.RES ERJ3GEYJ 152 V (1.5 k)	T	113/24.9
R1526	7030003460	S.RES ERJ3GEYJ 152 V (1.5 k)	B	106.5/21.5
R1527	7030007230	S.RES ERA3YED 102V (1 k)	T	113.1/21.5
R1528	7030007230	S.RES ERA3YED 102V (1 k)	T	113.1/20.2
R1529	7030007230	S.RES ERA3YED 102V (1 k)	T	117.9/29.6
R1530	7030003380	S.RES ERJ3GEYJ 331 V (330)	T	116.9/17.6
R1531	7030003380	S.RES ERJ3GEYJ 331 V (330)	T	125.2/17.6
R1532	7030005321	S.RES ERA3YED 103V (10 k)	T	129/21.5
R1533	7030005321	S.RES ERA3YED 103V (10 k)	T	129/17.6
R1534	7030005321	S.RES ERA3YED 103V (10 k)	T	129/22.8
R1535	7030005321	S.RES ERA3YED 103V (10 k)	T	129/24.1
R1536	7030005321	S.RES ERA3YED 103V (10 k)	T	141/16.5
R1537	7030003320	S.RES ERJ3GEYJ 101 V (100)	B	133.9/22.7
R1538	7030003320	S.RES ERJ3GEYJ 101 V (100)	B	139.1/22.7
R1539	7030008601	S.RES ERA3YED 222V (2.2 k)	T	146/14.5
R1540	7030010390	S.RES ERA3YED 821V (820)	T	144.2/19.5
R1541	7030003320	S.RES ERJ3GEYJ 101 V (100)	T	151.5/12.8
R1542	7030003320	S.RES ERJ3GEYJ 101 V (100)	B	145.5/22.7
R1543	7030009691	S.RES ERA3YED 101V (100)	T	151.5/19.5
R1544	7030007230	S.RES ERA3YED 102V (1 k)	T	126.3/6.2
R1651	7030003380	S.RES ERJ3GEYJ 331 V (330)	B	91.5/36.8
R1652	7030003220	S.RES ERJ3GEYJ 150 V (15)	B	92.4/34.4
R1653	7030003380	S.RES ERJ3GEYJ 331 V (330)	B	93.1/36.8
R1654	7030003280	S.RES ERJ3GEYJ 470 V (47)	B	95.6/38.3
R1655	7030003400	S.RES ERJ3GEYJ 471 V (470)	B	100.5/36.8
R1656	7030003630	S.RES ERJ3GEYJ 393 V (39 k)	B	95.7/34.3
R1657	7030003680	S.RES ERJ3GEYJ 104 V (100 k)	T	96.6/28.5
R1658	7030003320	S.RES ERJ3GEYJ 101 V (100)	T	96.6/25.9
R1659	7030009691	S.RES ERA3YED 101V (100)	T	87.8/20.6
R1660	7030009691	S.RES ERA3YED 101V (100)	T	92.2/20.6
R1661	7030003560	S.RES ERJ3GEYJ 103 V (10 k)	T	148.8/13.2
R1662	7030003560	S.RES ERJ3GEYJ 103 V (10 k)	T	143.3/13.2
R1663	7030003560	S.RES ERJ3GEYJ 103 V (10 k)	T	147.5/4.2
R1664	7030003560	S.RES ERJ3GEYJ 103 V (10 k)	B	146.9/8.7
R1665	7030003320	S.RES ERJ3GEYJ 101 V (100)	T	96.6/27.2
R1667	7030003360	S.RES ERJ3GEYJ 221 V (220)	B	149.3/9.5
R1668	7030003360	S.RES ERJ3GEYJ 221 V (220)	B	149.3/7.9
R1670	7030003800	S.RES ERJ3GEYJ 105 V (1 M)	B	152.3/10.3
R1673	7030003440	S.RES ERJ3GEYJ 102 V (1 k)	B	159.7/11.4
R1674	7030009851	S.RES ERA3YED 271V (270)	B	159.7/14.5
R1675	7030009591	S.RES ERA3YED 472V (4.7 k)	T	143.3/9.3
R1677	7030009591	S.RES ERA3YED 472V (4.7 k)	T	144.7/4.2
R1702	7030003320	S.RES ERJ3GEYJ 101 V (100)	B	108.7/138.6
R1703	7030003320	S.RES ERJ3GEYJ 101 V (100)	B	108.7/140.2
R1704	7030003320	S.RES ERJ3GEYJ 101 V (100)	B	108.7/141.8
R1705	7030003320	S.RES ERJ3GEYJ 101 V (100)	B	108.7/143.4
R1706	7030003320	S.RES ERJ3GEYJ 101 V (100)	T	108.7/145
R1707	7030003320	S.RES ERJ3GEYJ 101 V (100)	B	108.7/145
R1709	7030003480	S.RES ERJ3GEYJ 222 V (2.2 k)	T	121.9/130.2
R1710	7030003480	S.RES ERJ3GEYJ 222 V (2.2 k)	T	121.9/131.5
R1711	7030003540	S.RES ERJ3GEYJ 682 V (6.8 k)	T	121.9/

[RF UNIT]

REF NO.	ORDER NO.	DESCRIPTION	M.	H/V LOCATION
R1923	7030003560	S.RES ERJ3GEYJ 103 V (10 k)	B	140.9/115
R1924	7030003560	S.RES ERJ3GEYJ 103 V (10 k)	B	154.2/115
R1925	7030003560	S.RES ERJ3GEYJ 103 V (10 k)	B	142.5/115
R1926	7030003560	S.RES ERJ3GEYJ 103 V (10 k)	B	155.8/115
R1927	7030003560	S.RES ERJ3GEYJ 103 V (10 k)	B	144.1/115
R1928	7030003560	S.RES ERJ3GEYJ 103 V (10 k)	B	157.4/115
R1929	7030003560	S.RES ERJ3GEYJ 103 V (10 k)	B	145.7/115
R1930	7030003560	S.RES ERJ3GEYJ 103 V (10 k)	B	159/115
R1932	7030003560	S.RES ERJ3GEYJ 103 V (10 k)	B	160.6/115
R2001	7030003480	S.RES ERJ3GEYJ 222 V (2.2 k)	B	166.5/237.4
R2002	7030003520	S.RES ERJ3GEYJ 472 V (4.7 k)	B	155.8/231.4
R2003	7030003480	S.RES ERJ3GEYJ 222 V (2.2 k)	B	164.9/237.4
R2004	7030003620	S.RES ERJ3GEYJ 333 V (33 k)	B	156.6/233.8
R2005	7030003580	S.RES ERJ3GEYJ 153 V (15 k)	B	158.2/233.8
R2006	7030003520	S.RES ERJ3GEYJ 472 V (4.7 k)	B	158.9/231.4
R2007	7030003860	S.RES ERJ3GE JPW V	T	161.9/162.7
R2008	7030003860	S.RES ERJ3GE JPW V	T	161.9/162.7
R2009	7030003860	S.RES ERJ3GE JPW V	T	161.9/166.6
R2010	7030003860	S.RES ERJ3GE JPW V	T	161.9/165.3
R2011	7030003860	S.RES ERJ3GE JPW V	T	161.9/164
R2012	7030003860	S.RES ERJ3GE JPW V	T	161.9/162.7
C1	4030006880	S.CER C1608 JB 1H 472K-T	B	146.9/161.6
C2	4030006880	S.CER C1608 JB 1H 472K-T	B	146.1/159.2
C3	4030006880	S.CER C1608 JB 1H 472K-T	B	147.7/159.2
C4	4030006880	S.CER C1608 JB 1H 472K-T	B	147/222
C5	4030006880	S.CER C1608 JB 1H 472K-T	B	150/218.8
C6	4030006880	S.CER C1608 JB 1H 472K-T	B	147/220.4
C7	4030018620	S.CER C1608 CH 1H 222J-T	T	148.6/181.5
C8	4030018590	S.CER C1608 CH 1H 122J-T	T	148.6/192.3
C9	4030018590	S.CER C1608 CH 1H 122J-T	T	148.6/193.6
C10	4030018620	S.CER C1608 CH 1H 222J-T	T	148.6/203.1
C11	4030018600	S.CER C1608 CH 1H 152J-T	T	148.6/191
C21	4030006880	S.CER C1608 JB 1H 472K-T	B	131.4/161.6
C22	4030006880	S.CER C1608 JB 1H 472K-T	B	130.6/159.2
C23	4030006880	S.CER C1608 JB 1H 472K-T	B	132.2/159.2
C24	4030006880	S.CER C1608 JB 1H 472K-T	B	131.5/222
C25	4030006880	S.CER C1608 JB 1H 472K-T	B	134.5/218.8
C26	4030006880	S.CER C1608 JB 1H 472K-T	B	131.5/220.4
C27	4030017810	S.CER C1608 CH 1H 102J-T	B	139.2/170.3
C28	4030017810	S.CER C1608 CH 1H 102J-T	B	139.2/171.9
C29	4030010760	S.CER C1608 CH 1H 331J-T	B	138.6/185.4
C30	4030007140	S.CER C1608 CH 1H 121J-T	B	140.2/185.4
C31	4030007160	S.CER C1608 CH 1H 181J-T	B	130.9/185.4
C32	4030007060	S.CER C1608 CH 1H 270J-T	B	129.3/185.4
C33	4030010760	S.CER C1608 CH 1H 331J-T	B	134.1/190.1
C34	4030007090	S.CER C1608 CH 1H 470J-T	B	132.5/190.1
C35	4030007160	S.CER C1608 CH 1H 181J-T	B	130.9/190.1
C36	4030007060	S.CER C1608 CH 1H 270J-T	B	129.3/190.1
C37	4030010760	S.CER C1608 CH 1H 331J-T	B	138.6/195
C38	4030007140	S.CER C1608 CH 1H 121J-T	B	140.2/195
C39	4030017810	S.CER C1608 CH 1H 102J-T	B	139.2/209.9
C40	4030017810	S.CER C1608 CH 1H 102J-T	B	139.2/208.3
C51	4030006880	S.CER C1608 JB 1H 472K-T	B	115.9/161.6
C52	4030006880	S.CER C1608 JB 1H 472K-T	B	115.1/159.2
C53	4030006880	S.CER C1608 JB 1H 472K-T	B	116.7/159.2
C54	4030006880	S.CER C1608 JB 1H 472K-T	B	116/222
C55	4030006880	S.CER C1608 JB 1H 472K-T	B	119.2/18.8
C56	4030006880	S.CER C1608 JB 1H 472K-T	B	116/220.4
C57	4030017800	S.CER C1608 CH 1H 561J-T	B	123.7/170.3
C58	4030010760	S.CER C1608 CH 1H 331J-T	B	123.7/171.9
C59	4030010760	S.CER C1608 CH 1H 331J-T	B	123.1/185.4
C60	4030007080	S.CER C1608 CH 1H 390J-T	B	124.7/185.4
C61	4030007100	S.CER C1608 CH 1H 560J-T	B	115.4/185.4
C62	4030010760	S.CER C1608 CH 1H 331J-T	B	113.8/185.4
C63	4030010760	S.CER C1608 CH 1H 331J-T	B	118.6/190.1
C64	4030007090	S.CER C1608 CH 1H 470J-T	B	117/190.1
C65	4030010760	S.CER C1608 CH 1H 331J-T	B	115.4/190.1
C66	4030007100	S.CER C1608 CH 1H 560J-T	B	113.8/190.1
C67	4030010760	S.CER C1608 CH 1H 331J-T	B	123.1/195
C68	4030007080	S.CER C1608 CH 1H 390J-T	B	124.7/195
C69	4030017800	S.CER C1608 CH 1H 561J-T	B	123.7/209.9
C70	4030010760	S.CER C1608 CH 1H 331J-T	B	123.7/208.3
C81	4030006880	S.CER C1608 JB 1H 472K-T	B	100.5/161.6
C82	4030006880	S.CER C1608 JB 1H 472K-T	B	99.7/159.2
C83	4030006880	S.CER C1608 JB 1H 472K-T	B	101.3/159.2
C84	4030006880	S.CER C1608 JB 1H 472K-T	B	100.6/222
C85	4030006880	S.CER C1608 JB 1H 472K-T	B	103.7/218.8
C86	4030006880	S.CER C1608 JB 1H 472K-T	B	100.6/220.4
C87	4030017800	S.CER C1608 CH 1H 561J-T	B	108.3/170.3
C88	4030011330	S.CER C1608 CH 1H 391J-T	B	108.3/171.9
C89	4030007160	S.CER C1608 CH 1H 181J-T	B	107.7/185.4
C90	4030007070	S.CER C1608 CH 1H 330J-T	B	109.3/185.4
C91	4030007030	S.CER C1608 CH 1H 150J-T	B	100/185.4
C92	4030007120	S.CER C1608 CH 1H 820J-T	B	98.4/185.4
C93	4030007140	S.CER C1608 CH 1H 121J-T	B	103.2/190.1
C94	4030007100	S.CER C1608 CH 1H 560J-T	B	101.6/190.1
C95	4030007120	S.CER C1608 CH 1H 820J-T	B	100/190.1
C96	4030007030	S.CER C1608 CH 1H 150J-T	B	98.4/190.1
C97	4030007160	S.CER C1608 CH 1H 181J-T	B	107.7/195
C98	4030007070	S.CER C1608 CH 1H 330J-T	B	109.3/195
C99	4030017800	S.CER C1608 CH 1H 561J-T	B	108.3/209.9
C100	4030011330	S.CER C1608 CH 1H 391J-T	B	108.3/208.3
C111	4030006880	S.CER C1608 JB 1H 472K-T	B	85/161.6
C112	4030006880	S.CER C1608 JB 1H 472K-T	B	84.2/159.2
C113	4030006880	S.CER C1608 JB 1H 472K-T	B	85.8/159.2
C114	4030006880	S.CER C1608 JB 1H 472K-T	B	85/222
C115	4030006880	S.CER C1608 JB 1H 472K-T	B	87.1/219.6
C116	4030006880	S.CER C1608 JB 1H 472K-T	B	85/220.4
C117	4030010760	S.CER C1608 CH 1H 331J-T	B	92.8/170.3
C118	4030007150	S.CER C1608 CH 1H 151J-T	B	92.8/171.9
C119	4030007150	S.CER C1608 CH 1H 151J-T	B	93.7/185.4
C120	4030007060	S.CER C1608 CH 1H 270J-T	B	92.1/185.4

[RF UNIT]

REF NO.	ORDER NO.	DESCRIPTION	M.	H/V LOCATION
C121	4030007060	S.CER C1608 CH 1H 270J-T	B	84.4/185.4
C122	4030007140	S.CER C1608 CH 1H 121J-T	B	82.8/185.4
C123	4030007150	S.CER C1608 CH 1H 151J-T	B	87.6/190.1
C124	4030007010	S.CER C1608 CH 1H 100D-T	B	86/190.1
C125	4030007140	S.CER C1608 CH 1H 121J-T	B	84.4/190.1
C126	4030007060	S.CER C1608 CH 1H 270J-T	B	82.8/190.1
C127	4030007150	S.CER C1608 CH 1H 151J-T	B	92.1/195
C128	4030007060	S.CER C1608 CH 1H 270J-T	B	93.7/195
C129	4030010760	S.CER C1608 CH 1H 331J-T	B	92.8/209.9
C130	4030007150	S.CER C1608 CH 1H 151J-T	B	92.8/208.3
C141	4030006880	S.CER C1608 JB 1H 472K-T	B	69.5/161.6
C142	4030006880	S.CER C1608 JB 1H 472K-T	B	68.7/159.2
C143	4030006880	S.CER C1608 JB 1H 472K-T	B	70.3/159.2
C144	4030006880	S.CER C1608 JB 1H 472K-T	B	66.4/220.4
C145	4030006880	S.CER C1608 JB 1H 472K-T	B	72.6/218.8
C146	4030006880	S.CER C1608 JB 1H 472K-T	B	69.5/220.4
C147	4030007170	S.CER C1608 CH 1H 221J-T	B	77.2/170.3
C148	4030007170	S.CER C1608 CH 1H 221J-T	B	77.2/171.9
C149	4030007130	S.CER C1608 CH 1H 101J-T	B	78.2/185.4
C150	4030007050	S.CER C1608 CH 1H 220J-T	B	76.8/185.4
C151	4030007070	S.CER C1608 CH 1H 330J-T	B	68.8/185.4
C152	4030007080	S.CER C1608 CH 1H 390J-T	B	67.2/185.4
C153	4030007120	S.CER C1608 CH 1H 820J-T	B	72.1/190.1
C154	4030007050	S.CER C1608 CH 1H 220J-T	B	70.5/190.1
C155	4030007080	S.CER C1608 CH 1H 390J-T	B	68.8/190.1
C156	4030007070	S.CER C1608 CH 1H 330J-T	B	67.2/190.1
C157	4030007130	S.CER C1608 CH 1H 101J-T	B	76.6/195
C158	4030007050	S.CER C1608 CH 1H 220J-T	B	78.2/195
C159	4030007170	S.CER C1608 CH 1H 221J-T	B	77.2/209.9
C160	4030007170	S.CER C1608 CH 1H 221J-T	B	77.2/208.3
C171	4030006880	S.CER C1608 JB 1H 472K-T	B	50/161.6
C172	4030006880	S.CER C1608 JB 1H 472K-T	B	49.2/159.2
C173	4030006880	S.CER C1608 JB 1H 472K-T	B	50.8/159.2
C174	4030006880	S.CER C1608 JB 1H 472K-T	B	50/222
C175	4030006880	S.CER C1608 JB 1H 472K-T	B	53.1/218.8
C176	4030006880	S.CER C1608 JB 1H 472K-T	B	50/220.4
C177	4030007110	S.CER C1608 CH 1H 221J-T	B	57.8/170.3
C178	4030007110	S.CER C1608 CH 1H 680J-T	B	57.8/171.9
C179	4030007090	S.CER C1608 CH 1H 470J-T	B	58.7/185.4
C180	4030007090	S.CER C1608 CH 1H 470J-T	B	57.1/185.4
C181	4030007070	S.CER C1608 CH 1H 330J-T	B	49.4/185.4
C182	4030007070	S.CER C1608 CH 1H 330J-T	B	47.8/185.4
C183	4030007120	S.CER C1608 CH 1H 820J-T	B	52.6/190.1
C185	4030007070	S.CER C1608 CH 1H 330J-T	B	49.4/190.1
C186	4030007070	S.CER C1608 CH 1H 330J-T	B	47.8/190.1
C187	4030007090	S.CER C1608 CH 1H 470J-T	B	57.1/195
C188	4030007090	S.CER C1608 CH 1H 470J-T	B	58.7/195
C189	4030007170	S.CER C1608 CH 1H 221J-T	B	57.7/209.9
C190	4030007110	S.CER C1608 CH 1H 680J-T	B	57.7/208.3
C201	4030006880	S.CER C1608 JB 1H 472K-T	B	34.5/161.6
C202	4030006880	S.CER C1608 JB 1H 472K-T	B	33.7/159.2
C203	4030006880	S.CER C1608 JB 1H 472K-T	B	35.3/159.2
C204	4030006880	S.CER C1608 JB 1H 472K-T	B	34.5/222
C205	4030006880	S.CER C1608 JB 1H 472K-T	B	36.8/219.6
C206	4030006880	S.CER C1608 JB 1H 472K-T	B	34.5/220.4
C207	4030007160	S.CER C1608 CH 1H 181J-T	B	42.3/170.3
C208	4030007090	S.CER C1608 CH 1H 470J-T	B	42.3/171.9
C209	4030007090	S.CER C1608 CH 1H 470J-T	B	43.2/185.4
C210	4030007040	S.CER C1608 CH 1H 180J-T	B	41.6/185.4
C211	4030007030	S.CER C1608 CH 1H 150J-T	B	33.9/185.4
C212	4030007050	S.CER C1608 CH 1H 220J-T	B	32.3/185.4
C213	4030007090	S.CER C1608 CH 1H 470J-T	B	37.1/190.1
C214	4030006990	S.CER C1608 CH 1H 080D-T	B	35.5/190.1
C215	4030007050	S.CER C1608 CH 1H 220J-T	B	33.9/190.1
C216	4030007030	S.CER C1608 CH 1H 150J-T	B	32.3/190.1
C217	4030007090	S.CER C1608 CH 1H 470J-T	B	41.6/195
C218	4030007040	S.CER C1608 CH 1H 180J-T	B	43.2/195
C219	4030007160	S.CER C1608 CH 1H 181J-T	B	42.2/209.9
C220	4030007090	S.CER C1608 CH 1H 470J-T	B	42.2/208.3
C231	4030006880	S.CER C1608 JB 1H 472K-T	B	19.1/161.6
C232	4030006880	S.CER C1608 JB 1H 472K-T	B	18.3/159.2
C233	4030006880	S.CER C1608 JB 1H 472K-T	B	19.9/159.2
C234	4030006880	S.C		

[RF UNIT]

REF NO.	ORDER NO.	DESCRIPTION	M.	H/V LOCATION
C276	4030006880	S.CER C1608 JB 1H 472K-T	T	65.6/169.4
C277	4030007050	S.CER C1608 CH 1H 220J-T	B	10.9/195
C278	4030007020	S.CER C1608 CH 1H 120J-T	B	12.5/195
C279	4030007130	S.CER C1608 CH 1H 101J-T	B	11.5/209.9
C280	4030007030	S.CER C1608 CH 1H 150J-T	B	11.5/208.3
C283	4030011600	S.CER C1608 JB 1E 104K-T	T	63.8/193.3
C285	4030006880	S.CER C1608 JB 1H 472K-T	T	63.5/215.2
C286	4030006880	S.CER C1608 JB 1H 472K-T	T	63.5/213.4
C287	4030006880	S.CER C1608 JB 1H 472K-T	T	67.9/221.2
C297	4030007140	S.CER C1608 CH 1H 121J-T	T	64.5/182.4
C302	4030007040	S.CER C1608 CH 1H 180J-T	T	65.2/188.8
C303	4030007120	S.CER C1608 CH 1H 820J-T	T	63.9/197.5
C304	4030007040	S.CER C1608 CH 1H 180J-T	T	65.2/197.5
C320	4030011600	S.CER C1608 JB 1E 104K-T	B	63.5/185.8
C321	4030011600	S.CER C1608 JB 1E 104K-T	B	64.5/198.8
C322	4030006880	S.CER C1608 JB 1H 472K-T	B	63.2/217.7
C323	4030006880	S.CER C1608 JB 1H 472K-T	B	63.2/214.6
C324	4030011770	S.CER C1608 CH 1H 060B-T	B	63.7/190.7
C327	4030007100	S.CER C1608 CH 1H 560J-T	B	63.5/184.2
C329	4030007110	S.CER C1608 CH 1H 680J-T	B	63.7/193.9
C331	4030007100	S.CER C1608 CH 1H 560J-T	B	64.5/200.4
C353	4030006880	S.CER C1608 JB 1H 472K-T	B	87.1/225.4
C354	4030006880	S.CER C1608 JB 1H 472K-T	B	89.8/224.1
C355	4030006880	S.CER C1608 JB 1H 472K-T	B	84.5/225.4
C356	4030006880	S.CER C1608 JB 1H 472K-T	B	83.1/235.1
C357	4030006880	S.CER C1608 JB 1H 472K-T	B	83.2/236.7
C358	4030006880	S.CER C1608 JB 1H 472K-T	B	80/233.5
C359	4030006880	S.CER C1608 JB 1H 472K-T	B	69.8/225.4
C360	4030006880	S.CER C1608 JB 1H 472K-T	B	72.6/225.4
C361	4030006880	S.CER C1608 JB 1H 472K-T	B	75.4/225.4
C388	4030006880	S.CER C1608 JB 1H 472K-T	B	78.5/240.7
C389	4030010210	S.CER C3216 JB 1C 105M-T	B	92/240.3
C390	4030011600	S.CER C1608 JB 1E 104K-T	B	105.7/234.1
C391	4030011600	S.CER C1608 JB 1E 104K-T	B	98.4/241
C392	4030011600	S.CER C1608 JB 1E 104K-T	B	83.5/242.2
C393	4030008860	S.CER C1608 JB 1H 153K-T	B	96.2/229.5
C394	4030010210	S.CER C3216 JB 1C 105M-T	B	92.2/234.1
C395	4030008860	S.CER C1608 JB 1H 153K-T	B	95.5/224.2
C396	4030011600	S.CER C1608 JB 1E 104K-T	B	109.8/227.9
C397	4550006470	S.TAN TEESVB2 1D 106M8R	T	108.3/228.8
C398	4030011600	S.CER C1608 JB 1E 104K-T	T	158/152.3
C399	4030011600	S.CER C1608 JB 1E 104K-T	T	147.3/147.6
C401	4030006880	S.CER C1608 JB 1H 472K-T	B	50.9/230.1
C402	4030010210	S.CER C3216 JB 1C 105M-T	B	41.9/235.1
C403	4030009520	S.CER C1608 CH 1H 020B-T	B	43.9/233.7
C404	4030007050	S.CER C1608 CH 1H 220J-T	B	43.9/236.5
C405	4030010760	S.CER C1608 CH 1H 331J-T	B	46.1/237.3
C410	4030006880	S.CER C1608 JB 1H 472K-T	B	38.6/224.9
C411	4030006880	S.CER C1608 JB 1H 472K-T	B	40.2/224.9
C421	4030006880	S.CER C1608 JB 1H 472K-T	B	84.5/139.5
C422	4030006880	S.CER C1608 JB 1H 472K-T	B	96.5/139.5
C423	4030006880	S.CER C1608 JB 1H 472K-T	B	86/135.7
C424	4030006880	S.CER C1608 JB 1H 472K-T	B	95.2/135.7
C425	4030006880	S.CER C1608 JB 1H 472K-T	B	89/135
C426	4030006880	S.CER C1608 JB 1H 472K-T	B	91.3/142.6
C427	4030006880	S.CER C1608 JB 1H 472K-T	B	93.1/142.6
C428	4030006880	S.CER C1608 JB 1H 472K-T	B	87.9/142.6
C431	4030006880	S.CER C1608 JB 1H 472K-T	B	32.5/224.9
C432	4030006880	S.CER C1608 JB 1H 472K-T	B	34.1/224.9
C501	4030011600	S.CER C1608 JB 1E 104K-T	T	162.7/33.8
C502	4030018590	S.CER C1608 CH 1H 122J-T	T	162.7/37.7
C503	4030018600	S.CER C1608 CH 1H 152J-T	T	162.7/41.6
C505	4030011330	S.CER C1608 CH 1H 391J-T	T	162.7/44.2
C506	4030011600	S.CER C1608 JB 1E 104K-T	T	157.9/44.8
C507	4510008540	S.ELE EEE1CA100SR	T	156.6/47.9
C508	4510008540	S.ELE EEE1CA100SR	T	156.6/33.9
C509	4030011600	S.CER C1608 JB 1E 104K-T	T	155.3/37
C510	4030008470	S.CER C1608 JB 1H 272K-T	T	150.5/41.6
C511	4030011280	S.CER C1608 CH 1H 271J-T	T	150.5/44.2
C512	4030011600	S.CER C1608 JB 1E 104K-T	T	145.7/44.8
C513	4510008540	S.ELE EEE1CA100SR	T	144.4/47.9
C514	4030011600	S.CER C1608 JB 1E 104K-T	T	143.1/37
C515	4510008540	S.ELE EEE1CA100SR	T	144.4/33.9
C516	4030017810	S.CER C1608 CH 1H 102J-T	B	132.9/39.1
C517	4030011600	S.CER C1608 JB 1E 104K-T	T	133.6/38
C518	4030011600	S.CER C1608 JB 1E 104K-T	T	133.6/43.8
C519	4030011600	S.CER C1608 JB 1E 104K-T	T	133.6/45.1
C520	4510008540	S.ELE EEE1CA100SR	T	133.6/48.2
C521	4030011600	S.CER C1608 JB 1E 104K-T	T	138.3/40.2
C522	4030011600	S.CER C1608 JB 1E 104K-T	T	126.6/45.8
C523	4030011600	S.CER C1608 JB 1E 104K-T	T	126.6/38
C524	4510008540	S.ELE EEE1CA100SR	T	126.9/34.9
C525	4030006880	S.CER C1608 JB 1H 472K-T	T	129.4/41.9
C526	4030011600	S.CER C1608 JB 1E 104K-T	T	123.7/40.6
C527	4030006880	S.CER C1608 JB 1H 472K-T	T	120.8/43.2
C528	4030011600	S.CER C1608 JB 1E 104K-T	T	118.1/34.4
C529	4030011600	S.CER C1608 JB 1E 104K-T	B	115.9/44.5
C530	4030011600	S.CER C1608 JB 1E 104K-T	B	107.9/44.5
C531	4030006880	S.CER C1608 JB 1H 472K-T	B	104.7/42
C532	4030006880	S.CER C1608 JB 1H 472K-T	B	112.7/42
C533	4030006880	S.CER C1608 JB 1H 472K-T	B	106.3/52.2
C534	4030006880	S.CER C1608 JB 1H 472K-T	B	114.3/52.2
C535	4030006880	S.CER C1608 JB 1H 472K-T	B	108.5/55.7
C536	4030011600	S.CER C1608 JB 1E 104K-T	B	115.9/58.8
C538	4030008920	S.CER C1608 JB 1H 473K-T	B	105.4/58.4
C539	4030011600	S.CER C1608 JB 1E 104K-T	T	116.5/55.7
C540	4510008540	S.ELE EEE1CA100SR	T	113.4/55.7
C541	4030011600	S.CER C1608 JB 1E 104K-T	B	111.4/59
C544	4030009530	S.CER C1608 CH 1H 030B-T	B	112/81.2
C546	4030011340	S.CER C1608 CH 1H 471J-T	B	100.9/70.2
C551	4030006880	S.CER C1608 JB 1H 472K-T	B	111.2/98.2
C552	4030017810	S.CER C1608 CH 1H 102J-T	B	111.2/105.5
C553	4030011770	S.CER C1608 CH 1H 060B-T	B	110.5/103.2
C554	4030011600	S.CER C1608 JB 1E 104K-T	B	108.2/96.1

[RF UNIT]

REF NO.	ORDER NO.	DESCRIPTION	M.	H/V LOCATION
C555	4030007030	S.CER C1608 CH 1H 150J-T	B	105/96.1
C556	4030006880	S.CER C1608 JB 1H 472K-T	B	105.8/93.7
C558	4030007040	S.CER C1608 CH 1H 180J-T	B	100.9/116.7
C559	4030006880	S.CER C1608 JB 1H 472K-T	B	90/124.4
C560	4030007080	S.CER C1608 CH 1H 390J-T	B	92.3/119.5
C561	4030006880	S.CER C1608 JB 1H 472K-T	B	97.3/116.9
C562	4030011810	S.CER C1608 CH 1H 102J-T	B	87/111.7
C563	4030007600	S.CER C1608 JB 1E 104K-T	B	98.8/126.7
C564	4030007080	S.CER C1608 CH 1H 390J-T	T	104.2/125.6
C565	4030007130	S.CER C1608 CH 1H 101J-T	T	108.8/125.4
C566	4030007120	S.CER C1608 CH 1H 820J-T	T	106.6/129.1
C567	4030007090	S.CER C1608 CH 1H 470J-T	T	110.8/125.9
C568	4030007130	S.CER C1608 CH 1H 101J-T	T	112.7/128.2
C569	4030011600	S.CER C1608 JB 1E 104K-T	T	120.7/124.7
C570	4030006900	S.CER C1608 JB 1H 103K-T	B	115.3/125.7
C571	4030011600	S.CER C1608 JB 1E 104K-T	B	128/126.2
C572	4030006900	S.CER C1608 JB 1H 103K-T	B	124.9/126.2
C573	4030011600	S.CER C1608 JB 1E 104K-T	B	115.3/115.8
C574	4030011600	S.CER C1608 JB 1E 104K-T	T	121.8/111.6
C576	4610001590	S.TRI TZX3R100A110R00	T	106.6/87
C577	4030011600	S.CER C1608 JB 1E 104K-T	T	121.8/114.4
C578	4030007100	S.CER C1608 CH 1H 560J-T	B	92/96.2
C579	4030006980	S.CER C1608 CH 1H 070D-T	B	94.6/97
C580	4030007100	S.CER C1608 CH 1H 560J-T	B	93.8/94.6
C581	4030007050	S.CER C1608 CH 1H 220J-T	B	153.5/40.9
C582	4030007050	S.CER C1608 CH 1H 220J-T	B	141.3/40.9
C584	4030009650	S.CER C1608 CH 1H 240J-T	B	91.6/108.2
C585	4030006980	S.CER C1608 CH 1H 070D-T	B	93.2/109.9
C586	4030007070	S.CER C1608 CH 1H 330J-T	B	94.9/108.2
C587	4030007010	S.CER C1608 CH 1H 100D-T	B	95.7/110.7
C588	4030007060	S.CER C1608 CH 1H 270J-T	B	96.5/108.2
C589	4030007020	S.CER C1608 CH 1H 120J-T	T	113.5/124.7
C590	4030007100	S.CER C1608 CH 1H 560J-T	T	117.3/126.6
C595	4030006860	S.CER C1608 JB 1H 102K-T	B	116.3/106
C601	4030017810	S.CER C1608 CH 1H 102J-T	B	125.7/66.4
C602	4030017810	S.CER C1608 CH 1H 102J-T	B	125.7/68.2
C603	4030011600	S.CER C1608 JB 1E 104K-T	B	129/66.4
C604	4030007140	S.CER C1608 CH 1H 121J-T	B	128.3/63.6
C605	4030010760	S.CER C1608 CH 1H 331J-T	B	130.1/63.6
C606	4030007160	S.CER C1608 CH 1H 181J-T	B	132.6/59.3
C607	4030007060	S.CER C1608 CH 1H 270J-T	B	132.6/61.1
C608	4030010760	S.CER C1608 CH 1H 331J-T	B	131.9/63.6
C609	4030007090	S.CER C1608 CH 1H 470J-T	B	137.3/63.6
C610	4030007160	S.CER C1608 CH 1H 181J-T	B	136.6/61.1
C611	4030007060	S.CER C1608 CH 1H 270J-T	B	136.6/59.3
C612	4030007140	S.CER C1608 CH 1H 121J-T	B	141/63.6
C613	4030010760	S.CER C1608 CH 1H 331J-T	B	139.1/63.6
C614	4030017810	S.CER C1608 CH 1H 102J-T	B	143.6/66.4
C615	4030011600	S.CER C1608 JB 1E 104K-T	B	140.3/66.4
C616	4030017810	S.CER C1608 CH 1H 102J-T	B	143.6/68.2
C617	4030017800	S.CER C1608 CH 1H 561J-T	B	125.7/77.2
C618	4030010760	S.CER C1608 CH 1H 331J-T	B	125.7/79
C619	4030011600	S.CER C1608 JB 1E 104K-T	B	129/77.2
C620	4030010760	S.CER C1608 CH 1H 331J-T	B	128.3/74.4
C621	4030007080	S.CER C1608 CH 1H 390J-T	B	130.1/74.4
C622	4030007080	S.CER C1608 CH 1H 390J-T	B	132.6/70
C623	4030010760	S.CER C1608 CH 1H 331J-T	B	132.6/71.9
C624	4030007090	S.CER C1608 CH 1H 470J-T	B	131.9/74.4
C625	4030010760	S.CER C1608 CH 1H 331J-T	B	137.3/74.4
C626	4030007080	S.CER C1608 CH 1H 390J-T	B	136.6/71.9
C627	4030010760	S.CER C1608 CH 1H 331J-T	B	136.6/70.1
C628	4030007080	S.CER C1608 CH 1H 390J-T	B	141/74.4
C629	4030010760	S.CER C1608 CH 1H 331J-T	B	139.1/74.4
C630	4030010760	S.CER C1608 CH 1H 331J-T	B	143.6/77.2
C631	4030011600	S.CER C1608 JB 1E 104K-T	B	140.3/77.2
C632	4030017800	S.CER C1608 CH 1H 561J-T	B	143.6/79
C633	4030017800	S.CER C1608 CH 1H 561J-T	B	125.7/88
C634	4030011330	S.CER C1608 CH 1H 391J-T	B	125.7/89.8
C635	4030011600	S.CER C1608 JB 1E 104K-T	B	129/88
C636	4030007160	S.CER C1608 CH 1H 181J-T	B	128.3/85.2

[RF UNIT]

REF NO.	ORDER NO.	DESCRIPTION	M.	H/V LOCATION
C671	4030007070	S.CER C1608 CH 1H 330J-T	B	132.6/104.4
C672	4030007050	S.CER C1608 CH 1H 220J-T	B	137.3/106.9
C673	4030007120	S.CER C1608 CH 1H 820J-T	B	131.9/106.9
C674	4030007080	S.CER C1608 CH 1H 390J-T	B	136.6/104.4
C675	4030007070	S.CER C1608 CH 1H 330J-T	B	136.6/102.6
C676	4030007050	S.CER C1608 CH 1H 220J-T	B	141/106.9
C677	4030007130	S.CER C1608 CH 1H 101J-T	B	139.1/106.9
C678	4030007170	S.CER C1608 CH 1H 221J-T	B	143.6/109.7
C679	4030011600	S.CER C1608 JB 1E 104K-T	B	140.3/109.7
C680	4030007170	S.CER C1608 CH 1H 221J-T	B	143.6/111.5
C681	4030007170	S.CER C1608 CH 1H 221J-T	T	127.4/59.8
C682	4030007110	S.CER C1608 CH 1H 680J-T	T	127.4/61.1
C683	4030011600	S.CER C1608 JB 1E 104K-T	T	130.2/61.1
C684	4030007090	S.CER C1608 CH 1H 470J-T	T	131/63.8
C685	4030007090	S.CER C1608 CH 1H 470J-T	T	132.3/63.8
C686	4030007070	S.CER C1608 CH 1H 330J-T	T	131.7/65.9
C687	4030007070	S.CER C1608 CH 1H 330J-T	T	131.7/67.2
C688	4030007010	S.CER C1608 CH 1H 100D-T	T	134.6/61.6
C689	4030007120	S.CER C1608 CH 1H 820J-T	T	134.6/62.9
C690	4030007070	S.CER C1608 CH 1H 330J-T	T	137.6/67.2
C691	4030007070	S.CER C1608 CH 1H 330J-T	T	137.6/65.9
C692	4030007090	S.CER C1608 CH 1H 470J-T	T	137.1/63.3
C693	4030007090	S.CER C1608 CH 1H 470J-T	T	138.4/63.3
C694	4030007110	S.CER C1608 CH 1H 680J-T	T	141.9/59.8
C695	4030011600	S.CER C1608 JB 1E 104K-T	T	139.1/61.1
C696	4030007050	S.CER C1608 CH 1H 220J-T	T	141.9/61.1
C697	4030007160	S.CER C1608 CH 1H 181J-T	T	126.6/69.5
C698	4030007090	S.CER C1608 CH 1H 470J-T	T	127.9/69.5
C699	4030011600	S.CER C1608 JB 1E 104K-T	T	130.2/70.1
C700	4030007090	S.CER C1608 CH 1H 470J-T	T	131/72.3
C701	4030007040	S.CER C1608 CH 1H 180J-T	T	132.3/72.3
C702	4030007030	S.CER C1608 CH 1H 150J-T	T	131.7/74.8
C703	4030007050	S.CER C1608 CH 1H 220J-T	T	131.7/76.2
C704	4030006990	S.CER C1608 CH 1H 080D-T	T	134.6/71.9
C705	4030007090	S.CER C1608 CH 1H 470J-T	T	134.6/70.6
C706	4030007030	S.CER C1608 CH 1H 150J-T	T	137.6/74.8
C707	4030007050	S.CER C1608 CH 1H 220J-T	T	137.6/76.2
C708	4030007040	S.CER C1608 CH 1H 180J-T	T	137.1/72.3
C709	4030007090	S.CER C1608 CH 1H 470J-T	T	138.4/72.3
C710	4030007090	S.CER C1608 CH 1H 470J-T	T	141.9/68.8
C711	4030011600	S.CER C1608 JB 1E 104K-T	T	139.1/70.1
C712	4030007160	S.CER C1608 CH 1H 181J-T	T	141.9/70.1
C713	4030007140	S.CER C1608 CH 1H 121J-T	T	127.4/79.1
C714	4030007040	S.CER C1608 CH 1H 180J-T	T	127.4/77.8
C715	4030011600	S.CER C1608 JB 1E 104K-T	T	130.2/79.1
C716	4030007070	S.CER C1608 CH 1H 330J-T	T	131/81.3
C717	4030007040	S.CER C1608 CH 1H 180J-T	T	132.3/81.3
C718	4030007010	S.CER C1608 CH 1H 100D-T	T	131.7/83.9
C719	4030007070	S.CER C1608 CH 1H 330J-T	T	131.7/85.2
C720	4030007010	S.CER C1608 CH 1H 100D-T	T	134.6/79.6
C721	4030007090	S.CER C1608 CH 1H 470J-T	T	134.6/80.9
C722	4030007010	S.CER C1608 CH 1H 100D-T	T	137.6/83.9
C723	4030007070	S.CER C1608 CH 1H 330J-T	T	137.6/85.2
C724	4030007040	S.CER C1608 CH 1H 180J-T	T	137.1/81.3
C725	4030007070	S.CER C1608 CH 1H 330J-T	T	138.4/81.3
C726	4030007040	S.CER C1608 CH 1H 180J-T	T	141.9/77.8
C727	4030011600	S.CER C1608 JB 1E 104K-T	T	139.1/79.1
C728	4030007140	S.CER C1608 CH 1H 121J-T	T	141.9/79.1
C729	4030007130	S.CER C1608 CH 1H 101J-T	T	127.4/88.1
C730	4030007030	S.CER C1608 CH 1H 150J-T	T	127.4/86.8
C731	4030011600	S.CER C1608 JB 1E 104K-T	T	130.2/88.1
C732	4030007050	S.CER C1608 CH 1H 220J-T	T	131/90.3
C733	4030007020	S.CER C1608 CH 1H 120J-T	T	132.3/90.3
C734	4030009500	S.CER C1608 CH 1H 0R5B-T	T	131.7/92.9
C735	4030007050	S.CER C1608 CH 1H 220J-T	T	131.7/94.2
C736	4030006980	S.CER C1608 CH 1H 070D-T	T	134.6/88.6
C737	4030007050	S.CER C1608 CH 1H 220J-T	T	134.6/89.9
C738	4030009500	S.CER C1608 CH 1H 0R5B-T	T	137.6/92.9
C739	4030007050	S.CER C1608 CH 1H 220J-T	T	137.6/94.2
C740	4030007020	S.CER C1608 CH 1H 120J-T	T	137.1/90.3
C741	4030007050	S.CER C1608 CH 1H 220J-T	T	138.4/90.3
C742	4030007030	S.CER C1608 CH 1H 150J-T	T	141.9/86.8
C743	4030011600	S.CER C1608 JB 1E 104K-T	T	139.1/88.1
C744	4030007130	S.CER C1608 CH 1H 101J-T	T	141.9/88.1
C745	4030007140	S.CER C1608 CH 1H 121J-T	T	128.5/99
C747	4030011600	S.CER C1608 JB 1E 104K-T	T	129.3/97
C749	4030009550	S.CER C1608 CH 1H 2R5B-T	T	131.9/101.4
C750	4030011770	S.CER C1608 CH 1H 060B-T	T	131.2/99.3
C751	4030007010	S.CER C1608 CH 1H 100D-T	T	132.6/99.3
C755	4030009550	S.CER C1608 CH 1H 2R5B-T	T	137.1/101.4
C756	4030011770	S.CER C1608 CH 1H 060B-T	T	137.9/99.3
C758	4030011600	S.CER C1608 JB 1E 104K-T	T	140/97
C759	4030007140	S.CER C1608 CH 1H 121J-T	T	140.8/99
C760	4030011770	S.CER C1608 CH 1H 060B-T	T	129.9/99.3
C761	4030011770	S.CER C1608 CH 1H 060B-T	T	136.3/99.3
C801	4030006880	S.CER C1608 JB 1H 472K-T	T	158/62.9
C802	4030011600	S.CER C1608 JB 1E 104K-T	T	151.1/62.9
C803	4030011600	S.CER C1608 JB 1E 104K-T	B	153.6/61.4
C804	4030011600	S.CER C1608 JB 1E 104K-T	T	159.1/73.1
C805	4030011600	S.CER C1608 JB 1E 104K-T	B	153.8/79.6
C806	4030006900	S.CER C1608 JB 1H 103K-T	B	154.6/76.1
C807	4030011600	S.CER C1608 JB 1E 104K-T	T	153.4/74.7
C812	4030006900	S.CER C1608 JB 1H 103K-T	B	163.6/99.1
C813	4030006880	S.CER C1608 JB 1H 472K-T	T	150.6/56.5
C814	4030012600	S.CER C2012 JB 1A 105M-T	T	152.2/56.2
C815	4030006990	S.CER C1608 CH 1H 080D-T	B	158/70.1
C816	4030012600	S.CER C2012 JB 1A 105M-T	T	149/56.1
C839	4030006880	S.CER C1608 JB 1H 472K-T	B	89.1/98
C840	4030011600	S.CER C1608 JB 1E 104K-T	B	85/96.5
C841	4030006880	S.CER C1608 JB 1H 472K-T	B	87.4/92.6
C871	4030006880	S.CER C1608 JB 1H 472K-T	B	27.7/224.5
C872	4030006880	S.CER C1608 JB 1H 472K-T	B	24.6/225
C904	4030006900	S.CER C1608 JB 1H 103K-T	B	71/142.3
C906	4030006880	S.CER C1608 JB 1H 472K-T	B	62.2/135.6

[RF UNIT]

REF NO.	ORDER NO.	DESCRIPTION	M.	H/V LOCATION
C907	4030011600	S.CER C1608 JB 1E 104K-T	B	80.5/139.8
C909	4030011600	S.CER C1608 JB 1E 104K-T	B	65.7/135
C910	4030006880	S.CER C1608 JB 1H 472K-T	T	79.7/143.5
C911	4030009920	S.CER C1608 CH 1H 050B-T	B	60.3/139.3
C912	4030006900	S.CER C1608 JB 1H 103K-T	B	81.7/137
C913	4030011600	S.CER C1608 JB 1E 104K-T	B	75.1/134.2
C914	4030006880	S.CER C1608 JB 1H 472K-T	T	79.7/140.8
C915	4030006900	S.CER C1608 JB 1H 103K-T	B	68.8/134.2
C917	4030007010	S.CER C1608 CH 1H 100D-T	B	68.6/128.1
C919	4030006880	S.CER C1608 JB 1H 472K-T	B	60.3/145.6
C920	4030006880	S.CER C1608 JB 1H 472K-T	B	60.6/131
C1001	4030007170	S.CER C1608 CH 1H 221J-T	T	16.6/137.1
C1008	4030006880	S.CER C1608 JB 1H 472K-T	B	50.7/134.3
C1009	4030006880	S.CER C1608 JB 1H 472K-T	B	49.9/119.8
C1010	4030012600	S.CER C2012 JB 1A 105M-T	B	38.1/139.5
C1011	4030012600	S.CER C2012 JB 1A 105M-T	T	38.1/144.4
C1012	4030010210	S.CER C3216 JB 1C 105M-T	B	38.8/145.6
C1013	4030012600	S.CER C2012 JB 1A 105M-T	T	38.1/138.6
C1014	4030018810	S.CER C3216 CH 1H 333J-T	T	25.5/147.7
C1016	4030012600	S.CER C2012 JB 1A 105M-T	B	41.4/129.2
C1017	4030012600	S.CER C2012 JB 1A 105M-T	B	41.4/118.2
C1020	4030012600	S.CER C2012 JB 1A 105M-T	B	33.5/126.1
C1021	4030012600	S.CER C2012 JB 1A 105M-T	B	33.5/112.2
C1024	4030010210	S.CER C3216 JB 1C 105M-T	B	29.7/125.5
C1025	4030010210	S.CER C3216 JB 1C 105M-T	B	29.6/111.6
C1026	4030010210	S.CER C3216 JB 1C 105M-T	B	22.1/132.5
C1027	4030010210	S.CER C3216 JB 1C 105M-T	B	22.1/119.9
C1028	4030006880	S.CER C1608 JB 1H 472K-T	B	11.5/122.4
C1029	4030006880	S.CER C1608 JB 1H 472K-T	B	12.2/136.9
C1032	4030011600	S.CER C1608 JB 1E 104K-T	T	15.4/131.3
C1033	4550006470	S.TAN TEESVB2 1D 106M8R	B	38.2/150.2
C1034	4550006470	S.TAN TEESVB2 1D 106M8R	T	19.5/131.4
C1037	4030007090	S.CER C1608 CH 1H 470J-T	T	24.3/144.5
C1038	4030017810	S.CER C1608 CH 1H 102J-T	T	37.7/141.5
C1039	4030017810	S.CER C1608 CH 1H 102J-T	B	39.9/147.3
C1040	4030017810	S.CER C1608 CH 1H 102J-T	B	35.7/137.7
C1041	4030006990	S.CER C1608 CH 1H 080D-T	T	27.3/141.3
C1046	4030007010	S.CER C1608 CH 1H 100D-T	B	18.7/125.9
C1048	4030017810	S.CER C1608 CH 1H 102J-T	B	31.3/129.8
C1049	4030017810	S.CER C1608 CH 1H 102J-T	B	31.3/116
C1050	4030017810	S.CER C1608 CH 1H 102J-T	B	28.8/127.5
C1051	4030017810	S.CER C1608 CH 1H 102J-T	B	28.8/113.6
C1052	4030007100	S.CER C1608 CH 1H 560J-T	B	44.9/119.3
C1053	4030007110	S.CER C1608 CH 1H 680J-T	T	3.1/141.7
C1054	4030007010	S.CER C1608 CH 1H 100D-T	T	4.4/141.7
C1055	4030007140	S.CER C1608 CH 1H 121J-T	T	3.6/139.6
C1056	4030007050	S.CER C1608 CH 1H 220J-T	T	3.6/138.3
C1057	4030007130	S.CER C1608 CH 1H 101J-T	T	3.1/136.1
C1060	4030017810	S.CER C1608 CH 1H 102J-T	B	3.1/109
C1061	4030007090	S.CER C1608 CH 1H 470J-T	T	49.2/83.9
C1062	4030007170	S.CER C1608 CH 1H 221J-T	T	50.5/83.9
C1064	4030007090	S.CER C1608 CH 1H 470J-T	T	50/81.8
C1066	4030007010	S.CER C1608 CH 1H 100D-T	T	50/77.8
C1067	4030007010	S.CER C1608 CH 1H 100D-T	T	3.6/133.8
C1068	4030009510	S.CER C1608 CH 1H 010B-T	B	28.9/132.2
C1069	4030009510	S.CER C1608 CH 1H 010B-T	B	28.9/118.4
C1070	4030006990	S.CER C1608 CH 1H 070D-T	T	50/79.2
C1071	4030007100	S.CER C1608 CH 1H 560J-T	T	5.7/128.3
C1072	4030007170	S.CER C1608 CH 1H 221J-T	T	3.6/125.6
C1073	4030007080	S.CER C1608 CH 1H 390J-T	T	4.4/128.3
C1074	4030007060	S.CER C1608 CH 1H 270J-T	T	50/80.5
C1081	4030006900	S.CER C1608 JB 1H 103K-T	B	38.3/96.1
C1082	4030006900	S.CER C1608 JB 1H 103K-T	B	39.7/91.8
C1083	4030006900	S.CER C1608 JB 1H 103K-T	T	42.6/90.3
C1084	4030006880	S.CER C1608 JB 1H 472K-T	T	41/88.2
C1085	4030006880	S.CER C1608 JB 1H 472K-T	T	39.7/88.2
C1091	4030006880	S.CER C1608 JB 1H 472K-T	T	51.8/51.9
C1092	4030006880	S.CER C1608 JB 1H 472K-T	T	51.8/54.6
C1093	4030006880	S.CER C1608 JB 1H 472K-T	T	

[RF UNIT]

REF NO.	ORDER NO.	DESCRIPTION	M.	H/V LOCATION
C1228	4030009920	S.CER C1608 CH 1H 050B-T	B	64.1/101.5
C1231	4030006900	S.CER C1608 JB 1H 103K-T	B	59.4/114.4
C1232	4030006900	S.CER C1608 JB 1H 103K-T	B	68.9/114.4
C1234	4030006900	S.CER C1608 JB 1H 103K-T	B	48.6/106
C1235	4030006880	S.CER C1608 JB 1H 472K-T	B	59.4/104.6
C1236	4030006900	S.CER C1608 JB 1H 103K-T	B	58.5/104.6
C1238	4030006900	S.CER C1608 JB 1H 103K-T	B	62.6/106
C1239	4030006880	S.CER C1608 JB 1H 472K-T	B	73.4/104.6
C1240	4030006900	S.CER C1608 JB 1H 103K-T	T	69.7/104.6
C1241	4030006900	S.CER C1608 JB 1H 103K-T	T	69.7/98.3
C1244	4030007040	S.CER C1608 CH 1H 180J-T	T	52.2/97
C1245	4030007130	S.CER C1608 CH 1H 101J-T	T	49.4/97
C1246	4030007120	S.CER C1608 CH 1H 820J-T	T	50.6/99.8
C1247	4030007090	S.CER C1608 CH 1H 470J-T	T	47.2/99.8
C1248	4030007130	S.CER C1608 CH 1H 101J-T	T	48/102
C1249	4030007020	S.CER C1608 CH 1H 120J-T	T	44.9/102
C1250	4030007040	S.CER C1608 CH 1H 180J-T	T	47.2/104.2
C1251	4030006900	S.CER C1608 JB 1H 103K-T	T	27.2/94.3
C1252	4030006900	S.CER C1608 JB 1H 103K-T	T	34.8/94.3
C1253	4030006900	S.CER C1608 JB 1H 103K-T	B	34.9/76
C1255	4030017810	S.CER C1608 CH 1H 102J-T	B	31/87.9
C1256	4030007010	S.CER C1608 CH 1H 100D-T	T	31/88.2
C1257	4030011600	S.CER C1608 JB 1E 104K-T	B	31/83.6
C1258	4030007080	S.CER C1608 CH 1H 390J-T	B	37/89.5
C1264	4030007110	S.CER C1608 CH 1H 680J-T	B	64.1/99.2
C1265	4610001830	S.TRI TZB4S100AB10R00	T	41/107.4
C1266	4030007020	S.CER C1608 CH 1H 120J-T	T	44.9/107.8
C1267	4030006880	S.CER C1608 JB 1H 472K-T	B	29.9/60.5
C1268	4030006980	S.CER C1608 CH 1H 070D-T	T	49.4/95.7
C1302	4030007060	S.CER C1608 CH 1H 270J-T	T	28.1/76.1
C1303	4030006980	S.CER C1608 CH 1H 070D-T	T	28.1/74.1
C1304	4030007070	S.CER C1608 CH 1H 330J-T	T	28.1/72.8
C1305	4030007010	S.CER C1608 CH 1H 100D-T	T	34/72.4
C1306	4030009650	S.CER C1608 CH 1H 240J-T	T	28.1/71.5
C1307	4030007030	S.CER C1608 CH 1H 150J-T	T	34/66.9
C1308	4030006900	S.CER C1608 JB 1H 103K-T	T	33.6/60.4
C1309	4030007080	S.CER C1608 CH 1H 390J-T	T	31/59.9
C1310	4030007080	S.CER C1608 CH 1H 390J-T	T	29.5/57.3
C1311	4030006900	S.CER C1608 JB 1H 103K-T	B	37.3/69
C1312	4030007060	S.CER C1608 CH 1H 270J-T	T	32/75.3
C1313	4030007060	S.CER C1608 CH 1H 270J-T	T	29.5/58.6
C1314	4030007030	S.CER C1608 CH 1H 150J-T	T	31.4/69.3
C1355	4030006880	S.CER C1608 JB 1H 472K-T	B	68.1/73.8
C1357	4030007000	S.CER C1608 CH 1H 090D-T	T	64.5/72.5
C1358	4030011600	S.CER C1608 JB 1E 104K-T	B	64.4/77.8
C1360	4030011600	S.CER C1608 JB 1E 104K-T	T	68/75.2
C1361	4030007020	S.CER C1608 CH 1H 120J-T	B	60.2/82.2
C1403	4030017810	S.CER C1608 CH 1H 102J-T	T	34.3/52.7
C1404	4030017810	S.CER C1608 CH 1H 102J-T	B	34.7/2.9
C1405	4030006900	S.CER C1608 JB 1H 103K-T	T	42.1/57.7
C1406	4030017810	S.CER C1608 CH 1H 102J-T	T	32.1/46.3
C1407	4030017810	S.CER C1608 CH 1H 102J-T	T	27.3/46.3
C1418	4030017810	S.CER C1608 CH 1H 102J-T	T	27.1/4.6
C1419	4030017810	S.CER C1608 CH 1H 102J-T	B	34.7/6.1
C1420	4030007120	S.CER C1608 CH 1H 820J-T	T	55.1/5
C1421	4030007150	S.CER C1608 CH 1H 151J-T	T	55.1/7.8
C1423	4030010750	S.CER C1608 CH 1H 201J-T	T	52.4/12.8
C1424	4030007010	S.CER C1608 CH 1H 100D-T	B	56.5/10.9
C1425	4030011600	S.CER C1608 JB 1E 104K-T	B	58.1/21.6
C1426	4030011600	S.CER C1608 JB 1E 104K-T	B	58.1/20
C1427	4030006900	S.CER C1608 JB 1H 103K-T	B	55.7/19.9
C1428	4030006980	S.CER C1608 CH 1H 070D-T	T	65.4/15
C1429	4030006900	S.CER C1608 JB 1H 103K-T	T	68/15
C1430	4030007040	S.CER C1608 CH 1H 180J-T	B	79.6/12.6
C1431	4030017810	S.CER C1608 CH 1H 102J-T	T	65.4/6.2
C1432	4030018600	S.CER C1608 CH 1H 152J-T	B	79.6/9.8
C1433	4030011600	S.CER C1608 JB 1E 104K-T	T	67.5/6.7
C1434	4030009920	S.CER C1608 CH 1H 050B-T	B	98.1/13.9
C1435	4030009920	S.CER C1608 CH 1H 050B-T	B	94.9/13.9
C1436	4030011600	S.CER C1608 JB 1E 104K-T	B	72.3/5.4
C1437	4030007170	S.CER C1608 CH 1H 221J-T	B	77.8/9.8
C1441	4030006880	S.CER C1608 JB 1H 472K-T	T	66.7/15
C1501	4030018640	S.CER C2012 CH 1H 103J-T	T	88/5.4
C1502	4550003220	S.TAN TEESVA 1E 105M8R	T	106/7.6
C1503	4030006900	S.CER C1608 JB 1H 103K-T	T	107.2/21.5
C1504	4030012610	S.CER C2012 JB 1C 474K-T	T	107/23.1
C1505	4030007010	S.CER C1608 CH 1H 100D-T	T	110/5.4
C1506	4030010760	S.CER C1608 CH 1H 331J-T	T	113.1/6.7
C1507	4510008540	S.ELE EEE1CA100SR	T	111.8/28.7
C1508	4030011600	S.CER C1608 JB 1E 104K-T	T	108.7/30.5
C1509	4030018800	S.CER C3216 CH 1H 223J-T	T	112/11
C1510	4030007110	S.CER C1608 CH 1H 680J-T	T	121.2/3.8
C1511	4510008540	S.ELE EEE1CA100SR	T	118.1/12.7
C1512	4030011600	S.CER C1608 JB 1E 104K-T	T	119.7/15.8
C1513	4030011600	S.CER C1608 JB 1E 104K-T	T	122.4/15.8
C1514	4510008540	S.ELE EEE1CA100SR	T	124/12.7
C1515	4030007160	S.CER C1608 CH 1H 181J-T	T	129/13.2
C1516	4030009350	S.CER C1608 CH 1H 3R5B-T	T	129/14.5
C1517	4030007110	S.CER C1608 CH 1H 680J-T	T	121.1/29.6
C1518	4030018640	S.CER C2012 CH 1H 103J-T	T	96.5/5.4
C1519	4550003220	S.TAN TEESVA 1E 105M8R	T	105.9/19.8
C1520	4030006900	S.CER C1608 JB 1H 103K-T	T	107.2/9.3
C1521	4030012610	S.CER C2012 JB 1C 474K-T	T	107/10.9
C1522	4030007010	S.CER C1608 CH 1H 100D-T	T	110/17.6
C1523	4030010760	S.CER C1608 CH 1H 331J-T	T	113.1/18.9
C1524	4030018800	S.CER C3216 CH 1H 223J-T	T	111.9/23.2
C1525	4510008540	S.ELE EEE1CA100SR	T	118.1/20.7
C1526	4030011600	S.CER C1608 JB 1E 104K-T	T	119.7/17.6
C1527	4030011600	S.CER C1608 JB 1E 104K-T	T	122.4/17.6
C1528	4510008540	S.ELE EEE1CA100SR	T	124/20.7
C1529	4030017870	S.CER C1608 CH 1H 681J-T	T	129/20.2
C1530	4030011330	S.CER C1608 CH 1H 391J-T	T	129/18.9
C1531	4510008500	S.ELE EEE1CA101WP	T	141.4/26.5
C1532	4030011600	S.CER C1608 JB 1E 104K-T	B	137.5/24.2

[RF UNIT]

REF NO.	ORDER NO.	DESCRIPTION	M.	H/V LOCATION
C1533	4030011600	S.CER C1608 JB 1E 104K-T	B	135.5/24.2
C1534	4510008500	S.ELE EEE1CA101WP	T	134.3/26.5
C1535	4030011600	S.CER C1608 JB 1E 104K-T	T	143.3/14.5
C1536	4030017870	S.CER C1608 CH 1H 681J-T	T	142.9/19.5
C1537	4510008500	S.ELE EEE1CA101WP	T	156.5/14.7
C1538	4030011600	S.CER C1608 JB 1E 104K-T	T	154.7/10.2
C1539	4030011600	S.CER C1608 JB 1E 104K-T	T	151.5/24.2
C1540	4510008500	S.ELE EEE1CA101WP	T	156.5/21.8
C1541	4030007050	S.CER C1608 CH 1H 220J-T	T	147.7/25.2
C1651	4030006880	S.CER C1608 JB 1H 472K-T	B	95.7/35.9
C1652	4030006880	S.CER C1608 JB 1H 472K-T	B	97.9/37.6
C1653	4030006880	S.CER C1608 JB 1H 472K-T	B	102.1/36.8
C1654	4030017810	S.CER C1608 CH 1H 102J-T	B	98.3/31.8
C1655	4030009530	S.CER C1608 CH 1H 030B-T	T	100.3/28.9
C1656	4610001970	S.TRI TZC3P200A110R00	T	99.7/25.6
C1657	4030017810	S.CER C1608 CH 1H 102J-T	T	85.9/19.9
C1658	4030017810	S.CER C1608 CH 1H 102J-T	T	94.1/19.9
C1659	4030011600	S.CER C1608 JB 1E 104K-T	T	83.5/28.7
C1660	4030011600	S.CER C1608 JB 1E 104K-T	B	158/14.5
C1661	4030011600	S.CER C1608 JB 1E 104K-T	B	153.4/3.6
C1662	4030011600	S.CER C1608 JB 1E 104K-T	T	150.3/4.2
C1663	4030011600	S.CER C1608 JB 1E 104K-T	T	143.3/11.9
C1665	4030006900	S.CER C1608 JB 1H 103K-T	B	152.3/7.1
C1666	4030006880	S.CER C1608 JB 1H 472K-T	B	82.9/35
C1701	4030006880	S.CER C1608 JB 1H 472K-T	B	75/100
C1702	4030006880	S.CER C1608 JB 1H 472K-T	B	75.8/104
C1703	4510004601	ELE 16 ME 1000 HC	T	66.9/24.1
C1704	4030011600	S.CER C1608 JB 1E 104K-T	T	64/24.1
C1705	4030011600	S.CER C1608 JB 1E 104K-T	T	58.1/27.8
C1706	4510009150	S.ELE EEE1EA470WP	T	117.3/148.2
C1707	4030011600	S.CER C1608 JB 1E 104K-T	T	104.9/138.6
C1717	4030006880	S.CER C1608 JB 1H 472K-T	T	104.9/140.2
C1718	4030006880	S.CER C1608 JB 1H 472K-T	T	104.9/143.4
C1720	4030006880	S.CER C1608 JB 1H 472K-T	T	104.9/141.8
C1721	4030006880	S.CER C1608 JB 1H 472K-T	T	104.9/145
C1722	4030006880	S.CER C1608 JB 1H 472K-T	T	104.9/146.6
C1723	4030006880	S.CER C1608 JB 1H 472K-T	T	126.6/147.5
C1724	4030011600	S.CER C1608 JB 1E 104K-T	B	121.3/137.3
C1725	4030011600	S.CER C1608 JB 1E 104K-T	T	136/126.9
C1901	4030011600	S.CER C1608 JB 1E 104K-T	T	149.6/126.9
C1902	4030011600	S.CER C1608 JB 1E 104K-T	T	143.7/137.7
C1903	4030011600	S.CER C1608 JB 1E 104K-T	T	157.1/137.7
C1904	4030011600	S.CER C1608 JB 1E 104K-T	B	129.3/242.3
C2001	4030007130	S.CER C1608 CH 1H 101J-T	B	142/238.7
C2002	4030006880	S.CER C1608 JB 1H 472K-T	B	146.5/139.7
C2003	4030006880	S.CER C1608 JB 1H 472K-T	T	159/173.7
C2004	4030011340	S.CER C1608 CH 1H 471J-T	T	172.8/171.6
C2006	4030011340	S.CER C1608 CH 1H 471J-T	T	167/189.7
C2007	4510009150	S.ELE EEE1EA470WP	T	159.1/175.2
C2009	4030011340	S.CER C1608 CH 1H 471J-T	T	167/218.4
C2010	4510009150	S.ELE EEE1EA470WP	T	172.8/178.8
C2012	4030011340	S.CER C1608 CH 1H 471J-T	T	163.5/209.3
C2013	4030006880	S.CER C1608 JB 1H 472K-T	T	163.5/206.7
C2015	4030006880	S.CER C1608 JB 1H 472K-T	T	163.5/204.1
C2016	4030006880	S.CER C1608 JB 1H 472K-T	T	163.5/201.5
C2017	4030006880	S.CER C1608 JB 1H 472K-T	T	172.8/156.9
C2018	4030006880	S.CER C1608 JB 1H 472K-T	T	163.5/198.9
C2019	4030006880	S.CER C1608 JB 1H 472K-T	T	172.8/161.5
C2020	4030006880	S.CER C1608 JB 1H 472K-T	T	172.8/168.9
C2021	4030011340	S.CER C1608 CH 1H 471J-T	T	159/170.7
C2022	4030011340	S.CER C1608 CH 1H 471J-T	T	159/172.2
C2023	4030011340	S.CER C1608 CH 1H 471J-T	T	
RL1	6330001860	RLY UA2-12NU		
RL2	6330001860	RLY UA2-12NU		
RL21	6330001860	RLY UA2-12NU		
RL22	6330001860	RLY UA2-12NU		
RL51	6330001860	RLY UA2-12NU		
RL52	6330001860	RLY UA2-12NU		
RL81	6330001860	RLY UA2-12NU		
RL82	6330001860	RLY UA2-12NU		
RL111	6330001860	RLY UA2-12NU		
RL112	6330001860	RLY UA2-12NU		
RL141	6330001860	RLY UA2-12NU		
RL142	6330001860</			

[RF UNIT]

REF NO.	ORDER NO.	DESCRIPTION	M.	H/V LOCATION
J103	6510023750	CNR 01K1971-10 ()		
J104	6510023750	CNR 01K1971-10 ()		
J105	6510023750	CNR 01K1971-10 ()		
J106	6510007020	CNR TMP-J01X-V6		
J108	6510007020	CNR TMP-J01X-V6		
J351	6510007020	CNR TMP-J01X-V6		
J352	6510007020	CNR TMP-J01X-V6		
J391	6510007020	CNR TMP-J01X-V6		
J501	6510007020	CNR TMP-J01X-V6		
J502	6510007020	CNR TMP-J01X-V6		
J503	6510007020	CNR TMP-J01X-V6		
J801	6510007020	CNR TMP-J01X-V6		
J808	6510007020	CNR TMP-J01X-V6		
J810	6510007020	CNR TMP-J01X-V6		
J1001	6510007020	CNR TMP-J01X-V6		
J1101	6510007020	CNR TMP-J01X-V6		
J1301	6510007020	CNR TMP-J01X-V6		
J1401	6910004741	CNR IMSA-9202B-1-03Z041-PT1		
J1402	6910004741	CNR IMSA-9202B-1-03Z041-PT1		
J1403	6910004741	CNR IMSA-9202B-1-03Z041-PT1		
J1404	6910004741	CNR IMSA-9202B-1-03Z041-PT1		
J1405	6910004741	CNR IMSA-9202B-1-03Z041-PT1		
J1406	6910004741	CNR IMSA-9202B-1-03Z041-PT1		
J1501	6510015541	S.CNR B4B-ZR-SM4-TF (LF) (SN)		168.2/21.6
J1651	6510007020	CNR TMP-J01X-V6		
J2001	6510024940	CNR HEC2305-016250		
J2002	6510023730	CNR LGY6502-0600C		
J2003	6510023730	CNR LGY6502-0600C		
J2004	6510007020	CNR TMP-J01X-V6		
J2006	6510019991	S.CNR 52808-2271 (2291)		168.3/166.7
J2007	6510018921	S.CNR B8B-PH-SM4-TB (LF) (SN)		168.2/204.1
F3	5210000041	FUS FGB 2A PBF (FGB0 125V)		
F2001	5220000230	HOL S-N5054 #01		
F2002	5220000230	HOL S-N5054 #01		
W1	8970024311	WIR 1.5D COAXIAL TUBE/C31		
W3	9030090170	WIR OPC-1805		
W1411	7120000480	S.JMP MJP-0.4-T		67.2/15
EP902	6910012350	S.BEA MMZ1608Y 102BT	B	60.6/134.1
EP903	6910012350	S.BEA MMZ1608Y 102BT	B	60.6/148.7
EP904	6910012350	S.BEA MMZ1608Y 102BT	B	104.9/141.8
EP1091	6910014690	S.BEA MPZ1608S221A-T	T	49/51.9
EP1092	6910014690	S.BEA MPZ1608S221A-T	T	49/53.2
EP1093	6910014690	S.BEA MPZ1608S221A-T	T	49/54.5
EP1201	6910012350	S.BEA MMZ1608Y 102BT	B	59/124.9
EP1202	6910012350	S.BEA MMZ1608Y 102BT	B	59/94.2
EP1210	6910012350	S.BEA MMZ1608Y 102BT	B	59/128
EP1229	6910014690	S.BEA MPZ1608S221A-T	B	28.2/69.2
EP1309	6910014690	S.BEA MPZ1608S221A-T	B	38.1/72.4
EP1504	6910014690	S.BEA MPZ1608S221A-T	B	132.3/22.7
EP1505	6910014690	S.BEA MPZ1608S221A-T	T	143.3/10.6
EP1654	6910012350	S.BEA MMZ1608Y 102BT	B	84.5/35
EP1801	6910012350	S.BEA MMZ1608Y 102BT	B	78.9/102.4
EP1802	6910012350	S.BEA MMZ1608Y 102BT	T	41.6/139.1
EP1803	6910014690	S.BEA MPZ1608S221A-T	B	75.8/102.4
EP1805	6910012350	S.BEA MMZ1608Y 102BT	B	104.9/143.4
EP1806	6910012350	S.BEA MMZ1608Y 102BT	B	78.9/105.6
EP1807	6910012350	S.BEA MMZ1608Y 102BT	B	75.8/105.6
EP1808	6910012350	S.BEA MMZ1608Y 102BT	B	154.1/14.5
EP1809	6910012350	S.BEA MMZ1608Y 102BT	B	104.9/145
EP1810	6910012350	S.BEA MMZ1608Y 102BT	T	23.1/132.8
EP1811	6910012350	S.BEA MMZ1608Y 102BT	T	23.1/135.6
EP1812	6910012350	S.BEA MMZ1608Y 102BT	B	104.9/146.6
EP1813	6910012350	S.BEA MMZ1608Y 102BT	T	55.2/131.7
EP1814	6910012350	S.BEA MMZ1608Y 102BT	T	55.2/130.4
EP1815	6910012350	S.BEA MMZ1608Y 102BT	T	6.8/124
EP1816	6910012350	S.BEA MMZ1608Y 102BT	T	55.2/133
EP1817	6910012350	S.BEA MMZ1608Y 102BT	B	15.4/140.2
EP1818	6910012350	S.BEA MMZ1608Y 102BT	B	104.9/138.6
EP1826	6910012350	S.BEA MMZ1608Y 102BT	B	104.9/140.2
EP1828	6910014690	S.BEA MPZ1608S221A-T	B	172.1/100
EP1830	6910012350	S.BEA MMZ1608Y 102BT	B	69.6/10.5
EP1831	6910012350	S.BEA MMZ1608Y 102BT	T	38.4/88.2
EP1832	6910012350	S.BEA MMZ1608Y 102BT	T	42.3/88.2
EP1833	6910012350	S.BEA MMZ1608Y 102BT	T	49/50.6
EP1834	6910012350	S.BEA MMZ1608Y 102BT	B	27.5/2.9
EP1835	6910012350	S.BEA MMZ1608Y 102BT	T	49/48
EP1836	6910012350	S.BEA MMZ1608Y 102BT	B	27.5/6.1
EP1837	6910012350	S.BEA MMZ1608Y 102BT	T	49/49.3
EP1838	6910012350	S.BEA MMZ1608Y 102BT	B	27.5/4.5
EP1901	6910014690	S.BEA MPZ1608S221A-T	T	136.8/137.7
EP2001	6910012350	S.BEA MMZ1608Y 102BT	B	166.5/245.8
EP2002	6910014690	S.BEA MPZ1608S221A-T	T	115.4/235.4
EP2003	6910012350	S.BEA MMZ1608Y 102BT	B	142.1/245.8
EP2004	6910012350	S.BEA MMZ1608Y 102BT	T	172.8/177.5
EP2005	6910012350	S.BEA MMZ1608Y 102BT	T	161.9/175.2
EP2006	6910012350	S.BEA MMZ1608Y 102BT	T	172.8/172.9
EP2007	6910012350	S.BEA MMZ1608Y 102BT	T	161.9/173.7
EP2008	6910012350	S.BEA MMZ1608Y 102BT	T	161.9/172.2
EP2009	6910012350	S.BEA MMZ1608Y 102BT	T	161.9/170.7
EP2010	6910012350	S.BEA MMZ1608Y 102BT	T	172.8/170.2
EP2011	6910012350	S.BEA MMZ1608Y 102BT	T	172.8/160.2
EP2012	6910012350	S.BEA MMZ1608Y 102BT	T	172.8/158.2
EP2013	6910014690	S.BEA MPZ1608S221A-T	T	163.5/208
EP2014	6910014690	S.BEA MPZ1608S221A-T	T	163.5/205.4
EP2015	6910014690	S.BEA MPZ1608S221A-T	T	163.5/202.8
EP2016	6910014690	S.BEA MPZ1608S221A-T	T	163.5/200.2
EP2017	6910014690	S.BEA MPZ1608S221A-T	T	163.5/197.6
EP2018	6910014690	S.BEA MPZ1608S221A-T	T	163.5/210.6

[MCF-W BOARD]

REF NO.	ORDER NO.	DESCRIPTION	M.	H/V LOCATION
F11401	2030000281	S.MLH FL-364A (64.455 MHz)	T	19.9/6.5
L1401	6150004280	COL LS-484B (C-14927)		
L1402	6150004280	COL LS-484B (C-14927)		
C1401	4030006900	S.CER C1608 JB 1H 103K-T	T	4.3/6.5
C1402	4030007030	S.CER C1608 CH 1H 150J-T	T	14.6/6.5
C1404	4030006990	S.CER C1608 CH 1H 080D-T	T	18.5/2.1
C1406	4030007030	S.CER C1608 CH 1H 150J-T	T	25.3/6.5
C1408	4030006900	S.CER C1608 JB 1H 103K-T	T	35.6/6.5

[MCF-M BOARD]

REF NO.	ORDER NO.	DESCRIPTION	M.	H/V LOCATION
F11401	2030000331	S.MLH FL-358A (64.455 MHz)	T	19.9/6.5
L1401	6150004280	COL LS-484B (C-14927)		
L1402	6150004280	COL LS-484B (C-14927)		
C1401	4030006900	S.CER C1608 JB 1H 103K-T	T	4.3/6.5
C1402	4030009920	S.CER C1608 CH 1H 050B-T	T	14.6/6.5
C1403	4030007020	S.CER C1608 CH 1H 120J-T	T	13.3/6.5
C1404	4030006990	S.CER C1608 CH 1H 080D-T	T	18.5/2.1
C1405	4030009920	S.CER C1608 CH 1H 050B-T	T	21.3/2.1
C1406	4030007020	S.CER C1608 CH 1H 120J-T	T	25.3/6.5
C1407	4030009920	S.CER C1608 CH 1H 050B-T	T	26.6/6.5
C1408	4030006900	S.CER C1608 JB 1H 103K-T	T	35.6/6.5

[MCF-N BOARD]

REF NO.	ORDER NO.	DESCRIPTION	M.	H/V LOCATION
F11401	2030000510	S.MLH FL-396 (64.455 MHz)	T	19.9/6.5
L1401	6150004280	COL LS-484B (C-14927)		
L1402	6150004280	COL LS-484B (C-14927)		
C1401	4030006900	S.CER C1608 JB 1H 103K-T	T	4.3/6.5
C1402	4030007020	S.CER C1608 CH 1H 120J-T	T	14.6/6.5
C1403	4030007020	S.CER C1608 CH 1H 120J-T	T	13.3/6.5
C1404	4030007030	S.CER C1608 CH 1H 150J-T	T	18.5/2.1
C1405	4030007030	S.CER C1608 CH 1H 150J-T	T	21.3/2.1
C1406	4030007020	S.CER C1608 CH 1H 120J-T	T	25.3/6.5
C1407	4030007020	S.CER C1608 CH 1H 120J-T	T	26.6/6.5
C1408	4030006900	S.CER C1608 JB 1H 103K-T	T	35.6/6.5

M.=Mounted side (T: Mounted on the Top side B: Mounted on the Bottom side) S.=Surface mount

[MAIN UNIT]

REF NO.	ORDER NO.	DESCRIPTION	M.	H/V LOCATION
IC171	1110006300	S.IC NJM2172V-TE1	T	48.8/40.6
IC191	1110006300	S.IC NJM2172V-TE1	B	60.8/75.6
IC201	1130005641	S.IC TC4W53F (TE12L,F)	T	47/33.2
IC211	1130005641	S.IC TC4W53F (TE12L,F)	B	47/26.4
IC221	1110001901	S.IC uPC4570G2-E1-A	T	41.9/27.2
IC231	1110006300	S.IC NJM2172V-TE1	T	39.7/75.7
IC241	1110001901	S.IC uPC4570G2-E1-A	B	41.4/65
IC281	1110006141	S.IC LA4485-E	T	
IC311	1110006300	S.IC NJM2172V-TE1	T	24.6/29.1
IC331	1110001901	S.IC uPC4570G2-E1-A	B	24.5/22.6
IC361	1120002830	S.IC NJM2125F-TE1-#FZZB	T	33.6/18.4
IC701	1130011990	S.IC SN74LVC1G08DCKR	T	131.8/95.3
IC721	1190001930	S.IC PS7122AL-1A-E3	B	81.5/89.5
IC741	1180001541	S.IC TA78L08F (TE12L,F)	B	27.2/81.9
IC1001	1140014340	S.IC TMS320C672BZDH275	T	131.5/32.1
IC1101	1130014253	S.IC AT29LV040A-15TU [FRA], [ITR], [ESP], [KOR] only	T	133.5/12.2
IC1111	1130010461	S.IC TC7SH08F (TE85L,JF)	T	142.6/32.4
IC1112	1110006411	S.IC R3111N111A-TR-F	T	147.9/32
IC1131	1130008361	S.IC TC7SH04FU (TE85L,JF)	T	134.3/43.2
IC1132	1130008041	S.IC TC7SH04FU (TE85L,JF)	T	125.3/43.2
IC1201	1130009981	S.IC TC7W53FK (TE85L,F)	T	84.7/18.2
IC1211	1110006100	S.IC NJM5534MD-TE1	T	89.3/7.6
IC1221	1110006100	S.IC NJM5534MD-TE1	T	91.3/16.9
IC1231	1110006100	S.IC NJM5534MD-TE1	T	102.2/7.6
IC1251	1110006111	S.IC AK5394AVSP/P	T	107.4/20.7
IC1311	1110006100	S.IC NJM5534MD-TE1	T	92/25.8
IC1321	1110006100	S.IC NJM5534MD-TE1	T	109.2/33.9
IC1331	1110006100	S.IC NJM5534MD-TE1	T	97.3/37.7
IC1351	1110001901	S.IC uPC4570G2-E1-A	T	77/17.4
IC1361	1180001771	S.IC TA79L05F (TE12L,F)	B	73.5/7.1
IC1401	1110007190	S.IC AK5383VFP-E2/P	T	76.5/29.4
IC1431	1130006891	S.IC TC7S04FU (TE85R,F)	T	122.5/45
IC1441	1130012160	S.IC SN74LVC1GU04DCKR	T	119.4/46.3
IC1451	1110005610	S.IC NJM2058V-TE1	T	66/26.9
IC1501	1190002090	S.IC AD1854JRSZRL	T	108.4/42.5
IC1511	1110006100	S.IC NJM5534MD-TE1	T	96.5/40.4
IC1521	1110006100	S.IC NJM5534MD-TE1	T	96.5/47.2
IC1531	1110006100	S.IC NJM5534MD-TE1	T	87.3/34.7
IC1571	1110006100	S.IC NJM5534MD-TE1	T	106/55.3
IC1601	1130012580	S.IC AK4355-VF-E2	T	84.7/43.8
IC1611	1110005420	S.IC BA15532F-E2	B	81.2/44
IC1651	1180003110	S.REG TLV1117CDCYR	B	156.2/7.7
IC1801	1130011530	S.IC CD74HC4094M96	B	173.1/56.9
IC1841	1130011530	S.IC CD74HC4094M96	B	173.1/68.7
IC1921	1130012000	S.IC M62352AGP C60Q	T	81.9/75.6
IC1931	1110005610	S.IC NJM2058V-TE1	T	96.9/77.7
IC2001	1110005610	S.IC NJM2058V-TE1	T	115.5/78.5
IC2051	1110005610	S.IC NJM2058V-TE1	T	134.4/86.2
Q11	1530002060	S.TR 2SC4081 T106 R	B	35.9/73.4
Q11	1530002060	S.TR 2SC4081 T106 R	B	50.8/74.4
Q21	1540000441	S.TR 2SD1619T-TD-E	B	39.1/82.1
Q22	1590001330	S.TR DTA114EUA T106	B	43.6/86.1
Q31	1530002060	S.TR 2SC4081 T106 R	B	31.9/77.9
Q201	1590000680	S.TR DTC114EUA T106	B	39.5/36.9
Q211	1590000680	S.TR DTC114EUA T106	B	40.1/30.2
Q261	1530002060	S.TR 2SC4081 T106 R	B	14.8/75.9
Q281	1590001050	S.TR DTC114TUA T106	B	4.4/57.6
Q282	1540000471	S.TR 2SD1801S-TL-E	B	18.4/49.9
Q291	1560001131	S.FET CPH3403-TL-E	B	20.1/35.5
Q301	1560001131	S.FET CPH3403-TL-E	B	28.9/28.2
Q351	1550000010	S.FET 2SC364-Q (TX)	B	23.2/13.6
Q721	1590001050	S.TR DTC114TUA T106	B	97.2/92.9
Q722	1590001050	S.TR DTC114TUA T106	B	82/80.8
Q731	1590001050	S.TR DTC114TUA T106	B	47/79.7
Q761	1530002060	S.TR 2SC4081 T106 R	T	50.4/78.2
Q810	1530002060	S.TR 2SC4081 T106 R	B	40.8/56.1
Q1201	1590000680	S.TR DTC114EUA T106	T	117.3/35.5
Q2001	1510000510	S.TR 2SA1576A T106R	T	106.9/72.4
Q2002	1560001260	S.FET 2SK3018 T106	B	116.5/76.1
Q2003	1590002430	S.FET DTA144EE TL	B	119.3/72.9
Q2051	1510000510	S.TR 2SA1576A T106R	B	145/83.1
Q2052	1590001050	S.FET DTC114TUA T106	B	141.9/83.1
Q2055	1530003091	S.TR 2SC4213-B (TE85R,F)	T	137.3/70.7
Q2056	1590002430	S.FET DTA144EE TL	T	136.4/73
Q2057	1590002150	S.FET DTC114TE TL	T	134.4/73
Q2058	1560001260	S.FET 2SK3018 T106	T	140.6/77.1
Q2059	1530002060	S.TR 2SC4081 T106 R	T	143.5/77.7
Q2060	1590002710	S.TR UMH11NTN	T	136/77.1
D1	1750000550	S.DIO 1SS355 TE-17	B	36.8/78.5
D11	1750000550	S.DIO 1SS355 TE-17	B	50.7/80.1
D161	1730002280	S.ZEN MA8091-M (TX)	B	46/58.4
D261	1750000550	S.DIO 1SS355 TE-17	B	14.9/79.8
D361	1750000550	S.DIO 1SS355 TE-17	B	23.4/11.4
D721	1750000550	S.DIO 1SS355 TE-17	B	92.5/90.4
D1351	1730002320	S.ZEN MA8051-M (TX)	B	71.7/16.3
D2001	1750000550	S.DIO 1SS355 TE-17	T	109.1/72.9
D2002	1750000550	S.DIO 1SS355 TE-17	T	107.3/81.1
D2003	1730002340	S.ZEN MA8047-M (TX)	B	113.2/75.2
D2004	1750000550	S.DIO 1SS355 TE-17	T	105.9/74.8
D2005	1750000550	S.DIO 1SS355 TE-17	T	105.9/78.6
D2041	1750000550	S.DIO 1SS355 TE-17	T	142.8/82.6
D2051	1750000550	S.DIO 1SS355 TE-17	T	136.9/82.5
D2052	1790001240	S.DIO MA25728-(TX)	B	144.2/77.5
D2053	1790001260	S.DIO MA25077-(TX)	T	140.7/75.2
D2054	1790001250	S.DIO MA25111-(TX)	B	147/78.5
D2091	1750000550	S.DIO 1SS355 TE-17	T	128.5/90.6
FI1121	2040000790	S.LC EXCCE1103U	T	119.7/39.2

[MAIN UNIT]

REF NO.	ORDER NO.	DESCRIPTION	M.	H/V LOCATION
X1141	6050011660	S.XTL CR-754 (30.000 MHz)	T	132.7/47.5
L171	6200003261	S.COL NLV32T-101J	B	45.9/41.2
L191	6200003261	S.COL NLV32T-101J	B	60.4/77.2
L231	6200003261	S.COL NLV32T-101J	B	43.6/76
L311	6200003261	S.COL NLV32T-101J	B	36.1/26.1
L701	6200003191	S.COL NLV32T-470J	B	141.5/93.6
L702	6200003191	S.COL NLV32T-470J	B	138.1/93.6
L711	6200003261	S.COL NLV32T-101J	B	163.7/81.4
L721	6200003261	S.COL NLV32T-101J	B	55.7/80.6
L731	6200003261	S.COL NLV32T-101J	B	47.9/85.3
L732	6200003261	S.COL NLV32T-101J	B	51.9/85.3
L733	6200003261	S.COL NLV32T-101J	B	55.7/85.3
L734	6200003261	S.COL NLV32T-101J	B	51.4/95.2
L735	6200003261	S.COL NLV32T-101J	B	60.1/87.7
L741	6200003261	S.COL NLV32T-101J	B	31.6/87.5
L742	6200003261	S.COL NLV32T-101J	B	34.2/90.8
L1001	6180003501	S.COL SLF6028T-100M1R3-PF	T	145.9/24.7
R1	7030003520	S.RES ERJ3GEYJ 472 V (4.7 k)	B	40.1/78.6
R2	7030003620	S.RES ERJ3GEYJ 333 V (33 k)	B	36.1/75.7
R3	7030003580	S.RES ERJ3GEYJ 153 V (15 k)	B	38.4/73.3
R4	7030003520	S.RES ERJ3GEYJ 472 V (4.7 k)	B	32.6/73.4
R11	7030003520	S.RES ERJ3GEYJ 472 V (4.7 k)	B	51/78.2
R12	7030003620	S.RES ERJ3GEYJ 333 V (33 k)	B	51/76.7
R13	7030003580	S.RES ERJ3GEYJ 153 V (15 k)	B	53.2/74.3
R14	7030003520	S.RES ERJ3GEYJ 472 V (4.7 k)	B	47.7/74.2
R21	7030003560	S.RES ERJ3GEYJ 103 V (10 k)	B	43.6/82
R22	7030009891	S.RES ERA3YED 151V (150)	B	43.7/83.8
R31	7030003640	S.RES ERJ3GEYJ 473 V (47 k)	B	31.7/75.6
R32	7030003560	S.RES ERJ3GEYJ 103 V (10 k)	B	31.5/84.3
R161	7030003360	S.RES ERJ3GEYJ 221 V (220)	B	38.6/60.3
R162	7030003440	S.RES ERJ3GEYJ 102 V (1 k)	B	41.8/60.3
R163	7030003420	S.RES ERJ3GEYJ 681 V (680)	B	40.9/53.9
R171	7030003860	S.RES ERJ3GE JPW V	T	37/61.5
R172	7030003520	S.RES ERJ3GEYJ 472 V (4.7 k)	T	47.6/51.7
R173	7030003860	S.RES ERJ3GE JPW V	B	52.7/41.9
R174	7030003560	S.RES ERJ3GEYJ 103 V (10 k)	B	50/43.7
R175	7030003720	S.RES ERJ3GEYJ 224 V (220 k)	B	49.8/45.9
R176	7030003560	S.RES ERJ3GEYJ 103 V (10 k)	T	50.9/46.6
R177	7030003550	S.RES ERJ3GEYJ 822 V (8.2 k)	T	49.6/46.6
R178	7030003640	S.RES ERJ3GEYJ 473 V (47 k)	T	47/46.6
R179	7030003620	S.RES ERJ3GEYJ 333 V (33 k)	T	48.3/46.6
R180	7030003560	S.RES ERJ3GEYJ 103 V (10 k)	T	52.2/42.3
R181	7030003560	S.RES ERJ3GEYJ 103 V (10 k)	T	52.2/39.7
R182	7030003440	S.RES ERJ3GEYJ 102 V (1 k)	T	57.7/33
R192	7030003560	S.RES ERJ3GEYJ 103 V (10 k)	T	60.8/70.4
R193	7030003520	S.RES ERJ3GEYJ 472 V (4.7 k)	B	61.7/74.4
R194	7030003440	S.RES ERJ3GEYJ 102 V (1 k)	T	64.2/73.7
R195	7030003580	S.RES ERJ3GEYJ 153 V (15 k)	T	55.6/66.5
R196	7030003600	S.RES ERJ3GEYJ 223 V (22 k)	B	61.2/80
R198	7030003620	S.RES ERJ3GEYJ 333 V (33 k)	B	61.2/81.8
R201	7030003320	S.RES ERJ3GEYJ 101 V (100)	B	48.8/40.6
R202	7030003320	S.RES ERJ3GEYJ 101 V (100)	B	42.7/36.6
R203	7030003440	S.RES ERJ3GEYJ 102 V (1 k)	B	43/32.9
R208	7030003620	S.RES ERJ3GEYJ 473 V (47 k)	B	41.2/34.9
R211	7030003560	S.RES ERJ3GEYJ 103 V (10 k)	B	51.6/27.6
R212	7030003560	S.RES ERJ3GEYJ 103 V (10 k)	B	51.6/25.8
R213	7030003580	S.RES ERJ3GEYJ 153 V (15 k)	T	39.2/30.7
R214	7030003320	S.RES ERJ3GEYJ 101 V (100)	B	41.2/32.9
R215	7030003520	S.RES ERJ3GEYJ 472 V (4.7 k)	B	43/26.1
R216	7030003620	S.RES ERJ3GEYJ 333 V (33 k)	B	41.2/26.1
R217	7030003860	S.RES ERJ3GE JPW V	B	44.4/16.3
R218	7030003640	S.RES ERJ3GEYJ 473 V (47 k)	B	40/28.2
R221	7030003680	S.RES ERJ3GEYJ 104 V (100 k)	T	49/25.8
R222	7030003560	S.RES ERJ3GEYJ 103 V (10 k)	T	50.3/25.8
R223	7030003440	S.RES ERJ3GEYJ 102 V (1 k)	T	46.5/28.4
R224	7030003320	S.RES ERJ3GEYJ 101 V (100)	T	51.6/28.4
R225	7030003320	S.RES ERJ3GEYJ 101 V (100)	T	48.4/23.9
R226	7030003320	S.RES ERJ3GEYJ 101 V (100)	T	38.6/23.6
R231	7030003440	S.RES ERJ3GEYJ 102 V (1 k)	T	52.5/75.5
R232	7030003620	S.RES ERJ3GEYJ 333 V (33 k)	T	45.5/77.3
R233	7030003560	S.RES ERJ3GEYJ 103 V (10 k)	T	45.7/76
R234	7030003620	S.RES ERJ3GEYJ 333 V (33 k)	T	42.5/80
R235	7030003560	S.RES ERJ3GEYJ 103 V (10 k)	B	39.9/76.9
R236	7030003560	S.RES ERJ3GEYJ 103 V (10 k)	T	35.1/76.3
R241	7030003440	S.RES ERJ3GEYJ 102 V (1 k)	B	33.2/67.5
R242	7030003660	S.RES ERJ3GEYJ 683 V (68 k)	B	34.6/64.7
R243	7030003560	S.RES ERJ3GEYJ 103 V (10 k)	B	32.2/63.9
R244	7030003560	S.RES ERJ3GEYJ 103 V (10 k)	B	35.6/62.3
R245	7030003320	S.RES ERJ3GEYJ 101 V (100)	T	40.7/66
R246	7030003320	S.RES ERJ3GEYJ 101 V (100)	T	46.2/70.7
R251	7030003680	S.RES ERJ3GEYJ 104 V (100 k)	B	48/65.9
R252	7030003680	S.RES ERJ3GEYJ 104 V (100 k)	B	46.4/65.9
R253	7030003470	S.RES ERJ3GEYJ 471 V (470)	B	47.1/68.2
R254	7030003440	S.RES ERJ3GEYJ 102 V (1 k)	B	11.2/93
R255	7030003480	S.RES ERJ3GEYJ 222 V (2.2 k)	B	11.2/90.1
R256	7030003680	S.RES ERJ3GEYJ 104 V (100 k)	B	47.1/63.5
R257	7030003570	S.RES ERJ3GEYJ 123 V (12 k		

[MAIN UNIT]

REF NO.	ORDER NO.	DESCRIPTION	M.	H/V LOCATION
R311	7030003520	S.RES ERJ3GEYJ 472 V (4.7 k)	B	28.7/33.4
R312	7030003440	S.RES ERJ3GEYJ 102 V (1 k)	B	32/32.7
R313	7030003560	S.RES ERJ3GEYJ 103 V (10 k)	B	26.2/26.2
R314	7030003560	S.RES ERJ3GEYJ 103 V (10 k)	B	23.1/26.2
R315	7030003520	S.RES ERJ3GEYJ 472 V (4.7 k)	B	14/35
R316	7030003480	S.RES ERJ3GEYJ 222 V (2.2 k)	B	31.3/36.9
R317	7030003470	S.RES ERJ3GEYJ 182 V (1.8 k)	B	35.3/35.5
R318	7030003470	S.RES ERJ3GEYJ 182 V (1.8 k)	B	35.2/37.2
R319	7030003470	S.RES ERJ3GEYJ 182 V (1.8 k)	B	34.6/33.2
R320	7030003470	S.RES ERJ3GEYJ 182 V (1.8 k)	B	35.9/33.2
R321	7030003480	S.RES ERJ3GEYJ 222 V (2.2 k)	B	36/31.2
R331	7030003580	S.RES ERJ3GEYJ 153 V (15 k)	B	30.4/22.1
R335	7030003640	S.RES ERJ3GEYJ 473 V (47 k)	B	33.5/22.9
R336	7030003440	S.RES ERJ3GEYJ 102 V (1 k)	B	20.6/19.3
R337	7030003560	S.RES ERJ3GEYJ 103 V (10 k)	B	17.9/21.4
R338	7030003440	S.RES ERJ3GEYJ 102 V (1 k)	B	16.3/21.4
R339	7030003560	S.RES ERJ3GEYJ 103 V (10 k)	B	22.5/16.6
R340	7030003320	S.RES ERJ3GEYJ 101 V (100)	B	26.7/18.4
R341	7030003320	S.RES ERJ3GEYJ 101 V (100)	B	19.5/25.3
R351	7030003560	S.RES ERJ3GEYJ 103 V (10 k)	B	20.7/16.6
R353	7030003440	S.RES ERJ3GEYJ 102 V (1 k)	B	24.3/16.6
R354	7030003500	S.RES ERJ3GEYJ 332 V (3.3 k)	B	26.6/15.8
R361	7030003600	S.RES ERJ3GEYJ 223 V (22 k)	B	20.7/12.9
R362	7030003700	S.RES ERJ3GEYJ 154 V (150 k)	B	23.4/9.7
R363	7030003460	S.RES ERJ3GEYJ 152 V (1.5 k)	B	28.5/11.4
R364	7030003320	S.RES ERJ3GEYJ 101 V (100)	B	35.9/19.7
R365	7030003640	S.RES ERJ3GEYJ 473 V (47 k)	B	38.9/19.1
R366	7030003560	S.RES ERJ3GEYJ 103 V (10 k)	B	32.5/11.4
R401	7030003320	S.RES ERJ3GEYJ 101 V (100)	T	147.3/7.7
R402	7030003320	S.RES ERJ3GEYJ 101 V (100)	T	147.3/12.6
R403	7030003320	S.RES ERJ3GEYJ 101 V (100)	B	65.1/44.3
R404	7030003320	S.RES ERJ3GEYJ 101 V (100)	T	147.3/11.3
R405	7030003320	S.RES ERJ3GEYJ 101 V (100)	B	147.6/35.3
R406	7030003320	S.RES ERJ3GEYJ 101 V (100)	B	65.1/39.5
R407	7030003320	S.RES ERJ3GEYJ 101 V (100)	B	65.1/42.7
R408	7030003320	S.RES ERJ3GEYJ 101 V (100)	B	65.1/33.1
R409	7030003320	S.RES ERJ3GEYJ 101 V (100)	B	65.1/41.1
R410	7030003320	S.RES ERJ3GEYJ 101 V (100)	B	65.1/34.7
R411	7030003320	S.RES ERJ3GEYJ 101 V (100)	B	65.1/37.9
R412	7030003320	S.RES ERJ3GEYJ 101 V (100)	B	65.1/36.3
R413	7030003320	S.RES ERJ3GEYJ 101 V (100)	B	122.6/50.8
R414	7030003320	S.RES ERJ3GEYJ 101 V (100)	B	147.6/36.9
R415	7030003320	S.RES ERJ3GEYJ 101 V (100)	T	147.3/8.9
R416	7030003320	S.RES ERJ3GEYJ 101 V (100)	B	144.5/36.3
R417	7030003320	S.RES ERJ3GEYJ 101 V (100)	T	147.3/10.1
R418	7030003320	S.RES ERJ3GEYJ 101 V (100)	T	147.3/16.5
R419	7030003320	S.RES ERJ3GEYJ 101 V (100)	T	147.3/13.9
R420	7030003320	S.RES ERJ3GEYJ 101 V (100)	T	147.3/15.2
R421	7030003320	S.RES ERJ3GEYJ 101 V (100)	B	147.6/42.9
R422	7030003320	S.RES ERJ3GEYJ 101 V (100)	B	147.6/40.9
R424	7030003320	S.RES ERJ3GEYJ 101 V (100)	B	144.5/39.8
R425	7030003320	S.RES ERJ3GEYJ 101 V (100)	B	147.6/38.9
R426	7030003320	S.RES ERJ3GEYJ 101 V (100)	T	147.3/5.1
R427	7030003320	S.RES ERJ3GEYJ 101 V (100)	T	147.3/6.4
R428	7030003320	S.RES ERJ3GEYJ 101 V (100)	B	132.8/20.9
R473	7030003860	S.RES ERJ3GE JPW V	T	55.6/32.2
R560	7030003680	S.RES ERJ3GEYJ 104 V (100 k)	B	10/32.8
R721	7310003820	TRI EVN-D2AA03 B14		
R722	7030003560	S.RES ERJ3GEYJ 103 V (10 k)	B	112/100.7
R723	7540000270	S.ASB ERZVF2M201	B	69.5/97.9
R724	7030003200	S.RES ERJ3GEYJ 100 V (10)	B	91.7/87.6
R725	7030003390	S.RES ERJ3GEYJ 391 V (390)	B	88/91.3
R741	7030003550	S.RES ERJ3GEYJ 822 V (8.2 k)	B	47.1/81.9
R745	7030006230	S.RES ERJ12YJ151U (150)	B	28.4/75
R761	7030003320	S.RES ERJ3GEYJ 101 V (100)	T	48.4/77.7
R762	7030003580	S.RES ERJ3GEYJ 153 V (15 k)	T	50.6/76.3
R763	7030003390	S.RES ERJ3GEYJ 391 V (390)	T	50.7/80.2
R764	7030003580	S.RES ERJ3GEYJ 153 V (15 k)	T	52.5/78.2
R801	7030003410	S.RES ERJ3GEYJ 561 V (560)	B	125.8/52.7
R802	7030007860	S.RES ERJ3GEYJ 8R2V (8.2)	B	123.9/52.3
R803	7030003410	S.RES ERJ3GEYJ 561 V (560)	B	125.8/50.5
R841	7030003860	S.RES ERJ3GE JPW V	B	21.3/72.2
R890	7030003320	S.RES ERJ3GEYJ 101 V (100)	T	157.7/17.1
R891	7030003320	S.RES ERJ3GEYJ 101 V (100)	T	166/18
R892	7030003320	S.RES ERJ3GEYJ 101 V (100)	T	157.7/15
R893	7030003320	S.RES ERJ3GEYJ 101 V (100)	T	166.2/16
R901	7030003320	S.RES ERJ3GEYJ 101 V (100)	B	117.1/95.1
R902	7030003320	S.RES ERJ3GEYJ 101 V (100)	B	115.5/95.1
R911	7030003320	S.RES ERJ3GEYJ 101 V (100)	T	157.7/19
R912	7030003320	S.RES ERJ3GEYJ 101 V (100)	T	166/20
R913	7030003320	S.RES ERJ3GEYJ 101 V (100)	T	157.7/21
R914	7030003320	S.RES ERJ3GEYJ 101 V (100)	T	166/22
R915	7030003320	S.RES ERJ3GEYJ 101 V (100)	T	157.7/23
R916	7030003320	S.RES ERJ3GEYJ 101 V (100)	T	166/24
R917	7030003320	S.RES ERJ3GEYJ 101 V (100)	T	157.7/25
R918	7030003320	S.RES ERJ3GEYJ 101 V (100)	T	166/26
R919	7030003320	S.RES ERJ3GEYJ 101 V (100)	T	157.7/27
R920	7030003320	S.RES ERJ3GEYJ 101 V (100)	T	157.7/31
R921	7030003320	S.RES ERJ3GEYJ 101 V (100)	T	166.1/30
R922	7030003320	S.RES ERJ3GEYJ 101 V (100)	T	166/32
R923	7030003320	S.RES ERJ3GEYJ 101 V (100)	T	157.7/33
R924	7030003320	S.RES ERJ3GEYJ 101 V (100)	T	166/34
R925	7030003320	S.RES ERJ3GEYJ 101 V (100)	T	157.7/35
R926	7030003320	S.RES ERJ3GEYJ 101 V (100)	T	166/36
R927	7030003320	S.RES ERJ3GEYJ 101 V (100)	T	157.7/37
R945	7030003860	S.RES ERJ3GE JPW V	B	10/27
R946	7030003860	S.RES ERJ3GE JPW V	T	4.8/26
R947	7030003860	S.RES ERJ3GE JPW V	B	10/25
R948	7030003860	S.RES ERJ3GE JPW V	T	4.8/24
R949	7030003860	S.RES ERJ3GE JPW V	B	10/23
R950	7030003860	S.RES ERJ3GE JPW V	T	4.8/22
R951	7030003320	S.RES ERJ3GEYJ 101 V (100)	T	4.8/20
R952	7030003320	S.RES ERJ3GEYJ 101 V (100)	B	10/20.9
R953	7030003320	S.RES ERJ3GEYJ 101 V (100)	T	4.8/18

[MAIN UNIT]

REF NO.	ORDER NO.	DESCRIPTION	M.	H/V LOCATION
R956	7030003860	S.RES ERJ3GE JPW V	B	10/17.5
R961	7030003320	S.RES ERJ3GEYJ 101 V (100)	T	172.1/13
R962	7030003320	S.RES ERJ3GEYJ 101 V (100)	T	180.4/14
R963	7030003320	S.RES ERJ3GEYJ 101 V (100)	T	172.1/15
R964	7030003320	S.RES ERJ3GEYJ 101 V (100)	T	180.4/16
R965	7030003320	S.RES ERJ3GEYJ 101 V (100)	T	172.1/17
R966	7030003860	S.RES ERJ3GE JPW V	T	180.4/18
R967	7030003860	S.RES ERJ3GE JPW V	T	172.1/19
R968	7030003860	S.RES ERJ3GE JPW V	T	180.4/20
R969	7030003320	S.RES ERJ3GEYJ 101 V (100)	T	172.1/21
R970	7030003320	S.RES ERJ3GEYJ 101 V (100)	T	180.4/22
R971	7030003320	S.RES ERJ3GEYJ 101 V (100)	T	172.1/23
R972	7030003320	S.RES ERJ3GEYJ 101 V (100)	T	180.4/24
R973	7030003320	S.RES ERJ3GEYJ 101 V (100)	T	172.1/25
R974	7030003320	S.RES ERJ3GEYJ 101 V (100)	T	180.4/26
R975	7030003320	S.RES ERJ3GEYJ 101 V (100)	T	172.1/27
R976	7030003320	S.RES ERJ3GEYJ 101 V (100)	T	180.4/28
R977	7030003320	S.RES ERJ3GEYJ 101 V (100)	T	172.1/29
R978	7030003320	S.RES ERJ3GEYJ 101 V (100)	T	180.4/30
R979	7030003320	S.RES ERJ3GEYJ 101 V (100)	T	172.1/31
R981	7030003320	S.RES ERJ3GEYJ 101 V (100)	T	172.1/33
R982	7030003320	S.RES ERJ3GEYJ 101 V (100)	T	180.4/34
R983	7030003320	S.RES ERJ3GEYJ 101 V (100)	T	172.1/35
R984	7030003860	S.RES ERJ3GE JPW V	T	180.4/36
R985	7030003860	S.RES ERJ3GE JPW V	T	172.1/37
R986	7030003860	S.RES ERJ3GE JPW V	T	180.4/38
R992	7030003320	S.RES ERJ3GEYJ 101 V (100)	T	157.7/39
R1001	7030003640	S.RES ERJ3GEYJ 473 V (47 k)	B	140.6/23.8
R1002	7030003640	S.RES ERJ3GEYJ 473 V (47 k)	B	136.4/21.6
R1003	7030003640	S.RES ERJ3GEYJ 473 V (47 k)	B	142.6/25.2
R1004	7030003640	S.RES ERJ3GEYJ 473 V (47 k)	B	141.6/32.6
R1005	7030003640	S.RES ERJ3GEYJ 473 V (47 k)	B	143.8/37.9
R1006	7030003640	S.RES ERJ3GEYJ 473 V (47 k)	B	147.5/30.5
R1007	7030003640	S.RES ERJ3GEYJ 473 V (47 k)	B	147.3/26.2
R1008	7030003640	S.RES ERJ3GEYJ 473 V (47 k)	B	147.3/24.6
R1009	7030003640	S.RES ERJ3GEYJ 473 V (47 k)	B	147.5/32.3
R1010	7030008240	S.RES ERJ12Y0R00U	T	117.4/55.1
R1011	7030003860	S.RES ERJ3GE JPW V	T	114.2/57
R1012	7030008240	S.RES ERJ12Y0R00U	T	123.2/60.3
R1013	7030008240	S.RES ERJ12Y0R00U	B	150/18.4
R1014	7030003640	S.RES ERJ3GEYJ 473 V (47 k)	B	120.5/24.3
R1015	7030003640	S.RES ERJ3GEYJ 473 V (47 k)	B	120.5/26.9
R1016	7030003640	S.RES ERJ3GEYJ 473 V (47 k)	B	120.5/25.6
R1017	7030003640	S.RES ERJ3GEYJ 473 V (47 k)	B	120.5/29.5
R1018	7030003640	S.RES ERJ3GEYJ 473 V (47 k)	B	117.9/30.2
R1019	7030003640	S.RES ERJ3GEYJ 473 V (47 k)	B	120.5/31.5
R1020	7030003640	S.RES ERJ3GEYJ 473 V (47 k)	B	117.9/32.4
R1021	7030003640	S.RES ERJ3GEYJ 473 V (47 k)	B	120.5/33
R1111	7030003640	S.RES ERJ3GEYJ 473 V (47 k)	T	145.4/33.2
R1112	7030003640	S.RES ERJ3GEYJ 473 V (47 k)	B	143.4/32.6
R1113	7030003640	S.RES ERJ3GEYJ 473 V (47 k)	T	147.4/35.4
R1131	7030003320	S.RES ERJ3GEYJ 101 V (100)	T	137.5/43.2
R1132	7030003320	S.RES ERJ3GEYJ 101 V (100)	T	128.5/43.2
R1141	7030003800	S.RES ERJ3GEYJ 105 V (1 M)	T	130.4/44
R1151	7030004040	S.RES ERJ3GEYJ 4R7 V (4.7)	B	133.5/42.3
R1152	7030003520	S.RES ERJ3GEYJ 472 V (4.7 k)	B	127.3/41.5
R1153	7030003520	S.RES ERJ3GEYJ 472 V (4.7 k)	B	126/41.5
R1201	7030003800	S.RES ERJ3GEYJ 332 V (3.3 k)	B	97.5/11.9
R1202	7030003480	S.RES ERJ3GEYJ 222 V (2.2 k)	B	95.3/9.2
R1203	7030003640	S.RES ERJ3GEYJ 473 V (47 k)	T	86.6/18.5
R1204	7030003860	S.RES ERJ3GE JPW V	T	82/14.2
R1211	7030009591	S.RES ERA3YED 472V (4.7 k)	T	83.9/4.8
R1212	7030009591	S.RES ERA3YED 472V (4.7 k)	T	85.9/4.8
R1213	7030003860	S.RES ERJ3GE JPW V	T	85.9/7.5
R1214	7030003320	S.RES ERJ3GEYJ 101 V (100)	T	83.1/11
R1215	7030003320	S.RES ERJ3GEYJ 101 V (100)	T	92.7/5.6
R1221	7030003320	S.RES ERJ3GEYJ 101 V (100)	T	87.9/17.4
R1222	7030003320	S.RES ERJ3GEYJ 101 V (100)	T	94.7/14.4
R1223	7030006601	S.RES ERA3YED 272V (2.7 k)	T	87.9/14.3
R1224	7030010390	S.RES ERA3YED 821V (820)	T	96/18.1
R1225	7030009691	S.RES ERA3YED 101V (100)	T	95.4/20
R1231	7030003320	S.RES ERJ3GEYJ 101 V (100)	T	98.4/7.9
R1232	7030003320	S.RES ERJ3GEYJ 101 V (100)	T	106.3/5.4
R1233	7030006601	S.RES ERA3YED 272V (2.7 k)	T	98.2/6.1
R1234	7030010390	S.RES ERA3YED 821V (820)	T	107.2/9.9
R1235	7030009691	S.RES ERA3YED 101V (100)	T	105.6/12
R1241	7030009591	S.RES ERA3YED 472V (4.7 k)	T	1

[MAIN UNIT]

REF NO.	ORDER NO.	DESCRIPTION	M.	H/V LOCATION
R1351	7030006521	S.RES ERA3YED 561V (560)	B	74.5/12.2
R1352	7030003360	S.RES ERJ3GEYJ 221 V (220)	B	77.3/13.6
R1353	7030003680	S.RES ERJ3GEYJ 104 V (100 k)	T	78.2/13.4
R1354	7030003680	S.RES ERJ3GEYJ 104 V (100 k)	T	72/13.9
R1355	7030003680	S.RES ERJ3GEYJ 104 V (100 k)	B	77.8/17.1
R1356	7030003380	S.RES ERJ3GEYJ 331 V (330)	B	76.6/17.9
R1361	7030003560	S.RES ERJ3GEYJ 103 V (10 k)	B	77.6/12
R1362	7030003560	S.RES ERJ3GEYJ 103 V (10 k)	T	76.5/9.4
R1363	7030003410	S.RES ERJ3GEYJ 561 V (560)	B	77.9/8.5
R1401	7030003520	S.RES ERJ3GEYJ 472 V (4.7 k)	B	76.2/32.3
R1402	7030003520	S.RES ERJ3GEYJ 472 V (4.7 k)	B	80.7/29.9
R1407	7030003640	S.RES ERJ3GEYJ 473 V (47 k)	T	82.3/27.7
R1408	7030003200	S.RES ERJ3GEYJ 100 V (10)	T	85/27.4
R1409	7030003320	S.RES ERJ3GEYJ 101 V (100)	T	82.3/30.6
R1410	7030003640	S.RES ERJ3GEYJ 473 V (47 k)	T	82.3/31.8
R1411	7030003640	S.RES ERJ3GEYJ 473 V (47 k)	T	82.7/33.7
R1421	7030003640	S.RES ERJ3GEYJ 473 V (47 k)	T	70.6/30.9
R1422	7030003640	S.RES ERJ3GEYJ 473 V (47 k)	T	70.6/32.1
R1423	7030003640	S.RES ERJ3GEYJ 473 V (47 k)	T	71.2/34
R1441	7030003800	S.RES ERJ3GEYJ 105 V (1 M)	T	119.4/44.4
R1451	7030009691	S.RES ERA3YED 101V (100)	T	62.8/20.4
R1452	7030009591	S.RES ERA3YED 472V (4.7 k)	T	64/20.4
R1453	7030003520	S.RES ERJ3GEYJ 472 V (4.7 k)	B	69.2/20.6
R1454	7030003520	S.RES ERJ3GEYJ 472 V (4.7 k)	B	69.3/16.8
R1455	7030005321	S.RES ERA3YED 103V (10 k)	B	69.2/34.9
R1461	7030009691	S.RES ERA3YED 101V (100)	T	69/20.4
R1462	7030009591	S.RES ERA3YED 472V (4.7 k)	T	67.8/20.4
R1463	7030005321	S.RES ERA3YED 103V (10 k)	B	69.2/23.8
R1471	7030009591	S.RES ERA3YED 472V (4.7 k)	T	67.8/32.3
R1472	7030009591	S.RES ERA3YED 472V (4.7 k)	B	70.8/34.9
R1481	7030003320	S.RES ERJ3GEYJ 101 V (100)	B	69.2/22.2
R1482	7030003320	S.RES ERJ3GEYJ 101 V (100)	T	73.5/38.2
R1491	7030003860	S.RES ERJ3GE JPW V	T	63.7/32.3
R1492	7030003860	S.RES ERJ3GE JPW V	T	66/33.9
R1501	7030003360	S.RES ERJ3GEYJ 221 V (220)	T	102.6/38.9
R1511	7030005351	S.RES ERA3YED 182V (1.8 k)	B	102/39.6
R1512	7030007230	S.RES ERA3YED 102V (1 k)	B	98.9/39.6
R1513	7030007230	S.RES ERA3YED 102V (1 k)	B	99/37.2
R1514	7030010770	S.RES ERA3YED 681V (680)	B	94.5/40.6
R1521	7030005351	S.RES ERA3YED 182V (1.8 k)	B	101.6/45.7
R1522	7030007230	S.RES ERA3YED 102V (1 k)	B	98.5/45.7
R1523	7030007230	S.RES ERA3YED 102V (1 k)	B	98.5/44.1
R1524	7030010770	S.RES ERA3YED 681V (680)	B	94.4/44.3
R1525	7030007230	S.RES ERA3YED 102V (1 k)	B	97.5/41.7
R1531	7030006461	S.RES ERA3YED 152V (1.5 k)	B	90.6/40.2
R1532	7030007230	S.RES ERA3YED 102V (1 k)	B	87.4/36.3
R1533	7030006461	S.RES ERA3YED 152V (1.5 k)	B	90.6/41.8
R1534	7030007230	S.RES ERA3YED 102V (1 k)	T	92/35
R1535	7030009691	S.RES ERA3YED 101V (100)	B	83.1/33.3
R1541	7030003320	S.RES ERJ3GEYJ 101 V (100)	B	90.6/38.6
R1542	7030003320	S.RES ERJ3GEYJ 101 V (100)	B	107/36.1
R1551	7030003320	S.RES ERJ3GEYJ 101 V (100)	B	96.4/50.6
R1552	7030003320	S.RES ERJ3GEYJ 101 V (100)	B	103.8/47.3
R1561	7030003320	S.RES ERJ3GEYJ 101 V (100)	B	90.1/36.2
R1562	7030003320	S.RES ERJ3GEYJ 101 V (100)	T	88.8/38.8
R1571	7030003520	S.RES ERJ3GEYJ 472 V (4.7 k)	T	104.9/44.4
R1572	7030003520	S.RES ERJ3GEYJ 472 V (4.7 k)	T	103.7/48.8
R1573	7030003360	S.RES ERJ3GEYJ 221 V (220)	B	108.1/52.1
R1574	7030003520	S.RES ERJ3GEYJ 472 V (4.7 k)	T	111.5/48.5
R1575	7030003360	S.RES ERJ3GEYJ 221 V (220)	B	107.8/54.3
R1576	7030003520	S.RES ERJ3GEYJ 472 V (4.7 k)	B	107.8/55.9
R1577	7030003320	S.RES ERJ3GEYJ 101 V (100)	B	109.8/52.1
R1578	7030003320	S.RES ERJ3GEYJ 101 V (100)	B	99.6/57.1
R1579	7030009691	S.RES ERA3YED 101V (100)	T	101.9/52
R1601	7030003320	S.RES ERJ3GEYJ 101 V (100)	B	86/41.8
R1605	7030007230	S.RES ERA3YED 102V (1 k)	B	97.4/37.2
R1611	7030009591	S.RES ERA3YED 472V (4.7 k)	T	78.6/41.1
R1612	7030009591	S.RES ERA3YED 472V (4.7 k)	B	76.9/38.7
R1613	7030009961	S.RES ERA3YED 221V (220)	B	76.9/40.5
R1614	7030009591	S.RES ERA3YED 472V (4.7 k)	T	78.6/39.8
R1615	7030009591	S.RES ERA3YED 472V (4.7 k)	T	74.4/39.9
R1616	7030009961	S.RES ERA3YED 221V (220)	B	81.6/37
R1617	7030009691	S.RES ERA3YED 101V (100)	B	74.6/39.4
R1621	7030005321	S.RES ERA3YED 103V (10 k)	T	78.6/43.6
R1622	7030005321	S.RES ERA3YED 103V (10 k)	T	78.6/42.4
R1623	7030005341	S.RES ERA3YED 332V (3.3 k)	T	74.7/42
R1624	7030007661	S.RES ERA3YED 331V (3.3 k)	B	75.2/45.7
R1625	7030006521	S.RES ERA3YED 561V (560)	B	72.2/47.3
R1626	7030006461	S.RES ERA3YED 152V (1.5 k)	B	72.2/44.2
R1627	7030007661	S.RES ERA3YED 331V (330)	B	75.5/49.5
R1628	7030005341	S.RES ERA3YED 332V (3.3 k)	B	75.5/51.1
R1631	7030003320	S.RES ERJ3GEYJ 101 V (100)	B	84.2/47.5
R1641	7030003320	S.RES ERJ3GEYJ 101 V (100)	B	83.9/40
R1651	7030003330	S.RES ERJ3GEYJ 121 V (120)	B	160.5/4.9
R1652	7030011740	S.RES ERJ12YJ1R5U	B	170.6/10.3
R1653	7030011740	S.RES ERJ12YJ1R5U	B	166.6/10.3
R1701	7030003860	S.RES ERJ3GE JPW V	B	114.8/23.6
R1822	7030003320	S.RES ERJ3GEYJ 101 V (100)	B	165.9/56.7
R1823	7030003320	S.RES ERJ3GEYJ 101 V (100)	B	166.9/58.2
R1824	7030003320	S.RES ERJ3GEYJ 101 V (100)	B	165.9/59.7
R1833	7030003320	S.RES ERJ3GEYJ 101 V (100)	B	166.8/61.2
R1834	7030003320	S.RES ERJ3GEYJ 101 V (100)	B	179.1/54.4
R1835	7030003320	S.RES ERJ3GEYJ 101 V (100)	B	179.9/56.1
R1859	7030003320	S.RES ERJ3GEYJ 101 V (100)	B	166/67.5
R1860	7030003320	S.RES ERJ3GEYJ 101 V (100)	B	166.8/69.1
R1861	7030003320	S.RES ERJ3GEYJ 101 V (100)	B	165.9/70.7
R1863	7030003320	S.RES ERJ3GEYJ 101 V (100)	B	179.8/65.9
R1881	7030003860	S.RES ERJ3GE JPW V	B	178.7/62.8
R1882	7030003860	S.RES ERJ3GE JPW V	B	172.6/47.1
R1883	7030003860	S.RES ERJ3GE JPW V	B	174.5/47.2
R1884	7030003860	S.RES ERJ3GE JPW V	B	170.6/47.1
R1885	7030003860	S.RES ERJ3GE JPW V	T	82.3/80.4
R1886	7030003860	S.RES ERJ3GE JPW V	B	176.8/47.2
R1887	7030003860	S.RES ERJ3GE JPW V	B	163.8/61.2

[MAIN UNIT]

REF NO.	ORDER NO.	DESCRIPTION	M.	H/V LOCATION
R1888	7030003860	S.RES ERJ3GE JPW V	B	182.3/54.4
R1889	7030003860	S.RES ERJ3GE JPW V	B	182.7/56.1
R1890	7030003860	S.RES ERJ3GE JPW V	B	162.8/67.5
R1891	7030003860	S.RES ERJ3GE JPW V	B	166.7/72.3
R1892	7030003320	S.RES ERJ3GEYJ 101 V (100)	T	93.2/81.8
R1893	7030003320	S.RES ERJ3GEYJ 101 V (100)	T	100.1/82.1
R1894	7030003320	S.RES ERJ3GEYJ 101 V (100)	T	100.5/72.1
R1895	7030003320	S.RES ERJ3GEYJ 101 V (100)	T	93.2/72.1
R1896	7030003860	S.RES ERJ3GE JPW V	T	82.5/70
R1897	7030003860	S.RES ERJ3GE JPW V	T	81.3/70
R1898	7030003860	S.RES ERJ3GE JPW V	T	80.1/70
R1899	7030003860	S.RES ERJ3GE JPW V	T	78.9/70
R1900	7030003860	S.RES ERJ3GE JPW V	T	79.3/70
R1901	7030003860	S.RES ERJ3GE JPW V	T	81.7/81.6
R1902	7030003860	S.RES ERJ3GE JPW V	B	135.8/69.3
R1903	7030003860	S.RES ERJ3GE JPW V	B	107.9/72.3
R1904	7030003860	S.RES ERJ3GE JPW V	B	110.6/72.8
R1905	7030003860	S.RES ERJ3GE JPW V	B	135.9/81.5
R1906	7030003860	S.RES ERJ3GE JPW V	B	125.4/71.7
R1907	7030003860	S.RES ERJ3GE JPW V	B	104.8/72.4
R1908	7030003860	S.RES ERJ3GE JPW V	B	136.9/71.8
R1909	7030003860	S.RES ERJ3GE JPW V	B	124.9/75.6
R1910	7030003860	S.RES ERJ3GE JPW V	B	127.7/86.6
R1911	7030003860	S.RES ERJ3GE JPW V	T	143.5/89.8
R1912	7030003860	S.RES ERJ3GE JPW V	B	123.5/80.3
R1913	7030003860	S.RES ERJ3GE JPW V	B	123.3/72.7
R1914	7030003860	S.RES ERJ3GE JPW V	B	76.1/78.5
R1921	7030009851	S.RES ERA3YED 271V (270)	T	87.3/73.4
R1922	7030009891	S.RES ERA3YED 151V (150)	T	86.1/70
R1930	7030003320	S.RES ERJ3GEYJ 101 V (100)	T	100.5/79.1
R1931	7030003320	S.RES ERJ3GEYJ 101 V (100)	T	100.5/76
R1932	7030003560	S.RES ERJ3GEYJ 103 V (10 k)	T	95/83.5
R1933	7030003560	S.RES ERJ3GEYJ 103 V (10 k)	T	98.6/83.5
R1934	7030003560	S.RES ERJ3GEYJ 103 V (10 k)	T	98.7/72.1
R1935	7030003560	S.RES ERJ3GEYJ 103 V (10 k)	T	95.1/72.1
R2001	7030003440	S.RES ERJ3GEYJ 102 V (1 k)	T	108.6/70.6
R2002	7030003440	S.RES ERJ3GEYJ 102 V (1 k)	T	104.9/71.7
R2003	7030003620	S.RES ERJ3GEYJ 333 V (33 k)	T	120.2/85
R2004	7030003680	S.RES ERJ3GEYJ 104 V (100 k)	T	118/86.1
R2005	7030003520	S.RES ERJ3GEYJ 472 V (4.7 k)	T	116.5/82.7
R2006	7310005390	S.TRI EVM-3VXS50 BQ3 (472)	T	113.5/86.6
R2007	7030003320	S.RES ERJ3GEYJ 101 V (100)	T	110.7/72.6
R2008	7030003450	S.RES ERJ3GEYJ 122 V (1.2 k)	T	113.3/82.6
R2009	7030003520	S.RES ERJ3GEYJ 472 V (4.7 k)	T	109.9/79.8
R2010	7030003720	S.RES ERJ3GEYJ 224 V (220 k)	T	110.7/75.2
R2011	7030003640	S.RES ERJ3GEYJ 473 V (47 k)	T	116.1/76.6
R2012	7030003720	S.RES ERJ3GEYJ 224 V (220 k)	T	110.7/81.8
R2013	7030003480	S.RES ERJ3GEYJ 222 V (2.2 k)	T	108.8/77.2
R2014	7030003380	S.RES ERJ3GEYJ 331 V (330)	T	109.5/81.8
R2015	7030000340	S.RES MCR10EZHJ 470 (471)	T	112.2/71.6
R2016	7030000340	S.RES MCR10EZHJ 470 (471)	T	114/71.6
R2017	7030003560	S.RES ERJ3GEYJ 103 V (10 k)	T	108.8/76
R2018	7030003660	S.RES ERJ3GEYJ 683 V (68 k)	T	110.7/77.9
R2019	7030003680	S.RES ERJ3GEYJ 104 V (100 k)	T	106.9/76.7
R2020	7510001511	S.TMR NTCG16 4LH 223J	T	108.8/78.6
R2021	7030003320	S.RES ERJ3GEYJ 101 V (100)	B	120.1/80.3
R2022	7030003740	S.RES ERJ3GEYJ 334 V (330 k)	T	120.3/81.2
R2023	7030003320	S.RES ERJ3GEYJ 101 V (100)	T	140.8/87.8
R2024	7030005681	S.RES ERA3YKD 473V (47 k)	T	122.1/81.7
R2025	7030008121	S.RES ERA3YED 682V (6.8 k)	T	122.1/80.5
R2026	7030003320	S.RES ERJ3GEYJ 101 V (100)	T	125.8/86
R2027	7030009861	S.RES ERA3YED 471V (470)	T	125/81.5
R2028	7310005370	S.TRI EVM-3VXS50 BQ2 (471)	T	125.3/78.5
R2029	7030008121	S.RES ERA3YED 682V (6.8 k)	T	121.8/79.3
R2030	7030005681	S.RES ERA3YKD 473V (47 k)	T	121.8/78.1
R2041	7030003860	S.RES ERJ3GE JPW V	T	118.1/87.8
R2042	7310005420	S.TRI EVM-3VXS50 B15 (104)	T	122.3/88.2
R2043	7030003560	S.RES ERJ3GEYJ 103 V (10 k)	T	129.1/84.3
R2044	7030003560	S.RES ERJ3GEYJ 103 V (10 k)	T	128.9/86.1
R2045	7030003660	S.RES ERJ3GEYJ 474 V (470 k)	T	130.6/83
R2046	7030003380	S.RES ERJ3GEYJ 331 V (330)	T	139.9/81
R2048	7030003660	S.RES ERJ3GEYJ 683 V (68 k)	B	118.3/80.3
R2051	7030009920	S.RES ERJ3GEYJ 335 V (3.3 M)	T	140.4/83.4
R2052	7030003600	S.RES ERJ3GEYJ 223 V (22 k)	B	145.1/85.3
R2053	7030003820	S.RES ERJ3GEYJ 155 V (1.5 M)	T	142.3/84.1
R2054	7030003840	S.RES ERJ3GEYJ 225 V (2.2 M)		

[MAIN UNIT]

REF NO.	ORDER NO.	DESCRIPTION	M.	H/V LOCATION
C11	4030006880	S.CER C1608 JB 1H 472K-T	B	50.8/72.2
C21	4030006880	S.CER C1608 JB 1H 472K-T	B	43.6/80.2
C31	4030006880	S.CER C1608 JB 1H 472K-T	B	32.2/80.2
C101	4030011600	S.CER C1608 JB 1E 104K-T	T	131.6/93.4
C161	4510008510	S.ELE EEE1CA471P	T	44.7/59.5
C162	4510008540	S.ELE EEE1CA100SR	T	47.9/67.5
C163	4030011600	S.CER C1608 JB 1E 104K-T	B	44/55
C164	4510008500	S.ELE EEE1CA101WP	T	53.8/54.7
C171	4510008550	S.ELE EEE1HA010SR	T	43.3/51.7
C172	4030011600	S.CER C1608 JB 1E 104K-T	B	52.3/44.4
C173	4030007120	S.CER C1608 CH 1H 820J-T	B	49.8/47.7
C174	4510008550	S.ELE EEE1HA010SR	T	43.5/46.9
C175	4510008550	S.ELE EEE1HA010SR	T	54/47.6
C176	4510008540	S.ELE EEE1CA100SR	T	43.2/42.1
C177	4510008540	S.ELE EEE1CA100SR	T	55.3/40.7
C178	4510008550	S.ELE EEE1HA010SR	T	54.6/35.4
C179	4510008550	S.ELE EEE1HA010SR	T	49.3/32.6
C191	4510008550	S.ELE EEE1HA010SR	T	65.1/69.8
C192	4030017840	S.CER C2012 CH 1H 222J-T	B	61.6/72.6
C193	4030019090	S.CER C2012 JB 1C 225M-T	T	66.9/76
C194	4510008540	S.ELE EEE1CA100SR	T	55.4/70.6
C195	4510008550	S.ELE EEE1HA010SR	T	60.2/67.3
C196	4510008540	S.ELE EEE1CA100SR	T	55.6/76.1
C197	4510008550	S.ELE EEE1HA010SR	T	63/82.8
C198	4510008540	S.ELE EEE1CA100SR	T	58.2/82.8
C201	4510008550	S.ELE EEE1HA010SR	T	43.2/37.3
C202	4030011600	S.CER C1608 JB 1E 104K-T	B	45.8/36.6
C211	4030011600	S.CER C1608 JB 1E 104K-T	B	51.6/24
C212	4030011600	S.CER C1608 JB 1E 104K-T	B	46.3/29.8
C213	4030012600	S.CER C2012 JB 1A 105M-T	B	41.2/22.6
C221	4030007170	S.CER C1608 CH 1H 221J-T	T	47.7/25.8
C222	4030011600	S.CER C1608 JB 1E 104K-T	T	51.6/25.8
C223	4510008500	S.ELE EEE1CA101WP	T	56.1/25.9
C224	4510008540	S.ELE EEE1CA100SR	T	49.8/20.4
C225	4510008500	S.ELE EEE1CA101WP	T	43.3/20.7
C226	4030011600	S.CER C1608 JB 1E 104K-T	T	51.5/23.9
C231	4510008540	S.ELE EEE1CA100SR	T	39.9/70.5
C232	4030012600	S.CER C2012 JB 1A 105M-T	T	45.9/74.5
C233	4030012600	S.CER C2012 JB 1A 105M-T	T	45.8/78.9
C234	4510008540	S.ELE EEE1CA100SR	T	40.3/83.3
C235	4030012600	S.CER C2012 JB 1A 105M-T	T	40.1/79.3
C236	4510008540	S.ELE EEE1CA100SR	T	30.7/83.2
C237	4510008540	S.ELE EEE1CA100SR	T	35.5/81.2
C241	4030010760	S.CER C1608 CH 1H 331J-T	B	36.4/64.7
C242	4510008540	S.ELE EEE1CA100SR	T	37.2/65.2
C243	4510008540	S.ELE EEE1CA100SR	T	50.1/72.4
C261	4030006880	S.CER C1608 JB 1H 472K-T	B	19/80.5
C262	4030006880	S.CER C1608 JB 1H 472K-T	B	14.7/778
C271	4510008180	ELE EUUFC1E102S		
C272	4030011600	S.CER C1608 JB 1E 104K-T	B	18.6/58.4
C281	4510008180	ELE EUUFC1E102S		
C282	4030009000	S.CER C2012 JB 1C 224K-T	T	5.3/58.3
C283	4510008500	S.ELE EEE1CA101WP	T	9.8/43.9
C284	4510008550	S.ELE EEE1HA010SR	T	5.2/37.8
C285	4510008550	S.ELE EEE1HA010SR	T	10.6/37.5
C286	4510008550	S.ELE EEE1HA010SR	T	16.8/43
C287	4510008190	ELE EUUFC1E222S		
C288	4030011600	S.CER C1608 JB 1E 104K-T	B	18.7/69.5
C291	4030011600	S.CER C1608 JB 1E 104K-T	B	22.7/35.7
C292	4030008950	S.CER C2012 JB 1C 823K-T	B	16.8/37.3
C293	4030008880	S.CER C1608 JB 1H 223K-T	B	16.6/33.9
C301	4030008950	S.CER C2012 JB 1C 823K-T	B	28.9/30.8
C302	4030011600	S.CER C1608 JB 1E 104K-T	B	32.2/28.6
C311	4510008500	S.ELE EEE1CA101WP	T	32.6/31.8
C313	4510008550	S.ELE EEE1HA010SR	T	24.4/34.3
C314	4510008540	S.ELE EEE1CA100SR	T	26.1/23
C315	4510008540	S.ELE EEE1CA100SR	T	21.3/23
C316	4510008540	S.ELE EEE1CA100SR	T	17.6/32.8
C317	4510008550	S.ELE EEE1HA010SR	T	17.3/26.9
C318	4510008540	S.ELE EEE1CA100SR	T	20.2/38.1
C319	4030012600	S.CER C2012 JB 1A 105M-T	B	33/37.8
C320	4030012600	S.CER C2012 JB 1A 105M-T	B	36.2/29.5
C331	4030008650	S.CER C1608 JB 1H 332K-T	B	19.5/21.4
C332	4030019090	S.CER C2012 JB 1C 225M-T	T	18.9/18.3
C333	4510008540	S.ELE EEE1CA100SR	T	24.3/17.7
C334	4510008540	S.ELE EEE1CA100SR	T	15.8/21.5
C351	4030011600	S.CER C1608 JB 1E 104K-T	B	18.9/14.4
C354	4550007480	S.TAN F930J106MAABMA	B	32.8/15.7
C355	4550007480	S.TAN F930J106MAABMA	B	29/13.7
C361	4030011600	S.CER C1608 JB 1E 104K-T	T	36/18.6
C400	4030006880	S.CER C1608 JB 1H 472K-T	T	19.2/4.5
C426	4510008800	S.ELE EEE1EA100SR	T	65.1/46.5
C427	4030011600	S.CER C1608 JB 1E 104K-T	B	64.7/49.8
C428	4030006880	S.CER C1608 JB 1H 472K-T	B	66.3/49.8
C429	4030006880	S.CER C1608 JB 1H 472K-T	B	67.9/49.8
C430	4030006880	S.CER C1608 JB 1H 472K-T	B	67.9/49.8
C464	4510008540	S.ELE EEE1CA100SR	T	43.2/32.5
C701	4030011600	S.CER C1608 JB 1E 104K-T	B	139/99.5
C702	4030011600	S.CER C1608 JB 1E 104K-T	B	124/99.5
C703	4030011600	S.CER C1608 JB 1E 104K-T	T	131.6/92.1
C711	4030006880	S.CER C1608 JB 1H 472K-T	B	163.7/77.8
C721	4030006880	S.CER C1608 JB 1H 472K-T	B	54.9/77.5
C722	4010005380	CER HMI3SJ YB 472K 500V		
C723	4030006880	S.CER C1608 JB 1H 472K-T	B	90.6/90.5
C724	4030006880	S.CER C1608 JB 1H 472K-T	B	90.6/93.8
C731	4030006880	S.CER C1608 JB 1H 472K-T	B	63.8/90.8
C732	4030006880	S.CER C1608 JB 1H 472K-T	B	62.8/85.2
C733	4030006880	S.CER C1608 JB 1H 472K-T	B	52.1/98.6
C734	4030006880	S.CER C1608 JB 1H 472K-T	B	42.2/97.7
C735	4030006880	S.CER C1608 JB 1H 472K-T	B	53.4/81.2
C736	4030006880	S.CER C1608 JB 1H 472K-T	B	50.9/81.9
C737	4030006880	S.CER C1608 JB 1H 472K-T	B	47.1/77.5
C741	4030006880	S.CER C1608 JB 1H 472K-T	B	36.4/88.6
C742	4030006880	S.CER C1608 JB 1H 472K-T	B	28.7/97.8

[MAIN UNIT]

REF NO.	ORDER NO.	DESCRIPTION	M.	H/V LOCATION
C743	4030006880	S.CER C1608 JB 1H 472K-T	B	33.1/84.3
C745	4510008540	S.ELE EEE1CA100SR	T	25.9/83.3
C746	4030011600	S.CER C1608 JB 1E 104K-T	B	28.2/85.2
C747	4030011600	S.CER C1608 JB 1E 104K-T	B	28.1/78.6
C748	4510008540	S.ELE EEE1CA100SR	T	21.1/83.3
C761	4510008500	S.ELE EEE1CA101WP	T	46.8/83.4
C762	4510008540	S.ELE EEE1CA100SR	T	53.3/81.5
C842	4030006880	S.CER C1608 JB 1H 472K-T	T	35.7/61.5
C843	4030006880	S.CER C1608 JB 1H 472K-T	T	35/56.3
C844	4030006880	S.CER C1608 JB 1H 472K-T	T	37/58.5
C851	4030006880	S.CER C1608 JB 1H 472K-T	B	72.1/71.7
C852	4030006880	S.CER C1608 JB 1H 472K-T	B	72.1/73.5
C853	4030006880	S.CER C1608 JB 1H 472K-T	B	72.1/75.3
C854	4030006880	S.CER C1608 JB 1H 472K-T	B	72.1/77.1
C855	4030006880	S.CER C1608 JB 1H 472K-T	B	72.2/79.8
C911	4030006880	S.CER C1608 JB 1H 472K-T	B	159/19.6
C912	4030006880	S.CER C1608 JB 1H 472K-T	B	168.2/21
C913	4030006880	S.CER C1608 JB 1H 472K-T	B	158/21
C914	4030006880	S.CER C1608 JB 1H 472K-T	B	168.2/23
C915	4030006880	S.CER C1608 JB 1H 472K-T	B	154.4/24.3
C916	4030006880	S.CER C1608 JB 1H 472K-T	B	168.2/25
C917	4030006880	S.CER C1608 JB 1H 472K-T	B	154.4/26.1
C918	4030006880	S.CER C1608 JB 1H 472K-T	B	168.2/27
C919	4030006880	S.CER C1608 JB 1H 472K-T	B	154.4/27.9
C921	4030006880	S.CER C1608 JB 1H 472K-T	B	168.3/31
C922	4030006880	S.CER C1608 JB 1H 472K-T	B	168.2/33
C923	4030006880	S.CER C1608 JB 1H 472K-T	B	154.8/34.1
C924	4030006880	S.CER C1608 JB 1H 472K-T	B	168.2/35
C925	4030006880	S.CER C1608 JB 1H 472K-T	B	154.8/35.9
C928	4030006880	S.CER C1608 JB 1H 472K-T	T	166.1/41.9
C943	4030006880	S.CER C1608 JB 1H 472K-T	B	12.9/28.1
C944	4030006880	S.CER C1608 JB 1H 472K-T	B	3.2/29.1
C974	4030006880	S.CER C1608 JB 1H 472K-T	B	180.4/26
C975	4030006880	S.CER C1608 JB 1H 472K-T	B	172.1/27
C978	4030006880	S.CER C1608 JB 1H 472K-T	B	180.4/30
C979	4030006880	S.CER C1608 JB 1H 472K-T	B	172.1/31
C981	4030006880	S.CER C1608 JB 1H 472K-T	B	172.1/33
C982	4030006880	S.CER C1608 JB 1H 472K-T	B	172.1/35
C987	4030006880	S.CER C1608 JB 1H 472K-T	B	172.1/39
C991	4030006880	S.CER C1608 JB 1H 472K-T	T	166.1/39.3
C1001	4510007130	S.ELE EEFCD OJ 470R	B	142.2/14.7
C1002	4510007130	S.ELE EEFCD OJ 470R	B	137.4/14.7
C1003	4030011600	S.CER C1608 JB 1E 104K-T	B	120.5/23
C1004	4030011600	S.CER C1608 JB 1E 104K-T	B	119.7/39
C1005	4030011600	S.CER C1608 JB 1E 104K-T	B	124.5/21.6
C1006	4030011600	S.CER C1608 JB 1E 104K-T	B	123.7/41.1
C1007	4030011600	S.CER C1608 JB 1E 104K-T	B	120.5/34.7
C1008	4030011600	S.CER C1608 JB 1E 104K-T	B	120.5/28.2
C1009	4030011600	S.CER C1608 JB 1E 104K-T	B	120.5/36
C1010	4030011600	S.CER C1608 JB 1E 104K-T	B	127.4/21.6
C1011	4030011600	S.CER C1608 JB 1E 104K-T	B	128.6/41.5
C1012	4030011600	S.CER C1608 JB 1E 104K-T	B	130/21
C1013	4030011600	S.CER C1608 JB 1E 104K-T	B	134.8/21.5
C1014	4030011600	S.CER C1608 JB 1E 104K-T	B	134.9/42.3
C1015	4030011600	S.CER C1608 JB 1E 104K-T	B	140.6/26.8
C1016	4030011600	S.CER C1608 JB 1E 104K-T	B	140.5/28.4
C1017	4030011600	S.CER C1608 JB 1E 104K-T	B	145.3/33
C1018	4030011600	S.CER C1608 JB 1E 104K-T	B	136.4/42.3
C1019	4030011600	S.CER C1608 JB 1E 104K-T	B	138/21.5
C1020	4030011600	S.CER C1608 JB 1E 104K-T	B	138/42.3
C1021	4030011600	S.CER C1608 JB 1E 104K-T	B	140.6/25.2
C1022	4030011600	S.CER C1608 JB 1E 104K-T	B	140.5/39.5
C1023	4030016930	S.CER ECJ0EB1A104K	B	128.5/29.1
C1024	4030016930	S.CER ECJ0EB1A104K	B	128.5/30.1
C1025	4030016930	S.CER ECJ0EB1A104K	B	128.5/31.1
C1026	4030016930	S.CER ECJ0EB1A104K	B	128.5/32.1
C1027	4030016930	S.CER ECJ0EB1A104K	B	128.5/33.1
C1028	4030016930	S.CER ECJ0EB1A104K	B	128.5/34.1
C1029	4030016930	S.CER ECJ0EB1A104K	B	133.4/29.1
C1030	4030016930	S.CER ECJ0EB1A104K	B	133.4/30.1
C1031	4030016930	S.CER ECJ0EB1A104K	B	133.4/31.1
C1032	4030016930	S.CER ECJ0EB1A104K	B	133.4/32.1
C1033	4030016930	S.CER ECJ0EB1A104K	B	133.4/33.1
C1034	4030016930	S.CER ECJ0EB1A104K	B	133.4/34.1
C1035	4030016930	S.CER ECJ0EB1A104K	B	132.2/29.1
C1036	4030016930	S.CER ECJ0EB1A104K	B	131.3/30.7
C1037	4030016930	S.CER ECJ0EB1A104K	B	130.3/29.1
C1038	4030016930	S.CER ECJ0EB1A104K	B	12

[MAIN UNIT]

REF NO.	ORDER NO.	DESCRIPTION	M.	H/V LOCATION
C1223	4550007500	S.TAN F931D106MBABMA	B	88.4/13.6
C1224	4030011600	S.CER C1608 JB 1E 104K-T	T	96/14.4
C1225	4030018580	S.CER C1608 CH 1H 821J-T	T	94.7/18.1
C1226	4030007050	S.CER C1608 CH 1H 220J-T	T	90.5/22.4
C1227	4030011600	S.CER C1608 JB 1E 104K-T	T	95.5/16.2
C1231	4550007500	S.TAN F931D106MBABMA	B	102.6/11.2
C1232	4030011600	S.CER C1608 JB 1E 104K-T	T	98.4/9.1
C1233	4550007500	S.TAN F931D106MBABMA	B	110.8/9.7
C1234	4030011600	S.CER C1608 JB 1E 104K-T	T	108.2/6.2
C1235	4030018580	S.CER C1608 CH 1H 821J-T	T	105.6/8.6
C1236	4030007050	S.CER C1608 CH 1H 220J-T	B	101.5/6.8
C1237	4030011600	S.CER C1608 JB 1E 104K-T	T	106.3/6.7
C1241	4550007520	S.TAN F931A106MAABMA	B	106.7/7.8
C1251	4550007480	S.TAN F930J106MAABMA	B	97.5/16.4
C1252	4550007480	S.TAN F930J106MAABMA	B	103.3/17.1
C1253	4030011810	S.CER C1608 JB 1A 224K-T	B	99.9/16.8
C1254	4030011810	S.CER C1608 JB 1A 224K-T	T	98.1/15
C1255	4030017840	S.CER C2012 CH 1H 222J-T	T	103.5/14.1
C1256	4550007480	S.TAN F930J106MAABMA	B	111.2/15.6
C1257	4030011600	S.CER C1608 JB 1E 104K-T	T	107.5/14.3
C1261	4550007480	S.TAN F930J106MAABMA	B	98.5/23.3
C1262	4550007480	S.TAN F930J106MAABMA	B	103.3/22.6
C1263	4030009000	S.CER C2012 JB 1C 224K-T	T	99.5/27.5
C1264	4030009000	S.CER C2012 JB 1C 224K-T	T	100.8/29.2
C1265	4030017840	S.CER C2012 CH 1H 222J-T	T	103.6/27.4
C1266	4030011600	S.CER C1608 JB 1E 104K-T	T	107.4/27.2
C1267	4550007520	S.TAN F931A106MAABMA	B	108.6/25.2
C1301	4550007480	S.TAN F930J106MAABMA	B	108.6/27.7
C1311	4030017810	S.CER C1608 CH 1H 102J-T	B	92.7/26.5
C1312	4030007050	S.CER C1608 CH 1H 220J-T	T	96.2/22.8
C1313	4030011600	S.CER C1608 JB 1E 104K-T	T	87.1/24.5
C1314	4550007520	S.TAN F931A106MAABMA	B	86.2/25.4
C1315	4030011600	S.CER C1608 JB 1E 104K-T	T	97/25.4
C1316	4550007500	S.TAN F931D106MBABMA	B	95.6/24.1
C1317	4030011600	S.CER C1608 JB 1E 104K-T	T	87.9/22.4
C1318	4550007500	S.TAN F931D106MBABMA	B	90/25.1
C1321	4030017810	S.CER C1608 CH 1H 102J-T	T	109.5/30.5
C1322	4030007050	S.CER C1608 CH 1H 220J-T	T	113.8/32.4
C1323	4030011600	S.CER C1608 JB 1E 104K-T	T	103.4/30.5
C1324	4550007520	S.TAN F931A106MAABMA	B	104.2/32.1
C1325	4030011600	S.CER C1608 JB 1E 104K-T	T	113.8/35.2
C1326	4550007500	S.TAN F931D106MBABMA	B	113.7/32.1
C1327	4030011600	S.CER C1608 JB 1E 104K-T	T	104.6/30.5
C1328	4550007500	S.TAN F931D106MBABMA	B	107.2/32.1
C1330	4030007170	S.CER C1608 CH 1H 221J-T	B	83.7/26.6
C1331	4030007050	S.CER C1608 CH 1H 220J-T	T	101.9/35.5
C1333	4030011600	S.CER C1608 JB 1E 104K-T	T	101.9/31.9
C1334	4550007500	S.TAN F931D106MBABMA	B	100/34.1
C1335	4030011600	S.CER C1608 JB 1E 104K-T	T	92.7/32.4
C1336	4550007500	S.TAN F931D106MBABMA	B	97.7/30.1
C1351	4030011600	S.CER C1608 JB 1E 104K-T	T	75.1/13.9
C1352	4550007500	S.TAN F931D106MBABMA	B	74.3/16.1
C1353	4030011600	S.CER C1608 JB 1E 104K-T	T	79/21.3
C1354	4550007500	S.TAN F931D106MBABMA	B	81.8/16.2
C1355	4030007090	S.CER C1608 CH 1H 470J-T	B	77.3/15.2
C1361	4030011600	S.CER C1608 JB 1E 104K-T	B	79.5/7
C1362	4510008540	S.ELE EEE1CA100SR	T	79.6/7.9
C1363	4030011600	S.CER C1608 JB 1E 104K-T	B	73.4/10.6
C1401	4550007480	S.TAN F930J106MAABMA	B	81.8/26.3
C1402	4030011600	S.CER C1608 JB 1E 104K-T	T	82.3/24.8
C1403	4030011810	S.CER C1608 JB 1A 224K-T	T	82.3/26.4
C1404	4550007520	S.TAN F931A106MAABMA	B	79.5/32.8
C1405	4030011600	S.CER C1608 JB 1E 104K-T	B	80.7/31.1
C1406	4030017840	S.CER C2012 CH 1H 222J-T	B	79.8/27.6
C1407	4030011600	S.CER C1608 JB 1E 104K-T	T	82.3/29
C1408	4550007480	S.TAN F930J106MAABMA	B	76.7/27.5
C1421	4550007480	S.TAN F930J106MAABMA	B	74.4/22.9
C1422	4030011600	S.CER C1608 JB 1E 104K-T	T	72.2/23.9
C1423	4030011810	S.CER C1608 JB 1A 224K-T	T	70.7/25.1
C1424	4030017840	S.CER C2012 CH 1H 222J-T	B	71.9/27.1
C1425	4030011600	S.CER C1608 JB 1E 104K-T	T	70.5/29.3
C1426	4550007520	S.TAN F931A106MAABMA	B	74.2/26.4
C1431	4030011600	S.CER C1608 JB 1E 104K-T	T	122.5/46.9
C1441	4030011600	S.CER C1608 JB 1E 104K-T	T	119.4/48.2
C1442	4030006860	S.CER C1608 JB 1H 102K-T	B	121.2/47
C1451	4030006860	S.CER C1608 JB 1H 102K-T	T	63.5/22.4
C1453	4030011600	S.CER C1608 JB 1E 104K-T	T	65.4/21.7
C1454	4550007480	S.TAN F930J106MAABMA	B	65.7/16.9
C1455	4030011600	S.CER C1608 JB 1E 104K-T	B	64.4/23.3
C1456	4550007480	S.TAN F930J106MAABMA	B	69.4/38.9
C1461	4030006860	S.CER C1608 JB 1H 102K-T	T	68.5/22.4
C1463	4030011600	S.CER C1608 JB 1E 104K-T	T	66.6/21.7
C1464	4550007480	S.TAN F930J106MAABMA	B	69.5/27.4
C1472	4550007660	S.TAN F931E105MAABMA	B	71.8/38.9
C1481	4030011600	S.CER C1608 JB 1E 104K-T	T	69.4/27.4
C1482	4550007520	S.TAN F931A106MAABMA	B	66.4/22.1
C1483	4030011600	S.CER C1608 JB 1E 104K-T	T	66/32.3
C1484	4550007500	S.TAN F931D106MBABMA	T	70.2/38.3
C1501	4030011600	S.CER C1608 JB 1E 104K-T	T	113.6/45.9
C1502	4550007520	S.TAN F931A106MAABMA	B	108.9/48.4
C1503	4030011600	S.CER C1608 JB 1E 104K-T	T	102.1/43.7
C1504	4550007520	S.TAN F931A106MAABMA	B	108.9/46
C1505	4550007520	S.TAN F931A106MAABMA	B	105.1/43.1
C1506	4030011600	S.CER C1608 JB 1E 104K-T	T	102.3/44.9
C1507	4030011600	S.CER C1608 JB 1E 104K-T	T	102.9/41.9
C1512	4030018610	S.CER C1608 CH 1H 182J-T	B	94.8/42.5
C1513	4030018610	S.CER C1608 CH 1H 182J-T	B	101.7/37.7
C1514	4030007050	S.CER C1608 CH 1H 220J-T	T	90.6/39.5
C1522	4030018610	S.CER C1608 CH 1H 182J-T	B	94.8/46.4
C1523	4030018610	S.CER C1608 CH 1H 182J-T	B	101.6/43.9
C1524	4030007050	S.CER C1608 CH 1H 220J-T	T	90.6/45.9
C1531	4030017800	S.CER C1608 CH 1H 561J-T	B	87.5/38
C1532	4030017800	S.CER C1608 CH 1H 561J-T	B	92/36.1
C1533	4030007050	S.CER C1608 CH 1H 220J-T	B	84.7/36.6

[MAIN UNIT]

REF NO.	ORDER NO.	DESCRIPTION	M.	H/V LOCATION
C1541	4030011600	S.CER C1608 JB 1E 104K-T	T	91.9/38.7
C1542	4550007500	S.TAN F931D106MBABMA	B	94.8/36.6
C1543	4030011600	S.CER C1608 JB 1E 104K-T	T	97.9/43.8
C1544	4550007500	S.TAN F931D106MBABMA	B	108.1/38.7
C1551	4030011600	S.CER C1608 JB 1E 104K-T	T	91.9/45.3
C1552	4550007500	S.TAN F931D106MBABMA	B	93.8/51.5
C1553	4030011600	S.CER C1608 JB 1E 104K-T	T	101.4/48.3
C1554	4550007500	S.TAN F931D106MBABMA	B	103.8/51.2
C1561	4030011600	S.CER C1608 JB 1E 104K-T	B	87.4/34.7
C1562	4550007500	S.TAN F931D106MBABMA	B	88.5/32.1
C1563	4030011600	S.CER C1608 JB 1E 104K-T	T	92.7/36.9
C1564	4550007500	S.TAN F931D106MBABMA	T	89.2/30.2
C1571	4030019130	S.CER C2012 CH 1H 562JT-NS	T	108.5/48.7
C1572	4030018580	S.CER C1608 CH 1H 821J-T	B	107.8/57.5
C1573	4030018580	S.CER C1608 CH 1H 821J-T	B	105.3/56
C1574	4030011600	S.CER C1608 JB 1E 104K-T	B	111.6/53.7
C1575	4510008540	S.ELE EEE1CA100SR	T	111.9/55.2
C1576	4030011600	S.CER C1608 JB 1E 104K-T	T	102.6/56.8
C1577	4510008540	S.ELE EEE1CA100SR	T	99.5/55.2
C1578	4030007050	S.CER C1608 CH 1H 220J-T	T	106/60
C1601	4510008540	S.ELE EEE1CA100SR	T	94.2/54.3
C1602	4030011600	S.CER C1608 JB 1E 104K-T	T	89.7/48.4
C1603	4030011600	S.CER C1608 JB 1E 104K-T	T	90.5/42.1
C1604	4030011600	S.CER C1608 JB 1E 104K-T	T	78.6/38.4
C1605	4510008540	S.ELE EEE1CA100SR	T	87.8/53.9
C1611	4030019130	S.CER C2012 CH 1H 562JT-NS	T	76.5/39.5
C1612	4030018580	S.CER C1608 CH 1H 821J-T	B	81.5/38.7
C1613	4030018580	S.CER C1608 CH 1H 821J-T	B	79.1/39.7
C1621	4030018620	S.CER C1608 CH 1H 222J-T	T	76.7/43.2
C1622	4030011600	S.CER C1608 JB 1E 104K-T	B	70.8/47.3
C1623	4510008540	S.ELE EEE1CA101WP	T	71.6/46.1
C1624	4030017870	S.CER C1608 CH 1H 681J-T	B	73.8/47.3
C1625	4030017870	S.CER C1608 CH 1H 681J-T	B	77.6/50.3
C1631	4510008540	S.ELE EEE1CA100SR	T	81.5/53.9
C1632	4030011600	S.CER C1608 JB 1E 104K-T	B	84.2/49.1
C1641	4030011600	S.CER C1608 JB 1E 104K-T	B	81.8/40.5
C1642	4510008540	S.ELE EEE1CA100SR	T	77.8/47.2
C1651	4030011600	S.CER C1608 JB 1E 104K-T	B	162.6/12.9
C1652	4510008540	S.ELE EEE1CA100SR	T	153.8/3.4
C1653	4030011600	S.CER C1608 JB 1E 104K-T	B	152.5/3.9
C1654	4030017490	S.CER C1608 JB 1A 105K-T	B	161.8/4.9
C1655	4550007460	S.TAN F930G107MBABMA	B	149.6/11.8
C1801	4030011600	S.CER C1608 JB 1E 104K-T	B	175.5/50.1
C1841	4030011600	S.CER C1608 JB 1E 104K-T	B	175/62.8
C1921	4030011600	S.CER C1608 JB 1E 104K-T	T	86.1/77.8
C1922	4030011600	S.CER C1608 JB 1E 104K-T	T	86.1/73.4
C1930	4030011600	S.CER C1608 JB 1E 104K-T	T	101.9/79
C1931	4030011600	S.CER C1608 JB 1E 104K-T	T	101.9/76
C2001	4030011600	S.CER C1608 JB 1E 104K-T	B	112.9/72.6
C2002	4030011600	S.CER C1608 JB 1E 104K-T	T	118.2/73.2
C2003	4030011600	S.CER C1608 JB 1E 104K-T	T	140.8/86.6
C2004	4030011600	S.CER C1608 JB 1E 104K-T	T	127/85.9
C2045	4030006860	S.CER C1608 JB 1H 102K-T	T	130.6/81.8
C2051	4030006860	S.CER C1608 JB 1H 102K-T	T	139.2/83.4
C2053	4030012600	S.CER C2012 JB 1A 105M-T	B	143.8/74.3
C2056	4030012600	S.CER C2012 JB 1A 105M-T	B	139.2/74.2
C2057	4030012600	S.CER C2012 JB 1A 105M-T	B	139.9/72.3
C2058	4510008540	S.ELE EEE1CA100SR	T	142.3/72
C2059	4030009530	S.CER C1608 CH 1H 030B-T	T	121.4/75
C2060	4030011600	S.CER C1608 JB 1E 104K-T	T	138.6/77.2
C2061	4030012600	S.CER C2012 JB 1A 105M-T	B	139.6/76.2
RL261	6330001860	RLY UA2-12NU		
RL721	6330000540	RLY 2-1419131-2 (OMR-109F)		
CP2041	6910009670	S.CHK HK3-S-T	T	150.7/72.8
CP2051	6910009670	S.CHK HK3-S-T	T	123.6/71
J701	6510026830	CNR AT29LV040A-15TU		
J702	6510026830	CNR AT29LV040A-15TU		
J711	6510023740	CNR LGR4609-7000		
J721	6450001130	CNR JJP2042-01-110		
J731	6510023671	CNR TCS4480-0141577		
J741	6510023661	CNR TCS4470-0141577		
J751	6510023720	CNR LGY6501-0600C		
J761	6510023750	CNR 01K1971-10 (I)		
J762	6510007020	CNR TMP-J01X-V6		
J801	6510007020	C		

[MAIN UNIT]

REF NO.	ORDER NO.	DESCRIPTION	M.	H/V LOCATION
EP752	6910014730	S.BEA MPZ2012S331A-T	T	8.9/95.9
EP811	6910014690	S.BEA MPZ1608S221A-T	T	32.2/5.3
EP812	6910014690	S.BEA MPZ1608S221A-T	T	30.8/5.4
EP813	6910014690	S.BEA MPZ1608S221A-T	T	26.2/5.3
EP814	6910012350	S.BEA MMZ1608Y 102BT	T	24.2/5.3
EP815	6910014690	S.BEA MPZ1608S221A-T	T	22.2/5.4
EP816	6910014690	S.BEA MPZ1608S221A-T	T	19.4/16.6
EP842	6910014690	S.BEA MPZ1608S221A-T	T	35/59.6
EP843	6910014690	S.BEA MPZ1608S221A-T	T	35/57.6
EP851	6910012350	S.BEA MMZ1608Y 102BT	B	75.3/71.7
EP852	6910012350	S.BEA MMZ1608Y 102BT	B	75.3/73.5
EP853	6910012350	S.BEA MMZ1608Y 102BT	B	75.3/75.3
EP854	6910014690	S.BEA MPZ1608S221A-T	B	75.3/77.1
EP855	6910012350	S.BEA MMZ1608Y 102BT	B	75.3/80.1
EP941	6910012350	S.BEA MMZ1608Y 102BT	B	10/31
EP942	6910012350	S.BEA MMZ1608Y 102BT	T	4.8/30
EP943	6910012350	S.BEA MMZ1608Y 102BT	B	9.9/29
EP944	6910012350	S.BEA MMZ1608Y 102BT	T	4.8/28
EP954	6910012350	S.BEA MMZ1608Y 102BT	B	10/19.3
EP987	6910012350	S.BEA MMZ1608Y 102BT	T	172.1/39
EP991	6910012350	S.BEA MMZ1608Y 102BT	T	166.1/38
EP992	6910012350	S.BEA MMZ1608Y 102BT	T	166.1/40.6
EP1001	6910014690	S.BEA MPZ1608S221A-T	B	119.2/17
EP1251	6910014690	S.BEA MPZ1608S221A-T	T	112.3/8.1
EP1401	6910014690	S.BEA MPZ1608S221A-T	T	85/31
EP1498	6910014690	S.BEA MPZ1608S221A-T	T	103.6/71.7
EP1651	6910014690	S.BEA MPZ1608S221A-T	B	162.6/11.1
EP1911	6910014690	S.BEA MPZ1608S221A-T	B	120.1/83.4

[PLL UNIT]

REF NO.	ORDER NO.	DESCRIPTION	M.	H/V LOCATION
IC1	1130011530	S.IC CD74HC4094M96	B	151.5/16.9
IC2	1130009691	S.IC TC74HCT7007AF (F)	T	152.7/17.7
IC51	1180001251	S.IC TA7808F (TE16L,Q)	T	164.8/92.2
IC61	1180000421	S.IC TA78L05F (TE12R,F)	B	168.5/68.5
IC101	1190002101	S.IC AD9951YSVZ	T	101.2/27.2
IC102	1130010560	S.IC SN74AHC244PWR	T	113/33
IC103	1180003190	S.REG uPD120N33TA-E1-A	T	111.4/40.1
IC104	1180003200	S.REG uPD120N18TA-E1-A	T	103.2/40.1
IC201	1130013270	S.IC ADF4116BRUZ	T	149.5/36.7
IC501	1140007881	S.IC TC190G08EFG0046JDZ/SC1246A	T	50.1/42.7
IC503	1130003831	S.IC TC7S04F (TE85R,F)	T	38.5/43.1
IC602	1130006441	S.IC TC7S08F (TE85R,F)	T	98.2/50.6
IC651	1140007881	S.IC TC190G08EFG0046JDZ/SC1246A	T	12.7/71
IC652	1130003831	S.IC TC7S04F (TE85R,F)	T	10.2/58.4
IC1651	1130003831	S.IC TC7S04F (TE85R,F)	T	30.7/26.5
IC1652	1140007881	S.IC TC190G08EFG0046JDZ/SC1246A	T	16.7/22.8
IC1701	1130006441	S.IC TC7S08F (TE85R,F)	T	30.4/20.3
Q1	1590001050	S.TR DTC114TUA T106	B	158.2/17.2
Q30	1530002060	S.TR 2SC4081 T106 R	B	74.5/32.1
Q41	1590000680	S.TR DTC114EUA T106	T	142.8/8.9
Q101	1530003151	S.TR 2SC4673D-TD-E	T	89.7/30.3
Q151	1530002060	S.TR 2SC4081 T106 R	B	130.9/43.8
Q201	1590000680	S.TR DTC114EUA T106	T	154.3/38.1
Q220	1560000331	S.FET 2SK210-GR (TE85R,F)	T	150.8/83
Q230	1560000331	S.FET 2SK210-GR (TE85R,F)	T	138.3/83
Q240	1560000331	S.FET 2SK210-GR (TE85R,F)	T	125.8/83
Q250	1560000331	S.FET 2SK210-GR (TE85R,F)	T	113.3/83
Q260	1560000331	S.FET 2SK210-GR (TE85R,F)	T	100.8/83
Q270	1560000331	S.FET 2SK210-GR (TE85R,F)	T	88.9/83
Q280	1590000680	S.TR DTC114EUA T106	T	150.3/92.8
Q281	1590000680	S.TR DTC114EUA T106	T	137.8/92.8
Q282	1590000680	S.TR DTC114EUA T106	T	125.3/92.8
Q283	1590000680	S.TR DTC114EUA T106	T	112.8/92.8
Q284	1590000680	S.TR DTC114EUA T106	T	100.3/92.8
Q285	1590000680	S.TR DTC114EUA T106	T	88.3/92.8
Q301	1530003431	S.TR 2SC5226-4-TL-E	T	154.6/102.6
Q302	1530003431	S.TR 2SC5226-4-TL-E	B	141.5/99.6
Q303	1530003431	S.TR 2SC5226-4-TL-E	B	158/101.7
Q341	1590000680	S.TR DTC114EUA T106	T	148/96.8
Q351	1580000751	S.FET 3SK294 (TE85L,F)	T	127.8/103.2
Q352	1530003431	S.TR 2SC5226-4-TL-E	B	121/99.6
Q441	1590000680	S.TR DTC114EUA T106	T	111/97
Q502	1590000680	S.TR DTC114EUA T106	T	63.3/52.9
Q540	1530002060	S.TR 2SC4081 T106 R	T	57.7/75.9
Q541	1560000331	S.FET 2SK210-GR (TE85R,F)	T	41.1/73.5
Q561	1530003431	S.TR 2SC5226-4-TL-E	T	41.4/82.4
Q580	1530003431	S.TR 2SC5226-4-TL-E	T	45.2/53.1
Q591	1530003151	S.TR 2SC4673D-TD-E	B	64.9/84.2
Q592	1520000561	S.TR 2SB1123 T-TD-E	B	73/87.3
Q593	1590000680	S.TR DTC114EUA T106	B	72.8/97.5
Q680	1530002060	S.TR 2SC4081 T106 R	T	8.5/85.5
Q702	1530002601	S.TR 2SC4215-O (TE85R,F)	B	78.1/38.7
Q801	1560000561	S.FET 2SK882-GR (TE85L,F)	T	61.1/92.1
Q811	1560000561	S.FET 2SK882-GR (TE85L,F)	T	18.3/92.7
Q831	1560000561	S.FET 2SK882-GR (TE85L,F)	T	22.1/102.6
Q832	1520000561	S.TR 2SB1123 T-TD-E	T	53/99.4
Q833	1590000680	S.TR DTC114EUA T106	B	51.7/106.6
Q1601	1530002601	S.TR 2SC4215-O (TE85R,F)	T	80.7/56.2
Q1680	1530002060	S.TR 2SC4081 T106 R	T	15.9/51.6
D201	1750000520	S.DIO DAN222TL	T	144.7/6.6
D205	1790001250	S.DIO MA2S111-(TX)	T	154.3/30.7
D220	1720000590	S.VCP MA357 (TX)	T	152.9/61.3
D221	1720000590	S.VCP MA357 (TX)	T	152.9/63.4
D222	1790000620	S.DIO MA77 (TX)	T	154.9/93.4
D230	1720000590	S.VCP MA357 (TX)	T	140.5/61.3
D231	1720000590	S.VCP MA357 (TX)	T	140.5/63.4
D232	1790000620	S.DIO MA77 (TX)	T	142.5/93.1
D240	1720000590	S.VCP MA357 (TX)	T	128/61.3
D242	1790000620	S.DIO MA77 (TX)	T	129.9/93.4
D250	1720000590	S.VCP MA357 (TX)	T	115.5/61.3
D252	1790000620	S.DIO MA77 (TX)	T	117.4/93.4
D261	1720000590	S.VCP MA357 (TX)	T	103/63.4
D262	1790000620	S.DIO MA77 (TX)	T	104.9/93.4
D263	1720000590	S.VCP MA357 (TX)	T	100.3/62.9
D270	1720000590	S.VCP MA357 (TX)	T	90.5/61.3
D271	1720000590	S.VCP MA357 (TX)	T	88/62.9
D272	1790000620	S.DIO MA77 (TX)	T	92.7/93.4
D341	1790000620	S.DIO MA77 (TX)	T	147.5/100.5
D342	1160000070	S.DIO DAN202K T146	B	136/91.6
D441	1790000620	S.DIO MA77 (TX)	T	110.3/100.1
D501	1750000520	S.DIO DAN222TL	T	60.5/53.4
D542	1720000590	S.VCP MA357 (TX)	T	45.5/62.1
D821	1750000431	S.DIO HSB88WSTR-E	T	43.4/97.3
FI101	2020001820	S.CER SFECV10M5FA00-R0	T	112.2/22.2
FI831	2030000300	S.MLH FL-356 (64.491 MHz)	T	27/103
L1	6200003261	S.COL NLV32T-101J	B	156.6/23.9
L2	6200003261	S.COL NLV32T-101J	T	155.8/24.7
L20	6200003321	S.COL NLV32T-3R3J	T	79.6/102.1
L30	6200005491	S.COL NLV32T-331J	T	73.1/27.7
L101	6200001831	S.COL NLV32T-100J	T	114.6/39.5
L102	6200002641	S.COL NLV25T-R15J	T	90.4/23.4
L103	6140002810	S.COL LR-317 (T	104/15.2
L123	6200004951	S.COL NLV25T-1R8J	T	113.7/16.7
L161	6200001981	S.COL NLV25T-1R0J	B	123.4/35.6
L201	6200005011	S.COL NLV25T-100J	T	143.3/31
L211	6200003661	S.COL NLV25T-R68J	B	153/54.3

M.=Mounted side (T: Mounted on the Top side B: Mounted on the Bottom side)
S.=Surface mount

[PLL UNIT]

REF NO.	ORDER NO.	DESCRIPTION	M.	H/V LOCATION
L220	6200010790	S.COL C2520C-3R9G-A	T	147.2/62.4
L221	6190001421	COL #E526GN-110502		
L222	6200010790	S.COL C2520C-3R9G-A	T	147/86.7
L230	6200010830	S.COL C2520C-3R3G-A	T	134.7/62.4
L231	6190001421	COL #E526GN-110502		
L232	6200010830	S.COL C2520C-3R3G-A	T	134.5/86.7
L240	6200010830	S.COL C2520C-3R3G-A	T	122.3/62.4
L241	6190001421	COL #E526GN-110502		
L242	6200010830	S.COL C2520C-3R3G-A	T	122/86.7
L250	6200010820	S.COL C2520C-2R7G-A	T	109.8/62.4
L251	6190001421	COL #E526GN-110502		
L252	6200010820	S.COL C2520C-2R7G-A	T	109.5/86.7
L260	6200010820	S.COL C2520C-2R7G-A	T	97.3/62.4
L261	6190001411	COL #E526GN-110501		
L262	6200010820	S.COL C2520C-2R7G-A	T	97/86.7
L270	6200010810	S.COL C2520C-2R2G-A	T	84.9/62.4
L271	6190001411	COL #E526GN-110501		
L272	6200010810	S.COL C2520C-2R2G-A	T	85.8/86.6
L280	6200005011	S.COL NLV25T-100J	T	160/74.6
L302	6200001831	S.COL NLV32T-100J	T	142.1/99.8
L331	6200002641	S.COL NLV25T-F15J	T	150.6/105.6
L332	6200002411	S.COL NLV25T-056J	T	149/102.7
L341	6200003261	S.COL NLV32T-101J	T	145.1/97.5
L351	6200001831	S.COL NLV32T-100J	T	122.7/101.8
L441	6200002601	S.COL NLV25T-047J	T	112.4/102.4
L442	6200010730	S.COL C2520C-68NG-A	T	106.5/101
L451	6200002641	S.COL NLV25T-F15J	T	103.7/105.5
L452	6200003261	S.COL NLV32T-101J	T	106.3/97.9
L501	6200001831	S.COL NLV32T-100J	T	66.8/42.4
L530	6200003171	S.COL NLV32T-330J	T	57.7/26
L531	6200003171	S.COL NLV32T-330J	T	61.8/26
L532	6200003171	S.COL NLV32T-330J	T	65.5/26.9
L541	6200010790	S.COL C2520C-3R9G-A	T	46.9/65.3
L542	6190001421	COL #E526GN-110502		
L543	6200010790	S.COL C2520C-3R9G-A	T	39.8/76.6
L544	6200003261	S.COL NLV32T-101J	B	45.2/66.1
L545	6200003261	S.COL NLV32T-101J	B	55.4/78.2
L561	6200003261	S.COL NLV32T-101J	B	76/92
L562	6200001831	S.COL NLV32T-100J	T	51.6/105.4
L565	6150004250	COL LS-471A (C-14922)		
L566	6150004250	COL LS-471A (C-14922)		
L591	6200007790	S.COL LQW2BHN1R15J03L	B	69/81.9
L651	6200001831	S.COL NLV32T-100J	B	4.4/60.7
L681	6200005491	S.COL NLV32T-331J	T	30.2/78.1
L682	6200008641	S.COL NLV32T-391J	T	29.2/81.5
L683	6200008641	S.COL NLV32T-391J	T	18.7/85.7
L701	6200003261	S.COL NLV32T-101J	T	73.1/31.8
L702	6150004971	S.COL LS-522-LF	T	77.2/38.1
L703	6150004971	S.COL LS-522-LF	T	77.2/48.2
L801	6150004280	COL LS-484B (C-14927)		
L812	6200003231	S.COL NLV32T-181J	T	22.8/92.2
L821	6140003530	COL LR-395		
L822	6140003530	COL LR-395		
L831	6140003770	S.COL LR-414 4KBL (STP-01435)	T	34.4/104.5
L834	6150004280	COL LS-484B (C-14927)		
L1601	6200001831	S.COL NLV32T-100J	B	87.4/55.3
L1602	6200002641	S.COL NLV25T-R15J	T	76.9/57.8
L1603	6200002841	S.COL NLV25T-R22J	T	77.2/63.4
L1651	6200001831	S.COL NLV32T-100J	B	29.1/11.5
L1681	6200002981	S.COL NLV32T-R56J	T	12.3/40.5
L1682	6200003041	S.COL NLV32T-R68J	T	8.7/39.7
L1683	6200003051	S.COL NLV32T-R82J	B	21.3/44.1
R1	7030003680	S.RES ERJ3GEYJ 104 V (100 k)	B	160.9/17.1
R2	7030003560	S.RES ERJ3GEYJ 103 V (10 k)	B	158.1/19.4
R3	7030003550	S.RES ERJ3GEYJ 822 V (8.2 k)	T	153.3/10.3
R4	7030003550	S.RES ERJ3GEYJ 822 V (8.2 k)	T	149.3/10.3
R5	7030003550	S.RES ERJ3GEYJ 822 V (8.2 k)	T	148/10.3
R6	7030003550	S.RES ERJ3GEYJ 822 V (8.2 k)	T	146.7/10.3
R7	7030003500	S.RES ERJ3GEYJ 332 V (3.3 k)	B	162.3/22.3
R9	7030003680	S.RES ERJ3GEYJ 104 V (100 k)	B	164.7/23.1
R10	7030003360	S.RES ERJ3GEYJ 221 V (220)	T	160/16.8
R11	7030003360	S.RES ERJ3GEYJ 221 V (220)	T	160/18.1
R13	7030003360	S.RES ERJ3GEYJ 221 V (220)	T	160/20.7
R14	7030003360	S.RES ERJ3GEYJ 221 V (220)	T	160/22
R15	7030003360	S.RES ERJ3GEYJ 221 V (220)	T	160/23.3
R16	7030003360	S.RES ERJ3GEYJ 221 V (220)	T	160/26.1
R17	7030003360	S.RES ERJ3GEYJ 221 V (220)	T	160/28.2
R18	7030003550	S.RES ERJ3GEYJ 822 V (8.2 k)	B	152.8/22
R19	7030003550	S.RES ERJ3GEYJ 822 V (8.2 k)	T	152/10.3
R30	7030003240	S.RES ERJ3GEYJ 220 V (22)	B	78/29.7
R31	7030003600	S.RES ERJ3GEYJ 223 V (22 k)	B	74.7/27.9
R32	7030003320	S.RES ERJ3GEYJ 101 V (100)	B	74.7/34.5
R33	7030003340	S.RES ERJ3GEYJ 151 V (150)	B	78/26.1
R51	7030011030	S.RES ERJ1TYJ 270U (27)	T	172.7/91.9
R52	7030010550	S.RES ERJ1TYJ 820U (82)	B	169.5/91.9
R61	7030011030	S.RES ERJ1TYJ 270U (27)	T	169.9/73.2
R101	7030003290	S.RES ERJ3GEYJ 560 V (56)	T	87.5/34.1
R102	7030003360	S.RES ERJ3GEYJ 221 V (220)	T	90.3/34.1
R103	7030003290	S.RES ERJ3GEYJ 560 V (56)	T	94.3/34.1
R104	7030003560	S.RES ERJ3GEYJ 103 V (10 k)	T	93.6/32.1
R105	7030003480	S.RES ERJ3GEYJ 222 V (2.2 k)	T	94.9/32.1
R106	7030003320	S.RES ERJ3GEYJ 101 V (100)	T	91.5/27.1
R107	7030003320	S.RES ERJ3GEYJ 101 V (100)	T	93.6/21.2
R108	7030003440	S.RES ERJ3GEYJ 102 V (1 k)	T	96.6/32
R109	7030003440	S.RES ERJ3GEYJ 102 V (1 k)	T	101.8/34.1
R110	7030003440	S.RES ERJ3GEYJ 102 V (1 k)	T	103.1/34.1
R111	7030003440	S.RES ERJ3GEYJ 102 V (1 k)	T	104.4/34.1
R112	7030003440	S.RES ERJ3GEYJ 102 V (1 k)	T	107.4/31.1
R113	7030003510	S.RES ERJ3GEYJ 392 V (3.9 k)	T	105.1/21.4
R114	7030003320	S.RES ERJ3GEYJ 101 V (100)	B	103.5/22.6
R115	7030003320	S.RES ERJ3GEYJ 101 V (100)	B	101.3/22.6
R131	7030003320	S.RES ERJ3GEYJ 101 V (100)	T	114.3/27.9

[PLL UNIT]

REF NO.	ORDER NO.	DESCRIPTION	M.	H/V LOCATION
R132	7030003410	S.RES ERJ3GEYJ 561 V (560)	T	111.5/27.9
R133	7030003320	S.RES ERJ3GEYJ 101 V (100)	T	111.5/26.6
R138	7030003860	S.RES ERJ3GE JPW V	T	108.7/15.1
R159	7030003200	S.RES ERJ3GEYJ 100 V (10)	B	126.4/43.2
R160	7030003370	S.RES ERJ3GEYJ 271 V (270)	B	128.2/43.2
R161	7030003640	S.RES ERJ3GEYJ 473 V (47 k)	B	133.6/43.2
R201	7030003520	S.RES ERJ3GEYJ 472 V (4.7 k)	T	154.4/40
R202	7030003440	S.RES ERJ3GEYJ 102 V (1 k)	B	146.8/30
R203	7030003440	S.RES ERJ3GEYJ 102 V (1 k)	B	148.8/30
R204	7030003360	S.RES ERJ3GEYJ 221 V (220)	B	150.4/30
R205	7030003560	S.RES ERJ3GEYJ 103 V (10 k)	T	154.3/32
R206	7030003860	S.RES ERJ3GE JPW V	T	142.6/39.9
R210	7030003860	S.RES ERJ3GE JPW V	T	150.8/46
R217	7030009861	S.RES ERA3YED 471V (470)	B	147.3/49.2
R219	7030009861	S.RES ERA3YED 471V (470)	B	152.6/48.9
R220	7030003680	S.RES ERJ3GEYJ 104 V (100 k)	T	147.1/83.7
R221	7030003680	S.RES ERJ3GEYJ 104 V (100 k)	T	153.8/82.8
R222	7030003360	S.RES ERJ3GEYJ 221 V (220)	T	146.4/92.4
R223	7030003440	S.RES ERJ3GEYJ 102 V (1 k)	T	152.8/92.4
R224	7030003320	S.RES ERJ3GEYJ 101 V (100)	T	144.5/83.7
R230	7030003680	S.RES ERJ3GEYJ 104 V (100 k)	T	134.6/83.7
R231	7030003680	S.RES ERJ3GEYJ 104 V (100 k)	T	141.4/82.8
R232	7030003360	S.RES ERJ3GEYJ 221 V (220)	T	133.9/92.4
R233	7030003440	S.RES ERJ3GEYJ 102 V (1 k)	T	140.3/92.4
R234	7030003320	S.RES ERJ3GEYJ 101 V (100)	T	132/83.7
R240	7030003680	S.RES ERJ3GEYJ 104 V (100 k)	T	122.1/83.7
R241	7030003680	S.RES ERJ3GEYJ 104 V (100 k)	T	128.9/82.8
R242	7030003360	S.RES ERJ3GEYJ 221 V (220)	T	121.4/92.4
R243	7030003440	S.RES ERJ3GEYJ 102 V (1 k)	T	127.8/92.4
R244	7030003320	S.RES ERJ3GEYJ 101 V (100)	T	119.5/83.7
R250	7030003680	S.RES ERJ3GEYJ 104 V (100 k)	T	109.6/83.7
R251	7030003680	S.RES ERJ3GEYJ 104 V (100 k)	T	116.3/82.8
R252	7030003360	S.RES ERJ3GEYJ 221 V (220)	T	108.9/92.4
R253	7030003440	S.RES ERJ3GEYJ 102 V (1 k)	T	115.3/92.4
R254	7030003320	S.RES ERJ3GEYJ 101 V (100)	T	107/83.7
R260	7030003680	S.RES ERJ3GEYJ 104 V (100 k)	T	97.1/83.7
R261	7030003680	S.RES ERJ3GEYJ 104 V (100 k)	T	103.8/82.8
R262	7030003360	S.RES ERJ3GEYJ 221 V (220)	T	96.4/92.4
R263	7030003440	S.RES ERJ3GEYJ 102 V (1 k)	T	102.8/92.4
R264	7030003320	S.RES ERJ3GEYJ 101 V (100)	T	94.5/83.7
R270	7030003680	S.RES ERJ3GEYJ 104 V (100 k)	T	85.2/83.5
R271	7030003680	S.RES ERJ3GEYJ 104 V (100 k)	T	91.9/82.8
R272	7030003360	S.RES ERJ3GEYJ 221 V (220)	T	83.9/93.4
R273	7030003440	S.RES ERJ3GEYJ 102 V (1 k)	T	90.8/92.4
R274	7030003320	S.RES ERJ3GEYJ 101 V (100)	T	82.6/83.7
R281	7030003440	S.RES ERJ3GEYJ 102 V (1 k)	B	76.1/68.8
R282	7030003440	S.RES ERJ3GEYJ 102 V (1 k)	B	73/67.9
R283	7030003440	S.RES ERJ3GEYJ 102 V (1 k)	B	76.1/67
R284	7030003440	S.RES ERJ3GEYJ 102 V (1 k)	B	73/66.1
R285	7030003440	S.RES ERJ3GEYJ 102 V (1 k)	B	76.1/65.2
R286	7030003440	S.RES ERJ3GEYJ 102 V (1 k)	B	73/64.3
R301	7030003200	S.RES ERJ3GEYJ 100 V (10)	T	154.1/97
R302	7030003440	S.RES ERJ3GEYJ 102 V (1 k)	T	155.4/97
R303	7030003360	S.RES ERJ3GEYJ 221 V (220)	T	156.7/102.6
R304	7030003490	S.RES ERJ3GEYJ 272 V (2.7 k)	T	154.6/104.5
R305	7030003510	S.RES ERJ3GEYJ 392 V (3.9 k)	T	154.6/105.8
R306	7030003360	S.RES ERJ3GEYJ 221 V (220)	T	152.5/105.2
R307	7030003260	S.RES ERJ3GEYJ 330 V (33)	T	152.5/102.6
R308	7030003370	S.RES ERJ3GEYJ 271 V (270)	B	141.2/102.1
R309	7030003540	S.RES ERJ3GEYJ 682 V (6.8 k)	B	136.2/99.6
R310	7030003500	S.RES ERJ3GEYJ 332 V (3.3 k)	B	136.6/101.9
R311	7030003350	S.RES ERJ3GEYJ 181 V (180)	B	138.1/98.8
R312	7030003360	S.RES ERJ3GEYJ 221 V (220)	B	155.4/102.9
R313	7030003490	S.RES ERJ3GEYJ 272 V (2.7 k)	B	160.4/101.6
R314	7030003510	S.RES ERJ3GEYJ 392 V (3.9 k)	B	160.4/98.9
R315	7030003360	S.RES ERJ3GEYJ 221 V (220)	B	158.2/98.1
R316	7030003280	S.RES ERJ3GEYJ 470 V (47)	B	159.3/85.5
R317	7030006220	S.RES ERJ12YJ470U (47)	B	151.2/100.5
R318	7030003440	S.RES ERJ3GEYJ 330 V (33)	B	144.1/102.1
R341	7030003260	S.RES ERJ3GEYJ 102 V (1 k)	T	144.6/102.6
R342	7030003560	S.RES ERJ3GEYJ 103 V (10 k)	T	152.5/97
R343	7030003440	S.RES ERJ3GEYJ 102 V (1 k)	T	149.9/99.8
R351	7030003200	S.RES ERJ3GEYJ 100 V (10)	B	131.2/101.1
R352	7030003280	S.RES ERJ3GEYJ 470 V (47)	T	128.9/99.8
R353	7030003520	S.RES ERJ3GEYJ 472 V (4.7 k)	T	130.2/99.8
R354	7030003520	S.RES ERJ3GEYJ 472 V (4.7 k)	T	134.3/99.8
R355	7030003520	S.RES ERJ3GEYJ 472 V (4.7 k)	T	131.5/99.8
R356	7030003320	S.RES ERJ3GEYJ 101 V (100)	T	127.6/99.8
R357	7310005390	S.TRI EVM-3V5X50 BQ3 (472)	T	132/104.1
R358	7030003280	S.RES ERJ3GEYJ 470 V (47)	T	128.2/105.7
R359	7030003320	S.RES ERJ3GEYJ 101 V (100)	T	125.6/105.7
R360	7030003320	S.RES ERJ3GEYJ 10		

[PLL UNIT]

REF NO.	ORDER NO.	DESCRIPTION	M.	H/V LOCATION
R544	7030003680	S.RES ERJ3GEYJ 104 V (100 k)	T	41.3/71.2
R545	7030003680	S.RES ERJ3GEYJ 104 V (100 k)	T	41.3/69.9
R546	7030003400	S.RES ERJ3GEYJ 471 V (470)	T	38.4/79.4
R548	7030009591	S.RES ERA3YED 472V (4.7 k)	T	56.6/64.4
R550	7030009691	S.RES ERA3YED 101V (100)	T	55.3/64.4
R554	7030009891	S.RES ERA3YED 151V (150)	T	52.5/65.1
R555	7030003380	S.RES ERJ3GEYJ 331 V (330)	T	60.1/75
R556	7030006561	S.RES ERA3YED 223V (22 k)	T	49.8/62.3
R561	7030003200	S.RES ERJ3GEYJ 100 V (10)	T	43.5/78.5
R562	7030003360	S.RES ERJ3GEYJ 221 V (220)	T	45.5/81.5
R563	7030003490	S.RES ERJ3GEYJ 272 V (2.7 k)	T	41.5/80.5
R564	7030003510	S.RES ERJ3GEYJ 392 V (3.9 k)	T	41.5/79.2
R565	7030003360	S.RES ERJ3GEYJ 221 V (220)	T	39.2/83.6
R570	7030003230	S.RES ERJ3GEYJ 180 V (18)	T	45.6/81.8
R571	7030003230	S.RES ERJ3GEYJ 180 V (18)	T	46.4/79.9
R572	7030003290	S.RES ERJ3GEYJ 560 V (56)	T	48.2/79.2
R573	7030003260	S.RES ERJ3GEYJ 330 V (33)	T	48.2/81.8
R574	7030003300	S.RES ERJ3GEYJ 680 V (68)	T	50.1/79.9
R575	7030003220	S.RES ERJ3GEYJ 150 V (15)	T	50.1/82.5
R580	7030003380	S.RES ERJ3GEYJ 331 V (330)	T	38.9/53.3
R581	7030003360	S.RES ERJ3GEYJ 221 V (220)	T	47.1/53.3
R582	7030003600	S.RES ERJ3GEYJ 223 V (22 k)	T	43.1/53.3
R583	7030000010	S.RES MCR10EZHZ JPW (000)	B	56.1/39.6
R584	7030000010	S.RES MCR10EZHZ JPW (000)	B	56/47.4
R587	7030003370	S.RES ERJ3GEYJ 271 V (270)	B	57/81.8
R588	7030003230	S.RES ERJ3GEYJ 180 V (18)	B	59.6/83.3
R589	7030003370	S.RES ERJ3GEYJ 271 V (270)	B	60.6/88.6
R591	7030003320	S.RES ERJ3GEYJ 101 V (100)	B	70.4/79.7
R592	7030003560	S.RES ERJ3GEYJ 103 V (10 k)	B	61.7/83.4
R593	7030003480	S.RES ERJ3GEYJ 222 V (2.2 k)	B	62.4/88.6
R594	7030003320	S.RES ERJ3GEYJ 101 V (100)	B	69/85.9
R595	7030003640	S.RES ERJ3GEYJ 473 V (47 k)	B	71.9/91.2
R596	7030003540	S.RES ERJ3GEYJ 682 V (6.8 k)	B	72.8/94
R603	7030003480	S.RES ERJ3GEYJ 222 V (2.2 k)	T	101.6/49.5
R604	7030003440	S.RES ERJ3GEYJ 102 V (1 k)	T	94.9/50.6
R605	7030003320	S.RES ERJ3GEYJ 101 V (100)	B	103.5/47.3
R651	7030003440	S.RES ERJ3GEYJ 102 V (1 k)	B	12.5/81.9
R652	7030003360	S.RES ERJ3GEYJ 221 V (220)	B	12.9/58.3
R653	7030003440	S.RES ERJ3GEYJ 102 V (1 k)	B	14.7/58.3
R654	7030003440	S.RES ERJ3GEYJ 102 V (1 k)	B	16.5/58.3
R655	7030007220	S.RES ERA3YED 202V (2 k)	T	30.1/58.6
R656	7030003800	S.RES ERJ3GEYJ 105 V (1 M)	T	12.5/58.8
R657	7030003400	S.RES ERJ3GEYJ 471 V (470)	T	17.5/58.1
R658	7030007220	S.RES ERA3YED 202V (2 k)	T	27.5/58.6
R659	7030007220	S.RES ERA3YED 202V (2 k)	T	27.5/59.9
R660	7030007230	S.RES ERA3YED 102V (1 k)	T	30.1/59.9
R661	7030007220	S.RES ERA3YED 202V (2 k)	T	27.5/61.2
R662	7030007230	S.RES ERA3YED 102V (1 k)	T	30.1/61.2
R663	7030007220	S.RES ERA3YED 202V (2 k)	T	27.5/62.5
R664	7030007230	S.RES ERA3YED 102V (1 k)	T	30.1/62.5
R665	7030007220	S.RES ERA3YED 202V (2 k)	T	27.5/63.8
R666	7030007230	S.RES ERA3YED 102V (1 k)	T	30.1/63.8
R667	7030007220	S.RES ERA3YED 202V (2 k)	T	27.5/65.1
R668	7030007230	S.RES ERA3YED 102V (1 k)	T	30.1/65.1
R669	7030007220	S.RES ERA3YED 202V (2 k)	T	27.5/66.4
R670	7030007230	S.RES ERA3YED 102V (1 k)	T	30.1/66.4
R671	7030007200	S.RES ERA3YED 202V (2 k)	T	27.5/67.7
R672	7030007210	S.RES ERA3YEB 102V (1 k)	T	30.1/67.7
R673	7030007200	S.RES ERA3YEB 202V (2 k)	T	27.5/70.3
R674	7030007210	S.RES ERA3YEB 102V (1 k)	T	30.1/70.3
R675	7030007200	S.RES ERA3YEB 202V (2 k)	T	27.5/71.6
R676	7030007210	S.RES ERA3YEB 102V (1 k)	T	30.1/71.6
R677	7030007200	S.RES ERA3YEB 202V (2 k)	T	27.5/72.9
R678	7030007210	S.RES ERA3YEB 102V (1 k)	T	30.1/72.9
R679	7030007200	S.RES ERA3YEB 202V (2 k)	T	27.5/74.2
R680	7030007210	S.RES ERA3YEB 102V (1 k)	T	30.1/74.2
R682	7030003860	S.RES ERJ3GE JPW V	B	74/100.9
R685	7030003460	S.RES ERJ3GEYJ 152 V (1.5 k)	T	16.1/85.4
R686	7030003320	S.RES ERJ3GEYJ 101 V (100)	T	4.5/83.5
R687	7030003470	S.RES ERJ3GEYJ 182 V (1.8 k)	T	8.7/83.5
R688	7030003480	S.RES ERJ3GEYJ 222 V (2.2 k)	T	11.3/84.8
R689	7030003360	S.RES ERJ3GEYJ 221 V (220)	T	11.3/86.1
R690	7030003370	S.RES ERJ3GEYJ 271 V (270)	T	2.6/91.7
R691	7030003230	S.RES ERJ3GEYJ 180 V (18)	T	4.5/92.4
R692	7030003370	S.RES ERJ3GEYJ 271 V (270)	T	2.6/93.2
R693	7030003500	S.RES ERJ3GEYJ 332 V (3.3 k)	T	15.4/83.5
R704	7030003260	S.RES ERJ3GEYJ 330 V (33)	T	72.7/37.3
R705	7030003600	S.RES ERJ3GEYJ 223 V (22 k)	B	78/36.3
R706	7030003560	S.RES ERJ3GEYJ 103 V (10 k)	B	78/32.7
R707	7030003400	S.RES ERJ3GEYJ 471 V (470)	B	78/41.1
R708	7030003410	S.RES ERJ3GEYJ 561 V (560)	T	82.4/47.6
R709	7030007860	S.RES ERJ3GEYJ 8R2V (8.2)	T	83.2/49.6
R710	7030003410	S.RES ERJ3GEYJ 561 V (560)	T	83.2/45.5
R711	7030003400	S.RES ERJ3GEYJ 471 V (470)	T	38.9/50.1
R712	7030000010	S.RES MCR10EZHZ JPW (000)	T	73.3/52.1
R802	7030003400	S.RES ERJ3GEYJ 471 V (470)	T	59.6/87.3
R803	7030003560	S.RES ERJ3GEYJ 103 V (10 k)	T	59.6/88.6
R804	7030003320	S.RES ERJ3GEYJ 101 V (100)	B	58.7/90.5
R805	7030003370	S.RES ERJ3GEYJ 271 V (270)	B	50.6/91
R806	7030003230	S.RES ERJ3GEYJ 180 V (18)	B	48/91.7
R807	7030003370	S.RES ERJ3GEYJ 271 V (270)	B	44.8/91.7
R812	7030003440	S.RES ERJ3GEYJ 102 V (1 k)	T	14.1/93.6
R814	7030003560	S.RES ERJ3GEYJ 103 V (10 k)	T	16.4/92.9
R815	7030003320	S.RES ERJ3GEYJ 101 V (100)	B	23.3/90.6
R831	7030003320	S.RES ERJ3GEYJ 101 V (100)	B	37.2/103.9
R832	7030003300	S.RES ERJ3GEYJ 680 V (68)	B	38.3/101.3
R833	7030003320	S.RES ERJ3GEYJ 101 V (100)	B	39/103.9
R834	7030003380	S.RES ERJ3GEYJ 331 V (330)	T	22.7/99.8
R835	7030003320	S.RES ERJ3GEYJ 101 V (100)	T	22.7/97
R836	7030003320	S.RES ERJ3GEYJ 101 V (100)	B	15.3/99.8
R837	7030003320	S.RES ERJ3GEYJ 101 V (100)	B	13.4/100.6
R838	7030003320	S.RES ERJ3GEYJ 101 V (100)	B	12.6/98.7
R839	7030003560	S.RES ERJ3GEYJ 103 V (10 k)	T	52.3/102.7
R840	7030003540	S.RES ERJ3GEYJ 682 V (6.8 k)	B	51.7/103.4

[PLL UNIT]

REF NO.	ORDER NO.	DESCRIPTION	M.	H/V LOCATION
R1601	7030003370	S.RES ERJ3GEYJ 271 V (270)	B	81.5/55.3
R1602	7030003470	S.RES ERJ3GEYJ 182 V (1.8 k)	T	82.6/56.4
R1606	7030003360	S.RES ERJ3GEYJ 221 V (220)	T	82.6/53.6
R1607	7030003480	S.RES ERJ3GEYJ 222 V (2.2 k)	T	85.2/56.4
R1608	7030003440	S.RES ERJ3GEYJ 102 V (1 k)	T	78.5/54.6
R1651	7030003400	S.RES ERJ3GEYJ 471 V (470)	T	30.2/30.5
R1652	7030003800	S.RES ERJ3GEYJ 105 V (1 M)	T	28.3/26.6
R1653	7030003360	S.RES ERJ3GEYJ 221 V (220)	B	28.9/23.6
R1654	7030003440	S.RES ERJ3GEYJ 102 V (1 k)	B	28.9/25.2
R1655	7030003440	S.RES ERJ3GEYJ 102 V (1 k)	B	28.9/26.8
R1656	7030007220	S.RES ERA3YED 202V (2 k)	T	30.5/40.4
R1657	7030007220	S.RES ERA3YED 202V (2 k)	T	30.5/37.8
R1658	7030007220	S.RES ERA3YED 202V (2 k)	T	29.2/37.8
R1659	7030007230	S.RES ERA3YED 102V (1 k)	T	29.2/40.4
R1660	7030007220	S.RES ERA3YED 202V (2 k)	T	27.9/37.8
R1661	7030007230	S.RES ERA3YED 102V (1 k)	T	27.9/40.4
R1662	7030007220	S.RES ERA3YED 202V (2 k)	T	26.6/37.8
R1663	7030007230	S.RES ERA3YED 102V (1 k)	T	26.6/40.4
R1664	7030007220	S.RES ERA3YED 202V (2 k)	T	25.3/37.8
R1665	7030007230	S.RES ERA3YED 102V (1 k)	T	25.3/40.4
R1666	7030007220	S.RES ERA3YED 202V (2 k)	T	24/37.8
R1667	7030007230	S.RES ERA3YED 102V (1 k)	T	24/40.4
R1668	7030007220	S.RES ERA3YED 202V (2 k)	T	22.7/37.8
R1669	7030007230	S.RES ERA3YED 102V (1 k)	T	22.7/40.4
R1670	7030007200	S.RES ERA3YEB 202V (2 k)	T	21.4/37.8
R1671	7030007210	S.RES ERA3YEB 102V (1 k)	T	21.4/40.4
R1672	7030007200	S.RES ERA3YEB 202V (2 k)	T	18.8/37.8
R1673	7030007210	S.RES ERA3YEB 102V (1 k)	T	20.1/40.4
R1674	7030007200	S.RES ERA3YEB 202V (2 k)	T	17.5/37.8
R1675	7030007210	S.RES ERA3YEB 102V (1 k)	T	18.8/40.4
R1676	7030007200	S.RES ERA3YEB 202V (2 k)	T	16.2/37.8
R1677	7030007210	S.RES ERA3YEB 102V (1 k)	T	17.5/40.4
R1678	7030007200	S.RES ERA3YEB 202V (2 k)	T	14.9/37.8
R1679	7030007210	S.RES ERA3YEB 102V (1 k)	T	16.2/40.4
R1680	7030003440	S.RES ERJ3GEYJ 102 V (1 k)	T	5.4/27.9
R1685	7030003460	S.RES ERJ3GEYJ 152 V (1.5 k)	T	20.6/47.8
R1686	7030003320	S.RES ERJ3GEYJ 101 V (100)	T	17.1/48.6
R1687	7030003470	S.RES ERJ3GEYJ 182 V (1.8 k)	T	17.8/51.5
R1688	7030003480	S.RES ERJ3GEYJ 222 V (2.2 k)	T	19.1/50.4
R1689	7030003360	S.RES ERJ3GEYJ 221 V (220)	T	15/46.8
R1690	7030003370	S.RES ERJ3GEYJ 271 V (270)	T	13.5/46.8
R1691	7030003230	S.RES ERJ3GEYJ 180 V (18)	T	12.8/49.9
R1692	7030003370	S.RES ERJ3GEYJ 271 V (270)	T	12/48.1
R1693	7030003360	S.RES ERJ3GEYJ 221 V (220)	T	20.6/50.4
R1694	7030003360	S.RES ERJ3GEYJ 221 V (220)	T	29/23.4
R1703	7030003440	S.RES ERJ3GEYJ 102 V (1 k)	B	30.9/18.6
R1705	7030003860	S.RES ERJ3GE JPW V	T	28.1/19.2
R1706	7030003860	S.RES ERJ3GE JPW V	T	6.1/17.4
R1707	7030003860	S.RES ERJ3GE JPW V	T	6.1/18.7
R1708	7030003360	S.RES ERJ3GEYJ 221 V (220)	B	12.1/11.8
C2	4030006880	S.CER C1608 JB 1H 472K-T	T	148.9/23.7
C3	4030011600	S.CER C1608 JB 1E 104K-T	B	153.2/23.9
C14	4030006880	S.CER C1608 JB 1H 472K-T	T	164/43.9
C15	4030006880	S.CER C1608 JB 1H 472K-T	T	172.3/26
C16	4030006880	S.CER C1608 JB 1H 472K-T	T	172.3/28
C17	4030006880	S.CER C1608 JB 1H 472K-T	T	172.3/16.8
C18	4030006880	S.CER C1608 JB 1H 472K-T	T	172.3/18.1
C19	4030006880	S.CER C1608 JB 1H 472K-T	T	173.6/39
C20	4030006880	S.CER C1608 JB 1H 472K-T	T	72.8/106.7
C21	4030006880	S.CER C1608 JB 1H 472K-T	T	74.1/106.7
C22	4030006880	S.CER C1608 JB 1H 472K-T	T	75.4/106.7
C30	4030011600	S.CER C1608 JB 1E 104K-T	B	74.7/26.1
C31	4030011600	S.CER C1608 JB 1E 104K-T	B	74.7/29.7
C32	4030011600	S.CER C1608 JB 1E 104K-T	B	78/34.5
C51	4510008520	S.ELE EEE1CA470SP	T	170.5/101.2
C52	4030011600	S.CER C1608 JB 1E 104K-T	T	165.9/99.2
C53	4030011600	S.CER C1608 JB 1E 104K-T	T	163.3/99.2
C54	4510008500	S.ELE EEE1CA101WP	T	162.5/103.9
C61	4510008520	S.ELE EEE1CA470SP	T	164.1/62
C62	4030011600	S.CER C1608 JB 1E 104K-T	B	167.2/64.3
C63	4030011600	S.CER C1608 JB 1E 104K-T	B	169.8/64.3
C64	4510008500	S.ELE EEE1CA101WP	T	171.2/62
C101	4030006880	S.CER C1608 JB 1H 472K-T	T	92.3/33.4
C102	4030006880	S.CER C1608 JB 1H 472K-T	T	91.5/25.8
C103	4030007110	S.CER C1608 CH 1H 680J-T	T	92.3/33.4
C104	4030007070	S.CER C1608 CH 1H 330J-T	T	94.3/24.5
C105	4030006880	S.CER C1608 JB 1H 47		

[PLL UNIT]

REF NO.	ORDER NO.	DESCRIPTION	M.	H/V LOCATION
C202	4510009280	S.ELE EEE1EA4R7SR	T	144.3/35.3
C203	4030006900	S.CER C1608 JB 1H 103K-T	T	150/41.3
C204	4030006880	S.CER C1608 JB 1H 472K-T	T	153/34.2
C205	4030006880	S.CER C1608 JB 1H 472K-T	T	154.3/34.2
C206	4030006880	S.CER C1608 JB 1H 472K-T	T	145.3/39.9
C207	4030007030	S.CER C1608 CH 1H 150J-T	B	155.9/56.4
C208	4030007030	S.CER C1608 CH 1H 150J-T	T	147.3/41.3
C209	4030011340	S.CER C1608 CH 1H 471J-T	T	157.2/57
C210	4550000510	S.TAN TEESVA 1V 473M8R	T	159/58.8
C211	4550002960	S.TAN TEESVA 1C 155M8R	B	146.7/55.4
C212	4030011810	S.CER C1608 JB 1A 224K-T	T	154.3/36.2
C219	4550000510	S.TAN TEESVA 1V 473M8R	T	150/44.3
C220	4030007130	S.CER C1608 CH 1H 101J-T	T	147.1/65.2
C221	4030009520	S.CER C1608 CH 1H 020B-T	T	152.7/65.2
C222	4610001830	S.TRI TZB4S100AB10R00	T	152.1/78.6
C223	4030007080	S.CER C1608 CH 1H 390J-T	T	148.4/83.7
C224	4030009920	S.CER C1608 CH 1H 050B-T	T	145.8/83.7
C225	4030007020	S.CER C1608 CH 1H 120J-T	T	153.8/84.1
C226	4030006880	S.CER C1608 JB 1H 472K-T	T	153.8/81.5
C227	4030009920	S.CER C1608 CH 1H 050B-T	T	152.1/85.6
C228	4550006250	S.TAN TEESVA 1A 106M8R	T	146.9/79.3
C229	4030006990	S.CER C1608 CH 1H 080D-T	T	152.1/88.3
C230	4030007070	S.CER C1608 CH 1H 330J-T	T	134.7/65.2
C232	4610001830	S.TRI TZB4S100AB10R00	T	139.6/78.6
C233	4030007070	S.CER C1608 CH 1H 330J-T	T	135.9/83.7
C234	4030009920	S.CER C1608 CH 1H 050B-T	T	133.3/83.7
C235	4030009920	S.CER C1608 CH 1H 050B-T	T	141.4/84.1
C236	4030006880	S.CER C1608 JB 1H 472K-T	T	141.4/81.5
C237	4030009520	S.CER C1608 CH 1H 020B-T	T	139.7/85.6
C238	4550006250	S.TAN TEESVA 1A 106M8R	T	134.4/79.3
C239	4030009910	S.CER C1608 CH 1H 040B-T	T	139.7/88.3
C240	4030007100	S.CER C1608 CH 1H 560J-T	T	122.2/65.2
C241	4030009520	S.CER C1608 CH 1H 020B-T	T	127.6/65.2
C242	4610001830	S.TRI TZB4S100AB10R00	T	127.1/78.6
C243	4030007070	S.CER C1608 CH 1H 330J-T	T	123.4/83.7
C244	4030009520	S.CER C1608 CH 1H 020B-T	T	120.8/83.7
C245	4030011770	S.CER C1608 CH 1H 060B-T	T	128.9/84.1
C246	4030006880	S.CER C1608 JB 1H 472K-T	T	128.8/81.5
C247	4030007040	S.CER C1608 CH 1H 180J-T	T	127.2/85.6
C248	4550006250	S.TAN TEESVA 1A 106M8R	T	121.8/79.3
C250	4030007100	S.CER C1608 CH 1H 560J-T	T	109.7/65.2
C252	4610001860	S.TRI TZB4Z060AB10R00	T	114.6/78.6
C253	4030007080	S.CER C1608 CH 1H 390J-T	T	110.9/83.7
C254	4030009530	S.CER C1608 CH 1H 030B-T	T	108.3/83.7
C255	4030006980	S.CER C1608 CH 1H 070D-T	T	116.3/84.1
C256	4030006880	S.CER C1608 JB 1H 472K-T	T	116.3/81.5
C257	4030007050	S.CER C1608 CH 1H 220J-T	T	114.7/85.6
C258	4550006250	S.TAN TEESVA 1A 106M8R	T	109.3/79.3
C259	4030006880	S.CER C1608 JB 1H 472K-T	T	160.4/51.7
C260	4030007090	S.CER C1608 CH 1H 470J-T	T	97.2/65.2
C262	4610001860	S.TRI TZB4Z060AB10R00	T	102.1/78.6
C263	4030007080	S.CER C1608 CH 1H 390J-T	T	98.4/83.7
C264	4030009530	S.CER C1608 CH 1H 030B-T	T	95.8/83.7
C265	4030006980	S.CER C1608 CH 1H 070D-T	T	103.8/84.1
C266	4030006880	S.CER C1608 JB 1H 472K-T	T	103.8/81.5
C267	4030007050	S.CER C1608 CH 1H 220J-T	T	102.2/85.6
C268	4550006250	S.TAN TEESVA 1A 106M8R	T	96.8/79.3
C272	4610001860	S.TRI TZB4Z060AB10R00	T	89.6/78.6
C273	4030007050	S.CER C1608 CH 1H 220J-T	T	86.5/83.5
C274	4030009530	S.CER C1608 CH 1H 030B-T	T	83.9/83.5
C275	4030009530	S.CER C1608 CH 1H 030B-T	T	91.9/84.1
C276	4030006880	S.CER C1608 JB 1H 472K-T	T	91.9/81.5
C277	4030007050	S.CER C1608 CH 1H 220J-T	T	89.7/85.6
C278	4550006250	S.TAN TEESVA 1A 106M8R	T	84.3/79.3
C283	4030017810	S.CER C1608 CH 1H 102J-T	T	148.4/92.6
C284	4030006880	S.CER C1608 JB 1H 472K-T	T	150.4/95
C285	4030017810	S.CER C1608 CH 1H 102J-T	T	135.9/92.6
C286	4030006880	S.CER C1608 JB 1H 472K-T	T	137.8/95
C287	4030017810	S.CER C1608 CH 1H 102J-T	T	123.4/92.6
C288	4030006880	S.CER C1608 JB 1H 472K-T	T	127.2/94.4
C289	4030017810	S.CER C1608 CH 1H 102J-T	T	110.9/92.6
C290	4030006880	S.CER C1608 JB 1H 472K-T	T	114.3/94.8
C291	4030017810	S.CER C1608 CH 1H 102J-T	T	98.4/92.6
C292	4030006880	S.CER C1608 JB 1H 472K-T	T	100.3/94.9
C293	4030017810	S.CER C1608 CH 1H 102J-T	T	86.9/92.6
C294	4030006880	S.CER C1608 JB 1H 472K-T	T	90.8/93.7
C296	4030007060	S.CER C1608 CH 1H 270J-T	T	137.7/63.1
C301	4030006880	S.CER C1608 JB 1H 472K-T	T	153.8/99.8
C302	4030006880	S.CER C1608 JB 1H 472K-T	T	156.7/105.4
C303	4030006880	S.CER C1608 JB 1H 472K-T	B	147.2/102.1
C304	4030006880	S.CER C1608 JB 1H 472K-T	B	138.7/101.2
C305	4030006880	S.CER C1608 JB 1H 472K-T	B	134.4/99.6
C306	4030006880	S.CER C1608 JB 1H 472K-T	B	132.6/99.6
C308	4030006880	S.CER C1608 JB 1H 472K-T	T	156.2/99.1
C309	4030017810	S.CER C1608 CH 1H 102J-T	T	142/105.4
C310	4030011600	S.CER C1608 JB 1E 104K-T	T	142.6/103.3
C311	4510008520	S.ELE EEE1CA470SP	T	137.3/103.9
C312	4030006880	S.CER C1608 JB 1H 472K-T	B	155/98.3
C313	4030006880	S.CER C1608 JB 1H 472K-T	B	160.4/104.2
C314	4030006880	S.CER C1608 JB 1H 472K-T	B	161.1/95.7
C331	4030007110	S.CER C1608 CH 1H 680J-T	T	152.5/99.8
C332	4030007160	S.CER C1608 CH 1H 181J-T	T	151.2/102.6
C333	4030007110	S.CER C1608 CH 1H 680J-T	T	151.2/99.8
C334	4030007050	S.CER C1608 CH 1H 220J-T	T	148.7/105.4
C335	4030006980	S.CER C1608 CH 1H 070D-T	T	147.3/105.4
C336	4030007030	S.CER C1608 CH 1H 150J-T	T	146.7/102.6
C337	4030007050	S.CER C1608 CH 1H 220J-T	T	145.9/105.4
C341	4030006880	S.CER C1608 JB 1H 472K-T	T	144.6/105.4
C342	4030006880	S.CER C1608 JB 1H 472K-T	T	151.2/97
C344	4030011600	S.CER C1608 JB 1E 104K-T	T	143.3/105.4
C351	4030017810	S.CER C1608 CH 1H 102J-T	T	123.5/105.4
C352	4030011600	S.CER C1608 JB 1E 104K-T	T	122.2/105.4
C353	4510008520	S.ELE EEE1CA470SP	T	117.6/103.9
C354	4030006880	S.CER C1608 JB 1H 472K-T	T	133/99.8

[PLL UNIT]

REF NO.	ORDER NO.	DESCRIPTION	M.	H/V LOCATION
C355	4030006880	S.CER C1608 JB 1H 472K-T	T	129.5/105.7
C356	4030006880	S.CER C1608 JB 1H 472K-T	T	126.3/99.7
C357	4030006880	S.CER C1608 JB 1H 472K-T	T	126.9/105.7
C358	4030006880	S.CER C1608 JB 1H 472K-T	B	126/100.5
C359	4030006880	S.CER C1608 JB 1H 472K-T	B	122.8/103.1
C360	4030006880	S.CER C1608 JB 1H 472K-T	B	117.1/100.1
C361	4030006880	S.CER C1608 JB 1H 472K-T	T	100.5/100.5
C441	4030007040	S.CER C1608 CH 1H 180J-T	T	113.4/105.4
C442	4030007040	S.CER C1608 CH 1H 180J-T	T	112.1/105.4
C443	4030007020	S.CER C1608 CH 1H 120J-T	T	110.5/102.6
C444	4030007080	S.CER C1608 CH 1H 390J-T	T	110.8/105.4
C445	4030011770	S.CER C1608 CH 1H 060B-T	T	109.5/105.4
C446	4030007060	S.CER C1608 CH 1H 270J-T	T	105.6/105.4
C447	4030007110	S.CER C1608 CH 1H 680J-T	T	105.8/103.3
C448	4030006880	S.CER C1608 JB 1H 472K-T	T	108.2/105.4
C449	4030006880	S.CER C1608 JB 1H 472K-T	T	115.6/98.6
C451	4030007110	S.CER C1608 CH 1H 680J-T	T	102.6/102.5
C452	4030007160	S.CER C1608 CH 1H 181J-T	T	103.9/102.5
C453	4030011600	S.CER C1608 JB 1E 104K-T	T	106.9/105.4
C501	4030006880	S.CER C1608 JB 1H 472K-T	T	61.4/50.3
C502	4030011600	S.CER C1608 JB 1E 104K-T	T	62.7/50.3
C503	4510008540	S.ELE EEE1CA100SR	T	65.9/48
C504	4030011600	S.CER C1608 JB 1E 104K-T	T	44/32.9
C505	4550007470	S.TAN F931A107MNM8MA	B	46/31
C506	4030011600	S.CER C1608 JB 1E 104K-T	T	46.8/32.9
C507	4030011600	S.CER C1608 JB 1E 104K-T	T	55.5/32.8
C509	4030011600	S.CER C1608 JB 1E 104K-T	T	60/37.2
C510	4030011600	S.CER C1608 JB 1E 104K-T	T	60/39.8
C511	4030011600	S.CER C1608 JB 1E 104K-T	T	60/43.6
C512	4030011600	S.CER C1608 JB 1E 104K-T	T	60/46.2
C513	4030011600	S.CER C1608 JB 1E 104K-T	T	60/48.8
C514	4030011600	S.CER C1608 JB 1E 104K-T	T	56.6/52.6
C515	4030011600	S.CER C1608 JB 1E 104K-T	T	52.9/52.7
C516	4030011600	S.CER C1608 JB 1E 104K-T	T	50.3/52.7
C517	4030011600	S.CER C1608 JB 1E 104K-T	T	40.8/49
C518	4030011600	S.CER C1608 JB 1E 104K-T	T	40.8/46.2
C519	4030011600	S.CER C1608 JB 1E 104K-T	T	40.8/42.6
C520	4030011600	S.CER C1608 JB 1E 104K-T	T	42/35.2
C521	4030011600	S.CER C1608 JB 1E 104K-T	T	58.6/53
C522	4550007220	S.TAN F931A476MCM8MA	B	47.6/52
C525	4030006880	S.CER C1608 JB 1H 472K-T	T	38.1/46.8
C526	4030011600	S.CER C1608 JB 1E 104K-T	T	38.1/48.1
C532	4030007070	S.CER C1608 CH 1H 330J-T	T	55.1/28.6
C533	4030007110	S.CER C1608 CH 1H 680J-T	T	59.2/28.7
C534	4030007110	S.CER C1608 CH 1H 680J-T	T	62.5/28.2
C535	4030007070	S.CER C1608 CH 1H 330J-T	T	64.8/29.5
C540	4030006880	S.CER C1608 JB 1H 472K-T	T	57.8/73.8
C541	4510008540	S.ELE EEE1CA100SR	T	58.7/69.5
C542	4340000260	S.MLR ECPU1C104MA5	T	48.2/62
C543	4030007060	S.CER C1608 CH 1H 270J-T	T	42.2/63.1
C545	4030008560	S.CER C1608 CH 1H 300J-T	T	40/63.8
C546	4610001830	S.TRI TZB4S100AB10R00	T	40.2/66.8
C547	4030007130	S.CER C1608 CH 1H 101J-T	T	43.5/69.1
C548	4030007010	S.CER C1608 CH 1H 100D-T	T	43.5/73.3
C549	4030007050	S.CER C1608 CH 1H 220J-T	T	38.8/73.8
C550	4030006880	S.CER C1608 JB 1H 472K-T	T	38.4/70.5
C551	4030009520	S.CER C1608 CH 1H 020B-T	T	43.5/75.9
C552	4030017810	S.CER C1608 CH 1H 102J-T	T	60.1/76.8
C553	4030006880	S.CER C1608 JB 1H 472K-T	T	52.6/80.6
C554	4510008500	S.ELE EEE1CA101WP	T	57.5/81.2
C555	4030006880	S.CER C1608 JB 1H 472K-T	B	62.6/76.2
C556	4550007220	S.TAN F931A476MCM8MA	B	39.8/66.4
C558	4550007520	S.TAN F931A106MA8BMA	T	53.6/62
C559	4550007400	S.TAN F931A225MA8BMA	T	51.5/62
C561	4550007520	S.TAN F931A106MA8BMA	B	41.4/79.9
C562	4030006880	S.CER C1608 JB 1H 472K-T	B	43.1/80.7
C563	4030017810	S.CER C1608 CH 1H 102J-T	B	75.3/94.8
C564	4030006880	S.CER C1608 JB 1H 472K-T	B	75.3/96.3
C565	4510008520	S.ELE EEE1CA470SP	T	75/89
C566	4030006880	S.CER C1608 JB 1H 472K-T	T	44.1/83.1
C571	4030006880	S.CER C1608 JB 1H 472K-T	B	60.7/85.9
C573	4030007040			

[PLL UNIT]

REF NO.	ORDER NO.	DESCRIPTION	M.	H/V LOCATION
C671	4030011600	S.CER C1608 JB 1E 104K-T	T	14.5/80.9
C672	4030011600	S.CER C1608 JB 1E 104K-T	T	18.4/80.9
C680	4030006880	S.CER C1608 JB 1H 472K-T	T	30.1/75.5
C681	4030011340	S.CER C1608 CH 1H 471J-T	T	27.5/76.6
C682	4030007120	S.CER C1608 CH 1H 820J-T	T	28.1/78.8
C683	4030017870	S.CER C1608 CH 1H 681J-T	T	26.8/78.8
C684	4030007070	S.CER C1608 CH 1H 330J-T	T	30.1/83.6
C685	4030017800	S.CER C1608 CH 1H 561J-T	T	27.5/83.6
C686	4030011280	S.CER C1608 CH 1H 271J-T	T	23.2/83.5
C687	4030017810	S.CER C1608 CH 1H 102J-T	T	21.3/84.3
C688	4030011280	S.CER C1608 CH 1H 271J-T	T	18.9/83.5
C689	4030011600	S.CER C1608 JB 1E 104K-T	T	12.8/83.5
C690	4030011600	S.CER C1608 JB 1E 104K-T	T	6.4/84.3
C691	4030011600	S.CER C1608 JB 1E 104K-T	T	6.2/90.8
C692	4030006880	S.CER C1608 JB 1H 472K-T	T	4.5/85.1
C693	4030006880	S.CER C1608 JB 1H 472K-T	B	72.2/104.2
C694	4030006880	S.CER C1608 JB 1H 472K-T	B	74/104.2
C703	4030017810	S.CER C1608 CH 1H 102J-T	T	72.4/35.2
C704	4030006880	S.CER C1608 JB 1H 472K-T	T	72.4/33.9
C705	4510008500	S.ELE EEE1CA101WP	T	79.3/29.7
C707	4030011600	S.CER C1608 JB 1E 104K-T	B	74.7/36.3
C708	4030011600	S.CER C1608 JB 1E 104K-T	B	75.4/40.7
C709	4030007070	S.CER C1608 CH 1H 330J-T	T	77.2/42.4
C710	4030006880	S.CER C1608 JB 1H 472K-T	T	75.2/43.2
C711	4030009540	S.CER C1608 CH 1H 1R5B-T	T	79.3/43.2
C712	4030007070	S.CER C1608 CH 1H 330J-T	T	77.2/43.9
C713	4030006880	S.CER C1608 JB 1H 472K-T	T	81.7/50.9
C801	4030006880	S.CER C1608 JB 1H 472K-T	T	62.4/87.3
C802	4030007030	S.CER C1608 CH 1H 150J-T	T	58.9/92
C803	4030006900	S.CER C1608 JB 1H 103K-T	T	59.6/89.9
C811	4030011600	S.CER C1608 JB 1E 104K-T	T	9.8/90.8
C812	4030011600	S.CER C1608 JB 1E 104K-T	T	19.4/90.6
C813	4030017800	S.CER C1608 CH 1H 561J-T	T	25.4/93.6
C831	4030009910	S.CER C1608 CH 1H 040B-T	T	30.4/106.8
C832	4030009510	S.CER C1608 CH 1H 010B-T	T	26.5/98.1
C834	4030007030	S.CER C1608 CH 1H 150J-T	T	21.4/99.8
C835	4030006900	S.CER C1608 JB 1H 103K-T	T	21.4/97
C836	4510008540	S.ELE EEE1CA100SR	T	59.5/97.3
C837	4030006880	S.CER C1608 JB 1H 472K-T	T	57.6/100.3
C838	4030007020	S.CER C1608 CH 1H 120J-T	T	30.4/100.9
C1601	4030006880	S.CER C1608 JB 1H 472K-T	T	83.9/56.4
C1602	4030006880	S.CER C1608 JB 1H 472K-T	B	84.1/56.1
C1607	4030006880	S.CER C1608 JB 1H 472K-T	T	80.6/54
C1608	4030006880	S.CER C1608 JB 1H 472K-T	T	78.8/57.4
C1609	4030007100	S.CER C1608 CH 1H 560J-T	T	77.2/54.6
C1610	4030008750	S.CER C1608 CH 1H 360J-T	T	78.8/60.2
C1611	4030007140	S.CER C1608 CH 1H 121J-T	T	76.8/60.2
C1612	4030007020	S.CER C1608 CH 1H 120J-T	T	76.8/61.5
C1613	4030007110	S.CER C1608 CH 1H 680J-T	T	74.7/62.3
C1651	4030006880	S.CER C1608 JB 1H 472K-T	T	30.2/29
C1652	4030011600	S.CER C1608 JB 1E 104K-T	T	31/24.2
C1653	4030006880	S.CER C1608 JB 1H 472K-T	B	26.3/12.3
C1654	4030011600	S.CER C1608 JB 1E 104K-T	B	24.5/12.3
C1655	4030011600	S.CER C1608 JB 1E 104K-T	T	26.6/17.2
C1656	4030011600	S.CER C1608 JB 1E 104K-T	T	26.6/20.2
C1658	4510008540	S.ELE EEE1CA100SR	T	29.2/14.2
C1659	4030011600	S.CER C1608 JB 1E 104K-T	T	26.6/22.8
C1660	4030011600	S.CER C1608 JB 1E 104K-T	T	26.6/28.1
C1661	4030011600	S.CER C1608 JB 1E 104K-T	T	22.8/32.7
C1662	4550007470	S.TAN F931A107MNBMA	B	19/33
C1663	4550007220	S.TAN F931A476MNCBMA	B	15.2/14.6
C1664	4030011600	S.CER C1608 JB 1E 104K-T	T	20.1/12.9
C1665	4030011600	S.CER C1608 JB 1E 104K-T	T	14.5/12.9
C1666	4030011600	S.CER C1608 JB 1E 104K-T	T	12.7/33.5
C1667	4030011600	S.CER C1608 JB 1E 104K-T	T	11.5/12.9
C1668	4030011600	S.CER C1608 JB 1E 104K-T	T	10/32.7
C1669	4030011600	S.CER C1608 JB 1E 104K-T	T	6.4/15.9
C1670	4030011600	S.CER C1608 JB 1E 104K-T	T	6.1/20.2
C1671	4030011600	S.CER C1608 JB 1E 104K-T	T	6.8/22
C1672	4030011600	S.CER C1608 JB 1E 104K-T	T	6.8/24.6
C1673	4030011600	S.CER C1608 JB 1E 104K-T	T	6.8/28.6
C1680	4030006880	S.CER C1608 JB 1H 472K-T	T	14.9/40.4
C1681	4030007160	S.CER C1608 CH 1H 181J-T	T	13.6/37.8
C1682	4030007140	S.CER C1608 CH 1H 121J-T	T	11.5/38.4
C1683	4030011330	S.CER C1608 CH 1H 391J-T	T	11.5/37.1
C1684	4030007080	S.CER C1608 CH 1H 390J-T	T	6.4/40.5
C1685	4030011280	S.CER C1608 CH 1H 271J-T	T	6.4/37.9
C1686	4030010760	S.CER C1608 CH 1H 331J-T	B	19.4/47
C1687	4030018580	S.CER C1608 CH 1H 821J-T	B	23.7/46.3
C1688	4030010760	S.CER C1608 CH 1H 331J-T	B	21.9/47.8
C1689	4030011600	S.CER C1608 JB 1E 104K-T	T	19.9/52.2
C1690	4030011600	S.CER C1608 JB 1E 104K-T	T	17.8/46.8
C1691	4030011600	S.CER C1608 JB 1E 104K-T	T	14.3/48.6
C1692	4030006880	S.CER C1608 JB 1H 472K-T	T	16.3/46.8
C1701	4030006880	S.CER C1608 JB 1H 472K-T	B	20.2/25.9
C1702	4030006880	S.CER C1608 JB 1H 472K-T	B	18.4/25.9
C1703	4030006880	S.CER C1608 JB 1H 472K-T	B	16.6/25.9
C1704	4030006880	S.CER C1608 JB 1H 472K-T	B	15.4/23.7
C1705	4030006880	S.CER C1608 JB 1H 472K-T	B	15.4/21.9
C1706	4030006880	S.CER C1608 JB 1H 472K-T	B	15.4/20.1
C1707	4030006880	S.CER C1608 JB 1H 472K-T	B	15.4/18.3
C1709	4030006880	S.CER C1608 JB 1H 472K-T	B	9.9/18.3
C1710	4030006880	S.CER C1608 JB 1H 472K-T	B	29.1/18.6
C1711	4030011600	S.CER C1608 JB 1E 104K-T	T	30.1/18
C1751	4030006880	S.CER C1608 JB 1H 472K-T	T	70/16.9
C1752	4030006880	S.CER C1608 JB 1H 472K-T	T	70/15.6
C1753	4030006880	S.CER C1608 JB 1H 472K-T	T	70/14.3
C1754	4030006880	S.CER C1608 JB 1H 472K-T	T	70/13
C1755	4030006880	S.CER C1608 JB 1H 472K-T	T	70/11.7
C1756	4030006880	S.CER C1608 JB 1H 472K-T	T	71.2/10.4
C1757	4030006880	S.CER C1608 JB 1H 472K-T	T	72/9.1
J31	6510007020	CNR TMP-J01X-V6		

[PLL UNIT]

REF NO.	ORDER NO.	DESCRIPTION	M.	H/V LOCATION
J351	6510007020	CNR TMP-J01X-V6		
J561	6510007020	CNR TMP-J01X-V6		
J601	6510007020	CNR TMP-J01X-V6		
J681	6510007020	CNR TMP-J01X-V6		
J831	6510007020	CNR TMP-J01X-V6		
J1601	6510007020	CNR TMP-J01X-V6		
J1681	6510007020	CNR TMP-J01X-V6		
J2018	6510019981	S.CNR 52808-1671 (1690)	T	167.7/22.5
J2019	6510018971	S.CNR B4B-PH-SM4-TB (LF) (SN)	T	167.7/40.8
EP10	6910014690	S.BEA MPZ1608S221A-T	T	173.8/45.7
EP11	6910014690	S.BEA MPZ1608S221A-T	T	160/14.2
EP12	6910014690	S.BEA MPZ1608S221A-T	T	160/15.5
EP13	6910014690	S.BEA MPZ1608S221A-T	T	163.2/39.8
EP20	6910012350	S.BEA MMZ1608Y 102BT	T	78.8/104.9
EP21	6910012350	S.BEA MMZ1608Y 102BT	T	78.8/106.2
EP22	6910012350	S.BEA MMZ1608Y 102BT	T	78.8/107.5
EP101	6910012350	S.BEA MMZ1608Y 102BT	B	94.7/35
EP102	6910012350	S.BEA MMZ1608Y 102BT	B	96.6/35
EP1701	6910012350	S.BEA MMZ1608Y 102BT	T	43.2/18.4
EP1702	6910012350	S.BEA MMZ1608Y 102BT	T	43.2/17
EP1703	6910012350	S.BEA MMZ1608Y 102BT	T	43.2/15.6
EP1704	6910012350	S.BEA MMZ1608Y 102BT	T	43.2/14.2
EP1705	6910012350	S.BEA MMZ1608Y 102BT	T	43.2/12.5
EP1706	6910012350	S.BEA MMZ1608Y 102BT	T	43.2/11.4
EP1707	6910012350	S.BEA MMZ1608Y 102BT	T	43.2/10
EP1708	6910012350	S.BEA MMZ1608Y 102BT	T	43.2/19.8
EP1709	6910012350	S.BEA MMZ1608Y 102BT	T	43.2/8.6

M.=Mounted side (T: Mounted on the Top side B: Mounted on the Bottom side)
S.=Surface mount

[SCOPE UNIT]

REF NO.	ORDER NO.	DESCRIPTION	M.	H/V LOCATION
IC2	1180001771	S.IC TA79L05F (TE12L,F)	T	52.1/75.5
IC31	1110006180	S.IC UPG2009TB-E3	T	20.7/72.8
IC201	1180003110	S.REG TLV1117CDCYR	T	155.7/69.2
IC401	1110006131	S.IC uPC4094G2-E1-A	T	41.6/68.1
IC403	1110006131	S.IC uPC4094G2-E1-A	T	54.5/69.7
IC404	1110006131	S.IC uPC4094G2-E1-A	T	71.6/69
IC405	1110002700	S.IC NJM2904M-TE1-#FMZB	T	29.3/11.7
IC501	1190002031	S.IC AD7650ASTZ	T	83.1/60.3
IC502	1130006891	S.IC TC7S04FU (TE85R,F)	T	85.3/69.1
IC505	1180003030	S.REG S-812C25AJA-C2FT2G	T	84.2/77.1
IC601	1140014320	S.IC TMS320C6720BRFP200	T	118.4/57.7
IC602	1130011930	S.IC SN74LVC1G04DCKR	T	96.1/53.5
IC603	1130011930	S.IC SN74LVC1G04DCKR	T	98.6/56.4
IC607	1110006411	S.IC R3111N111A-TR-F	T	104.9/70.3
IC671	1130014240	S.IC AT49BV040B-TU (SX-3009D)	T	140.4/62
IC801	1130013270	S.IC ADF4116BRUZ	T	109.2/15.1
IC803	1130009691	S.IC TC74HCT7007AF (F)	T	166.3/18.2
IC820	1190001961	S.IC AD9857ASTZ	T	138.7/17.1
IC821	1130010461	S.IC TC7SH08FU (TE85L,JF)	T	105.3/60.9
Q1	1530002060	S.TR 2SC4081 T106 R	T	26.9/54.1
Q2	1530003851	S.TR 2SC5551F-TD-E	T	30.9/23.4
Q101	1530003151	S.TR 2SC4673D-TD-E	T	56.7/5.4
Q201	1560000561	S.FET 2SK882-GR (TE85L,F)	T	47.7/29.5
Q202	1560000561	S.FET 2SK882-GR (TE85L,F)	T	45.7/37.2
Q301	1530003151	S.TR 2SC4673D-TD-E	T	65.3/51.5
Q701	1530003221	S.TR 2SC4406-4-TL-E	T	130.9/33.3
Q720	1530003221	S.TR 2SC4406-4-TL-E	T	146.9/27.2
Q810	1530003221	S.TR 2SC4406-4-TL-E	T	116.8/16.3
Q821	1560000331	S.FET 2SK210-GR (TE85R,F)	T	86.9/24.3
Q841	1530002060	S.TR 2SC4081 T106 R	T	85.1/15.8
Q842	1530003431	S.TR 2SC5226-4-TL-E	T	72.8/15.5
Q843	1530003431	S.TR 2SC5226-4-TL-E	T	71.2/21.9
Q872	1590000680	S.TR DTC114EUA T106	T	70.5/12.4
D1	1750000971	S.DIO CPH5513-TL-E	T	19.9/66.1
D2	1750000971	S.DIO CPH5513-TL-E	T	17.3/59.2
D3	1750000441	S.DIO 1SV263-TL-E	T	20.4/58.8
D4	1750000431	S.DIO HSB88WSTR-E	T	54.2/51.8
D101	1750000431	S.DIO HSB88WSTR-E	T	51.1/19.3
D821	1750000681	S.VCP 1SV232 (TPH2,F)	T	101.5/21.8
D822	1750000681	S.VCP 1SV232 (TPH2,F)	T	101.5/23.5
FI201	2030000290	S.MLH FL-357 (45 MHz)	T	53.1/33
FI501	2040000790	S.LC EXCCET103U	T	97.2/49.4
L1	6200001831	S.COL NLV32T-100J	T	20.4/62.9
L2	6200001831	S.COL NLV32T-100J	T	14.1/61.8
L3	6200001831	S.COL NLV32T-100J	T	10.8/60.2
L4	6200001831	S.COL NLV32T-100J	T	21.1/54
L5	6150004280	COL LS-484B (C-14927)		
L6	6150004280	COL LS-484B (C-14927)		
L7	6200003261	S.COL NLV32T-101J	T	36.4/32.8
L8	6140003790	COL LR-442		
L9	6200001831	S.COL NLV32T-100J	T	25.9/30.5
L10	6200001831	S.COL NLV32T-100J	T	34.9/17.3
L11	6200001831	S.COL NLV32T-100J	T	29.6/45.9
L12	6200010450	S.COL C2520C-R82G-A (0.82U)	T	17.7/44.3
L13	6200010940	S.COL C2520C-39NG-A	T	13.2/55
L14	6200010860	S.COL C2520C-R10G-A (0.1U)	T	14/50.8
L51	6200001831	S.COL NLV32T-100J	T	143/32.4
L52	6200001831	S.COL NLV32T-100J	T	174.5/43.3
L53	6200001831	S.COL NLV32T-100J	T	74.5/44.9
L54	6200001831	S.COL NLV32T-100J	T	78/44.9
L101	6140003530	COL LR-395		
L102	6140003530	COL LR-395		
L103	6200003021	S.COL NLV32T-R33J	T	50.8/6.9
L104	6200001920	S.COL ELJNC R15K-F	T	51.1/10.6
L201	6150004250	COL LS-471A (C-14922)		
L202	6150004280	COL LS-484B (C-14927)		
L203	6150004280	COL LS-484B (C-14927)		
L204	6200001831	S.COL NLV32T-100J	T	38.4/47.7
L205	6200002431	S.COL NLV25T-082J	T	55.4/27.2
L301	6140003530	COL LR-395		
L302	6140003530	COL LR-395		
L303	6200003041	S.COL NLV32T-R68J	T	64.8/56.2
L304	6200001831	S.COL NLV32T-100J	T	64.8/59.2
L401	6200003171	S.COL NLV32T-330J	T	45/61.5
L501	6200001831	S.COL NLV32T-100J	T	81.3/44.9
L502	6200001831	S.COL NLV32T-100J	T	84.3/48.1
L551	6180003501	S.COL SLF6028T-100M1R3-PF	T	144.3/40.7
L552	6200001831	S.COL NLV32T-100J	T	141.6/45.5
L671	6200001831	S.COL NLV32T-100J	T	145.8/47.5
L701	6200005491	S.COL NLV32T-331J	T	138/34.6
L720	6200011610	S.COL NLC453232T-100K-PF	T	126.7/15.4
L721	6200011610	S.COL NLC453232T-100K-PF	T	153.7/22.4
L722	6200001831	S.COL NLV32T-100J	T	152/25.8
L761	6200003011	S.COL NLV32T-R27J	T	152.4/11.1
L762	6200003021	S.COL NLV32T-R33J	T	155.8/9.6
L763	6200003251	S.COL NLV32T-R39J	T	151.5/5.9
L764	6200003251	S.COL NLV32T-R39J	T	131.5/4.1
L801	6200005491	S.COL NLV32T-331J	T	113.3/19.5
L802	6200005491	S.COL NLV32T-331J	T	169/11.1
L821	6200001831	S.COL NLV32T-100J	T	105.4/24.3
L822	6190001441	COL #E526GN-110504		
L823	6200001851	S.COL NLV32T-5R6J	T	84.4/20.8
L825	6200003261	S.COL NLV32T-101J	T	93.5/31.9
L841	6200003261	S.COL NLV32T-101J	T	81/31.4
L842	6200003031	S.COL NLV32T-R47J	T	68.8/16.8
L851	6200003431	S.COL NLV32T-R10J	T	71/25.7

[SCOPE UNIT]

REF NO.	ORDER NO.	DESCRIPTION	M.	H/V LOCATION
L852	6200001471	S.COL NLV32T-R12J	T	70.6/29.5
R1	7030003360	S.RES ERJ3GEYJ 221 V (220)	T	22.3/65.9
R2	7030003440	S.RES ERJ3GEYJ 222 V (220 k)	T	22.4/57.4
R3	7030003480	S.RES ERJ3GEYJ 102 V (1 k)	T	23.7/57.4
R4	7030003460	S.RES ERJ3GEYJ 152 V (1.5 k)	T	25/54.5
R5	7030003520	S.RES ERJ3GEYJ 472 V (4.7 k)	T	29.6/54
R5	7030003580	S.RES ERJ3GEYJ 153 V (15 k)	T	29.6/54
R6	7030003440	S.RES ERJ3GEYJ 102 V (1 k)	T	28.2/56.1
R7	7030003290	S.RES ERJ3GEYJ 560 V (56)	T	31.2/35.4
R8	7030003440	S.RES ERJ3GEYJ 102 V (1 k)	T	31/19.8
R9	7030003500	S.RES ERJ3GEYJ 332 V (3.3 k)	T	33.4/19.8
R11	7310005400	S.TRI EVM-3VXS50 BE4 (223)	T	29.9/49.6
R12	7030003320	S.RES ERJ3GEYJ 101 V (100)	T	32.4/26.5
R36	7030003520	S.RES ERJ3GEYJ 472 V (4.7 k)	T	18.1/71.7
R38	7030003520	S.RES ERJ3GEYJ 472 V (4.7 k)	T	20.9/68.4
R53	7030003320	S.RES ERJ3GEYJ 101 V (100)	T	163.3/41.8
R60	7030003320	S.RES ERJ3GEYJ 101 V (100)	T	163.3/59.8
R61	7030003320	S.RES ERJ3GEYJ 101 V (100)	T	152.4/60.8
R62	7030003320	S.RES ERJ3GEYJ 101 V (100)	T	152.4/54.8
R63	7030003320	S.RES ERJ3GEYJ 101 V (100)	T	163.3/55.8
R64	7030003320	S.RES ERJ3GEYJ 101 V (100)	T	152.4/56.8
R65	7030003320	S.RES ERJ3GEYJ 101 V (100)	T	163.3/49.8
R66	7030003320	S.RES ERJ3GEYJ 101 V (100)	T	152.4/48.8
R71	7030003320	S.RES ERJ3GEYJ 101 V (100)	T	152.4/42.8
R72	7030003320	S.RES ERJ3GEYJ 101 V (100)	T	163.3/53.8
R73	7030003320	S.RES ERJ3GEYJ 101 V (100)	T	153.7/50.3
R74	7030003320	S.RES ERJ3GEYJ 101 V (100)	T	152.4/52.8
R75	7030003320	S.RES ERJ3GEYJ 101 V (100)	T	163.3/51.8
R76	7030003320	S.RES ERJ3GEYJ 101 V (100)	T	152.4/47.6
R77	7030003320	S.RES ERJ3GEYJ 101 V (100)	T	163.3/48.6
R78	7030003320	S.RES ERJ3GEYJ 101 V (100)	T	163.3/45.8
R79	7030003320	S.RES ERJ3GEYJ 101 V (100)	T	163.3/57.8
R81	7030010520	S.RES ERJ1TYJ 101U (100)	T	52.3/79.9
R103	7030003480	S.RES ERJ3GEYJ 222 V (2.2 k)	T	60.6/49
R104	7030003320	S.RES ERJ3GEYJ 101 V (100)	T	51.1/4.3
R105	7030003370	S.RES ERJ3GEYJ 271 V (270)	T	51.3/14.9
R106	7030003230	S.RES ERJ3GEYJ 180 V (18)	T	53.4/15.8
R107	7030003370	S.RES ERJ3GEYJ 271 V (270)	T	51.3/16.1
R108	7030003370	S.RES ERJ3GEYJ 271 V (270)	T	52.4/26.2
R109	7030003230	S.RES ERJ3GEYJ 180 V (18)	T	55.8/25.3
R110	7030003370	S.RES ERJ3GEYJ 271 V (270)	T	52.4/27.4
R111	7030003550	S.RES ERJ3GEYJ 822 V (8.2 k)	T	54.1/3.6
R112	7030003320	S.RES ERJ3GEYJ 101 V (100)	T	60.6/6.3
R113	7030003860	S.RES ERJ3GE JPW V	T	53.3/13.2
R201	7030003430	S.RES ERJ3GEYJ 821 V (820)	T	47.5/32.6
R202	7030003430	S.RES ERJ3GEYJ 821 V (820)	T	47.5/31.4
R203	7030003280	S.RES ERJ3GEYJ 470 V (47)	T	47.5/26.4
R204	7030003560	S.RES ERJ3GEYJ 103 V (10 k)	T	43.6/36.2
R205	7030003280	S.RES ERJ3GEYJ 470 V (47)	T	39.9/37.1
R206	7030003380	S.RES ERJ3GEYJ 331 V (330)	T	46/48.7
R207	7030003220	S.RES ERJ3GEYJ 150 V (15)	T	46.7/46.8
R208	7030003380	S.RES ERJ3GEYJ 331 V (330)	T	47.5/48.7
R209	7030003640	S.RES ERJ3GEYJ 473 V (47 k)	T	41.7/36.6
R210	7030003330	S.RES ERJ3GEYJ 121 V (120)	T	152.1/65.5
R211	7030011130	S.RES ERJ1TYJ 1R0U (1)	T	163.7/65.8
R301	7030003320	S.RES ERJ3GEYJ 101 V (100)	T	47/64.1
R302	7030003370	S.RES ERJ3GEYJ 271 V (270)	T	59.2/52.2
R303	7030003230	S.RES ERJ3GEYJ 180 V (18)	T	60/54
R304	7030003370	S.RES ERJ3GEYJ 271 V (270)	T	60.7/52.2
R305	7030003320	S.RES ERJ3GEYJ 101 V (100)	T	67.6/57.5
R306	7030003480	S.RES ERJ3GEYJ 222 V (2.2 k)	T	65.2/47
R307	7030003550	S.RES ERJ3GEYJ 822 V (8.2 k)	T	62.1/50.5
R308	7030003340	S.RES ERJ3GEYJ 151 V (150)	T	68.2/47
R402	7030003440	S.RES ERJ3GEYJ 102 V (1 k)	T	45/67
R403	7030003440	S.RES ERJ3GEYJ 102 V (1 k)	T	44.1/72.6
R404	7030003440	S.RES ERJ3GEYJ 102 V (1 k)	T	45.4/71.4
R405	7030003440	S.RES ERJ3GEYJ 102 V (1 k)	T	46.9/70.2
R410	7030003560	S.RES ERJ3GEYJ 103 V (10 k)	T	49.9/68.5
R411	7030003560	S.RES ERJ3GEYJ 103 V (10 k)	T	40.9/60.6
R412	7030003560	S.RES ERJ3GEYJ 103 V (10 k)	T	38.1/66
R413	7030003730	S.RES ERJ3GEYJ 274 V (270 k)	T	41.6/62.4
R414	7030003560	S.RES ERJ3GEYJ 103 V (10 k)	T	55.3/66.3
R415	7030003560	S.RES ERJ3GEYJ 103 V (10 k)	T	59/71.1
R416	7310005410	S.TRI EVM-3VXS50 BQ4 (473)	T	62.1/68.1
R417	7030003630	S.RES ERJ3GEYJ 104 V (100 k)	T	66.4/67.3
R418	7030003570	S.RES ERJ3GEYJ 123 V (12 k)	T	73.1/73.6
R419	7030003220	S.RES ERJ3GEYJ 150 V (15)	T	75.5/73.7
R421	7030003860	S.RES ERJ3GE JPW V	T	68.1/66.9
R422	7030003560	S.RES ERJ3GEYJ 103 V (10 k)	T	69.9/73.6
R423	7030003540	S.RES ERJ3GEYJ 682 V (6.8 k)	T	70.7/75.5
R424	7030003860	S.RES ERJ3GE JPW V	T	72.8/64.1
R429	7030003860	S.RES ERJ3GE JPW V	T	24.7/9
R431	7030003860	S.RES ERJ3GE JPW V	T	26.3/15.1
R433	7030005631	S.RES ERA3YKD 154V (150 k)	T	28.9/7.6
R435	7030005501	S.RES ERA3YKD 124V (120 k)	T	30.2/7.6
R436	7030005501	S.RES ERA3YKD 124V (120 k)	T	27/8.2
R437	7030003680	S.RES ERJ3GEYJ 104 V (100 k)	T	33.9/9
R438	7030003680	S.RES ERJ3GEYJ 104 V (100 k)	T	33.9/11.7
R500	7030003860	S.RES ERJ3GE JPW V	T	89.5/66.4
R501	7030003320	S.RES ERJ3GEYJ 101 V (100)	T	82.7/54.1
R502	7030003560	S.RES ERJ3GEYJ 103 V (10 k)	T	83.2/51.6
R503				

[SCOPE UNIT]

REF NO.	ORDER NO.	DESCRIPTION	M.	H/V LOCATION
R607	7030003560	S.RES ERJ3GEYJ 103 V (10 k)	T	127/70.7
R610	7030003800	S.RES ERJ3GEYJ 105 V (1 M)	T	98/53.7
R611	7030004040	S.RES ERJ3GEYJ 4R7 V (4.7)	T	94.2/56.4
R612	7030004040	S.RES ERJ3GEYJ 4R7 V (4.7)	T	95.4/57.9
R615	7030003320	S.RES ERJ3GEYJ 101 V (100)	T	99.2/53.6
R616	7030003520	S.RES ERJ3GEYJ 472 V (4.7 k)	T	103.9/43.1
R617	7030003520	S.RES ERJ3GEYJ 472 V (4.7 k)	T	105.1/43.1
R618	7030003520	S.RES ERJ3GEYJ 472 V (4.7 k)	T	105.9/45.1
R620	7030003560	S.RES ERJ3GEYJ 103 V (10 k)	T	125.4/73.4
R621	7030003560	S.RES ERJ3GEYJ 103 V (10 k)	T	122.6/73.8
R622	7030003860	S.RES ERJ3GE JPW V	T	108.8/45
R623	7030003860	S.RES ERJ3GE JPW V	T	103.9/66.9
R624	7030003560	S.RES ERJ3GEYJ 103 V (10 k)	T	122.6/72.5
R625	7030003560	S.RES ERJ3GEYJ 103 V (10 k)	T	123.1/70.7
R626	7030003560	S.RES ERJ3GEYJ 103 V (10 k)	T	121.7/70.7
R627	7030003560	S.RES ERJ3GEYJ 103 V (10 k)	T	105.5/47.9
R628	7030003560	S.RES ERJ3GEYJ 103 V (10 k)	T	123.2/40.6
R629	7030003560	S.RES ERJ3GEYJ 103 V (10 k)	T	122.6/43.2
R630	7030003560	S.RES ERJ3GEYJ 103 V (10 k)	T	121.1/43.2
R631	7030003560	S.RES ERJ3GEYJ 103 V (10 k)	T	120.5/39.2
R632	7030003560	S.RES ERJ3GEYJ 103 V (10 k)	T	119.7/41.8
R633	7030003560	S.RES ERJ3GEYJ 103 V (10 k)	T	118.7/39.5
R634	7030003860	S.RES ERJ3GE JPW V	T	101.9/58.5
R635	7030003560	S.RES ERJ3GEYJ 103 V (10 k)	T	118/42.1
R636	7030003560	S.RES ERJ3GEYJ 103 V (10 k)	T	105.1/66.9
R701	7030003240	S.RES ERJ3GEYJ 220 V (22)	T	134.7/34.3
R702	7030003560	S.RES ERJ3GEYJ 103 V (10 k)	T	129/34.3
R703	7030003320	S.RES ERJ3GEYJ 101 V (100)	T	132.8/34.3
R704	7030003280	S.RES ERJ3GEYJ 470 V (47)	T	136/32.4
R705	7030003340	S.RES ERJ3GEYJ 151 V (150)	T	128.5/32.4
R720	7030003370	S.RES ERJ3GEYJ 271 V (270)	T	148.9/28.3
R721	7030003560	S.RES ERJ3GEYJ 103 V (10 k)	T	150.1/28.3
R722	7030003340	S.RES ERJ3GEYJ 151 V (150)	T	152.5/28.3
R723	7030003440	S.RES ERJ3GEYJ 102 V (1 k)	T	141.6/6.6
R724	7030003440	S.RES ERJ3GEYJ 102 V (1 k)	T	141.6/5.4
R725	7030003440	S.RES ERJ3GEYJ 102 V (1 k)	T	138.4/4.8
R726	7030003440	S.RES ERJ3GEYJ 102 V (1 k)	T	141.6/4
R727	7030003440	S.RES ERJ3GEYJ 102 V (1 k)	T	137/28.6
R729	7030003280	S.RES ERJ3GEYJ 470 V (47)	T	144.5/26.3
R730	7030003560	S.RES ERJ3GEYJ 103 V (10 k)	T	145/29
R731	7030003460	S.RES ERJ3GEYJ 152 V (1.5 k)	T	150.2/20
R732	7030003510	S.RES ERJ3GEYJ 392 V (3.9 k)	T	151.5/15.7
R734	7030003510	S.RES ERJ3GEYJ 392 V (3.9 k)	T	147.6/24.2
R735	7030003280	S.RES ERJ3GEYJ 470 V (47)	T	151.1/13.2
R736	7030003280	S.RES ERJ3GEYJ 470 V (47)	T	151.5/14.4
R737	7030003440	S.RES ERJ3GEYJ 102 V (1 k)	T	138.2/6.6
R738	7030003640	S.RES ERJ3GEYJ 473 V (47 k)	T	133.2/27.6
R739	7030003510	S.RES ERJ3GEYJ 392 V (3.9 k)	T	151.5/17
R742	7030003860	S.RES ERJ3GE JPW V	T	131.9/27.5
R745	7030003860	S.RES ERJ3GE JPW V	T	130.9/9
R764	7030003370	S.RES ERJ3GEYJ 271 V (270)	T	121.7/2
R765	7030003230	S.RES ERJ3GEYJ 180 V (18)	T	119.9/1.2
R766	7030003370	S.RES ERJ3GEYJ 271 V (270)	T	118/2
R771	7030003860	S.RES ERJ3GE JPW V	T	110.8/1.2
R801	7030003440	S.RES ERJ3GEYJ 102 V (1 k)	T	113.6/16.5
R802	7030003440	S.RES ERJ3GEYJ 102 V (1 k)	T	114.8/13.1
R803	7030003440	S.RES ERJ3GEYJ 102 V (1 k)	T	114.7/14.6
R806	7030003520	S.RES ERJ3GEYJ 472 V (4.7 k)	T	106.1/18.7
R808	7030003600	S.RES ERJ3GEYJ 223 V (22 k)	T	105.3/21.2
R809	7030003840	S.RES ERJ3GEYJ 225 V (2.2 M)	T	107.6/20.2
R810	7030003370	S.RES ERJ3GEYJ 271 V (270)	T	117.7/13.8
R811	7030003560	S.RES ERJ3GEYJ 103 V (10 k)	T	121.7/18.8
R812	7030003280	S.RES ERJ3GEYJ 470 V (47)	T	114.6/10.2
R813	7030003340	S.RES ERJ3GEYJ 151 V (150)	T	117.5/24
R814	7030003500	S.RES ERJ3GEYJ 332 V (3.3 k)	T	103.9/19.7
R821	7030003680	S.RES ERJ3GEYJ 104 V (100 k)	T	83/24.5
R822	7030003680	S.RES ERJ3GEYJ 104 V (100 k)	T	90.5/23.2
R823	7030003370	S.RES ERJ3GEYJ 271 V (270)	T	87.1/20.3
R841	7030003200	S.RES ERJ3GEYJ 100 V (10)	T	81.6/18.5
R842	7030003360	S.RES ERJ3GEYJ 221 V (220)	T	85.8/13.6
R843	7030003500	S.RES ERJ3GEYJ 332 V (3.3 k)	T	83.8/17.7
R844	7030003540	S.RES ERJ3GEYJ 682 V (6.8 k)	T	82.3/16.4
R845	7030003360	S.RES ERJ3GEYJ 221 V (220)	T	82.3/15.1
R846	7030003380	S.RES ERJ3GEYJ 331 V (330)	T	84/10.6
R847	7030003370	S.RES ERJ3GEYJ 271 V (270)	T	74.7/15.5
R848	7030003540	S.RES ERJ3GEYJ 682 V (6.8 k)	T	70.2/14.6
R849	7030003500	S.RES ERJ3GEYJ 332 V (3.3 k)	T	73/12
R850	7030003390	S.RES ERJ3GEYJ 391 V (390)	T	72.4/17.7
R851	7030003360	S.RES ERJ3GEYJ 221 V (220)	T	68.8/18.9
R852	7030003490	S.RES ERJ3GEYJ 272 V (2.7 k)	T	74.4/21.1
R853	7030003510	S.RES ERJ3GEYJ 392 V (3.9 k)	T	74.4/24
R854	7030003360	S.RES ERJ3GEYJ 221 V (220)	T	68.8/21.5
R855	7030008180	S.RES ERJ12VJ331U (330)	T	87.5/32.2
R856	7030003370	S.RES ERJ3GEYJ 271 V (270)	T	66.8/43.9
R857	7030003230	S.RES ERJ3GEYJ 180 V (18)	T	64.5/43.1
R858	7030003320	S.RES ERJ3GEYJ 101 V (100)	T	64.5/44.6
R859	7030003260	S.RES ERJ3GEYJ 330 V (33)	T	68/24.7
R860	7030003400	S.RES ERJ3GEYJ 471 V (470)	T	86.1/10.6
R861	7030003860	S.RES ERJ3GE JPW V	T	68.2/43.9
R862	7030003320	S.RES ERJ3GEYJ 101 V (100)	T	1.7/25.1
R863	7030003320	S.RES ERJ3GEYJ 101 V (100)	T	12.7/30.9
R864	7030003320	S.RES ERJ3GEYJ 101 V (100)	T	21/29.9
R865	7030003320	S.RES ERJ3GEYJ 101 V (100)	T	10/24.1
R866	7030003320	S.RES ERJ3GEYJ 101 V (100)	T	1.7/23.1
R867	7030003320	S.RES ERJ3GEYJ 101 V (100)	T	1.7/27.1
R868	7030003320	S.RES ERJ3GEYJ 101 V (100)	T	10/28.1
R869	7030003860	S.RES ERJ3GE JPW V	T	10/22.1
R870	7030003320	S.RES ERJ3GEYJ 101 V (100)	T	12.7/26.9
R871	7030003320	S.RES ERJ3GEYJ 101 V (100)	T	21/27.9
R872	7030003320	S.RES ERJ3GEYJ 101 V (100)	T	21/31.9
R873	7030003320	S.RES ERJ3GEYJ 101 V (100)	T	12.7/32.9
R874	7030003320	S.RES ERJ3GEYJ 101 V (100)	T	21/33.9
R876	7030003320	S.RES ERJ3GEYJ 101 V (100)	T	12.7/28.9
R877	7030003860	S.RES ERJ3GE JPW V	T	12.7/34.9

[SCOPE UNIT]

REF NO.	ORDER NO.	DESCRIPTION	M.	H/V LOCATION
R878	7030003320	S.RES ERJ3GEYJ 101 V (100)	T	165.9/46.8
R879	7030003320	S.RES ERJ3GEYJ 101 V (100)	T	174.2/47.8
R880	7030003320	S.RES ERJ3GEYJ 101 V (100)	T	174.2/49.8
R881	7030003320	S.RES ERJ3GEYJ 101 V (100)	T	165.9/50.8
R882	7030003320	S.RES ERJ3GEYJ 101 V (100)	T	174.2/51.8
R883	7030003320	S.RES ERJ3GEYJ 101 V (100)	T	174.2/53.8
R884	7030003320	S.RES ERJ3GEYJ 101 V (100)	T	165.9/54.8
R885	7030003320	S.RES ERJ3GEYJ 101 V (100)	T	174.2/55.8
R886	7030003320	S.RES ERJ3GEYJ 101 V (100)	T	165.9/56.8
R887	7030003320	S.RES ERJ3GEYJ 101 V (100)	T	174.2/57.8
R888	7030003320	S.RES ERJ3GEYJ 101 V (100)	T	165.9/58.8
R889	7030003320	S.RES ERJ3GEYJ 101 V (100)	T	174.2/59.8
R890	7030003860	S.RES ERJ3GE JPW V	T	165.9/60.8
R891	7030003860	S.RES ERJ3GE JPW V	T	174.2/61.8
C1	4030006880	S.CER C1608 JB 1H 472K-T	T	23.5/72.1
C3	4030006880	S.CER C1608 JB 1H 472K-T	T	19/69.1
C4	4030011340	S.CER C1608 CH 1H 471J-T	T	17.1/63.3
C5	4030011340	S.CER C1608 CH 1H 471J-T	T	20.3/60.8
C6	4030006880	S.CER C1608 JB 1H 472K-T	T	17.1/61.6
C7	4030006880	S.CER C1608 JB 1H 472K-T	T	20.4/56.8
C8	4030006880	S.CER C1608 JB 1H 472K-T	T	13.2/58
C9	4030006880	S.CER C1608 JB 1H 472K-T	T	17.5/56.7
C10	4030011600	S.CER C1608 JB 1E 104K-T	T	23.7/54.5
C11	4030009510	S.CER C1608 CH 1H 010B-T	T	16.9/47.4
C12	4030007040	S.CER C1608 CH 1H 180J-T	T	22.4/44.1
C13	4030007040	S.CER C1608 CH 1H 180J-T	T	18.2/40.9
C14	4030011340	S.CER C1608 CH 1H 471J-T	T	28.2/35.4
C15	4030006880	S.CER C1608 JB 1H 472K-T	T	26.4/33.2
C16	4030006880	S.CER C1608 JB 1H 472K-T	T	32.2/19.8
C17	4030006880	S.CER C1608 JB 1H 472K-T	T	36.4/25.2
C18	4030006960	S.CER C1608 CH 1H 050C-T	T	29.8/26.5
C21	4030006880	S.CER C1608 JB 1H 472K-T	T	125.9/32.4
C22	4030006880	S.CER C1608 JB 1H 472K-T	T	23.5/73.6
C23	4030011600	S.CER C1608 JB 1E 104K-T	T	152.4/44.8
C24	4030011600	S.CER C1608 JB 1E 104K-T	T	23.5/70.9
C39	4030011600	S.CER C1608 JB 1E 104K-T	T	20.8/74.7
C40	4030011600	S.CER C1608 JB 1E 104K-T	T	20.9/70.9
C41	4610001830	S.TRI TZB4S100AB10R00	T	13.9/44.2
C42	4030007030	S.CER C1608 CH 1H 150J-T	T	17.5/55.4
C43	4030007120	S.CER C1608 CH 1H 820J-T	T	15.5/54.6
C44	4030007100	S.CER C1608 CH 1H 560J-T	T	17.5/53.7
C45	4030007400	S.CER C1608 CH 1H 180J-T	T	16.8/51.6
C46	4030008750	S.CER C1608 CH 1H 360J-T	T	18.3/51.6
C53	4510008540	S.ELE EEE1CA100SR	T	59.3/76.9
C54	4510008540	S.ELE EEE1CA100SR	T	74.4/50.4
C55	4030011600	S.CER C1608 JB 1E 104K-T	T	48/75.9
C56	4510008540	S.ELE EEE1CA100SR	T	44.2/76.9
C57	4030011600	S.CER C1608 JB 1E 104K-T	T	55.3/76.3
C101	4030006880	S.CER C1608 JB 1H 472K-T	T	60.6/37.8
C102	4030007150	S.CER C1608 CH 1H 151J-T	T	53/5.4
C103	4030011600	S.CER C1608 JB 1E 104K-T	T	48.7/6.5
C106	4030006880	S.CER C1608 JB 1H 472K-T	T	60.6/7.5
C107	4030007100	S.CER C1608 CH 1H 560J-T	T	53/8
C108	4030007110	S.CER C1608 CH 1H 680J-T	T	54.8/9.9
C109	4030007110	S.CER C1608 CH 1H 121J-T	T	53/10.6
C110	4030007140	S.CER C1608 CH 1H 680J-T	T	54.8/11.4
C201	4030007040	S.CER C1608 CH 1H 180J-T	T	58.4/35.2
C202	4030007040	S.CER C1608 CH 1H 180J-T	T	53.7/37.6
C204	4030006880	S.CER C1608 JB 1H 472K-T	T	47.5/33.8
C205	4030007070	S.CER C1608 CH 1H 330J-T	T	44/25.2
C206	4030006880	S.CER C1608 JB 1H 472K-T	T	47.5/27.6
C207	4030006960	S.CER C1608 CH 1H 050C-T	T	44.8/34.8
C208	4030007070	S.CER C1608 CH 1H 330J-T	T	41.7/37.8
C209	4030006880	S.CER C1608 JB 1H 472K-T	T	39.2/39.7
C210	4030011600	S.CER C1608 JB 1E 104K-T	T	37.7/44.8
C211	4030009550	S.CER C1608 CH 1E 2R5B-T	T	59.6/35.3
C212	4030006940	S.CER C1608 CH 1H 030C-T	T	52.5/37.6
C213	4550007660	S.TAN F930G107MBABMA	T	155.7/74.6
C214	4510009270	S.ELE EEEH1C220UR	T	162.4/70.5
C215	4030011600	S.CER C1608 JB 1E 104K-T	T	157/64.7
C216	4030011600	S.CER C1608 JB 1A 104K-T	T	154.3/64.7
C301	4030007040	S.CER C1608 CH 1H 180J-T	T	62.6/54
C302	4030006880	S.CER C1608 JB 1H 472K-T	T	67.6/54.7
C303	4030006880	S.CER C1608 JB 1H 472K-T	T	63.8/47
C304	4030006880	S.CER C1608 JB 1H 472K-T	T	66.8/47
C401	4030008850	S.CER		

[RF-B UNIT]

REF NO.	ORDER NO.	DESCRIPTION	M.	H/V LOCATION
C506	4030011600	S.CER C1608 JB 1E 104K-T	T	89.1/62.9
C507	4510008580	S.ELE EEE0JA470SR	T	78.6/68.5
C508	4030017490	S.CER C1608 JB 1A 105K-T	T	76.9/64
C509	4030011600	S.CER C1608 JB 1E 104K-T	T	87.2/69
C521	4510008540	S.ELE EEE1CA100SR	T	91.4/79.3
C522	4030011600	S.CER C1608 JB 1E 104K-T	T	87.3/79.4
C523	4550006250	S.TAN TEESVA 1A 106M8R	T	79.4/77.2
C524	4030011600	S.CER C1608 JB 1E 104K-T	T	81.1/77.6
C551	4550007460	S.TAN F930G107MBA BMA	T	126.8/41.6
C601	4030011600	S.CER C1608 JB 1E 104K-T	T	113.7/70.6
C602	4030011600	S.CER C1608 JB 1E 104K-T	T	115.5/70.8
C603	4030011600	S.CER C1608 JB 1E 104K-T	T	117.8/70.6
C604	4030011600	S.CER C1608 JB 1E 104K-T	T	119.1/70.6
C605	4030011600	S.CER C1608 JB 1E 104K-T	T	120.5/70.7
C606	4030011600	S.CER C1608 JB 1E 104K-T	T	125.7/70.8
C607	4030011600	S.CER C1608 JB 1E 104K-T	T	131.4/64.5
C608	4030011600	S.CER C1608 JB 1E 104K-T	T	131.4/62.9
C609	4030011600	S.CER C1608 JB 1E 104K-T	T	130.6/59.2
C610	4030011600	S.CER C1608 JB 1E 104K-T	T	131.4/57.1
C611	4030011600	S.CER C1608 JB 1E 104K-T	T	131.4/54.9
C612	4030011600	S.CER C1608 JB 1E 104K-T	T	131.4/52.9
C613	4030011600	S.CER C1608 JB 1E 104K-T	T	130.6/50.2
C614	4030011600	S.CER C1608 JB 1E 104K-T	T	129.4/47.4
C615	4030011600	S.CER C1608 JB 1E 104K-T	T	125.6/44.5
C616	4030011600	S.CER C1608 JB 1E 104K-T	T	124.4/44.7
C617	4030011600	S.CER C1608 JB 1E 104K-T	T	121.9/45.1
C618	4030011600	S.CER C1608 JB 1E 104K-T	T	119.4/44.4
C619	4030011600	S.CER C1608 JB 1E 104K-T	T	117/44.7
C620	4030011600	S.CER C1608 JB 1E 104K-T	T	115.8/44.7
C621	4030011600	S.CER C1608 JB 1E 104K-T	T	113.9/45.5
C622	4030011600	S.CER C1608 JB 1E 104K-T	T	111.3/45.5
C623	4030011600	S.CER C1608 JB 1E 104K-T	T	105.2/50.2
C624	4030011600	S.CER C1608 JB 1E 104K-T	T	105.2/51.6
C625	4030011600	S.CER C1608 JB 1E 104K-T	T	105.1/56.6
C626	4030011600	S.CER C1608 JB 1E 104K-T	T	105.5/58.9
C627	4030011600	S.CER C1608 JB 1E 104K-T	T	105/63.7
C628	4030011600	S.CER C1608 JB 1E 104K-T	T	106.2/63.7
C629	4030011600	S.CER C1608 JB 1E 104K-T	T	105.5/54.7
C660	4510008540	S.ELE EEE1CA100SR	T	96.5/45.9
C661	4030011600	S.CER C1608 JB 1E 104K-T	T	98/51.5
C662	4030011600	S.CER C1608 JB 1E 104K-T	T	127.2/44.7
C663	4030011600	S.CER C1608 JB 1E 104K-T	T	96.7/56.4
C664	4030011600	S.CER C1608 JB 1E 104K-T	T	94.2/53.8
C666	4550007310	S.TAN F930J227MNM BMA	T	132.5/43.7
C667	4550007310	S.TAN F930J227MNM BMA	T	137.3/43.7
C671	4030011600	S.CER C1608 JB 1E 104K-T	T	148/48.2
C672	4030006880	S.CER C1608 JB 1H 472K-T	T	100.4/53.6
C702	4030011600	S.CER C1608 JB 1E 104K-T	T	130.9/35.3
C703	4030011600	S.CER C1608 JB 1E 104K-T	T	133.4/32.4
C720	4030006880	S.CER C1608 JB 1H 472K-T	T	127.9/19.6
C721	4030011600	S.CER C1608 JB 1E 104K-T	T	128.3/21.7
C722	4510008540	S.ELE EEE1CA100SR	T	127.6/25.6
C723	4030006880	S.CER C1608 JB 1H 472K-T	T	155/18.7
C724	4030011600	S.CER C1608 JB 1E 104K-T	T	155/19.9
C725	4510008540	S.ELE EEE1CA100SR	T	155.2/15.2
C726	4030006880	S.CER C1608 JB 1H 472K-T	T	149.4/25.7
C727	4030006880	S.CER C1608 JB 1H 472K-T	T	151.3/28.3
C730	4030011600	S.CER C1608 JB 1E 104K-T	T	129.2/16.8
C731	4030011600	S.CER C1608 JB 1E 104K-T	T	129.2/19.6
C733	4030011600	S.CER C1608 JB 1E 104K-T	T	138.5/7.8
C734	4030011600	S.CER C1608 JB 1E 104K-T	T	148.2/11.4
C736	4030011600	S.CER C1608 JB 1E 104K-T	T	141.9/26.3
C737	4030011600	S.CER C1608 JB 1E 104K-T	T	148.1/22.3
C738	4030011600	S.CER C1608 JB 1E 104K-T	T	141.8/7.8
C739	4030011600	S.CER C1608 JB 1E 104K-T	T	144.6/7.8
C740	4030011600	S.CER C1608 JB 1E 104K-T	T	148.1/18.9
C741	4030011600	S.CER C1608 JB 1E 104K-T	T	137.7/26.6
C742	4030011600	S.CER C1608 JB 1E 104K-T	T	135/26.6
C750	4030006900	S.CER C1608 JB 1H 103K-T	T	148.2/16
C751	4030006900	S.CER C1608 JB 1H 103K-T	T	150.2/18.8
C761	4030007150	S.CER C1608 CH 1H 151J-T	T	149.8/11.4
C762	4030007110	S.CER C1608 CH 1H 680J-T	T	151.8/8.9
C763	4030011280	S.CER C1608 CH 1H 271J-T	T	149.1/8.9
C764	4030007080	S.CER C1608 CH 1H 390J-T	T	153.6/8.4
C765	4030011830	S.CER C1608 CH 1H 301J-T	T	148.9/7.7
C766	4030007020	S.CER C1608 CH 1H 120J-T	T	149.3/5.9
C767	4030007170	S.CER C1608 CH 1H 221J-T	T	148.1/5.9
C768	4030011280	S.CER C1608 CH 1H 271J-T	T	137.1/1.9
C769	4030006860	S.CER C1608 JB 1H 102K-T	T	134.1/2.7
C770	4030011280	S.CER C1608 CH 1H 271J-T	T	132.2/2
C801	4030006880	S.CER C1608 JB 1H 472K-T	T	109.9/18.6
C802	4510008540	S.ELE EEE1CA100SR	T	112.7/23.4
C803	4030006900	S.CER C1608 JB 1H 103K-T	T	104/15.7
C805	4550003220	S.TAN TEESVA 1E 105M8R	T	102.1/17.3
C806	4340000240	S.MLR ECHU 1C 682JX5	T	107.8/21.9
C807	4030006880	S.CER C1608 JB 1H 472K-T	T	113.2/11.9
C808	4030006880	S.CER C1608 JB 1H 472K-T	T	160.9/15.2
C809	4510008540	S.ELE EEE1CA100SR	T	164/10.1
C810	4030006880	S.CER C1608 JB 1H 472K-T	T	117.5/21.4
C811	4030006880	S.CER C1608 JB 1H 472K-T	T	117/11.5
C812	4030006880	S.CER C1608 JB 1H 472K-T	T	117.5/9.5
C813	4030011600	S.CER C1608 JB 1E 104K-T	T	109.6/10.4
C821	4030007060	S.CER C1608 CH 1H 270J-T	T	101.4/25.1
C822	4030007100	S.CER C1608 CH 1H 560J-T	T	98/24.3
C823	4030006960	S.CER C1608 CH 1H 050C-T	T	99.3/24.3
C824	4610001850	S.TRI T2B4R200AB10R00	T	94.3/23.3
C825	4030007130	S.CER C1608 CH 1H 101J-T	T	90.6/25.4
C826	4030007060	S.CER C1608 CH 1H 270J-T	T	84.5/24.5
C827	4030007020	S.CER C1608 CH 1H 120J-T	T	89.1/23.2
C828	4030006880	S.CER C1608 JB 1H 472K-T	T	87.1/21.7
C829	4030009500	S.CER C1608 CH 1H 0R5B-T	T	81.6/21.5
C830	4030006860	S.CER C1608 JB 1H 102K-T	T	83.2/35.1
C831	4030006880	S.CER C1608 JB 1H 472K-T	T	83.2/33.9
C832	4510008500	S.ELE EEE1CA101WP	T	87.6/38.1

[SCOPE UNIT]

REF NO.	ORDER NO.	DESCRIPTION	M.	H/V LOCATION
C833	4510008540	S.ELE EEE1CA100SR	T	81.6/39.2
C842	4030006880	S.CER C1608 JB 1H 472K-T	T	83.1/13.6
C843	4030006880	S.CER C1608 JB 1H 472K-T	T	67.3/12.4
C844	4030006880	S.CER C1608 JB 1H 472K-T	T	68.6/12.4
C845	4510008520	S.ELE EEE1CA470SP	T	75.7/37.8
C846	4030006880	S.CER C1608 JB 1H 472K-T	T	82.1/19.9
C847	4030006880	S.CER C1608 JB 1H 472K-T	T	73/13.3
C848	4030006880	S.CER C1608 JB 1H 472K-T	T	73.1/19
C849	4030006880	S.CER C1608 JB 1H 472K-T	T	73.1/21.1
C850	4030006880	S.CER C1608 JB 1H 472K-T	T	68.8/20.2
C851	4030006880	S.CER C1608 JB 1H 472K-T	T	68.8/22.8
C852	4030007120	S.CER C1608 CH 1H 820J-T	T	68/26.5
C853	4030007070	S.CER C1608 CH 1H 330J-T	T	67.9/28.4
C854	4030007140	S.CER C1608 CH 1H 121J-T	T	73.7/26.5
C855	4030007020	S.CER C1608 CH 1H 120J-T	T	73.7/28.8
C856	4030007090	S.CER C1608 CH 1H 470J-T	T	73.8/31
C862	4030006880	S.CER C1608 JB 1H 472K-T	T	104/13.1
J1	6510007020	CNR TMP-J01X-V6		
J3	6510007020	CNR TMP-J01X-V6		
J11	6510007020	CNR TMP-J01X-V6		
J601	6510019971	S.CNR 52808-1071	T	102.1/32.4
J2013	6510023261	S.CNR B6B-PH-SM4-TB (LF) (SN)	T	173.1/32.6
J2016	6510020091	S.CNR 52808-0871 (0890)	T	5.9/25.6
J2017	6510019971	S.CNR 52808-1071	T	16.9/30.4
J2020	6510019991	S.CNR 52808-2271 (2291)	T	157.8/50.3
J2021	6510019981	S.CNR 52808-1671 (1690)	T	170.1/53.3
EP54	6910014690	S.BEA MPZ1608S221A-T	T	166.6/32.2
EP55	6910014690	S.BEA MPZ1608S221A-T	T	171.4/13.5
EP56	6910014690	S.BEA MPZ1608S221A-T	T	141.4/34.8
EP57	6910014690	S.BEA MPZ1608S221A-T	T	166.6/29.6
EP58	6910014690	S.BEA MPZ1608S221A-T	T	157.5/23.6
EP59	6910014690	S.BEA MPZ1608S221A-T	T	166.6/33.6
EP60	6910014690	S.BEA MPZ1608S221A-T	T	166.6/31

M.=Mounted side (T: Mounted on the Top side B: Mounted on the Bottom side)
S.=Surface mount

[LOGIC UNIT]

REF NO.	ORDER NO.	DESCRIPTION	M.	H/V LOCATION
IC1	1130014630	S.IC MT48LC16M16A2P IT	T	94.7/50.3
IC2	1130014630	S.IC MT48LC16M16A2P IT	T	94.7/34.2
IC51	1130011591	S.IC IDT70V24L15PFG	B	168/84.3
IC52	1140009781	S.IC XC9572XL-10TQG100C	B	139.7/86.9
IC53	1110005821	S.IC R3112N281A-TR-F	B	15/60.9
IC54	1130007431	S.IC TC7S14FU (TE85R,F)	B	19.8/61.9
IC55	1130008041	S.IC TC7SH04FU (TE85L,JF)	B	22.7/62.6
IC56	1130010111	S.IC TC7WH04FU (TE12L,F)	T	265/70.9
IC101	1130011010	S.IC SN74C85 (TE85R,F)	T	206.5/48.9
IC102	1130006441	S.IC TC7S08F (TE85R,F)	B	148.2/67.8
IC103	1140011561	S.IC HD6417751RBP200V	T	132.4/39.2
IC104	1130008361	S.IC TC7SHU04FU (TE85L,JF)	T	161.4/46.2
IC105	1130012241	S.IC CY2292FXC (SX-2590J)	B	158.2/43.8
IC106	1130011110	S.IC TC74VCX04FT (EL)	T	159.2/39.9
IC201	1130014630	S.IC MT48LC16M16A2P IT	T	78.8/82.8
IC202	1130014630	S.IC MT48LC16M16A2P IT	T	62.7/82.8
IC203	1140011571	S.IC HD64404BTDV	T	61/51.6
IC204	1140011581	S.IC ADV7123KSTZ50	B	77/9.2
IC205	1130011941	S.IC TC7SZ04F (TE85L,F)	B	82.1/16.3
IC206	1130012150	S.IC SN74ACT04PWR	B	104.5/4.8
IC208	1130014030	S.IC BD6516F-E2	T	22.3/73.4
IC209	1190001920	S.IC AK5355-VT-E2	B	94.3/78.7
IC210	1190001920	S.IC AK5355-VT-E2	B	104/78.7
IC211	1190001910	S.IC AK4384-VT-E2	B	110.7/78.7
IC212	1190001910	S.IC AK4384-VT-E2	B	116.6/78.7
IC403	1130009570	S.IC BR93LC46F-WE2	T	169/40.2
IC404	1130010990	S.IC RTL8139C <GMI>	B	180.9/41.9
IC601	1130008041	S.IC TC7SH04FU (TE85L,JF)	T	251.7/64
IC602	1130008711	S.IC TC7SET04FU (T5L,JF)	T	256.5/65
IC603	1110004770	S.IC BU9480F-E2	B	219.6/69.9
IC604	1140011590	S.IC HD64F2377VQ33V	B	198.4/77.7
IC605	1140009781	S.IC XC9572XL-10TQG100C	T	175.5/104
IC607	1130006441	S.IC TC7S08F (TE85R,F)	B	206.9/63.3
IC608	1130006441	S.IC TC7S08F (TE85R,F)	B	212.6/63.3
IC609	1130005252	S.IC TC74HC08AF (EL,F)	T	178/63.5
IC610	1140008650	S.IC HN58X2464TI	T	194.9/63.8
IC801	1180003170	S.REG uPC2933BT-E1-AZ	T	21.9/42.4
IC802	1180001541	S.IC TA78L08F (TE12L,F)	T	21.9/56.4
IC821	1110002700	S.IC NJM2904M-TE1-#FMZB	T	253.4/33.2
IC851	1110003870	S.IC NJM2058M-TE1	B	235.6/63.4
IC852	1110003870	S.IC NJM2058M-TE1	B	114.6/96.2
IC853	1110003870	S.IC NJM2058M-TE1	B	97.8/94.3
IC854	1130005721	S.IC TC7W04F (TE12L,F)	T	51.2/102.5
IC2051	1130009831	S.IC TC74VHCT04AF (F)	T	264.9/88.4
IC2052	1130005252	S.IC TC74HC08AF (EL,F)	B	264.9/94.7
IC2053	1130005721	S.IC TC7W04F (TE12L,F)	T	265/99.2
IC2054	1120002921	S.IC ADM202EARNZ	T	275.1/94.6
Q601	1530002060	S.TR 2SC4081 T106 R	T	256.8/71.4
Q602	1510000510	S.TR 2SA1576A T106R	T	251.7/67
Q802	1530002060	S.TR 2SC4081 T106 R	T	242.6/83.7
Q803	1540000441	S.TR 2SD1619T-TD-E	T	238.6/85.5
Q804	1540000441	S.TR 2SD1619T-TD-E	T	238.6/78.3
Q805	1530002060	S.TR 2SC4081 T106 R	T	242.6/76.5
Q810	1540000550	S.TR 2SD1664 T100Q	T	238.6/91.3
Q821	1520000651	S.TR 2SB1201S-TL-E	T	242.2/34.9
Q822	1530002060	S.TR 2SC4081 T106 R	T	247.8/38
Q901	1590001960	S.TR XP4311 (TX)	B	15.6/100.9
Q902	1590001960	S.TR XP4311 (TX)	B	5.7/100.2
Q2051	1510000510	S.TR 2SA1576A T106R	T	258.9/85.5
Q2052	1530002280	S.TR 2SC4081 T106 S	T	254.9/79.4
D51	1750000550	S.DIO 1SS355 TE-17	T	143.6/99.8
D52	1750000550	S.DIO 1SS355 TE-17	T	141.9/99.8
D53	1750000550	S.DIO 1SS355 TE-17	T	140.3/99.8
D54	1750000550	S.DIO 1SS355 TE-17	T	138.6/99.8
D55	1750000550	S.DIO 1SS355 TE-17	T	137/99.8
D56	1750000550	S.DIO 1SS355 TE-17	T	135.3/99.8
D57	1750000550	S.DIO 1SS355 TE-17	T	133.7/99.8
D58	1750000550	S.DIO 1SS355 TE-17	T	132/99.8
D59	1750000550	S.DIO 1SS355 TE-17	T	130.4/99.8
D60	1750000550	S.DIO 1SS355 TE-17	T	143.6/103.6
D61	1750000550	S.DIO 1SS355 TE-17	T	141.9/103.6
D62	1750000550	S.DIO 1SS355 TE-17	T	140.3/103.6
D63	1750000550	S.DIO 1SS355 TE-17	T	138.6/103.6
D64	1750000550	S.DIO 1SS355 TE-17	T	137/103.6
D65	1750000550	S.DIO 1SS355 TE-17	T	135.3/103.6
D66	1750000550	S.DIO 1SS355 TE-17	T	133.7/103.6
D67	1750000550	S.DIO 1SS355 TE-17	T	132/103.6
D68	1750000550	S.DIO 1SS355 TE-17	T	130.4/103.6
D201	1790000980	S.DIO MA742 (TX)	B	91.7/11.1
D202	1790000980	S.DIO MA742 (TX)	B	91.7/11.1
D203	1790000980	S.DIO MA742 (TX)	B	91.7/16.8
D204	1790000980	S.DIO MA742 (TX)	B	110.1/7.9
D205	1790000980	S.DIO MA742 (TX)	B	110.1/3
D206	1790000980	S.DIO MA742 (TX)	B	16/71.7
D207	1790000980	S.DIO MA742 (TX)	B	16/68.2
D208	1790000980	S.DIO MA742 (TX)	B	16/79.3
D209	1790000980	S.DIO MA742 (TX)	B	16/75.8
D601	1750000550	S.DIO 1SS355 TE-17	T	254.7/71.3
D801	1750000370	S.DIO DA221 TL	B	238.7/89.2
D802	1750000370	S.DIO DA221 TL	B	238.7/82
D805	1790001611	S.DIO 1SS385 (TE85L,F)	B	194.1/113.5
D821	1730002340	S.ZEN MA8047-M (TX)	T	247.9/35.1
D851	1750000550	S.DIO 1SS355 TE-17	B	241.9/67.6

[LOGIC UNIT]

REF NO.	ORDER NO.	DESCRIPTION	M.	H/V LOCATION
D852	1750000550	S.DIO 1SS355 TE-17	B	230.4/67.6
D853	1790000980	S.DIO MA742 (TX)	T	99.2/94
D854	1790000980	S.DIO MA742 (TX)	B	104.9/92.7
D855	1790000980	S.DIO MA742 (TX)	B	88.4/86.7
D856	1790000980	S.DIO MA742 (TX)	T	99.1/89.3
D857	1750000550	S.DIO 1SS355 TE-17	B	230.8/57.3
D858	1750000550	S.DIO 1SS355 TE-17	B	239.3/57.1
D860	1790000980	S.DIO MA742 (TX)	B	188.2/108.2
D861	1790000980	S.DIO MA742 (TX)	B	188.2/110.7
D862	1790000980	S.DIO MA742 (TX)	B	188.2/113.2
D863	1790000980	S.DIO MA742 (TX)	B	188.2/115.7
D864	1790000980	S.DIO MA742 (TX)	B	194.4/101.2
D865	1790000980	S.DIO MA742 (TX)	B	194.4/106.2
D866	1790000980	S.DIO MA742 (TX)	B	194.4/103.7
D867	1790000980	S.DIO MA742 (TX)	B	194.4/108.7
D901	1790000980	S.DIO MA742 (TX)	B	194.4/115.9
D2051	1750000550	S.DIO 1SS355 TE-17	T	257.1/79.5
X101	6050011610	S.XTL CR-751 (25.000 MHz)	T	160.6/52.4
X201	6050010690	S.XTL CR-628 (24.576 MHz)	T	42.9/56.6
X202	6050011910	S.XTL CR-780 (48 MHz)	T	79.6/52.9
X601	6050011810	S.XTL CR-755 (15.9744 MHz)	T	201.3/94.5
L203	6200002631	S.COL NLV25T-R10J	B	96/10.8
L204	6200002631	S.COL NLV25T-R10J	B	96/13.7
L205	6200002631	S.COL NLV25T-R10J	B	96/16.5
L801	6200003261	S.COL NLV32T-101J	T	223.7/32.2
L803	6180003321	S.COL SLF6028T-150M1R0-PF	T	200.8/35.7
L804	6180003321	S.COL SLF6028T-150M1R0-PF	T	198.2/27.6
L805	6180003321	S.COL SLF6028T-150M1R0-PF	T	191.7/27.7
L806	6180003321	S.COL SLF6028T-150M1R0-PF	T	176.6/16.1
L807	6180003321	S.COL SLF6028T-150M1R0-PF	T	200.8/5.9
L808	6200013300	S.COL SLF12555T-150M2R8-PF	T	197.8/16.4
L811	6200001831	S.COL NLV32T-100J	T	203.5/27.5
L826	6180003321	S.COL SLF6028T-150M1R0-PF	T	21.2/14.6
L2051	6200003241	S.COL NLV32T-221J	T	257.7/101.6
R1	7030003520	S.RES ERJ3GEYJ 472 V (4.7 k)	T	89.5/69.8
R51	7030003520	S.RES ERJ3GEYJ 472 V (4.7 k)	B	129.4/93.4
R52	7030003560	S.RES ERJ3GEYJ 103 V (10 k)	B	17.6/61.1
R55	7030003440	S.RES ERJ3GEYJ 102 V (1 k)	B	144.1/96.4
R56	7030003440	S.RES ERJ3GEYJ 102 V (1 k)	B	147.1/95.6
R57	7030003680	S.RES ERJ3GEYJ 104 V (100 k)	T	260.7/71.9
R58	7030003680	S.RES ERJ3GEYJ 104 V (100 k)	T	260.7/70.6
R101	7030003680	S.RES ERJ3GEYJ 104 V (100 k)	T	266.3/68.6
R102	7030003520	S.RES ERJ3GEYJ 472 V (4.7 k)	T	201.1/50.5
R103	7030003520	S.RES ERJ3GEYJ 472 V (4.7 k)	T	201.2/48.6
R104	7030003520	S.RES ERJ3GEYJ 472 V (4.7 k)	T	211.2/50.7
R105	7030003520	S.RES ERJ3GEYJ 472 V (4.7 k)	T	212/49.7
R106	7030003560	S.RES ERJ3GEYJ 103 V (10 k)	B	137.2/40.3
R107	7030003560	S.RES ERJ3GEYJ 103 V (10 k)	B	137.2/35.1
R108	7030003560	S.RES ERJ3GEYJ 103 V (10 k)	B	148.1/36.1
R109	7030003560	S.RES ERJ3GEYJ 103 V (10 k)	B	138.5/37.7
R110	7030003560	S.RES ERJ3GEYJ 103 V (10 k)	T	148/38.1
R111	7030003560	S.RES ERJ3GEYJ 103 V (10 k)	B	138.5/40.3
R112	7030003560	S.RES ERJ3GEYJ 103 V (10 k)	T	148/36.8
R113	7030003560	S.RES ERJ3GEYJ 103 V (10 k)	B	138.5/35.1
R114	7030003560	S.RES ERJ3GEYJ 103 V (10 k)	B	148.1/33.5
R115	7030003560	S.RES ERJ3GEYJ 103 V (10 k)	B	134.6/35.1
R116	7030003560	S.RES ERJ3GEYJ 103 V (10 k)	B	135.9/35.1
R117	7030003260	S.RES ERJ3GEYJ 330 V (33)	B	148.1/29.7
R118	7030003560	S.RES ERJ3GEYJ 103 V (10 k)	B	133.3/35.1
R119	7030003560	S.RES ERJ3GEYJ 103 V (10 k)	B	147.5/27.6
R120	7030003560	S.RES ERJ3GEYJ 103 V (10 k)	B	132/35.1
R121	7030003560	S.RES ERJ3GEYJ 103 V (10 k)	B	152/29.7
R122	7030003560	S.RES ERJ3GEYJ 103 V (10 k)	B	150.7/29.7
R123	7030003560	S.RES ERJ3GEYJ 103 V (10 k)	B	142.2/25
R124	7030003680	S.RES ERJ3GEYJ 104 V (100 k)	T	148/34.2
R125	7030003520	S.RES ERJ3GEYJ 472 V (4.7 k)	T	148/35.5
R126	7030003560	S.RES ERJ3GEYJ 103 V (10 k)	B	135.9/37.7
R127	7030003560	S.RES ERJ3GEYJ 103 V (10 k)	B	137.2/37.7
R128	7030003560	S.RES ERJ3GEYJ 103 V (10 k)	T	151.4/36.8
R129	7030003560	S.RES ERJ3GEYJ 103 V (10 k)	T	151.4/38.1
R130	7030003560	S.RES ERJ3GEYJ 103 V (10 k)	B	146.8/42
R131	7030003560	S.RES ERJ3GEYJ 103 V (10 k)	B	135.9/40.3
R132	7030003560	S.RES ERJ3GEYJ 103 V (10 k)	T	148/39.4
R133	7030003560	S.RES ERJ3GEYJ 103 V (10 k)	T	151.4/39.4
R134	7030003200	S.RES ERJ3GEYJ 100 V (10)	B	138.5/42.9
R135	7030003200	S.RES ERJ3GEYJ 100 V (10)	B	137.2/42.9
R136	7030003200	S.RES ERJ3GEYJ 100 V (10)	B	146.8/55.3
R137	7030004050	S.RES ERJ3GEYJ 1R0 V (1)	B	129.3/35.1
R138	7030003560	S.RES ERJ3GEYJ 103 V (10 k)	B	128/35.1
R139	7030003560	S.RES ERJ3GEYJ 103 V (10 k)	B	119.2/34.2
R140	7410000990	S.ARY EXB-V8V 470JV (47)	T	114.6/33.1
R141	7410000990	S.ARY EXB-V8V 470JV (47)	T	114.6/29.5
R142	7410000990	S.ARY EXB-V8V 470JV (47)	T	114.6/40.3
R143	7410000990	S.ARY EXB-V8V 470JV (47)	T	114.6/47.5
R144	7410000990	S.ARY EXB-V8V 470JV (47)	T	114.6/36.7
R145	7410000990	S.ARY EXB-V8V 470JV (47)	T	114.6/43.9
R146	7030003280	S.RES ERJ3GEYJ 470 V (47)	T	116/56.9
R147	7030003280	S.RES ERJ3GEYJ 470 V (47)	T	117.2/56.9
R148	7410000990	S.ARY EXB-V8V 470JV (47)	T	114.6/51.1
R149	7410000990	S.ARY EXB-V8V 470JV (47)	T	142.4/57
R150	7410000990	S.ARY EXB-V8V 470JV (47)	T	138.8/57

[LOGIC UNIT]

REF NO.	ORDER NO.	DESCRIPTION	M.	H/V LOCATION
R158	7030003560	S.RES ERJ3GEYJ 103 V (10 k)	T	147.8/67.9
R159	7030003560	S.RES ERJ3GEYJ 103 V (10 k)	T	147.8/69.2
R161	7030003250	S.RES ERJ3GEYJ 270 V (27)	B	160.2/49.5
R162	7030003800	S.RES ERJ3GEYJ 105 V (1 M)	T	159.9/48
R163	7030003320	S.RES ERJ3GEYJ 101 V (100)	T	154.5/40.3
R164	7030003250	S.RES ERJ3GEYJ 270 V (27)	B	162.7/42.6
R165	7030003340	S.RES ERJ3GEYJ 151 V (150)	T	159.9/49.2
R166	7030003860	S.RES ERJ3GE JPW V	T	159.4/35.9
R167	7030003860	S.RES ERJ3GE JPW V	T	158.2/35.9
R170	7030003600	S.RES ERJ3GEYJ 223 V (22 k)	T	134.5/23.5
R171	7030003600	S.RES ERJ3GEYJ 223 V (22 k)	T	133.2/23.5
R172	7030003600	S.RES ERJ3GEYJ 223 V (22 k)	T	128/23.5
R173	7030003600	S.RES ERJ3GEYJ 223 V (22 k)	T	129.3/23.5
R174	7030003600	S.RES ERJ3GEYJ 223 V (22 k)	T	130.6/23.5
R175	7030003600	S.RES ERJ3GEYJ 223 V (22 k)	T	131.9/23.5
R176	7030003600	S.RES ERJ3GEYJ 223 V (22 k)	T	126.7/23.5
R201	7030003560	S.RES ERJ3GEYJ 103 V (10 k)	T	50.4/68.8
R202	7030003560	S.RES ERJ3GEYJ 103 V (10 k)	T	50.4/65.6
R203	7030003560	S.RES ERJ3GEYJ 103 V (10 k)	T	49.1/72.7
R204	7030003560	S.RES ERJ3GEYJ 103 V (10 k)	T	50.4/72.7
R205	7030003560	S.RES ERJ3GEYJ 103 V (10 k)	T	53/68.8
R206	7030003560	S.RES ERJ3GEYJ 103 V (10 k)	T	51.7/65.6
R207	7030003560	S.RES ERJ3GEYJ 103 V (10 k)	T	51.7/72.7
R208	7030003560	S.RES ERJ3GEYJ 103 V (10 k)	T	53/72.7
R209	7030003560	S.RES ERJ3GEYJ 103 V (10 k)	T	51.7/68.8
R212	7030003640	S.RES ERJ3GEYJ 473 V (47 k)	T	56.9/37.3
R213	7030003640	S.RES ERJ3GEYJ 473 V (47 k)	T	54.3/37.3
R218	7030003520	S.RES ERJ3GEYJ 472 V (4.7 k)	T	80.8/63.5
R219	7030003520	S.RES ERJ3GEYJ 472 V (4.7 k)	T	82/64.8
R220	7030003520	S.RES ERJ3GEYJ 472 V (4.7 k)	B	64.9/48.4
R221	7030003560	S.RES ERJ3GEYJ 103 V (10 k)	T	67.2/38
R225	7030003560	S.RES ERJ3GEYJ 103 V (10 k)	B	59.7/48.4
R226	7030003560	S.RES ERJ3GEYJ 103 V (10 k)	B	58.4/48.4
R227	7030003560	S.RES ERJ3GEYJ 103 V (10 k)	T	41.4/44.6
R228	7030003560	S.RES ERJ3GEYJ 103 V (10 k)	T	44.4/44.6
R229	7030003560	S.RES ERJ3GEYJ 103 V (10 k)	T	47.5/43.9
R230	7030003560	S.RES ERJ3GEYJ 103 V (10 k)	T	44.4/45.9
R231	7030003560	S.RES ERJ3GEYJ 103 V (10 k)	T	47.5/45.2
R232	7030003560	S.RES ERJ3GEYJ 103 V (10 k)	B	56.1/47.6
R233	7030003560	S.RES ERJ3GEYJ 103 V (10 k)	T	41.4/45.9
R234	7030003560	S.RES ERJ3GEYJ 103 V (10 k)	T	47.5/46.5
R235	7030003560	S.RES ERJ3GEYJ 103 V (10 k)	T	44.4/47.2
R236	7030003560	S.RES ERJ3GEYJ 103 V (10 k)	T	41.4/47.2
R237	7030003560	S.RES ERJ3GEYJ 103 V (10 k)	B	56.1/48.9
R238	7030003560	S.RES ERJ3GEYJ 103 V (10 k)	T	47.5/47.8
R239	7030003560	S.RES ERJ3GEYJ 103 V (10 k)	T	44.4/48.5
R240	7030003560	S.RES ERJ3GEYJ 103 V (10 k)	T	41.4/48.5
R241	7030003560	S.RES ERJ3GEYJ 103 V (10 k)	B	50/51.9
R242	7030003560	S.RES ERJ3GEYJ 103 V (10 k)	T	47.5/49.2
R243	7030003560	S.RES ERJ3GEYJ 103 V (10 k)	B	56.1/50.2
R244	7030003560	S.RES ERJ3GEYJ 103 V (10 k)	T	74.6/49.2
R245	7030003560	S.RES ERJ3GEYJ 103 V (10 k)	T	74.6/42.7
R246	7030003560	S.RES ERJ3GEYJ 103 V (10 k)	T	78.3/41.4
R247	7030003560	S.RES ERJ3GEYJ 103 V (10 k)	B	64.9/51
R248	7030003560	S.RES ERJ3GEYJ 103 V (10 k)	T	74.6/44
R249	7030003560	S.RES ERJ3GEYJ 103 V (10 k)	T	74.6/38.8
R250	7030003560	S.RES ERJ3GEYJ 103 V (10 k)	T	74.6/40.1
R251	7030003560	S.RES ERJ3GEYJ 103 V (10 k)	T	78.3/42.7
R252	7030003560	S.RES ERJ3GEYJ 103 V (10 k)	T	78.3/40.1
R253	7030003560	S.RES ERJ3GEYJ 103 V (10 k)	T	68.4/38
R254	7030003560	S.RES ERJ3GEYJ 103 V (10 k)	T	74.6/41.4
R255	7030003560	S.RES ERJ3GEYJ 103 V (10 k)	T	78.3/38.8
R256	7030003560	S.RES ERJ3GEYJ 103 V (10 k)	B	62.3/51
R257	7030003560	S.RES ERJ3GEYJ 103 V (10 k)	T	74.6/45.3
R258	7030003560	S.RES ERJ3GEYJ 103 V (10 k)	B	61/51
R259	7030003560	S.RES ERJ3GEYJ 103 V (10 k)	T	78.3/45.3
R260	7030003560	S.RES ERJ3GEYJ 103 V (10 k)	B	59.7/51
R261	7030003560	S.RES ERJ3GEYJ 103 V (10 k)	T	78.3/46.6
R262	7030003560	S.RES ERJ3GEYJ 103 V (10 k)	B	58.4/51
R263	7030003560	S.RES ERJ3GEYJ 103 V (10 k)	B	72.9/47.4
R264	7030003560	S.RES ERJ3GEYJ 103 V (10 k)	B	66.8/52.3
R265	7030003560	S.RES ERJ3GEYJ 103 V (10 k)	T	80.9/46.6
R266	7030003560	S.RES ERJ3GEYJ 103 V (10 k)	T	80.9/45.3
R267	7030003560	S.RES ERJ3GEYJ 103 V (10 k)	T	74.6/47.9
R268	7030003560	S.RES ERJ3GEYJ 103 V (10 k)	B	72.9/44.8
R269	7030003560	S.RES ERJ3GEYJ 103 V (10 k)	T	74.6/46.6
R270	7030003560	S.RES ERJ3GEYJ 103 V (10 k)	T	78.3/44
R271	7030003560	S.RES ERJ3GEYJ 103 V (10 k)	T	80.9/44
R272	7030003560	S.RES ERJ3GEYJ 103 V (10 k)	T	77.4/62
R273	7030003560	S.RES ERJ3GEYJ 103 V (10 k)	T	77.4/60.8
R274	7030003560	S.RES ERJ3GEYJ 103 V (10 k)	B	59.7/54.1
R275	7030003560	S.RES ERJ3GEYJ 103 V (10 k)	T	74.6/63.2
R276	7030003560	S.RES ERJ3GEYJ 103 V (10 k)	T	74.6/60.8
R277	7030003560	S.RES ERJ3GEYJ 103 V (10 k)	T	74.6/59.6
R278	7030003560	S.RES ERJ3GEYJ 103 V (10 k)	T	74.6/58.4
R279	7030003560	S.RES ERJ3GEYJ 103 V (10 k)	B	58.4/54.1
R280	7030003560	S.RES ERJ3GEYJ 103 V (10 k)	T	77.4/63.2
R281	7030003560	S.RES ERJ3GEYJ 103 V (10 k)	B	64.2/54.9
R282	7030003560	S.RES ERJ3GEYJ 103 V (10 k)	B	64.2/53.6
R283	7030003560	S.RES ERJ3GEYJ 103 V (10 k)	B	73.7/59.7
R284	7030003560	S.RES ERJ3GEYJ 103 V (10 k)	B	73.7/58.4
R285	7030003560	S.RES ERJ3GEYJ 103 V (10 k)	B	61/54.1
R286	7030003560	S.RES ERJ3GEYJ 103 V (10 k)	T	77.4/59.6
R287	7030003560	S.RES ERJ3GEYJ 103 V (10 k)	T	74.6/56
R288	7030003560	S.RES ERJ3GEYJ 103 V (10 k)	T	77.4/57.2
R289	7030003560	S.RES ERJ3GEYJ 103 V (10 k)	T	74.6/54.8
R290	7030003560	S.RES ERJ3GEYJ 103 V (10 k)	B	62.3/54.1
R291	7030003560	S.RES ERJ3GEYJ 103 V (10 k)	T	74.6/57.2
R292	7030003560	S.RES ERJ3GEYJ 103 V (10 k)	B	63.6/48.4
R293	7030003560	S.RES ERJ3GEYJ 103 V (10 k)	B	62.3/48.4
R294	7030003560	S.RES ERJ3GEYJ 103 V (10 k)	B	61/48.4
R295	7030003640	S.RES ERJ3GEYJ 473 V (47 k)	B	63.6/51
R296	7030003560	S.RES ERJ3GEYJ 103 V (10 k)	T	47.8/65.6
R297	7030003560	S.RES ERJ3GEYJ 103 V (10 k)	T	43.9/65.6

[LOGIC UNIT]

REF NO.	ORDER NO.	DESCRIPTION	M.	H/V LOCATION
R298	7030003560	S.RES ERJ3GEYJ 103 V (10 k)	T	43.9/72.7
R299	7030003560	S.RES ERJ3GEYJ 103 V (10 k)	T	45.2/65.6
R300	7030003560	S.RES ERJ3GEYJ 103 V (10 k)	T	45.2/68.8
R301	7030003560	S.RES ERJ3GEYJ 103 V (10 k)	T	45.2/72.7
R302	7030003560	S.RES ERJ3GEYJ 103 V (10 k)	T	43.9/68.8
R303	7030003560	S.RES ERJ3GEYJ 103 V (10 k)	T	46.5/72.7
R304	7030003560	S.RES ERJ3GEYJ 103 V (10 k)	T	46.5/68.8
R305	7030003560	S.RES ERJ3GEYJ 103 V (10 k)	T	46.5/65.6
R306	7030003560	S.RES ERJ3GEYJ 103 V (10 k)	T	49.1/65.6
R307	7030003560	S.RES ERJ3GEYJ 103 V (10 k)	T	49.1/68.8
R308	7030003560	S.RES ERJ3GEYJ 103 V (10 k)	T	47.8/72.7
R309	7030003560	S.RES ERJ3GEYJ 103 V (10 k)	T	47.8/68.8
R310	7030003560	S.RES ERJ3GEYJ 103 V (10 k)	T	74.6/62
R311	7030003560	S.RES ERJ3GEYJ 103 V (10 k)	T	77.4/58.4
R313	7030003410	S.RES ERJ3GEYJ 561 V (560)	B	79/3.2
R314	7030003340	S.RES ERJ3GEYJ 151 V (150)	B	88.5/11.3
R315	7030003340	S.RES ERJ3GEYJ 151 V (150)	B	89.8/11.3
R316	7030003340	S.RES ERJ3GEYJ 151 V (150)	B	88.5/13.9
R317	7030003340	S.RES ERJ3GEYJ 151 V (150)	B	89.8/13.9
R318	7030003340	S.RES ERJ3GEYJ 151 V (150)	B	88.5/16.5
R319	7030003340	S.RES ERJ3GEYJ 151 V (150)	B	93.6/16.7
R320	7030003240	S.RES ERJ3GEYJ 220 V (22)	B	110/6.1
R321	7030003240	S.RES ERJ3GEYJ 220 V (22)	B	110/4.8
R322	7030003250	S.RES ERJ3GEYJ 270 V (27)	B	13.2/70.6
R323	7030003250	S.RES ERJ3GEYJ 270 V (27)	B	13.2/69.3
R324	7030003580	S.RES ERJ3GEYJ 153 V (15 k)	B	12.5/72.4
R325	7030003580	S.RES ERJ3GEYJ 153 V (15 k)	B	12.5/67.4
R326	7030003250	S.RES ERJ3GEYJ 270 V (27)	B	13.2/78.2
R327	7030003250	S.RES ERJ3GEYJ 270 V (27)	B	13.2/76.9
R328	7030003580	S.RES ERJ3GEYJ 153 V (15 k)	B	12.5/80
R329	7030003580	S.RES ERJ3GEYJ 153 V (15 k)	B	12.5/75
R330	7030003560	S.RES ERJ3GEYJ 103 V (10 k)	B	21.6/70.6
R331	7030003560	S.RES ERJ3GEYJ 103 V (10 k)	B	22.9/70.6
R332	7030003640	S.RES ERJ3GEYJ 473 V (47 k)	B	96.9/84.2
R333	7030003640	S.RES ERJ3GEYJ 473 V (47 k)	B	93.7/73.3
R334	7030003640	S.RES ERJ3GEYJ 473 V (47 k)	T	94/78.7
R335	7030003280	S.RES ERJ3GEYJ 470 V (47)	B	95.5/73.3
R336	7030003640	S.RES ERJ3GEYJ 473 V (47 k)	B	106.4/84.2
R337	7030003640	S.RES ERJ3GEYJ 473 V (47 k)	B	103.4/73.3
R338	7030003640	S.RES ERJ3GEYJ 473 V (47 k)	T	103.5/78.7
R339	7030003280	S.RES ERJ3GEYJ 470 V (47)	B	105.2/73.3
R340	7030003280	S.RES ERJ3GEYJ 470 V (47)	B	113/73.3
R341	7030003640	S.RES ERJ3GEYJ 473 V (47 k)	B	110.1/73.3
R342	7030003280	S.RES ERJ3GEYJ 470 V (47)	B	118.9/73.3
R343	7030003640	S.RES ERJ3GEYJ 473 V (47 k)	B	116.1/73.3
R344	7030003520	S.RES ERJ3GEYJ 472 V (4.7 k)	B	108.2/84.2
R345	7030003520	S.RES ERJ3GEYJ 472 V (4.7 k)	B	113.7/84.2
R346	7030003560	S.RES ERJ3GEYJ 103 V (10 k)	B	109.4/84.2
R347	7030003860	S.RES ERJ3GE JPW V	T	20.4/66.7
R348	7030003860	S.RES ERJ3GE JPW V	T	24.2/67.6
R350	7030003860	S.RES ERJ3GE JPW V	T	80.7/62.1
R351	7030003860	S.RES ERJ3GE JPW V	B	56.1/54.9
R353	7030003860	S.RES ERJ3GE JPW V	T	60.7/28.5
R355	7030003860	S.RES ERJ3GE JPW V	T	59.3/28.5
R356	7030003860	S.RES ERJ3GE JPW V	T	62/25.4
R357	7030003860	S.RES ERJ3GE JPW V	B	99.8/11.4
R358	7030003860	S.RES ERJ3GE JPW V	B	99.8/14.4
R359	7030003860	S.RES ERJ3GE JPW V	B	99.8/17.4
R360	7030003860	S.RES ERJ3GE JPW V	B	117.6/3.2
R361	7030003320	S.RES ERJ3GEYJ 101 V (100)	B	79.7/16.6
R371	7030003200	S.RES ERJ3GEYJ 100 V (10)	B	46.5/47.7
R372	7030003200	S.RES ERJ3GEYJ 100 V (10)	B	43.2/44.5
R373	7030003200	S.RES ERJ3GEYJ 100 V (10)	B	44.3/47.7
R374	7030003200	S.RES ERJ3GEYJ 100 V (10)	B	42.1/47.7
R375	7030003200	S.RES ERJ3GEYJ 100 V (10)	B	37.7/47.7
R376	7030003200	S.RES ERJ3GEYJ 100 V (10)	B	41/44.5
R377	7030003200	S.RES ERJ3GEYJ 100 V (10)	B	39.9/47.7
R378	7030003200	S.RES ERJ3GEYJ 100 V (10)	B	36.6/44.5
R379	7030003200	S.RES ERJ3GEYJ 100 V (10)	B	38.8/44.5
R380	7030003200	S.RES ERJ3GEYJ 100 V (10)	B	35.5/47.7
R381	7030003200	S.RES ERJ3GEYJ 100 V (10)	B	45.4/44.5
R382	7030003200	S.RES ERJ3GEYJ 100 V (10)	B	52.8/37.1
R383	7030003200	S.RES ERJ3GEYJ 100 V (10)	B	49.6/34.1
R384	7030003200	S.RES ERJ3GEYJ 100 V (10)	B	50.6/37.1
R385	7030003200	S.RES ERJ3GEYJ 100 V (10)	B	47.4/34.1
R386	7030003200	S.RES ERJ3GEYJ 100 V (10)	B	48.4/37.1

[LOGIC UNIT]

REF NO.	ORDER NO.	DESCRIPTION	M.	H/V LOCATION
R601	7030003620	S.RES ERJ3GEYJ 333 V (33 k)	T	254.7/68.3
R602	7030003590	S.RES ERJ3GEYJ 183 V (18 k)	T	257.1/67.9
R603	7030003540	S.RES ERJ3GEYJ 682 V (6.8 k)	T	253.5/66.8
R604	7030003640	S.RES ERJ3GEYJ 473 V (47 k)	T	249.9/65.4
R605	7030003680	S.RES ERJ3GEYJ 104 V (100 k)	T	255.8/62.8
R606	7030003680	S.RES ERJ3GEYJ 104 V (100 k)	T	251.8/61.6
R607	7030003350	S.RES ERJ3GEYJ 181 V (180)	B	198.6/92
R608	7030003520	S.RES ERJ3GEYJ 472 V (4.7 k)	B	196/92
R609	7030003440	S.RES ERJ3GEYJ 102 V (1 k)	B	216.6/85.1
R610	7030003440	S.RES ERJ3GEYJ 102 V (1 k)	B	216.6/83.9
R611	7030003440	S.RES ERJ3GEYJ 102 V (1 k)	B	216.6/82.7
R612	7030003440	S.RES ERJ3GEYJ 102 V (1 k)	B	216.6/81.5
R613	7030003440	S.RES ERJ3GEYJ 102 V (1 k)	B	216.6/80.4
R614	7030003440	S.RES ERJ3GEYJ 102 V (1 k)	B	216.6/79.1
R615	7030003440	S.RES ERJ3GEYJ 102 V (1 k)	B	216.6/77.9
R616	7030003440	S.RES ERJ3GEYJ 102 V (1 k)	B	216.6/76.7
R617	7030003800	S.RES ERJ3GEYJ 105 V (1 M)	T	217.9/76.7
R618	7030003800	S.RES ERJ3GEYJ 105 V (1 M)	T	217.9/77.9
R619	7030003800	S.RES ERJ3GEYJ 105 V (1 M)	T	217.9/79.1
R620	7030003800	S.RES ERJ3GEYJ 105 V (1 M)	T	217.9/80.3
R621	7030003800	S.RES ERJ3GEYJ 105 V (1 M)	T	217.9/81.5
R622	7030003800	S.RES ERJ3GEYJ 105 V (1 M)	T	217.9/82.7
R623	7030003800	S.RES ERJ3GEYJ 105 V (1 M)	T	217.9/83.9
R624	7030003800	S.RES ERJ3GEYJ 105 V (1 M)	T	217.9/85.1
R625	7030003640	S.RES ERJ3GEYJ 473 V (47 k)	B	212.5/77.3
R626	7030003600	S.RES ERJ3GEYJ 223 V (22 k)	B	212.5/76
R627	7030003640	S.RES ERJ3GEYJ 473 V (47 k)	T	205.3/73.2
R628	7030003640	S.RES ERJ3GEYJ 473 V (47 k)	T	205.3/74.6
R629	7030003640	S.RES ERJ3GEYJ 473 V (47 k)	B	212.4/72.5
R630	7030003520	S.RES ERJ3GEYJ 472 V (4.7 k)	T	229.2/86.5
R631	7030003520	S.RES ERJ3GEYJ 472 V (4.7 k)	T	229.2/85.3
R632	7030003520	S.RES ERJ3GEYJ 472 V (4.7 k)	T	229.2/84.1
R633	7030003520	S.RES ERJ3GEYJ 472 V (4.7 k)	T	229.2/82.9
R634	7030003520	S.RES ERJ3GEYJ 472 V (4.7 k)	T	229.2/81.7
R635	7030003520	S.RES ERJ3GEYJ 472 V (4.7 k)	T	229.2/80.5
R636	7030003640	S.RES ERJ3GEYJ 473 V (47 k)	B	209.2/62.9
R637	7030003640	S.RES ERJ3GEYJ 473 V (47 k)	B	214.9/62.9
R639	7030003640	S.RES ERJ3GEYJ 473 V (47 k)	T	211.8/59.2
R640	7030003640	S.RES ERJ3GEYJ 473 V (47 k)	T	216.7/52.2
R641	7030003640	S.RES ERJ3GEYJ 473 V (47 k)	T	218/52.2
R642	7030003640	S.RES ERJ3GEYJ 473 V (47 k)	T	219.2/52.2
R643	7030003600	S.RES ERJ3GEYJ 223 V (22 k)	T	200.7/64.2
R644	7030003560	S.RES ERJ3GEYJ 103 V (10 k)	T	201.9/64.2
R645	7030003520	S.RES ERJ3GEYJ 472 V (4.7 k)	B	190.4/63.5
R646	7030003720	S.RES ERJ3GEYJ 224 V (220 k)	B	183.7/88.4
R647	7030003720	S.RES ERJ3GEYJ 224 V (220 k)	B	183.7/86.5
R648	7030003720	S.RES ERJ3GEYJ 224 V (220 k)	B	183.7/85.2
R649	7030003720	S.RES ERJ3GEYJ 224 V (220 k)	B	183.7/83.9
R650	7030003720	S.RES ERJ3GEYJ 224 V (220 k)	B	183.7/82.6
R651	7030003720	S.RES ERJ3GEYJ 224 V (220 k)	B	183.7/81.3
R652	7030003720	S.RES ERJ3GEYJ 224 V (220 k)	B	183.7/80
R653	7030003720	S.RES ERJ3GEYJ 224 V (220 k)	B	183.7/78.7
R654	7030003520	S.RES ERJ3GEYJ 472 V (4.7 k)	B	183.7/67.3
R655	7030003520	S.RES ERJ3GEYJ 472 V (4.7 k)	B	183.7/66.6
R656	7030003520	S.RES ERJ3GEYJ 472 V (4.7 k)	T	181.9/114.5
R657	7030003720	S.RES ERJ3GEYJ 224 V (220 k)	B	212.5/78.6
R658	7030003640	S.RES ERJ3GEYJ 473 V (47 k)	T	195.4/71.3
R660	7030003640	S.RES ERJ3GEYJ 473 V (47 k)	T	193.7/79.4
R661	7030003640	S.RES ERJ3GEYJ 473 V (47 k)	T	205.3/77.4
R662	7030003640	S.RES ERJ3GEYJ 473 V (47 k)	T	195.9/83.2
R663	7030003640	S.RES ERJ3GEYJ 473 V (47 k)	T	207.7/84.2
R665	7030003560	S.RES ERJ3GEYJ 103 V (10 k)	T	194.3/83.2
R666	7030003560	S.RES ERJ3GEYJ 103 V (10 k)	T	206.3/84.2
R668	7030003640	S.RES ERJ3GEYJ 473 V (47 k)	B	200.5/92
R669	7030003640	S.RES ERJ3GEYJ 473 V (47 k)	T	205.3/76
R670	7030003640	S.RES ERJ3GEYJ 473 V (47 k)	B	189.1/63.5
R671	7030003640	S.RES ERJ3GEYJ 473 V (47 k)	B	187.8/63.5
R672	7030003640	S.RES ERJ3GEYJ 473 V (47 k)	B	206.6/92
R674	7030003640	S.RES ERJ3GEYJ 473 V (47 k)	B	194.3/63.5
R675	7030003640	S.RES ERJ3GEYJ 473 V (47 k)	B	193/63.5
R676	7030003640	S.RES ERJ3GEYJ 473 V (47 k)	B	193.4/92
R677	7030003520	S.RES ERJ3GEYJ 472 V (4.7 k)	T	171.5/115
R678	7030003720	S.RES ERJ3GEYJ 224 V (220 k)	B	212.5/79.9
R679	7030003640	S.RES ERJ3GEYJ 473 V (47 k)	B	194.7/92
R680	7030003520	S.RES ERJ3GEYJ 472 V (4.7 k)	T	172.8/115
R681	7030003520	S.RES ERJ3GEYJ 472 V (4.7 k)	T	169.9/115
R687	7030003520	S.RES ERJ3GEYJ 472 V (4.7 k)	T	164.5/101.7
R689	7030003520	S.RES ERJ3GEYJ 472 V (4.7 k)	T	164.5/105.1
R690	7030003520	S.RES ERJ3GEYJ 472 V (4.7 k)	T	164.5/103.8
R691	7030003640	S.RES ERJ3GEYJ 473 V (47 k)	T	172.7/64.1
R692	7030003520	S.RES ERJ3GEYJ 472 V (4.7 k)	T	164.5/108.5
R693	7030003520	S.RES ERJ3GEYJ 472 V (4.7 k)	T	164.5/109.8
R694	7030003640	S.RES ERJ3GEYJ 473 V (47 k)	T	28.3/87.7
R695	7030003640	S.RES ERJ3GEYJ 473 V (47 k)	T	19.5/88.7
R696	7030003520	S.RES ERJ3GEYJ 472 V (4.7 k)	T	164.5/100.2
R697	7030003520	S.RES ERJ3GEYJ 472 V (4.7 k)	T	166.2/112.8
R701	7030003860	S.RES ERJ3GE JPW V	B	191.7/63.5
R703	7030003640	S.RES ERJ3GEYJ 473 V (47 k)	B	197.5/63.9
R801	7030003560	S.RES ERJ3GEYJ 103 V (10 k)	T	245.6/83
R802	7030006210	S.RES ERJ12YJ4R7U (4.7)	B	236.9/85.2
R803	7030003440	S.RES ERJ3GEYJ 102 V (1 k)	B	238.6/87.6
R804	7030006210	S.RES ERJ12YJ4R7U (4.7)	B	236.9/78
R805	7030003440	S.RES ERJ3GEYJ 102 V (1 k)	B	238.6/80.4
R806	7030003560	S.RES ERJ3GEYJ 103 V (10 k)	T	242.7/74.7
R808	7030003860	S.RES ERJ3GE JPW V	T	196.1/6.6
R811	7030008240	S.RES ERJ12Y0R00U	T	41.7/30.8
R812	7030010440	S.RES ERJ1TYJ 680U (68)	T	30/44.2
R813	7030003560	S.RES ERJ3GEYJ 103 V (10 k)	T	10.4/12.6
R814	7030003440	S.RES ERJ3GEYJ 102 V (1 k)	T	209.1/34.6
R816	7030003560	S.RES ERJ3GEYJ 103 V (10 k)	T	242.5/93.1
R817	7030003560	S.RES ERJ3GEYJ 103 V (10 k)	T	242.5/91.9
R818	7030000140	S.RES MCR10EZJH 10 (100)	T	235.3/90.1
R819	7030007190	S.RES ERJ12YJ220U (22)	T	28.9/51.6
R821	7030003370	S.RES ERJ3GEYJ 271 V (270)	T	258.7/37.2

[LOGIC UNIT]

REF NO.	ORDER NO.	DESCRIPTION	M.	H/V LOCATION
R822	7030009720	S.RES ERJ12YJ102U (1 k)	T	258.7/32.5
R823	7030003810	S.RES ERJ3GEYJ 125 V (1.2 M)	T	254.5/28
R824	7030003810	S.RES ERJ3GEYJ 125 V (1.2 M)	T	250/33.4
R825	7030008170	S.RES ERJ12YJ1R0U (1)	T	247.5/29.9
R826	7030003610	S.RES ERJ3GEYJ 273 V (27 k)	T	251.9/28
R827	7030003610	S.RES ERJ3GEYJ 273 V (27 k)	T	250/30.7
R828	7030003560	S.RES ERJ3GEYJ 103 V (10 k)	T	257.1/38.8
R829	7030000340	S.RES MCR10EZJH 470 (47)	T	247.8/40.1
R830	7030003600	S.RES ERJ3GEYJ 223 V (22 k)	T	255.2/38.1
R832	7030003600	S.RES ERJ3GEYJ 223 V (22 k)	T	254.4/39.9
R833	7030003560	S.RES ERJ3GEYJ 103 V (10 k)	T	252.6/38.1
R841	7030003480	S.RES ERJ3GEYJ 222 V (2.2 k)	B	113.3/101.9
R842	7030003640	S.RES ERJ3GEYJ 473 V (47 k)	B	111.4/101.2
R843	7030003380	S.RES ERJ3GEYJ 331 V (330)	B	110.2/102.7
R850	7030003860	S.RES ERJ3GE JPW V	B	239.9/68.4
R851	7030003680	S.RES ERJ3GEYJ 104 V (100 k)	B	235.3/55.9
R854	7030003770	S.RES ERJ3GEYJ 564 V (560 k)	B	233.8/57.3
R855	7030003520	S.RES ERJ3GEYJ 472 V (4.7 k)	B	230.5/55.8
R857	7030003560	S.RES ERJ3GEYJ 103 V (10 k)	B	111.1/87.7
R858	7030003460	S.RES ERJ3GEYJ 152 V (1.5 k)	B	111.1/88.9
R859	7030003470	S.RES ERJ3GEYJ 182 V (1.8 k)	B	112.6/90.1
R860	7030003500	S.RES ERJ3GEYJ 332 V (3.3 k)	B	108.8/94.9
R861	7030003480	S.RES ERJ3GEYJ 222 V (2.2 k)	B	111.4/91.3
R862	7030003480	S.RES ERJ3GEYJ 222 V (2.2 k)	B	108.8/91.3
R863	7030003560	S.RES ERJ3GEYJ 103 V (10 k)	B	118.1/87.7
R864	7030003460	S.RES ERJ3GEYJ 152 V (1.5 k)	B	118.1/88.9
R865	7030003470	S.RES ERJ3GEYJ 182 V (1.8 k)	B	116.6/90.1
R866	7030003500	S.RES ERJ3GEYJ 332 V (3.3 k)	B	120.4/94.9
R867	7030003480	S.RES ERJ3GEYJ 222 V (2.2 k)	B	117.9/91.3
R868	7030003380	S.RES ERJ3GEYJ 331 V (330)	B	120.5/91.3
R869	7030003560	S.RES ERJ3GEYJ 103 V (10 k)	B	114.9/84.2
R871	7030003680	S.RES ERJ3GEYJ 104 V (100 k)	B	236.9/57.8
R872	7030003770	S.RES ERJ3GEYJ 564 V (560 k)	B	238.9/58.5
R873	7030003520	S.RES ERJ3GEYJ 472 V (4.7 k)	B	241.5/56.3
R874	7030003540	S.RES ERJ3GEYJ 682 V (6.8 k)	B	240.3/55.1
R876	7030003410	S.RES ERJ3GEYJ 561 V (560)	B	91.8/97.8
R877	7030003700	S.RES ERJ3GEYJ 154 V (150 k)	B	94.5/99.2
R878	7030003520	S.RES ERJ3GEYJ 472 V (4.7 k)	B	95.3/101.1
R879	7030003550	S.RES ERJ3GEYJ 822 V (8.2 k)	B	103.7/99.2
R880	7030003690	S.RES ERJ3GEYJ 124 V (120 k)	B	101.1/99.2
R881	7030003520	S.RES ERJ3GEYJ 472 V (4.7 k)	B	101.1/101.6
R882	7030003410	S.RES ERJ3GEYJ 561 V (560)	B	91.6/87.2
R883	7030003550	S.RES ERJ3GEYJ 822 V (8.2 k)	B	92.1/89.3
R884	7030003520	S.RES ERJ3GEYJ 472 V (4.7 k)	B	92.9/87.2
R885	7030003410	S.RES ERJ3GEYJ 561 V (560)	B	103.7/89.4
R886	7030003550	S.RES ERJ3GEYJ 822 V (8.2 k)	B	101.1/89.4
R887	7030003520	S.RES ERJ3GEYJ 472 V (4.7 k)	B	101.1/87.9
R888	7030003360	S.RES ERJ3GEYJ 221 V (220)	B	241.1/69.8
R889	7030003640	S.RES ERJ3GEYJ 473 V (47 k)	B	241.4/71.8
R890	7030003360	S.RES ERJ3GEYJ 221 V (220)	B	231.2/69.8
R891	7030003560	S.RES ERJ3GEYJ 103 V (10 k)	B	231.9/71.6
R892	7030003730	S.RES ERJ3GEYJ 274 V (270 k)	B	232.4/68.3
R893	7030003680	S.RES ERJ3GEYJ 104 V (100 k)	B	239.1/70.2
R894	7030003200	S.RES ERJ3GEYJ 100 V (10)	B	237.9/69.1
R895	7030003680	S.RES ERJ3GEYJ 104 V (100 k)	B	233.1/70.2
R896	7030003200	S.RES ERJ3GEYJ 100 V (10)	B	234.3/69.1
R901	7030003200	S.RES ERJ3GEYJ 100 V (10)	T	230.7/110.6
R902	7030003200	S.RES ERJ3GEYJ 100 V (10)	B	229.7/116.4
R903	7030003200	S.RES ERJ3GEYJ 100 V (10)	T	228.7/110.6
R904	7030003200	S.RES ERJ3GEYJ 100 V (10)	T	227.7/116.4
R905	7030003200	S.RES ERJ3GEYJ 100 V (10)	T	226.7/110.6
R906	7030003200	S.RES ERJ3GEYJ 100 V (10)	B	225.7/116.4
R907	7030003200	S.RES ERJ3GEYJ 100 V (10)	T	224.7/110.6
R908	7030003200	S.RES ERJ3GEYJ 100 V (10)	B	223.7/116.4
R910	7030003200	S.RES ERJ3GEYJ 100 V (10)	B	221.7/116.4
R911	7030003200	S.RES ERJ3GEYJ 100 V (10)	T	220.7/110.6
R912	7030003200	S.RES ERJ3GEYJ 100 V (10)	T	219.7/116.4
R913	7030003200	S.RES ERJ3GEYJ 100 V (10)	T	218.7/110.6
R914	7030003200	S.RES ERJ3GEYJ 100 V (10)	T	217.7/116.4
R915	7030003200	S.RES ERJ3GEYJ 100 V (10)	T	216.7/110.6
R916	7030003200	S.RES ERJ3GEYJ 100 V (10)	B	215.7/116.4
R917	7030003200	S.RES ERJ3GEYJ 100 V		

[LOGIC UNIT]

REF NO.	ORDER NO.	DESCRIPTION	M.	H/V LOCATION
R972	7030003860	S.RES ERJ3GE JPW V	B	59.1/11
R973	7030003860	S.RES ERJ3GE JPW V	B	58.1/5.1
R974	7030003860	S.RES ERJ3GE JPW V	B	52/14
R975	7030003200	S.RES ERJ3GEYJ 100 V (10)	T	59.9/13.4
R976	7030003200	S.RES ERJ3GEYJ 100 V (10)	T	58.6/13.4
R982	7030003200	S.RES ERJ3GEYJ 100 V (10)	T	49.5/13.4
R983	7030003200	S.RES ERJ3GEYJ 100 V (10)	T	46.9/13.4
R996	7030003200	S.RES ERJ3GEYJ 100 V (10)	T	44.3/13.4
R997	7030003860	S.RES ERJ3GE JPW V	T	33.5/8
R1016	7030003200	S.RES ERJ3GEYJ 100 V (10)	T	52.8/107.5
R1017	7030003200	S.RES ERJ3GEYJ 100 V (10)	T	54.1/107.5
R1018	7030003200	S.RES ERJ3GEYJ 100 V (10)	T	55.4/107.5
R1019	7030003200	S.RES ERJ3GEYJ 100 V (10)	T	56.7/107.5
R1020	7030003200	S.RES ERJ3GEYJ 100 V (10)	T	58/107.5
R1021	7030003200	S.RES ERJ3GEYJ 100 V (10)	T	59.3/107.5
R1022	7030003200	S.RES ERJ3GEYJ 100 V (10)	T	60.6/107.5
R1023	7030003200	S.RES ERJ3GEYJ 100 V (10)	T	61.9/107.5
R1025	7030003320	S.RES ERJ3GEYJ 101 V (100)	T	114.6/90.5
R1026	7030003320	S.RES ERJ3GEYJ 101 V (100)	B	116.4/101.2
R1027	7030003320	S.RES ERJ3GEYJ 101 V (100)	T	98.9/97.1
R1028	7030003320	S.RES ERJ3GEYJ 101 V (100)	B	95.9/88.6
R1029	7030003520	S.RES ERJ3GEYJ 472 V (4.7 k)	B	96.5/100
R1030	7030003520	S.RES ERJ3GEYJ 472 V (4.7 k)	B	99.1/100
R1031	7030003520	S.RES ERJ3GEYJ 472 V (4.7 k)	B	94.2/88.6
R1032	7030003520	S.RES ERJ3GEYJ 472 V (4.7 k)	B	99.1/88.6
R1033	7030003860	S.RES ERJ3GE JPW V	T	238.5/55.1
R1035	7030003540	S.RES ERJ3GEYJ 682 V (6.8 k)	B	229.8/59.3
R1041	7030003520	S.RES ERJ3GEYJ 472 V (4.7 k)	B	206.5/113.3
R1042	7030003550	S.RES ERJ3GEYJ 822 V (8.2 k)	B	104.7/96.8
R1052	7030008240	S.RES ERJ12Y0R00U	T	102.3/73.2
R1053	7030008240	S.RES ERJ12Y0R00U	T	269.3/36.4
R1054	7030008240	S.RES ERJ12Y0R00U	T	156.3/112.5
R1056	7030003860	S.RES ERJ3GE JPW V	T	230.7/97.2
R1057	7030003860	S.RES ERJ3GE JPW V	B	101.1/102.8
R1101	7030003200	S.RES ERJ3GEYJ 100 V (10)	T	28.3/89
R1102	7030003200	S.RES ERJ3GEYJ 100 V (10)	T	19.5/90
R1103	7030003200	S.RES ERJ3GEYJ 100 V (10)	T	19.5/92.2
R1104	7030003200	S.RES ERJ3GEYJ 100 V (10)	T	28.3/93
R1105	7030003200	S.RES ERJ3GEYJ 100 V (10)	T	19.5/94.6
R1106	7030003200	S.RES ERJ3GEYJ 100 V (10)	T	28.2/95
R1107	7030003200	S.RES ERJ3GEYJ 100 V (10)	T	19.5/96
R1108	7030003200	S.RES ERJ3GEYJ 100 V (10)	T	28.2/97
R1109	7030003200	S.RES ERJ3GEYJ 100 V (10)	T	19.5/98
R1110	7030003200	S.RES ERJ3GEYJ 100 V (10)	T	28.2/99
R1111	7030003200	S.RES ERJ3GEYJ 100 V (10)	T	19.5/100
R1112	7030003200	S.RES ERJ3GEYJ 100 V (10)	T	28.2/101
R1113	7030003200	S.RES ERJ3GEYJ 100 V (10)	T	19.5/103.4
R1115	7030003200	S.RES ERJ3GEYJ 100 V (10)	T	28.2/107.3
R1118	7030003440	S.RES ERJ3GEYJ 102 V (1 k)	T	5.6/94.5
R1119	7030003440	S.RES ERJ3GEYJ 102 V (1 k)	T	14.4/95.5
R1120	7030003440	S.RES ERJ3GEYJ 102 V (1 k)	T	5.6/96.5
R1121	7030003440	S.RES ERJ3GEYJ 102 V (1 k)	T	14.4/97.5
R1122	7030003440	S.RES ERJ3GEYJ 102 V (1 k)	T	5.6/98.5
R1125	7030003200	S.RES ERJ3GEYJ 100 V (10)	T	5.6/104.5
R1126	7030003200	S.RES ERJ3GEYJ 100 V (10)	T	14.4/103.5
R1127	7030003200	S.RES ERJ3GEYJ 100 V (10)	T	5.6/102.8
R1128	7030003200	S.RES ERJ3GEYJ 100 V (10)	T	5.6/106.5
R1129	7030003200	S.RES ERJ3GEYJ 100 V (10)	T	14.3/107.5
R1151	7030003290	S.RES ERJ3GEYJ 560 V (56)	B	11.2/30.4
R1152	7030003320	S.RES ERJ3GEYJ 101 V (100)	B	14.3/30.4
R1153	7030003320	S.RES ERJ3GEYJ 101 V (100)	B	16.9/29.6
R1154	7030003320	S.RES ERJ3GEYJ 101 V (100)	B	14.3/28.9
R1155	7030003320	S.RES ERJ3GEYJ 101 V (100)	B	16.9/28.1
R1156	7030003320	S.RES ERJ3GEYJ 101 V (100)	B	14.3/27.4
R1157	7030003320	S.RES ERJ3GEYJ 101 V (100)	B	16.9/26.6
R1158	7030003320	S.RES ERJ3GEYJ 101 V (100)	B	14.3/25.9
R1159	7030003320	S.RES ERJ3GEYJ 101 V (100)	B	16.9/25.1
R1160	7030003320	S.RES ERJ3GEYJ 101 V (100)	B	14.3/24.4
R1161	7030003320	S.RES ERJ3GEYJ 101 V (100)	B	16.9/23.6
R1162	7030003320	S.RES ERJ3GEYJ 101 V (100)	B	14.3/22.9
R1163	7030003320	S.RES ERJ3GEYJ 101 V (100)	B	16.9/22.1
R1164	7030003320	S.RES ERJ3GEYJ 101 V (100)	B	14.3/21.4
R1165	7030003320	S.RES ERJ3GEYJ 101 V (100)	B	16.9/20.6
R1166	7030003320	S.RES ERJ3GEYJ 101 V (100)	B	14.3/19.9
R1167	7030003320	S.RES ERJ3GEYJ 101 V (100)	B	16.9/19.1
R1168	7030003320	S.RES ERJ3GEYJ 101 V (100)	B	14.3/18.4
R1169	7030003320	S.RES ERJ3GEYJ 101 V (100)	B	16.9/17.6
R1170	7030003320	S.RES ERJ3GEYJ 101 V (100)	B	11.2/17.4
R2001	7030003860	S.RES ERJ3GE JPW V	T	278.3/72.9
R2051	7030003200	S.RES ERJ3GEYJ 100 V (10)	T	257.1/76.4
R2052	7030003620	S.RES ERJ3GEYJ 333 V (33 k)	T	257.1/82.6
R2053	7030003540	S.RES ERJ3GEYJ 682 V (6.8 k)	T	259/83.3
R2054	7030003640	S.RES ERJ3GEYJ 473 V (47 k)	T	258.2/87.5
R2055	7030003580	S.RES ERJ3GEYJ 153 V (15 k)	T	255.6/82.6
R2057	7030003860	S.RES ERJ3GE JPW V	T	274/84.6
R2058	7030003860	S.RES ERJ3GE JPW V	B	281.7/97.1
R2059	7030003860	S.RES ERJ3GE JPW V	B	281.7/103.8
R2101	7030003860	S.RES ERJ3GE JPW V	T	274.1/54.8
R2102	7030003860	S.RES ERJ3GE JPW V	T	274.1/52.4
R2201	7030003860	S.RES ERJ3GE JPW V	T	274.2/26.8
R2202	7030003860	S.RES ERJ3GE JPW V	T	274.2/24.4
R2203	7030003860	S.RES ERJ3GE JPW V	T	274.2/25.6
R2204	7030003860	S.RES ERJ3GE JPW V	T	274.2/22
R2205	7030003860	S.RES ERJ3GE JPW V	T	274.2/23.2
R2206	7030003860	S.RES ERJ3GE JPW V	T	274.2/20.8
R2207	7030003860	S.RES ERJ3GE JPW V	T	274.2/19.6
R2208	7030003860	S.RES ERJ3GE JPW V	T	274.2/18.4
R2209	7030003860	S.RES ERJ3GE JPW V	T	274.2/17.2
C1	4030011600	S.CER C1608 JB 1E 104K-T	T	84.8/42.4
C2	4030011600	S.CER C1608 JB 1E 104K-T	T	86.6/43.1
C3	4030011600	S.CER C1608 JB 1E 104K-T	T	91.4/43.1
C4	4030011600	S.CER C1608 JB 1E 104K-T	T	94/43.1

[LOGIC UNIT]

REF NO.	ORDER NO.	DESCRIPTION	M.	H/V LOCATION
C5	4030011600	S.CER C1608 JB 1E 104K-T	T	105.8/43.1
C6	4030011600	S.CER C1608 JB 1E 104K-T	T	93.8/57.5
C7	4030011600	S.CER C1608 JB 1E 104K-T	T	89/57.5
C8	4030011600	S.CER C1608 JB 1E 104K-T	T	84/27
C9	4030011600	S.CER C1608 JB 1E 104K-T	T	86.6/27
C10	4030011600	S.CER C1608 JB 1E 104K-T	T	91.4/27
C11	4030011600	S.CER C1608 JB 1E 104K-T	T	94/27
C12	4030011600	S.CER C1608 JB 1E 104K-T	T	105.8/27
C13	4030011600	S.CER C1608 JB 1E 104K-T	T	93.8/41.4
C14	4030011600	S.CER C1608 JB 1E 104K-T	T	89/41.4
C51	4030011600	S.CER C1608 JB 1E 104K-T	B	168.5/73.1
C52	4030011600	S.CER C1608 JB 1E 104K-T	B	178.2/84.3
C53	4030011600	S.CER C1608 JB 1E 104K-T	B	167.5/95.5
C54	4030011600	S.CER C1608 JB 1E 104K-T	T	143.7/78.8
C55	4030011600	S.CER C1608 JB 1E 104K-T	B	129.1/80.9
C56	4030011600	S.CER C1608 JB 1E 104K-T	B	129.9/87.6
C57	4030011600	S.CER C1608 JB 1E 104K-T	T	133.7/91.6
C58	4030011600	S.CER C1608 JB 1E 104K-T	T	136.7/91.6
C59	4030011600	S.CER C1608 JB 1E 104K-T	B	149.6/87.6
C60	4030011600	S.CER C1608 JB 1E 104K-T	B	150.3/81.9
C61	4030009990	S.CER C1608 CH 1H 200J-T	B	129.4/92.1
C62	4030011600	S.CER C1608 JB 1E 104K-T	B	17/58.8
C63	4030008890	S.CER C1608 JB 1H 273K-T	B	14.7/63.2
C64	4030011600	S.CER C1608 JB 1E 104K-T	B	19.9/60
C65	4030011600	S.CER C1608 JB 1E 104K-T	B	22.9/60.8
C66	4030011600	S.CER C1608 JB 1E 104K-T	T	263.7/68.6
C101	4030011600	S.CER C1608 JB 1E 104K-T	T	208.7/52.4
C102	4030011600	S.CER C1608 JB 1E 104K-T	B	149.4/29.7
C103	4030011600	S.CER C1608 JB 1E 104K-T	B	119.2/31.6
C104	4030011600	S.CER C1608 JB 1E 104K-T	B	138.5/32.5
C105	4030011600	S.CER C1608 JB 1E 104K-T	B	126.3/35.1
C106	4030011600	S.CER C1608 JB 1E 104K-T	B	139.8/32.5
C107	4030011600	S.CER C1608 JB 1E 104K-T	B	139.8/37.7
C108	4030011600	S.CER C1608 JB 1E 104K-T	B	139.8/42.9
C109	4030011600	S.CER C1608 JB 1E 104K-T	B	136.5/45.3
C110	4030011600	S.CER C1608 JB 1E 104K-T	B	129.3/32.5
C111	4550007520	S.TAN F931A106MAABMA	B	148.4/43.3
C112	4030011600	S.CER C1608 JB 1E 104K-T	B	146.8/44.6
C113	4550007520	S.TAN F931A106MAABMA	B	148.4/48.9
C114	4030011600	S.CER C1608 JB 1E 104K-T	B	146.8/47.7
C115	4550007520	S.TAN F931A106MAABMA	B	148.4/54
C116	4030011600	S.CER C1608 JB 1E 104K-T	B	146.8/50.8
C117	4030011600	S.CER C1608 JB 1E 104K-T	B	126.3/32.5
C118	4030011600	S.CER C1608 JB 1E 104K-T	B	135.9/32.5
C119	4030011600	S.CER C1608 JB 1E 104K-T	B	128/32.5
C120	4030011600	S.CER C1608 JB 1E 104K-T	B	127.9/45.3
C121	4030011600	S.CER C1608 JB 1E 104K-T	B	127.1/43.5
C122	4030011600	S.CER C1608 JB 1E 104K-T	B	127.1/42.2
C123	4030006860	S.CER C1608 JB 1H 102K-T	B	119.2/43.1
C124	4030011600	S.CER C1608 JB 1E 104K-T	B	126.3/37.7
C125	4030011600	S.CER C1608 JB 1E 104K-T	B	126.3/40.3
C126	4030011600	S.CER C1608 JB 1E 104K-T	B	130.6/32.5
C127	4030011600	S.CER C1608 JB 1E 104K-T	B	146.8/29.7
C128	4030011600	S.CER C1608 JB 1E 104K-T	B	146.8/38.5
C129	4030011600	S.CER C1608 JB 1E 104K-T	B	132.5/31.8
C130	4030011600	S.CER C1608 JB 1E 104K-T	B	130.5/45.3
C131	4030011600	S.CER C1608 JB 1E 104K-T	B	127.9/52.2
C132	4030011600	S.CER C1608 JB 1E 104K-T	B	133.7/45.3
C133	4030011600	S.CER C1608 JB 1E 104K-T	B	146.8/33.5
C134	4030011600	S.CER C1608 JB 1E 104K-T	B	139.5/25
C135	4030011600	S.CER C1608 JB 1E 104K-T	B	137.2/32.5
C136	4030011600	S.CER C1608 JB 1E 104K-T	B	139.8/40.3
C137	4030011600	S.CER C1608 JB 1E 104K-T	B	139.8/35.1
C138	4030011600	S.CER C1608 JB 1E 104K-T	B	128/40.3
C139	4030011600	S.CER C1608 JB 1E 104K-T	B	139.1/45.3
C140	4030006900	S.CER C1608 JB 1H 103K-T	B	139.1/52.2
C141	4030011600	S.CER C1608 JB 1E 104K-T	B	147.8/71.3
C142	4030011600	S.CER C1608 JB 1E 104K-T	T	147.1/71.9
C144	4030011600	S.CER C1608 JB 1E 104K-T	T	161.3/44.4
C145	4030007100	S.CER C1608 CH 1H 560J-T	T	158/46.2
C146	4030008560	S.CER C1608 CH 1H 300J-T	T	162.5/48
C147	4030007060	S.CER C1608 CH 1H 270J-T	T	162.5/49.2
C148	4030011600	S.CER C1608 JB 1E 104K-T	B	153.7/47.5
C149	4030011600	S.CER C1608 JB 1E 104K-T	T	161.3/43.2
C201	4030011600	S.CER C1608 JB 1E 104K-T	T	71.6/93.4
C202	4030011600	S.CER C1608 JB 1E 104K-T	T	71.6/90.8
C203	4030011600	S.CER C1608 JB 1E 104		

[LOGIC UNIT]

REF NO.	ORDER NO.	DESCRIPTION	M.	H/V LOCATION
C231	4030011600	S.CER C1608 JB 1E 104K-T	B	55.8/56.7
C232	4030011600	S.CER C1608 JB 1E 104K-T	B	58.4/45.8
C233	4030011600	S.CER C1608 JB 1E 104K-T	B	62.3/56.7
C234	4030011600	S.CER C1608 JB 1E 104K-T	B	66.8/53.6
C235	4030011600	S.CER C1608 JB 1E 104K-T	B	72.7/55.7
C236	4030011600	S.CER C1608 JB 1E 104K-T	B	57.1/56.7
C237	4030011600	S.CER C1608 JB 1E 104K-T	B	58.4/56.7
C238	4030011600	S.CER C1608 JB 1E 104K-T	B	59.7/56.7
C239	4030011600	S.CER C1608 JB 1E 104K-T	B	57.2/39.2
C240	4030011600	S.CER C1608 JB 1E 104K-T	B	63.6/56.7
C241	4030011600	S.CER C1608 JB 1E 104K-T	B	64.9/56.7
C242	4030011600	S.CER C1608 JB 1E 104K-T	B	66.8/57.5
C243	4030011600	S.CER C1608 JB 1E 104K-T	B	66.8/56.2
C244	4030011600	S.CER C1608 JB 1E 104K-T	B	61/45.8
C245	4030011600	S.CER C1608 JB 1E 104K-T	B	56.1/46.3
C246	4030011600	S.CER C1608 JB 1E 104K-T	B	61/56.7
C247	4030011600	S.CER C1608 JB 1E 104K-T	B	56.1/53.6
C248	4030011600	S.CER C1608 JB 1E 104K-T	B	66.8/54.9
C249	4030011600	S.CER C1608 JB 1E 104K-T	B	66.8/47.6
C250	4030007050	S.CER C1608 CH 1H 220J-T	T	46.1/55.4
C251	4030007050	S.CER C1608 CH 1H 220J-T	T	46.1/52.8
C252	4030006990	S.CER C1608 CH 1H 080D-T	T	77.1/51
C253	4030006990	S.CER C1608 CH 1H 080D-T	T	77.1/53.6
C254	4030006900	S.CER C1608 JB 1H 103K-T	T	51.8/37.3
C255	4510008520	S.ELE EEE1CA470SP	T	44.4/38
C256	4030006900	S.CER C1608 JB 1H 103K-T	T	72.6/37.1
C257	4510007130	S.ELE EEFCD 0J 470R	T	75/33.9
C258	4030011600	S.CER C1608 JB 1E 104K-T	T	78.3/37.5
C259	4030011600	S.CER C1608 JB 1E 104K-T	B	61.3/39.8
C260	4030011600	S.CER C1608 JB 1E 104K-T	B	83.1/5.5
C261	4030011600	S.CER C1608 JB 1E 104K-T	B	84.3/5.5
C262	4030011600	S.CER C1608 JB 1E 104K-T	B	82/14
C263	4030011600	S.CER C1608 JB 1E 104K-T	B	82/12.8
C264	4030011600	S.CER C1608 JB 1E 104K-T	B	75/15.2
C265	4510008540	S.ELE EEE1CA100SR	T	80.8/4.8
C266	4030011600	S.CER C1608 JB 1E 104K-T	B	81.7/18.6
C267	4030007100	S.CER C1608 CH 1H 560J-T	B	93.6/11
C268	4030007100	S.CER C1608 CH 1H 560J-T	B	93.6/13.8
C269	4030007100	S.CER C1608 CH 1H 560J-T	B	89.8/16.5
C270	4030007050	S.CER C1608 CH 1H 220J-T	B	98.5/10.7
C271	4030007050	S.CER C1608 CH 1H 220J-T	B	98.5/13.8
C272	4030007050	S.CER C1608 CH 1H 220J-T	B	98.5/16.7
C273	4030011600	S.CER C1608 JB 1E 104K-T	B	103.3/8.2
C274	4030007170	S.CER C1608 CH 1H 221J-T	B	115.5/6.6
C275	4030007170	S.CER C1608 CH 1H 221J-T	B	116.4/4
C276	4030007050	S.CER C1608 CH 1H 220J-T	B	147/2.4
C277	4030007050	S.CER C1608 CH 1H 220J-T	B	14/67.4
C278	4510008500	S.ELE EEE1CA101WP	T	15.4/68.7
C279	4030007050	S.CER C1608 CH 1H 220J-T	B	14/80
C280	4030007050	S.CER C1608 CH 1H 220J-T	B	14/75
C281	4510008500	S.ELE EEE1CA101WP	T	15.4/77.3
C283	4510008550	S.ELE EEE1HA010SR	T	22.4/80.6
C284	4030011600	S.CER C1608 JB 1E 104K-T	B	92/84.2
C285	4510008540	S.ELE EEE1CA100SR	T	92.3/83.6
C286	4510008540	S.ELE EEE1CA100SR	T	97/83.6
C287	4030011600	S.CER C1608 JB 1E 104K-T	B	95.7/84.2
C288	4510008540	S.ELE EEE1CA100SR	T	97/77.6
C289	4030011600	S.CER C1608 JB 1E 104K-T	B	94.5/84.2
C290	4030011600	S.CER C1608 JB 1E 104K-T	B	101.7/84.2
C291	4510008540	S.ELE EEE1CA100SR	T	101.7/83.6
C292	4510008540	S.ELE EEE1CA100SR	T	106.4/83.6
C293	4030011600	S.CER C1608 JB 1E 104K-T	B	104/84.2
C294	4510008540	S.ELE EEE1CA100SR	T	106.6/77.6
C295	4030011600	S.CER C1608 JB 1E 104K-T	B	105.2/84.2
C296	4030011600	S.CER C1608 JB 1E 104K-T	B	112.5/84.2
C297	4510008540	S.ELE EEE1CA100SR	T	111.6/77.6
C298	4030011600	S.CER C1608 JB 1E 104K-T	B	110.6/84.2
C299	4510008540	S.ELE EEE1CA100SR	T	111.1/83.6
C300	4030011600	S.CER C1608 JB 1E 104K-T	B	118/84.2
C301	4510008540	S.ELE EEE1CA100SR	T	116.6/77.6
C302	4030011600	S.CER C1608 JB 1E 104K-T	B	116.4/84.2
C303	4510008540	S.ELE EEE1CA100SR	T	115.8/83.6
C422	4030011600	S.CER C1608 JB 1E 104K-T	T	168.9/44.8
C423	4030011600	S.CER C1608 JB 1E 104K-T	B	184.6/30.6
C424	4030011600	S.CER C1608 JB 1E 104K-T	B	178.1/30.6
C425	4030011600	S.CER C1608 JB 1E 104K-T	B	173.1/30.6
C426	4030011600	S.CER C1608 JB 1E 104K-T	B	166.8/38.9
C427	4030011600	S.CER C1608 JB 1E 104K-T	B	166.8/44.8
C428	4030011600	S.CER C1608 JB 1E 104K-T	B	166.8/46
C429	4030011600	S.CER C1608 JB 1E 104K-T	T	191.3/57.8
C430	4030011600	S.CER C1608 JB 1E 104K-T	T	192.5/57.8
C431	4030011600	S.CER C1608 JB 1E 104K-T	B	177.5/53.7
C432	4030011600	S.CER C1608 JB 1E 104K-T	B	184.1/53.7
C433	4030011600	S.CER C1608 JB 1E 104K-T	B	186.5/53.7
C434	4030011600	S.CER C1608 JB 1E 104K-T	B	195.3/46.7
C435	4030011600	S.CER C1608 JB 1E 104K-T	B	195.3/45.2
C436	4030011600	S.CER C1608 JB 1E 104K-T	B	195.3/40.2
C437	4030011600	S.CER C1608 JB 1E 104K-T	T	262.6/42.2
C438	4030011600	S.CER C1608 JB 1E 104K-T	T	268/43.1
C439	4030011600	S.CER C1608 JB 1E 104K-T	T	249.4/51.6
C440	4010008500	CER DEBB3D102KA2B		
C601	4030011600	S.CER C1608 JB 1E 104K-T	T	254.7/65.1
C602	4030011600	S.CER C1608 JB 1E 104K-T	T	253.5/63.9
C603	4030011600	S.CER C1608 JB 1E 104K-T	B	212.4/69.5
C604	4030011600	S.CER C1608 JB 1E 104K-T	B	202.7/92
C605	4030011600	S.CER C1608 JB 1E 104K-T	B	183.7/89.7
C606	4030011600	S.CER C1608 JB 1E 104K-T	B	183.7/71.9
C607	4030011600	S.CER C1608 JB 1E 104K-T	B	183.7/70.5
C608	4510008540	S.ELE EEE1CA100SR	T	210.1/89.7
C609	4510008540	S.ELE EEE1CA100SR	T	214.8/89.7
C610	4030006900	S.CER C1608 JB 1H 103K-T	B	211.9/88.1
C611	4030006900	S.CER C1608 JB 1H 103K-T	B	213.2/88.1
C612	4030007010	S.CER C1608 CH 1H 100D-T	T	202.7/91.3
C613	4030007010	S.CER C1608 CH 1H 100D-T	T	200.1/91.3

[LOGIC UNIT]

REF NO.	ORDER NO.	DESCRIPTION	M.	H/V LOCATION
C614	4030011600	S.CER C1608 JB 1E 104K-T	B	197.3/92
C615	4030006880	S.CER C1608 JB 1H 472K-T	T	215.3/76.7
C616	4030006880	S.CER C1608 JB 1H 472K-T	T	215.3/77.9
C617	4030006880	S.CER C1608 JB 1H 472K-T	T	215.3/79.1
C618	4030006880	S.CER C1608 JB 1H 472K-T	T	215.3/80.3
C619	4030006880	S.CER C1608 JB 1H 472K-T	T	215.3/81.5
C620	4030006880	S.CER C1608 JB 1H 472K-T	T	215.3/82.7
C621	4030006880	S.CER C1608 JB 1H 472K-T	T	215.3/83.9
C622	4030006880	S.CER C1608 JB 1H 472K-T	T	215.3/85.1
C623	4510008540	S.ELE EEE1CA100SR	T	226/67.5
C624	4030011600	S.CER C1608 JB 1E 104K-T	B	223.4/69.9
C625	4510008540	S.ELE EEE1CA100SR	T	221.2/67.5
C626	4030011600	S.CER C1608 JB 1E 104K-T	B	210.4/62.9
C627	4030011600	S.CER C1608 JB 1E 104K-T	B	216.1/62.9
C628	4030011600	S.CER C1608 JB 1E 104K-T	T	175.1/57.2
C629	4030011600	S.CER C1608 JB 1E 104K-T	T	199.5/64.3
C630	4030011600	S.CER C1608 JB 1E 104K-T	T	170.8/92.8
C631	4030011600	S.CER C1608 JB 1E 104K-T	T	186.6/98
C632	4030011600	S.CER C1608 JB 1E 104K-T	T	186.6/104
C633	4030011600	S.CER C1608 JB 1E 104K-T	T	183.1/114.5
C634	4030011600	S.CER C1608 JB 1E 104K-T	T	178.5/114.5
C635	4030011600	S.CER C1608 JB 1E 104K-T	T	164.5/106.4
C636	4030011600	S.CER C1608 JB 1E 104K-T	T	164.5/99
C801	4510008540	S.ELE EEE1CA100SR	T	28.3/39.3
C802	4030011600	S.CER C1608 JB 1E 104K-T	T	23.4/48.3
C803	4030011600	S.CER C1608 JB 1E 104K-T	T	20.4/48.3
C804	4510008520	S.ELE EEE1CA470SP	T	14.3/40.3
C805	4510008870	S.ELE EEE1AA471UP	T	191.2/37
C806	4510008870	S.ELE EEE1AA471UP	T	182.4/25.4
C807	4510008870	S.ELE EEE1AA471UP	T	168.9/17.9
C808	4510008870	S.ELE EEE1AA471UP	T	189.2/5.6
C809	4510008560	S.ELE EEE1HAR47SR	T	244.1/87.2
C810	4510008560	S.ELE EEE1HAR47SR	T	244.1/80.1
C811	4510008870	S.ELE EEE1AA471UP	T	185.3/16.4
C816	4030006860	S.CER C1608 JB 1H 102K-T	T	205/31.1
C817	4030006860	S.CER C1608 JB 1H 102K-T	T	203/24.1
C818	4030006860	S.CER C1608 JB 1H 102K-T	T	205.4/18
C819	4030006860	S.CER C1608 JB 1H 102K-T	T	218.5/17.5
C820	4030006860	S.CER C1608 JB 1H 102K-T	T	218.5/14.8
C821	4510008520	S.ELE EEE1CA470SP	T	14.5/14.3
C822	4510008500	S.ELE EEE1CA101WP	T	255.9/23.7
C823	4030006880	S.CER C1608 JB 1H 472K-T	T	250/27.3
C825	4030011600	S.CER C1608 JB 1E 104K-T	T	240.8/40.3
C826	4030006860	S.CER C1608 JB 1H 102K-T	T	2.5/54.5
C827	4030006860	S.CER C1608 JB 1H 102K-T	T	2.5/57.1
C828	4030007130	S.CER C1608 CH 1H 101J-T	T	2.5/58.4
C829	4030006860	S.CER C1608 JB 1H 102K-T	T	2.5/51.5
C830	4030007130	S.CER C1608 CH 1H 101J-T	T	2.5/52.8
C831	4030006860	S.CER C1608 JB 1H 102K-T	T	2.5/48.9
C832	4030007130	S.CER C1608 CH 1H 101J-T	T	2.5/50.2
C833	4030006860	S.CER C1608 JB 1H 102K-T	T	2.5/45
C834	4030007130	S.CER C1608 CH 1H 101J-T	T	2.5/46.3
C835	4030011600	S.CER C1608 JB 1E 104K-T	T	20.4/52.6
C836	4510008540	S.ELE EEE1CA100SR	T	16.5/56.6
C837	4030011600	S.CER C1608 JB 1E 104K-T	T	23.4/52.6
C838	4510008540	S.ELE EEE1CA100SR	T	27.4/56.5
C850	4030011600	S.CER C1608 JB 1E 104K-T	T	54.9/102.5
C851	4510008540	S.ELE EEE1CA100SR	T	110.9/90.3
C852	4030009490	S.CER C1608 JB 1H 821K-T	B	113.3/88.2
C853	4030009490	S.CER C1608 JB 1H 821K-T	B	110/90.1
C855	4510008540	S.ELE EEE1CA100SR	T	118.3/90.2
C856	4030009490	S.CER C1608 JB 1H 821K-T	B	115.8/88.2
C857	4030009490	S.CER C1608 JB 1H 821K-T	B	119.2/90.1
C865	4510008540	S.ELE EEE1CA100SR	T	95.2/96.6
C866	4030007160	S.CER C1608 CH 1H 181J-T	B	101.1/100.4
C867	4030009880	S.CER C1608 JB 1H 682K-T	B	104/95
C868	4030008880	S.CER C1608 JB 1H 223K-T	B	104.7/98
C869	4510008540	S.ELE EEE1CA100SR	T	88.9/91.2
C871	4510008540	S.ELE EEE1CA100SR	T	103.2/91.2
C873	4030011600	S.CER C1608 JB 1E 104K-T	B	114.6/90.5
C874	4030011600	S.CER C1608 JB 1E 104K-T	B	114.5/101.9
C875	4510008540	S.ELE EEE1CA100SR	T	112.2/95.8
C876	4510008540	S.ELE EEE1CA100SR	T	116.9/95.8
C877	4030011600	S.CER C1608 JB 1E 104K-T	B	97.8/100
C878	4030011600	S.CER C1608 JB 1E 104K-T	B	97.2/88.6
C879</				

[LOGIC UNIT]

REF NO.	ORDER NO.	DESCRIPTION	M.	H/V LOCATION
C936	4030006860	S.CER C1608 JB 1H 102K-T	B	223.7/106.1
C937	4030006860	S.CER C1608 JB 1H 102K-T	T	222.7/94.6
C938	4030006860	S.CER C1608 JB 1H 102K-T	B	217.7/106.1
C939	4030006860	S.CER C1608 JB 1H 102K-T	T	216.7/94.6
C940	4030006860	S.CER C1608 JB 1H 102K-T	B	215.7/106.1
C941	4030006860	S.CER C1608 JB 1H 102K-T	T	214.7/94.6
C942	4030006860	S.CER C1608 JB 1H 102K-T	B	213.7/106.1
C943	4030006860	S.CER C1608 JB 1H 102K-T	T	212.8/94.6
C944	4030006860	S.CER C1608 JB 1H 102K-T	B	211.7/106.1
C945	4030006860	S.CER C1608 JB 1H 102K-T	T	211.5/94.6
C946	4030006860	S.CER C1608 JB 1H 102K-T	B	209.7/106.1
C947	4030006860	S.CER C1608 JB 1H 102K-T	T	59.9/16.2
C948	4030006860	S.CER C1608 JB 1H 102K-T	T	58.6/16.2
C949	4030006860	S.CER C1608 JB 1H 102K-T	T	57.3/16.2
C950	4030006860	S.CER C1608 JB 1H 102K-T	T	49.5/16.2
C951	4030006860	S.CER C1608 JB 1H 102K-T	T	46.9/16.2
C952	4030006860	S.CER C1608 JB 1H 102K-T	T	68.2/5.3
C953	4030006860	S.CER C1608 JB 1H 102K-T	B	59.5/8.7
C954	4030006860	S.CER C1608 JB 1H 102K-T	B	58/2.5
C955	4030006860	S.CER C1608 JB 1H 102K-T	B	49.6/13.3
C963	4030006860	S.CER C1608 JB 1H 102K-T	T	28.2/103.4
C964	4030006860	S.CER C1608 JB 1H 102K-T	T	19.5/104.7
C965	4030006860	S.CER C1608 JB 1H 102K-T	T	28.2/106
C966	4030006860	S.CER C1608 JB 1H 102K-T	T	19.5/109.3
C967	4030006860	S.CER C1608 JB 1H 102K-T	T	28.2/110.3
C968	4030006860	S.CER C1608 JB 1H 102K-T	T	16.5/101.1
C969	4030006860	S.CER C1608 JB 1H 102K-T	T	5.6/101.5
C970	4030006860	S.CER C1608 JB 1H 102K-T	T	5.6/107.8
C971	4030006860	S.CER C1608 JB 1H 102K-T	T	14.3/106.2
C977	4030006860	S.CER C1608 JB 1H 102K-T	T	51.5/107.5
C979	4030006860	S.CER C1608 JB 1H 102K-T	T	71.4/117.1
C980	4030006860	S.CER C1608 JB 1H 102K-T	T	71.4/112.1
C991	4030006880	S.CER C1608 JB 1H 472K-T	T	43.5/2.7
C998	4030006880	S.CER C1608 JB 1H 472K-T	T	33.4/4.9
C999	4030006860	S.CER C1608 JB 1H 102K-T	T	33.7/10.2
C1001	4030006880	S.CER C1608 JB 1H 472K-T	T	15.1/100.9
C1002	4030006880	S.CER C1608 JB 1H 472K-T	T	98.9/100.4
C2051	4030011600	S.CER C1608 JB 1E 104K-T	T	262/82.3
C2052	4030011600	S.CER C1608 JB 1E 104K-T	B	264.9/101.4
C2053	4030011600	S.CER C1608 JB 1E 104K-T	T	265/95.7
C2054	4030008680	S.CER C2012 JF 1C 105Z-T	T	270.5/89.5
C2055	4030008680	S.CER C2012 JF 1C 105Z-T	T	273.6/88.5
C2056	4030008680	S.CER C2012 JF 1C 105Z-T	T	279.9/91.2
C2057	4030008680	S.CER C2012 JF 1C 105Z-T	T	279.9/95
C2058	4030008680	S.CER C2012 JF 1C 105Z-T	T	274.6/100.7
J1	6510022490	S.CNR AXK5S30045P	T	94/19.9
J2	6510019870	S.CNR AXK5S40045P	T	94/64.9
J52	6510023261	S.CNR B6B-PH-SM4-TB (LF) (SN)	T	153.9/103.6
J102	6510019981	S.CNR 52808-1671 (1690)	T	153.6/65
J602	6510019971	S.CNR 52808-1071	T	218.9/57
J604	6510019971	S.CNR 52808-1071	T	224.1/82
J804	6510022031	S.CNR B10B-ZR-SM4-TF (LF) (SN)	T	6.2/72
J805	6510020081	S.CNR 52808-2071 (2090)	T	6.8/48
J806	6510022471	S.CNR 40FLT-SM2-TB (LF) (SN)	T	6.9/21.1
J808	6510020001	S.CNR 52808-3071 (3090)	T	217.2/114.8
J809	6510020001	S.CNR 52808-3071 (3090)	T	217.2/101.7
J810	6510020251	S.CNR B9B-PH-SM4-TB (LF) (SN)	T	113.9/115.9
J811	6510021561	S.CNR 52808-2470 (2490)	T	50/6.8
J813	6510019991	S.CNR 52808-2271 (2291)	T	23.9/99.5
J814	6510019981	S.CNR 52808-1671 (1690)	T	10/101
J816	6510019981	S.CNR 52808-1671 (1690)	T	60.2/112.4
J820	6510022801	S.CNR B10B-PH-SM4-TB (LF) (SN)	T	232.5/23.3
J821	6510020251	S.CNR B9B-PH-SM4-TB (LF) (SN)	T	214.8/22.3
J824	6510018971	S.CNR B4B-PH-SM4-TB (LF) (SN)	T	244.6/21.7
J826	6510015541	S.CNR B4B-ZR-SM4-TF (LF) (SN)	T	81.6/115.8
J2001	6510023720	CNR LGY6501-0600C		
J2052	6510023120	CNR CD6109SA1J0 <CVI>		
J2101	6510024040	CNR TM11R-5M2-88-LP		
J2201	6450001941	CNR KEY-15S-2A3A (LF) (SN)		
DS403	5040002930	S.LED SML-512MW T86	T	187.7/53.7
DS491	5040002930	S.LED SML-512MW T86	T	282.5/46.4
DS492	5040002930	S.LED SML-512MW T86	T	282.5/57.5
SS1	2260002740	S.SW LS8J2M-T	T	15.9/62.2
T401	5920000841	S.TSM H1102NL	T	259.2/49.4
EP102	6910013310	S.BEA MMZ1608D121B	T	159.4/33.3
EP103	6910013310	S.BEA MMZ1608D121B	T	158.2/33.3
EP201	6910012350	S.BEA MMZ1608Y 102BT	B	81.7/21.3
EP202	6910012350	S.BEA MMZ1608Y 102BT	B	81.7/19.8
EP203	6910012350	S.BEA MMZ1608Y 102BT	T	50.6/37.3
EP204	6910012350	S.BEA MMZ1608Y 102BT	T	69.6/35.4
EP401	6910013310	S.BEA MMZ1608D121B	T	184.1/53.7
EP402	6910013310	S.BEA MMZ1608D121B	T	177.5/53.7
EP403	6910013310	S.BEA MMZ1608D121B	T	186.5/53.7
EP801	6910013310	S.BEA MMZ1608D121B	B	5.7/30.4
EP802	6910013310	S.BEA MMZ1608D121B	B	8/29.4
EP803	6910013310	S.BEA MMZ1608D121B	B	11.2/28.9
EP804	6910013310	S.BEA MMZ1608D121B	B	5.7/28.4
EP805	6910013310	S.BEA MMZ1608D121B	B	8/27.4
EP806	6910013310	S.BEA MMZ1608D121B	B	11.2/26.9
EP807	6910013310	S.BEA MMZ1608D121B	B	5.7/26.4
EP808	6910013310	S.BEA MMZ1608D121B	B	8/25.4
EP809	6910013310	S.BEA MMZ1608D121B	B	11.2/24.9
EP810	6910013310	S.BEA MMZ1608D121B	B	5.7/24.4
EP811	6910013310	S.BEA MMZ1608D121B	B	8/23.4

[LOGIC UNIT]

REF NO.	ORDER NO.	DESCRIPTION	M.	H/V LOCATION
EP812	6910013310	S.BEA MMZ1608D121B	B	11.2/22.9
EP813	6910013310	S.BEA MMZ1608D121B	B	5.7/22.4
EP814	6910013310	S.BEA MMZ1608D121B	B	8/21.4
EP815	6910013310	S.BEA MMZ1608D121B	B	11.2/20.9
EP816	6910013310	S.BEA MMZ1608D121B	B	5.7/20.4
EP817	6910013310	S.BEA MMZ1608D121B	B	8/19.4
EP818	6910013310	S.BEA MMZ1608D121B	B	11.2/18.9
EP819	6910013310	S.BEA MMZ1608D121B	B	5.7/18.4
EP820	6910013310	S.BEA MMZ1608D121B	B	8/17.4
EP821	6910015980	S.BEA MMZ1608S 181CT-AS	T	224.4/28.9
EP822	6910015980	S.BEA MMZ1608S 181CT-AS	T	224.4/27.7
EP824	6910014730	S.BEA MPZ2012S331A-T	T	12/50.5
EP825	6910014730	S.BEA MPZ2012S331A-T	T	12/46.5
EP826	6910012350	S.BEA MMZ1608Y 102BT	B	12.5/44.5
EP827	6910012350	S.BEA MMZ1608Y 102BT	B	12.5/41.8
EP828	6910012350	S.BEA MMZ1608Y 102BT	B	12.5/40.5
EP829	6910012350	S.BEA MMZ1608Y 102BT	B	12.5/43.2
EP832	6910014730	S.BEA MPZ2012S331A-T	T	224.1/25.6
EP833	6910014730	S.BEA MPZ2012S331A-T	T	224.1/23.9
EP834	6910014730	S.BEA MPZ2012S331A-T	T	208.5/15.8
EP835	6910014730	S.BEA MPZ2012S331A-T	T	206.8/15.8
EP836	6910014730	S.BEA MPZ2012S331A-T	T	224.1/20.3
EP837	6910014730	S.BEA MPZ2012S331A-T	T	224.1/16.2
EP838	6910014730	S.BEA MPZ2012S331A-T	T	12/57.5
EP839	6910014730	S.BEA MPZ2012S331A-T	T	12/53.5
EP840	6910014730	S.BEA MPZ2012S331A-T	T	12/55.7
EP851	6910015970	S.BEA MMZ1608B 301CT-AS	T	107.9/109.4
EP852	6910015970	S.BEA MMZ1608B 301CT-AS	T	111.9/109.4
EP853	6910015970	S.BEA MMZ1608B 301CT-AS	T	115.9/109.4
EP854	6910015970	S.BEA MMZ1608B 301CT-AS	T	119.9/109.4
EP901	6910014730	S.BEA MPZ2012S331A-T	T	65.6/7.9
EP902	6910014730	S.BEA MPZ2012S331A-T	B	57.1/11.1
EP903	6910014730	S.BEA MPZ2012S331A-T	B	55.1/15.1
EP904	6910014730	S.BEA MPZ2012S331A-T	B	54.2/11.9
EP905	6910014730	S.BEA MPZ2012S331A-T	T	35.4/5.9
EP907	6910015980	S.BEA MMZ1608S 181CT-AS	T	57.3/13.4
EP908	6910015980	S.BEA MMZ1608S 181CT-AS	T	56/13.4
EP909	6910015980	S.BEA MMZ1608S 181CT-AS	T	54.7/13.4
EP910	6910015980	S.BEA MMZ1608S 181CT-AS	T	53.4/13.4
EP911	6910015980	S.BEA MMZ1608S 181CT-AS	T	52.1/13.4
EP912	6910015980	S.BEA MMZ1608S 181CT-AS	T	50.8/13.4
EP918	6910014730	S.BEA MPZ2012S331A-T	T	71.8/115.5
EP919	6910014730	S.BEA MPZ2012S331A-T	T	71.8/113.7
EP920	6910014730	S.BEA MPZ2012S331A-T	T	64.7/107.7
EP932	6910014690	S.BEA MPZ1608S221A-T	T	229.7/106.1
EP933	6910014690	S.BEA MPZ1608S221A-T	T	228.7/97.2
EP972	6910015970	S.BEA MMZ1608B 301CT-AS	T	79.3/110.1
EP973	6910015970	S.BEA MMZ1608B 301CT-AS	T	82.1/109.9
EP1113	6910014690	S.BEA MPZ1608S221A-T	T	28.2/104.7
EP1114	6910014690	S.BEA MPZ1608S221A-T	T	19.5/106
EP1116	6910014690	S.BEA MPZ1608S221A-T	T	19.5/108
EP1117	6910014690	S.BEA MPZ1608S221A-T	T	28.2/109
EP1123	6910015970	S.BEA MMZ1608B 301CT-AS	T	14.4/98.8
EP1124	6910015970	S.BEA MMZ1608B 301CT-AS	T	5.6/100.2
EP2001	6910012350	S.BEA MMZ1608Y 102BT	T	276.2/70.7
EP2002	6910012350	S.BEA MMZ1608Y 102BT	T	276.2/72.1
EP2051	6910014730	S.BEA MPZ2012S331A-T	T	256.3/98.1

[MEMORY BOARD]

REF NO.	ORDER NO.	DESCRIPTION	M.	H/V LOCATION
IC1	1130014294	S.IC JS28F128J3D-75(SX-3009A-5)		
IC2	1130013480	S.IC JS28F128J3D-75		
C1	4030011600	S.CER C1608 JB 1E 104K-T		
C2	4030011600	S.CER C1608 JB 1E 104K-T		
C3	4030011600	S.CER C1608 JB 1E 104K-T		
C4	4030011600	S.CER C1608 JB 1E 104K-T		
C5	4030011600	S.CER C1608 JB 1E 104K-T		
C6	4030011600	S.CER C1608 JB 1E 104K-T		
J1	6510024410	S.CNR AXK6S30545		
J2	6510020120	S.CNR AXK6S40545P		

M.=Mounted side (T: Mounted on the Top side B: Mounted on the Bottom side)
S.=Surface mount

[PA200W BOARD]

REF NO.	ORDER NO.	DESCRIPTION	M.	H/V LOCATION
IC2	1180001541	S.IC TA78L08F (TE12L,F)	T	58.8/15.1
Q1	1520000531	S.TR 2SB1119S-TD-E	T	42.8/19.2
Q2	1590000680	S.TR DTC114EUA T106	T	45.8/13.5
Q101	1560001241	S.FET RD01MUS1-T113	T	5.9/66.4
Q201	1590003051	S.FET PDS5003-E	T	20.5/53.1
Q301	1590003840	FET MRF148A	T	64/45.8
Q401	1560001211	FET MRF150 (SRFJ150MP) M/A		
D1	1730000561	S.ZEN RD2.7M-T2B-A B1	T	100.6/22.8
D401	1750000271	S.DIO 1SS301 (TE85L,F)	T	116.8/99.1
D402	1750000271	S.DIO 1SS301 (TE85L,F)	T	118.3/35.9
D403	1750000271	S.DIO 1SS301 (TE85L,F)	T	104/98.3
D404	1750000271	S.DIO 1SS301 (TE85L,F)	T	104/35.7
D551	1790000491	S.DIO HSM88ASTR-E	T	150.1/35.3
L1	6200005011	S.COL NLV25T-100J	T	14.7/18
L2	6200005011	S.COL NLV25T-100J	T	14.7/20.5
L3	6200005011	S.COL NLV25T-100J	T	14.7/23
L4	6200005011	S.COL NLV25T-100J	T	14.7/29
L6	6200005011	S.COL NLV25T-100J	T	14.7/25.5
L7	6200010881	S.COL CDRH124NP-330MC	T	77.3/11
L101	6200005131	S.COL NLC453232T-101K-PF	T	5.6/59.6
L102	6200007220	S.COL EXCLCL4532U1	T	6/38.4
L201	6180001240	COL LAL 04NA 820K		
L202	6140004350	COL LR-475		
L301	6200003261	S.COL NLV32T-101J	T	46.1/36.4
L303	6200001831	S.COL NLV32T-100J	T	86.9/26.2
L304	2040000490	COL EXC-ELDR25C		
L305	2040000490	COL EXC-ELDR25C		
L306	6140004340	COL LR-474		
L307	6200001831	S.COL NLV32T-100J	T	75.7/100.2
L401	6200003261	S.COL NLV32T-101J	T	100.4/98.3
L402	6200003261	S.COL NLV32T-101J	T	100.1/35.8
L403	6140002590	COL LR-296 (TR18X8X8 D12A)		
L404	6140000720	COL LR-95	T	166.4/67
L501	6140002030	COL LR-230 (SK-10M-15Y 120)		
R1	7030003440	S.RES ERJ3GEYJ 102 V (1 k)	T	42.8/12.8
R2	7030003560	S.RES ERJ3GEYJ 103 V (10 k)	T	42.8/14.2
R3	7510001740	TMR DTN-C103F3H-STS-40		
R4	7030000380	S.RES MCR10EZHHJ 1 k	T	39.7/22.5
R5	7030008061	S.RES ERA3YED 222V (2.2 k)	T	104.3/23.1
R6	7030007210	S.RES ERA3YEB 102V (1 k)	T	103.6/16.5
R7	7030007210	S.RES ERA3YEB 102V (1 k)	T	103.6/17.8
R101	7030003370	S.RES ERJ3GEYJ 271 V (270)	T	6/87.2
R102	7030003220	S.RES ERJ3GEYJ 150 V (15)	T	3.9/86.1
R103	7030003370	S.RES ERJ3GEYJ 271 V (270)	T	6/85
R104	7030003360	S.RES ERJ3GEYJ 221 V (220)	T	4.8/71.3
R105	7030003430	S.RES ERJ3GEYJ 821 V (820)	T	6/73.3
R106	7030003480	S.RES ERJ3GEYJ 222 V (2.2 k)	T	9.2/73.8
R107	7030003440	S.RES ERJ3GEYJ 102 V (1 k)	T	2.2/64.7
R108	7030003200	S.RES ERJ3GEYJ 100 V (10)	T	9.2/68.3
R110	7030000230	S.RES MCR10EZHHJ 56 (560)	T	11.3/56.6
R111	7030003420	S.RES ERJ3GEYJ 681 V (680)	T	13.3/58.6
R112	7030003510	S.RES ERJ3GEYJ 392 V (3.9 k)	T	12.6/60.6
R113	7030003500	S.RES ERJ3GEYJ 332 V (3.3 k)	T	6.8/75.2
R115	7030003520	S.RES ERJ3GEYJ 472 V (4.7 k)	T	13.1/40.8
R117	7030003530	S.RES ERJ3GEYJ 562 V (5.6 k)	T	7.7/76.5
R118	7030003550	S.RES ERJ3GEYJ 822 V (8.2 k)	T	11.7/40.8
R119	7030008240	S.RES ERJ12Y0R00U	T	5/49.6
R201	7030004050	S.RES ERJ3GEYJ 1R0 V (1)	T	13.8/48.6
R202	7030003410	S.RES ERJ3GEYJ 561 V (560)	T	23.1/43.1
R203	7030010800	S.RES ERJ1TYJ 2R7U (2.7)	T	18.4/65.5
R205	7030006260	S.RES ERJ12YJ471U (470)	T	30.3/55.7
R301	7310005210	TRI VM5CK-PVB 20 k		
R302	7030008180	S.RES ERJ12YJ331U (330)	T	48.3/40.6
R305	7030003530	S.RES ERJ3GEYJ 562 V (5.6 k)	T	49.6/43.5
R307	7070000830	RES ERG3SJ 101 (100)		
R309	7030010570	S.RES ERJ1TYJ 4R7U (4.7)	T	80/45.8
R310	7310005200	TRI VM5CK-PVB 2 k		
R312	7070000830	RES ERG3SJ 101 (100)		
R401	7030010960	S.RES ERJ1TYJ 120U (12)	T	89.8/90.7
R402	7030010960	S.RES ERJ1TYJ 120U (12)	T	93.5/90.7
R403	7030010960	S.RES ERJ1TYJ 120U (12)	T	97.2/90.7
R404	7030010960	S.RES ERJ1TYJ 120U (12)	T	90.8/43.3
R405	7030010960	S.RES ERJ1TYJ 120U (12)	T	94.5/43.3
R406	7030010960	S.RES ERJ1TYJ 120U (12)	T	98.2/43.3
R407	7310005230	TRI VM5CK-PVB 10 k		
R408	7030000420	S.RES MCR10EZHHJ 2.2 k	T	116.3/96
R409	7030000420	S.RES MCR10EZHHJ 2.2 k	T	116.3/38
R410	7310005230	TRI VM5CK-PVB 10 k		
R411	7030010520	S.RES ERJ1TYJ 101U (100)	T	107.6/93.9
R412	7030010520	S.RES ERJ1TYJ 101U (100)	T	107.5/40.2
R413	7030010520	S.RES ERJ1TYJ 101U (100)	T	111.3/93.9
R414	7030010520	S.RES ERJ1TYJ 101U (100)	T	111.2/40.2
R416	7070000890	RES ERG3SJ 150 (15)		
R418	7070001190	RES ERG3SJ180 (18)		
R420	7070000890	RES ERG3SJ 150 (15)		
R422	7070001190	RES ERG3SJ180 (18)		
R423	7030003460	S.RES ERJ3GEYJ 152 V (1.5 k)	T	95.9/98.4
R424	7030003460	S.RES ERJ3GEYJ 152 V (1.5 k)	T	99.4/33.6
R425	7310005200	TRI VM5CK-PVB 2 k		
R426	7310005200	TRI VM5CK-PVB 2 k		
R427	7070001200	RES ERG3SJ100P (10)		
R501	7070000890	RES ERG3SJ 150 (15)		
R502	7070000890	RES ERG3SJ 150 (15)		
R503	7030003500	S.RES ERJ3GEYJ 332 V (3.3 k)	T	171.8/16.7
R504	7030003500	S.RES ERJ3GEYJ 332 V (3.3 k)	T	169.9/15.9
R507	7030003500	S.RES ERJ3GEYJ 332 V (3.3 k)	T	139.1/17.9
R508	7030003500	S.RES ERJ3GEYJ 332 V (3.3 k)	T	137.3/19.2
R511	7070000890	RES ERG3SJ 150 (15)		
R512	7070000890	RES ERG3SJ 150 (15)		
R513	7070001000	RES ERG3SJ 821 (820)		

[PA200W BOARD]

REF NO.	ORDER NO.	DESCRIPTION	M.	H/V LOCATION
R514	7070001000	RES ERG3SJ 821 (820)		
R521	7030011160	S.RES RL7520WT-R010-F	T	165.2/20.2
R522	7030011160	S.RES RL7520WT-R010-F	T	159.6/20.2
R523	7030011160	S.RES RL7520WT-R010-F	T	154/20.2
R551	7030010650	S.RES ERJ12YJ823U (82 k)	T	144.5/34.2
R552	7030008020	S.RES ERJ12YJ472U (4.7 k)	T	141.2/28.3
R554	7030003560	S.RES ERJ3GEYJ 103 V (10 k)	T	154.5/34.2
R563	7030008240	S.RES ERJ12Y0R00U	T	137.5/28.9
R564	7030008240	S.RES ERJ12Y0R00U	T	156.6/30
R565	7030008240	S.RES ERJ12Y0R00U	T	146/29.4
C1	4030011600	S.CER C1608 JB 1E 104K-T	T	18.9/18
C2	4030006880	S.CER C1608 JB 1H 472K-T	T	18.9/20.5
C3	4030006880	S.CER C1608 JB 1H 472K-T	T	18.9/23
C4	4030006880	S.CER C1608 JB 1H 472K-T	T	18.9/29
C6	4030006880	S.CER C1608 JB 1H 472K-T	T	18.9/25.5
C7	4030006900	S.CER C1608 JB 1H 103K-T	T	70/6.8
C8	4030006880	S.CER C1608 JB 1H 472K-T	T	42.8/15.6
C9	4030011600	S.CER C1608 JB 1E 104K-T	T	57.6/11.4
C10	4510008520	S.ELE EEE1CA470SP	T	52/15.5
C11	4030006900	S.CER C1608 JB 1H 103K-T	T	60.4/11.4
C12	4510008520	S.ELE EEE1CA470SP	T	64.9/15.5
C15	4030006880	S.CER C1608 JB 1H 472K-T	T	104.3/20.4
C16	4030006880	S.CER C1608 JB 1H 472K-T	T	103/23.1
C17	4510008550	S.ELE EEE1HA010SR	T	95.9/22.8
C102	4030017810	S.CER C1608 CH 1H 102J-T	T	4.1/76.2
C103	4030011600	S.CER C1608 JB 1E 104K-T	T	9.2/72.5
C104	4030011600	S.CER C1608 JB 1E 104K-T	T	9.5/75.2
C106	4030017320	S.CER GRM21BB11H104KA01L	T	2.2/67.7
C107	4030011600	S.CER C1608 JB 1E 104K-T	T	9.2/70.9
C108	4030017810	S.CER C1608 CH 1H 102J-T	T	9.2/69.6
C109	4030017320	S.CER GRM21BB11H104KA01L	T	8.1/62.6
C110	4030017810	S.CER C1608 CH 1H 102J-T	T	9/64.2
C111	4030017810	S.CER C1608 CH 1H 102J-T	T	9/56.4
C112	4030017320	S.CER GRM21BB11H104KA01L	T	8.7/54.8
C113	4030011600	S.CER C1608 JB 1E 104K-T	T	5.3/102.4
C114	4030011600	S.CER C1608 JB 1E 104K-T	T	13.9/60.6
C201	4030017320	S.CER GRM21BB11H104KA01L	T	18.2/43.1
C202	4030017810	S.CER C1608 CH 1H 102J-T	T	15.7/61.3
C204	4030008490	S.CER C2012 JB 1H 682K-T	T	31.2/61.6
C206	4030008700	S.CER GRM21BB11H473KA01L	T	29.3/61.6
C207	4030008700	S.CER GRM21BB11H473KA01L	T	34.4/36.7
C301	4030004760	S.CER C2012 JF 1H 104Z-T	T	49.4/45.5
C303	4030011600	S.CER C1608 JB 1E 104K-T	T	43.4/35.4
C305	4030004760	S.CER C2012 JF 1H 104Z-T	T	44.4/42.6
C307	4030017810	S.CER C1608 CH 1H 102J-T	T	39.7/31.7
C309	4030011600	S.CER C1608 JB 1E 104K-T	T	41.1/31.7
C311	4030018750	S.CER C3225 CH 2J 682K-T	T	54.1/58.9
C313	4030011600	S.CER C1608 JB 1E 104K-T	T	89.1/26.9
C314	4510008050	ELE 63 ME 220 CZ		
C317	4030018790	S.CER C3225 JB 2E 104K-T	T	76.8/34
C318	4030011600	S.CER C1608 JB 1E 104K-T	T	77.2/96.7
C319	4030018790	S.CER C3225 JB 2E 104K-T	T	70.4/79
C401	4030011790	S.CER GRM55RF52A684ZD01L	T	92.4/82.2
C402	4030011790	S.CER GRM55RF52A684ZD01L	T	92.4/51.8
C403	4030011600	S.CER C1608 JB 1E 104K-T	T	79.9/100.1
C404	4030011600	S.CER C1608 JB 1E 104K-T	T	88.6/30.3
C405	4030006900	S.CER C1608 JB 1H 103K-T	T	79.9/98.0
C406	4030006900	S.CER C1608 JB 1H 103K-T	T	88.6/31.6
C407	4030017810	S.CER C1608 CH 1H 102J-T	T	79.9/97.5
C408	4030017810	S.CER C1608 CH 1H 102J-T	T	88.6/32.9
C409	4030018790	S.CER C3225 JB 2E 104K-T	T	111.3/100.2
C410	4030018790	S.CER C3225 JB 2E 104K-T	T	111.2/33.9
C411	4030006880	S.CER C1608 JB 1H 472K-T	T	114.9/99.1
C412	4030006880	S.CER C1608 JB 1H 472K-T	T	116.3/35
C413	4030011600	S.CER C1608 JB 1E 104K-T	T	97.8/99.1
C414	4030011600	S.CER C1608 JB 1E 104K-T	T	97.4/36.5
C415	4030011790	S.CER GRM55RF52A684ZD01L	T	102.8/88.8
C416	4030011790	S.CER GRM55RF52A684ZD01L	T	103.8/49
C417	4030018760	S.CER C4532 CH 2A 104K-T	T	190.2/82.6
C418	4030018760	S.CER C4532 CH 2A 104K-T	T	193.9/82.6

[FILTER UNIT]

REF NO.	ORDER NO.	DESCRIPTION	M.	H/V LOCATION
D402	1750000271	S.DIO 1SS301 (TE85L,F)	T	11.8/24.3
D452	1750000271	S.DIO 1SS301 (TE85L,F)	T	32/20.5
D502	1750000271	S.DIO 1SS301 (TE85L,F)	T	54.8/30.3
D552	1750000271	S.DIO 1SS301 (TE85L,F)	T	155.6/29.1
D602	1750000271	S.DIO 1SS301 (TE85L,F)	T	130.1/20.3
D652	1750000271	S.DIO 1SS301 (TE85L,F)	T	93.8/33
D702	1750000271	S.DIO 1SS301 (TE85L,F)	T	69.6/20.3
D752	1750000271	S.DIO 1SS301 (TE85L,F)	T	113.1/33
D802	1750000271	S.DIO 1SS301 (TE85L,F)	T	173.6/25.9
L401	6200005131	S.COL NLC453232T-101K-PF	T	25.4/136.7
L402	6140004310	COL LR-471		
L403	6140004300	COL LR-470		
L404	6140004300	COL LR-470		
L405	6200005131	S.COL NLC453232T-101K-PF	T	7.3/24.6
L451	6200005131	S.COL NLC453232T-101K-PF	T	4.4/143.9
L452	6140004270	COL LR-467		
L453	6140004290	COL LR-469		
L454	6140004290	COL LR-469		
L455	6200005131	S.COL NLC453232T-101K-PF	T	28.4/29.9
L501	6200005131	S.COL NLC453232T-101K-PF	T	46.3/133.8
L502	6140004280	COL LR-468		
L503	6140004270	COL LR-467		
L504	6140004270	COL LR-467		
L505	6200005131	S.COL NLC453232T-101K-PF	T	50.2/29.6
L551	6200005131	S.COL NLC453232T-101K-PF	T	150.7/133.8
L552	6140004260	COL LR-466		
L553	6140004280	COL LR-468		
L554	6140004280	COL LR-468		
L555	6200005131	S.COL NLC453232T-101K-PF	T	151/29.7
L601	6200005131	S.COL NLC453232T-101K-PF	T	129.9/133.8
L602	6140004250	COL LR-465		
L603	6140004240	COL LR-464		
L604	6140004240	COL LR-464		
L605	6200005131	S.COL NLC453232T-101K-PF	T	130.1/14.2
L651	6200005131	S.COL NLC453232T-101K-PF	T	88.2/133.8
L652	6140004200	COL LR-463		
L653	6140004170	COL LR-462		
L654	6140004170	COL LR-462		
L655	6200005131	S.COL NLC453232T-101K-PF	T	92.3/29.8
L701	6200005131	S.COL NLC453232T-101K-PF	T	67.2/133.8
L702	6140004130	COL LR-461		
L703	6140004070	COL LR-460		
L704	6140004070	COL LR-460		
L705	6200005131	S.COL NLC453232T-101K-PF	T	69.6/14.1
L751	6200005131	S.COL NLC453232T-101K-PF	T	109.1/133.8
L752	6110003900	COL LA-592		
L753	6110003890	COL LA-591		
L754	6110003890	COL LA-591		
L755	6200005131	S.COL NLC453232T-101K-PF	T	111.4/29.8
L801	6200001831	S.COL NLV32T-100J	T	165.9/163.4
L802	6110003880	COL LA-590		
L803	6110003870	COL LA-589		
L804	6110003870	COL LA-589		
L805	6200001831	S.COL NLV32T-100J	T	173.9/22.8
C401	4030006880	S.CER C1608 JB 1H 472K-T	T	25.4/130.4
C402	4010008200	CER HM11TJ SL 331J 500V		
C403	4010008200	CER HM11TJ SL 331J 500V		
C404	4010008300	CER HM11TJ SL 391J 500V		
C405	4010008300	CER HM11TJ SL 391J 500V		
C406	4010008210	CER HM60TJ SL 560J 500V		
C407	4010007590	CER HM15SJ SL 681J 500V		
C408	4010007590	CER HM15SJ SL 681J 500V		
C409	4010007590	CER HM15SJ SL 681J 500V		
C410	4010005870	CER HM95TJ SL 221J 500V		
C411	4010008280	CER HM95TJ SL 221J 500V		
C412	4010008370	CER HM60TJ SL 150J 500V		
C413	4010007590	CER HM15SJ SL 681J 500V		
C414	4010007590	CER HM15SJ SL 681J 500V		
C415	4010007590	CER HM15SJ SL 681J 500V		
C416	4010008300	CER HM11TJ SL 391J 500V		
C417	4010008230	CER HM60TJ SL 820J 500V		
C418	4010007590	CER HM15SJ SL 681J 500V		
C419	4010007590	CER HM15SJ SL 681J 500V		
C420	4030006880	S.CER C1608 JB 1H 472K-T	T	11.6/26.3
C451	4030006880	S.CER C1608 JB 1H 472K-T	T	26.6/127.9
C452	4010008290	CER HM95TJ SL 271J 500V		
C453	4010008280	CER HM95TJ SL 221J 500V		
C454	4010008240	CER HM60TJ SL 101J 500V		
C455	4010005810	CER HM74SJ SL 111J 500V		
C456	4010007490	CER HM15SJ SL 561J 500V		
C457	4010006410	CER HM13SJ SL 471J 500V		
C458	4010008250	CER HM74TJ SL 121J 500V		
C459	4010005810	CER HM74SJ SL 111J 500V		
C461	4010007490	CER HM15SJ SL 561J 500V		
C462	4010007490	CER HM15SJ SL 561J 500V		
C463	4010008340	CER HM60TJ SL 270J 500V		
C464	4010008320	CER HM60TJ SL 390J 500V		
C465	4010007490	CER HM15SJ SL 561J 500V		
C466	4010008220	CER HM60TJ SL 680J 500V		
C467	4030006880	S.CER C1608 JB 1H 472K-T	T	32.4/23.4
C468	4010008230	CER HM60TJ SL 820J 500V		
C501	4030006880	S.CER C1608 JB 1H 472K-T	T	47.6/127.3
C502	4010008280	CER HM95TJ SL 221J 500V		
C503	4010008260	CER HM74TJ SL 151J 500V		
C504	4010008280	CER HM95TJ SL 221J 500V		
C506	4010008200	CER HM11TJ SL 331J 500V		
C507	4010008280	CER HM95TJ SL 221J 500V		
C508	4010008280	CER HM95TJ SL 221J 500V		
C509	4010005810	CER HM74SJ SL 111J 500V		
C511	4010008300	CER HM11TJ SL 391J 500V		
C512	4010008300	CER HM11TJ SL 391J 500V		
C513	4010008260	CER HM74TJ SL 151J 500V		
C514	4010008320	CER HM60TJ SL 390J 500V		
C515	4010008280	CER HM95TJ SL 221J 500V		
C516	4010008280	CER HM95TJ SL 221J 500V		
C517	4030006880	S.CER C1608 JB 1H 472K-T	T	54.7/28.4
C518	4010008340	CER HM60TJ SL 270J 500V		
C551	4030006880	S.CER C1608 JB 1H 472K-T	T	149.9/122.5
C552	4010005860	CER HM95SJ SL 201J 500V		
C554	4010008230	CER HM60TJ SL 820J 500V		

[FILTER UNIT]

REF NO.	ORDER NO.	DESCRIPTION	M.	H/V LOCATION
C555	4010008370	CER HM60TJ SL 150J 500V		
C556	4010008290	CER HM95TJ SL 271J 500V		
C557	4010008290	CER HM95TJ SL 271J 500V		
C558	4010008320	CER HM60TJ SL 390J 500V		
C559	4010008330	CER HM60TJ SL 330J 500V		
C560	4010008340	CER HM60TJ SL 270J 500V		
C561	4010008200	CER HM11TJ SL 331J 500V		
C562	4010008290	CER HM95TJ SL 271J 500V		
C563	4010008330	CER HM60TJ SL 330J 500V		
C564	4010005650	CER HM60SJ SL 200J 500V		
C565	4010008280	CER HM95TJ SL 221J 500V		
C566	4010008350	CER HM60TJ SL 220J 500V		
C567	4030006880	S.CER C1608 JB 1H 472K-T	T	152.2/32.2
C601	4030006880	S.CER C1608 JB 1H 472K-T	T	130.2/125
C604	4010008230	CER HM60TJ SL 820J 500V		
C605	4010008370	CER HM60TJ SL 150J 500V		
C606	4010008280	CER HM95TJ SL 221J 500V		
C607	4010008220	CER HM60TJ SL 680J 500V		
C608	4010008350	CER HM60TJ SL 220J 500V		
C609	4010008340	CER HM60TJ SL 270J 500V		
C610	4010008200	CER HM11TJ SL 331J 500V		
C611	4010008230	CER HM60TJ SL 820J 500V		
C612	4010008360	CER HM60TJ SL 180J 500V		
C613	4010008260	CER HM74TJ SL 151J 500V		
C614	4010008230	CER HM60TJ SL 820J 500V		
C615	4030006880	S.CER C1608 JB 1H 472K-T	T	130.2/18.3
C651	4030006880	S.CER C1608 JB 1H 472K-T	T	88.3/124.9
C654	4010008360	CER HM60TJ SL 180J 500V		
C655	4010008320	CER HM60TJ SL 390J 500V		
C656	4010008280	CER HM95TJ SL 221J 500V		
C657	4010008220	CER HM60TJ SL 680J 500V		
C658	4010008360	CER HM60TJ SL 180J 500V		
C659	4010008380	CER HM60TJ SL 120J 500V		
C660	4010008280	CER HM95TJ SL 221J 500V		
C661	4010008240	CER HM60TJ SL 101J 500V		
C662	4010008390	CER HM60TJ SL 100D 500V		
C663	4010008250	CER HM74TJ SL 121J 500V		
C664	4010008320	CER HM60TJ SL 390J 500V		
C665	4030006880	S.CER C1608 JB 1H 472K-T	T	96.6/28.6
C701	4030006880	S.CER C1608 JB 1H 472K-T	T	68.6/127.5
C703	4010008370	CER HM60TJ SL 150J 500V		
C704	4010008350	CER HM60TJ SL 220J 500V		
C705	4010005650	CER HM60SJ SL 200J 500V		
C706	4010005860	CER HM95SJ SL 201J 500V		
C707	4010008310	CER HM60TJ SL 470J 500V		
C708	4010008370	CER HM60TJ SL 150J 500V		
C709	4010008280	CER HM95TJ SL 221J 500V		
C710	4010008350	CER HM60TJ SL 220J 500V		
C712	4010008330	CER HM60TJ SL 330J 500V		
C713	4010008310	CER HM60TJ SL 470J 500V		
C714	4030006880	S.CER C1608 JB 1H 472K-T	T	69.6/18.3
C715	4010008360	CER HM60TJ SL 180J 500V		
C751	4030006880	S.CER C1608 JB 1H 472K-T	T	109.1/125
C755	4010008240	CER HM60TJ SL 101J 500V		
C756	4010008210	CER HM60TJ SL 560J 500V		
C757	4010008230	CER HM60TJ SL 820J 500V		
C757	4010008360	CER HM60TJ SL 180J 500V		
C758	4010008210	CER HM60TJ SL 560J 500V		
C759	4010008240	CER HM60TJ SL 101J 500V		
C760	4010008400	CER HM60TJ SL 060D 500V		
C761	4010008310	CER HM60TJ SL 470J 500V		
C763	4030006880	S.CER C1608 JB 1H 472K-T	T	115.6/28.6
C764	4010005650	CER HM60SJ SL 200J 500V		
C765	4010008370	CER HM60TJ SL 150J 500V		
C801	4030006880	S.CER C1608 JB 1H 472K-T	T	168.6/158.6
C804	4010008360	CER HM60TJ SL 180J 500V		
C805	4010008320	CER HM60TJ SL 390J 500V		
C806	4010008310	CER HM60TJ SL 470J 500V		
C807	4010005600	CER HM60SJ SL 090D 500V		
C808	4010008330	CER HM60TJ SL 330J 500V		
C809	4010008320	CER HM60TJ SL 390J 500V		
C810	4010008410	CER HM60TJ SL 030C 500V		
C811	4010005650	CER HM60SJ SL 050C 500V		
C813	4030006880	S.CER C1608 JB 1H 472K-T	T	175.6/26
RL401	6330001471	RLY AJS1311F-K2		
RL402	6330001471	RLY AJS1311F-K2		
RL451	6330001471	RLY AJS1311F-K2		
RL452	6330001471	RLY AJS1311F-K2		
RL501	6330001471	RLY AJS1311F-K2		
RL502	6330001471	RLY AJS1311F-K2		
RL551	6330001471	RLY AJS1311F-K2		
RL552	6330001471	RLY AJS1311F-K2		
RL601	6330001471	RLY AJS1311F-K2		
RL602	6330001471	RLY AJS1311F-K2		
RL651	6330001471	RLY AJS1311F-K2		
RL652	6330001471	RLY AJS1311F-K2		
RL701	6330001471	RLY AJS1311F-K2		
RL702	6330001471	RLY AJS1311F-K2		
RL751	6330001471	RLY AJS1311F-K2		
RL752	6330001471	RLY AJS1311F-K2		
RL801	6330001460	RLY FTR-F1CA012V		
RL802	6330001460	RLY FTR-F1CA012V		
J901	6510017930	CNR 1771P145-20		
J902	6510022031	S.CNR B10B-ZR-SM4-TF (LF) (SN)	T	145.3/165.2
J903	6510019971	S.CNR 52808-1071	T	4/156
J904	6510017930	CNR 1771P145-20		
J905	6510019421	S.CNR B8B-ZR-SM4-TF (LF) (SN)	T	

[DC-DC UNIT]

REF NO.	ORDER NO.	DESCRIPTION	M.	H/V LOCATION
IC201	1180003100	S.REG BD9302FP-E2	T	124.4/52.7
IC401	1180003100	S.REG BD9302FP-E2	T	51.4/52.3
IC601	1180003100	S.REG BD9302FP-E2	T	87.9/52.3
IC801	1180002530	S.REG LM2594M-12	T	160.2/59.4
Q141	1590003310	S.TR DTD113ZK T146	T	28.4/79.8
D141	1750000520	S.DIO DAN222TL	T	26.2/77.8
D201	1750000960	S.DIO RB081L-20	T	122.8/61.3
D301	1750000960	S.DIO RB081L-20	T	124.7/44.2
D401	1750000960	S.DIO RB081L-20	T	49.8/61.9
D501	1750000960	S.DIO RB081L-20	T	53.8/43.6
D601	1750000960	S.DIO RB081L-20	T	86.4/60.8
D801	1710000840	S.DIO 1SR154-400 TE25	T	149.2/41.5
D802	1750001011	S.DIO MBRD835LT4G	T	150.5/57.5
D803	1750000960	S.DIO RB081L-20	T	156.8/67.5
L141	6200001831	S.COL NLV32T-100J	T	30.4/74.4
L201	6200013280	S.COL SFLF10145T-330M1R6-PF	T	118.5/68.1
L211	6200010881	S.COL CDRH124NP-330MC	T	132.7/66.9
L301	6200013280	S.COL SFLF10145T-330M1R6-PF	T	132.2/37.6
L302	6200010901	S.COL CDRH104RNP-100NC	T	116.7/37.5
L401	6200013280	S.COL SFLF10145T-330M1R6-PF	T	45.8/68.9
L411	6200010881	S.COL CDRH124NP-330MC	T	59.6/66.2
L501	6200013280	S.COL SFLF10145T-330M1R6-PF	T	46.2/37
L601	6200013280	S.COL SFLF10145T-330M1R6-PF	T	82.4/67.6
L611	6200010881	S.COL CDRH124NP-330MC	T	96.2/65.9
L801	6190001640	S.COL SFLF12555T-101M1R1-PF	T	159/47.5
L802	6190001191	S.COL D10F-#A814AY-101K	T	166.3/33
L803	6200013280	S.COL SFLF10145T-330M1R6-PF	T	147.2/30.8
R141	7030008190	S.RES ERJ12YJ330U (33)	T	27/73.6
R201	7030003680	S.RES ERJ3GEYJ 104 V (100 k)	T	114.1/59.1
R202	7030003600	S.RES ERJ3GEYJ 223 V (22 k)	T	116.9/59.1
R204	7030003610	S.RES ERJ3GEYJ 273 V (27 k)	T	117.6/57.2
R205	7030005451	S.RES ERA3YED 153V (15 k)	T	118/55.4
R301	7030003670	S.RES ERJ3GEYJ 823 V (82 k)	T	113.4/47.4
R302	7030003530	S.RES ERJ3GEYJ 562 V (5.6 k)	T	116.4/47.4
R303	7030003530	S.RES ERJ3GEYJ 562 V (5.6 k)	T	118.3/46.5
R304	7030003610	S.RES ERJ3GEYJ 273 V (27 k)	T	117.6/48.4
R401	7030003670	S.RES ERJ3GEYJ 823 V (82 k)	T	41.3/58.8
R402	7030003530	S.RES ERJ3GEYJ 562 V (5.6 k)	T	43.3/58.1
R403	7030003530	S.RES ERJ3GEYJ 562 V (5.6 k)	T	44/60
R404	7030003610	S.RES ERJ3GEYJ 273 V (27 k)	T	44.6/57.2
R405	7030005451	S.RES ERA3YED 153V (15 k)	T	45/55
R501	7030003610	S.RES ERJ3GEYJ 273 V (27 k)	T	41.5/46
R502	7030003590	S.RES ERJ3GEYJ 183 V (18 k)	T	44.3/46
R504	7030003610	S.RES ERJ3GEYJ 273 V (27 k)	T	44.9/47.8
R601	7030003680	S.RES ERJ3GEYJ 104 V (100 k)	T	78.1/58.7
R602	7030003600	S.RES ERJ3GEYJ 223 V (22 k)	T	80.8/58.7
R604	7030003610	S.RES ERJ3GEYJ 273 V (27 k)	T	81.3/56.8
R605	7030005451	S.RES ERA3YED 153V (15 k)	T	81.9/54.9
R706	7030003860	S.RES ERJ3GE JPW V	T	81.8/49.6
R801	7030003640	S.RES ERJ3GEYJ 473 V (47 k)	T	155.9/61.4
R802	7030003640	S.RES ERJ3GEYJ 473 V (47 k)	T	158.1/62.8
C8	4030006880	S.CER C1608 JB 1H 472K-T	T	112.7/17.9
C9	4510008700	S.ELE 25 CV 330 BS	T	111.6/11.9
C141	4030011600	S.CER C1608 JB 1E 104K-T	T	30.7/79.6
C201	4030011280	S.CER C1608 CH 1H 271J-T	T	114.1/57.9
C202	4030006860	S.CER C1608 JB 1H 102K-T	T	116.1/57.2
C203	4030011600	S.CER C1608 JB 1E 104K-T	T	118/54.2
C204	4030011600	S.CER C1608 JB 1E 104K-T	T	129.8/57.3
C205	4030018970	S.CER C3225 JB 1C 226MT-N	T	114.9/61.3
C206	4030007130	S.CER C1608 CH 1H 101J-T	T	118.9/57.4
C207	4030018970	S.CER C3225 JB 1C 226MT-N	T	114.4/54
C211	4030011600	S.CER C1608 JB 1E 104K-T	T	129.9/54.5
C212	4550007140	S.TAN TEESVD 1C 107M12R	T	134.1/49.5
C213	4030018970	S.CER C3225 JB 1C 226MT-N	T	133.1/56.6
C214	4030011600	S.CER C1608 JB 1E 104K-T	T	137.3/74.4
C301	4030011280	S.CER C1608 CH 1H 271J-T	T	114.7/47.4
C302	4030006860	S.CER C1608 JB 1H 102K-T	T	115.5/49.4
C303	4030011600	S.CER C1608 JB 1E 104K-T	T	118.5/50.3
C304	4030011600	S.CER C1608 JB 1E 104K-T	T	129.6/48.1
C305	4030018970	S.CER C3225 JB 1C 226MT-N	T	125.3/39.7
C306	4030007130	S.CER C1608 CH 1H 101J-T	T	119/48.4
C307	4030018970	S.CER C3225 JB 1C 226MT-N	T	116.3/44.4
C308	4030011600	S.CER C1608 JB 1E 104K-T	T	106.9/36.2
C401	4030011280	S.CER C1608 CH 1H 271J-T	T	41.3/60
C402	4030006860	S.CER C1608 JB 1H 102K-T	T	41.9/56.9
C403	4030011600	S.CER C1608 JB 1E 104K-T	T	45/53.8
C404	4030011600	S.CER C1608 JB 1E 104K-T	T	56.8/56.6
C405	4030018970	S.CER C3225 JB 1C 226MT-N	T	41.9/62.1
C406	4030007130	S.CER C1608 CH 1H 101J-T	T	46/57.2
C408	4030011600	S.CER C1608 JB 1E 104K-T	T	34.6/60
C411	4030011600	S.CER C1608 JB 1E 104K-T	T	56.8/53.8
C412	4550007140	S.TAN TEESVD 1C 107M12R	T	61/45.3
C413	4030018970	S.CER C3225 JB 1C 226MT-N	T	59.6/54.3
C501	4030011280	S.CER C1608 CH 1H 271J-T	T	41.5/47.3
C502	4030006860	S.CER C1608 JB 1H 102K-T	T	43.5/47.8
C503	4030011600	S.CER C1608 JB 1E 104K-T	T	45.3/49.8
C504	4030011600	S.CER C1608 JB 1E 104K-T	T	56.7/47.6
C505	4030018970	S.CER C3225 JB 1C 226MT-N	T	43.6/43.8
C506	4030007130	S.CER C1608 CH 1H 101J-T	T	46.1/47.8
C508	4030011600	S.CER C1608 JB 1E 104K-T	T	35.4/47.1
C601	4030011280	S.CER C1608 CH 1H 271J-T	T	78.1/57.4
C602	4030006860	S.CER C1608 JB 1H 102K-T	T	80.1/56.8
C603	4030011600	S.CER C1608 JB 1E 104K-T	T	82.2/52.9
C604	4030011600	S.CER C1608 JB 1E 104K-T	T	93.2/56.6

[DC-DC UNIT]

REF NO.	ORDER NO.	DESCRIPTION	M.	H/V LOCATION
C605	4030018970	S.CER C3225 JB 1C 226MT-N	T	78.9/60.8
C606	4030007130	S.CER C1608 CH 1H 101J-T	T	82.5/56.8
C607	4030018970	S.CER C3225 JB 1C 226MT-N	T	77.3/55.3
C608	4030018970	S.CER C3225 JB 1C 226MT-N	T	79/52.3
C611	4030011600	S.CER C1608 JB 1E 104K-T	T	93.2/54
C612	4550007140	S.TAN TEESVD 1C 107M12R	T	97.7/45.3
C613	4030018970	S.CER C3225 JB 1C 226MT-N	T	95.9/54.4
C801	4510008910	S.ELE EEEFC1C101P	T	148.1/48.1
C802	4030011600	S.CER C1608 JB 1E 104K-T	T	160.7/62.8
C803	4510008940	S.ELE EEEFC1V470P	T	147.6/66.3
C805	4030018970	S.CER C3225 JB 1C 226MT-N	T	150/23.5
RL142	6330001760	RLY AW3023		
J1	6510022801	S.CNR B10B-PH-SM4-TB (LF) (SN)	T	24.5/23.9
J2	6510020251	S.CNR B9B-PH-SM4-TB (LF) (SN)	T	24.5/54.1
J3	6510018941	S.CNR B13B-PH-SM4-TB (LF) (SN)	T	60.2/24.5
J5	6510018951	S.CNR B7B-PH-SM4-TB (LF) (SN)	T	55.9/10.2
J6	6510023261	S.CNR B6B-PH-SM4-TB (LF) (SN)	T	80.3/10.2
J7	6510018921	S.CNR B8B-PH-SM4-TB (LF) (SN)	T	91/24.5
J8	6510018971	S.CNR B4B-PH-SM4-TB (LF) (SN)	T	112.9/24.5
W1	9030090150	WIR OPC-1803		
EP201	6910014730	S.BEA MPZ2012S331A-T	T	112/57.1
EP211	6910014730	S.BEA MPZ2012S331A-T	T	128.3/74.2
EP301	6910014730	S.BEA MPZ2012S331A-T	T	124.8/33.2
EP302	6910014730	S.BEA MPZ2012S331A-T	T	103.6/28.4
EP401	6910014730	S.BEA MPZ2012S331A-T	T	38.9/60.3
EP402	6910014730	S.BEA MPZ2012S331A-T	T	33.4/57.6
EP501	6910014730	S.BEA MPZ2012S331A-T	T	40/48.8
EP502	6910014730	S.BEA MPZ2012S331A-T	T	34.3/49.3
EP601	6910014730	S.BEA MPZ2012S331A-T	T	75.7/58.3
EP602	6910014730	S.BEA MPZ2012S331A-T	T	75.7/52.2

[TUNER UNIT]

REF NO.	ORDER NO.	DESCRIPTION	M.	H/V LOCATION
MF1	2710000780	MTR MP24Z (STEPPING MOTOR		
MF2	2710000780	MTR MP24Z (STEPPING MOTOR		
MF3	2710000470	FAN MF60B-12H901		
W1	8900012901	CBL OPC-1345R		
W2	8900012901	CBL OPC-1345R		
W3	8900017140	CBL OPC-927A (P1,N24,L100)		
W51	8600037090	CBL SX2590 P51*P52*P53TU		

M.=Mounted side (T: Mounted on the Top side B: Mounted on the Bottom side)
S.=Surface mount

[CTRL BOARD]

REF NO.	ORDER NO.	DESCRIPTION	M.	H/V LOCATION
IC1	1140004120	S.IC M38022M2-138FP	T	65.7/81.8
IC2	1130010390	S.IC HN58X2416TI	T	54/86.9
IC3	1130003921	S.IC TC4S69F (TE85R,F)	T	62/59.5
IC4	1180001071	S.IC TA7805F (TE16L,Q)	B	71.5/47.5
IC5	1130009691	S.IC TC74HCT7007AF (F)	B	92.5/91.6
IC6	1130006441	S.IC TC7S08F (TE85R,F)	T	81.7/70.3
IC51	1130011530	S.IC CD74HC4094M96	T	42.2/72.4
IC52	1130007690	S.IC BU4066BFC-E2	B	12.5/76.9
IC55	1130011530	S.IC CD74HC4094M96	B	100.2/76.1
IC56	1130011530	S.IC CD74HC4094M96	B	114.3/76.1
IC57	1160000131	S.IC TD62783AFG (S,EL)	T	99.6/73.1
IC58	1160000131	S.IC TD62783AFG (S,EL)	T	113.7/73.1
IC101	1110000960	S.IC NJM4558M-TE1-#FMZB	T	18.3/47.8
IC151	1120002301	S.IC TC74AC04F (F)	T	32.8/53.1
IC153	1130012011	S.IC TC7S232F (TE85L,F)	B	27.8/48.6
IC154	1130012011	S.IC TC7S232F (TE85L,F)	T	40.4/48.6
IC155	1130012011	S.IC TC7S232F (TE85L,F)	T	34.2/51.9
IC156	1130012021	S.IC TC74ACT112F (EL,F)	T	35.4/58.9
IC201	1110000960	S.IC NJM4558M-TE1-#FMZB	B	61.3/58.2
IC301	1110002690	S.IC NJM2903M-TE1-#FMZB	T	80/59
IC401	1160000131	S.IC TD62783AFG (S,EL)	T	13.6/86.1
IC402	1160000131	S.IC TD62783AFG (S,EL)	T	31.6/84.7
IC403	1160000131	S.IC TD62783AFG (S,EL)	B	24.7/88
Q1	1590001330	S.TR DTA114EUA T106	T	78.5/75.2
Q2	1590000680	S.TR DTC114EUA T106	T	77.8/71.2
Q3	1590000680	S.TR DTC114EUA T106	T	128.4/74.5
Q4	1590000680	S.TR DTC114EUA T106	T	128.4/77
Q5	1590000680	S.TR DTC114EUA T106	T	128.4/81.3
Q6	1590000680	S.TR DTC114EUA T106	T	128.4/83.8
Q7	1590000680	S.TR DTC114EUA T106	T	128.4/88.5
Q8	1590000680	S.TR DTC114EUA T106	T	128.4/91
Q9	1590000680	S.TR DTC114EUA T106	T	128.4/95.7
Q10	1590000680	S.TR DTC114EUA T106	T	128.4/100.5
Q11	1590000680	S.TR DTC114EUA T106	B	85.7/99.8
Q51	1590000680	S.TR DTC114EUA T106	B	6.1/78.6
Q52	1590000680	S.TR DTC114EUA T106	T	12.5/78.6
Q53	1590000680	S.TR DTC114EUA T106	B	6.6/72.8
Q54	1560001260	S.FET 2SK3018 T106	B	121.8/80.4
Q55	1590000680	S.TR DTC114EUA T106	B	130.2/68.9
Q59	1590000680	S.TR DTC114EUA T106	T	56.8/69.5
Q151	1590000680	S.TR DTC114EUA T106	B	39.8/42.3
Q152	1590000680	S.TR DTC114EUA T106	B	39.8/39.5
Q153	1590001330	S.TR DTA114EUA T106	B	39.8/45.1
Q201	1560000871	S.FET 2SK515-T1B-A (X33)	B	50.4/51.8
Q252	1520000561	S.TR 2SB1123 T-TD-E	T	18.8/6.7
Q253	1540000441	S.TR 2SD1619T-TD-E	B	26.6/6.7
Q254	1590000680	S.TR DTC114EUA T106	T	24.9/5.4
Q255	1590002420	S.TR UMD3N TR	T	97.4/12.1
Q256	1590000680	S.TR DTC114EUA T106	T	101.4/12.4
D1	1730000411	S.ZEN RD5.1M-T2B-A B2	T	69.8/58.7
D2	1710000780	S.DIO MA114 (TX)	T	73.8/58.7
D3	1750000201	S.DIO 1SS319 (TE85R,F)	B	129.5/98.1
D4	1750000201	S.DIO 1SS319 (TE85R,F)	B	129.5/90
D5	1750000201	S.DIO 1SS319 (TE85R,F)	B	129.5/82.8
D6	1750000201	S.DIO 1SS319 (TE85R,F)	B	129.5/76
D7	1730000031	S.ZEN RD5.6M-T2B-A B2	T	69.8/55.3
D101	1790000491	S.DIO HSM88ASTR-E	B	16.5/37.1
D102	1790000491	S.DIO HSM88ASTR-E	B	20.5/37.1
D103	1750000201	S.DIO 1SS319 (TE85R,F)	B	18.5/57
D151	1790000491	S.DIO HSM88ASTR-E	B	33.5/45.3
D152	1790000491	S.DIO HSM88ASTR-E	T	37/44.2
D153	1790000491	S.DIO HSM88ASTR-E	B	27.6/61.1
D154	1790000491	S.DIO HSM88ASTR-E	B	39.4/61.1
D201	1790000491	S.DIO HSM88ASTR-E	B	50.3/45.6
D202	1790000491	S.DIO HSM88ASTR-E	T	44.9/45.5
D203	1750000201	S.DIO 1SS319 (TE85R,F)	B	54.5/58.2
D301	1790000491	S.DIO HSM88ASTR-E	B	82.8/52.5
D302	1790000491	S.DIO HSM88ASTR-E	B	89.2/58
D303	1710000140	DIO U05G		
D304	1750000271	S.DIO 1SS301 (TE85L,F)	T	94.6/12.3
X1	6050009890	S.XTL CR-569 (6.144 MHz)	T	83.2/79.5
L1	6200003261	S.COL NLV32T-101J	T	51.1/76.5
L2	6200003261	S.COL NLV32T-101J	T	54.5/77.8
L5	6200005131	S.COL NLC453232T-101K-PF	T	121.6/100.3
L51	6200003261	S.COL NLV32T-101J	T	106.3/86.9
L52	6200005131	S.COL NLC453232T-101K-PF	T	114.9/88.1
L101	6140004410	COL LR-502		
L102	6200001831	S.COL NLV32T-100J	T	26.7/56.3
L103	6200003261	S.COL NLV32T-101J	T	14/56.3
L104	6200005190	S.COL MLF1608D R56K 0.56U	T	19.5/40.5
L151	6140004410	COL LR-502		
L152	6200001831	S.COL NLV32T-100J	T	43.1/62.7
L201	6140004410	COL LR-502		
L202	6180003300	COL T6-222J (2.2M)		
L301	6140004410	COL LR-502		
L302	6200003261	S.COL NLV32T-101J	B	76.9/60.8
L403	6140004670	COL LR-527 (CH160808TR271)		
L404	6140004670	COL LR-527 (CH160808TR271)		
R2	7030003680	S.RES ERJ3GEYJ 104 V (100 k)	T	63/71
R3	7030003680	S.RES ERJ3GEYJ 104 V (100 k)	T	64.3/71
R4	7030003680	S.RES ERJ3GEYJ 104 V (100 k)	T	65.6/71
R5	7030003680	S.RES ERJ3GEYJ 104 V (100 k)	T	66.9/71
R6	7030003560	S.RES ERJ3GEYJ 103 V (10 k)	T	74.7/71
R7	7030003440	S.RES ERJ3GEYJ 102 V (1 k)	T	73.4/71
R8	7030003680	S.RES ERJ3GEYJ 104 V (100 k)	T	55.4/72.8
R9	7030003680	S.RES ERJ3GEYJ 104 V (100 k)	T	54.7/74.7
R10	7030003680	S.RES ERJ3GEYJ 104 V (100 k)	T	57.3/72.9
R11	7030003680	S.RES ERJ3GEYJ 104 V (100 k)	T	53.4/74.7
R12	7030003440	S.RES ERJ3GEYJ 102 V (1 k)	T	78.3/83.9
R13	7030003680	S.RES ERJ3GEYJ 104 V (100 k)	T	76.6/75.6
R14	7030003680	S.RES ERJ3GEYJ 104 V (100 k)	T	78.5/78.2
R15	7030003440	S.RES ERJ3GEYJ 102 V (1 k)	T	61.7/62
R16	7030003320	S.RES ERJ3GEYJ 101 V (100)	T	62.2/55.8
R17	7030003560	S.RES ERJ3GEYJ 103 V (10 k)	T	54.1/82.2
R18	7030003560	S.RES ERJ3GEYJ 103 V (10 k)	T	54.1/80.9
R19	7030003680	S.RES ERJ3GEYJ 104 V (100 k)	T	64.7/59
R20	7030003570	S.RES ERJ3GEYJ 123 V (12 k)	T	67.7/61.1
R21	7030003650	S.RES ERJ3GEYJ 563 V (56 k)	T	66/59
R22	7030003450	S.RES ERJ3GEYJ 122 V (1.2 k)	T	73.3/61.1
R23	7030003400	S.RES ERJ3GEYJ 471 V (470)	B	105.1/100
R24	7030003440	S.RES ERJ3GEYJ 102 V (1 k)	B	102.9/98.8
R25	7030003380	S.RES ERJ3GEYJ 331 V (330)	B	126/99.1
R26	7030003380	S.RES ERJ3GEYJ 331 V (330)	B	126/97.1
R27	7030003380	S.RES ERJ3GEYJ 331 V (330)	B	126/91
R28	7030003380	S.RES ERJ3GEYJ 331 V (330)	B	126/89
R29	7030003380	S.RES ERJ3GEYJ 331 V (330)	B	126/83.8
R30	7030003380	S.RES ERJ3GEYJ 331 V (330)	B	126/81.8
R31	7030003380	S.RES ERJ3GEYJ 331 V (330)	B	126/77
R32	7030003380	S.RES ERJ3GEYJ 331 V (330)	B	126/75
R40	7030003440	S.RES ERJ3GEYJ 102 V (1 k)	T	61.2/99.9
R42	7030003860	S.RES ERJ3GE JPW V	T	60.4/71
R43	7030003860	S.RES ERJ3GE JPW V	T	60.7/69
R44	7030003860	S.RES ERJ3GE JPW V	T	68.2/71
R45	7030003860	S.RES ERJ3GE JPW V	T	65.7/68.5
R46	7030003860	S.RES ERJ3GE JPW V	T	70.6/68.9
R51	7030003440	S.RES ERJ3GEYJ 102 V (1 k)	T	35.5/77.3
R52	7030003440	S.RES ERJ3GEYJ 102 V (1 k)	T	34.2/77.3
R53	7030003860	S.RES ERJ3GE JPW V	T	32.9/77.3
R54	7030003860	S.RES ERJ3GE JPW V	T	31.6/77.3
R55	7030003860	S.RES ERJ3GE JPW V	B	29.6/80.1
R56	7030003860	S.RES ERJ3GE JPW V	B	28/80.1
R57	7030003860	S.RES ERJ3GE JPW V	B	26.4/80.1
R58	7030003860	S.RES ERJ3GE JPW V	B	24.8/80.1
R59	7030003860	S.RES ERJ3GE JPW V	T	18.3/78.7
R60	7030003860	S.RES ERJ3GE JPW V	T	17/76
R61	7030003860	S.RES ERJ3GE JPW V	T	15.7/76
R62	7030003860	S.RES ERJ3GE JPW V	T	14.4/78.7
R63	7030003860	S.RES ERJ3GE JPW V	T	10.6/78.7
R64	7030003860	S.RES ERJ3GE JPW V	T	9.3/74.8
R65	7030003860	S.RES ERJ3GE JPW V	T	8/74.8
R66	7030003520	S.RES ERJ3GEYJ 472 V (4.7 k)	B	15.6/81.6
R67	7030003200	S.RES ERJ3GEYJ 100 V (10)	T	99.8/90.4
R68	7030003200	S.RES ERJ3GEYJ 100 V (10)	T	98.5/90.4
R69	7030003200	S.RES ERJ3GEYJ 100 V (10)	T	97.2/90.4
R70	7030004040	S.RES ERJ3GEYJ 4R7 V (4.7)	T	104.8/65.9
R71	7030004040	S.RES ERJ3GEYJ 4R7 V (4.7)	T	103.5/65.9
R72	7030004040	S.RES ERJ3GEYJ 4R7 V (4.7)	T	102.2/65.9
R73	7030004040	S.RES ERJ3GEYJ 4R7 V (4.7)	T	100.9/65.9
R74	7030004040	S.RES ERJ3GEYJ 4R7 V (4.7)	T	99.6/65.9
R75	7030004040	S.RES ERJ3GEYJ 4R7 V (4.7)	T	98.3/65.9
R76	7030004040	S.RES ERJ3GEYJ 4R7 V (4.7)	T	97/65.9
R77	7030004040	S.RES ERJ3GEYJ 4R7 V (4.7)	T	95.7/65.9
R78	7030004040	S.RES ERJ3GEYJ 4R7 V (4.7)	B	120.1/64.6
R84	7030003240	S.RES ERJ3GEYJ 220 V (22)	B	110.5/64.6
R85	7030003240	S.RES ERJ3GEYJ 220 V (22)	B	108.9/64.6
R86	7030003560	S.RES ERJ3GEYJ 103 V (10 k)	B	116.1/83.6
R87	7030003440	S.RES ERJ3GEYJ 102 V (1 k)	T	71.8/94.4
R88	7030003440	S.RES ERJ3GEYJ 102 V (1 k)	T	75.7/88.1
R89	7030003440	S.RES ERJ3GEYJ 102 V (1 k)	T	73.3/94.4
R90	7030003440	S.RES ERJ3GEYJ 102 V (1 k)	T	77.2/88.1
R91	7030003440	S.RES ERJ3GEYJ 102 V (1 k)	T	74.8/94.4
R92	7030003440	S.RES ERJ3GEYJ 102 V (1 k)	T	78.7/88.1
R93	7030003440	S.RES ERJ3GEYJ 102 V (1 k)	T	76.3/94.4
R95	7030003860	S.RES ERJ3GE JPW V	T	15.7/78.7
R97	7030003860	S.RES ERJ3GE JPW V	T	8/78.7
R101	7030010950	S.RES ERJ1TYJ 100U (10)	T	16.4/39.4
R102	7030010950	S.RES ERJ1TYJ 100U (10)	T	20.2/39.4
R103	7030003560	S.RES ERJ3GEYJ 103 V (10 k)	B	16.7/42.9
R104	7030003510	S.RES ERJ3GEYJ 392 V (3.9 k)	B	20.3/42.9
R105	7030003720	S.RES ERJ3GEYJ 224 V (220 k)	B	15.1/44.5
R106	7030003720	S.RES ERJ3GEYJ 224 V (220 k)	B	21.9/44.5
R107	7030003660	S.RES ERJ3GEYJ 683 V (68 k)	T	12.4/45.8
R108	7030003660	S.RES ERJ3GEYJ 683 V (68 k)	T	24.1/45.8
R109	7030003720	S.RES ERJ3GEYJ 224 V (220 k)	T	12.4/47.1
R110	7030003720	S.RES ERJ3GEYJ 224 V (220 k)	T	24.1/47.1
R111	7030003440	S.RES ERJ3GEYJ 275V (2.7 M)	T	12.4/48.4
R112	7030003810	S.RES ERJ3GEYJ 125 V (1.2 M)	T	24.1/48.4
R113	7030003440	S.RES ERJ3GEYJ 102 V (1 k)	B	14.5/51.4
R114	7030003440	S.RES ERJ3GEYJ 102 V (1 k)	B	22.4/51.4
R115	7030009340	S.RES ERJ3GEYJ 275V (2.7 M)	T	12.4/49.7
R118	7030003860	S.RES ERJ3GE JPW V	B	17.5/40.5
R131	7030003440	S.RES ERJ3GEYJ 102 V (1 k)	B	73.1/81
R132	7030003440	S.RES ERJ3GEYJ 102 V (1 k)	B	70.1/81.9
R133	7030003440	S.RES ERJ3GEYJ 102 V (1 k)	B	73.2/82.8
R134	7030003440	S.RES ERJ3GEYJ 102 V (1 k)	B	70.1/83.7
R135	7030003440	S.RES ERJ3GEYJ 102 V (1 k)	B	73.2/84.6
R136	7030003440	S.RES ERJ3GEYJ 102 V (1 k)	B	70.1/85.5
R137	7030003440	S.RES ERJ3GEYJ 102 V (1 k)	B	73.1/86.4
R138	7030003440	S.RES ERJ3GEYJ 102 V (1 k)	B	70.1/87.5
R139	7030003440	S.RES ERJ3GEYJ 102 V (1 k)	T	63.8/94.4
R140	7030003440	S.RES ERJ3GEYJ 102 V (1 k)	T	65.1/94.4
R141	70300			

[CTRL BOARD]

REF NO.	ORDER NO.	DESCRIPTION	M.	H/V LOCATION
R153	7030007190	S.RES ERJ12YJ220U (22)	T	32.8/41.4
R154	7030010620	S.RES ERJ12YJ180U (18)	B	33.2/41.4
R155	7030003320	S.RES ERJ3GEYJ 101 V (100)	T	33.9/45.5
R157	7030003320	S.RES ERJ3GEYJ 101 V (100)	B	27.9/47.4
R158	7030003560	S.RES ERJ3GEYJ 103 V (10 k)	B	27.1/49.8
R159	7030003560	S.RES ERJ3GEYJ 103 V (10 k)	B	38.5/51.2
R160	7030003280	S.RES ERJ3GEYJ 470 V (47)	B	27.1/52.9
R161	7030003280	S.RES ERJ3GEYJ 470 V (47)	B	38.5/54.3
R162	7030003440	S.RES ERJ3GEYJ 102 V (1 k)	B	25.5/56
R163	7030003440	S.RES ERJ3GEYJ 102 V (1 k)	B	40.1/54.3
R164	7030003280	S.RES ERJ3GEYJ 470 V (47)	T	30.5/48.6
R165	7030003280	S.RES ERJ3GEYJ 470 V (47)	T	37.9/48.6
R166	7030003440	S.RES ERJ3GEYJ 102 V (1 k)	T	31.8/48.6
R167	7030003440	S.RES ERJ3GEYJ 102 V (1 k)	T	36.6/48.6
R168	7030003280	S.RES ERJ3GEYJ 470 V (47)	T	37.3/53
R169	7030003440	S.RES ERJ3GEYJ 102 V (1 k)	T	37.3/51.7
R170	7030003280	S.RES ERJ3GEYJ 470 V (47)	B	31.9/60.8
R171	7030003280	S.RES ERJ3GEYJ 470 V (47)	B	33.5/60.8
R172	7030003480	S.RES ERJ3GEYJ 222 V (2.2 k)	B	36.7/60.8
R173	7030003500	S.RES ERJ3GEYJ 332 V (3.3 k)	B	30.3/63.9
R174	7030003360	S.RES ERJ3GEYJ 221 V (220)	B	44.2/61.6
R201	7030010420	S.RES ERJ1TYJ 560U (56)	T	47.3/37.5
R202	7030010420	S.RES ERJ1TYJ 560U (56)	B	47.9/37.2
R203	7030010420	S.RES ERJ1TYJ 560U (56)	T	47.3/41.5
R204	7030010420	S.RES ERJ1TYJ 560U (56)	B	47.9/41.8
R205	7030003560	S.RES ERJ3GEYJ 103 V (10 k)	T	47.8/49.1
R206	7030003560	S.RES ERJ3GEYJ 103 V (10 k)	B	51.5/48.4
R207	7030003800	S.RES ERJ3GEYJ 105 V (1 M)	T	50.2/49.1
R208	7030003560	S.RES ERJ3GEYJ 103 V (10 k)	B	53.1/51.5
R209	7030003520	S.RES ERJ3GEYJ 472 V (4.7 k)	B	54.8/48.1
R210	7030003360	S.RES 220 ERJ3GE	B	55.5/50.6
R211	7030003480	S.RES ERJ3GEYJ 222 V (2.2 k)	B	60.7/67.4
R212	7030003560	S.RES ERJ3GEYJ 103 V (10 k)	B	59.1/49
R213	7030005331	S.RES ERA3YED 562V (5.6 k)	B	63.8/64.2
R214	7030005331	S.RES ERA3YED 562V (5.6 k)	B	62.2/64.2
R215	7030005871	S.RES ERA3YKD 104V (100 k)	B	59.8/65
R216	7030005331	S.RES ERA3YED 562V (5.6 k)	B	62.2/52.3
R216	7030008121	S.RES ERA3YED 682V (6.8 k)	B	62.2/52.3
R217	7030008121	S.RES ERA3YED 682V (6.8 k)	B	63.8/52
R218	7030005871	S.RES ERA3YKD 104V (100 k)	B	59.8/51.4
R221	7030003670	S.RES ERJ3GEYJ 823 V (82 k)	B	57.4/58.2
R222	7030003680	S.RES ERJ3GEYJ 104 V (100 k)	B	65.4/52.7
R223	7030003820	S.RES ERJ3GEYJ 155 V (1.5 M)	B	59.8/63.4
R224	7030003820	S.RES ERJ3GEYJ 155 V (1.5 M)	B	59.8/53
R225	7030003560	S.RES ERJ3GEYJ 103 V (10 k)	B	57.6/61.9
R226	7030003560	S.RES ERJ3GEYJ 103 V (10 k)	B	57.6/54.5
R227	7030003560	S.RES ERJ3GEYJ 103 V (10 k)	B	54.4/61.7
R228	7030003560	S.RES ERJ3GEYJ 103 V (10 k)	B	52.8/61.7
R251	7540000100	ABS SRYH-350L		
R301	7030003560	S.RES ERJ3GEYJ 103 V (10 k)	B	82.8/49.8
R302	7030003670	S.RES ERJ3GEYJ 823 V (82 k)	B	83.4/55.9
R302	7030003680	S.RES ERJ3GEYJ 104 V (100 k)	B	83.4/55.9
R303	7030010910	S.RES ERJ1TYJ 150U (15)	B	95.9/60.6
R304	7030003670	S.RES ERJ3GEYJ 823 V (82 k)	B	84.1/59.9
R305	7030003720	S.RES ERJ3GEYJ 224 V (220 k)	B	81.7/57.8
R306	7030003660	S.RES ERJ3GEYJ 683 V (68 k)	T	85.2/60.5
R307	7030003660	S.RES ERJ3GEYJ 683 V (68 k)	B	80.1/55.1
R308	7030003840	S.RES ERJ3GEYJ 225 V (2.2 M)	T	81.6/55.1
R309	7030003720	S.RES ERJ3GEYJ 224 V (220 k)	T	88.6/59.8
R310	7030003840	S.RES ERJ3GEYJ 225 V (2.2 M)	T	87.8/57.7
R311	7030003440	S.RES ERJ3GEYJ 102 V (1 k)	T	85.2/57.7
R311	7030003560	S.RES ERJ3GEYJ 103 V (10 k)	T	85.2/57.7
R312	7030003560	S.RES ERJ3GEYJ 103 V (10 k)	T	86.5/57.7
R312	7030003680	S.RES ERJ3GEYJ 104 V (100 k)	T	86.5/57.7
R313	7030003700	S.RES ERJ3GEYJ 154 V (150 k)	T	81.7/55.1
R345	7030003560	S.RES ERJ3GEYJ 103 V (10 k)	T	88.3/82.8
R346	7030003630	S.RES ERJ3GEYJ 393 V (39 k)	B	105.1/96.5
R351	7030003440	S.RES ERJ3GEYJ 102 V (1 k)	B	103.2/9.9
R401	7030003240	S.RES ERJ3GEYJ 220 V (22)	T	17.5/93.4
R402	7030003240	S.RES ERJ3GEYJ 220 V (22)	T	16.2/93.4
R403	7030003240	S.RES ERJ3GEYJ 220 V (22)	T	14.9/93.4
R404	7030003240	S.RES ERJ3GEYJ 220 V (22)	T	13.6/93.4
R405	7030003240	S.RES ERJ3GEYJ 220 V (22)	T	12.3/93.4
R406	7030003240	S.RES ERJ3GEYJ 220 V (22)	T	11/93.4
R407	7030003240	S.RES ERJ3GEYJ 220 V (22)	T	9.7/93.4
R408	7030003240	S.RES ERJ3GEYJ 220 V (22)	T	8.4/93.4
R409	7030003240	S.RES ERJ3GEYJ 220 V (22)	B	36.6/86.7
R410	7030003240	S.RES ERJ3GEYJ 220 V (22)	B	35.1/86.7
R411	7030003240	S.RES ERJ3GEYJ 220 V (22)	B	33.6/86.7
R412	7030003240	S.RES ERJ3GEYJ 220 V (22)	B	32/86.7
R413	7030003240	S.RES ERJ3GEYJ 220 V (22)	B	33.2/93
R414	7030003240	S.RES ERJ3GEYJ 220 V (22)	B	36.9/92.2
R415	7030003240	S.RES ERJ3GEYJ 220 V (22)	B	33.2/91.3
R416	7030003240	S.RES ERJ3GEYJ 220 V (22)	B	36.8/90.5
R417	7030003480	S.RES ERJ3GEYJ 222 V (2.2 k)	B	30.8/98.5
R418	7030003480	S.RES ERJ3GEYJ 222 V (2.2 k)	B	46.4/98.5
R419	7030003480	S.RES ERJ3GEYJ 222 V (2.2 k)	B	32.4/98.5
R420	7030003480	S.RES ERJ3GEYJ 222 V (2.2 k)	B	48/98.5
R421	7030003480	S.RES ERJ3GEYJ 222 V (2.2 k)	B	34/98.5
R422	7030003480	S.RES ERJ3GEYJ 222 V (2.2 k)	B	49.6/98.5
R423	7030003480	S.RES ERJ3GEYJ 222 V (2.2 k)	B	35.6/98.5
R424	7030003480	S.RES ERJ3GEYJ 222 V (2.2 k)	B	51.2/98.5
R425	7030003480	S.RES ERJ3GEYJ 222 V (2.2 k)	B	37.2/98.5
R426	7030003480	S.RES ERJ3GEYJ 222 V (2.2 k)	B	52.8/98.5
R427	7030003480	S.RES ERJ3GEYJ 222 V (2.2 k)	B	38.8/98.5
R428	7030003480	S.RES ERJ3GEYJ 222 V (2.2 k)	B	54.4/98.5
R429	7030003480	S.RES ERJ3GEYJ 222 V (2.2 k)	B	40.4/98.5
R430	7030003480	S.RES ERJ3GEYJ 222 V (2.2 k)	B	56/98.5
R431	7030003480	S.RES ERJ3GEYJ 222 V (2.2 k)	B	42/98.5
R432	7030003480	S.RES ERJ3GEYJ 222 V (2.2 k)	B	57.6/98.5
R433	7030003720	S.RES ERJ3GEYJ 224 V (220 k)	B	46.5/7.9
R434	7030010580	S.RES ERJ1TYJ 1R5U (1.5)	T	31/4.6
R434	7030011130	S.RES ERJ1TYJ 1R0U (1)	T	31/4.6
R435	7030010580	S.RES ERJ1TYJ 1R5U (1.5)	T	31/8.8

[CTRL BOARD]

REF NO.	ORDER NO.	DESCRIPTION	M.	H/V LOCATION
R435	7030011130	S.RES ERJ1TYJ 1R0U (1)	T	31/8.8
R436	7030010580	S.RES ERJ1TYJ 1R5U (1.5)	B	38.8/8.8
R436	7030011130	S.RES ERJ1TYJ 1R0U (1)	B	38.8/8.8
R437	7030010580	S.RES ERJ1TYJ 1R5U (1.5)	B	38.8/4.6
R437	7030011130	S.RES ERJ1TYJ 1R0U (1)	B	38.8/4.6
R438	7030003640	S.RES ERJ3GEYJ 473 V (47 k)	T	22.7/8.3
R439	7030003340	S.RES ERJ3GEYJ 151 V (150)	T	22.7/5.2
R439	7030003400	S.RES ERJ3GEYJ 471 V (470)	T	22.7/5.2
R440	7030003400	S.RES ERJ3GEYJ 471 V (470)	B	30.5/8.3
R440	7030003440	S.RES ERJ3GEYJ 102 V (1 k)	B	30.5/8.3
R441	7030003560	S.RES ERJ3GEYJ 103 V (10 k)	B	30.5/5.2
R442	7030003640	S.RES ERJ3GEYJ 473 V (47 k)	B	32.1/8.3
R443	7030003640	S.RES ERJ3GEYJ 473 V (47 k)	T	99.5/13.5
C1	4510008540	S.ELE EEE1CA100SR	T	42.6/80.3
C2	4030011600	S.CER C1608 JB 1E 104K-T	T	45.8/82.3
C3	4030006880	S.CER C1608 JB 1H 472K-T	B	83.5/100
C4	4030006900	S.CER C1608 JB 1H 103K-T	T	56/74.7
C5	4030006900	S.CER C1608 JB 1H 103K-T	T	58.6/79.2
C7	4030017810	S.CER C1608 CH 1H 102J-T	T	75.3/76.6
C8	4030011600	S.CER C1608 JB 1E 104K-T	T	56/81.3
C9	4030009990	S.CER C1608 CH 1H 200J-T	T	75.3/80.5
C10	4030011600	S.CER C1608 JB 1E 104K-T	T	51.7/79.8
C11	4030006880	S.CER C1608 JB 1H 472K-T	T	76.6/78.2
C12	4030009990	S.CER C1608 CH 1H 200J-T	T	76.6/81.5
C13	4510008750	S.ELE EEE1AA471UP	T	48.6/56.7
C14	4030011600	S.CER C1608 JB 1E 104K-T	T	67.4/56.2
C15	4030011600	S.CER C1608 JB 1E 104K-T	T	72.9/56.3
C16	4510008500	S.ELE EEE1CA101WP	T	75.3/50.5
C17	4510008550	S.ELE EEE1HA010SR	T	133.3/100.5
C18	4510008550	S.ELE EEE1HA010SR	T	133.3/95.7
C19	4510008550	S.ELE EEE1HA010SR	T	138.4/91.9
C20	4510008550	S.ELE EEE1HA010SR	T	133.3/89.7
C21	4510008550	S.ELE EEE1HA010SR	T	138.4/85.3
C22	4510008550	S.ELE EEE1HA010SR	T	133.3/83.1
C23	4510008550	S.ELE EEE1HA010SR	T	138.4/78.6
C24	4510008550	S.ELE EEE1HA010SR	T	133.3/76.5
C25	4030011600	S.CER C1608 JB 1E 104K-T	T	62.2/57.1
C26	4030006880	S.CER C1608 JB 1H 472K-T	T	67.4/59
C40	4030011600	S.CER C1608 JB 1E 104K-T	T	84/70.6
C41	4030011600	S.CER C1608 JB 1E 104K-T	T	78.5/73.2
C43	4030006880	S.CER C1608 JB 1H 472K-T	B	85.7/97.3
C45	4030011600	S.CER C1608 JB 1E 104K-T	T	92.2/88.2
C46	4510008750	S.ELE EEE1AA471UP	T	66.9/49.2
C48	4030011600	S.CER C1608 JB 1E 104K-T	B	118.9/97.7
C66	4510008540	S.ELE EEE1CA100SR	T	106.6/81.6
C68	4030011600	S.CER C1608 JB 1E 104K-T	B	106.7/78.4
C69	4030011600	S.CER C1608 JB 1E 104K-T	T	118.4/79.9
C70	4030011600	S.CER C1608 JB 1E 104K-T	T	95.8/80.5
C71	4030011600	S.CER C1608 JB 1E 104K-T	T	106.9/77.6
C72	4510008540	S.ELE EEE1CA100SR	T	111.6/83.3
C88	4030011600	S.CER C1608 JB 1E 104K-T	B	6.9/78.2
C101	4030011070	S.CER GRM31M2C2H5R0CY21L	B	10.8/12.6
C102	4010005530	CER HM60SJ SL 020C 500V		
C103	4010005530	CER HM60SJ SL 020C 500V		
C105	4030007070	S.CER C1608 CH 1H 330J-T	B	11.4/35.6
C106	4030011540	S.CER C1608 CH 1H 750J-T	B	20.3/34
C107	4030017810	S.CER C1608 CH 1H 102J-T	B	13.6/42.9
C108	4030017810	S.CER C1608 CH 1H 102J-T	B	23.4/42.9
C109	4030006880	S.CER C1608 JB 1H 472K-T	B	20/47.9
C110	4030006880	S.CER C1608 JB 1H 472K-T	B	16.9/47.9
C111	4510008540	S.ELE EEE1CA100SR	T	22.8/54.1
C112	4510008540	S.ELE EEE1CA100SR	T	18/54.1
C113	4030006880	S.CER C1608 JB 1H 472K-T	B	16.9/50.7
C114	4030006880	S.CER C1608 JB 1H 472K-T	B	20/50.7
C115	4030007070	S.CER C1608 CH 1H 330J-T	B	11.4/34
C116	4030011540	S.CER C1608 CH 1H 750J-T	B	20.3/32.4
C119	4030007100	S.CER C1608 CH 1H 560J-T	B	14.7/34
C119	4030007110	S.CER C1608 CH 1H 680J-T	B	14.7/34
C120	4030007070	S.CER C1608 CH 1H 330J-T	B	11.4/32.4
C121	4030007070	S.CER C1608 CH 1H 330J-T	B	10.7/37
C122	4030009530	S.CER C1608 CH 1H 030B-T	B	10.6/38.6
C151	4010005540	CER HM60SJ SL 030C 500V		
C152	4030007070	S.CER C1608 CH 1H 330J-T	B	27.6/45
C153	4030007120	S.CER C1608 CH 1H 820J-T	B	29.2/45
C154	4030007070	S.CER C1608 CH 1H 330J-T	T	31.1/44.2
C155	4030007120	S.CER C1608 CH 1H 820J-T	T	33.9/44.2
C156	4030006880	S.CER C1608 JB 1H 472K-T	B	30.8/45
C157	4030006880	S.CER		

[CTRL BOARD]

REF NO.	ORDER NO.	DESCRIPTION	M.	H/V LOCATION
C212	4030006880	S.CER C1608 JB 1H 472K-T	B	60.7/49
C213	4030006880	S.CER C1608 JB 1H 472K-T	B	65.4/56.6
C214	4030007170	S.CER C1608 CH 1H 221J-T	B	56.7/64.1
C215	4030007170	S.CER C1608 CH 1H 221J-T	B	56.7/52.3
C216	4030011340	S.CER C1608 CH 1H 471J-T	B	56/61.9
C217	4030011340	S.CER C1608 CH 1H 471J-T	B	56/54.5
C218	4030006880	S.CER C1608 JB 1H 472K-T	B	65.4/59.7
C221	4030018400	S.CER 33P CM105 CH G	T	51.2/45.7
C222	4030018400	S.CER 33P CM105 CH G	T	49.9/45.7
C251	4030011020	S.CER GRM31M4C2H1R0CY21L	B	88.3/32.5
C253	4030006880	S.CER C1608 JB 1H 472K-T	B	76.3/25.9
C254	4030006880	S.CER C1608 JB 1H 472K-T	B	76.3/39.2
C255	4030011090	S.CER GRM31M2C2H7R0DV01L	B	107.7/49.3
C301	4010005520	CER HM60SJ SL 01C 500V [USA], [EUR], [UK] 4030011020 S.CER GRM31M4C2H1R0CY21L [FRA], [ITR], [ESP], [KOR]		
C302	4030007030	S.CER C1608 CH 1H 150J-T	T	82.1/51.7
C303	4030007050	S.CER C1608 CH 1H 220J-T	T	82.1/49.1
C304	4030017810	S.CER C1608 CH 1H 102J-T	B	85.7/55.1
C305	4030017810	S.CER C1608 CH 1H 102J-T	B	86.5/57.7
C307	4030006880	S.CER C1608 JB 1H 472K-T	T	86.5/60.5
C308	4030011600	S.CER C1608 JB 1E 104K-T	B	78.5/55.1
C309	4030011600	S.CER C1608 JB 1E 104K-T	T	78.4/55.1
C310	4030009530	S.CER C1608 CH 1H 030B-T	T	82.1/50.4
C311	4030012600	S.CER C2012 JB 1A 105M-T	T	86.2/55.4
C417	4510008540	S.ELE EEE1CA100SR	T	22.6/77.6
C418	4510008540	S.ELE EEE1CA100SR	T	40.6/85.6
C419	4030011600	S.CER C1608 JB 1E 104K-T	T	19.6/78.7
C420	4030011600	S.CER C1608 JB 1E 104K-T	T	38.4/79.2
C425	4030018790	S.CER C3225 JB 2E 104K-T	B	77.4/12.1
C426	4030018790	S.CER C3225 JB 2E 104K-T	B	60.3/17
C427	4030006860	S.CER C1608 JB 1H 102K-T	B	67.1/7.9
C428	4030006860	S.CER C1608 JB 1H 102K-T	B	50.1/17.9
C429	4030011600	S.CER C1608 JB 1E 104K-T	B	68.9/7.9
C430	4030011600	S.CER C1608 JB 1E 104K-T	B	48.3/7.9
C431	4030006880	S.CER C1608 JB 1H 472K-T	B	70.7/7.9
C432	4030018790	S.CER C3225 JB 2E 104K-T	B	86/12.3
C433	4030018790	S.CER C3225 JB 2E 104K-T	B	82.7/11.7
C434	4030006880	S.CER C1608 JB 1H 472K-T	T	92.7/11.7
C435	4030011600	S.CER C1608 JB 1E 104K-T	B	20.5/80.1
C436	4030011600	S.CER C1608 JB 1E 104K-T	B	19.5/101.6
RL252	6330001460	RLY FTR-F1CA012V		
RL253	6330001460	RLY FTR-F1CA012V		
RL254	6330001770	RLY SIP-1A-12V		
CP1	6910009670	S.CHK HK3-S-T	T	67.7/100.1
CP101	6910009670	S.CHK HK3-S-T	T	5/83.4
J1	6510023771	S.CNR 52793-2470 (2490)	T	101.8/99.6
J2	6510023761	S.CNR S10B-PH-SM4-TB (LF) (SN)	T	148.3/82.8
J51	6510023771	S.CNR 52793-2470 (2490)	T	43.9/99.6
J52	6510022031	S.CNR B10B-ZR-SM4-TF (LF) (SN)	T	133/2.9
J53	6510021431	S.CNR S8B-ZR-SM4A-TF (LF) (SN)	T	134.6/65
J101	6510017920	CNR 1811P342		
J251	6510017920	CNR 1811P342		
J252	6510017920	CNR 1811P342		
J301	6510017920	CNR 1811P342		
J351	6510007020	CNR TMP-J01X-V6		
W1	9029804001	WIR 72/99/040/X98/X98		
EP1	9040902903	TUB IRRAX 0.7 (d) L=22 mm		
EP3	6910014690	S.BEA MPZ1608S221A-T	B	115.7/68.2
EP4	6910014690	S.BEA MPZ1608S221A-T	B	113.5/62.3
EP5	6910014730	S.BEA MPZ2012S331A-T	B	117.9/95.2
EP6	6910014730	S.BEA MPZ2012S331A-T	T	109.7/91.2
EP7	6910014730	S.BEA MPZ2012S331A-T	T	106.7/91.2
EP8	6910014730	S.BEA MPZ2012S331A-T	T	103.8/91.2
EP9	6910014690	S.BEA MPZ1608S221A-T	T	94/91.7
EP10	6910014730	S.BEA MPZ2012S331A-T	T	90.8/90.6
EP12	6910015970	S.BEA MMZ1608B 301CT-AS	B	95.2/63.3
EP13	6910015970	S.BEA MMZ1608B 301CT-AS	T	79.4/63.1
EP14	6910014730	S.BEA MPZ2012S331A-T	B	56.3/95.6
EP15	6910014730	S.BEA MPZ2012S331A-T	B	44.6/97.9
EP16	6910014730	S.BEA MPZ2012S331A-T	T	28.7/95.5
EP401	6910014690	S.BEA MPZ1608S221A-T	B	28.1/100.9
EP402	6910014690	S.BEA MPZ1608S221A-T	B	21.9/100.9

[NETWORK BOARD]

REF NO.	ORDER NO.	DESCRIPTION	M.	H/V LOCATION
Q300	1520000561	S.TR 2SB1123 T-TD-E	T	205.7/10.5
Q301	1590000680	S.TR DTC114EUA T106	T	201.4/9.1
L50	6110003950	COL LA-598		
L60	6110003910	COL LA-593		
L70	6110003050	COL LA-492		
L80	6110003050	COL LA-492		
L90	6110003060	COL LA-493		
L100	6110003070	COL LA-494		
L110	6110003920	COL LA-594		
L120	6140004460	COL LR-504		
L130	6140004470	COL LR-505		
L131	6140004470	COL LR-505		
L300	6180000990	COL LAL 04NA 101K		
R300	7030000420	S.RES MCR10EZHZ 2.2 k	T	202.8/6.9
R301	7030000420	S.RES MCR10EZHZ 2.2 k	T	201.5/11.3
R302	7030000420	S.RES MCR10EZHZ 2.2 k	T	206.2/6.9
R303	7030009800	S.RES ERJ12YJ121U (120)	T	209.7/5
C1	4620000120	VAR KB-150-07 150P		
C2	4620000120	VAR KB-150-07 150P		
C3	4010007580	CER HT20SJ SL 201J 3KV		
C4	4010007580	CER HT20SJ SL 201J 3KV		
C5	4010007580	CER HT20SJ SL 201J 3KV		
C6	4010007580	CER HT20SJ SL 201J 3KV		
C7	4010007580	CER HT20SJ SL 201J 3KV		
C8	4010007580	CER HT20SJ SL 201J 3KV		
C9	4010007580	CER HT20SJ SL 201J 3KV		
C10	4010007580	CER HT20SJ SL 201J 3KV		
C18	4030006880	S.CER C1608 JB 1H 472K-T	T	92.6/102.4
C19	4030006880	S.CER C1608 JB 1H 472K-T	T	95.2/1.3
C20	4010007570	CER HT15SJ SL 151J 3KV		
C21	4010007570	CER HT15SJ SL 151J 3KV		
C22	4010007570	CER HT15SJ SL 151J 3KV		
C23	4010007570	CER HT15SJ SL 151J 3KV		
C24	4010007570	CER HT15SJ SL 151J 3KV		
C25	4010007570	CER HT15SJ SL 151J 3KV		
C26	4010007570	CER HT15SJ SL 151J 3KV		
C27	4010007570	CER HT15SJ SL 151J 3KV		
C28	4030006880	S.CER C1608 JB 1H 472K-T	T	84.3/102.4
C29	4030006880	S.CER C1608 JB 1H 472K-T	T	85.3/1.3
C30	4010007550	CER HT11SJ SL 820J 3KV		
C31	4010007550	CER HT11SJ SL 820J 3KV		
C32	4010007550	CER HT11SJ SL 820J 3KV		
C33	4010007550	CER HT11SJ SL 820J 3KV		
C34	4010007550	CER HT11SJ SL 820J 3KV		
C35	4010007550	CER HT11SJ SL 820J 3KV		
C36	4010007550	CER HT11SJ SL 820J 3KV		
C37	4010007550	CER HT11SJ SL 820J 3KV		
C38	4030006880	S.CER C1608 JB 1H 472K-T	T	65.7/102.4
C39	4030006880	S.CER C1608 JB 1H 472K-T	T	71.8/1.3
C40	4010008550	CER DEA1X3F390JC3B		
C41	4010008550	CER DEA1X3F390JC3B		
C42	4010008550	CER DEA1X3F390JC3B		
C43	4010008550	CER DEA1X3F390JC3B		
C44	4010008550	CER DEA1X3F390JC3B		
C45	4010008550	CER DEA1X3F390JC3B		
C46	4010008550	CER DEA1X3F390JC3B		
C47	4010008550	CER DEA1X3F390JC3B		
C48	4030006880	S.CER C1608 JB 1H 472K-T	T	106.1/102.4
C49	4030006880	S.CER C1608 JB 1H 472K-T	T	112.1/1.3
C50	4030006880	S.CER C1608 JB 1H 472K-T	T	140.7/12
C60	4030006880	S.CER C1608 JB 1H 472K-T	T	154.1/12
C70	4030006880	S.CER C1608 JB 1H 472K-T	T	167.5/16.1
C80	4030006880	S.CER C1608 JB 1H 472K-T	T	181.9/21.5
C90	4030006880	S.CER C1608 JB 1H 472K-T	T	195.3/21.3
C100	4030006880	S.CER C1608 JB 1H 472K-T	T	204.4/20.7
C110	4030006880	S.CER C1608 JB 1H 472K-T	T	205.8/20.7
C120	4030006880	S.CER C1608 JB 1H 472K-T	T	207.2/20.6
C211	4030006880	S.CER C1608 JB 1H 472K-T	T	196.2/16.4
C212	4030006880	S.CER C1608 JB 1H 472K-T	T	194.1/18.9
C213	4030006880	S.CER C1608 JB 1H 472K-T	T	192.1/19.6
C214	4030006880	S.CER C1608 JB 1H 472K-T	T	190.7/19.6
C301	4030006880	S.CER C1608 JB 1H 472K-T	T	210.5/10.1
C303	4030006880	S.CER C1608 JB 1H 472K-T	T	199.3/9
RL10	6330001200	RLY VS-12MBU-UC		
RL11	6330001200	RLY VS-12MBU-UC		
RL20	6330001200	RLY VS-12MBU-UC		
RL21	6330001200	RLY VS-12MBU-UC		
RL30	6330001200	RLY VS-12MBU-UC		
RL31	6330001200	RLY VS-12MBU-UC		
RL40	6330001200	RLY VS-12MBU-UC		
RL41	6330001200	RLY VS-12MBU-UC		
RL50	6330001460	RLY FTR-F1CA012V		
RL60	6330001200	RLY VS-12MBU-UC		
RL70	6330001200	RLY VS-12MBU-UC		
RL80	6330001200	RLY VS-12MBU-UC		
RL90	6330001200	RLY VS-12MBU-UC		
RL100	6330001200	RLY VS-12MBU-UC		
RL110	6330001200	RLY VS-12MBU-UC		
RL120	6330001200	RLY VS-12MBU-UC		
J1	6510022472	S.CNR 40FLT-SM2-TB(LF)(SN)(M)	T	184.9/7.4
J2	6510017930	CNR 1771P145-20		
J3	6510017930	CNR 1771P145-20		
J4	6510003521	CNR S04B-EH-S (LF) (SN)		

M.=Mounted side (T: Mounted on the Top side B: Mounted on the Bottom side) S.=Surface mount

[NETWORK BOARD]

REF NO.	ORDER NO.	DESCRIPTION	M.	H/V LOCATION
EP2	6910014730	S.BEA MPZ2012S331A-T	T	198.2/3.3
EP3	6910014730	S.BEA MPZ2012S331A-T	T	183.9/2.7
EP4	6910014730	S.BEA MPZ2012S331A-T	T	170.7/4
EP202	6910015970	S.BEA MMZ1608B 301CT-AS	T	187.4/11.9
EP203	6910015970	S.BEA MMZ1608B 301CT-AS	T	188.4/14.6
EP204	6910015970	S.BEA MMZ1608B 301CT-AS	T	189.4/11.9
EP205	6910015970	S.BEA MMZ1608B 301CT-AS	T	190.4/14.6
EP206	6910015970	S.BEA MMZ1608B 301CT-AS	T	191.4/11.9
EP207	6910015970	S.BEA MMZ1608B 301CT-AS	T	192.4/14.6
EP208	6910015970	S.BEA MMZ1608B 301CT-AS	T	193.4/11.9
EP209	6910015970	S.BEA MMZ1608B 301CT-AS	T	194.4/14.6
EP252	6910015970	S.BEA MMZ1608B 301CT-AS	T	175.4/11.8
EP253	6910015970	S.BEA MMZ1608B 301CT-AS	T	176.4/14.2
EP254	6910015970	S.BEA MMZ1608B 301CT-AS	T	177.4/11.8
EP255	6910015970	S.BEA MMZ1608B 301CT-AS	T	178.4/14.2
EP256	6910015970	S.BEA MMZ1608B 301CT-AS	T	179.4/11.8
EP257	6910015970	S.BEA MMZ1608B 301CT-AS	T	180.4/14.2
EP258	6910015970	S.BEA MMZ1608B 301CT-AS	T	181.4/11.8
EP259	6910015970	S.BEA MMZ1608B 301CT-AS	T	182.4/14.2
EP300	6910015970	S.BEA MMZ1608B 301CT-AS	T	185/11.8

[ANT-SW BOARD]

REF NO.	ORDER NO.	DESCRIPTION	M.	H/V LOCATION
IC11	1130011510	S.IC BU2099FV-E2	T	160.6/33.6
IC12	1180002391	S.REG S-812C33AMC-C2N-G	T	152.4/28.7
Q11	1590001001	S.TR RN2427 (TE85L,F)	T	156.9/38.6
Q12	1590001001	S.TR RN2427 (TE85L,F)	T	152.3/36.9
Q13	1590001001	S.TR RN2427 (TE85L,F)	T	164.7/38.5
Q14	1590001001	S.TR RN2427 (TE85L,F)	T	164.7/17.5
D51	1750000550	S.DIO 1SS355 TE-17	T	161.9/13.3
D61	1750000550	S.DIO 1SS355 TE-17	T	118.9/19.7
D71	1750000550	S.DIO 1SS355 TE-17	T	68.7/21.4
D81	1750000550	S.DIO 1SS355 TE-17	T	36.9/19.7
D83	1750000550	S.DIO 1SS355 TE-17	T	28.2/45.3
D84	1750000550	S.DIO 1SS355 TE-17	T	25.8/43
L2	6110001670	COL LA-253		
R3	7540000130	ABS 2P-50A-301		
R11	7030003320	S.RES ERJ3GEYJ 101 V (100)	T	165.5/27.4
R12	7030003320	S.RES ERJ3GEYJ 101 V (100)	T	164.2/27.4
R13	7030003320	S.RES ERJ3GEYJ 101 V (100)	T	162.9/27.4
R14	7030003320	S.RES ERJ3GEYJ 101 V (100)	T	166.2/33.9
R15	7030003320	S.RES ERJ3GEYJ 101 V (100)	T	153.9/32.6
R17	7030003320	S.RES ERJ3GEYJ 101 V (100)	T	154.7/39.4
R18	7030003320	S.RES ERJ3GEYJ 101 V (100)	T	153.9/34
R20	7030003320	S.RES ERJ3GEYJ 101 V (100)	T	152.1/39.1
R21	7030003320	S.RES ERJ3GEYJ 101 V (100)	T	154.7/36.6
R23	7030003320	S.RES ERJ3GEYJ 101 V (100)	T	162.3/39.1
R24	7030003320	S.RES ERJ3GEYJ 101 V (100)	T	161/39.1
R26	7030003320	S.RES ERJ3GEYJ 101 V (100)	T	162.7/15.6
C1	4010005610	CER HM60SJ SL 100D 500V		
C2	4010005660	CER HM60SJ SL 220J 500V		
C11	4030011600	S.CER C1608 JB 1E 104K-T	T	160.7/29.4
C12	4030011600	S.CER C1608 JB 1E 104K-T	T	154.9/27.9
C51	4030006880	S.CER C1608 JB 1H 472K-T	T	163.5/13.6
C61	4030006880	S.CER C1608 JB 1H 472K-T	T	119.2/21.3
C71	4030006880	S.CER C1608 JB 1H 472K-T	T	69/19.9
C81	4030006880	S.CER C1608 JB 1H 472K-T	T	37.2/21.3
C83	4030006880	S.CER C1608 JB 1H 472K-T	T	26.6/45.6
C84	4030006880	S.CER C1608 JB 1H 472K-T	T	25/45.6
RL51	6330001460	RLY FTR-F1CA012V		
RL61	6330001460	RLY FTR-F1CA012V		
RL71	6330001460	RLY FTR-F1CA012V		
RL81	6330001460	RLY FTR-F1CA012V		
RL83	6330001780	RLY FTR-MYAA012D		
RL84	6330001780	RLY FTR-MYAA012D		
J1	6510017930	CNR 1771P145-20		
J3	6510007020	CNR TMP-J01X-V6		
J4	6510019971	S.CNR 52808-1071	T	153/22
J51	6510000410	CNR MR-DS-E 02		
J61	6510000410	CNR MR-DS-E 02		
J71	6510000410	CNR MR-DS-E 02		
J81	6510000410	CNR MR-DS-E 02		
EP2	6910014730	S.BEA MPZ2012S331A-T	T	151.5/26.1

[OSC UNIT]

REF NO.	ORDER NO.	DESCRIPTION	M.	H/V LOCATION
IC10	1180002610	S.REG BA12FP-E2	T	59.9/37.5
IC1091	1190002001	S.IC AD5260BRUZ50	T	26.8/12
IC1092	1130005721	S.IC TC7W04F (TE12L,F)	T	23.7/6.1
Q1010	1590000680	S.TR DTC114EUA T106	T	30.7/17.9
Q1011	1590000680	S.TR DTC114EUA T106	T	24.9/36.4
Q1012	1590000680	S.TR DTC114EUA T106	T	44.4/32.8
Q1013	1590000680	S.TR DTC114EUA T106	T	41.8/32.8
Q1021	1530002060	S.TR 2SC4081 T106 R	T	11.3/6.3
Q1022	1530002601	S.TR 2SC4215-O (TE85R,F)	T	10.4/17.8
Q1023	1590000680	S.TR DTC114EUA T106	T	13.1/11
Q1042	1530002601	S.TR 2SC4215-O (TE85R,F)	T	18.8/18.0
Q1043	1590000680	S.TR DTC114EUA T106	T	19.7/11.7
Q1061	1530002060	S.TR 2SC4081 T106 R	T	29.8/29.6
Q1062	1530002060	S.TR 2SC4081 T106 R	T	24/32
Q1070	1530002060	S.TR 2SC4081 T106 R	T	18.3/41.3
Q1101	1530002700	S.TR 2SC4097 T106Q	T	66.1/17.8
D1010	1790001250	S.DIO MA2S111-(TX)	T	30.5/16
D1011	1790001250	S.DIO MA2S111-(TX)	T	21.7/37.4
D1071	1750000381	S.DIO 1SS312 (TE85L,F)	T	32.4/27
D1072	1750000381	S.DIO 1SS312 (TE85L,F)	T	32.7/30.4
X10	6050012210	XTL CR-772.OCVXO-148A		
L1020	6200005491	S.COL NLV32T-331J	T	14.7/1.9
L1021	6200003261	S.COL NLV32T-101J	T	7.7/10.9
L1022	6200003261	S.COL NLV32T-101J	T	6.2/16
L1023	6200003051	S.COL NLV32T-R82J	T	6.9/20.3
L1024	6200003051	S.COL NLV32T-R82J	T	6.2/23.8
L1041	6200003261	S.COL NLV32T-101J	T	15.3/13.7
L1042	6200003261	S.COL NLV32T-101J	T	14.7/17.2
L1043	6200003051	S.COL NLV32T-R82J	T	15.3/22.4
L1044	6200003051	S.COL NLV32T-R82J	T	18.8/24.2
L1061	6150004170	COL LS-476		
L1062	6150004170	COL LS-476		
R1011	7030003200	S.RES ERJ3GEYJ 100 V (10)	T	32.7/17
R1012	7030003200	S.RES ERJ3GEYJ 100 V (10)	T	23.8/38.4
R1013	7030003440	S.RES ERJ3GEYJ 102 V (1)	T	16.9/11.6
R1020	7030003240	S.RES ERJ3GEYJ 220 V (22 k)	T	11.3/1.8
R1021	7030003560	S.RES ERJ3GEYJ 103 V (10 k)	T	11.1/4.4
R1022	7030003370	S.RES ERJ3GEYJ 271 V (270)	T	15.5/7.9
R1023	7030004040	S.RES ERJ3GEYJ 4R7 V (4.7)	T	11.4/14
R1024	7030003370	S.RES ERJ3GEYJ 271 V (270)	T	12.3/17.7
R1025	7030003500	S.RES ERJ3GEYJ 332 V (3.3 k)	T	10.1/14.2
R1026	7030003480	S.RES ERJ3GEYJ 222 V (2.2 k)	T	13/9.1
R1027	7030003360	S.RES ERJ3GEYJ 221 V (220)	T	8.8/14.3
R1028	7030003440	S.RES ERJ3GEYJ 102 V (1 k)	T	10.2/11.9
R1043	7030003240	S.RES ERJ3GEYJ 220 V (22)	T	19.7/14.2
R1044	7030003370	S.RES ERJ3GEYJ 271 V (270)	T	20.7/18.6
R1045	7030003500	S.RES ERJ3GEYJ 332 V (3.3 k)	T	17.9/15.1
R1046	7030003480	S.RES ERJ3GEYJ 222 V (2.2 k)	T	19.5/9.8
R1047	7030003290	S.RES ERJ3GEYJ 560 V (56)	T	16.8/17.9
R1061	7030003240	S.RES ERJ3GEYJ 220 V (22)	T	27.8/28.4
R1062	7030003560	S.RES ERJ3GEYJ 103 V (10 k)	T	29.6/27.7
R1063	7030003380	S.RES ERJ3GEYJ 331 V (330)	T	29.9/31.5
R1064	7030003280	S.RES ERJ3GEYJ 470 V (47)	T	25.2/34
R1065	7030003400	S.RES ERJ3GEYJ 471 V (470)	T	24.3/27.5
R1067	7030003560	S.RES ERJ3GEYJ 103 V (10 k)	T	24.3/30.1
R1068	7030003550	S.RES ERJ3GEYJ 822 V (8.2 k)	T	26/32.2
R1071	7030003340	S.RES ERJ3GEYJ 151 V (150)	T	32.9/33.7
R1072	7030003270	S.RES ERJ3GEYJ 390 V (39)	T	34.8/32.8
R1073	7030003340	S.RES ERJ3GEYJ 151 V (150)	T	32.9/32.4
R1074	7030003320	S.RES ERJ3GEYJ 101 V (100)	T	24.2/41.1
R1075	7030003280	S.RES ERJ3GEYJ 470 V (47)	T	26.2/41.8
R1077	7030003320	S.RES ERJ3GEYJ 101 V (100)	T	11.8/41.7
R1078	7030003480	S.RES ERJ3GEYJ 222 V (2.2 k)	T	16.4/41.2
R1079	7030003590	S.RES ERJ3GEYJ 183 V (18 k)	T	15.1/41.2
R1080	7030003360	S.RES ERJ3GEYJ 221 V (220)	T	21.6/41
R1091	7030006091	S.RES ERA3YED 822V (8.2 k)	T	19.4/7.2
R1092	7030005341	S.RES ERA3YED 332V (3.3 k)	T	19.5/8.5
R1093	7030003560	S.RES ERJ3GEYJ 103 V (10 k)	T	25.6/1.4
R1094	7030003540	S.RES ERJ3GEYJ 682 V (6.8 k)	T	25.6/2.7
R1095	7030003320	S.RES ERJ3GEYJ 101 V (100)	T	22.4/16.7
R1096	7030003440	S.RES ERJ3GEYJ 102 V (1 k)	T	32/13.6
R1097	7030003440	S.RES ERJ3GEYJ 102 V (1 k)	T	32/12.1
R1098	7030003640	S.RES ERJ3GEYJ 473 V (47 k)	T	27.4/16
R1099	7030003480	S.RES ERJ3GEYJ 222 V (2.2 k)	T	22.4/10.1
R1100	7030003640	S.RES ERJ3GEYJ 473 V (47 k)	T	27.2/6.4
R1101	7030003360	S.RES ERJ3GEYJ 221 V (220)	T	66/15.9
R1102	7030005981	S.RES ERA3YED 333V (33 k)	T	32/8.8
R2016	7030003440	S.RES ERJ3GEYJ 102 V (1 k)	T	48.5/36.1
R2017	7030003440	S.RES ERJ3GEYJ 102 V (1 k)	T	45.1/35.7
R2018	7030003440	S.RES ERJ3GEYJ 102 V (1 k)	T	42.5/35.7
C1004	4030006880	S.CER C1608 JB 1H 472K-T	T	29.9/8.4
C1005	4550007670	S.TAN F931C105MAABMA	T	29.2/3.2
C1006	4030006880	S.CER C1608 JB 1H 472K-T	T	33/4
C1007	4550007670	S.TAN F931C105MAABMA	T	31.3/3.2
C1008	4030011600	S.CER C1608 JB 1E 104K-T	T	17.3/2.1
C1010	4510008680	S.ELE EEE1EA220SP	T	52.8/35.2
C1011	4030011600	S.CER C1608 JB 1E 104K-T	T	58.3/32
C1012	4030011600	S.CER C1608 JB 1E 104K-T	T	65.1/34.7
C1013	4030006880	S.CER C1608 JB 1H 472K-T	T	63.8/34.7
C1014	4510008680	S.ELE EEE1EA220SP	T	69/31.2
C1015	4030006880	S.CER C1608 JB 1H 472K-T	T	60.9/32
C1016	4030011600	S.CER C1608 JB 1E 104K-T	T	28.7/16

M.=Mounted side (T: Mounted on the Top side B: Mounted on the Bottom side) S.=Surface mount

[OSC UNIT]

REF NO.	ORDER NO.	DESCRIPTION	M.	H/V LOCATION
C1017	4030011600	S.CER C1608 JB 1E 104K-T	T	21.7/34.8
C1018	4030011600	S.CER C1608 JB 1E 104K-T	T	23/36.6
C1019	4030011600	S.CER C1608 JB 1E 104K-T	T	32.3/14.9
C1020	4030011600	S.CER C1608 JB 1E 104K-T	T	13.3/5.2
C1021	4030011600	S.CER C1608 JB 1E 104K-T	T	11.3/3.1
C1022	4030011600	S.CER C1608 JB 1E 104K-T	T	15.1/11
C1023	4030011600	S.CER C1608 JB 1E 104K-T	T	11.9/15.8
C1024	4030011600	S.CER C1608 JB 1E 104K-T	T	12.7/14
C1025	4030011600	S.CER C1608 JB 1E 104K-T	T	10.2/19.8
C1026	4030011330	S.CER C1608 CH 1H 391J-T	T	10.2/21.1
C1027	4030007050	S.CER C1608 CH 1H 220J-T	T	7.7/18.2
C1028	4030017800	S.CER C1608 CH 1H 561J-T	T	8.9/22.5
C1030	4030007110	S.CER C1608 CH 1H 680J-T	T	8.4/24.5
C1031	4030010760	S.CER C1608 CH 1H 331J-T	T	10.2/25.1
C1032	4030011600	S.CER C1608 JB 1E 104K-T	T	11.1/9.1
C1033	4030011600	S.CER C1608 JB 1E 104K-T	T	9.8/10.1
C1042	4030011600	S.CER C1608 JB 1E 104K-T	T	22/12.7
C1043	4030011600	S.CER C1608 JB 1E 104K-T	T	20.1/16.8
C1044	4030011600	S.CER C1608 JB 1E 104K-T	T	19.9/15.5
C1045	4030011600	S.CER C1608 JB 1E 104K-T	T	13.2/20.6
C1046	4030011330	S.CER C1608 CH 1H 391J-T	T	15/19.8
C1047	4030007050	S.CER C1608 CH 1H 220J-T	T	13.2/23.2
C1048	4030017800	S.CER C1608 CH 1H 561J-T	T	17.5/21.5
C1050	4030007110	S.CER C1608 CH 1H 680J-T	T	20.6/22.1
C1051	4030010760	S.CER C1608 CH 1H 331J-T	T	21.7/24.4
C1052	4030011600	S.CER C1608 JB 1E 104K-T	T	17.7/8.8
C1053	4030011600	S.CER C1608 JB 1E 104K-T	T	16.4/9.7
C1062	4030011600	S.CER C1608 JB 1E 104K-T	T	27/30.3
C1063	4030011600	S.CER C1608 JB 1E 104K-T	T	29.9/32.8
C1064	4030011600	S.CER C1608 JB 1E 104K-T	T	24.3/28.8
C1066	4030007010	S.CER C1608 CH 1H 100D-T	T	12.8/25.1
C1067	4030011600	S.CER C1608 JB 1E 104K-T	T	26.5/28.4
C1069	4030006880	S.CER C1608 JB 1H 472K-T	T	66/21
C1070	4030006880	S.CER C1608 JB 1H 472K-T	T	66/22.3
C1071	4030006880	S.CER C1608 JB 1H 472K-T	T	36.6/32.8
C1072	4030006880	S.CER C1608 JB 1H 472K-T	T	28.8/41.8
C1073	4030006880	S.CER C1608 JB 1H 472K-T	T	13.8/41.2
C1074	4030006880	S.CER C1608 JB 1H 472K-T	T	20.2/41.1
C1075	4030006880	S.CER C1608 JB 1H 472K-T	T	22.9/41
C1077	4030011600	S.CER C1608 JB 1E 104K-T	T	11.8/40.4
C1091	4030006880	S.CER C1608 JB 1H 472K-T	T	25.6/15.5
C1092	4030006880	S.CER C1608 JB 1H 472K-T	T	18.9/5.3
C1093	4030006880	S.CER C1608 JB 1H 472K-T	T	22.1/2.7
C1094	4030006880	S.CER C1608 JB 1H 472K-T	T	27.9/8.6
C1101	4550006480	S.TAN TEESVA 1C 475M8R	T	65.4/12.7
C2016	4030006880	S.CER C1608 JB 1H 472K-T	T	43.8/35.7
C2017	4030006880	S.CER C1608 JB 1H 472K-T	T	41.2/35.7
C6110	4030011600	S.CER C1608 JB 1E 104K-T	T	28.7/26.1
RL1010	6330001860	R.LY UA2-12NU		
RL1011	6330001860	R.LY UA2-12NU		
J1071	6510007020	C.NR TMP-J01X-V6		
J1072	6510007020	C.NR TMP-J01X-V6		
J2016	6510020091	S.C.NR 52808-0871 (0890)	T	44.4/40.4
J2017	6510003401	C.NR B04B-EH-S (LF) (SN)		
EP1010	6910012350	S.BEA MMZ1608Y 102BT	T	63.5/32
EP1069	6910014690	S.BEA MPZ1608S221A-T	T	66/19.7
EP1070	6910014690	S.BEA MPZ1608S221A-T	T	66/23.6
EP1091	6910012350	S.BEA MMZ1608Y 102BT	T	20.2/5.3
EP1092	6910012350	S.BEA MMZ1608Y 102BT	T	25.6/16.8

[DIGISEL UNIT]

REF NO.	ORDER NO.	DESCRIPTION	M.	H/V LOCATION
IC1	1130011141	S.IC CAT24WC256X-1.8-T13		
		[USA], [EUR], [UK]	B	98/31.1
	1130014370	S.IC CAT24C256XI-T2		
		[FRA], [ITR], [ESP], [KOR]	B	98/31.1
IC4	1130011510	S.IC BU2099FV-E2	T	86/38.6
IC5	1130011510	S.IC BU2099FV-E2	T	85.9/30.3
Q201	1530003851	S.TR 2SC5551F-TD-E	T	72.2/60.4
D21	1750000550	S.DIO 1SS355 TE-17	B	79.5/8.5
D51	1750000550	S.DIO 1SS355 TE-17	B	60.2/48.3
D52	1750000550	S.DIO 1SS355 TE-17	B	69.4/51.8
D53	1750000550	S.DIO 1SS355 TE-17	B	47.8/48.3
D54	1750000550	S.DIO 1SS355 TE-17	B	54.7/40
D55	1750000550	S.DIO 1SS355 TE-17	T	32.6/42.1
D56	1750000550	S.DIO 1SS355 TE-17	B	78.1/38.1
D57	1750000550	S.DIO 1SS355 TE-17	B	54.7/36.2
D58	1750000550	S.DIO 1SS355 TE-17	B	53.4/18.4
D59	1750000550	S.DIO 1SS355 TE-17	B	53.1/25.3
D60	1750000550	S.DIO 1SS355 TE-17	B	51/25.3
D61	1750000550	S.DIO 1SS355 TE-17	B	50.7/18.5
D62	1750000550	S.DIO 1SS355 TE-17	B	77.9/12
D63	1750000550	S.DIO 1SS355 TE-17	B	77.9/25.3
D64	1750000550	S.DIO 1SS355 TE-17	B	28/27.7
D65	1750000550	S.DIO 1SS355 TE-17	B	28/20.7
D66	1750000550	S.DIO 1SS355 TE-17	B	77.9/18.6
D67	1750000550	S.DIO 1SS355 TE-17	T	51.7/13.6
D68	1750000550	S.DIO 1SS355 TE-17	B	28/13.7
D69	1750000550	S.DIO 1SS355 TE-17	B	24.6/64.7
D70	1750000550	S.DIO 1SS355 TE-17	B	25.3/41.8
D71	1750000550	S.DIO 1SS355 TE-17	B	19/41.8
D72	1750000550	S.DIO 1SS355 TE-17	B	28.1/40.3
D73	1750000550	S.DIO 1SS355 TE-17	B	21.8/40.2
D74	1750000550	S.DIO 1SS355 TE-17	B	24.5/11.7
D75	1750000550	S.DIO 1SS355 TE-17	B	21/28.7
D201	1710001240	DIO L204BBB		
D202	1710001240	DIO L204BBB		
D203	1750000550	S.DIO 1SS355 TE-17	T	42.6/62.4
D204	1750000550	S.DIO 1SS355 TE-17	T	42.6/60.7
D205	1750000550	S.DIO 1SS355 TE-17	B	77.5/46.3
L1	6200003261	S.COL NLV32T-101J	T	94/37.4
L2	6180000990	COL LAL 04NA 101K		
L3	6200003261	S.COL NLV32T-101J	T	94/29.9
L4	6200003261	S.COL NLV32T-101J	T	94/32.9
L101	6140003980	COL LR-476		
L102	6140003990	COL LR-477		
L103	6140004001	COL LR-478A		
L104	6140004010	COL LR-479		
L105	6140004020	COL LR-480		
L106	6140004030	COL LR-481		
L107	6110003930	COL LA-595		
L201	6180000920	COL LAL 03NA 221K		
L203	6140003940	COL LR-493		
R1	7030003680	S.RES ERJ3GEYJ 104 V (100 k)	T	92.3/14.1
R2	7030003680	S.RES ERJ3GEYJ 103 V (10 k)	B	96.6/24.1
R3	7030003680	S.RES ERJ3GEYJ 103 V (10 k)	B	96.6/22.5
R4	7030003440	S.RES ERJ3GEYJ 102 V (1 k)	T	93.2/25.1
R5	7030003440	S.RES ERJ3GEYJ 102 V (1 k)	T	93.2/26.4
R6	7030003440	S.RES ERJ3GEYJ 102 V (1 k)	T	93.2/27.7
R7	7030003440	S.RES ERJ3GEYJ 102 V (1 k)	B	99/24.9
R8	7030003440	S.RES ERJ3GEYJ 102 V (1 k)	B	100.6/24.9
R9	7030003360	S.RES ERJ3GEYJ 221 V (220)	B	82.3/7.6
R10	7030003360	S.RES ERJ3GEYJ 221 V (220)	B	86.7/46.3
R35	7030003360	S.RES ERJ3GEYJ 221 V (220)	B	84.3/39.2
R36	7030003360	S.RES ERJ3GEYJ 221 V (220)	B	83.5/42.6
R37	7030003360	S.RES ERJ3GEYJ 221 V (220)	B	83.5/41
R38	7030003360	S.RES ERJ3GEYJ 221 V (220)	B	86.6/41
R39	7030003360	S.RES ERJ3GEYJ 221 V (220)	B	86.6/42.6
R40	7030003360	S.RES ERJ3GEYJ 221 V (220)	T	80.1/42.6
R41	7030003360	S.RES ERJ3GEYJ 221 V (220)	T	79.9/39.6
R42	7030003360	S.RES ERJ3GEYJ 221 V (220)	T	79.9/38.4
R43	7030003360	S.RES ERJ3GEYJ 221 V (220)	T	79.9/37.2
R44	7030003360	S.RES ERJ3GEYJ 221 V (220)	T	80.2/35.6
R45	7030003360	S.RES ERJ3GEYJ 221 V (220)	T	80.2/34.3
R46	7030003360	S.RES ERJ3GEYJ 221 V (220)	T	79.5/40.8
R47	7030003360	S.RES ERJ3GEYJ 221 V (220)	T	78.7/25.8
R48	7030003360	S.RES ERJ3GEYJ 221 V (220)	T	79.4/23.2
R49	7030003360	S.RES ERJ3GEYJ 221 V (220)	T	80.1/26.2
R50	7030003360	S.RES ERJ3GEYJ 221 V (220)	T	80.8/23.6
R51	7030003360	S.RES ERJ3GEYJ 221 V (220)	T	81.5/26.5
R52	7030003360	S.RES ERJ3GEYJ 221 V (220)	T	86.8/25.4
R53	7030003360	S.RES ERJ3GEYJ 221 V (220)	T	86.1/22.8
R54	7030003360	S.RES ERJ3GEYJ 221 V (220)	T	85.4/25.4
R55	7030003360	S.RES ERJ3GEYJ 221 V (220)	T	84.7/22.8
R56	7030003360	S.RES ERJ3GEYJ 221 V (220)	T	84/25.4
R57	7030003360	S.RES ERJ3GEYJ 221 V (220)	T	83.3/22.8
R58	7030003360	S.RES ERJ3GEYJ 221 V (220)	T	88.4/25.4
R59	7030003440	S.RES ERJ3GEYJ 102 V (1 k)	T	93.2/23.8
R100	7030000010	S.RES MCR10EZJH JPW (000)	B	96.1/38
R104	7030003560	S.RES ERJ3GEYJ 103 V (10 k)	B	24.4/34.3
R105	7030003560	S.RES ERJ3GEYJ 103 V (10 k)	B	17.7/34
R201	7030000380	S.RES MCR10EZJH 1 k	T	57.6/62.7
R202	7030000290	S.RES MCR10EZJH 180 (181)	T	57.6/59.2
R203	7030000220	S.RES MCR10EZJH 47 (470)	T	57.6/60.9
R204	7030003360	S.RES ERJ3GEYJ 221 V (220)	B	80.6/45.3
R205	7030003350	S.RES ERJ3GEYJ 181 V (180)	T	47.3/60.7
R206	7030003370	S.RES ERJ3GEYJ 271 V (270)	T	45/61.4
R207	7030003560	S.RES ERJ3GEYJ 103 V (10 k)	T	48.1/62.7

M.=Mounted side (T: Mounted on the Top side B: Mounted on the Bottom side) S.=Surface mount

[DIGISEL UNIT]

REF NO.	ORDER NO.	DESCRIPTION	M.	H/V LOCATION
R208	703000200	S.RES MCR10EZHZ 33 (330)	T	79.8/60
R209	7030003240	S.RES ERJ3GEYJ 220 V (22)	T	76.8/59.7
R210	7030003370	S.RES ERJ3GEYJ 271 V (270)	T	71.5/56.6
R211	7030003370	S.RES ERJ3GEYJ 271 V (270)	T	72.7/56.5
R213	7030000220	S.RES MCR10EZHZ 47 (470)	T	64.6/56
R214	7030003460	S.RES ERJ3GEYJ 152 V (1.5 k)	T	60.2/59.3
R215	7030003460	S.RES ERJ3GEYJ 152 V (1.5 k)	T	73.3/53.9
R216	7030003680	S.RES ERJ3GEYJ 104 V (100 k)	T	92.6/52.8
C1	4030011600	S.CER C1608 JB 1E 104K-T	B	96.6/25.7
C4	4030011600	S.CER C1608 JB 1E 104K-T	T	87.7/34.4
C5	4030011600	S.CER C1608 JB 1E 104K-T	T	84.4/34.4
C21	4030006880	S.CER C1608 JB 1H 472K-T	B	79.6/6.8
C35	4030006880	S.CER C1608 JB 1H 472K-T	B	83.5/46.3
C51	4030006880	S.CER C1608 JB 1H 472K-T	T	60.5/47.6
C52	4030006880	S.CER C1608 JB 1H 472K-T	T	72.9/47.5
C53	4030006880	S.CER C1608 JB 1H 472K-T	T	48.1/47.6
C54	4030006880	S.CER C1608 JB 1H 472K-T	T	54.7/39.7
C55	4030006880	S.CER C1608 JB 1H 472K-T	T	32.6/43.7
C56	4030006880	S.CER C1608 JB 1H 472K-T	B	80/38.1
C57	4030006880	S.CER C1608 JB 1H 472K-T	T	54.7/36.5
C58	4030006880	S.CER C1608 JB 1H 472K-T	T	51.9/20.1
C59	4030006880	S.CER C1608 JB 1H 472K-T	T	52/27.2
C60	4030006880	S.CER C1608 JB 1H 472K-T	T	52/23.8
C61	4030006880	S.CER C1608 JB 1H 472K-T	T	52/16.8
C62	4030006880	S.CER C1608 JB 1H 472K-T	B	76.3/11.9
C63	4030006880	S.CER C1608 JB 1H 472K-T	B	76.2/25.3
C64	4030006880	S.CER C1608 JB 1H 472K-T	B	28/24.2
C65	4030006880	S.CER C1608 JB 1H 472K-T	B	28/17.2
C66	4030006880	S.CER C1608 JB 1H 472K-T	B	76.2/18.5
C67	4030006880	S.CER C1608 JB 1H 472K-T	T	53.3/13.9
C68	4030006880	S.CER C1608 JB 1H 472K-T	B	28/10.2
C69	4030006880	S.CER C1608 JB 1H 472K-T	B	20.9/64.7
C70	4030006880	S.CER C1608 JB 1H 472K-T	B	28.4/42.1
C71	4030006880	S.CER C1608 JB 1H 472K-T	B	18.6/39.9
C72	4030006880	S.CER C1608 JB 1H 472K-T	B	24.9/39.9
C73	4030006880	S.CER C1608 JB 1H 472K-T	B	22.1/42
C74	4030006880	S.CER C1608 JB 1H 472K-T	B	24.5/8.2
C75	4030006880	S.CER C1608 JB 1H 472K-T	B	16.9/25.5
C101	4030011340	S.CER C1608 CH 1H 471J-T	B	50.5/52.4
C102	4030011280	S.CER C1608 CH 1H 271J-T	B	38.1/52.4
C103	4030011280	S.CER C1608 CH 1H 271J-T	B	40.3/52.4
C104	4030007130	S.CER C1608 CH 1H 101J-T	B	65.1/52.4
C105	4030006940	S.CER C1608 CH 1H 030C-T	B	65.1/44
C106	4030007150	S.CER C1608 CH 1H 151J-T	B	40.4/44
C107	4030007150	S.CER C1608 CH 1H 151J-T	B	50.5/44
C108	4030007150	S.CER C1608 CH 1H 151J-T	B	52.3/44
C109	4030007150	S.CER C1608 CH 1H 151J-T	B	37.2/44
C110	4030009520	S.CER C1608 CH 1H 020B-T	B	62.5/34
C111	4030009550	S.CER C1608 CH 1H 2R5B-T	B	64.3/34
C113	4030007000	S.CER C1608 CH 1H 090D-T	B	40.3/34
C114	4030007040	S.CER C1608 CH 1H 180J-T	B	70.9/34
C115	4030007040	S.CER C1608 CH 1H 180J-T	B	46.9/34
C116	4030007040	S.CER C1608 CH 1H 180J-T	B	48.7/34
C117	4030007070	S.CER C1608 CH 1H 330J-T	B	65.9/31
C118	4030007090	S.CER C1608 CH 1H 470J-T	B	66.9/42.4
C119	4030007040	S.CER C1608 CH 1H 180J-T	B	45.1/42.4
C120	4030007040	S.CER C1608 CH 1H 180J-T	B	46.9/42.4
C121	4030007040	S.CER C1608 CH 1H 180J-T	B	70.9/42.4
C122	4030007000	S.CER C1608 CH 1H 090D-T	B	42/42.4
C124	4030009520	S.CER C1608 CH 1H 020B-T	B	60.7/42.4
C125	4030009550	S.CER C1608 CH 1H 2R5B-T	B	62.5/42.4
C126	4030008360	S.CER C1608 UJ 1H 101J-T	B	40.3/7.5
C128	4030009500	S.CER C1608 CH 1H 0R5B-T	B	60.5/14.4
C129	4030009510	S.CER C1608 CH 1H 010B-T	B	59.7/21.8
C130	4030009520	S.CER C1608 CH 1H 020B-T	B	44.3/21.8
C131	4030009910	S.CER C1608 CH 1H 040B-T	B	44.6/15.1
C132	4030006990	S.CER C1608 CH 1H 080D-T	B	68.6/7.6
C133	4030007040	S.CER C1608 CH 1H 180J-T	B	76/28.6
C134	4030008750	S.CER C1608 CH 1H 360J-T	B	31.4/15
C135	4030007110	S.CER C1608 CH 1H 680J-T	B	34.1/15.2
C136	4030007140	S.CER C1608 CH 1H 121J-T	B	76/21.8
C137	4030007140	S.CER C1608 CH 1H 121J-T	B	42.1/7.5
C138	4030007130	S.CER C1608 CH 1H 101J-T	B	43.9/7.5
C139	4030007160	S.CER C1608 CH 1H 181J-T	B	34.9/7.5
C140	4030007160	S.CER C1608 CH 1H 181J-T	B	36.7/7.5
C141	4030008330	S.CER C1608 UJ 1H 560J-T	B	17.7/59.1
C142	4030008330	S.CER C1608 UJ 1H 560J-T	B	13.7/43.7
C143	4030007090	S.CER C1608 CH 1H 470J-T	B	17.6/48
C201	4030011600	S.CER C1608 JB 1E 104K-T	T	60.2/62.1
C202	4030006900	S.CER C1608 JB 1H 103K-T	T	46.5/64.2
C203	4030011600	S.CER C1608 JB 1E 104K-T	T	45/64.2
C204	4030011600	S.CER C1608 JB 1E 104K-T	T	48/58.6
C205	4030011600	S.CER C1608 JB 1E 104K-T	B	61/63
C206	4030011600	S.CER C1608 JB 1E 104K-T	T	76.8/61
C207	4030006880	S.CER C1608 JB 1H 472K-T	B	59.2/63
C208	4030007010	S.CER C1608 CH 1H 100D-T	T	76.8/58.4
C209	4030006880	S.CER C1608 JB 1H 472K-T	T	62.9/56.3
C210	4030006900	S.CER C1608 JB 1H 103K-T	T	70.2/56.6
C211	4030009000	S.CER C2012 JB 1C 224K-T	T	68.6/56.1
C212	4030006880	S.CER C1608 JB 1H 472K-T	T	71.7/53.9
C213	4030006880	S.CER C1608 JB 1H 472K-T	T	46.5/58.6
C214	4030006880	S.CER C1608 JB 1H 472K-T	T	45/58.6
C215	4030006880	S.CER C1608 JB 1H 472K-T	B	77.8/44.4
RL2	6330001860	RLY UA2-12NU		
RL21	6330001860	RLY UA2-12NU		
RL51	6330001860	RLY UA2-12NU		
RL52	6330001860	RLY UA2-12NU		
RL53	6330001860	RLY UA2-12NU		
RL54	6330001860	RLY UA2-12NU		
RL55	6330001860	RLY UA2-12NU		

[DIGISEL UNIT]

REF NO.	ORDER NO.	DESCRIPTION	M.	H/V LOCATION
RL56	6330001860	RLY UA2-12NU		
RL57	6330001860	RLY UA2-12NU		
RL58	6330001860	RLY UA2-12NU		
RL59	6330001860	RLY UA2-12NU		
RL60	6330001860	RLY UA2-12NU		
RL61	6330001860	RLY UA2-12NU		
RL62	6330001860	RLY UA2-12NU		
RL63	6330001860	RLY UA2-12NU		
RL64	6330001860	RLY UA2-12NU		
RL65	6330001860	RLY UA2-12NU		
RL66	6330001860	RLY UA2-12NU		
RL67	6330001860	RLY UA2-12NU		
RL69	6330001860	RLY UA2-12NU		
RL70	6330001860	RLY UA2-12NU		
RL71	6330001860	RLY UA2-12NU		
RL72	6330001860	RLY UA2-12NU		
RL73	6330001860	RLY UA2-12NU		
RL74	6330001860	RLY UA2-12NU		
RL75	6330001860	RLY UA2-12NU		
RL76	6330001860	RLY UA2-12NU		
RL201	6330001860	RLY UA2-12NU		
J1	6510007020	CNR TMP-J01X-V6		
J2	6510007020	CNR TMP-J01X-V6		
J2017	6510019971	S.CNR 52808-1071	T	99.4/27.4
J2018	6510003391	CNR B03B-EH-S (LF) (SN)		
W11	8600037250	CBL SX3009 J11*J12DI		
EP2	6910014690	S.BEA MPZ1608S221A-T		

M.=Mounted side (T: Mounted on the Top side B: Mounted on the Bottom side)
S.=Surface mount

[FRONT UNIT]

REF NO.	ORDER NO.	DESCRIPTION	M.	H/V LOCATION
W1	8900017300	CBL OPC-1838 (P1,N16,L140)		
W2	8900015940	CBL OPC-875A (P1,N20,L70)		
W3	8900015930	CBL OPC-886A (P1,N10,L75)		
W4	8900017280	CBL OPC-1836 (P1,N10,L60)		
W5	8900014720	CBL OPC-909A (P1,N10,L110)		
W6	8900017290	CBL OPC-1837 (P1,N10,L170)		
W7	8900017100	CBL OPC-1825 (P1,N18,L70)		
W8	8900015930	CBL OPC-886A (P1,N10,L75)		
W9	8900014871	CBL OPC-1332A-1 (P0.5,N40,L100)		
W10	8900014720	CBL OPC-909A (P1,N10,L110)		
W11	8900015930	CBL OPC-886A (P1,N10,L75)		
W12	8900015930	CBL OPC-886A (P1,N10,L75)		
W13	8900014871	CBL OPC-1332A-1 (P0.5,N40,L100)		
EP1	6910015291	UBD LTA070B790F		
EP11	6910011090	SUT RMS20-250-201-P		
EP12	0880001460	UBD EX-2500 [EUR]		
EP101	6910015650	E.OTH S-G2218-3#01 (MOUNT PLATE)		
EP102	6910015650	E.OTH S-G2218-3#01 (MOUNT PLATE)		

[DISPLAY BOARD]

REF NO.	ORDER NO.	DESCRIPTION	M.	H/V LOCATION
IC1	1130009640	S.IC BU4051BCFV-E2	T	113/15
IC3	1130009640	S.IC BU4051BCFV-E2	T	85.2/18.4
IC4	1130009640	S.IC BU4051BCFV-E2	T	43.4/78.7
IC5	1130009640	S.IC BU4051BCFV-E2	T	44.7/68.7
IC6	1140014420	S.IC M30620FCMGP (SX-3009B)	T	52.4/39
IC7	1130011510	S.IC BU2099FV-E2	T	72.2/59.8
IC201	1130009301	S.IC TC7SET08FU (T5L,JF)	T	81/40.5
IC202	1130009301	S.IC TC7SET08FU (T5L,JF)	T	117.2/58.5
IC601	1130011551	S.IC RX-4581NB-F	T	35.5/29.3
IC651	1110005821	S.IC R3112N281A-TR-F	T	120.7/71.8
Q200	1590000430	S.TR DTC144EUA T106	T	117.7/80.1
Q201	1530003301	S.TR 2SC3647S-TD-E	T	100.7/47.1
Q202	1530003301	S.TR 2SC3647S-TD-E	T	98.1/26.5
Q203	1530002060	S.TR 2SC4081 T106 R	T	85.4/50.2
Q204	1520000651	S.TR 2SB1201S-TL-E	T	91/53.9
Q205	1590000680	S.TR DTC114EUA T106	T	82.3/45.9
Q206	1590000680	S.TR DTC114EUA T106	T	134.4/14.6
Q209	1520000651	S.TR 2SB1201S-TL-E	T	123.9/59.9
Q210	1530002060	S.TR 2SC4081 T106 R	T	117.3/55.3
Q211	1590001330	S.TR DTA114EUA T106	T	131.8/63.5
Q212	1590000680	S.TR DTC114EUA T106	T	84/43.1
Q501	1590000680	S.TR DTC114EUA T106	T	131.5/73.3
Q502	1590000680	S.TR DTC114EUA T106	T	29.6/46
Q503	1590000680	S.TR DTC114EUA T106	T	29.6/48.5
Q504	1590001330	S.TR DTA114EUA T106	T	131.5/68.3
Q505	1590000680	S.TR DTC114EUA T106	T	131.5/70.8
Q601	1510000501	S.TR 2SA1162-GR (TE85R,F)	T	113.6/80.4
D7	1750000520	S.DIO DAN222TL	T	130.4/18.3
D8	1160000140	S.DIO DAP222 TL	T	130.4/16.2
D9	1730002340	S.ZEN MA8047-H (TX)	T	85.8/48.1
D10	1730002590	S.ZEN MA8033-H (TX)	T	119.5/56.9
D11	1790001670	S.DIO RB706F-40T106	T	135.2/17.1
D12	1790001670	S.DIO RB706F-40T106	T	50.7/54
D601	1790001250	S.DIO MA2S111-(TX)	T	111.5/81.6
D602	1790001250	S.DIO MA2S111-(TX)	T	113.3/78
D603	1790001250	S.DIO MA2S111-(TX)	T	111.5/78.9
X1	6050009870	S.XTL CR-567 (9.8304 MHz)	T	35.6/40.5
L201	6200001831	S.COL NLV32T-100J	T	31.1/58.1
L204	6200001831	S.COL NLV32T-100J	T	25.9/73.2
L210	6190001191	S.COL D10F-#A814AY-101K	T	88.9/64.9
L211	6190001191	S.COL D10F-#A814AY-101K	T	89.6/30.2
L601	6200001831	S.COL NLV32T-100J	T	116.7/77.3
R200	7030003440	S.RES ERJ3GEYJ 102 V (1 k)	T	84.6/40.4
R201	7030003470	S.RES ERJ3GEYJ 182 V (1.8 k)	T	103.6/43.6
R202	7030003470	S.RES ERJ3GEYJ 182 V (1.8 k)	T	103.6/32.9
R203	7030003800	S.RES ERJ3GEYJ 105 V (1 M)	T	38.9/40.5
R208	7030003360	S.RES ERJ3GEYJ 221 V (220)	T	86.5/45.7
R209	7030003860	S.RES ERJ3GE JPW V	T	16.1/24.6
R210	7030003860	S.RES ERJ3GE JPW V	T	23.7/24
R212	7030003660	S.RES ERJ3GEYJ 683 V (68 k)	T	80.1/45.5
R213	7030003580	S.RES ERJ3GEYJ 153 V (15 k)	T	81.8/43.4
R214	7030003440	S.RES ERJ3GEYJ 102 V (1 k)	T	50.7/13.4
R215	7030003440	S.RES ERJ3GEYJ 102 V (1 k)	T	49.4/13.4
R216	7030003440	S.RES ERJ3GEYJ 102 V (1 k)	T	48.1/13.4
R217	7030003440	S.RES ERJ3GEYJ 102 V (1 k)	T	46.8/13.4
R218	7030003440	S.RES ERJ3GEYJ 102 V (1 k)	T	45.5/13.4
R219	7030003440	S.RES ERJ3GEYJ 102 V (1 k)	T	44.2/13.4
R220	7030003440	S.RES ERJ3GEYJ 102 V (1 k)	T	41.6/13.6
R221	7030003440	S.RES ERJ3GEYJ 102 V (1 k)	T	42.9/13.4
R222	7030003440	S.RES ERJ3GEYJ 102 V (1 k)	T	40.6/16.1
R223	7030003440	S.RES ERJ3GEYJ 102 V (1 k)	T	39.8/13.5
R224	7030003440	S.RES ERJ3GEYJ 102 V (1 k)	T	39.1/16.1
R225	7030003440	S.RES ERJ3GEYJ 102 V (1 k)	T	38.3/13.4
R226	7030003440	S.RES ERJ3GEYJ 102 V (1 k)	T	37.6/16.1
R227	7030003440	S.RES ERJ3GEYJ 102 V (1 k)	T	36.8/13.4
R228	7030003440	S.RES ERJ3GEYJ 102 V (1 k)	T	35.5/13.4
R229	7030003440	S.RES ERJ3GEYJ 102 V (1 k)	T	32.9/13.4
R230	7030003440	S.RES ERJ3GEYJ 102 V (1 k)	T	34.2/13.4
R232	7030003440	S.RES ERJ3GEYJ 102 V (1 k)	T	83.9/13.5
R233	7030003440	S.RES ERJ3GEYJ 102 V (1 k)	T	85.2/13.5
R234	7030003440	S.RES ERJ3GEYJ 102 V (1 k)	T	86.5/13.5
R235	7030003440	S.RES ERJ3GEYJ 102 V (1 k)	T	87.8/13.5
R236	7030003440	S.RES ERJ3GEYJ 102 V (1 k)	T	89.1/13.5
R237	7030003440	S.RES ERJ3GEYJ 102 V (1 k)	T	90.4/13.5
R238	7030003440	S.RES ERJ3GEYJ 102 V (1 k)	T	91.7/13.5
R239	7030003440	S.RES ERJ3GEYJ 102 V (1 k)	T	30.8/53.2
R240	7030003440	S.RES ERJ3GEYJ 102 V (1 k)	T	30.8/51.9
R241	7030003680	S.RES ERJ3GEYJ 104 V (100 k)	T	30.9/54.6
R242	7030003680	S.RES ERJ3GEYJ 104 V (100 k)	T	33.5/52.3
R246	7030003440	S.RES ERJ3GEYJ 102 V (1 k)	T	65.3/13.4
R247	7030003440	S.RES ERJ3GEYJ 102 V (1 k)	T	64/13.4
R248	7030003440	S.RES ERJ3GEYJ 102 V (1 k)	T	62.7/13.4
R249	7030003440	S.RES ERJ3GEYJ 102 V (1 k)	T	61.4/13.4
R250	7030003440	S.RES ERJ3GEYJ 102 V (1 k)	T	60.1/13.4
R251	7030003320	S.RES ERJ3GEYJ 101 V (100)	T	58.8/13.4
R252	7030003440	S.RES ERJ3GEYJ 102 V (1 k)	T	57.5/13.4
R253	7030003440	S.RES ERJ3GEYJ 102 V (1 k)	T	56.2/13.4
R254	7030003680	S.RES ERJ3GEYJ 104 V (100 k)	T	54.9/13.4
R255	7030003640	S.RES ERJ3GEYJ 473 V (47 k)	T	22.6/14.1
R256	7030003640	S.RES ERJ3GEYJ 473 V (47 k)	T	26.5/14.1
R257	7030003670	S.RES ERJ3GEYJ 823 V (82 k)	T	23.9/14.1
R258	7030003670	S.RES ERJ3GEYJ 823 V (82 k)	T	25.2/14.1
R259	7030003440	S.RES ERJ3GEYJ 102 V (1 k)	T	40.9/63.4
R260	7030003440	S.RES ERJ3GEYJ 102 V (1 k)	T	16.4/59.4
R261	7030003440	S.RES ERJ3GEYJ 102 V (1 k)	T	6.3/58.7
R262	7030003440	S.RES ERJ3GEYJ 102 V (1 k)	T	16/56
R263	7030003440	S.RES ERJ3GEYJ 102 V (1 k)	T	6.3/55.6
R264	7030003440	S.RES ERJ3GEYJ 102 V (1 k)	T	16/54.7
R265	7030003440	S.RES ERJ3GEYJ 102 V (1 k)	T	6.3/54.3
R266	7030003440	S.RES ERJ3GEYJ 102 V (1 k)	T	16/53.4
R267	7030003440	S.RES ERJ3GEYJ 102 V (1 k)	T	6.3/53
R268	7030003440	S.RES ERJ3GEYJ 102 V (1 k)	T	15.2/52.1
R270	7030003440	S.RES ERJ3GEYJ 102 V (1 k)	T	15.2/50.8
R272	7030003440	S.RES ERJ3GEYJ 102 V (1 k)	T	6.3/51.7
R273	7030003440	S.RES ERJ3GEYJ 102 V (1 k)	T	6.3/50.4
R274	7030003440	S.RES ERJ3GEYJ 102 V (1 k)	T	15.2/49.5
R275	7030003440	S.RES ERJ3GEYJ 102 V (1 k)	T	6.3/49.1
R276	7030003440	S.RES ERJ3GEYJ 102 V (1 k)	T	15.9/72.6
R278	7030003440	S.RES ERJ3GEYJ 102 V (1 k)	T	15.9/62.2
R279	7030003440	S.RES ERJ3GEYJ 102 V (1 k)	T	6.3/62
R280	7030003440	S.RES ERJ3GEYJ 102 V (1 k)	T	15.9/63.5
R281	7030003440	S.RES ERJ3GEYJ 102 V (1 k)	T	6.3/63.3
R282	7030003440	S.RES ERJ3GEYJ 102 V (1 k)	T	15.9/64.8
R295	7030003440	S.RES ERJ3GEYJ 102 V (1 k)	T	15.9/67.4
R296	7030003440	S.RES ERJ3GEYJ 102 V (1 k)	T	6.2/67.2
R297	7030003440	S.RES ERJ3GEYJ 102 V (1 k)	T	15.9/68.7
R298	7030003440	S.RES ERJ3GEYJ 102 V (1 k)	T	6.3/68.5
R299	7030003440	S.RES ERJ3GEYJ 102 V (1 k)	T	6.3/64.6
R300	7030003440	S.RES ERJ3GEYJ 102 V (1 k)	T	15.9/71.3
R301	7030003440	S.RES ERJ3GEYJ 102 V (1 k)	T	6.3/71.1
R302	7030003560	S.RES ERJ3GEYJ 103 V (10 k)	T	6.3/69.8
R303	7030003560	S.RES ERJ3GEYJ 103 V (10 k)	T	15.9/70
R304	7030003560	S.RES ERJ3GEYJ 103 V (10 k)	T	6.3/65.9
R305	7030003560	S.RES ERJ3GEYJ 103 V (10 k)	T	15.9/66.1
R310	7030003440	S.RES ERJ3GEYJ 102 V (1 k)	T	14.6/22.4
R311	7030003440	S.RES ERJ3GEYJ 102 V (1 k)	T	14.6/21.1
R312	7030003440	S.RES ERJ3GEYJ 102 V (1 k)	T	135/20.4
R313	7030003440	S.RES ERJ3GEYJ 102 V (1 k)	T	135/19.1
R320	7030003440	S.RES ERJ3GEYJ 102 V (1 k)	T	135/26.9
R321	7030003440	S.RES ERJ3GEYJ 102 V (1 k)	T	135/25.6
R322	7030003440	S.RES ERJ3GEYJ 102 V (1 k)	T	135/24.3
R323	7030003560	S.RES ERJ3GEYJ 103 V (10 k)	T	135/28.2
R326	7030003360	S.RES ERJ3GEYJ 221 V (220)	T	119.8/54.4
R327	7030003580	S.RES ERJ3GEYJ 153 V (15 k)	T	115.4/55.1
R328	7030003660	S.RES ERJ3GEYJ 683 V (68 k)	T	115/61.2
R329	7030003560	S.RES ERJ3GEYJ 103 V (10 k)	T	52/21.3
R330	7030003500	S.RES ERJ3GEYJ 332 V (3.3 k)	T	134.4/63
R333	7030003640	S.RES ERJ3GEYJ 473 V (47 k)	T	16/57.3
R334	7030003640	S.RES ERJ3GEYJ 473 V (47 k)	T	6.3/56.9
R337	7030003670	S.RES ERJ3GEYJ 823 V (82 k)	T	19.7/57.3
R338	7030003670	S.RES ERJ3GEYJ 823 V (82 k)	T	2.8/56.9
R339	7070000261	RES ERG2SJ 220 (22)	T	
R340	7070000261	RES ERG2SJ 220 (22)	T	
R342	7030003640	S.RES ERJ3GEYJ 473 V (47 k)	T	80.2/38.1
R343	7030003640	S.RES ERJ3GEYJ 473 V (47 k)	T	115.1/57.7
R351	7030003440	S.RES ERJ3GEYJ 102 V (1 k)	T	135.3/74.9
R352	7030003440	S.RES ERJ3GEYJ 102 V (1 k)	T	135.3/76.2
R353	7030003440	S.RES ERJ3GEYJ 102 V (1 k)	T	50/69.5
R354	7030003440	S.RES ERJ3GEYJ 102 V (1 k)	T	50/66.8
R355	7030003440	S.RES ERJ3GEYJ 102 V (1 k)	T	50/68.2
R356	7030003440	S.RES ERJ3GEYJ 102 V (1 k)	T	128.4/9.8
R357	7030003440	S.RES ERJ3GEYJ 102 V (1 k)	T	119.4/10
R358	7030003440	S.RES ERJ3GEYJ 102 V (1 k)	T	128.5/11.8
R359	7030003440	S.RES ERJ3GEYJ 102 V (1 k)	T	119.4/11.3
R360	7030003440	S.RES ERJ3GEYJ 102 V (1 k)	T	128.5/13.8
R361	7030003440	S.RES ERJ3GEYJ 102 V (1 k)	T	119.4/12.6
R362	7030003440	S.RES ERJ3GEYJ 102 V (1 k)	T	135/23
R363	7030003440	S.RES ERJ3GEYJ 102 V (1 k)	T	135/21.7
R364	7030003640	S.RES ERJ3GEYJ 473 V (47 k)	T	51.1/51.6
R365	7030004730	S.RES ERJ3GEYF 222 V (2.2 k)	T	49.8/51.6
R366	7030003440	S.RES ERJ3GEYJ 102 V (1 k)	T	134.4/70.6
R369	7030003860	S.RES ERJ3GE JPW V	T	44.8/51.7
R501	7030003640	S.RES ERJ3GEYJ 473 V (47 k)	T	52/22.6
R502	7030003640	S.RES ERJ3GEYJ 473 V (47 k)	T	52/23.9
R503	7030003640	S.RES ERJ3GEYJ 473 V (47 k)	T	54.7/20.6
R504	7030003440	S.RES ERJ3GEYJ 102 V (1 k)	T	134.4/69.3
R505	7030003330	S.RES ERJ3GEYJ 121 V (120)	T	134.4/68
R506	7030003640	S.RES ERJ3GEY		

[DISPLAY BOARD]

REF NO.	ORDER NO.	DESCRIPTION	M.	H/V LOCATION
R603	7030003640	S.RES ERJ3GEYJ 473 V (47 k)	T	30.3/28.6
R604	7030003560	S.RES ERJ3GEYJ 103 V (10 k)	T	30.3/30.1
R651	7030003650	S.RES ERJ3GEYJ 563 V (56 k)	T	117.9/74.4
R652	7030003620	S.RES ERJ3GEYJ 333 V (33 k)	T	116.6/71.8
R653	7030003520	S.RES ERJ3GEYJ 472 V (4.7 k)	T	116.6/74.4
R654	7030003540	S.RES ERJ3GEYJ 682 V (6.8 k)	T	134.2/78
R655	7030003540	S.RES ERJ3GEYJ 682 V (6.8 k)	T	144/77.2
R656	7030003540	S.RES ERJ3GEYJ 682 V (6.8 k)	T	144/75.9
R657	7030003540	S.RES ERJ3GEYJ 682 V (6.8 k)	T	144/74.6
C201	4310001170	MLR ECQE1A 124JBB		
C202	4030016880	S.CER C4520 CH 3F 150KT-A	T	134.5/44.3
C203	4030007020	S.CER C1608 CH 1H 120J-T	T	40.2/41.3
C204	4030007020	S.CER C1608 CH 1H 120J-T	T	40.1/38.7
C205	4030011600	S.CER C1608 JB 1E 104K-T	T	43.2/82.3
C206	4030011600	S.CER C1608 JB 1E 104K-T	T	43.4/65.2
C207	4030011600	S.CER C1608 JB 1E 104K-T	T	83.9/22
C209	4030011600	S.CER C1608 JB 1E 104K-T	T	115.2/18.5
C210	4030011600	S.CER C1608 JB 1E 104K-T	T	83/40.4
C211	4030011600	S.CER C1608 JB 1E 104K-T	T	117.6/61.2
C212	4510008800	S.ELE EEE1EA100SR	T	80.3/50
C213	4510009150	S.ELE EEE1EA470WP	T	89.3/40.8
C214	4510008800	S.ELE EEE1EA100SR	T	83.7/55.8
C215	4030011600	S.CER C1608 JB 1E 104K-T	T	32.4/62.7
C216	4030011600	S.CER C1608 JB 1E 104K-T	T	66.1/6.2
C217	4030011600	S.CER C1608 JB 1E 104K-T	T	34.2/54.3
C218	4510009150	S.ELE EEE1EA470WP	T	36.6/61.8
C219	4030006860	S.CER C1608 JB 1H 102K-T	T	34.2/55.7
C220	4030011600	S.CER C1608 JB 1E 104K-T	T	28.7/72.1
C221	4030011600	S.CER C1608 JB 1E 104K-T	T	113.2/55.1
C222	4030011600	S.CER C1608 JB 1E 104K-T	T	82.6/13.5
C223	4030011600	S.CER C1608 JB 1E 104K-T	T	144.6/33.9
C224	4030011600	S.CER C1608 JB 1E 104K-T	T	41.9/39
C225	4030011600	S.CER C1608 JB 1E 104K-T	T	70/55.6
C226	4030011600	S.CER C1608 JB 1E 104K-T	T	18.7/60.7
C227	4030011600	S.CER C1608 JB 1E 104K-T	T	33.1/66.2
C228	4510008800	S.ELE EEE1EA100SR	T	32.6/70.4
C229	4030011600	S.CER C1608 JB 1E 104K-T	T	6.3/73.7
C230	4030006880	S.CER C1608 JB 1H 472K-T	T	50.6/55.9
C231	4030011600	S.CER C1608 JB 1E 104K-T	T	64.6/38.9
C232	4030011600	S.CER C1608 JB 1E 104K-T	T	47.4/53
C241	4030011600	S.CER C1608 JB 1E 104K-T	T	106.5/17.3
C242	4030011600	S.CER C1608 JB 1E 104K-T	T	106.5/16
C243	4030011600	S.CER C1608 JB 1E 104K-T	T	106.5/14.7
C244	4030011600	S.CER C1608 JB 1E 104K-T	T	106.5/13.4
C245	4030011600	S.CER C1608 JB 1E 104K-T	T	119.4/17.8
C246	4030011600	S.CER C1608 JB 1E 104K-T	T	119.4/16.5
C247	4030011600	S.CER C1608 JB 1E 104K-T	T	119.4/15.2
C248	4030011600	S.CER C1608 JB 1E 104K-T	T	119.4/13.9
C254	4030011600	S.CER C1608 JB 1E 104K-T	T	50.2/79.6
C255	4030011600	S.CER C1608 JB 1E 104K-T	T	50.2/80.9
C257	4030011600	S.CER C1608 JB 1E 104K-T	T	79.2/19.4
C258	4030011600	S.CER C1608 JB 1E 104K-T	T	79.2/20.7
C259	4030011600	S.CER C1608 JB 1E 104K-T	T	79.2/16.8
C260	4030011600	S.CER C1608 JB 1E 104K-T	T	79.2/18.1
C261	4030011600	S.CER C1608 JB 1E 104K-T	T	93.1/16.8
C262	4030011600	S.CER C1608 JB 1E 104K-T	T	93.1/18.1
C263	4030011600	S.CER C1608 JB 1E 104K-T	T	93.1/19.4
C264	4030011600	S.CER C1608 JB 1E 104K-T	T	93.1/20.7
C265	4030011600	S.CER C1608 JB 1E 104K-T	T	50.2/77
C266	4030011600	S.CER C1608 JB 1E 104K-T	T	50.2/78.3
C601	4510008800	S.ELE EEE1EA100SR	T	113/73.1
C602	4030011600	S.CER C1608 JB 1E 104K-T	T	30.3/27.3
C651	4030008890	S.CER C1608 JB 1H 273K-T	T	123.3/72
C652	4030011600	S.CER C1608 JB 1E 104K-T	T	117.9/71.8
J1	6510022472	S.CNR 40FLT-SM2-TB(LF)(SN)(M)	T	11/59.6
J4	6510020531	S.CNR 52808-1871	T	40.8/8.8
J5	6510019971	S.CNR 52808-1071	T	87.7/8.8
J7	6510019971	S.CNR 52808-1071	T	60.7/8.8
J8	6510019971	S.CNR 52808-1071	T	124/12.3
J201	6510022472	S.CNR 40FLT-SM2-TB(LF)(SN)(M)	T	9.5/28.4
J202	6510022472	S.CNR 40FLT-SM2-TB(LF)(SN)(M)	T	19.9/28.4
J203	6510020081	S.CNR 52808-2071 (2090)	T	26/59.7
J205	6510003401	CNR B04B-EH-S (LF) (SN)		
J301	6510021181	S.CNR SM2 (8.0) B-BHS1TB(LF)(SN)	T	141.7/44.8
J601	6510021861	CNR BH-800.4GG <LTC>		
J602	6510020081	S.CNR 52808-2071 (2090)	T	139.7/70.5
J603	6510019971	S.CNR 52808-1071	T	102.7/8.8
J604	6510019981	S.CNR 52808-1671 (1690)	T	140.1/27.4
J605	6510018961	S.CNR B2B-PH-SM4-TB (LF) (SN)	T	87.5/81.9
J606	6510022191	S.CNR B3B-PH-SM4-TB (LF) (SN)	T	99.4/82.9
T201	5910000981	TSM 3319-T088-LF		
BT601	3020000110	LTM CR2032		
EP203	6910014690	S.BEA MPZ1608S221A-T	T	30.4/62.3
EP205	6910014690	S.BEA MPZ1608S221A-T	T	47.4/54.3
EP207	6910014690	S.BEA MPZ1608S221A-T	T	143.9/32
EP208	6910014690	S.BEA MPZ1608S221A-T	T	31/64.9
EP209	6910014690	S.BEA MPZ1608S221A-T	T	6.3/72.4

[VR-A BOARD]

REF NO.	ORDER NO.	DESCRIPTION	M.	H/V LOCATION
R1	7210002970	VAR RV-314 (RK0972210 10KB/10KB)		
R2	7210002970	VAR RV-314 (RK0972210 10KB/10KB)		
R3	7030003520	S.RES ERJ3GEYJ 472 V (4.7 k)	T	22.7/61.5
R4	7030003520	S.RES ERJ3GEYJ 472 V (4.7 k)	T	18.2/61.5
R5	7030003520	S.RES ERJ3GEYJ 472 V (4.7 k)	T	24.2/39
R6	7030003520	S.RES ERJ3GEYJ 472 V (4.7 k)	T	19.5/39
R101	7030003860	S.RES ERJ3GE JPW V	T	8.8/56.1
R102	7030003860	S.RES ERJ3GE JPW V	T	4.6/56.1
R103	7030003860	S.RES ERJ3GE JPW V	T	3.3/56
R104	7030003860	S.RES ERJ3GE JPW V	T	9.4/9
R105	7030003860	S.RES ERJ3GE JPW V	T	8.2/9
R106	7030003860	S.RES ERJ3GE JPW V	T	6.2/9
R107	7030003860	S.RES ERJ3GE JPW V	T	4.2/8.1
R108	7030003860	S.RES ERJ3GE JPW V	T	12/23.5
C1	4030006880	S.CER C1608 JB 1H 472K-T	T	20.7/39
C2	4030006880	S.CER C1608 JB 1H 472K-T	T	23/39
C3	4030006880	S.CER C1608 JB 1H 472K-T	T	19.5/61.5
C4	4030006880	S.CER C1608 JB 1H 472K-T	T	21.5/61.5
J103	6510019971	S.CNR 52808-1071	T	9.5/60.6
J104	6510020711	S.CNR 52793-1070 (1090)	T	9.7/2.4
J106	6510019981	S.CNR 52808-1671 (1690)	T	4.8/40.9
J107	6510025270	S.CNR S6B-PH-SM4-TB (LF) (SN)	T	3.7/18.5
EP107	6910012350	S.BEA MMZ1608Y 102BT	T	13.1/56.1
EP108	6910012350	S.BEA MMZ1608Y 102BT	T	14.4/56.1
EP111	6910012350	S.BEA MMZ1608Y 102BT	T	10.1/56.1
EP112	6910012350	S.BEA MMZ1608Y 102BT	T	7.4/56.1
EP113	6910012350	S.BEA MMZ1608Y 102BT	T	6/56.1
EP114	6910012350	S.BEA MMZ1608Y 102BT	T	16.1/39.2
EP115	6910012350	S.BEA MMZ1608Y 102BT	T	16.1/13.5
EP116	6910012350	S.BEA MMZ1608Y 102BT	T	14.8/13.5
EP117	6910012350	S.BEA MMZ1608Y 102BT	T	13.5/13.5
EP118	6910012350	S.BEA MMZ1608Y 102BT	T	12.2/13.5
EP119	6910012350	S.BEA MMZ1608Y 102BT	T	10.9/13.5
EP120	6910012350	S.BEA MMZ1608Y 102BT	T	15.5/21.7
EP121	6910012350	S.BEA MMZ1608Y 102BT	T	15.5/22.9
EP122	6910012350	S.BEA MMZ1608Y 102BT	T	15.5/20.5

[VR-B BOARD]

REF NO.	ORDER NO.	DESCRIPTION	M.	H/V LOCATION
R1	7210002970	VAR RV-314 (RK0972210 10KB/10KB)		
R2	7210002970	VAR RV-314 (RK0972210 10KB/10KB)		
R3	7210002970	VAR RV-314 (RK0972210 10KB/10KB)		
R4	7030003520	S.RES ERJ3GEYJ 472 V (4.7 k)	T	12.7/78
R5	7030003520	S.RES ERJ3GEYJ 472 V (4.7 k)	T	11.3/78
R6	7030003520	S.RES ERJ3GEYJ 472 V (4.7 k)	T	12.7/42.4
R7	7030003520	S.RES ERJ3GEYJ 472 V (4.7 k)	T	11.3/42.4
R8	7030003520	S.RES ERJ3GEYJ 472 V (4.7 k)	T	12.2/14
R9	7030003520	S.RES ERJ3GEYJ 472 V (4.7 k)	T	10.9/14
C1	4030006880	S.CER C1608 JB 1H 472K-T	T	10/42.4
C2	4030006880	S.CER C1608 JB 1H 472K-T	T	12.7/39.7
C3	4030006880	S.CER C1608 JB 1H 472K-T	T	10.1/78
C4	4030006880	S.CER C1608 JB 1H 472K-T	T	13.9/78
C5	4030006880	S.CER C1608 JB 1H 472K-T	T	9.7/14
C6	4030006880	S.CER C1608 JB 1H 472K-T	T	12.2/16.6
J1	6510019971	S.CNR 52808-1071	T	4/42.4

[VR-C BOARD]

REF NO.	ORDER NO.	DESCRIPTION	M.	H/V LOCATION
R1	7210001130	VAR RK097111T005A (10KB)		
R2	7210001130	VAR RK097111T005A (10KB)		
R3	7210001130	VAR RK097111T005A (10KB)		
R4	7210001130	VAR RK097111T005A (10KB)		
R5	7210001130	VAR RK097111T005A (10KB)		
R6	7210001130	VAR RK097111T005A (10KB)		
R7	7210001130	VAR RK097111T005A (10KB)		
R11	7030003520	S.RES ERJ3GEYJ 472 V (4.7 k)	B	139.3/11
R12	7030003520	S.RES ERJ3GEYJ 472 V (4.7 k)	B	117.2/11
R13	7030003520	S.RES ERJ3GEYJ 472 V (4.7 k)	B	95.1/11
R14	7030003520	S.RES ERJ3GEYJ 472 V (4.7 k)	B	74.5/11
R15	7030003520	S.RES ERJ3GEYJ 472 V (4.7 k)	B	8.2/11
R16	7030003520	S.RES ERJ3GEYJ 472 V (4.7 k)	B	30.3/11
R17	7030003520	S.RES ERJ3GEYJ 472 V (4.7 k)	B	52.4/11
C11	4030006880	S.CER C1608 JB 1H 472K-T	B	139.3/9.7
C12	4030006880	S.CER C1608 JB 1H 472K-T	B	117.2/9.7
C13	4030006880	S.CER C1608 JB 1H 472K-T	B	95.1/9.7
C14	4030006880	S.CER C1608 JB 1H 472K-T	B	74.5/9.7
C15	4030006880	S.CER C1608 JB 1H 472K-T	B	8.2/9.7
C16	4030006880	S.CER C1608 JB 1H 472K-T	B	30.3/9.7
C17	4030006880	S.CER C1608 JB 1H 472K-T	B	52.4/9.7
J1	6510019971	S.CNR 52808-1071	B	81.8/5.5

M.=Mounted side (T: Mounted on the Top side B: Mounted on the Bottom side) S.=Surface mount

[SW-A BOARD]

REF NO.	ORDER NO.	DESCRIPTION	M.	H/V LOCATION
R2	7030003400	S.RES ERJ3GEYJ 471 V (470)	B	9.3/83.2
R3	7030003420	S.RES ERJ3GEYJ 681 V (680)	B	8.6/61.5
R4	7030003390	S.RES ERJ3GEYJ 391 V (390)	B	8.6/60.2
R12	7030003400	S.RES ERJ3GEYJ 471 V (470)	B	36.7/81.7
R13	7030003480	S.RES ERJ3GEYJ 222 V (2.2 k)	B	10.8/47
R14	7030003520	S.RES ERJ3GEYJ 472 V (4.7 k)	B	21.2/71
R22	7030003480	S.RES ERJ3GEYJ 222 V (2.2 k)	B	97.7/81.5
R23	7030003520	S.RES ERJ3GEYJ 472 V (4.7 k)	B	99.3/63.3
R24	7030003580	S.RES ERJ3GEYJ 153 V (15 k)	B	99.3/55
R25	7030003480	S.RES ERJ3GEYJ 222 V (2.2 k)	B	99.3/30.1
R26	7030003520	S.RES ERJ3GEYJ 472 V (4.7 k)	B	99.3/19.9
R27	7030003580	S.RES ERJ3GEYJ 153 V (15 k)	B	98.1/19.9
R29	7030003580	S.RES ERJ3GEYJ 153 V (15 k)	B	43/71
R30	7030003400	S.RES ERJ3GEYJ 471 V (470)	B	56.5/81.7
R31	7030003400	S.RES ERJ3GEYJ 471 V (470)	B	76.3/81.7
C2	4030011600	S.CER C1608 JB 1E 104K-T	B	91.2/72.7
C4	4030011600	S.CER C1608 JB 1E 104K-T	B	99.2/71.1
C5	4030011600	S.CER C1608 JB 1E 104K-T	B	90.5/69.9
C9	4030011600	S.CER C1608 JB 1E 104K-T	B	96.8/52.4
J1	6510020081	S.CNR 52808-2071 (2090)	B	95/65.4
DS5	5040002980	S.LED SML-512DW-T86	T	9.5/93.7
DS6	5040002930	S.LED SML-512MW T86	T	9/92.4
DS7	5040002930	S.LED SML-512MW T86	T	9.5/45.3
DS12	5040002930	S.LED SML-512MW T86	T	35.9/76.2
DS15	5040002990	S.LED SML-512UWT86	T	9/62.1
DS16	5040002930	S.LED SML-512MW T86	T	9/60.8
DS17	5040002930	S.LED SML-512MW T86	T	55.7/76.2
DS18	5040002930	S.LED SML-512MW T86	T	75.5/76.2
S1	2260002740	S.SW LS8J2M-T	T	8.3/85.2
S2	2260002740	S.SW LS8J2M-T	T	9.8/70.1
S3	2260002740	S.SW LS8J2M-T	T	8.3/54.7
S4	2260002740	S.SW LS8J2M-T	T	8.3/39.3
S11	2260002740	S.SW LS8J2M-T	T	35.7/70.8
S14	2260002740	S.SW LS8J2M-T	T	100.2/81.3
S15	2260002740	S.SW LS8J2M-T	T	100.2/69.3
S16	2260002740	S.SW LS8J2M-T	T	100.2/57.3
S17	2260002740	S.SW LS8J2M-T	T	100.2/45.3
S18	2260002740	S.SW LS8J2M-T	T	100.2/33.3
S19	2260002740	S.SW LS8J2M-T	T	100.2/21.3
S20	2260002740	S.SW LS8J2M-T	T	100.2/9.3
S21	2260002740	S.SW LS8J2M-T	T	55.5/70.8
S22	2260002740	S.SW LS8J2M-T	T	75.3/70.8

[SW-B BOARD]

REF NO.	ORDER NO.	DESCRIPTION	M.	H/V LOCATION
J1	6510020531	S.CNR 52808-1871	B	117/18.5
S1	2260002740	S.SW LS8J2M-T	T	22.1/22.8
S2	2260002740	S.SW LS8J2M-T	T	44.1/22.8
S3	2260002740	S.SW LS8J2M-T	T	66.1/22.8
S4	2260002740	S.SW LS8J2M-T	T	88.1/22.8
S5	2260002740	S.SW LS8J2M-T	T	110.1/22.8
S6	2260002740	S.SW LS8J2M-T	T	132.1/22.8
S7	2260002740	S.SW LS8J2M-T	T	154.1/22.8
S8	2260002740	S.SW LS8J2M-T	T	22.1/13.9
S9	2260002740	S.SW LS8J2M-T	T	44.1/13.9
S10	2260002740	S.SW LS8J2M-T	T	66.1/13.9
S11	2260002740	S.SW LS8J2M-T	T	88.1/13.9
S12	2260002740	S.SW LS8J2M-T	T	110.1/13.9
S13	2260002740	S.SW LS8J2M-T	T	132.1/13.9
S14	2260002740	S.SW LS8J2M-T	T	154.1/13.9
S15	2260002740	S.SW LS8J2M-T	T	146.3/2.3
S16	2260002740	S.SW LS8J2M-T	T	158.1/2.3
S17	2260002740	S.SW LS8J2M-T	T	175.6/4.5

[JACK BOARD]

REF NO.	ORDER NO.	DESCRIPTION	M.	H/V LOCATION
L4	6180000900	COL LAL 03NA 101K		
L5	6180000900	COL LAL 03NA 101K		
L6	6180000900	COL LAL 03NA 101K		
L101	6180000900	COL LAL 03NA 101K		
L102	6180000900	COL LAL 03NA 101K		
L103	6180000900	COL LAL 03NA 101K		
R1	7030006240	S.RES ERJ12YJ181U (180)	B	5.8/30.9
R2	7030006240	S.RES ERJ12YJ181U (180)	B	6.1/21.8
C1	4030006880	S.CER C1608 JB 1H 472K-T	T	18.9/41.2
C2	4030006880	S.CER C1608 JB 1H 472K-T	T	3.3/36.9
C101	4030006880	S.CER C1608 JB 1H 472K-T	B	3/19
C102	4030006880	S.CER C1608 JB 1H 472K-T	T	6.9/19
J1	6510020711	S.CNR 52793-1070 (1090)	T	9.2/42.6
J2	6510023891	CNR S-G4617#01F		
J102	6510023900	CNR LGR4619-7000		
EP1	6910014690	S.BEA MPZ1608S221A-T	B	27.5/30.8
EP2	6910014690	S.BEA MPZ1608S221A-T	B	4.3/28.4
EP3	6910014690	S.BEA MPZ1608S221A-T	B	4/24.3
EP101	6910012350	S.BEA MMZ1608Y 102BT	T	3/16.4
EP102	6910012350	S.BEA MMZ1608Y 102BT	T	6.9/16.4

[MIC BOARD]

REF NO.	ORDER NO.	DESCRIPTION	M.	H/V LOCATION
L1	6200003261	S.COL NLV32T-101J	B	4.5/17.8
L2	6200003261	S.COL NLV32T-101J	B	2.4/12.5
L3	6200003261	S.COL NLV32T-101J	B	4.5/2
C1	4030006880	S.CER C1608 JB 1H 472K-T	B	8.6/16.1
C2	4030006880	S.CER C1608 JB 1H 472K-T	B	2.8/5.5
C3	4030006880	S.CER C1608 JB 1H 472K-T	B	14.2/12.4
C4	4030007130	S.CER C1608 CH 1H 101J-T	B	10.1/11.2
C5	4030006880	S.CER C1608 JB 1H 472K-T	B	1.5/5.5
C6	4030006880	S.CER C1608 JB 1H 472K-T	B	9.6/9
C7	4030006880	S.CER C1608 JB 1H 472K-T	B	7.7/10.1
C8	4030007090	S.CER C1608 CH 1H 470J-T	B	9.4/13.9
J1	6510000191	CNR FM214-8SS (P) -1		
J2	6510019971	S.CNR 52808-1071	B	12.7/20.2
EP2	6910012350	S.BEA MMZ1608Y 102BT	B	4.1/6.3
EP3	6910012350	S.BEA MMZ1608Y 102BT	B	7.6/2
EP4	6910012350	S.BEA MMZ1608Y 102BT	B	10.5/16
EP5	6910012350	S.BEA MMZ1608Y 102BT	B	2.7/8.1
EP6	6910012350	S.BEA MMZ1608Y 102BT	B	7.7/7.7
EP7	6910015130	S.BEA MMZ1608D 301BT	B	17.2/10.8
EP8	6910015130	S.BEA MMZ1608D 301BT	B	15.9/10.8
EP9	6910015130	S.BEA MMZ1608D 301BT	B	10.2/6.9
EP10	6910015130	S.BEA MMZ1608D 301BT	B	11.5/9.1
EP11	6910012350	S.BEA MMZ1608Y 102BT	B	5.4/14.1
EP12	6910014690	S.BEA MPZ1608S221A-T	B	15.2/15

M.=Mounted side (T: Mounted on the Top side B: Mounted on the Bottom side)
S.=Surface mount

[USB BOARD]

REF NO.	ORDER NO.	DESCRIPTION	M.	H/V LOCATION
R1	7030003380	S.RES ERJ3GEYJ 331 V (330)	B	52/36.1
R2	7030003380	S.RES ERJ3GEYJ 331 V (330)	B	46.2/36.1
R3	7030003380	S.RES ERJ3GEYJ 331 V (330)	B	28/36.1
R4	7030003450	S.RES ERJ3GEYJ 122 V (1.2 k)	B	22.5/28.2
R5	7030003580	S.RES ERJ3GEYJ 153 V (15 k)	B	47.4/30.6
R6	7030003520	S.RES ERJ3GEYJ 472 V (4.7 k)	B	32.7/30.6
R7	7030003480	S.RES ERJ3GEYJ 222 V (2.2 k)	B	22.7/22.3
R103	7030003860	S.RES ERJ3GE JPW V	B	12.8/23.5
R104	7030003860	S.RES ERJ3GE JPW V	B	11.5/23.5
R113	7030003860	S.RES ERJ3GE JPW V	B	11.6/12.2
R114	7030003860	S.RES ERJ3GE JPW V	B	12.8/12.2
C1	4030011600	S.CER C1608 JB 1E 104K-T	B	33.4/25
J106	6510019971	S.CNR 52808-1071	B	27.2/22.5
J107	6510026080	CNR XM7A-0441		
J108	6510026080	CNR XM7A-0441		
J109	6510022031	S.CNR B10B-ZR-SM4-TF (LF) (SN)	B	2.6/27.8
DS8	5040002930	S.LED SML-512MW T86	T	12.4/36.1
DS9	5040002930	S.LED SML-512MW T86	T	39.1/36.1
DS10	5040002930	S.LED SML-512MW T86	T	58.6/36.1
DS11	5040002990	S.LED SML-512UWT86	T	12.4/23.8
S1	2260002740	S.SW LS8J2M-T	T	58.9/31.5
S2	2260002740	S.SW LS8J2M-T	T	38.9/31.5
S3	2260002740	S.SW LS8J2M-T	T	12.2/31.5
EP102	6910014730	S.BEA MPZ2012S331A-T	B	10/23.5
EP105	6910014730	S.BEA MPZ2012S331A-T	B	14.4/23.5
EP112	6910014730	S.BEA MPZ2012S331A-T	B	10/12.2
EP115	6910014730	S.BEA MPZ2012S331A-T	B	14.4/12.2

[TENKEY BOARD]

REF NO.	ORDER NO.	DESCRIPTION	M.	H/V LOCATION
IC1	1130011510	S.IC BU2099FV-E2	B	23.2/113.2
R1	7030003480	S.RES ERJ3GEYJ 222 V (2.2 k)	B	14.9/121.7
R2	7030003520	S.RES ERJ3GEYJ 472 V (4.7 k)	B	15.9/112
R3	7030003580	S.RES ERJ3GEYJ 153 V (15 k)	B	16/101.9
R4	7030003540	S.RES ERJ3GEYJ 682 V (6.8 k)	B	16.1/121.7
R5	7030003480	S.RES ERJ3GEYJ 222 V (2.2 k)	B	31.5/121.7
R6	7030003520	S.RES ERJ3GEYJ 472 V (4.7 k)	B	32.7/112.2
R7	7030003580	S.RES ERJ3GEYJ 153 V (15 k)	B	32.7/102.7
R8	7030003540	S.RES ERJ3GEYJ 682 V (6.8 k)	B	30.3/121.7
R9	7030003480	S.RES ERJ3GEYJ 222 V (2.2 k)	B	53/121.7
R10	7030003520	S.RES ERJ3GEYJ 472 V (4.7 k)	B	54.2/112.2
R11	7030003580	S.RES ERJ3GEYJ 153 V (15 k)	B	54.2/102.7
R12	7030003540	S.RES ERJ3GEYJ 682 V (6.8 k)	B	51.8/121.7
R51	7030003540	S.RES ERJ3GEYJ 682 V (6.8 k)	B	85.7/117.8
R52	7030003420	S.RES ERJ3GEYJ 681 V (680)	B	88.2/116.7
R53	7030003480	S.RES ERJ3GEYJ 222 V (2.2 k)	B	86.5/112
R54	7030003520	S.RES ERJ3GEYJ 472 V (4.7 k)	B	86.2/92.3
R55	7030003420	S.RES ERJ3GEYJ 681 V (680)	B	91/95.1
R56	7030003420	S.RES ERJ3GEYJ 681 V (680)	B	91/85.6
R57	7030003580	S.RES ERJ3GEYJ 153 V (15 k)	B	86.2/82.7
R58	7030003540	S.RES ERJ3GEYJ 682 V (6.8 k)	B	84.6/73.3
R59	7030003420	S.RES ERJ3GEYJ 681 V (680)	B	91/76.1
R60	7030003480	S.RES ERJ3GEYJ 222 V (2.2 k)	B	84.6/60.1
R61	7030003520	S.RES ERJ3GEYJ 472 V (4.7 k)	B	84.6/47.4
R62	7030003580	S.RES ERJ3GEYJ 153 V (15 k)	B	84.6/41.7
R63	7030003540	S.RES ERJ3GEYJ 682 V (6.8 k)	B	85.7/24
R65	7030003480	S.RES ERJ3GEYJ 222 V (2.2 k)	B	85.7/10
R66	7030003520	S.RES ERJ3GEYJ 472 V (4.7 k)	B	75.4/6.6
C1	4030011600	S.CER C1608 JB 1E 104K-T	B	13.7/121.7
C2	4030011600	S.CER C1608 JB 1E 104K-T	B	32.7/121.7
C3	4030011600	S.CER C1608 JB 1E 104K-T	B	54.3/121.7
C4	4030011600	S.CER C1608 JB 1E 104K-T	B	25.4/109
C51	4030011600	S.CER C1608 JB 1E 104K-T	B	87/10
C52	4030011600	S.CER C1608 JB 1E 104K-T	B	85.8/60.1
C53	4030011600	S.CER C1608 JB 1E 104K-T	B	87.2/119.2
J1	6510022471	S.CNR 40FLT-SM2-TB (LF) (SN)	B	9/93.8
J4	6510019971	S.CNR 52808-1071	B	98/101
J5	6510019971	S.CNR 52808-1071	B	6.5/120.5
J7	6510018971	S.CNR B4B-PH-SM4-TB (LF) (SN)	B	93.7/53.6
J8	6510019971	S.CNR 52808-1071	B	97.7/12.5
DS51	5040002930	S.LED SML-512MW T86	T	91/115.6
DS52	5040002930	S.LED SML-512MW T86	T	91/95.1
DS53	5040002930	S.LED SML-512MW T86	T	91/85.6
DS54	5040002930	S.LED SML-512MW T86	T	91/76.1
S1	2260002740	S.SW LS8J2M-T	T	12/86.7
S2	2260002740	S.SW LS8J2M-T	T	12/78.7
S3	2260002740	S.SW LS8J2M-T	T	55.5/78.7
S4	2260002740	S.SW LS8J2M-T	T	34/86.7
S5	2260002740	S.SW LS8J2M-T	T	34/78.7
S6	2260002740	S.SW LS8J2M-T	T	55.5/86.7
S7	2260002740	S.SW LS8J2M-T	T	12/66.3
S8	2260002740	S.SW LS8J2M-T	T	34/67.9
S11	2260002740	S.SW LS8J2M-T	T	12.5/126.6
S12	2260002740	S.SW LS8J2M-T	T	12.5/117.1
S13	2260002740	S.SW LS8J2M-T	T	12.5/107.6
S14	2260002740	S.SW LS8J2M-T	T	12.5/98.1
S15	2260002740	S.SW LS8J2M-T	T	34/126.6
S16	2260002740	S.SW LS8J2M-T	T	34/117.1
S17	2260002740	S.SW LS8J2M-T	T	34/107.6
S18	2260002740	S.SW LS8J2M-T	T	34/98.1
S19	2260002740	S.SW LS8J2M-T	T	55.5/126.6
S20	2260002740	S.SW LS8J2M-T	T	55.5/117.1
S21	2260002740	S.SW LS8J2M-T	T	55.5/107.6
S22	2260002740	S.SW LS8J2M-T	T	55.5/98.1
S23	2260002740	S.SW LS8J2M-T	T	55.5/67.9
S24	2260002740	S.SW LS8J2M-T	T	60.4/56.5
S51	2260002740	S.SW LS8J2M-T	T	90.8/122.7
S52	2260002740	S.SW LS8J2M-T	T	90.8/111.7
S53	2260002740	S.SW LS8J2M-T	T	90.8/91.2
S54	2260002740	S.SW LS8J2M-T	T	90.8/81.7
S55	2260002740	S.SW LS8J2M-T	T	90.8/72.2
S56	2260002740	S.SW LS8J2M-T	T	90.8/55.7
S57	2260002740	S.SW LS8J2M-T	T	90.8/46.2
S58	2260002740	S.SW LS8J2M-T	T	90.8/36.7
S59	2260002740	S.SW LS8J2M-T	T	90.8/22.8
S60	2260002740	S.SW LS8J2M-T	T	90.8/4.4
S61	2260002740	S.SW LS8J2M-T	T	69.7/4.2

M.=Mounted side (T: Mounted on the Top side B: Mounted on the Bottom side)
S.=Surface mount

[PBT BOARD]

REF NO.	ORDER NO.	DESCRIPTION	M.	H/V LOCATION
R1	7210003290	VAR RV-321 (RK0972210C1K 10KB/10KB)		
R2	7030003520	S.RES ERJ3GEYJ 472 V (4.7 k)	T	12.6/12.5
R3	7030003520	S.RES ERJ3GEYJ 472 V (4.7 k)	T	11.4/12.5
C1	4030006880	S.CER C1608 JB 1H 472K-T	T	10.2/12.5
C2	4030006880	S.CER C1608 JB 1H 472K-T	T	13.8/12.5
J1	6510019971	S.CNR 52808-1071	T	7/23
S1	2250000410	ECR TP90D96E20-30F-2178-1		

[PITCH BOARD]

REF NO.	ORDER NO.	DESCRIPTION	M.	H/V LOCATION
R1	7210003170	VAR RV-318 (RK09L1120CON)		
R2	7030003520	S.RES ERJ3GEYJ 472 V (4.7 k)	T	7.8/7.5
C1	4030006880	S.CER C1608 JB 1H 472K-T	T	7.8/4.9
J1	6510019971	S.CNR 52808-1071	T	4.1/7.5

[LED BOARD]

REF NO.	ORDER NO.	DESCRIPTION	M.	H/V LOCATION
R1	7030003450	S.RES ERJ3GEYJ 122 V (1.2 k)	T	124/2.9
R2	7030003420	S.RES ERJ3GEYJ 681 V (680)	T	100/2.9
R3	7030003460	S.RES ERJ3GEYJ 152 V (1.5 k)	T	19.9/2.9
R4	7030003400	S.RES ERJ3GEYJ 471 V (470)	T	59.9/2.9
J1	6510020711	S.CNR 52793-1070 (1090)	T	24/12.2
DS1	5040003000	S.LED SML-A12UT-T86	T	124/1.3
DS2	5040002961	S.LED SML-A12MT T86J	T	100/1.3
DS3	5040003010	S.LED SML-A12WT	T	19.9/1.3
DS4	5040002970	S.LED CL-270WB-D-TS	T	59.9/1.3

M.=Mounted side (T: Mounted on the Top side B: Mounted on the Bottom side)
S.=Surface mount

• SCOPE UNIT (TOP VIEW)

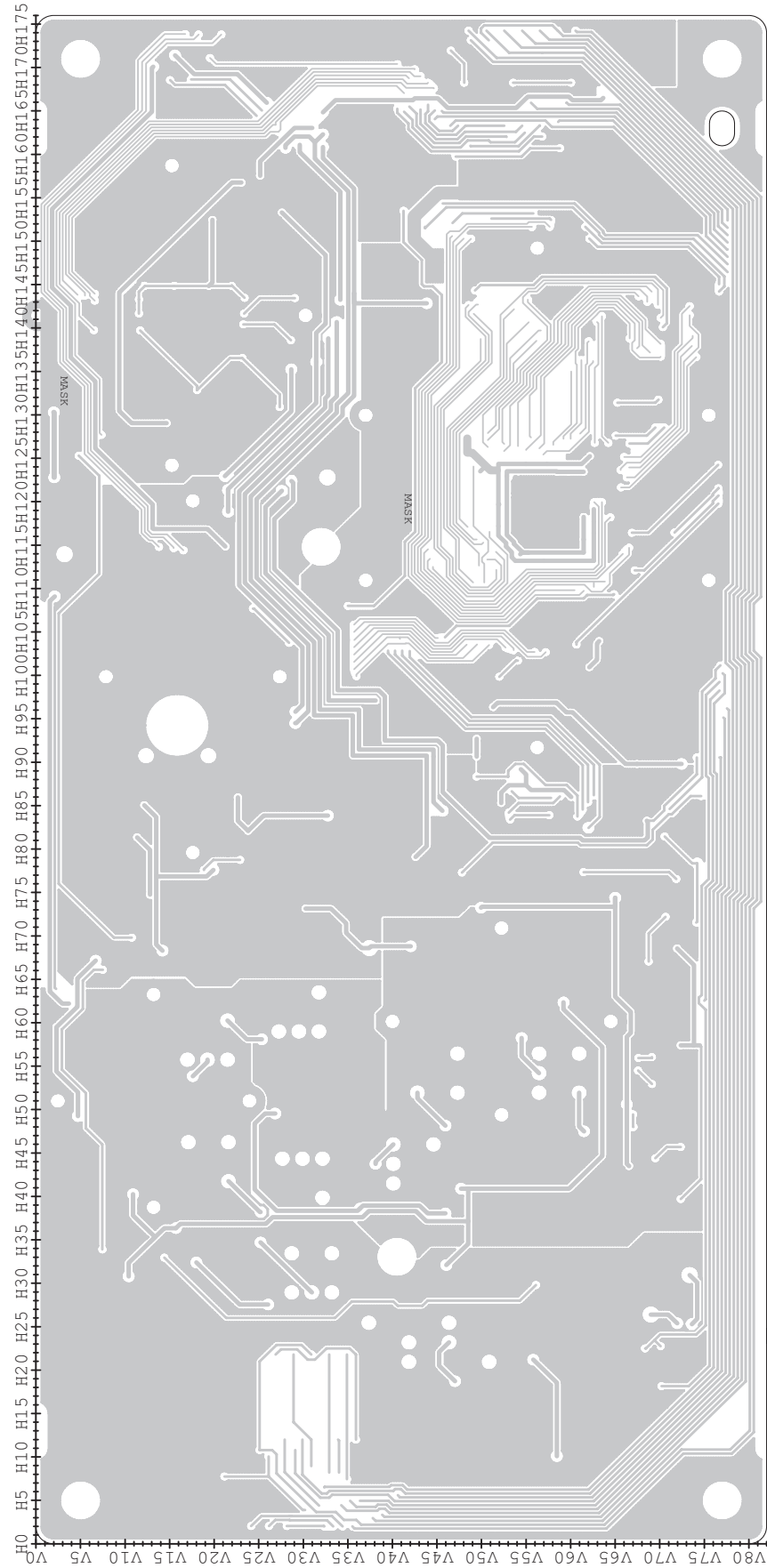

• MAIN UNIT (TOP VIEW)

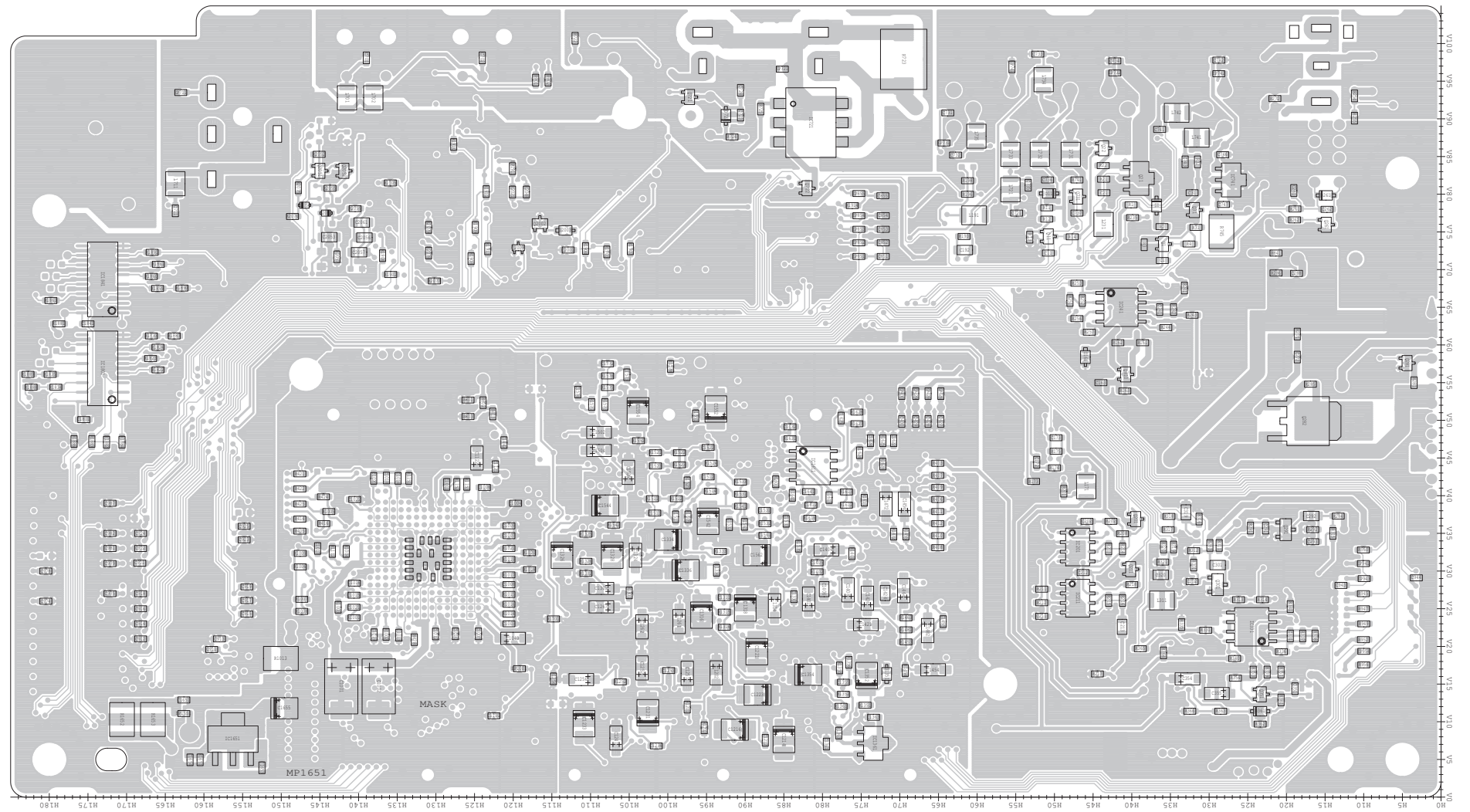

LOGIC UNIT (LOGIC-1)

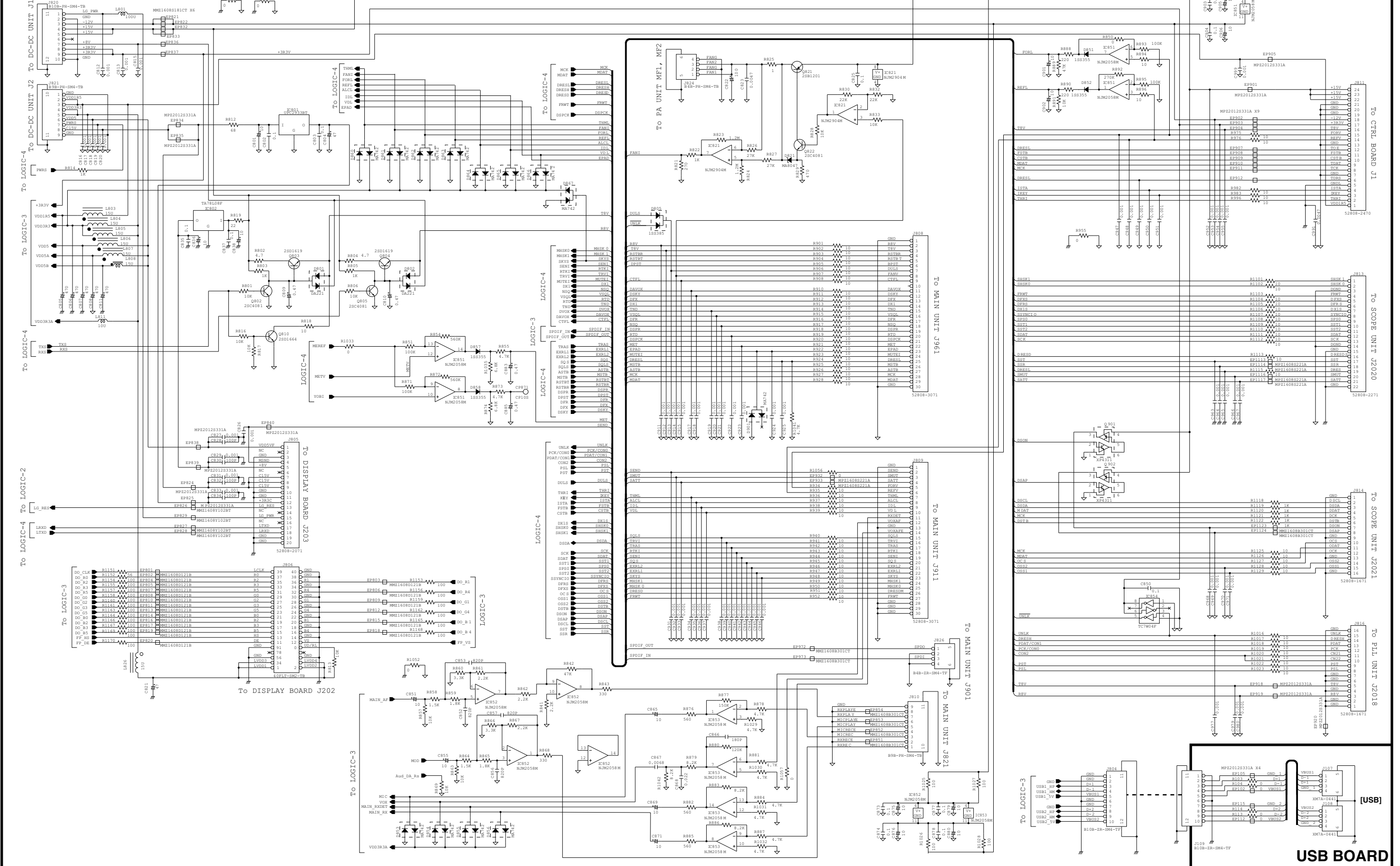

USB BOARD

LOGIC UNIT (LOGIC-5)

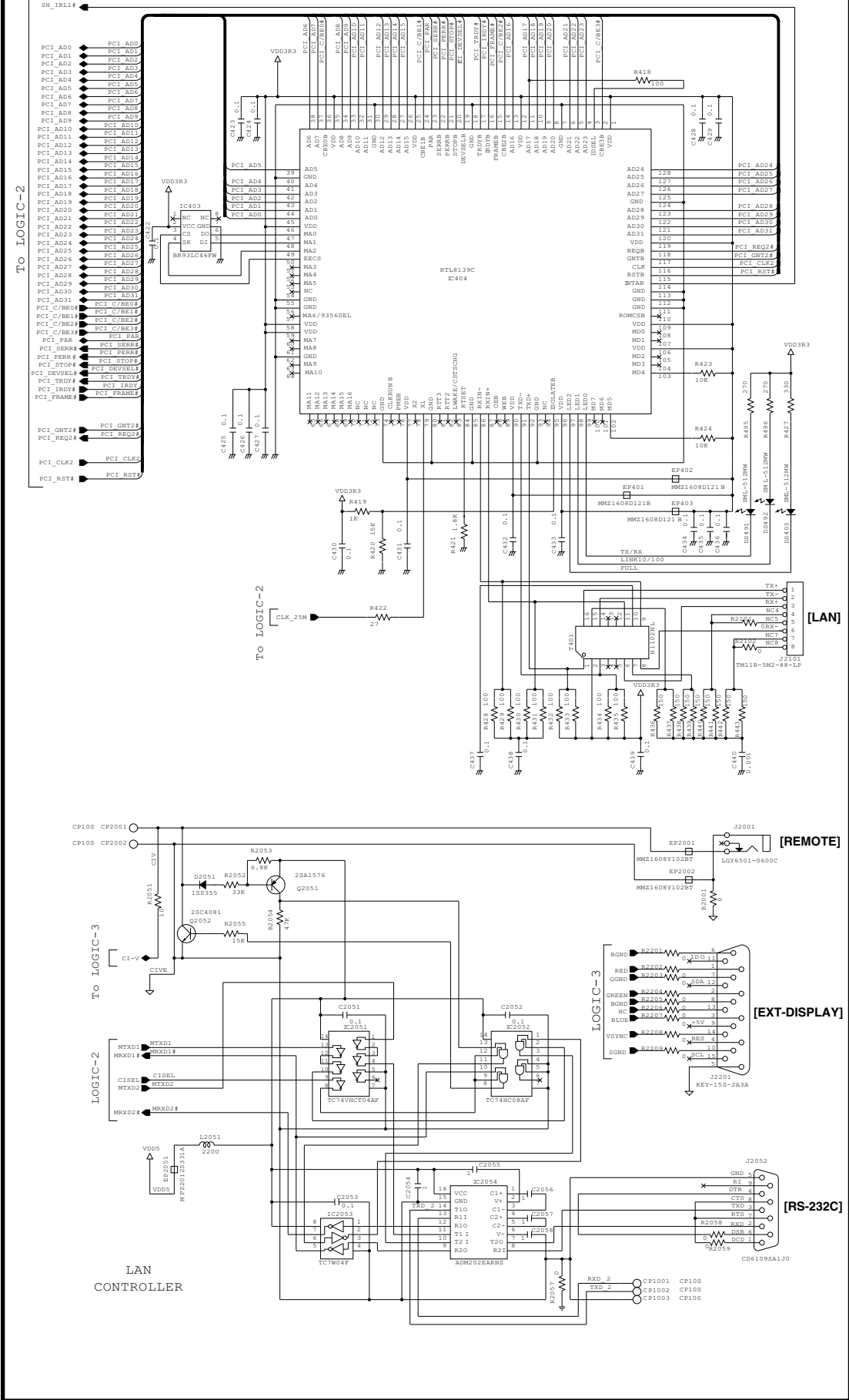

PLL UNIT (PLL-1)

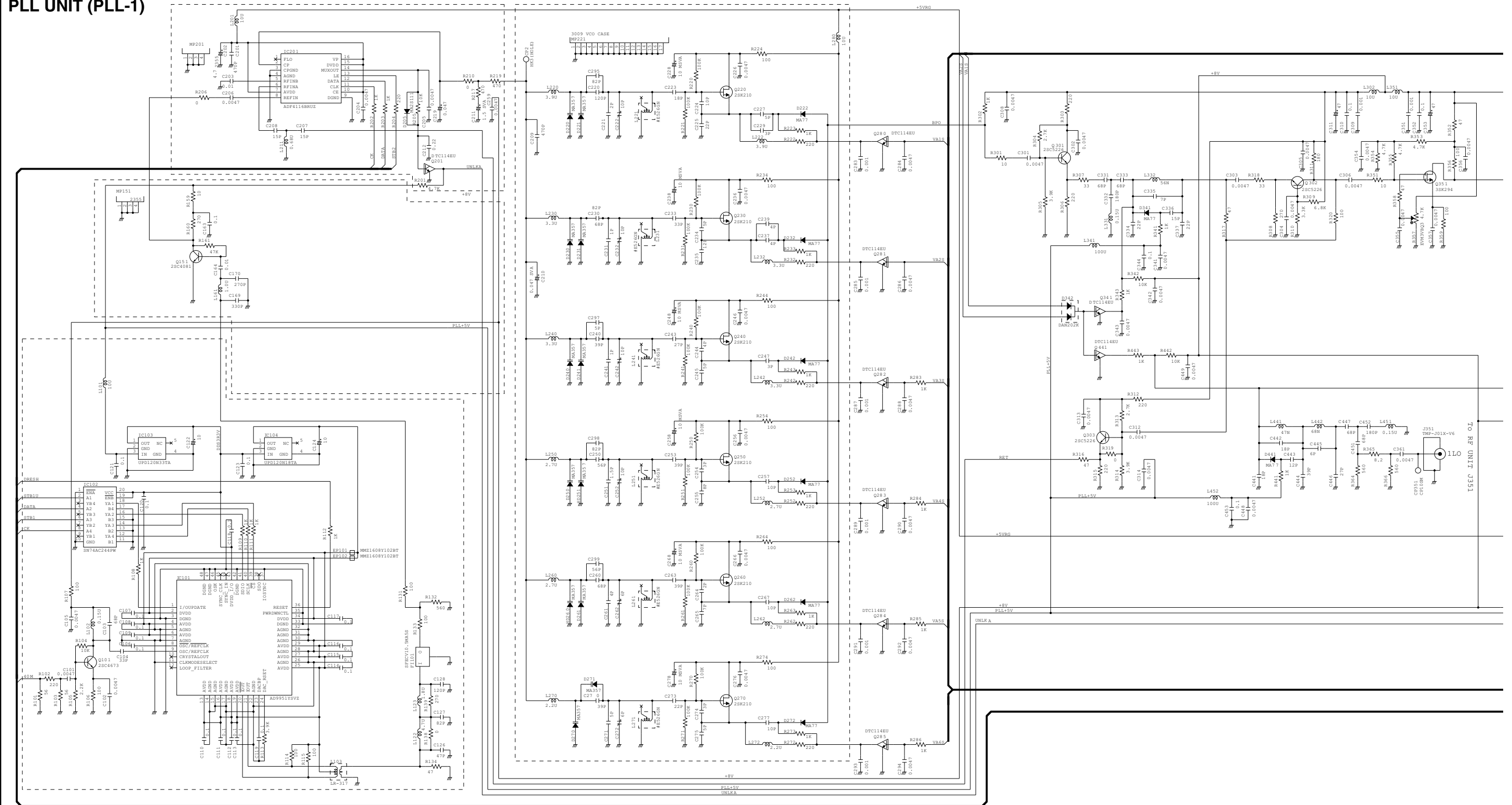

PLL UNIT (PLL-2)

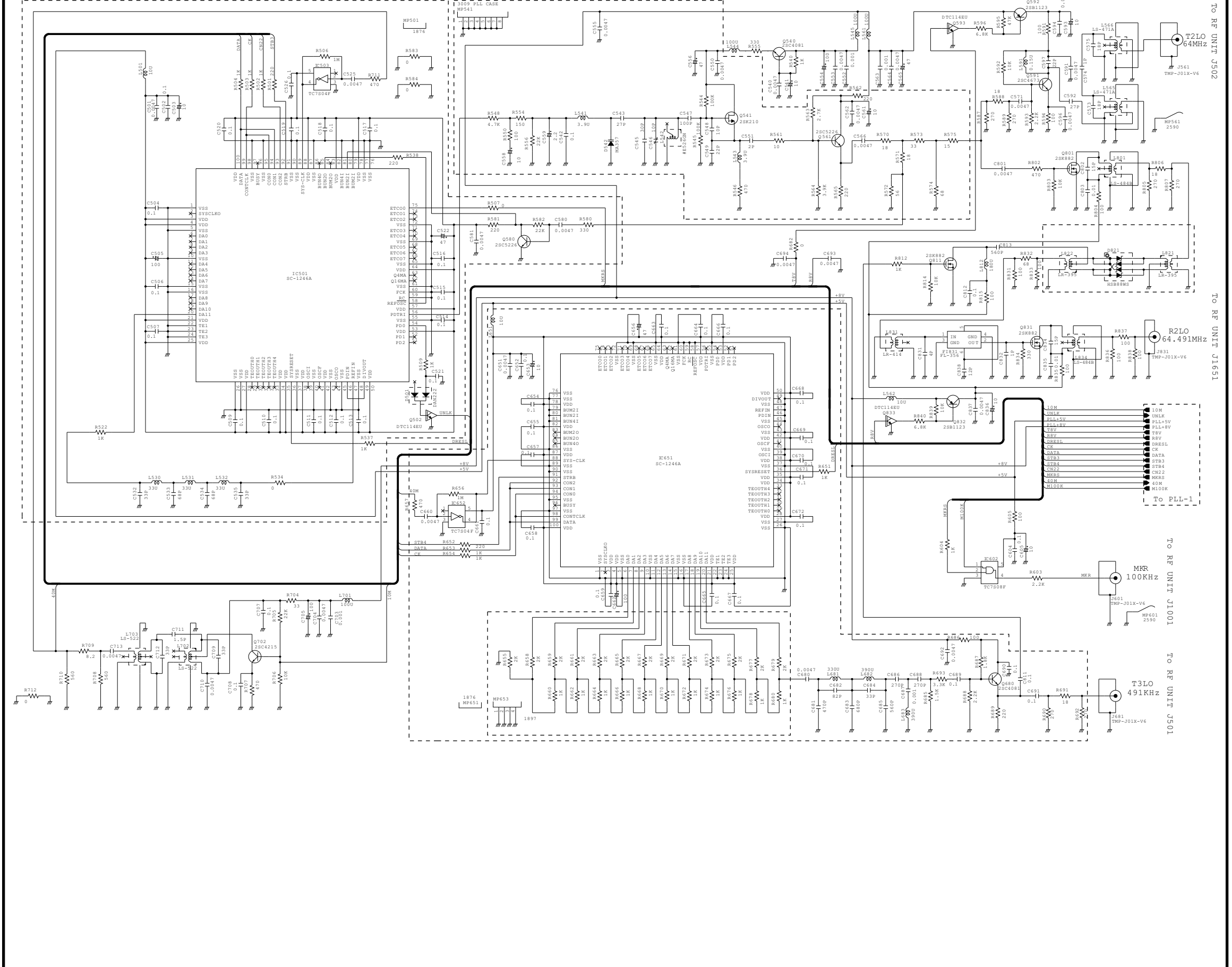

To RF UNIT J502

To RF UNIT J1651

To RF UNIT J1001

To RF UNIT J501

PLL UNIT (PLL-3)

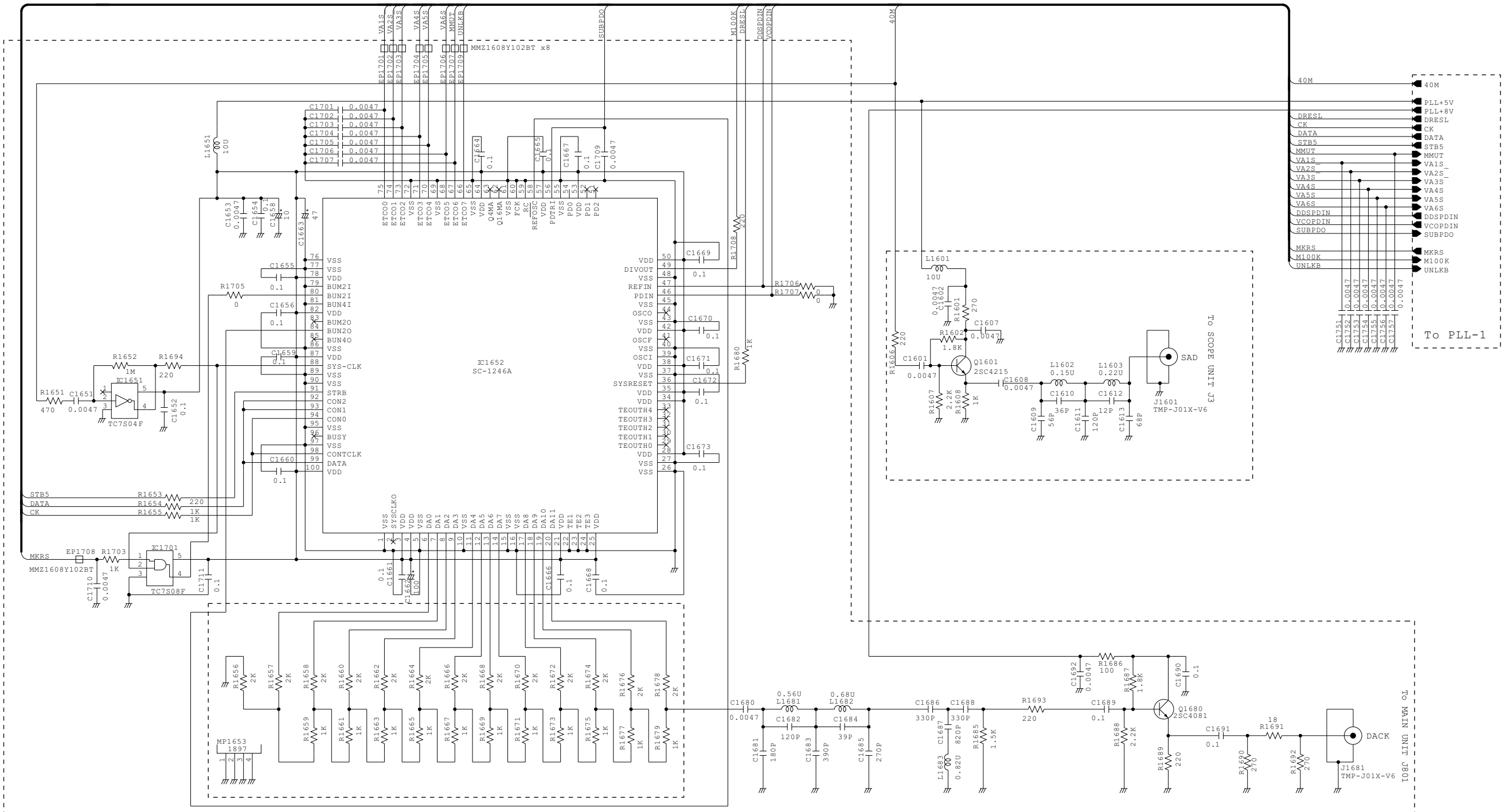

ANT-SW UNIT

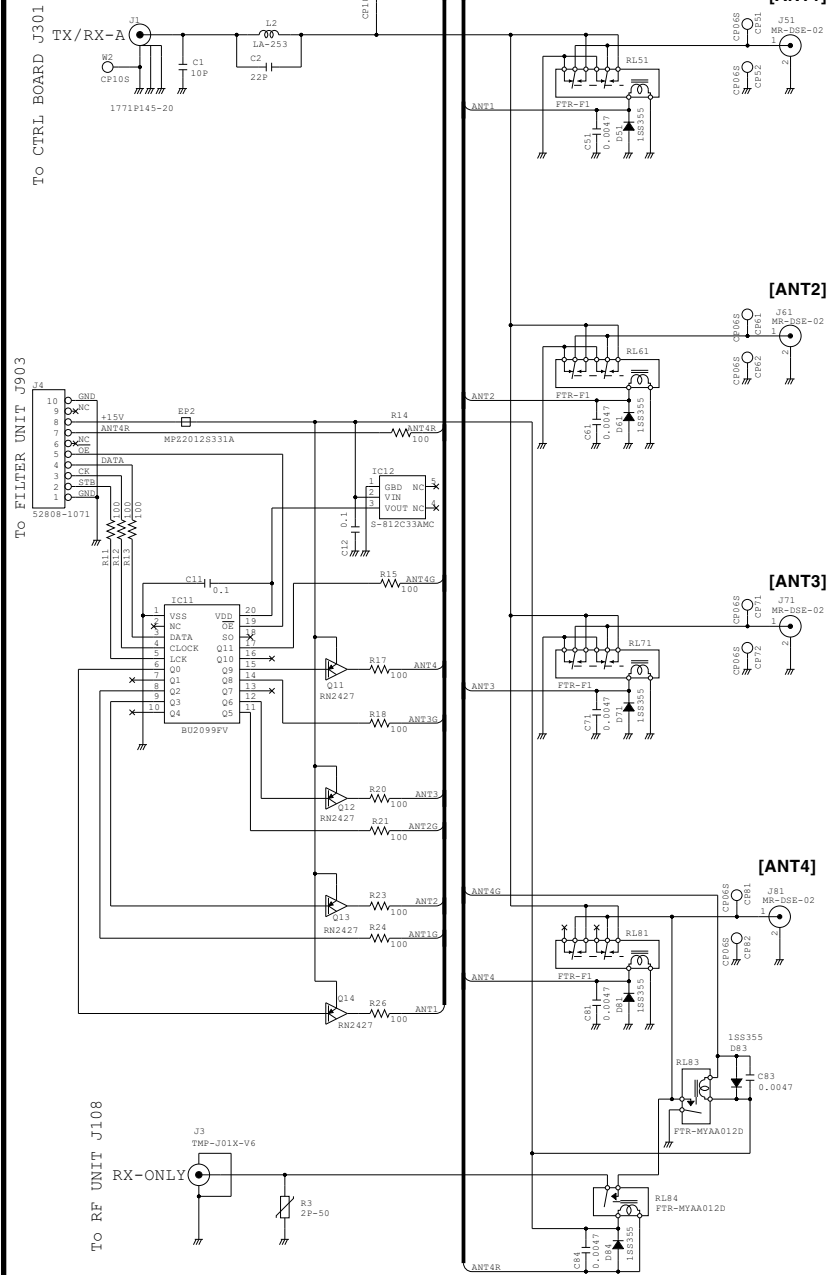

DIGISEL UNIT

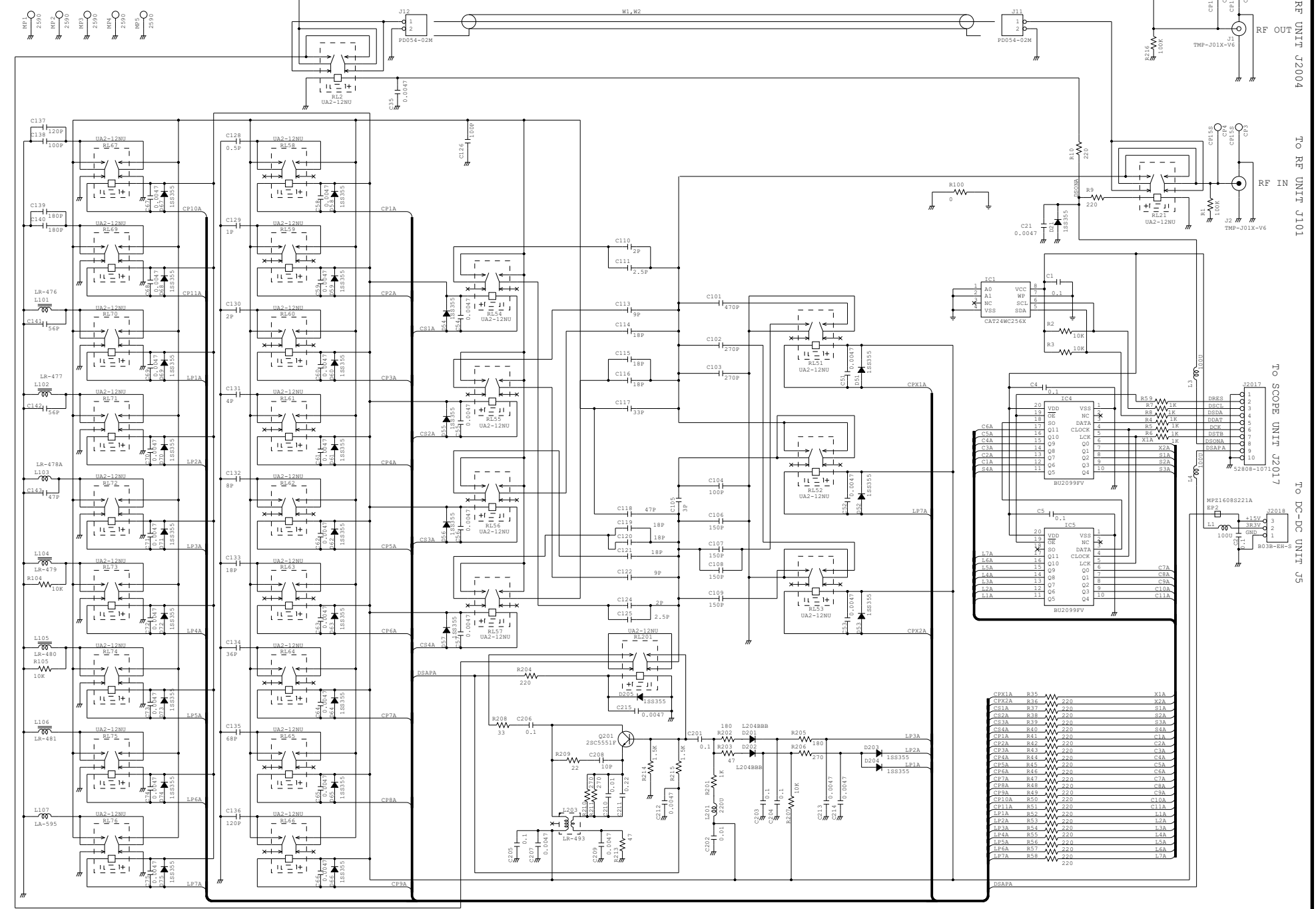

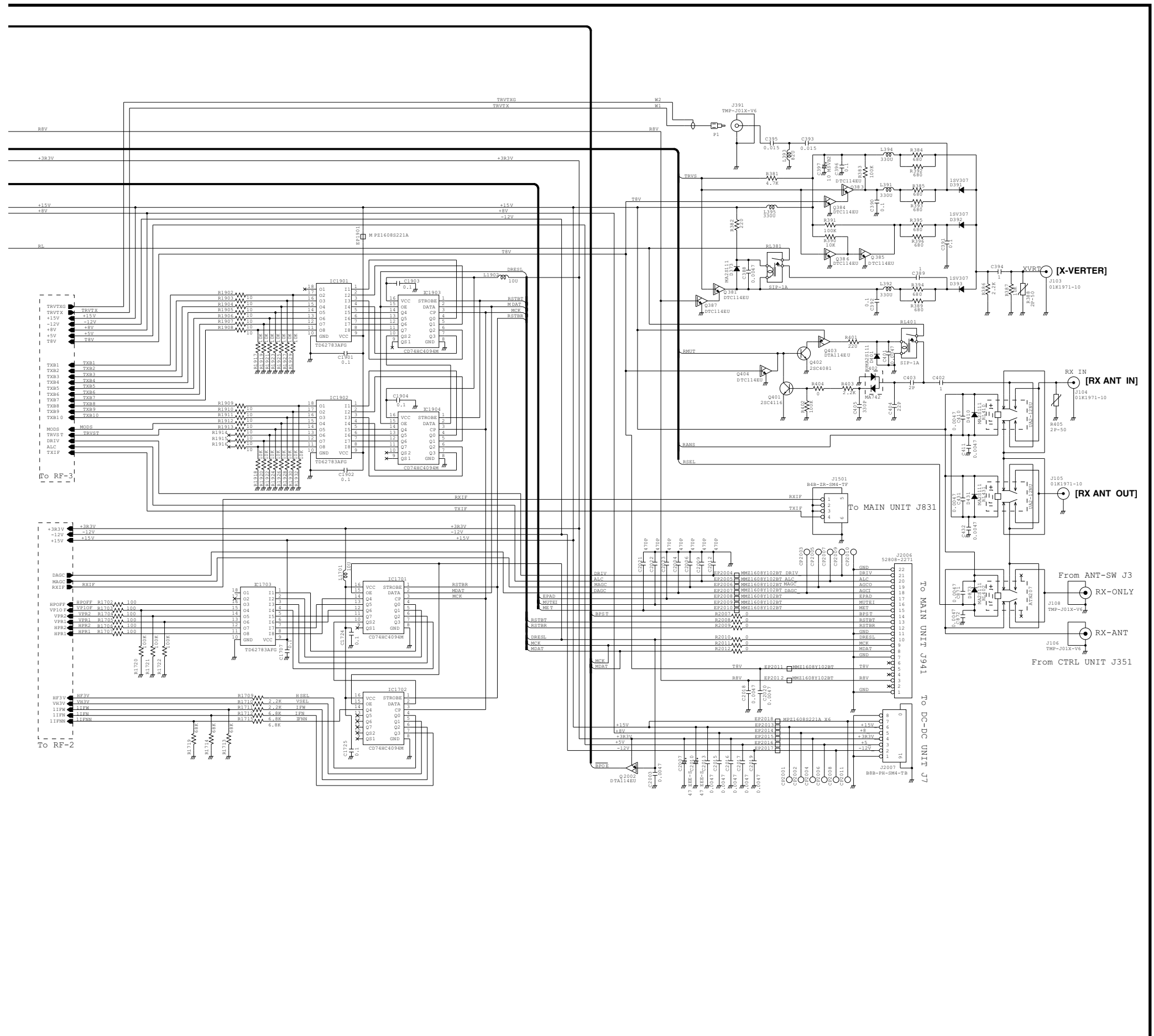

RF UNIT (RF-2)

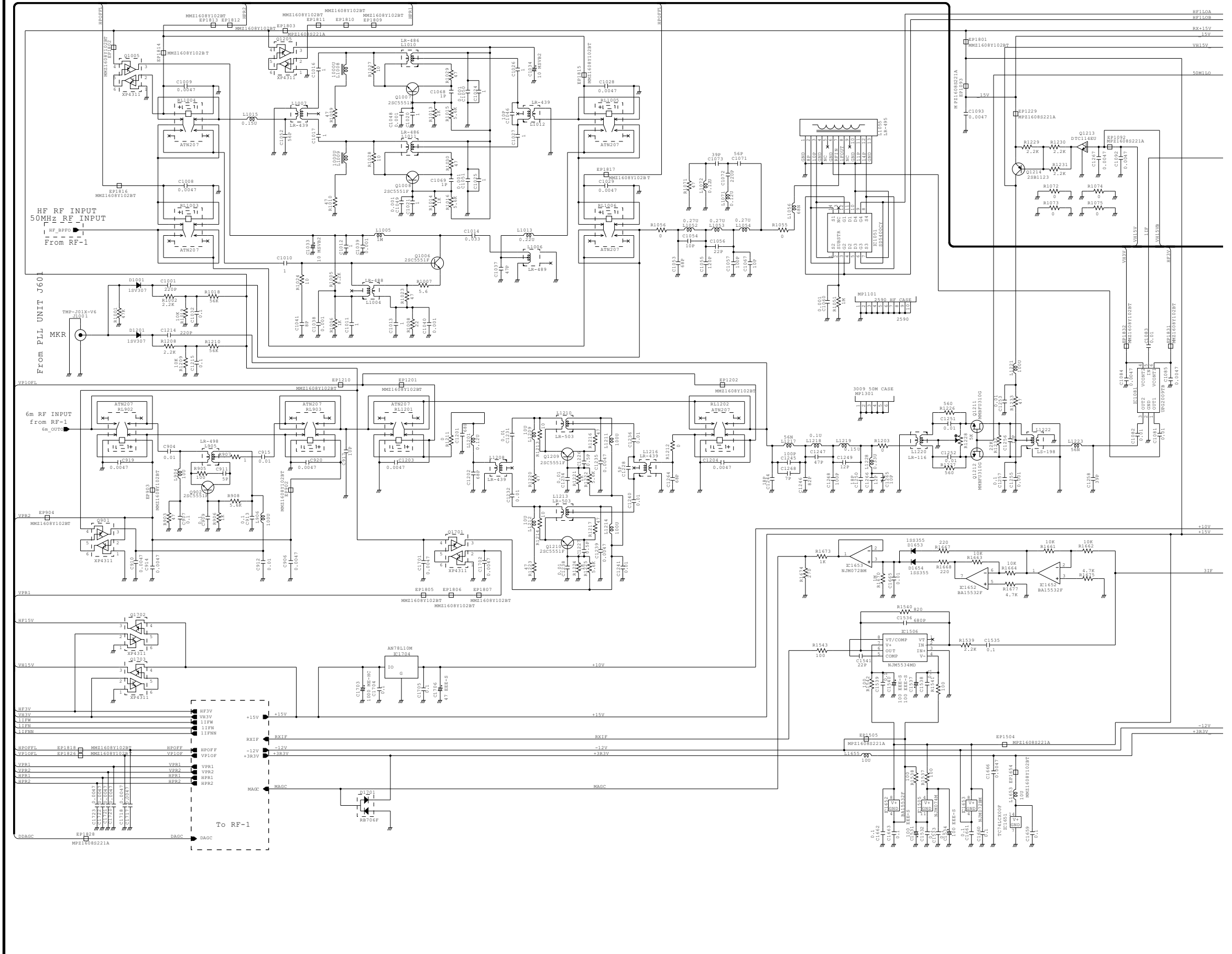

NETWORK BOARD

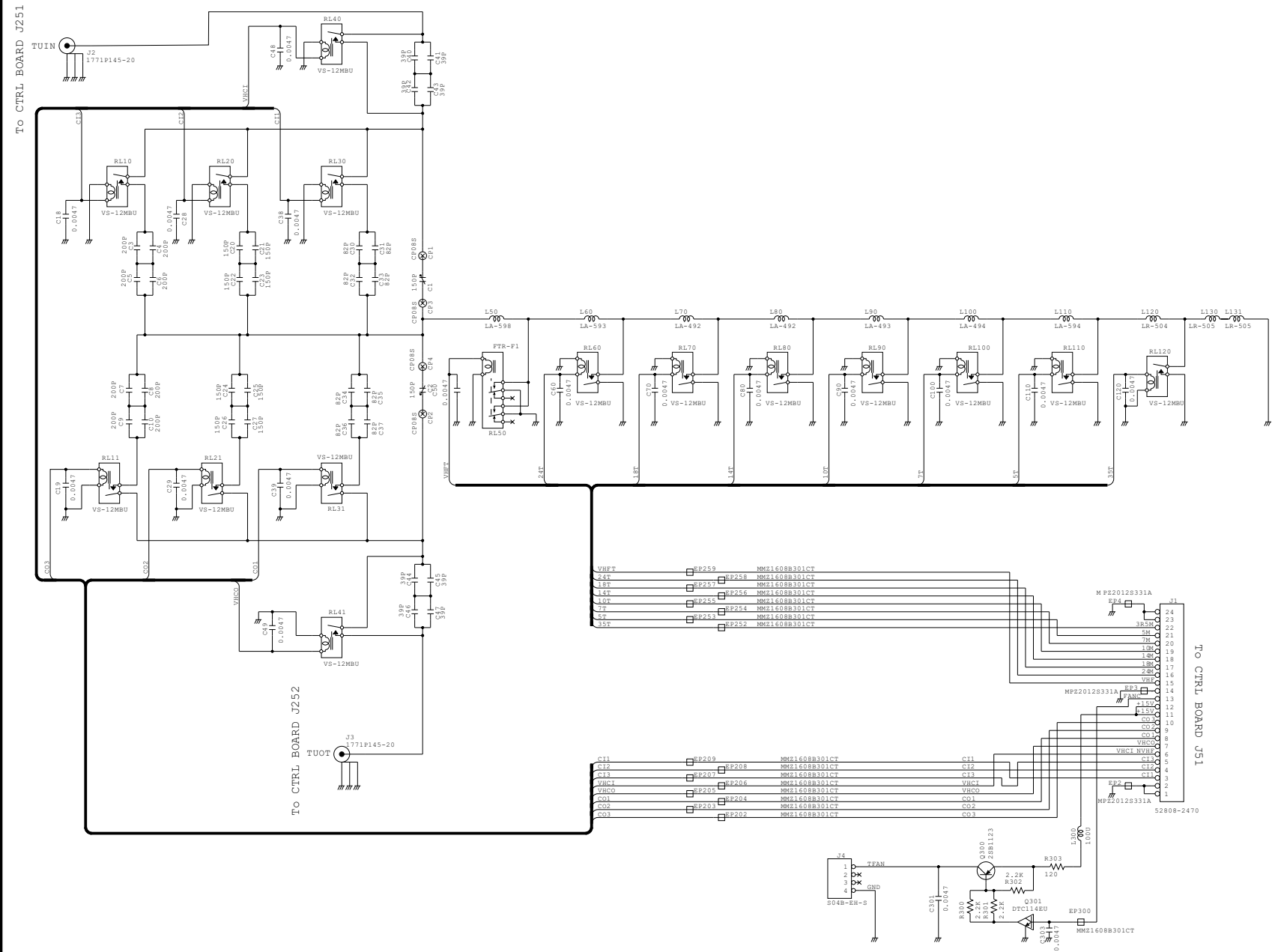

CTRL BOARD

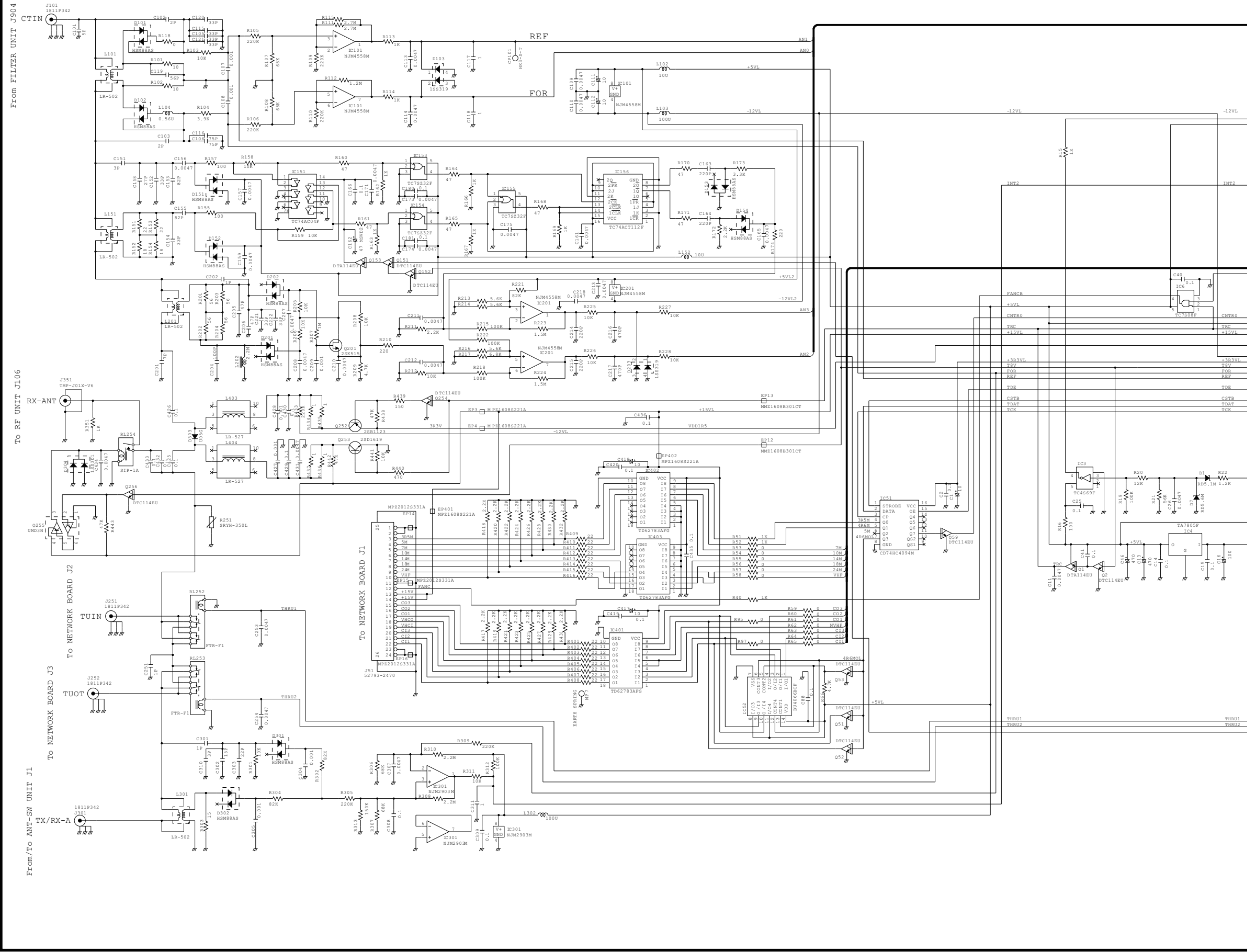

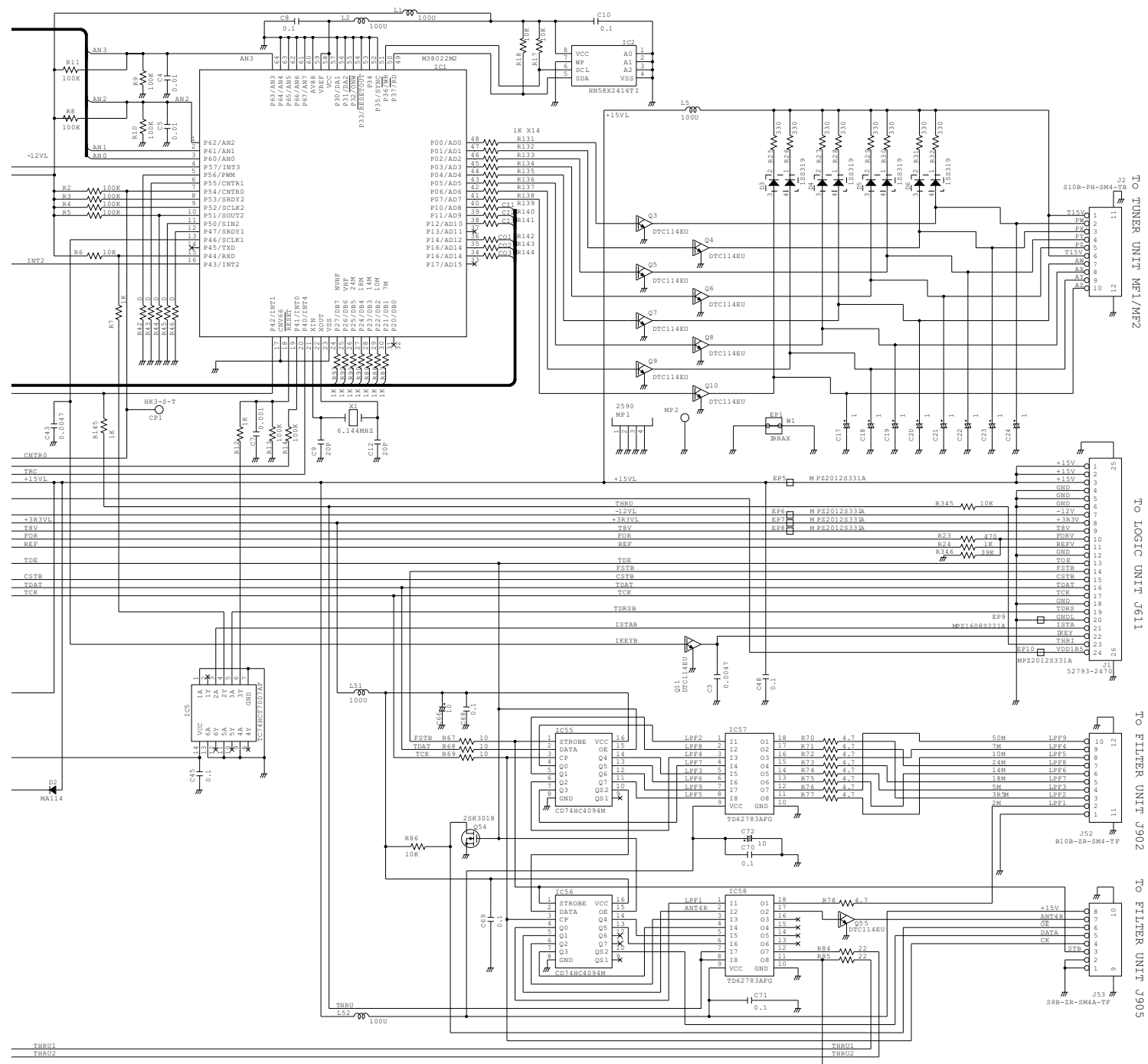

PA200W BOARD

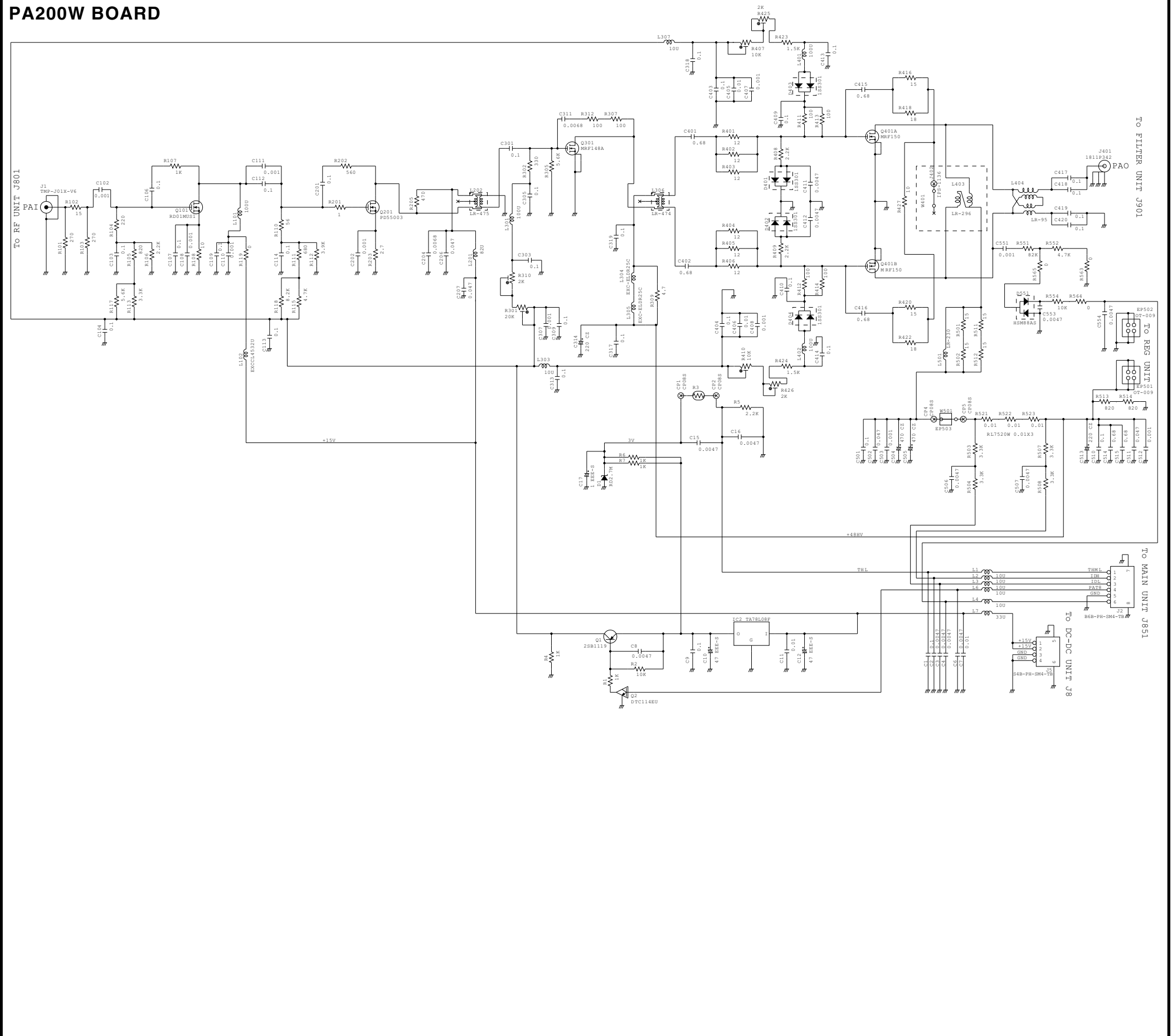

DC-DC UNIT

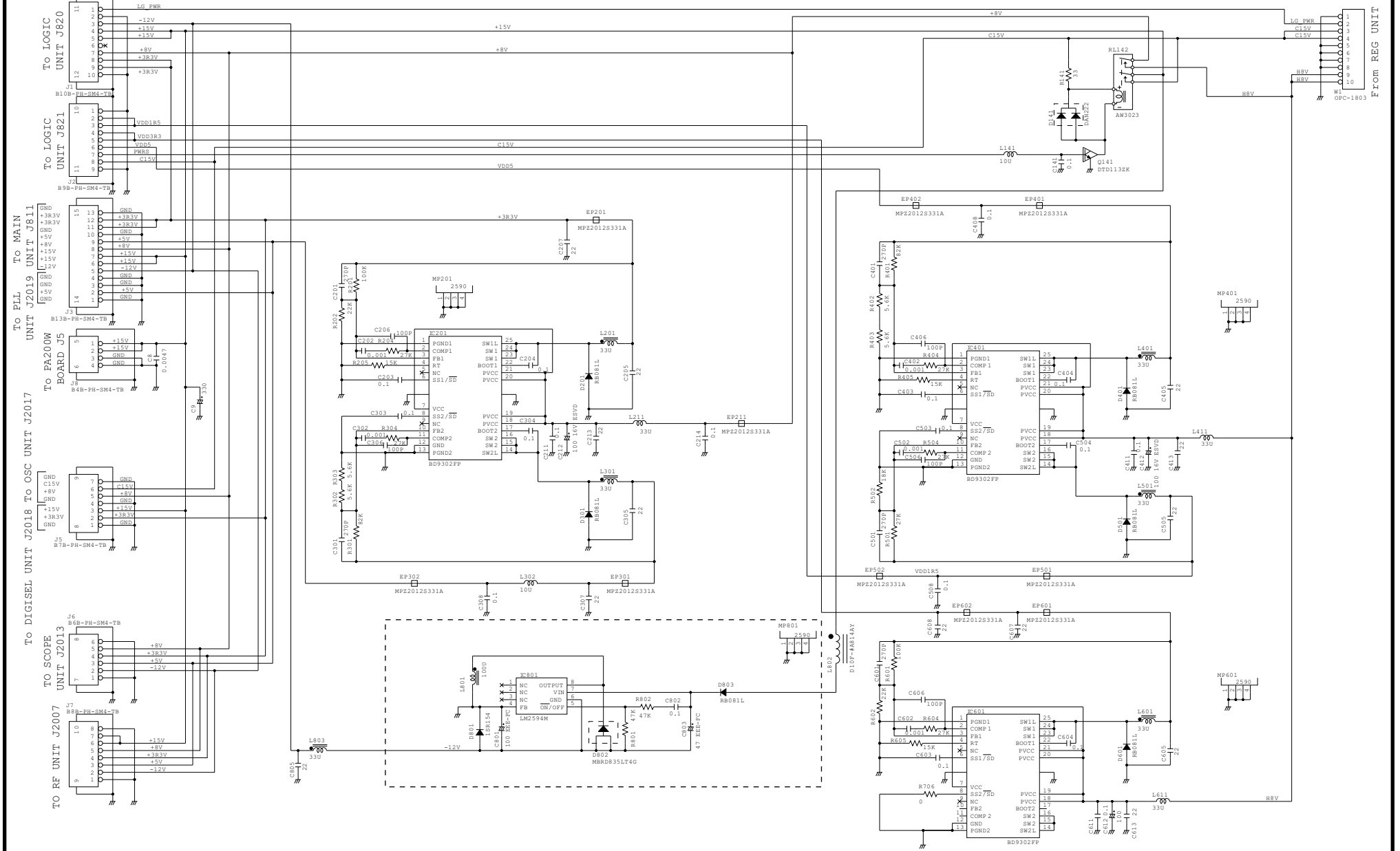

Apr. 2008



SERVICE MANUAL ADDENDUM

IC-7700

CONTENTS

PARTS LIST	1
BOARD LAYOUTS	4
VOLTAGE DIAGRAM	6

[CTRL BOARD]

REF NO.	ORDER NO.	DESCRIPTION	M.	H/V LOCATION
IC1	1140004120	S.IC M38022M2-138FP	T	65.7/81.8
IC2	1130010390	S.IC HN58X2416TI	T	54/86.9
IC3	1130003921	S.IC TC4S69F (TE85R,F)	T	62/59.5
IC4	1180001071	S.IC TA7805F (TE16L,Q)	B	71.5/47.5
IC5	1130009691	S.IC TC74HCT7007AF (F)	B	92.5/91.6
IC6	1130006441	S.IC TC7S08F (TE85R,F)	T	81.7/70.3
IC51	1130011530	S.IC CD74HC4094M96	T	42.2/72.4
IC52	1130007690	S.IC BU4066BCF-E2	B	12.5/76.9
IC55	1130011530	S.IC CD74HC4094M96	B	100.2/76.1
IC56	1130011530	S.IC CD74HC4094M96	B	114.3/76.1
IC57	1160000131	S.IC TD62783AFG (S,EL)	T	99.6/73.1
IC58	1160000131	S.IC TD62783AFG (S,EL)	T	113.7/73.1
IC101	1110000960	S.IC NJM4558M-TE1-#FMZB	T	18.3/47.8
IC151	1120002301	S.IC TC74AC04F (F)	B	32.8/53.1
IC153	1130012011	S.IC TC7S232F (TE85L,F)	T	27.8/48.6
IC154	1130012011	S.IC TC7S232F (TE85L,F)	T	40.4/48.6
IC155	1130012011	S.IC TC7S232F (TE85L,F)	T	34.2/51.9
IC156	1130012021	S.IC TC74ACT112F (EL,F)	T	35.4/58.9
IC201	1110000960	S.IC NJM4558M-TE1-#FMZB	B	61.3/58.2
IC301	1110002690	S.IC NJM2903M-TE1-#FMZB	T	80/59
IC401	1160000131	S.IC TD62783AFG (S,EL)	T	13.6/86.1
IC402	1160000131	S.IC TD62783AFG (S,EL)	T	31.6/84.7
IC403	1160000131	S.IC TD62783AFG (S,EL)	B	24.7/88
Q1	1590001330	S.TR DTA114EUA T106	T	78.5/75.2
Q2	1590000680	S.TR DTC114EUA T106	T	77.8/71.2
Q3	1590000680	S.TR DTC114EUA T106	T	128.4/74.5
Q4	1590000680	S.TR DTC114EUA T106	T	128.4/77
Q5	1590000680	S.TR DTC114EUA T106	T	128.4/81.3
Q6	1590000680	S.TR DTC114EUA T106	T	128.4/83.8
Q7	1590000680	S.TR DTC114EUA T106	T	128.4/88.5
Q8	1590000680	S.TR DTC114EUA T106	T	128.4/91
Q9	1590000680	S.TR DTC114EUA T106	T	128.4/95.7
Q10	1590000680	S.TR DTC114EUA T106	T	128.4/100.5
Q11	1590000680	S.TR DTC114EUA T106	B	85.7/99.8
Q51	1590000680	S.TR DTC114EUA T106	T	6.1/78.6
Q52	1590000680	S.TR DTC114EUA T106	T	12.5/78.6
Q53	1590000680	S.TR DTC114EUA T106	B	6.6/72.8
Q54	1560001260	S.FET 2SK3018 T106	B	121.8/80.4
Q55	1590000680	S.TR DTC114EUA T106	B	130.2/68.9
Q59	1590000680	S.TR DTC114EUA T106	T	56.8/69.5
Q151	1590000680	S.TR DTC114EUA T106	B	39.8/42.3
Q152	1590000680	S.TR DTC114EUA T106	B	39.8/39.5
Q153	1590001330	S.TR DTA114EUA T106	B	39.8/45.1
Q201	1560000871	S.FET 2SK515-T1B-A (X33)	B	50.4/51.8
Q252	1520000561	S.TR 2SB1123 T-TD-E	T	18.8/6.7
Q253	1540000441	S.TR 2SD1619T-TD-E	B	26.6/6.7
Q254	1590000680	S.TR DTC114EUA T106	T	24.9/5.4
Q255	1590002420	S.TR UMD3N TR	T	97.4/12.1
Q256	1590000680	S.TR DTC114EUA T106	T	101.4/12.4
D1	1730000411	S.ZEN RD5.1M-T2B-A B2	T	69.8/58.7
D2	1710000780	S.DIO MA114 (TX)	T	73.8/58.7
D3	1750000201	S.DIO 1SS319 (TE85R,F)	B	129.5/98.1
D4	1750000201	S.DIO 1SS319 (TE85R,F)	B	129.5/90
D5	1750000201	S.DIO 1SS319 (TE85R,F)	B	129.5/82.8
D6	1750000201	S.DIO 1SS319 (TE85R,F)	B	129.5/76
D7	1730000031	S.ZEN RD5.6M-T2B-A B2	T	69.8/55.3
D101	1790000491	S.DIO HSM88ASTR-E	B	16.5/37.1
D102	1790000491	S.DIO HSM88ASTR-E	B	20.5/37.1
D103	1750000201	S.DIO 1SS319 (TE85R,F)	B	18.5/57
D151	1790000491	S.DIO HSM88ASTR-E	B	33.5/45.3
D152	1790000491	S.DIO HSM88ASTR-E	T	37/44.2
D153	1790000491	S.DIO HSM88ASTR-E	B	27.6/61.1
D154	1790000491	S.DIO HSM88ASTR-E	B	39.4/61.1
D201	1790000491	S.DIO HSM88ASTR-E	B	50.3/45.6
D202	1790000491	S.DIO HSM88ASTR-E	T	44.9/45.5
D203	1750000201	S.DIO 1SS319 (TE85R,F)	B	54.5/58.2
D301	1790000491	S.DIO HSM88ASTR-E	B	82.8/52.5
D302	1790000491	S.DIO HSM88ASTR-E	B	89.2/58
D303	1710000140	S.DIO U05G	T	94.6/12.3
D304	1750000271	S.DIO 1SS301 (TE85L,F)	T	94.6/12.3
X1	6050009890	S.XTL CR-569 (6.144 MHz)	T	83.2/79.5
L1	6200003261	S.COL NLV32T-101J	T	51.1/76.5
L2	6200003261	S.COL NLV32T-101J	T	54.5/77.8
L5	6200005131	S.COL NLC453232T-101K-PF	T	121.6/100.3
L51	6200003261	S.COL NLV32T-101J	T	106.3/86.9
L52	6200005131	S.COL NLC453232T-101K-PF	T	114.9/88.1
L101	6140004410	COL LR-502	T	
L102	6200001831	S.COL NLV32T-100J	T	26.7/56.3
L103	6200003261	S.COL NLV32T-101J	T	14/56.3
L151	6140004410	COL LR-502	T	
L152	6200001831	S.COL NLV32T-100J	T	43.1/62.7
L201	6140004410	COL LR-502	T	
L202	6180003300	COL T6-222J (2.2M)	T	
L301	6140004410	COL LR-502	T	
L302	6200003261	S.COL NLV32T-101J	B	76.9/60.8
L403	6140004670	COL LR-527 (CH160808TR271)	T	
L404	6140004670	COL LR-527 (CH160808TR271)	T	
R2	7030003680	S.RES ERJ3GEYJ 104 V (100 k)	T	63/71
R3	7030003680	S.RES ERJ3GEYJ 104 V (100 k)	T	64.3/71
R4	7030003680	S.RES ERJ3GEYJ 104 V (100 k)	T	65.6/71
R5	7030003680	S.RES ERJ3GEYJ 104 V (100 k)	T	66.9/71
R6	7030003560	S.RES ERJ3GEYJ 103 V (10 k)	T	74.7/71
R7	7030003440	S.RES ERJ3GEYJ 102 V (1 k)	T	73.4/71
R8	7030003680	S.RES ERJ3GEYJ 104 V (100 k)	T	55.4/72.8
R9	7030003680	S.RES ERJ3GEYJ 104 V (100 k)	T	54.7/74.7
R10	7030003680	S.RES ERJ3GEYJ 104 V (100 k)	T	57.3/72.9
R11	7030003680	S.RES ERJ3GEYJ 104 V (100 k)	T	53.4/74.7
R12	7030003440	S.RES ERJ3GEYJ 102 V (1 k)	T	78.3/83.9
R13	7030003680	S.RES ERJ3GEYJ 104 V (100 k)	T	76.6/75.6
R14	7030003680	S.RES ERJ3GEYJ 104 V (100 k)	T	78.5/78.2
R15	7030003440	S.RES ERJ3GEYJ 102 V (1 k)	T	61.7/62
R16	7030003220	S.RES ERJ3GEYJ 101 V (100 k)	T	62.2/55.8
R17	7030003560	S.RES ERJ3GEYJ 103 V (10 k)	T	54.1/82.2
R18	7030003560	S.RES ERJ3GEYJ 103 V (10 k)	T	54.1/80.9
R19	7030003680	S.RES ERJ3GEYJ 104 V (100 k)	T	64.7/59
R20	7030003570	S.RES ERJ3GEYJ 123 V (12 k)	T	67.7/61.1
R21	7030003650	S.RES ERJ3GEYJ 563 V (56 k)	T	66/59
R22	7030003450	S.RES ERJ3GEYJ 122 V (1.2 k)	T	73.3/61.1
R23	7030003400	S.RES ERJ3GEYJ 471 V (470)	B	105.1/100
R24	7030003440	S.RES ERJ3GEYJ 102 V (1 k)	B	102.9/98.8
R25	7030003380	S.RES ERJ3GEYJ 331 V (330)	B	126/99.1
R26	7030003380	S.RES ERJ3GEYJ 331 V (330)	B	126/97.1
R27	7030003380	S.RES ERJ3GEYJ 331 V (330)	B	126/91
R28	7030003380	S.RES ERJ3GEYJ 331 V (330)	B	126/89
R29	7030003380	S.RES ERJ3GEYJ 331 V (330)	B	126/83.8
R30	7030003380	S.RES ERJ3GEYJ 331 V (330)	B	126/81.8
R31	7030003380	S.RES ERJ3GEYJ 331 V (330)	B	126/77
R32	7030003380	S.RES ERJ3GEYJ 331 V (330)	B	126/75
R40	7030003440	S.RES ERJ3GEYJ 102 V (1 k)	T	61.2/99.9
R42	7030003860	S.RES ERJ3GE JPW V	T	60.4/71
R43	7030003860	S.RES ERJ3GE JPW V	T	60.7/69
R44	7030003860	S.RES ERJ3GE JPW V	T	68.2/71
R45	7030003860	S.RES ERJ3GE JPW V	T	65.7/68.5
R46	7030003860	S.RES ERJ3GE JPW V	T	70.6/68.9
R51	7030003440	S.RES ERJ3GEYJ 102 V (1 k)	T	35.5/77.3
R52	7030003440	S.RES ERJ3GEYJ 102 V (1 k)	T	34.2/77.3
R53	7030003860	S.RES ERJ3GE JPW V	T	32.9/77.3
R54	7030003860	S.RES ERJ3GE JPW V	T	31.6/77.3
R55	7030003860	S.RES ERJ3GE JPW V	B	29.6/80.1
R56	7030003860	S.RES ERJ3GE JPW V	B	28/80.1
R57	7030003860	S.RES ERJ3GE JPW V	B	26.4/80.1
R58	7030003860	S.RES ERJ3GE JPW V	B	24.8/80.1
R59	7030003860	S.RES ERJ3GE JPW V	T	18.3/78.7
R60	7030003860	S.RES ERJ3GE JPW V	T	17/76
R61	7030003860	S.RES ERJ3GE JPW V	T	15.7/76
R62	7030003860	S.RES ERJ3GE JPW V	T	14.4/78.7
R63	7030003860	S.RES ERJ3GE JPW V	T	10.6/78.7
R64	7030003860	S.RES ERJ3GE JPW V	T	9.3/78.4
R65	7030003860	S.RES ERJ3GE JPW V	T	8/74.8
R66	7030003520	S.RES ERJ3GEYJ 472 V (4.7 k)	B	15.6/81.6
R67	7030003200	S.RES ERJ3GEYJ 100 V (10)	T	99.8/90.4
R68	7030003200	S.RES ERJ3GEYJ 100 V (10)	T	98.5/90.4
R69	7030003200	S.RES ERJ3GEYJ 100 V (10)	T	97.2/90.4
R70	7030004040	S.RES ERJ3GEYJ 4R7 V (4.7)	T	104.8/65.9
R71	7030004040	S.RES ERJ3GEYJ 4R7 V (4.7)	T	103.5/65.9
R72	7030004040	S.RES ERJ3GEYJ 4R7 V (4.7)	T	102.2/65.9
R73	7030004040	S.RES ERJ3GEYJ 4R7 V (4.7)	T	100.9/65.9
R74	7030004040	S.RES ERJ3GEYJ 4R7 V (4.7)	T	99.6/65.9
R75	7030004040	S.RES ERJ3GEYJ 4R7 V (4.7)	T	98.3/65.9
R76	7030004040	S.RES ERJ3GEYJ 4R7 V (4.7)	T	97/65.9
R77	7030004040	S.RES ERJ3GEYJ 4R7 V (4.7)	T	95.7/65.9
R78	7030004040	S.RES ERJ3GEYJ 4R7 V (4.7)	B	120.1/64.6
R84	7030003240	S.RES ERJ3GEYJ 220 V (22)	B	110.5/64.6
R85	7030003240	S.RES ERJ3GEYJ 220 V (22)	B	108.9/64.6
R86	7030003560	S.RES ERJ3GEYJ 103 V (10 k)	B	116.1/83.6
R87	7030003440	S.RES ERJ3GEYJ 102 V (1 k)	T	71.8/94.4
R88	7030003440	S.RES ERJ3GEYJ 102 V (1 k)	T	75.7/88.1
R89	7030003440	S.RES ERJ3GEYJ 102 V (1 k)	T	73.3/94.4
R90	7030003440	S.RES ERJ3GEYJ 102 V (1 k)	T	77.2/88.1
R91	7030003440	S.RES ERJ3GEYJ 102 V (1 k)	T	74.8/94.4
R92	7030003440	S.RES ERJ3GEYJ 102 V (1 k)	T	78.7/88.1
R93	7030003440	S.RES ERJ3GEYJ 102 V (1 k)	T	76.3/94.4
R95	7030003860	S.RES ERJ3GE JPW V	T	15.7/78.7
R97	7030003860	S.RES ERJ3GE JPW V	T	8/78.7
R101	7030010950	S.RES ERJ1TYJ 100U (10)	T	16.4/39.4
R102	7030010950	S.RES ERJ1TYJ 100U (10)	T	20.2/39.4
R103	7030003560	S.RES ERJ3GEYJ 103 V (10 k)	B	16.7/42.9
R104	7030003560	S.RES ERJ3GEYJ 103 V (10 k)	B	20.3/42.9
R105	7030003720	S.RES ERJ3GEYJ 224 V (220 k)	B	15.1/44.5
R106	7030003720	S.RES ERJ3GEYJ 224 V (220 k)	B	21.9/44.5
R107	7030003660	S.RES ERJ3GEYJ 683 V (68 k)	T	12.4/45.8
R108	7030003660	S.RES ERJ3GEYJ 683 V (68 k)	T	24.1/45.8
R109	7030003720	S.RES ERJ3GEYJ 224 V (220 k)	T	12.4/47.1
R110	7030003720	S.RES ERJ3GEYJ 224 V (220 k)	T	24.1/47.1
R111	7030009340	S.RES ERJ3GEYJ 275V (2.7 M)	T	12.4/48.4
R112	7030003810	S.RES ERJ3GEYJ 125 V (1.2 M)	T	24.1/48.4
R113	7030003440	S.RES ERJ3GEYJ 102 V (1 k)	B	14.5/51.4
R114	7030003440	S.RES ERJ3GEYJ 102 V (1 k)	B	22.4/51.4
R115	7030009340	S.RES ERJ3GEYJ 275V (2.7 M)	T	12.4/49.7
R118	7030003860	S.RES ERJ3GE JPW V	B	17.5/40.5
R119	7030003860	S.RES ERJ3GE JPW V	B	19.5/40.5
R131	7030003440	S.RES ERJ3GEYJ 102 V (1 k)	B	73.1/81
R132	7030003440	S.RES ERJ3GEYJ 102 V (1 k)	B	70.1/81.9
R133	7030003440	S.RES ERJ3GEYJ 102 V (1 k)	B	73.2/82.8
R134	7030003440	S.RES ERJ3GEYJ 102 V (1 k)	B	70.1/83.7
R135	7030003440	S.RES ERJ3GEYJ 102 V (1 k)	B	73.2/84.6
R136	7030003440	S.RES ERJ3GEYJ 102 V (1 k)	B	70.1/85.5
R137	7030003440	S.RES ERJ3GEYJ 102 V (1 k)	B	73.1/86.4
R138	7030003440	S.RES ERJ3GEYJ 102 V (1 k)	B	70.1/87.5
R139	7030003440	S.RES ERJ3GEYJ 102 V (1 k)	T	63.8/94.4
R140	7030003440	S.RES ERJ3GEYJ 102 V (1 k)	T	65.1/94.4
R141	703000344			

[CTRL BOARD]

REF NO.	ORDER NO.	DESCRIPTION	M.	H/V LOCATION
R153	7030007190	S.RES ERJ12YJ220U (22)	T	32.8/41.4
R154	7030010620	S.RES ERJ12YJ180U (18)	B	33.2/41.4
R155	7030003320	S.RES ERJ3GEYJ 101 V (100)	T	33.9/45.5
R157	7030003320	S.RES ERJ3GEYJ 101 V (100)	B	27.9/47.4
R158	7030003560	S.RES ERJ3GEYJ 103 V (10 k)	B	27.1/49.8
R159	7030003560	S.RES ERJ3GEYJ 103 V (10 k)	B	38.5/51.2
R160	7030003280	S.RES ERJ3GEYJ 470 V (47)	B	27.1/52.9
R161	7030003280	S.RES ERJ3GEYJ 470 V (47)	B	38.5/54.3
R162	7030003440	S.RES ERJ3GEYJ 102 V (1 k)	B	25.5/56
R163	7030003440	S.RES ERJ3GEYJ 102 V (1 k)	B	40.1/54.3
R164	7030003280	S.RES ERJ3GEYJ 470 V (47)	T	30.5/48.6
R165	7030003280	S.RES ERJ3GEYJ 470 V (47)	T	37.9/48.6
R166	7030003440	S.RES ERJ3GEYJ 102 V (1 k)	T	31.8/48.6
R167	7030003440	S.RES ERJ3GEYJ 102 V (1 k)	T	36.6/48.6
R168	7030003280	S.RES ERJ3GEYJ 470 V (47)	T	37.3/53
R169	7030003440	S.RES ERJ3GEYJ 102 V (1 k)	T	37.3/51.7
R170	7030003280	S.RES ERJ3GEYJ 470 V (47)	B	31.9/60.8
R171	7030003280	S.RES ERJ3GEYJ 470 V (47)	B	33.5/60.8
R172	7030003480	S.RES ERJ3GEYJ 222 V (2.2 k)	B	36.7/60.8
R173	7030003500	S.RES ERJ3GEYJ 332 V (3.3 k)	B	30.3/63.9
R174	7030003360	S.RES ERJ3GEYJ 221 V (220)	B	44.2/61.6
R201	7030010420	S.RES ERJ1TYJ 560U (56)	T	47.3/37.5
R202	7030010420	S.RES ERJ1TYJ 560U (56)	B	47.9/37.2
R203	7030010420	S.RES ERJ1TYJ 560U (56)	T	47.3/41.5
R204	7030010420	S.RES ERJ1TYJ 560U (56)	B	47.9/41.8
R205	7030003560	S.RES ERJ3GEYJ 103 V (10 k)	T	47.8/49.1
R206	7030003560	S.RES ERJ3GEYJ 103 V (10 k)	B	51.5/48.4
R207	7030003800	S.RES ERJ3GEYJ 105 V (1 M)	T	50.2/49.1
R208	7030003560	S.RES ERJ3GEYJ 103 V (10 k)	B	53.1/51.5
R209	7030003520	S.RES ERJ3GEYJ 472 V (4.7 k)	B	54.8/48.1
R210	7030003360	S.RES 220 ERJ3GE	B	55.5/50.6
R211	7030003480	S.RES ERJ3GEYJ 222 V (2.2 k)	B	60.7/67.4
R212	7030003560	S.RES ERJ3GEYJ 103 V (10 k)	B	59.1/49
R213	7030005331	S.RES ERA3YED 562V (5.6 k)	B	63.8/64.2
R214	7030005331	S.RES ERA3YED 562V (5.6 k)	B	62.2/64.2
R215	7030005871	S.RES ERA3YKD 104V (100 k)	B	59.8/65
R216	7030005331	S.RES ERA3YED 562V (5.6 k)	B	62.2/52.3
R216	7030008121	S.RES ERA3YED 682V (6.8 k)	B	62.2/52.3
R217	7030008121	S.RES ERA3YED 682V (6.8 k)	B	63.8/52
R218	7030005871	S.RES ERA3YKD 104V (100 k)	B	59.8/51.4
R221	7030003670	S.RES ERJ3GEYJ 823 V (82 k)	B	57.4/58.2
R222	7030003680	S.RES ERJ3GEYJ 104 V (100 k)	B	65.4/52.7
R223	7030003820	S.RES ERJ3GEYJ 155 V (1.5 M)	B	59.8/63.4
R224	7030003820	S.RES ERJ3GEYJ 155 V (1.5 M)	B	59.8/53
R225	7030003560	S.RES ERJ3GEYJ 103 V (10 k)	B	57.6/61.9
R226	7030003560	S.RES ERJ3GEYJ 103 V (10 k)	B	57.6/54.5
R227	7030003560	S.RES ERJ3GEYJ 103 V (10 k)	B	54.4/61.7
R228	7030003560	S.RES ERJ3GEYJ 103 V (10 k)	B	52.8/61.7
R251	7540000100	ABS SRYH-350L		
R301	7030003560	S.RES ERJ3GEYJ 103 V (10 k)	B	82.8/49.8
R302	7030003670	S.RES ERJ3GEYJ 823 V (82 k)	B	83.4/55.9
R302	7030003680	S.RES ERJ3GEYJ 104 V (100 k)	B	83.4/55.9
R303	7030010910	S.RES ERJ1TYJ 150U (15)	B	95.9/60.6
R304	7030003670	S.RES ERJ3GEYJ 823 V (82 k)	B	84.1/59.9
R305	7030003720	S.RES ERJ3GEYJ 224 V (220 k)	B	81.7/57.8
R306	7030003660	S.RES ERJ3GEYJ 683 V (68 k)	T	85.2/60.5
R307	7030003660	S.RES ERJ3GEYJ 683 V (68 k)	B	80.1/55.1
R308	7030003840	S.RES ERJ3GEYJ 225 V (2.2 M)	T	81.6/55.1
R309	7030003720	S.RES ERJ3GEYJ 224 V (220 k)	T	88.6/59.8
R310	7030003840	S.RES ERJ3GEYJ 225 V (2.2 M)	T	87.8/57.7
R311	7030003440	S.RES ERJ3GEYJ 102 V (1 k)	T	85.2/57.7
R311	7030003560	S.RES ERJ3GEYJ 103 V (10 k)	T	85.2/57.7
R312	7030003560	S.RES ERJ3GEYJ 103 V (10 k)	T	86.5/57.7
R312	7030003680	S.RES ERJ3GEYJ 104 V (100 k)	T	86.5/57.7
R313	7030003700	S.RES ERJ3GEYJ 154 V (150 k)	T	81.7/55.1
R345	7030003560	S.RES ERJ3GEYJ 103 V (10 k)	T	88.3/82.8
R346	7030003680	S.RES ERJ3GEYJ 104 V (100 k)	B	105.1/96.5
R351	7030003440	S.RES ERJ3GEYJ 102 V (1 k)	B	103.2/9.9
R401	7030003240	S.RES ERJ3GEYJ 220 V (22)	T	17.5/93.4
R402	7030003240	S.RES ERJ3GEYJ 220 V (22)	T	16.2/93.4
R403	7030003240	S.RES ERJ3GEYJ 220 V (22)	T	14.9/93.4
R404	7030003240	S.RES ERJ3GEYJ 220 V (22)	T	13.6/93.4
R405	7030003240	S.RES ERJ3GEYJ 220 V (22)	T	12.3/93.4
R406	7030003240	S.RES ERJ3GEYJ 220 V (22)	T	11/93.4
R407	7030003240	S.RES ERJ3GEYJ 220 V (22)	T	9.7/93.4
R408	7030003240	S.RES ERJ3GEYJ 220 V (22)	T	8.4/93.4
R409	7030003240	S.RES ERJ3GEYJ 220 V (22)	B	36.6/86.7
R410	7030003240	S.RES ERJ3GEYJ 220 V (22)	B	35.1/86.7
R411	7030003240	S.RES ERJ3GEYJ 220 V (22)	B	33.6/86.7
R412	7030003240	S.RES ERJ3GEYJ 220 V (22)	B	32/86.7
R413	7030003240	S.RES ERJ3GEYJ 220 V (22)	B	33.2/93
R414	7030003240	S.RES ERJ3GEYJ 220 V (22)	B	36.9/92.2
R415	7030003240	S.RES ERJ3GEYJ 220 V (22)	B	33.2/91.3
R416	7030003240	S.RES ERJ3GEYJ 220 V (22)	B	36.8/90.5
R417	7030003480	S.RES ERJ3GEYJ 222 V (2.2 k)	B	30.8/98.5
R418	7030003480	S.RES ERJ3GEYJ 222 V (2.2 k)	B	46.4/98.5
R419	7030003480	S.RES ERJ3GEYJ 222 V (2.2 k)	B	32.4/98.5
R420	7030003480	S.RES ERJ3GEYJ 222 V (2.2 k)	B	48/98.5
R421	7030003480	S.RES ERJ3GEYJ 222 V (2.2 k)	B	34/98.5
R422	7030003480	S.RES ERJ3GEYJ 222 V (2.2 k)	B	49.6/98.5
R423	7030003480	S.RES ERJ3GEYJ 222 V (2.2 k)	B	35.6/98.5
R424	7030003480	S.RES ERJ3GEYJ 222 V (2.2 k)	B	51.2/98.5
R425	7030003480	S.RES ERJ3GEYJ 222 V (2.2 k)	B	37.2/98.5
R426	7030003480	S.RES ERJ3GEYJ 222 V (2.2 k)	B	52.8/98.5
R427	7030003480	S.RES ERJ3GEYJ 222 V (2.2 k)	B	38.8/98.5
R428	7030003480	S.RES ERJ3GEYJ 222 V (2.2 k)	B	54.4/98.5
R429	7030003480	S.RES ERJ3GEYJ 222 V (2.2 k)	B	40.4/98.5
R430	7030003480	S.RES ERJ3GEYJ 222 V (2.2 k)	B	56/98.5
R431	7030003480	S.RES ERJ3GEYJ 222 V (2.2 k)	B	42/98.5
R432	7030003480	S.RES ERJ3GEYJ 222 V (2.2 k)	B	57.6/98.5
R433	7030003720	S.RES ERJ3GEYJ 224 V (220 k)	B	46.5/7.9
R434	7030010580	S.RES ERJ1TYJ 1R5U (1.5)	T	31/4.6
R434	7030011130	S.RES ERJ1TYJ 1R0U (1)	T	31/4.6
R435	7030010580	S.RES ERJ1TYJ 1R5U (1.5)	T	31/8.8

[CTRL BOARD]

REF NO.	ORDER NO.	DESCRIPTION	M.	H/V LOCATION
R435	7030011130	S.RES ERJ1TYJ 1R0U (1)	T	31/8.8
R436	7030010580	S.RES ERJ1TYJ 1R5U (1.5)	B	38.8/8.8
R436	7030011130	S.RES ERJ1TYJ 1R0U (1)	B	38.8/8.8
R437	7030010580	S.RES ERJ1TYJ 1R5U (1.5)	B	38.8/4.6
R437	7030011130	S.RES ERJ1TYJ 1R0U (1)	B	38.8/4.6
R438	7030003640	S.RES ERJ3GEYJ 473 V (47 k)	T	22.7/8.3
R439	7030003340	S.RES ERJ3GEYJ 151 V (150)	T	22.7/5.2
R439	7030003400	S.RES ERJ3GEYJ 471 V (470)	T	22.7/5.2
R440	7030003400	S.RES ERJ3GEYJ 471 V (470)	B	30.5/8.3
R440	7030003440	S.RES ERJ3GEYJ 102 V (1 k)	B	30.5/8.3
R441	7030003560	S.RES ERJ3GEYJ 103 V (10 k)	B	30.5/5.2
R442	7030003640	S.RES ERJ3GEYJ 473 V (47 k)	B	32.1/8.3
R443	7030003640	S.RES ERJ3GEYJ 473 V (47 k)	T	99.5/13.5
C1	4510008540	S.ELE EEE1CA100SR	T	42.6/80.3
C2	4030011600	S.CER C1608 JB 1E 104K-T	T	45.8/82.3
C3	4030006880	S.CER C1608 JB 1H 472K-T	B	83.5/100
C4	4030006900	S.CER C1608 JB 1H 103K-T	T	56/74.7
C5	4030006900	S.CER C1608 JB 1H 103K-T	T	58.6/72.9
C7	4030017810	S.CER C1608 CH 1H 102J-T	T	75.3/76.6
C8	4030011600	S.CER C1608 JB 1E 104K-T	T	56/81.3
C9	4030009990	S.CER C1608 CH 1H 200J-T	T	75.3/80.5
C10	4030011600	S.CER C1608 JB 1E 104K-T	T	51.7/79.8
C11	4030006880	S.CER C1608 JB 1H 472K-T	T	76.6/78.2
C12	4030009990	S.CER C1608 CH 1H 200J-T	T	76.6/81.7
C13	4510008750	S.ELE EEE1AA471UP	T	48.6/56.5
C14	4030011600	S.CER C1608 JB 1E 104K-T	T	67.4/56.2
C15	4030011600	S.CER C1608 JB 1E 104K-T	T	72.9/56.3
C16	4510008500	S.ELE EEE1CA101WP	T	75.3/50.5
C17	4510008550	S.ELE EEE1HA010SR	T	133.3/100.5
C18	4510008550	S.ELE EEE1HA010SR	T	133.3/95.7
C19	4510008550	S.ELE EEE1HA010SR	T	138.4/91.9
C20	4510008550	S.ELE EEE1HA010SR	T	133.3/89.7
C21	4510008550	S.ELE EEE1HA010SR	T	138.4/85.3
C22	4510008550	S.ELE EEE1HA010SR	T	133.3/83.1
C23	4510008550	S.ELE EEE1HA010SR	T	138.4/78.6
C24	4510008550	S.ELE EEE1HA010SR	T	133.3/76.5
C25	4030011600	S.CER C1608 JB 1E 104K-T	T	62.2/57.1
C26	4030006880	S.CER C1608 JB 1H 472K-T	T	67.4/59
C40	4030011600	S.CER C1608 JB 1E 104K-T	T	84/70.6
C41	4030011600	S.CER C1608 JB 1E 104K-T	T	78.5/73.2
C43	4030006880	S.CER C1608 JB 1H 472K-T	B	85.7/97.3
C45	4030011600	S.CER C1608 JB 1E 104K-T	T	92.2/88.2
C46	4510008750	S.ELE EEE1AA471UP	T	66.9/49.2
C48	4030011600	S.CER C1608 JB 1E 104K-T	B	118.9/97.7
C66	4510008540	S.ELE EEE1CA100SR	T	106.6/81.6
C68	4030011600	S.CER C1608 JB 1E 104K-T	B	106.7/78.4
C69	4030011600	S.CER C1608 JB 1E 104K-T	T	118.4/79.9
C70	4030011600	S.CER C1608 JB 1E 104K-T	T	95.8/80.5
C71	4030011600	S.CER C1608 JB 1E 104K-T	T	106.9/77.6
C72	4510008540	S.ELE EEE1CA100SR	T	111.6/83.3
C88	4030011600	S.CER C1608 JB 1E 104K-T	B	6.9/78.2
C101	4030011070	S.CER GRM31M2C2H5R0CY21L	B	10.8/12.6
C102	4010005530	CER HM60SJ SL 020C 500V		
C103	4010005530	CER HM60SJ SL 020C 500V		
C105	4030007070	S.CER C1608 CH 1H 330J-T	B	11.4/35.6
C106	4030011540	S.CER C1608 CH 1H 750J-T	B	20.3/34
C107	4030017810	S.CER C1608 CH 1H 102J-T	B	13.6/42.9
C108	4030017810	S.CER C1608 CH 1H 102J-T	B	23.4/42.9
C109	4030006880	S.CER C1608 JB 1H 472K-T	B	20/47.9
C110	4030006880	S.CER C1608 JB 1H 472K-T	B	16.9/47.9
C111	4510008540	S.ELE EEE1CA100SR	T	22.8/54.1
C112	4510008540	S.ELE EEE1CA100SR	T	18/54.1
C113	4030006880	S.CER C1608 JB 1H 472K-T	B	16.9/50.7
C114	4030006880	S.CER C1608 JB 1H 472K-T	B	20/50.7
C115	4030007070	S.CER C1608 CH 1H 330J-T	B	11.4/34
C116	4030011540	S.CER C1608 CH 1H 750J-T	B	20.3/32.4
C119	4030007100	S.CER C1608 CH 1H 560J-T	B	14.7/34
C119	4030007110	S.CER C1608 CH 1H 680J-T	B	14.7/34
C120	4030007070	S.CER C1608 CH 1H 330J-T	B	11.4/32.4
C121	4030007070	S.CER C1608 CH 1H 330J-T	B	10.7/37
C122	4030009530	S.CER C1608 CH 1H 030B-T	B	10.6/38.6
C151	4010005540	CER HM60SJ SL 030C 500V		
C152	4030007070	S.CER C1608 CH 1H 330J-T	B	27.6/45
C153	4030007120	S.CER C1608 CH 1H 820J-T	B	29.2/45
C154	4030007070	S.CER C1608 CH 1H 330J-T	T	31.1/44.2
C155	4030007120	S.CER C1608 CH 1H 820J-T	T	33.9/44.2
C156	4030006880	S.CER C1608 JB 1H 472K-T	B	30.8/45
C157	4030006880	S.CER C1608 JB 1H 472K-T		

[CTRL BOARD]

REF NO.	ORDER NO.	DESCRIPTION	M.	H/V LOCATION
C212	4030006880	S.CER C1608 JB 1H 472K-T	B	60.7/49
C213	4030006880	S.CER C1608 JB 1H 472K-T	B	65.4/56.6
C214	4030007170	S.CER C1608 CH 1H 221J-T	B	56.7/64.1
C215	4030007170	S.CER C1608 CH 1H 221J-T	B	56.7/52.3
C216	4030011340	S.CER C1608 CH 1H 471J-T	B	56/61.9
C217	4030011340	S.CER C1608 CH 1H 471J-T	B	56/54.5
C218	4030006880	S.CER C1608 JB 1H 472K-T	B	65.4/59.7
C221	4030018400	S.CER 33P CM105 CH G	T	51.2/45.7
C222	4030018400	S.CER 33P CM105 CH G	T	49.9/45.7
C251	4030011020	S.CER GRM31M4C2H1R0CY21L	B	88.3/32.5
C253	4030006880	S.CER C1608 JB 1H 472K-T	B	76.3/25.9
C254	4030006880	S.CER C1608 JB 1H 472K-T	B	76.3/39.2
C255	4030011090	S.CER GRM31M2C2H7R0DVO1L	B	107.7/49.3
C301	4010005520	CER HM60SJ SL 010C 500V		
		[USA], [EUR], [UK]		
	4030011020	S.CER GRM31M4C2H1R0CY21L		
		[FRA], [ITR], [ESP], [KOR]		
C302	4030007030	S.CER C1608 CH 1H 150J-T	T	82.1/51.7
C303	4030007050	S.CER C1608 CH 1H 220J-T	T	82.1/49.1
C304	4030017810	S.CER C1608 CH 1H 102J-T	B	85.7/55.1
C305	4030017810	S.CER C1608 CH 1H 102J-T	B	86.5/57.7
C307	4030006880	S.CER C1608 JB 1H 472K-T	T	86.5/60.5
C308	4030011600	S.CER C1608 JB 1E 104K-T	B	78.5/55.1
C309	4030011600	S.CER C1608 JB 1E 104K-T	T	78.4/55.1
C310	4030009530	S.CER C1608 CH 1H 030B-T	T	82.1/50.4
C311	4030012600	S.CER C2012 JB 1A 105M-T	T	86.2/55.4
C417	4510008540	S.ELE EEE1CA100SR	T	22.6/77.6
C418	4510008540	S.ELE EEE1CA100SR	T	40.6/85.6
C419	4030011600	S.CER C1608 JB 1E 104K-T	T	19.6/78.7
C420	4030011600	S.CER C1608 JB 1E 104K-T	T	38.4/79.2
C425	4030018790	S.CER C3225 JB 2E 104K-T	B	77.4/12.1
C426	4030018790	S.CER C3225 JB 2E 104K-T	B	60.3/17
C427	4030006860	S.CER C1608 JB 1H 102K-T	B	67.1/7.9
C428	4030006860	S.CER C1608 JB 1H 102K-T	B	50.1/7.9
C429	4030011600	S.CER C1608 JB 1E 104K-T	B	68.9/7.9
C430	4030011600	S.CER C1608 JB 1E 104K-T	B	48.3/7.9
C431	4030006880	S.CER C1608 JB 1H 472K-T	B	70.7/7.9
C432	4030018790	S.CER C3225 JB 2E 104K-T	B	86/12.3
C433	4030018790	S.CER C3225 JB 2E 104K-T	B	82.7/11.7
C434	4030006880	S.CER C1608 JB 1H 472K-T	T	92.7/11.7
C435	4030011600	S.CER C1608 JB 1E 104K-T	B	20.5/80.1
C436	4030011600	S.CER C1608 JB 1E 104K-T	B	19.5/101.6
RL252	6330001460	RLY FTR-F1CA012V		
RL253	6330001460	RLY FTR-F1CA012V		
RL254	6330001770	RLY SIP-1A-12Y		
CP1	6910009670	S.CHK HK3-S-T	T	67.7/100.1
CP101	6910009670	S.CHK HK3-S-T	T	5/83.4
J1	6510023771	S.CNR 52793-2470 (2490)	T	101.8/99.6
J2	6510023761	S.CNR S10B-PH-SM4-TB (LF) (SN)	T	148.3/82.8
J51	6510023771	S.CNR 52793-2470 (2490)	T	43.9/99.6
J52	6510022031	S.CNR B10B-ZR-SM4-TF (LF) (SN)	T	133/2.9
J53	6510021431	S.CNR S8B-ZR-SM4A-TF (LF) (SN)	T	134.6/65
J101	6510017920	CNR 1811P342		
J251	6510017920	CNR 1811P342		
J252	6510017920	CNR 1811P342		
J301	6510017920	CNR 1811P342		
J351	6510007020	CNR TMP-J01X-V6		
W1	9029804001	WIR 72/99/040/X98/X98		
EP1	9040902903	TUB IRRAX 0.7 (d) L=22 mm		
EP3	6910014690	S.BEA MPZ1608S221A-T	B	115.7/68.2
EP4	6910014690	S.BEA MPZ1608S221A-T	B	113.5/62.3
EP5	6910014730	S.BEA MPZ2012S331A-T	B	117.9/95.2
EP6	6910014730	S.BEA MPZ2012S331A-T	T	109.7/91.2
EP7	6910014730	S.BEA MPZ2012S331A-T	T	106.7/91.2
EP8	6910014730	S.BEA MPZ2012S331A-T	T	103.8/91.2
EP9	6910014690	S.BEA MPZ1608S221A-T	T	94/91.7
EP10	6910014730	S.BEA MPZ2012S331A-T	T	90.8/90.6
EP12	6910015970	S.BEA MMZ1608B 301CT-AS	B	95.2/63.3
EP13	6910015970	S.BEA MMZ1608B 301CT-AS	T	79.4/63.1
EP14	6910014730	S.BEA MPZ2012S331A-T	B	56.3/95.6
EP15	6910014730	S.BEA MPZ2012S331A-T	B	44.6/97.9
EP16	6910014730	S.BEA MPZ2012S331A-T	T	28.7/95.5
EP401	6910014690	S.BEA MPZ1608S221A-T	B	28.1/100.9
EP402	6910014690	S.BEA MPZ1608S221A-T	B	21.9/100.9
Q300	1520000561	S.TR 2SB1123 T-TD-E	T	205.7/10.5

• ANT-SW UNIT
(TOP VIEW)

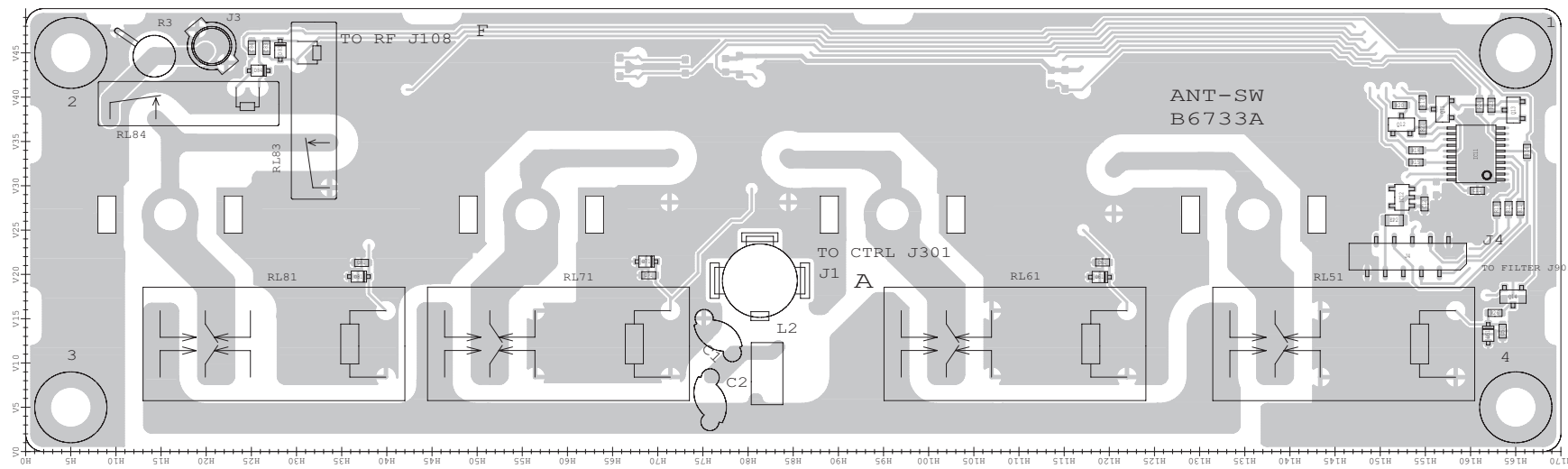

• NETWORK BOARD
(TOP VIEW)

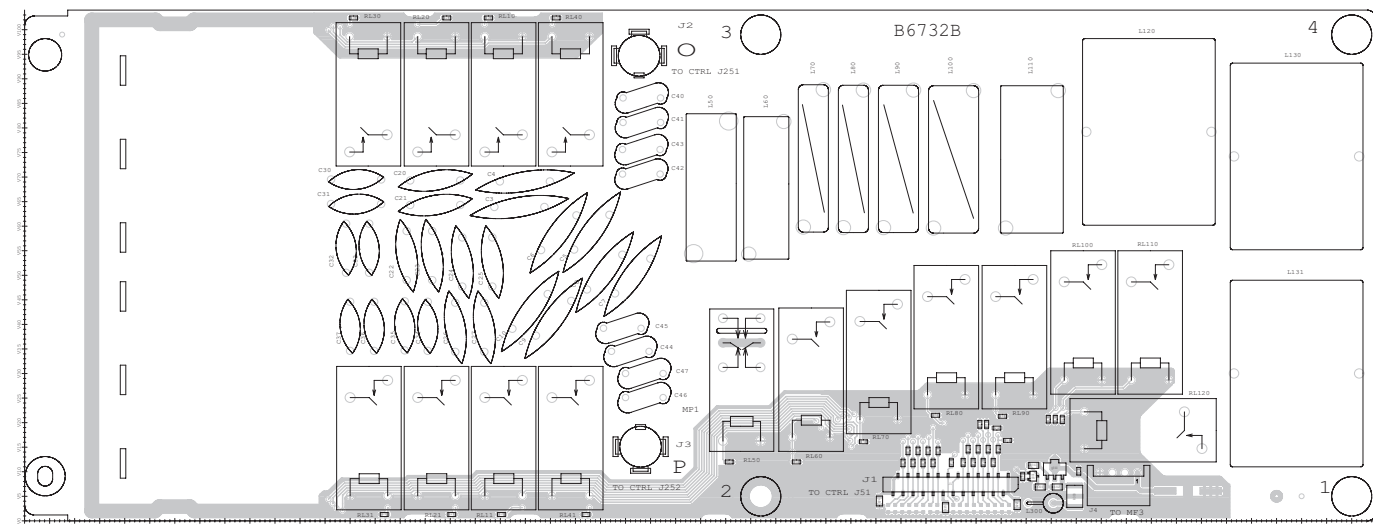

• CTRL UNIT
(TOP VIEW)

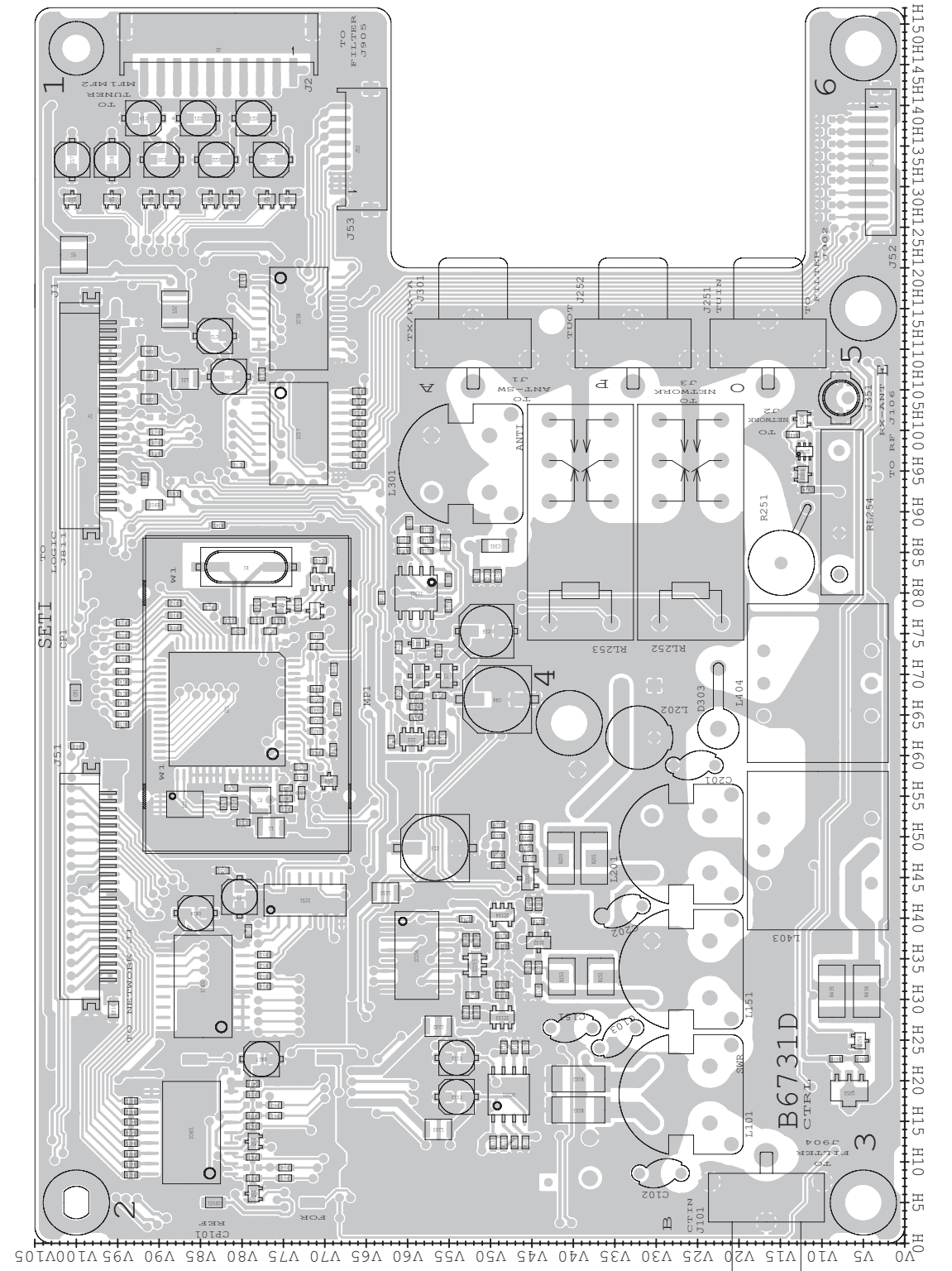

• CTRL UNIT
(BOTTOM VIEW)

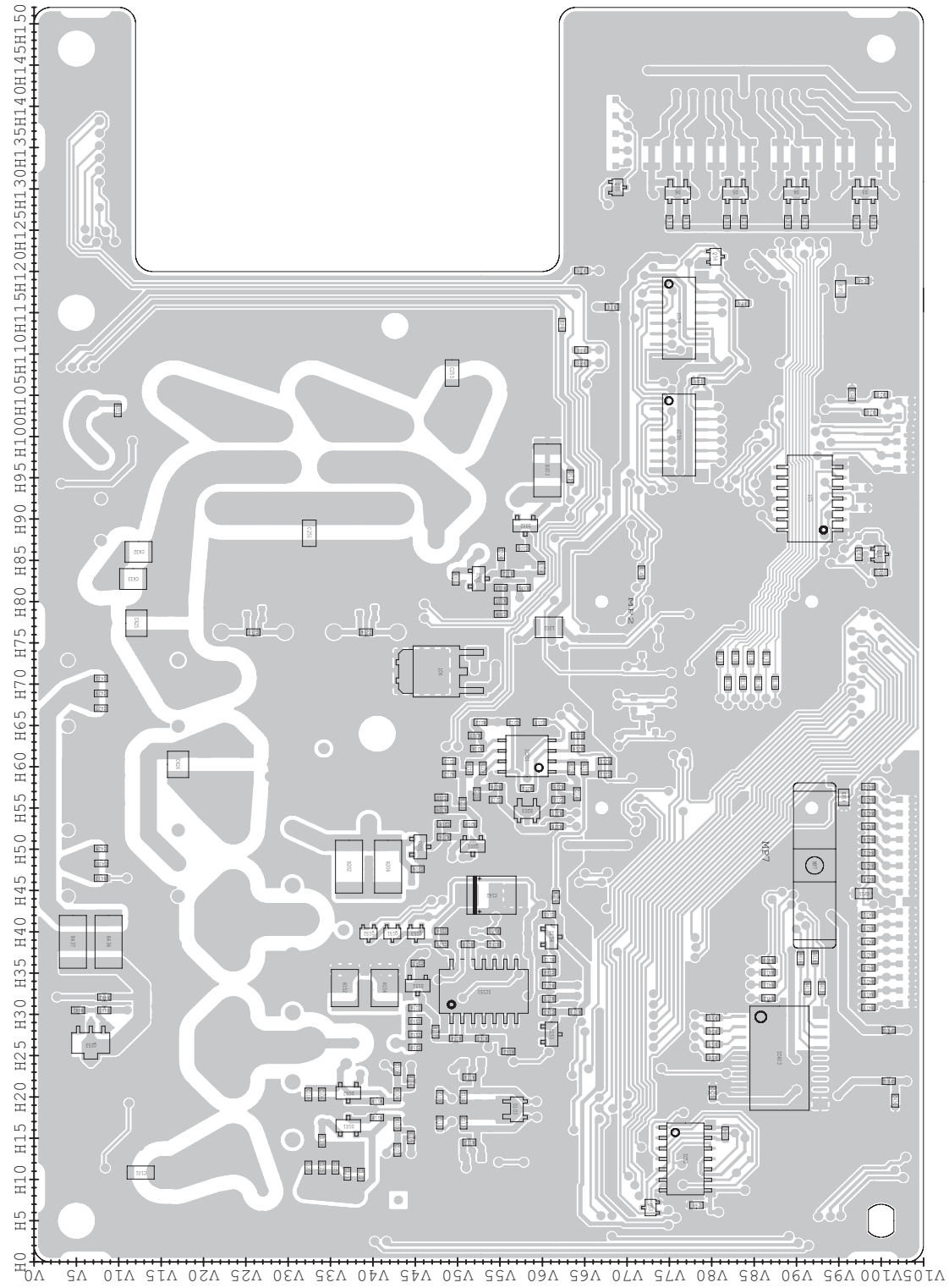

• ANT-SW UNIT
(BOTTOM VIEW)

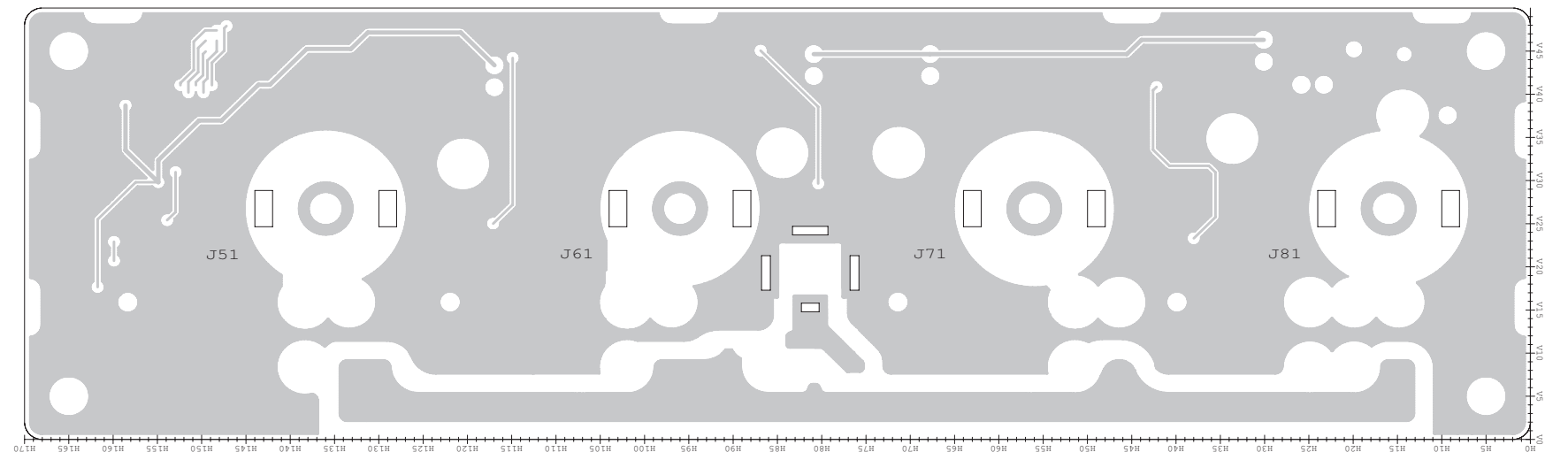

• NETWORK BOARD
(BOTTOM VIEW)

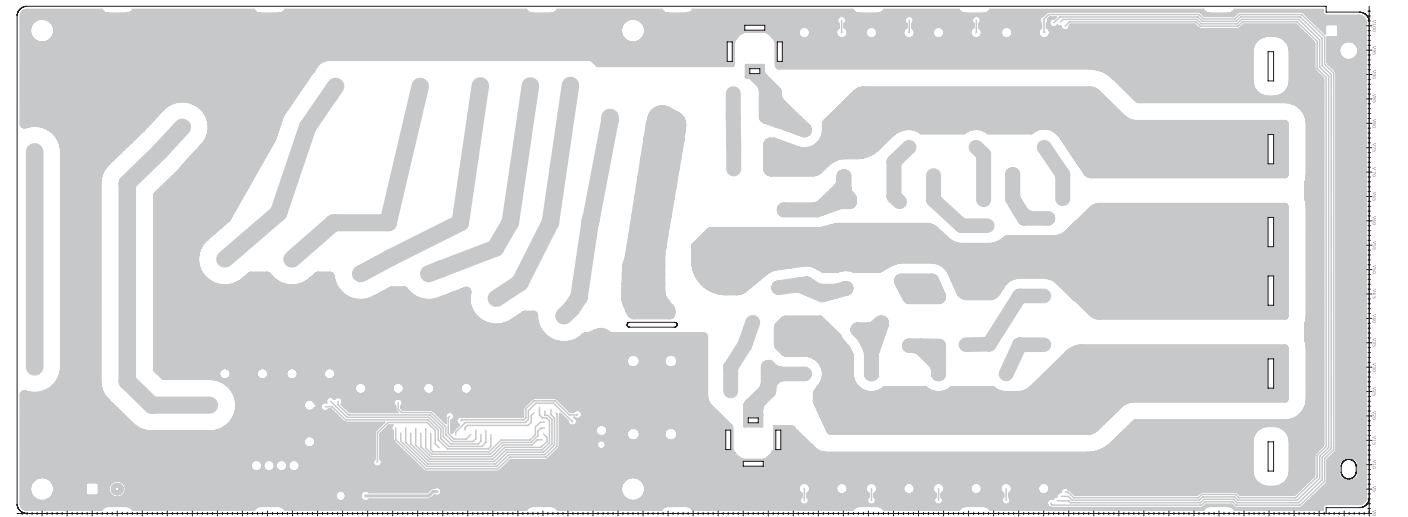

CTRL BOARD

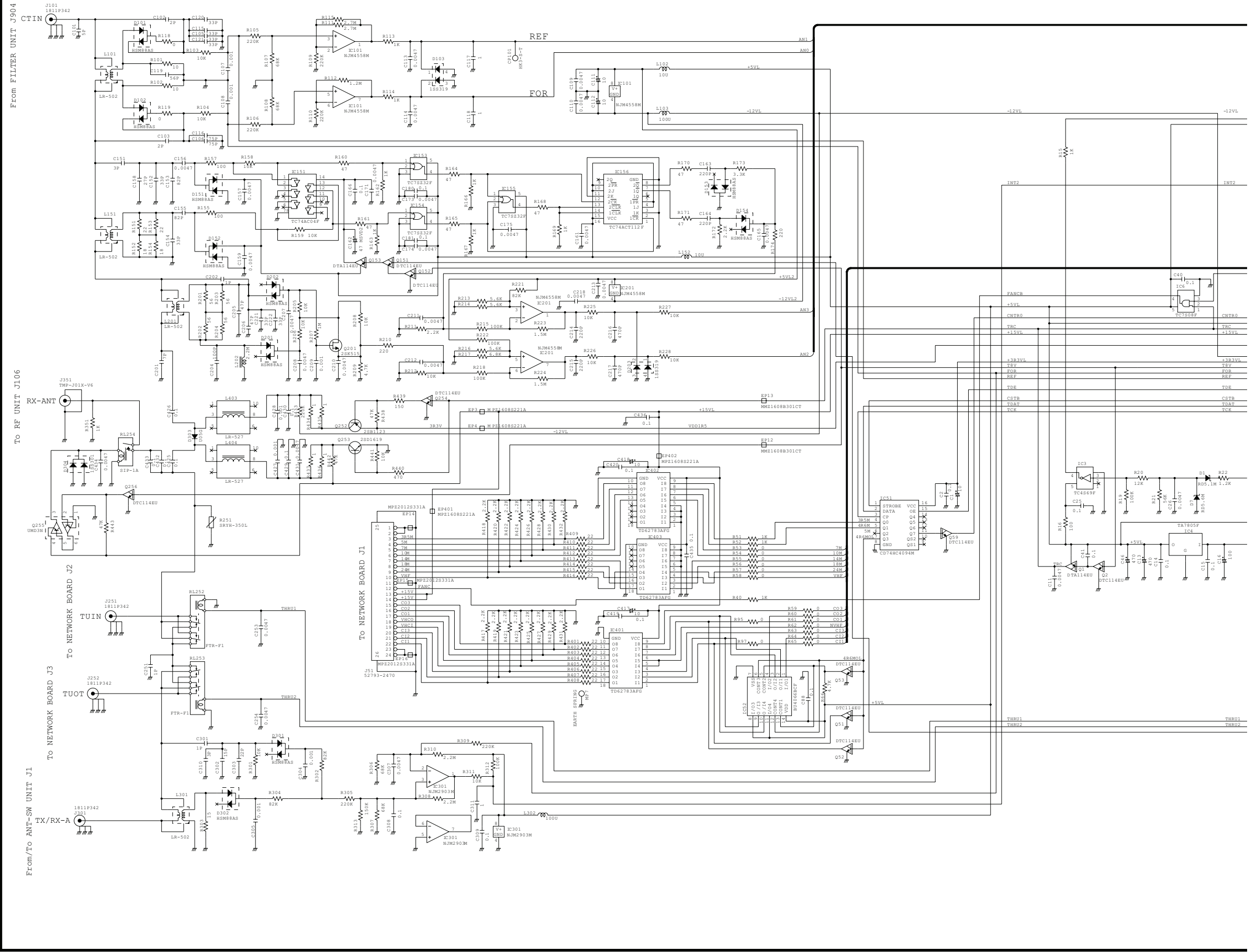

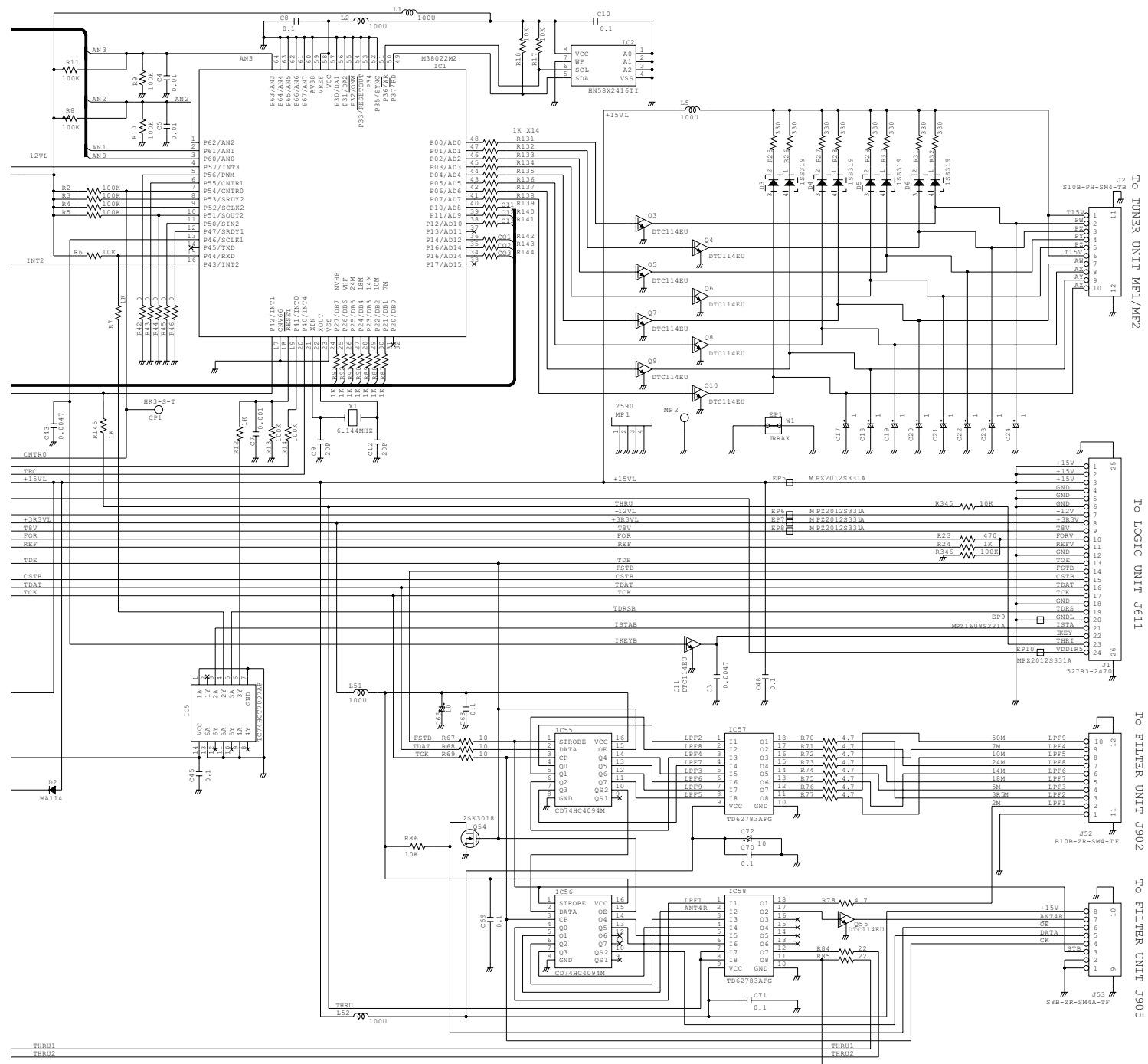



SERVICE MANUAL

HF/50MHz TRANSCEIVER

IC-7700

S-14407XZ-C1
Feb. 2008

Icom Inc.

INTRODUCTION

This service manual describes the latest service information for the **IC-7700** HF/50MHz TRANSCEIVER at the time of publication.

MODEL	VERSION
IC-7700	USA
	EUR
	FRA
	ITR
	ESP
	UK
	KOR

CAUTION

NEVER connect the transceiver to an AC outlet or to a DC power supply that uses more than specified. This will ruin the transceiver.

DO NOT expose the transceiver to rain, snow or any liquids.

DO NOT reverse the polarities of the power supply when connecting the transceiver.

DO NOT apply an RF signal of more than 20 dBm (100 mW) to the antenna connector. This could damage the transceiver's front-end.

To upgrade quality, any electrical or mechanical parts and internal circuits are subject to change without notice or obligation.



ORDERING PARTS

Be sure to include the following four points when ordering replacement parts:

1. 10-digit Icom parts numbers
2. Component name
3. Equipment model name and unit name
4. Quantity required

<ORDER EXAMPLE>

1110003491	S.IC	TA31136FNG	IC-7700	MAIN UNIT	5 pieces
8820001210	Screw	2438 screw	IC-7700	Top cover	10 pieces

Addresses are provided on the inside back cover for your convenience.

REPAIR NOTES

1. Make sure the problem is internal before disassembling the transceiver.
2. **DO NOT** open the transceiver until the transceiver is disconnected from its power source.
3. **DO NOT** force any of the variable components. Turn them slowly and smoothly.
4. **DO NOT** short any circuits or electronic parts. An insulated tuning tool **MUST** be used for all adjustments.
5. **DO NOT** keep power ON for a long time when the transceiver is defective.
6. **DO NOT** transmit power into a Standard Signal Generator or a Sweep Generator.
7. **ALWAYS** connect a 50 dB to 60 dB attenuator between the transceiver and a Deviation Meter or Spectrum Analyzer when using such test equipment.
8. **READ** the instructions of test equipment thoroughly before connecting a test equipment to the transceiver.

CONTENTS

SECTION 1 SPECIFICATIONS

SECTION 2 INSIDE VIEWS

SECTION 3 CIRCUIT DESCRIPITON

3-1	RECEIVER CIRCUITS.....	3-1
3-2	TRANSMITTER CIRCUITS.....	3-3
3-3	FREQUENCY SYNTHESIZER CIRCUITS.....	3-4
3-4	MAIN CPU PORT ALLOCATIONS.....	3-5

SECTION 4 ADJUSTMENT PROCEDURES

4-1	PREPARATION.....	4-1
4-2	ADJUSTMENTS ON THE OSC UNIT AND PLL UNIT.....	4-3
4-3	ADJUSTMENTS ON THE RF UNIT.....	4-5
4-4	ADJUSTMENTS ON THE PA200W BOARD.....	4-7
4-5	ADJUSTMENTS ON THE MAIN UNIT (including RF UNIT).....	4-9
4-6	ADJUSTMENTS ON THE SCOPE UNIT.....	4-11
4-7	AUTOMATIC ADJUSTMENTS.....	4-12

SECTION 5 PARTS LIST

SECTION 6 MECHANICAL PARTS

SECTION 7 BOARD LAYOUTS

SECTION 8 GENERAL WIRING

SECTION 9 BLOCK DIAGRAM

SECTION 10 SCHEMATIC DIAGRAM

FRONT UNIT.....	10-1
LOGIC UNIT.....	10-2
MAIN UNIT.....	10-8
PLL UNIT.....	10-12
OSC UNIT.....	10-13
ANT-SW UNIT.....	10-16
DIGISEL UNIT.....	10-16
RF UNIT.....	10-17
NETWORK BOARD.....	10-22
CTRL BOARD.....	10-23
FILTER UNIT.....	10-24
PA200W BOARD.....	10-25
SCOPE UNIT.....	10-26
DC-DC UNIT.....	10-29

◇ General

- **Frequency coverage** (unit: MHz) :
 - Receiver : 0.030000–60.000000*¹
 - Transmitter : 1.800000–1.999999*², 3.500000–3.999999*²,
5.330500*³, 5.346500*³, 5.366500*³, 5.371500*³,
5.403500*³, 7.000000–7.300000*²,
10.100000–10.150000*², 14.000000–14.350000*²,
18.068000–18.168000*², 21.000000–21.450000*²,
24.890000–24.990000*², 28.000000–29.700000*²,
50.000000–54.000000*²
- *Some frequency ranges are not guaranteed.
- *²Depending on versions. *³USA version only.
- **Operating mode** : USB, LSB, CW, RTTY, PSK31, AM, FM
- **Number of memory channels** : 101 (99 regular, 2 scan edges)
- **Antenna connector** : SO-239×4 (antenna impedance: 50 Ω)
- **Operating temperature range** : 0°C to +50°C; +32°F to +122°F
- **Frequency stability** : Less than ±0.05 ppm (approx. 5 min. after from turn
the main power, [I/O], ON, 0–50°C; 32–122°F)
- **Frequency resolution** : 1 Hz
- **Power supply requirement** : 85–265 V AC (universal input)
- **Power consumption** :
 - Receive : 200 VA typical
 - Stand-by : 210 VA typical
 - Max. audio : 800 VA
 - Transmit at 200 W
- **Dimensions** (projections not included) : 425×149×437 mm; 16²³/₃₂×5⁷/₈×17⁷/₃₂ in
- **Weight** : Approx. 22.5 kg; 50 lb
- **ACC 1 connectors** : 8-pin DIN connector
- **ACC 2 connectors** : 7-pin DIN connector
- **Display*** : 7-inch (diagonal) TFT color LCD (800×480)
- **EXT-DISPLAY connector** : D-sub 15S
- **CI-V connector** : 2-conductor 3.5 (d) mm (1/8")
- **RS-232C connector** : D-sub 9-pin
- **USB connector** : USB (Universal Serial Bus)1.1/2.0×2

◇ Transmitter

- **Transmit output power** :
 - SSB, CW, RTTY, PSK31, FM : 5–200 W
 - AM : 5–50 W
- **Modulation system** :
 - SSB : D.P.S.N. modulation
 - AM : Digital low power modulation
 - FM : Digital phase modulation
- **Spurious emission** :
 - Harmonics : More than 60 dB (HF bands)
 - More than 70 dB (50 MHz band)
 - Unwanted emission : More than 50 dB (HF bands)
 - (except Harmonics) : More than 66 dB (50 MHz band)
 - Out of band emission : More than 40 dB (HF bands)
 - More than 60 dB (50 MHz band)
- **Carrier suppression** : More than 63 dB
- **Unwanted side-band suppression** : More than 80 dB
- **ΔTX variable range** : ±9.999 kHz
- **Microphone connector** : 8-pin connector (600 Ω)
- **ELEC-KEY connector** : 3-conductor 6.35 (d) mm (1/4")
- **KEY connector** : 3-conductor 6.35 (d) mm (1/4")
- **RELAY connector** : Phono (RCA)
- **ALC connector** : Phono (RCA)

◇ Receiver

- **Receive system** : Double conversion superheterodyne system
- **Intermediate frequencies** :
 - 1st 64.455 MHz
 - 2nd 36 kHz
- **Sensitivity (typical)** :
 - SSB, CW, RTTY (BW=2.4 kHz, 10 dB S/N)
 - 0.100000– 1.799999 MHz 0.5 μ V (pre-amp 1 ON)
 - 1.800000–29.990000 MHz 0.16 μ V (pre-amp 1 ON)
 - 50.000000–54.000000 MHz 0.13 μ V (pre-amp 2 ON)
 - AM (BW=6 kHz, 10 dB S/N)
 - 0.100000– 1.799999 MHz 6.3 μ V (pre-amp 1 ON)
 - 1.800000–29.990000 MHz 2 μ V (pre-amp 1 ON)
 - 50.000000–54.000000 MHz 1 μ V (pre-amp 2 ON)
 - FM (BW=15 kHz, 12 dB SINAD)
 - 28.000000–29.990000 MHz 0.5 μ V (pre-amp 1 ON)
 - 50.000000–54.000000 MHz 0.32 μ V (pre-amp 2 ON)
- **Internal Modulate Distortion (typical)** : Dynamic range 109 dB
(at 14.100 MHz, 100 kHz separation, pre-amp OFF, CW mode; BW=500 Hz)
- **Selectivity** :
 - SSB, RTTY (BW=2.4 kHz) More than 2.4 kHz/–3 dB
Less than 3.6 kHz/–60 dB
 - CW (BW=500 Hz) More than 500 Hz/–3 dB
Less than 700 Hz/–60 dB
 - AM (BW=6 kHz) More than 6.0 kHz/–3 dB
Less than 15.0 kHz/–60 dB
 - FM (BW=15 kHz) More than 12.0 kHz/–6 dB
Less than 20.0 kHz/–60 dB
- **Spurious and image rejection ratio** : More than 70 dB
- **Squelch sensitivity (pre-amp OFF)** :
 - SSB, CW, RTTY, PSK31 Less than 5.6 μ V
 - FM Less than 1 μ V
- **RIT variable range** : \pm 9.999 kHz
- **Audio output power** : More than 2.6 W at 10% distortion with an 8 Ω load
- **PHONES connector** : 3-conductor 6.35 (d) mm (1/4")
- **EXT-SP connectors** : 2-conductor 3.5 (d) mm (1/8")/8 Ω

◇ Antenna tuner

- **Matching impedance range** : 16.7 to 150 Ω unbalanced
(HF bands; VSWR better than 3:1)
20 to 125 Ω unbalanced
(50 MHz band; VSWR better than 2.5:1)
- **Minimum operating input** : 8 W (HF bands)
15 W (50 MHz band)
- **Tuning accuracy** : VSWR 1.5:1 or less
- **Insertion loss (after tuning)** : Less than 1.0 dB

All stated specifications are typical and subject to change without notice or obligation.

(viewing from the bottom)

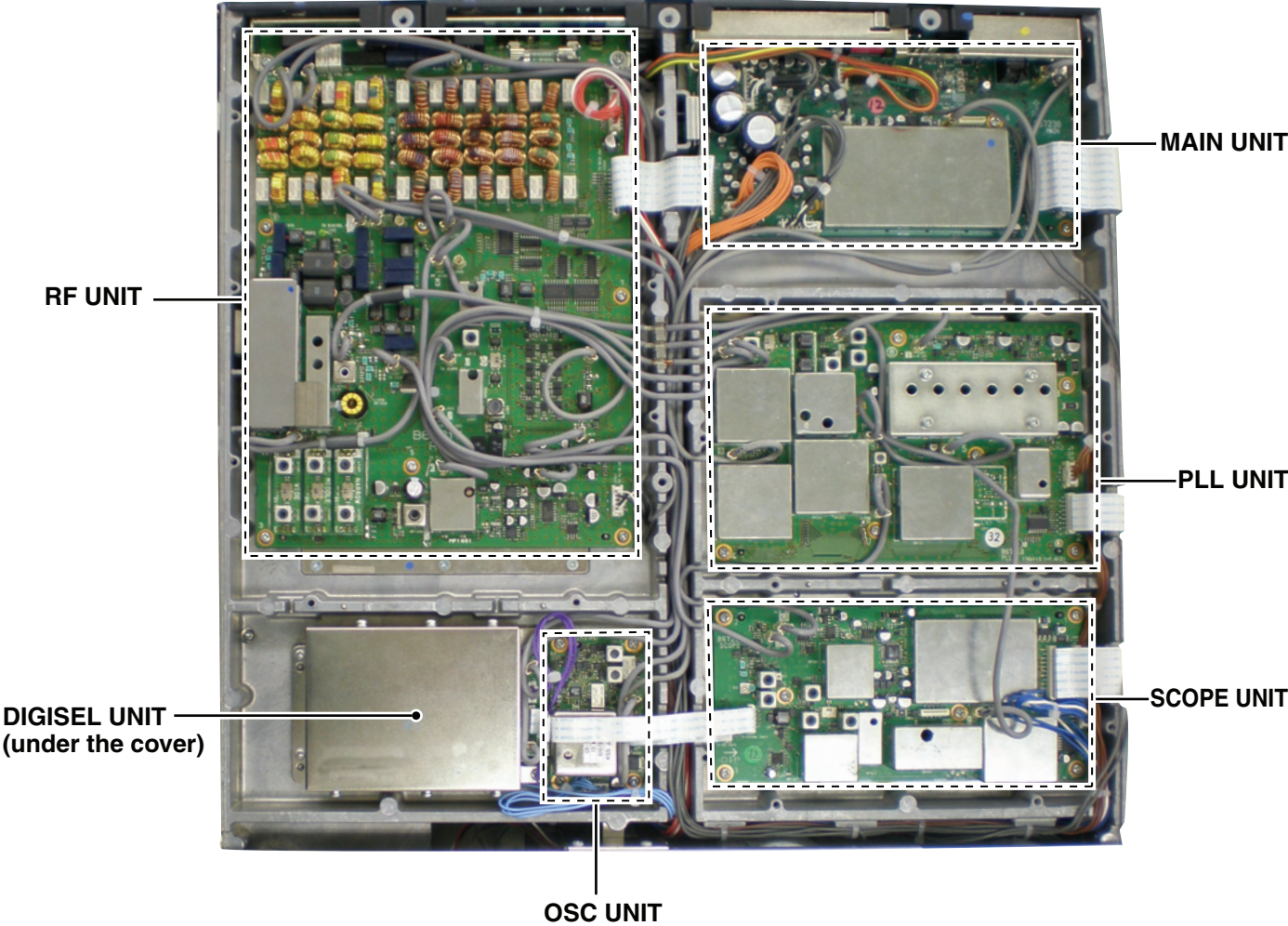

3-1 RECEIVER CIRCUITS

ANT-SW UNIT

Antenna switching relays (RL51, 61, 71, 81) select the RX signals which are from [ANT1]–[ANT4], and the relays are controlled by relay controller (IC11). RX signals from [ANT1]–[ANT3] are applied to the CTRL BOARD, RX signals from [ANT4] are applied to the RF UNIT directly.

CTRL BOARD

The CTRL BOARD has TX/RX switch which toggles the RF path between in TX and RX.

RX signals from the ANT-SW UNIT are passed through the TX/RX switches (RL252–254), and applied to the RF UNIT.

RF UNIT

RF UNIT contains receive circuits; from RX BPF to 2nd RX IF AMP. The RX signals are filtered by BPFs to remove unwanted signals and amplified, then down-converted twice into 2nd IF signal.

The received signals from the ANT-SW UNIT and CTRL BOARD are passed through some relays and attenuators, then filtered by BPFs which is assigned to filter the RX signals that desired to receive. The filtered RX signals are amplified by RF AMPs before being applied to the 1st mixer.

• 0.03–30 MHz SIGNALS

The RX signals from the band SW (RL351) are passed through one of the BPF or LPF. The filtered signals are entered to the DIGISEL UNIT, and gone through or by-passed the DIGISEL (Digital RF Selector Switch) filter.

When the DIGISEL function is activated, the RX signals are passed through the DIGISEL SW (RL21) and narrow bandwidth filter (D_SEL) which filters out unwanted signals with its sharpen frequency response. The filtered signals are amplified by the RF AMP (Q201) which recovers the insert loss of the D_SEL filter, then backed to the RF UNIT via DIGISEL SW (RL2).

The RX signals from the DIGISEL UNIT are applied to or by-passed the Pre-AMP.

When the Pre-AMP1/2 is activated, the RX signals are applied to the Pre-AMP1 (for all HF bands) or Pre-AMP2 (for 24 MHz and above) via P.AMP SW (RL1004), and the amplified RX signals are applied to the 1st mixer (IC1051) via the P.AMP SWs (RL1005, 1006) and LPF.

The RX signals are mixed with the 1st LO signals from the PLL UNIT (1st LO signals are gone through LO AMPs (Q1105, 1104, 1101) before being applied.) to be converted into the 1st RX IF signal.

• 30–60 MHz SIGNALS

RX signals from the band SW (RL351) are passed through one of the BPFs ($F_c=50\text{--}54$ MHz or $F_c=54\text{--}60$ MHz) to remove unwanted signals.

The filtered signals are amplified by one of (or both of) the Pre-AMPs (or by-passed; according to the setting). The amplified RX signals are then applied to the 1st mixer (Q1211, 1212) via the LPF.

The RX signals are mixed with the 1st LO signals from PLL UNIT (the 1st LO signals are gone through LO AMP (Q1301), HPF and LPF before being applied.) to be converted into the 1st RX IF signal.

A portion of 1st IF signal is applied to the SCOPE UNIT via buffer (Q1352).

The converted 1st RX IF signal is then filtered by one of 1st IF filters on the MCF BOARDS (F11401). Selecting of the filter to pass is carried out by IF SW (IC1402, 1403). The filtered 1st RX IF signal is amplified by two 1st IF AMPs (Q1401–1403), then splitted into two before being applied to the 2nd mixers; as a image rejection mixer (IC501, 1502). Each divided 1st RX IF signal is mixed with 2nd LO signals from the PLL UNIT (gone through ATT, LO AMP (Q1651), buffer (IC1651) and another buffer (IC1651)), to be converted into the 36 kHz 2nd RX IF signal.

One of the LO signal is 90 degrees phase-shifted before being applied to the 2nd mixer (IC1502), and the converted 2nd RX IF is 90 degrees phase-shifted too.

These converted 2nd RX IF signals are buffer-amplified by buffer (IC1502/IC1501) and amplified by 2nd IF AMP (IC1504/IC1503). Then the 2nd RX IF signals whose phase is different each other are phase-shifted by the phase shifter (IC1505), then composed by the composer (IC1505).

The composed 2nd RX IF signal is amplified by another 2nd IF AMP (IC1506), then entered to the MAIN UNIT.

• FREQUENCY CONFIGURATION

Signal	Frequency	Signal	Frequency
1st RX IF	64.455 MHz	1st RX LO	64.485–124.455 MHz
2nd RX IF	36 kHz	2nd RX LO	64.491 MHz
1st TX IF	36 kHz	1st TX LO	64.485–124.455 MHz
2nd TX IF	455 kHz	2nd TX LO	64 MHz
3rd TX IF	(*)		

*; Refer to "SPECIFICATIONS."

MAIN UNIT

MAIN UNIT contains receive circuits; from demodulator to AF circuits. The 2nd IF signal is demodulated by digital audio processing circuits.

• DEMODULATOR CIRCUIT

The 36 kHz 2nd RX IF signal from the MAIN UNIT is applied to the Analog to Digital Converter (ADC; IC1251) via the IF mute SW (IC1201) and unbalance-balance convert circuit (IC1211, 1231), to be converted into the 24-bit serial data. The serial data is applied to the DSP (IC1001) and processed as digital audio signals. The processed digital audio signals are then applied to the Digital Audio Converter (DAC; IC1501) to be converted into the analog audio signals; as recovered AF signals.

The recovered AF signals are applied to the RX AF circuits via buffer (IC1751).

• RX AF CIRCUITS

The recovered AF signals are amplified and level-adjusted, then output from the audio interfaces. (The destination of AF output signals is depends on the setting)

<OUTPUT FROM Int./Ext. SPEAKER>

The recovered AF signals from the buffer (IC1751) are passed through the SQL SW (Q351), and applied to the AF AMP (IC331). The amplified AF signals are splitted into two AF lines; one is bound for the headphones jack (J2) on the FRONT UNIT, another is bound for the internal speaker (SP1)/external speaker via the external SP jack (J751) on the MAIN UNIT. Both of AF signals on each AF lines are applied to the 2-channel Voltage Controlled Amplifier (VCA; IC311) whose gain is determined by applied control voltage to be adjusted its signal level.

The level-adjusted AF signals are applied to the AF power AMP (IC281) which power-amplifies to obtain audio output power, via LPF (Q291/301).

The power-amplified AF signals are passed through the AF mute SW (RL261), then applied to the internal speaker (SP1) via the external SP jack (J751), or an external speaker on the MAIN UNIT.

When the headphones are connected to the headphones jack (J2) on the FRONT UNIT, the power-amplified AF signals from the AF power AMP (IC281) are applied to the connected headphones.

<TO THE AUDIO STORAGE>

When recording received audio, recovered AF signals from the buffer (IC1571) are also send to the audio storage (IC203) on the LOGIC UNIT to be recorded.

<OUTPUT FROM ACC PORT>

The recovered AF signals from the buffer (IC1571) are amplified by AF AMPs (IC241), the amplified AF signals are applied to the VCA (IC231) to be adjusted its signal level. The level-adjusted AF signals are output from [ACC1] socket.

SCOPE UNIT

The 1st RX/TX IF signal from the buffer (Q1352) on the RF UNIT are passed through the scope IF SW (IC31), scope ATT, LPF and BPF (dual tuned), and amplified by scope AMP (Q2) then applied to the 2nd scope mixer (D101).

The 1st IF signal is converted into the 45 MHz 2nd scope IF signal (S2IF), and filtered to remove unwanted signals, then amplified by the 2nd scope IF AMPs (Q201 and Q202). The amplified 2nd scope IF signal is applied to the 3rd scope mixer (D4) to be converted into the 200 kHz 3rd scope IF signal. The converted signal is amplified by the 3rd scope IF AMP (IC401), filtered by the active LPF (IC403), level-limited by the saturation AMP (IC404). The level-limited signal is applied to the ADC (IC501) which samples the 200 kHz 3rd scope IF signal (0–2.5 V) into digital signal, then applied to the DSP (IC601) as the serial data.

The DSP processes input data, then output to the CPU to display the frequency and relative signal strength of RX signals on the spectrum screen.

3-2 TRANSMITTER CIRCUITS

MAIN UNIT

The MAIN UNIT contains transmit circuits; from MIC AMP to modulator circuit.

• TX AF CIRCUITS

The audio signals from the microphone (MIC signals) are amplified by MIC AMP (IC171) and level-adjusted by VCA (IC171). The level-adjusted MIC signals are passed through the MIC mute SW (IC201) and MIC line selector (IC211) which selects the MIC line; MIC signals from the microphone jack on the FRONT UNIT, or from [ACC1] socket on the MAIN UNIT.

The MIC signals are then applied to the limiter AMP (IC221) which limits the amplitude of MIC signals. The amplitude-limited MIC signals are applied to the ADC (IC1251) via the unbalance-balance convert circuit (IC1311, 1321, 1331), to be converted into the 24-bit serial data. The serial data is applied to the DSP (IC1001) and processed as digital audio signals. The processed digital audio signals are then applied to the Digital to Analog Converter (DAC; IC1501) to be converted into the analog audio signals; as the 36 kHz 1st TX IF signal. The 1st TX IF signal is entered to the RF UNIT.

RF UNIT

RF UNIT contains transmit circuits; TX mixers and AMPs.

The 36 kHz 1st TX IF signal from the MAIN UNIT is applied to the 1st TX mixer (IC503) to be mixed with the 491 kHz 3rd LO signal from the PLL UNIT, to be converted into the 455 kHz 2nd TX IF signal. The converted 2nd TX IF is amplified by the 2nd IF AMP (Q501), filtered by 2nd TX IF filter (FI1501 for BW=20 kHz or FI1502 for BW=4 kHz). The filtered 2nd TX signal is amplified by 2nd IF AMP (Q504), and applied to the 2nd TX mixer (D505) to be mixed with the 64 MHz 2nd LO signal from the PLL UNIT, to be converted into the 64.455 MHz 3rd TX IF signal. The converted 3rd TX IF signal is passed through the BPF (FI503), amplified by 3rd IF AMP (Q506), and filtered by the LPF. The filtered 3rd TX IF signal is applied to the 3rd TX mixer (D506) to be mixed with the 3rd LO signal from the PLL UNIT, to be converted into the 4th TX IF signal (=TX signal). The converted TX signal is filtered by the LPF, amplified by RF AMP (Q508), passed through one of BPFs, then applied to the YGR AMP (Q801).

The amplified TX signal is entered to the PA200W BOARD.

PA200W BOARD

• TX AMPLIFIERS

The TX signal from the RF UNIT is amplified by the RF AMP (Q101), Pre-drive (Q201), drive (Q301) and power (Q401A, B) amplifiers in sequence, to obtain TX output power. The power-amplified TX signal is entered to the FILTER UNIT.

FILTER UNIT

• TX FILTERS

The power-amplified TX signal from the PA200W BOARD is passed through one of BPFs (according to the TX frequency) to remove unwanted signals including harmonic components. The filtered TX signal is then entered to the CTRL BOARD.

CTRL BOARD

The CTRL BOARD mainly contains circuits for parameter detection of TX signal; Forward Wave, Reflected wave, Reactance, Resistance, antenna current and voltage.

TX signal from the FILTER UNIT is passed through several detection circuits in sequence, then applied to the antenna [ANT1]–[ANT4].

• FOR (Forward Wave) voltage detection circuit

A portion of TX signal is rectified by current trans (L101) and diode (D102), and the produced DC voltage is composed by C103, C106 and C116 to detect FOR voltage (Forward wave components). The detected voltage is amplified by IC101 and applied to the A/D port of CPU (IC1).

• REF (Reflected Wave) voltage detection circuit

A portion of TX signal is rectified by current trans (L101) and diode (D101), and the produced DC voltage is composed by C102, C105, C115, C120 and C121 to detect REF voltage (Reflected wave components). The detected voltage is amplified by IC101 and applied to the A/D port of CPU (IC1).

• Reactance components detection circuit

A portion of TX signal which is detected by current trans (L151) and TX signal which is divided by C153 and C158 are amplified by C-MOS IC. This AMP, as the first stage, employs a C-MOS type AMP to detect the low TX signal.

The inverter AMP requires input level lower than others need, and provides high speed operation for stable high frequency operation with low TX signal.

The amplified signal is adjusted its waveform, then applied to the IC155 and IC156 for phase comparison. The output signal is rectified by D153 and D154, composed and amplified by IC201, then applied to the A/D port of the CPU (IC1).

• Resistance components detection

A portion of TX signal which is detected by current trans (L201) and TX signal which is divided by C202, C205 and C206 are adjusted so that two of these are the same on the voltage. And two of these are rectified composed each other to detect the resistance components. When the detected voltage is increased, Q201 is activated to amplify the signal for high detection sensitivity.

3-3 FREQUENCY SYNTHESIZER CIRCUITS

PLL UNIT

PLL UNIT provides LO signals; 1st LO for TX/RX IF circuits, 2nd RX LO (64.491 MHz), 2nd TX LO (64 MHz), 3rd TX LO (491 kHz), marker frequency (100 kHz), reference frequency for the SCOPE UNIT (40 MHz) and clock signal for the DSP UNIT (12.888 MHz). These LO signals are generated by the reference signal from the OSC UNIT as reference.

This transceiver employs the Direct Digital Synthesizer (DDS) which digitally creates arbitrary waveforms and frequencies from a fixed source frequency, to provide extremely high resolution and stability frequency and pure waveform.

• Reference frequency signal

The 10 MHz reference frequency signal generated on the OSC UNIT is applied to the 4th harmonic extractor (Q702, L702, 703) via buffer (Q30) to produce the 40 MHz reference signal.

• 1st LO signals

The 40 MHz reference signal from the harmonic extractor is amplified by Q101, and applied to the DDS (IC101) as the clock signal. The DDS generates the 10.4122038–10.4963312 MHz sine waves, and these are passed through the ceramic filter (F1101; Fc=10.7 MHz) to adjust the waveform, then applied to the PLL IC (IC201) via buffer (Q151).

The PLL IC (IC201) controls the oscillating frequency of 6 VCOs (VCO1 to VCO6) using the reference signal generated by the DDS as reference frequency.

VCO	Oscillator component	Oscillating frequency
VCO1	Q220	64.485–72.454999 MHz
VCO2	Q230	72.455–79.454999 MHz
VCO3	Q240	79.455–86.454999 MHz
VCO4	Q250	86.455–94.454999 MHz
VCO5	Q260	94.455–109.454999 MHz
VCO6	Q270	109.455–124.455 MHz

The output signals of each VCOs (1st LO signals) are buffer-amplified by Q301, passed through the HPF and LPF, then amplified by the 1st LO AMPs (Q302 and Q351). The amplified 1st LO signals are buffer-amplified by Q352, passed through the LPF, HPF and ATT, then output to the RF UNIT as 1st LO signals (64.485–124.455 MHz).

• 2nd LO signals

The 40 MHz reference signal from the harmonic extractor is amplified by IC503, and applied to the DDS (IC501) as the clock signal. The DDS generates the reference frequency which controls the oscillating frequency of 64 MHz VCO (Q541).

The output signal of 64 MHz VCO (Q541) is buffer-amplified by Q561, and applied to the hybrid divider.

The hybrid divider divides the VCO output into two; 2nd TX LO and 2nd RX LO.

<2nd TX LO signal>

The VCO output signal from the hybrid divider is passed through the ATT, and applied to the 2nd LO AMP (Q591). The amplified VCO output signal is passed through the BPF, then entered to the RF UNIT as the 2nd TX LO signal.

<2nd RX LO signal>

The VCO output signal from the hybrid divider is passed through the ATT, and applied to the 2nd LO AMP (Q801). The amplified VCO output signal is passed through the ATT and, applied to the 2nd LO mixer (D821) and mixed with the 491 kHz 3rd TX LO signal from the 3rd TX LO oscillator (IC651), to convert into the 64.491 MHz 2nd RX LO signal. The converted 2nd RX LO signal is passed through the ATT and BPF, and applied to the 2nd LO AMP (Q831). The amplified signal is entered to the RF UNIT as the 2nd RX LO signal.

• 3rd TX LO signal

The 40 MHz reference signal from the harmonic extractor is amplified by IC652, and applied to the DDS (IC655) as the clock signal. Using the clock signal, the DDS directly generates the 491 kHz 3rd TX LO signal.

The output signal of DDS is passed through the LPF and HPF, and applied to the buffer AMP (Q680). The buffer-amplified 2nd TX LO signal is entered to the RF UNIT via ATT.

• DSP system clock

The 40 MHz reference signal from the harmonic extractor is amplified by IC1651, and applied to the DDS (IC1652) as the clock signal. Using the clock signal, the DDS directly generates 12.288 MHz system clock signal. The system clock signal is passed through the LPF and HPF, and applied to the buffer (Q1680). The buffer-amplified system clock signal is entered to the MAIN UNIT via ATT.

• Scope clock

The 40 MHz reference signal from the harmonic extractor is amplified by Q1601, and entered to the SCOPE UNIT.

3-4 MAIN CPU (IC604) PORT ALLOCATIONS

Pin No.	Description	IN/OUT	Condition
42	Clock signal to 4094/LMX2306 (PLL UNIT). (DDS for 1st LO PLL-IC/DDS, 2nd TX LO DDS, 3rd TX LO)	O	
43	"Serial data to 4094/LMX2306 (PLL UNIT). (DDS for 1st LO PLL-IC/DDS, 2nd TX LO DDS, 3rd TX LO)	O	
44	N/C	O	
45	Mode status (1Lo or T2Lo) output.	O	
46	Chip select signal to PLL.	I/O	
47	Strobe to the PLL.	O	
51	Clock signal to units other than PLL and SCOPE.	O	
52	Serial data (other than PLL, SCOPE and DSP).	O	
53	N/C	O	
54	CI-V format data (UART).	O	
55	CI-V format data (UART).	I	
56	Clock to the DSP IC.	O	
57	Serial data (TXD/RXD) to the DSP.	O	
58	START signal to the TUNER UNIT (UART, 9600).	O	
142	Serial data to the DAC (BU9480) for ext. S-meter.	O	
140	Clock (A-clock) to the DAC (BU9480) for ext. S-meter.	O	
138	Clock (B-clock) to the DAC (BU9480) for ext. S-meter.	O	
137	Power line for liner circuit control signal.	O	"H"=Power ON
113	Forward wave detected voltage (A/D).	I	
114	Reflected wave detected voltage (A/D).	I	
115	ALC feedback voltage (A/D).	I	
116	Drain current (final amp.).	I	
117	Drain voltage (final amp.).	I	
118	PA UNIT temperature.	I	
119	Cooling fan motor current.	I	
120	Voltage from key pad (rear panel).	I	
133	Serial data to the FRONT CPU (UART, 38400).	O	
134	Serial data from the FRONT CPU (UART, 38400).	I	
135	CW/RTTY keying signal to the DSP.	O	"L"=Key pushed
81	Mute control signal.	I	"H"=Mute
82	TX power line control signal.	O	"L"=TX
83	Noise pulse.	I	
105	RX power line control signal.	O	"L"=RX
3	Serial communication with the scope DDS (AD9857) detect signal.	O	"H"=detected
33	Serial data to the SCOPE UNIT DDS/PLL/DSP.	O	
34	Strobe to the scope PLL (LMX2306).	O	
59	Chip select signal to the scope DDS (AD9857).	O	"L"=AD9875 is selected
60	Profile (0/1) select signal to the scope DDS (AD9857).	O	"H"=Profile 1 is selected.
61	Clock signal to the DDS/PLL/DSP.	O	
121	DSP data (TXD/RXD).	I	
122	Hand shake signal from SCOPE DSP.	I	
123	Extra port for SCOPE DSP.	I	
124	Serial data from SCOPE DSP.	I	
125	N/C	I	
126	Through signal from the TUNER UNIT.	I	"H"=Through
127	Key input from the TUNER UNIT.	I	"H"=Tuner ON
128	Straight key input (A/D).	I	"L"=Key pushed

3-4 MAIN CPU (IC604) PORT ALLOCATIONS (continued)

Pin No.	Description	IN/OUT	Condition
23	Clock to the EEPROM (HN58X2464TI).	O	
24	Serial data from the EEPROM (HN58X2464TI).	I/O	
26	Clock signal to the EEPROM (DIGISEL UNIT; CAT24WC256).	O	
27	Serial data from/to the EEPROM (DIGISEL UNIT; CAT24WC256).	I/O	
30	RTTY keying.	I	"H"="space" is marked
31	Transverter control signal from the [ACC] connector.	I	"L"=Transverter is activated.
21	PLL unlock signal.	I	"L"=Unlocked
5–20	Address bus lines.	O	
73–71	Data bus lines.	I/O	
84	WAIT signal (bus line control).	I	"L"=Wait.
85	SEND signal.	O	"L"=TX
86	Dual Port SRAM intrude signal.	I	
87	"L" indicator control signal (bus control).	O	"L"= lights.
88	"H" indicator control signal (bus control).	O	"H"= lights.
89	READ data (bus control).	O	
90	Address data (bus control).	O	
94	PTT/ACC SEND input.	I	"H"=TX
107	Squelch signal to the [ACC] connector.	O	"H"=Squelch open (RX LED lights)
109	Squelch signal.	O	"L"=Squelch open (Mute OFF)
35	External SEND (lead relay) signal output.	O	"H"=Relay ON
36	External SEND (IC relay) signal output.	O	"H"=Relay ON
37	Chip select signal to the Dual Port SRAM.	O	"L"=SRAM is selected.
38	Chip select signal to the expander.	O	"L"= E x p a n d e r i s selected.

SECTION 4 ADJUSTMENT PROCEDURE

4-1 PREPARATION

■ REQUIRED EQUIPMENTS

EQUIPMENT	SPECIFICATION	EQUIPMENT	SPECIFICATION
Spectrum analyzer	Frequency range : At least 90 MHz Bandwidth : 100 kHz or more	Digital multimeter	Input impedance : 50 k Ω /DC or more Measuring range : Voltage: 0.1–10V Current: 5A/30A
RF power (terminated type)	Measuring range : 10–300 W Frequency range : 1.8–100 MHz Impedance : 50 Ω SWR : Less than 1.2 : 1	Standard Signal Generator (SSG)	Frequency range : 0.1–100 MHz Output level : 0.1 μ V to 32 mV (–127 to –17 dBm)
Frequency Counter	Frequency range : 0.1–100 MHz Frequency accuracy : \pm 0.5 ppm or better Input level : Less than 1 mW	AC Millivoltmeter	Measuring range : 10 mV to 10 V
Modulation Analyzer	Frequency range : 30–300 MHz Measuring range : 0 to \pm 10 kHz	External Speaker	Input impedance : 8 Ω Capacity : More than 5 W
Audio Generator	Frequency range : 300–3000 Hz Output level : 1–500 mV	Attenuator	Power attenuation : 50 or 60 dB Capacity : More than 200 W

CAUTION!: BACK UP originally programmed contents (Memory channels, Common settings, etc.) in the transceiver before starting adjustment. When all adjustments are completed, these contents in the transceiver will be cleared.

■ EXPOSING UNITS

CAUTION: The transceiver weighs approx. 22.5 kg (50 lb). Always have two people available to carry, lift or turn over the transceiver.

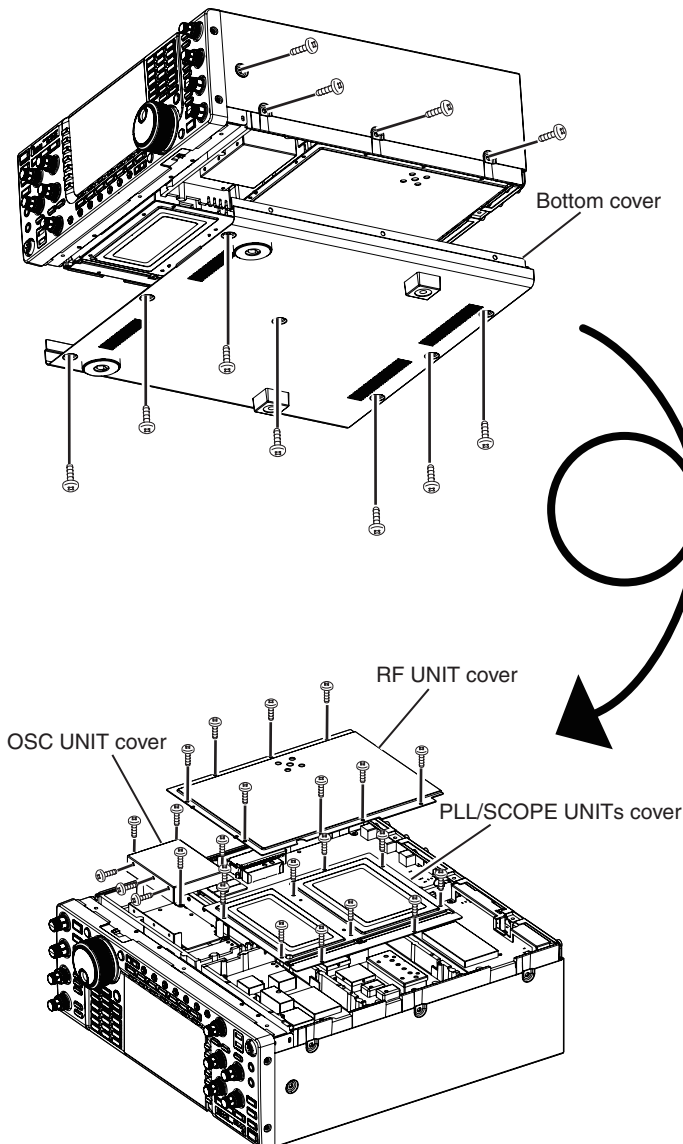

- 1) Remove 8 screws from the both sides.
- 2) Remove 7 screws from the bottom, then remove the bottom cover.

- 3) Turn over the transceiver.
- 4) Remove 8 screws from the RF UNIT cover, 10 screws from the PLL/SCOPE UNITS cover and 10 screws from the OSC UNIT cover, then remove those covers.

UNITS LOCATION

<Bottom view>

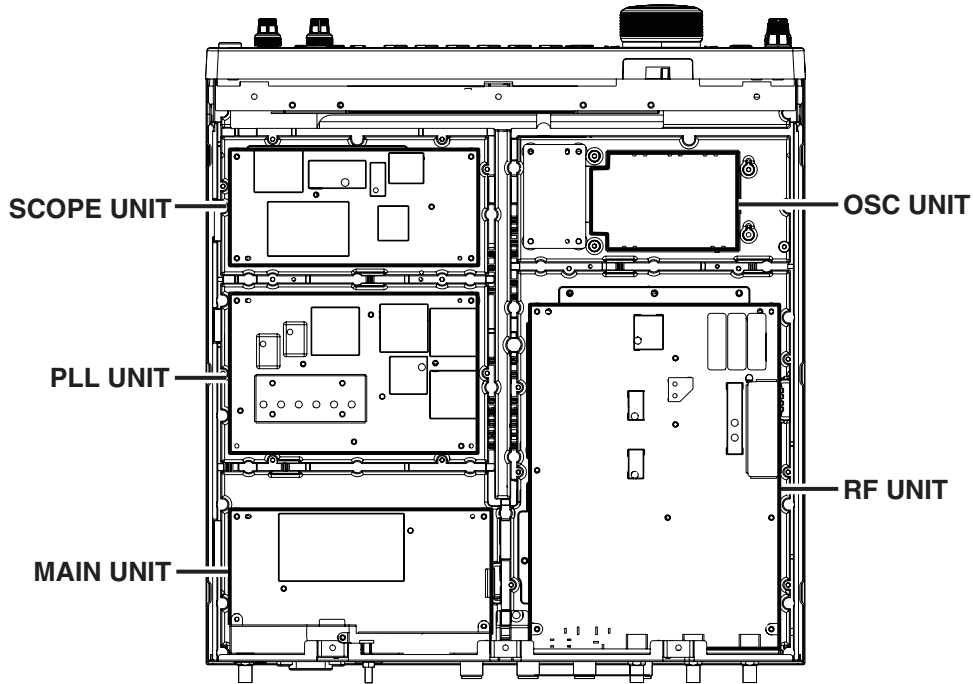

CONNECTIONS



CAUTION !
DO NOT select an TX adjustment item while an SSG is connected to the antenna connector.

<Rear view>

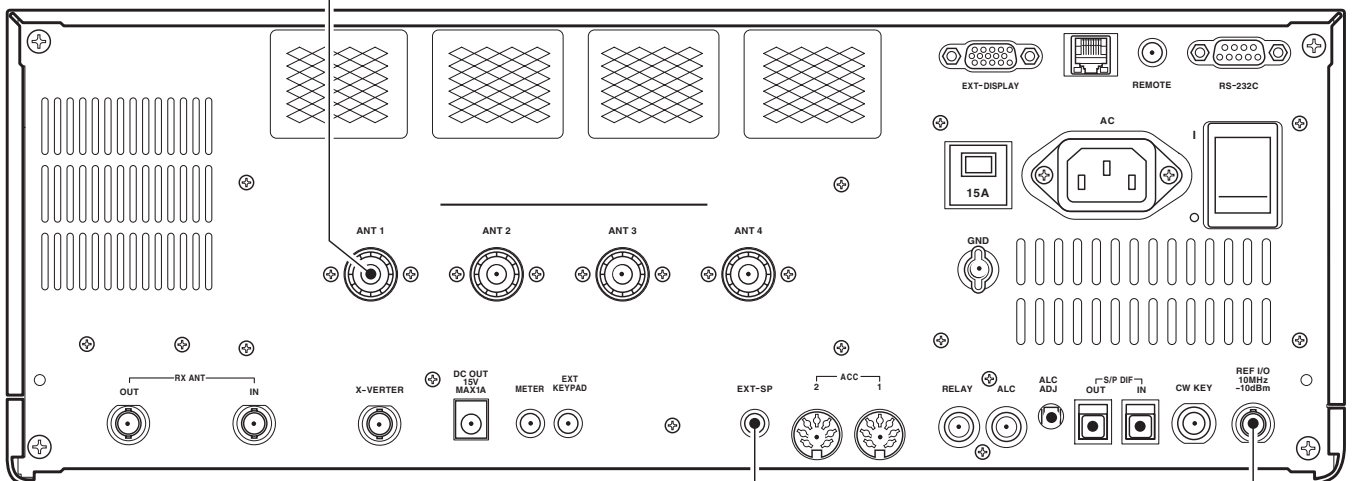

SINAD METER

SSG
 (for adjustments on the OSC UNIT)

<Front view>

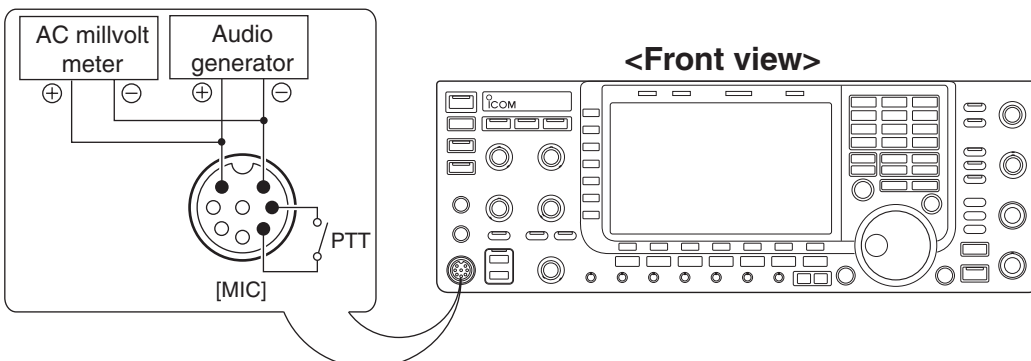

4-2 ADJUSTMENTS ON THE OSC UNIT AND PLL UNIT

ADJUSTMENT	ADJUSTMENT CONDITION	OPERATION	ADJUSTMENT POINT	VALUE
REFERENCE SIGNAL LEVEL	1 <ul style="list-style-type: none"> Reference signal source : External Receiving 	<ol style="list-style-type: none"> Connect an Standard Signal Generator to J1071 ([EXT-REF I/O] terminal on the rear panel) and set as; <ul style="list-style-type: none"> Frequency : 10.000 MHz Level : -10.0 dBm Modulation : None Connect a Spectrum Analyzer to J1072. Adjust the REF signal level with L1061 and L1062. 	L1061, L1062 (OSC UNIT) (repeatedly)	Maximum level
REFERENCE SIGNAL LEVEL (40MHz)	1 <ul style="list-style-type: none"> Receiving 	<ol style="list-style-type: none"> Connect a Spectrum Analyzer to CP701 (PLL UNIT). Adjust the REF signal (40 MHz) level with L702 and L703. 	L702, L703 (PLL UNIT) (repeatedly)	Maximum level
HPL LOCK VOLTAGE (VCO1)	1 <ul style="list-style-type: none"> Frequency : 7.999 MHz Mode : USB Receiving 	<ol style="list-style-type: none"> Connect a Digital multimeter to CP2 "LV2" (PLL UNIT). Adjust the lock voltage with C222. 	C222 (PLL UNIT)	3.9-4.1 V
(VCO2)	2 <ul style="list-style-type: none"> Frequency : 14.999 MHz Mode : USB Receiving 	<ol style="list-style-type: none"> Connect a Digital multimeter to CP2 "LV2" (PLL UNIT). Adjust the lock voltage with C232. 	C232 (PLL UNIT)	3.9-4.1 V
(VCO3)	3 <ul style="list-style-type: none"> Frequency : 21.999 MHz Mode : USB Receiving 	<ol style="list-style-type: none"> Connect a Digital multimeter to CP2 "LV2" (PLL UNIT). Adjust the lock voltage with C242. 	C242 (PLL UNIT)	3.9-4.1 V
(VCO4)	4 <ul style="list-style-type: none"> Frequency : 29.999 MHz Mode : USB Receiving 	<ol style="list-style-type: none"> Connect a Digital multimeter to CP2 "LV2" (PLL UNIT). Adjust the lock voltage with C252. 	C252 (PLL UNIT)	3.9-4.1 V
(VCO5)	5 <ul style="list-style-type: none"> Frequency : 44.999 MHz Mode : USB Receiving 	<ol style="list-style-type: none"> Connect a Digital multimeter to CP2 "LV2" (PLL UNIT). Adjust the lock voltage with C262. 	C262 (PLL UNIT)	3.9-4.1 V
(VCO6)	6 <ul style="list-style-type: none"> Frequency : 60.000 MHz Mode : USB Receiving 	<ol style="list-style-type: none"> Connect a Digital multimeter to CP2 "LV2" (PLL UNIT). Adjust the lock voltage with C272. 	C272 (PLL UNIT)	3.9-4.1 V
1st LO OUTPUT LEVEL	1 <ul style="list-style-type: none"> Frequency : 14.999 MHz Mode : USB Receiving 	<ol style="list-style-type: none"> Connect a Spectrum Analyzer to J351 "1LO" (PLL UNIT). Adjust the output level with R357. 	R357 (PLL UNIT)	2.35-2.85 dBm
2nd LO LOCK VOLTAGE	1 <ul style="list-style-type: none"> Frequency : 14.100 MHz Mode : USB Receiving 	<ol style="list-style-type: none"> Connect a Digital multimeter to CP3 "LV3" (PLL UNIT). Adjust the lock voltage with C546. 	C546 (PLL UNIT)	1.7-2.3 V
RX 2nd LO LEVEL	1 <ul style="list-style-type: none"> Frequency : 14.100 MHz Mode : USB Receiving 	<ol style="list-style-type: none"> Connect a Spectrum Analyzer to J831 "R2LO" (PLL UNIT). Adjust the output level with L801 and L834. 	L801, L834 (PLL UNIT) (repeatedly)	Max. level (-20.0 dBm ±3.0 dB)
TX 2nd LO LEVEL	1 <ul style="list-style-type: none"> Frequency : 14.100 MHz Mode : USB Transmitting 	<ol style="list-style-type: none"> Connect a Dummy Load to [ANT1]. Connect a Spectrum Analyzer to J561 "T2LO" (PLL UNIT). Adjust the output level with L565 and L566. 	L565, L566 (PLL UNIT) (repeatedly)	Max. level (3.0 dBm ±3.0 dB)

- ADJUSTMENT AND CHECK POINTS -

• PLL UNIT (TOP VIEW)

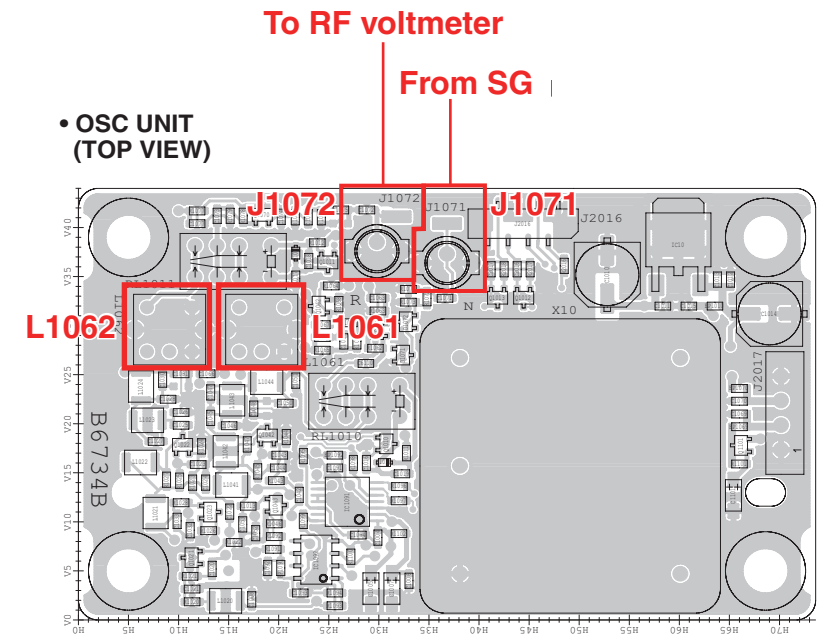
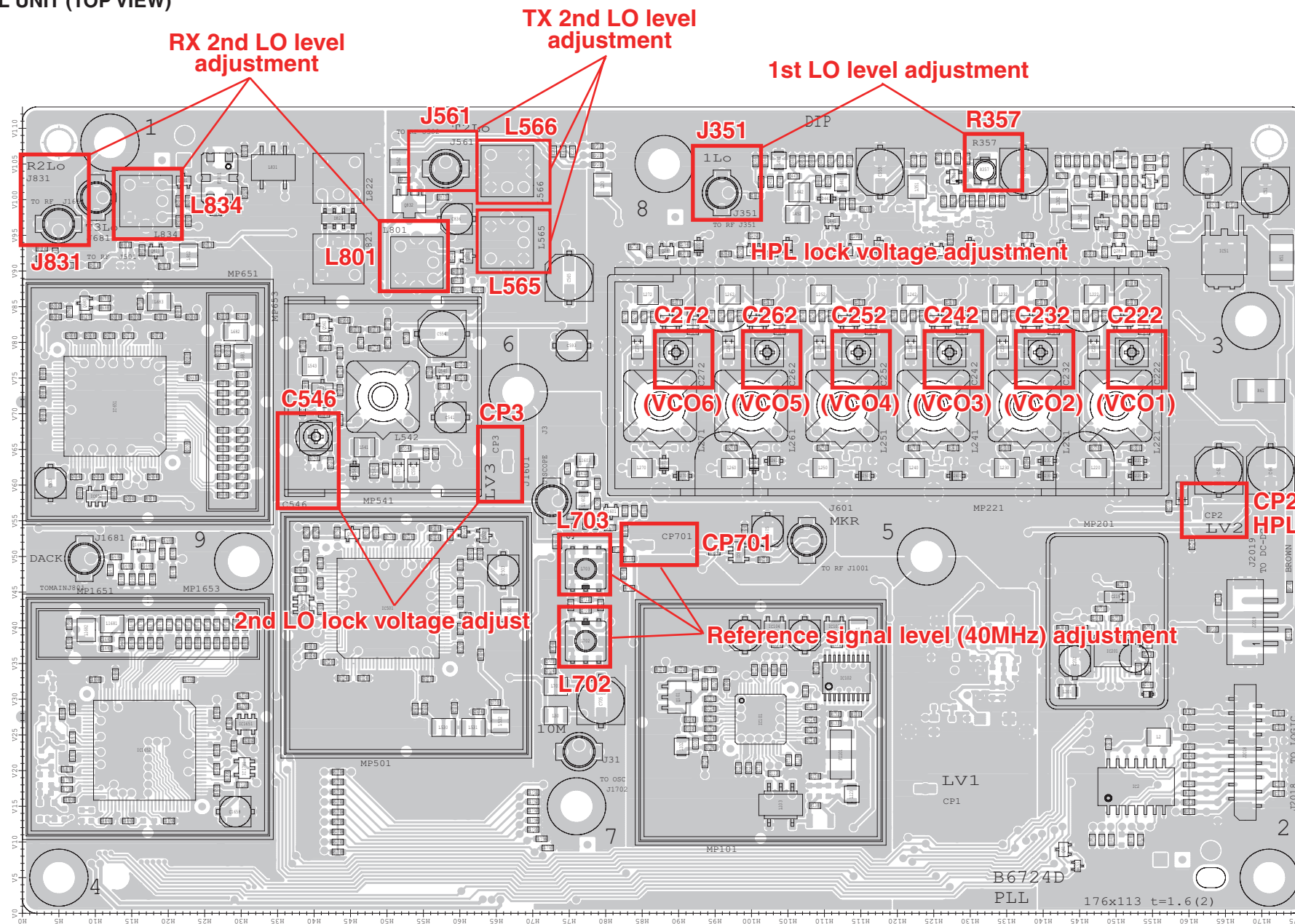

4-3 ADJUSTMENTS ON THE RF UNIT

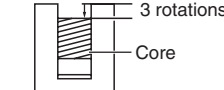
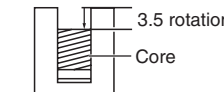
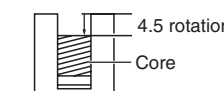
ADJUSTMENT	ADJUSTMENT CONDITION	OPERATION	ADJUSTMENT POINT	VALUE
PRERARATION (Preset)	1 • Frequency : 14.150 MHz • Mode : USB • ANTENNA : [ANT1] • [P.AMP1] : "ON" • Receiving	• Connect a Digital multimeter to CP1102" (RF UNIT) .	R1101 (RF UNIT)	4.4–4.6 V
		• Connect a Digital multimeter to CP1103" (RF UNIT) .	R1132 (RF UNIT)	4.4–4.6 V
		• Set R1228 (RF UNIT) to center position.  Center position	R1228 (RF UNIT)	Center position
(MCF-M)	4	• Set the L1401 and L1402 as below.  3 rotations Core	L1401, L1402 (MCF-M BOARD)	–
(MCF-W)	5	• Set the L1401 and L1402 as below.  3.5 rotations Core	L1401, L1402 (MCF-W BOARD)	–
(MCF-N)	6	• Set the L1401 and L1402 as below.  4.5 rotations Core	L1401, L1402 (MCF-N BOARD)	–
RECEIVE SENSITIVITY (HF BAND)	1 • Frequency : 14.150 MHz • Mode : USB • ANTENNA : [ANT1] • Receiving	1) Connect an SSG to the [ANT1] and set as; Frequency : 14.1515 MHz Level : 0 dB μ Modulation : None 2) Connect an AC Millivoltmeter to the [EXP-SP]. 3) Adjust the sensitivity with L1408 and L1058 .	L1408, L1058 (repeatedly) (RF UNIT)	Max. audio output level
IMAGE RESPONSE	1 • Frequency : 14.150 MHz • Mode : USB • ANTENNA : [ANT1] • Receiving	1) Connect an SSG to the [ANT1] and set as; Frequency : 14.0765 MHz Level : +94 dB μ Modulation : None 2) Connect an AC Millivoltmeter to the [EXP-SP]. 3) Adjust the sensitivity with R1516 and C1656 .	R1516, C1656 (RF UNIT)	Min. audio output level
RECEIVE SENSITIVITY (50 MHz BAND)	1 • Frequency : 50.0200 MHz • Mode : USB • ANTENNA : [ANT1] • [PREAMP2] : "ON" • Receiving	1) Connect an SSG to the [ANT1] and set as; Frequency : 50.0215 MHz Level : –10 dB μ Modulation : None 2) Connect an AC Millivoltmeter to the [EXP-SP]. 3) Adjust the sensitivity with L1222 .	L1222 (RF UNIT)	Max. audio output level
IF THROUGH (50 MHz)	1 • Frequency : 50.0200 MHz • Mode : USB • Receiving	1) Connect an SSG to the [ANT1] and set as; Frequency : 64.455 MHz Level : +94 dB μ Modulation : None 2) Monitoring the S-METER on the display, adjust the swing width with C1265 .	C1265 (RF UNIT)	Min. swing width

• RF UNIT (TOP VIEW)

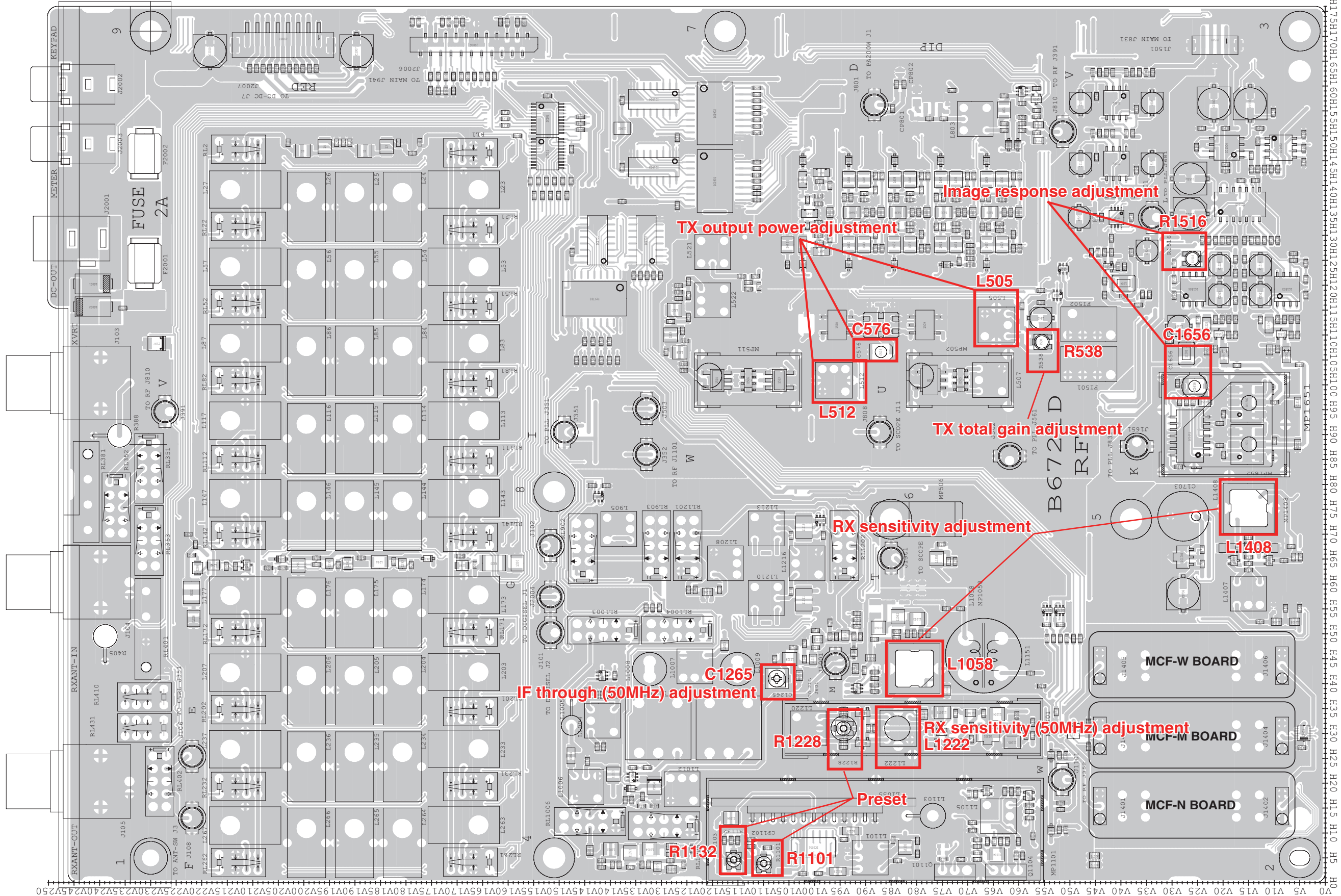

• MCF-M BOARD (TOP VIEW)

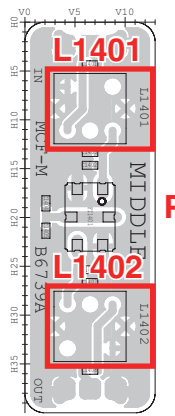

• MCF-N BOARD (TOP VIEW)

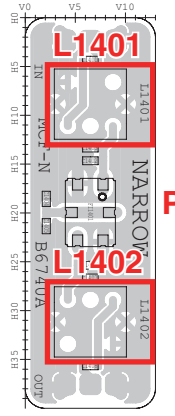

• MCF-W BOARD (TOP VIEW)

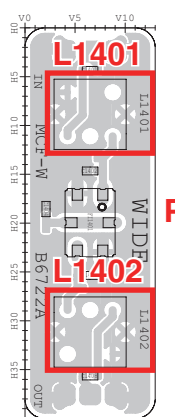

4-4 ADJUSTMENTS ON THE PA200W BOARD

ADJUSTMENT	ADJUSTMENT CONDITION	OPERATION	ADJUSTMENT POINT	VALUE	
IDLING (Preparation)	"IDLING" must be adjusted by cold-started.				
	1	<ul style="list-style-type: none"> • Mode : USB • MIC gain : Minimum 	<ul style="list-style-type: none"> • Connect an Audio Generator to the MIC jack (see the page 4-2) and set it as; <ul style="list-style-type: none"> Frequency : 1.5 kHz Level : 1 mV 	-	-
	2		<ul style="list-style-type: none"> 1) Set 3 variable resistors to the preset point. 2) Disconnect the W1 from the PA200W BOARD, and connect an Ammeter between the PA200W BOARD and W1. 3) Measure the driving current, and note it as the initial value. 	R301, R407, R410	Max. counter clockwise
IDLING (DRIVER AMP.)	1	<ul style="list-style-type: none"> • Frequency : 14.100 MHz • Mode : USB • Transmitting 	<ul style="list-style-type: none"> • Adjust the driving current with R301. 	R301	+1.0 A more than initial value
IDLING (FINAL AMP.)	1	<ul style="list-style-type: none"> • Frequency : 14.100 MHz • Mode : USB • Transmitting 	<ul style="list-style-type: none"> • Adjust the driving current with variable resistors. 	R407 (for main adjustment) R425 (for critical adjustment)	+2.0 A more than initial value
	2			R410 (for main adjustment) R426 (for critical adjustment)	+3.0 A more than initial value
	3	Apply slight vibration to the PA200W BOARD, and verify that the current is stable against the vibration.			

- ADJUSTMENT AND CHECK POINTS -

• PA200W BOARD
(TOP VIEW)

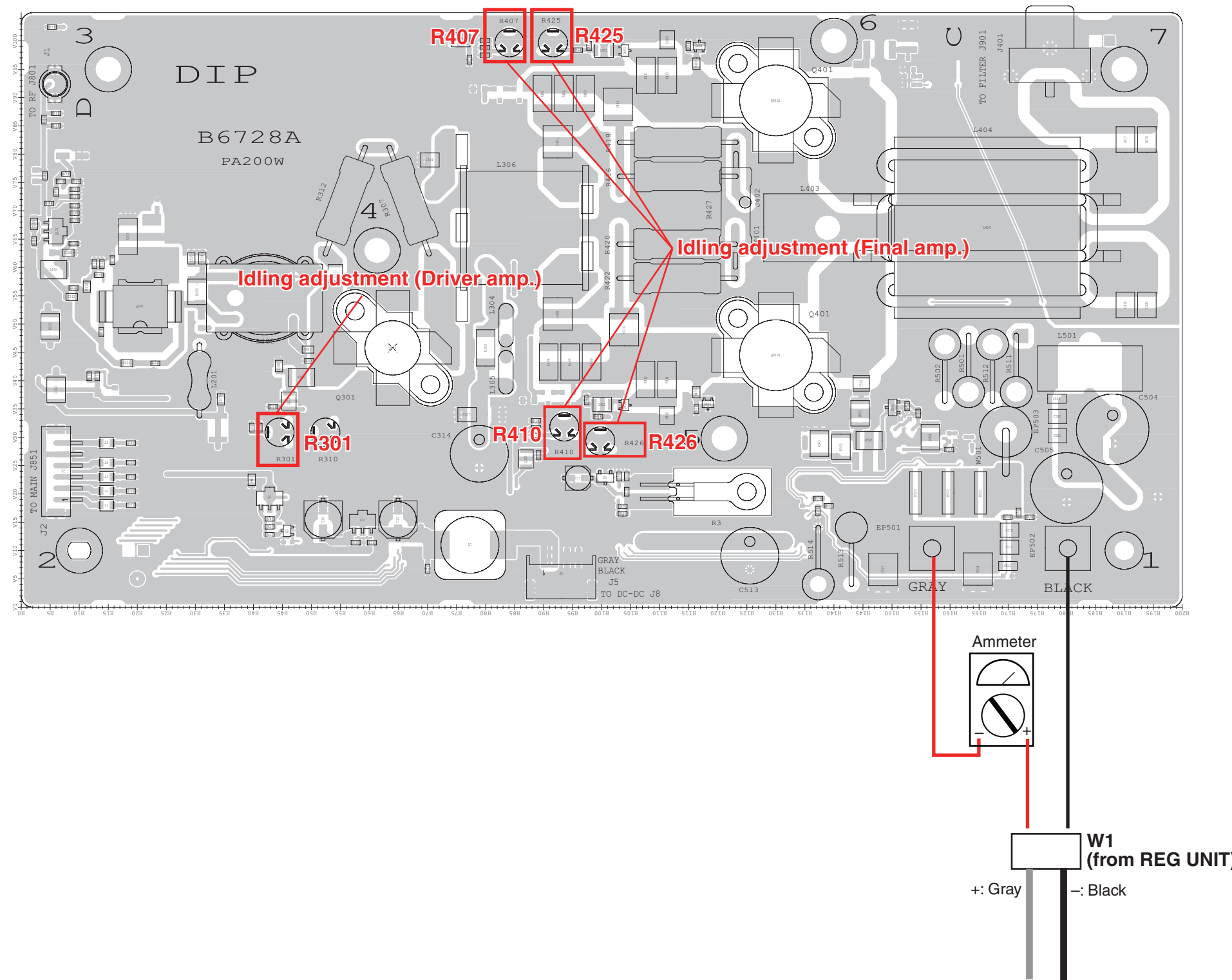

4-5 ADJUSTMENTS ON THE MAIN UNIT (including RF UNIT)

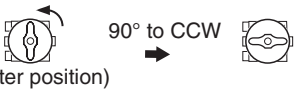
ADJUSTMENT	ADJUSTMENT CONDITION	OPERATION	ADJUSTMENT POINT	VALUE
PREPARATION (Preset)	1	• Receiving	1) Turn the power OFF. 2) Push and hold [F-INP]+[MW] keys, and turn the power ON (All clear).	–
	2		• Set the variable resistor to the preset point.	R2042
	3		• Set the variable resistor to the preset point.	R2006
	3		• Connect a Digital multimeter to the CP2001.	R2028
TRANSMIT OUTPUT POWER	1	• Frequency : 14.100 MHz • Mode : USB • Transmitting	1) Connect an Audio Generator to the MIC jack (see the page 4-2) and set it as; Frequency : 1.5 kHz Level : 1 mV 2) Connect an RF Power Meter to the [ANT1]. 3) Adjust the RF power.	L505→C576→ L512 (RF UNIT) (in sequence, repeatedly)
	2	• Frequency : 14.100 MHz • Mode : FM • MIC gain : Maximum • Transmitting	1) Set the SSG as; Frequency : 1 kHz Level : 10 mV 2) Connect an RF Power Meter to the [ANT1]. 3) Adjust the RF power.	C576 (RF UNIT)
TRANSMIT TOTAL GAIN	1	• Frequency : 14.100 MHz • Mode : USB • MIC gain : Center • Transmitting	1) Connect an Audio Generator to the MIC jack (see the page 4-2) and set it as; Frequency : 1.5 kHz Level : 1 mV 2) Connect an RF Power Meter to the [ANT1]. 3) Adjust the RF power.	R538 (RF UNIT)
TRANSMIT HIGH POWER (HF)	1	• Frequency : 14.100 MHz • Mode : RTTY • Transmitting	• Connect an RF Power Meter to the [ANT1].	R2072
TRANSMIT HIGH POWER (50 MHz)	1	• Frequency : 50.100 MHz • Mode : RTTY • Transmitting	• Connect an RF Power Meter to the [ANT1].	R2068
AM CARRIER POWER	1	• Frequency : 14.100 MHz • Mode : AM • MIC input : OFF • Transmitting	• Connect an RF Power Meter to the [ANT1].	R2065
APC Vd (Drain-Volatge)	1	• Frequency : 1.900 MHz • Mode : RTTY	• Connect the CP2051 to the GND.	CP2051
	2	• Transmitting	• Turn the R2042 max. counter clockwise.	R2042 (CCW rotation)
	3		• Adjust the RF power with R2042 .	R2042
	4		• Disconnect the CP2051 from the GND.	CP2051
APC Id (Drain-Current)	1	• Frequency : 24.900 MHz • Mode : RTTY	• Connect the CP2051, CP2041 to the GND.	CP2051, CP2041
	2	• MIC : OFF • Transmitting	• Set the variable resistor to the preset point.  (Center position) → 90° to CCW	R2006
	3		• Disconnect the W1 from the PA200W BOARD, and connect an Ammeter between the PA200W BOARD and W1.	R2006 (CW rotation)
	4		• Disconnect the CP2051 and CP2041 from the GND.	CP2051, CP2041

4-6 ADJUSTMENTS ON THE SCOPE UNIT

ADJUSTMENT	ADJUSTMENT CONDITION	OPERATION	ADJUSTMENT POINT	VALUE
PREPARATION (Common setting)	1 <ul style="list-style-type: none"> • Frequency : 14.200 MHz • Mode : CW • [P.AMP] : "OFF" • [SCOPE] : "ON" • [SCOPE ATT] : "OFF" • [SPAN] : ±25 kHz 	–	–	–
3rd LO LOCK VOLTAGE	1	–	1) Connect a Digital multimeter to the CP801. 2) Adjust the lock voltage.	C824 2.2–2.8 V
SCOPE	1	• Receiving	• Connect a Signal Generator to [ANT1] and set as; Frequency : 14.200 MHz Modulation : None Level : +54 dBμ	L203→L202→L201→L5→L6→C41 (in sequence) and L5, L6, C41 (repeatedly) Maximum waveform on the SCOPE screen
	2	• Receiving	• Connect a Signal Generator to J1 (SCOPE UNIT) and set as; Frequency : 71.715 MHz Modulation : None Level : +100 dBμ	C41 Minimum waveform on the SCOPE screen
	3	• Receiving	• Connect a Signal Generator to [ANT1] and set as; Frequency : 14.200 MHz Modulation : None Level : +54 dBμ	L5, L6 (repeatedly) Maximum waveform on the SCOPE screen
SCOPE GAIN	1	• Receiving	• Adjust the waveform to set the peak of the wave spectrum reaches the 6th scale.	R416 (see fig. 1).
SCOPE ATTENUATION	1	• [SCOPE ATT] : 30 dB • Receiving	• Adjust the waveform to set the peak of the wave spectrum reaches the 3rd scale.	R11 (see fig. 2)

<fig. 1>

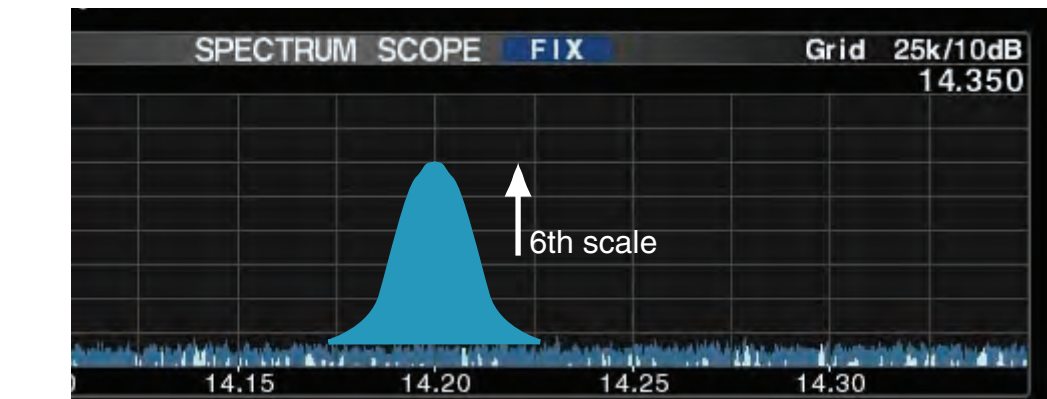

<fig. 2>

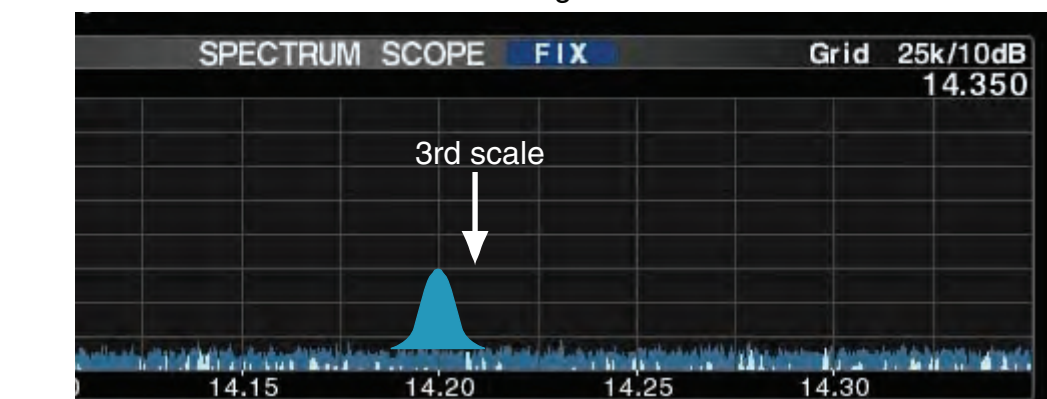

4-7 AUTOMATIC ADJUSTMENTS

■ ENTERING AUTOMATIC ADJUSTMENT MODE

- 1) Connect the short plug to the [REMOTE] terminal (see the illust below).
- 2) Push and hold [SSB]+[CW] keys and turn the power ON, then the adjustment main menu appears.
- 3) When the automatic adjustments are finished, turn the power OFF to quit the adjustment mode.

<Main menu>

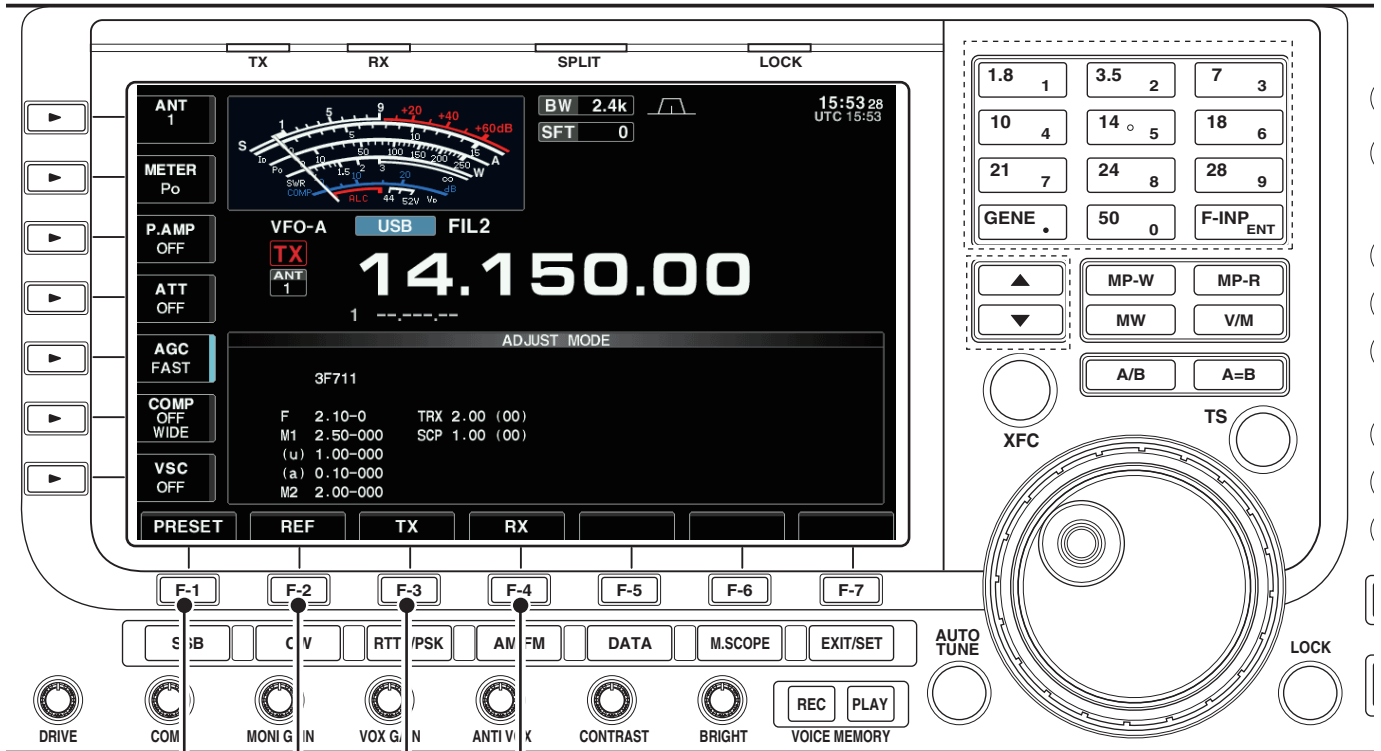

Receiver adjustment (page 4-15)

Transmitter adjustment (page 4-13)

CAUTION: When a TX adjustment item is selected, the transceiver transmits automatically.

Reference frequency adjustment (page 4-17)

Other adjustment (page 4-17)

• CONNECTION

<Rear view>

Short plug

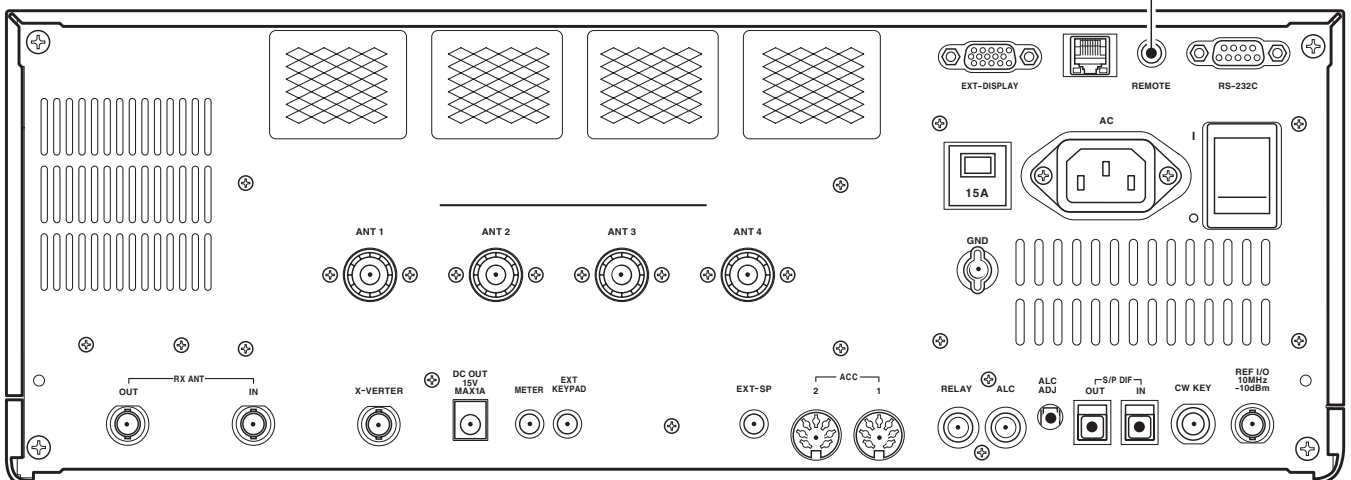

• Short plug

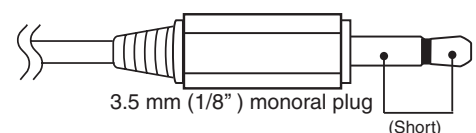

4-7-1 AUTOMATIC ADJUSTMENTS (TRANSMITTER)

<TX adjustment screen>

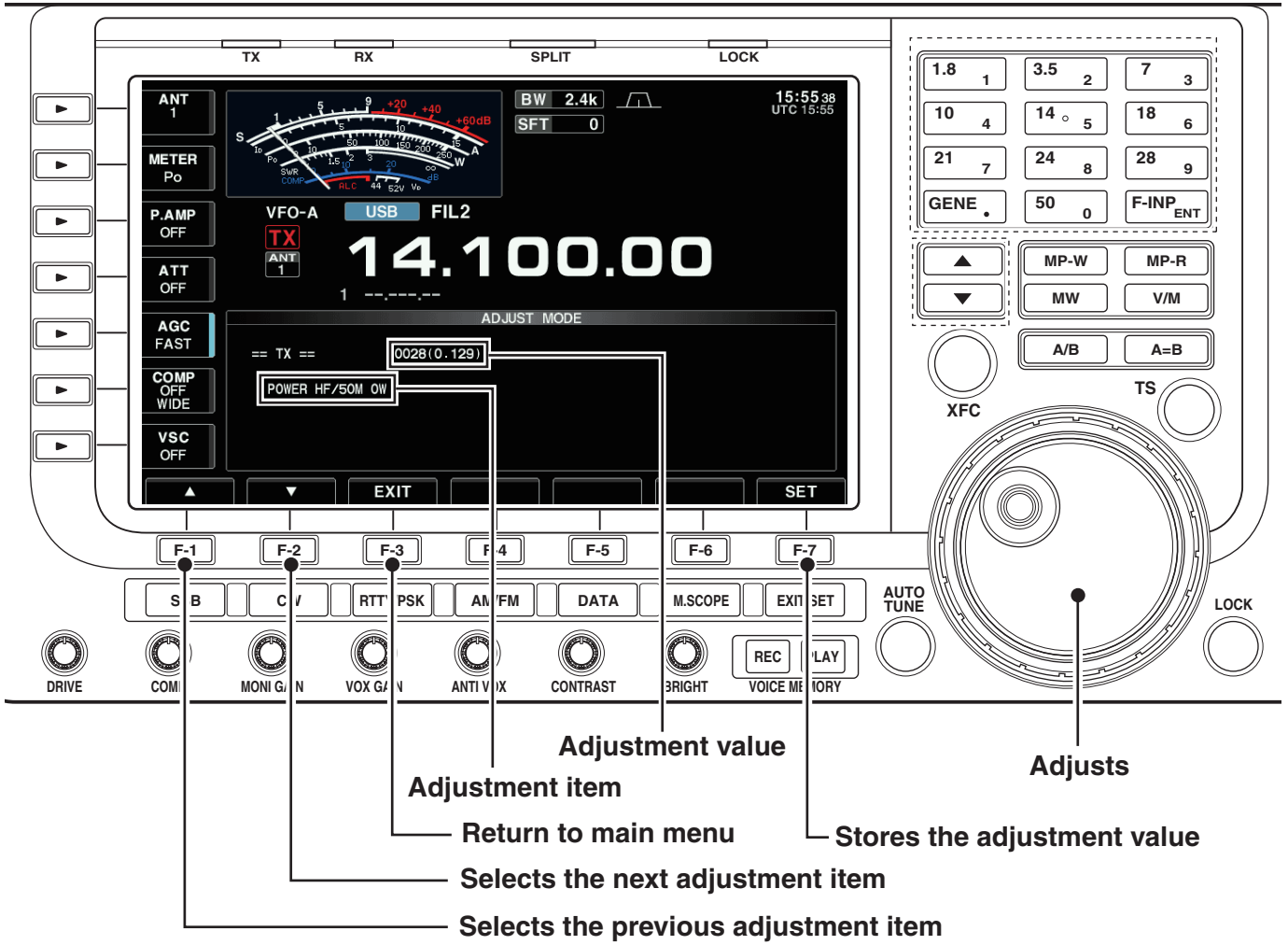

• CONNECTION FOR TX ADJUSTMENTS

RF Power Meter 100 ohm Dummy Load (SWR=2)

<Rear view>

Short plug
(see page 4-12)

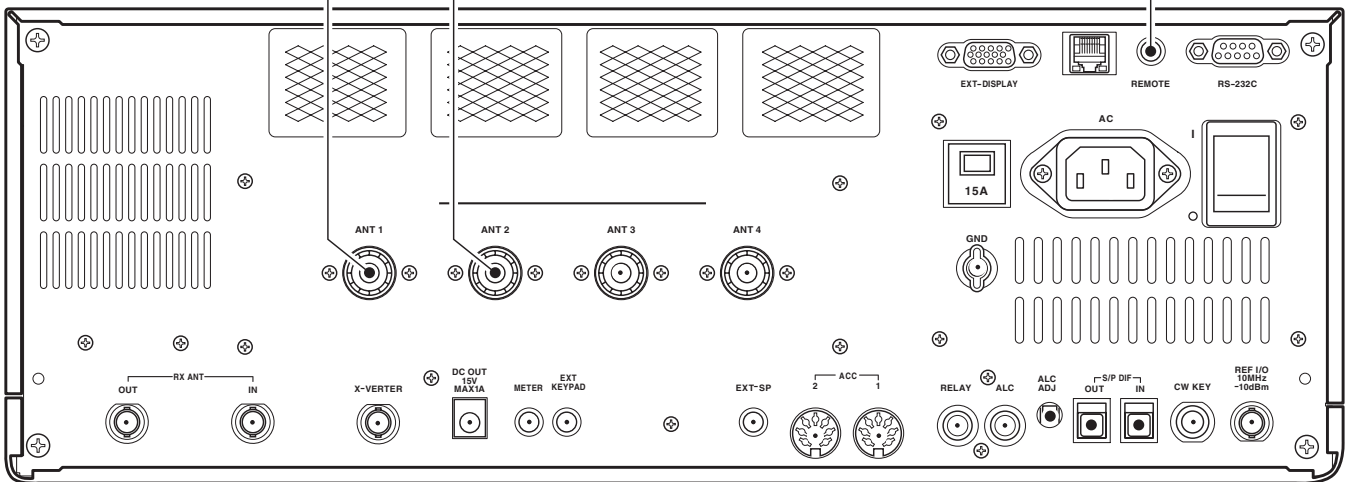

<Front view>

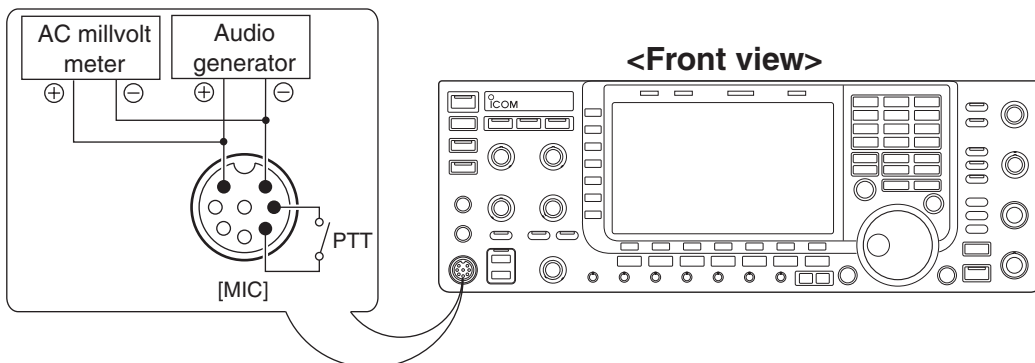

4-7-2 AUTOMATIC ADJUSTMENTS (TRANSMITTER)

ADJUSTMENT	ADJUSTMENT CONDITION	OPERATION	ADJUSTMENT ITEM	VALUE
PREPARATION	1	1) Connect an Audio Generator to the MIC jack and set it as; Frequency : 1.5 kHz Level : 10 mV 2) Connect an RF power meter to the [ANT1]. 3) Connect an terminator (SWR=2) to the [ANT2].	-	-
POWER METER (HF BAND) <Preset>	1	-	[POWER HF/50M 0W]	-
<10 W>	2	• Transmitting (Automatically)	[POWER HF 10W]	10 W
<50 W>	3	• Transmitting (Automatically)	[POWER HF 50W]	50 W
<100 W>	4	• Transmitting (Automatically)	[POWER HF 100W]	100 W
<150 W>	5	• Transmitting (Automatically)	[POWER HF 150W]	150 W
<200 W>	6	• Transmitting (Automatically)	[POWER HF 200W]	195 W
POWER METER (50 MHz BAND)	7	• Transmitting (Automatically)	[POWER 50M 10W]	10 W
<50 W>	8	• Transmitting (Automatically)	[POWER 50M 50W]	50 W
<100 W>	9	• Transmitting (Automatically)	[POWER 50M 100W]	100 W
<150 W>	10	• Transmitting (Automatically)	[POWER 50M 150W]	150 W
<195 W>	11	• Transmitting (Automatically)	[POWER 50M 200W]	195 W
[RESERVE POWER SET] (NO AJUSTMENT)	1	-	-	-
POWER DOWN	1	• Transmitting (Automatically)	[POWER for Power Down HF/50M]	100 W
ALC METER	1	• Transmitting (Automatically)	[ALC]	(Automatic adjustment)
DRIVE LEVEL	1	• Transmitting (Automatically)	[DRIVE]	(Automatic adjustment)
DRAIN VOLTAGE METER	1	• Transmitting (Automatically)	[Vd48V]	(Automatic adjustment)
DRAIN CURRENT METER	1	• Transmitting (Automatically)	[Id 0A]	-
0A				
5A	2	• Transmitting (Automatically)	[Id 5A]	5 A
10A	3	• Transmitting (Automatically)	[Id 10A]	10 A
SWR METER	1	• Transmitting (Automatically)	[SWR]	(Automatic adjustment)

4-7-2 AUTOMATIC ADJUSTMENTS (RECEIVER)

<RX adjustment screen>

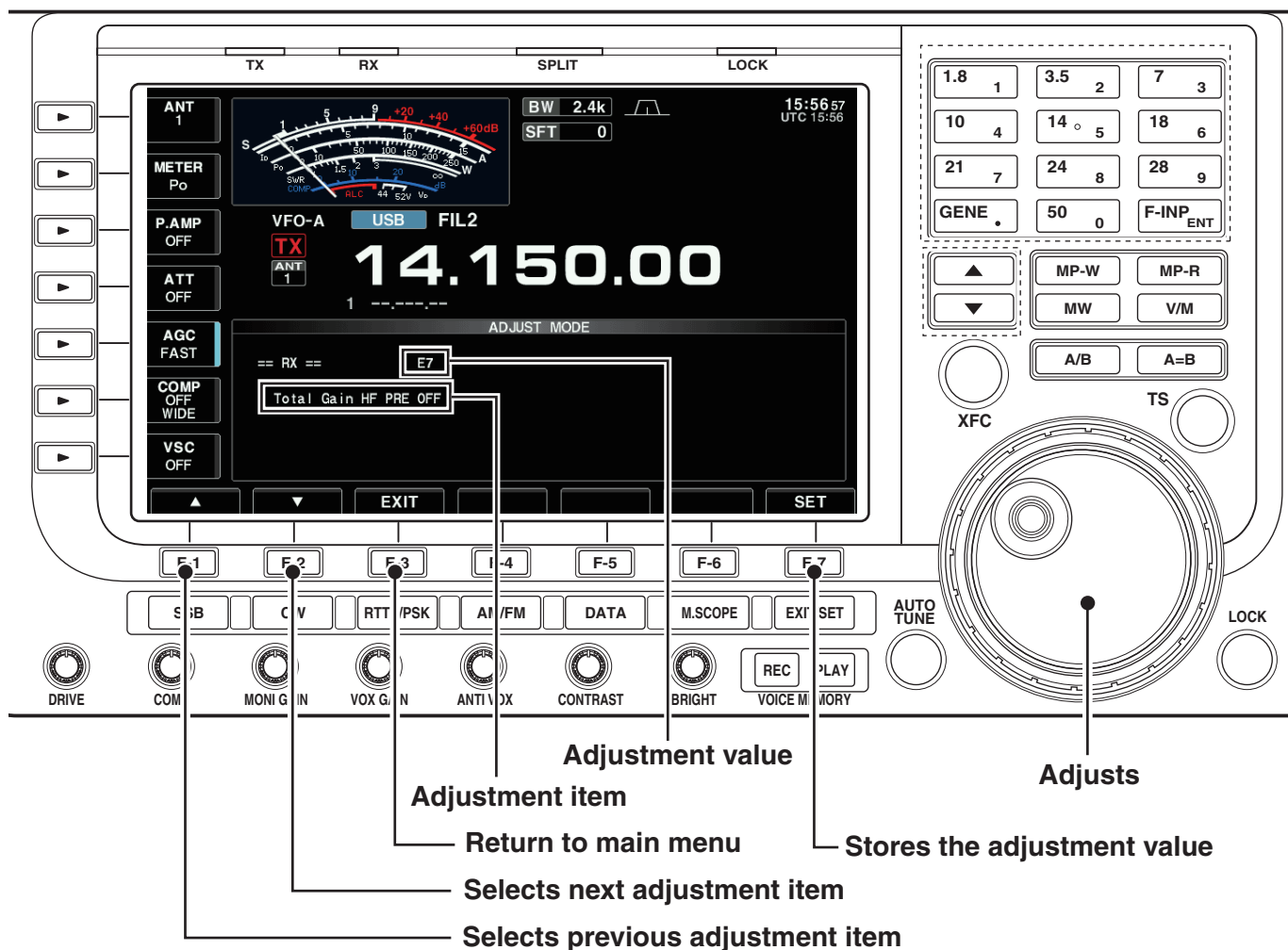

• CONNECTION FOR RX ADJUSTMENTS

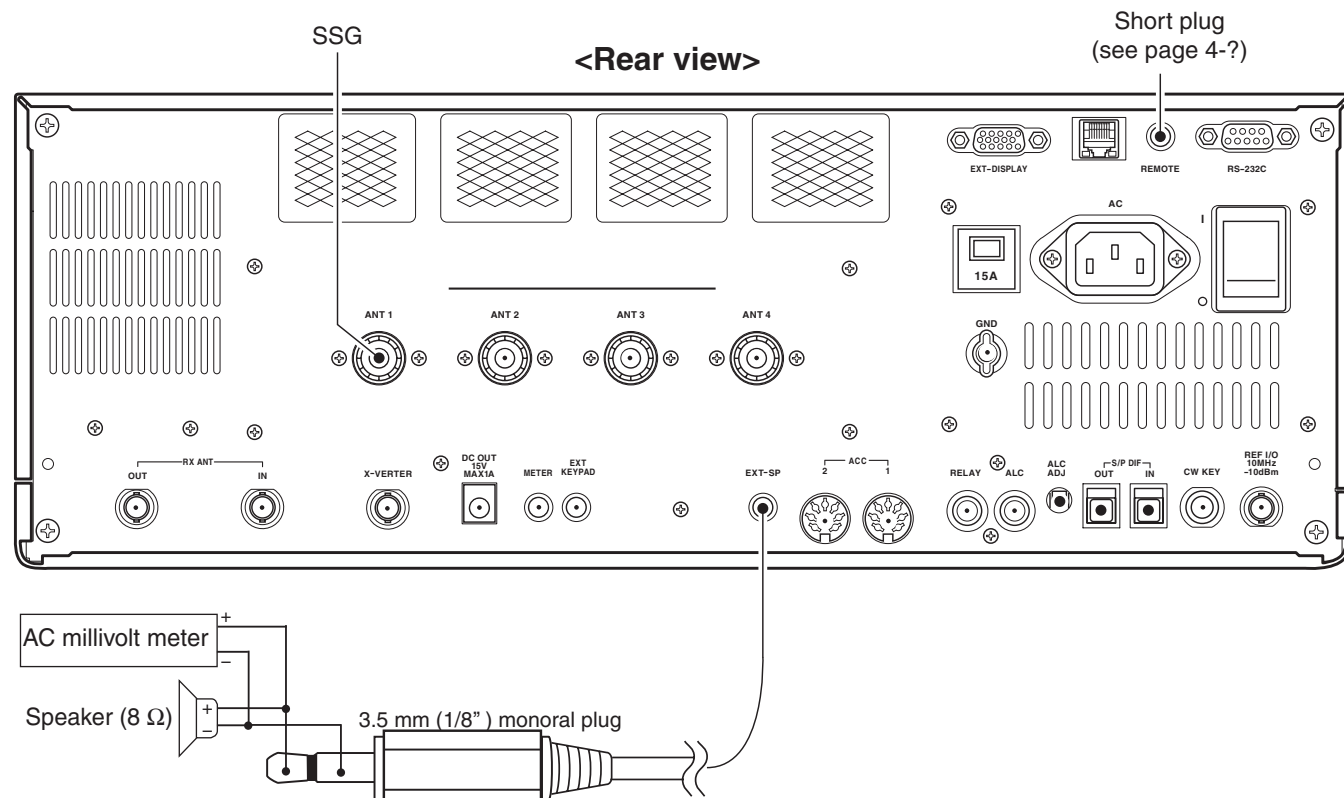

4-7-2 AUTOMATIC ADJUSTMENTS (RECEIVER)

ADJUSTMENT	ADJUSTMENT CONDITION	OPERATION	ADJUSTMENT ITEM	VALUE
TOTAL GAIN (PREPARATION)	1 • Receiving	1) Connect an AC millivoltmeter to [EXT-SP]. 2) Connect an SSG to the [ANT1] and set it as; Frequency : 14.1515 MHz Modulation : None	-	-
HF (P.AMP OFF)	1 • Receiving	1) Set the SSG as; Level : +60 dB μ 2) Set the audio output level to 0 dB (Set it as reference). 3) Set the SSG as; Level : "OFF" 4) Adjust the AF output level using [MAIN DIAL], then push [F-7] key.	[Total Gain HF PRE OFF]	-30 dB
HF (P.AMP ON)	2 • Receiving	• Adjust the AF output level using [MAIN DIAL], then push [F-7] key.	[Total Gain HF PRE ON]	
50MHz (P.AMP OFF)	3 • Receiving	• Adjust the AF output level using [MAIN DIAL], then push [F-7] key.	[Total Gain 50M PRE OFF]	
50MHz (P.AMP ON)	4 • Receiving	• Adjust the AF output level using [MAIN DIAL], then push [F-7] key.	[Total Gain 50M PRE ON]	
EXTERNAL AGC	1 • Receiving	1) Set the SSG as; Level : +70 dB μ 2) Push [F-7] key. 3) Wait until the beep "Pi!" sounds (approx. 20 sec.) NEVER CHANGE the SSG output level until the beep sounds.	[AGC]	(Automatic adjustment)
HF S-METER HF (S0 LEVEL)	1 • Receiving	1) Set the SSG as; Level : "OFF" 2) Push [F-7] key. (the beep "Pi!" sounds) 3) Soon, another beeps "PiPi!" sound. NEVER CHANGE the SSG output level until the 2nd beep sounds.	[HF S0 LEVEL]	
HF (S9 LEVEL)	2 • Receiving	1) Set the SSG as; Level : +34 dB μ 2) Push [F-7] key. (the beep "Pi!" sounds) 3) Soon, another beeps "PiPi!" sound. NEVER CHANGE the SSG output level until the 2nd beep sounds.	[HF S9 LEVEL]	(Automatic adjustment)
HF (S9+60 dBu LEVEL)	3 • Receiving	1) Set the SSG as; Level : +94 dB μ 2) Push [F-7] key. (the beep "Pi!" sounds) 3) Soon, another beeps "PiPi!" sound. NEVER CHANGE the SSG output level until the 2nd beep sounds.	[HF S9+60 LEVEL]	
50MHz S-METER 50MHz (S0 LEVEL)	4 • Receiving	1) Set the SSG as; Frequency : 50.1515 MHz Modulation : None Level : "OFF" 2) Push [F-7] key. (the beep "Pi!" sounds) 3) Soon, another beeps "PiPi!" sound. NEVER CHANGE the SSG output level until the beep sounds.	[50M S0 LEVEL]	
50MHz (S9 LEVEL)	5 • Receiving	1) Set the SSG as; Level : +34 dB μ 2) Push [F-7] key. (the beep "Pi!" sounds) 3) Soon, another beeps "PiPi!" sound. NEVER CHANGE the SSG output level until the beep sounds.	[50M S9 LEVEL]	(Automatic adjustment)
50MHz (S9+60 dBu LEVEL)	6 • Receiving	1) Set the SSG as; Level : +94 dB μ 2) Push [F-7] key. (the beep "Pi!" sounds) 3) Soon, another beeps "PiPi!" sound. NEVER CHANGE the SSG output level until the beep sounds. 4) (Returns to adjustment main menu)	[50MHz (S9+60 dBu LEVEL)]	

4-7-3 REFERENCE FREQUENCY

<Reference frequency adjustment screen>

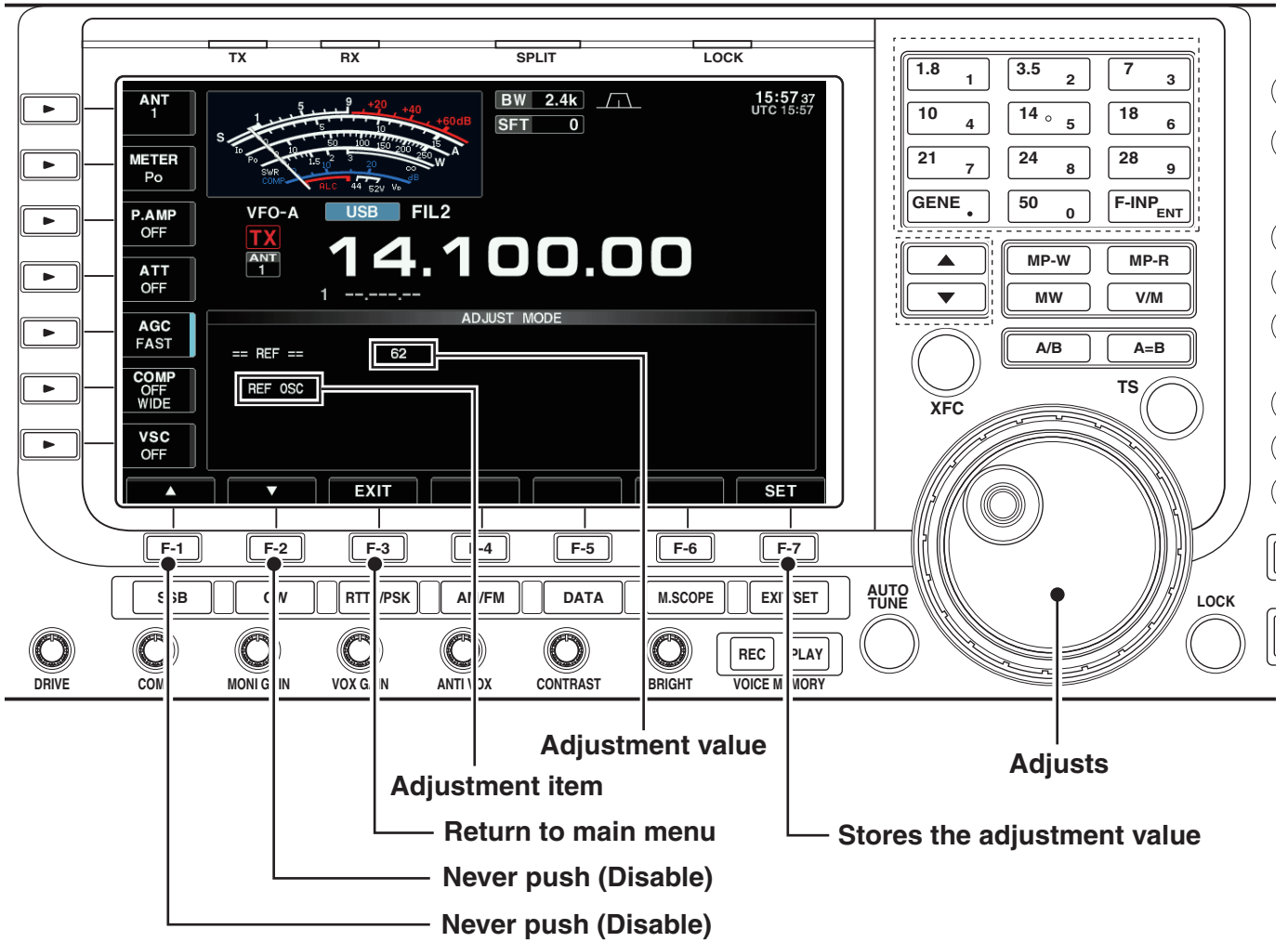

• CONNECTION FOR RX ADJUSTMENTS

<Rear view>

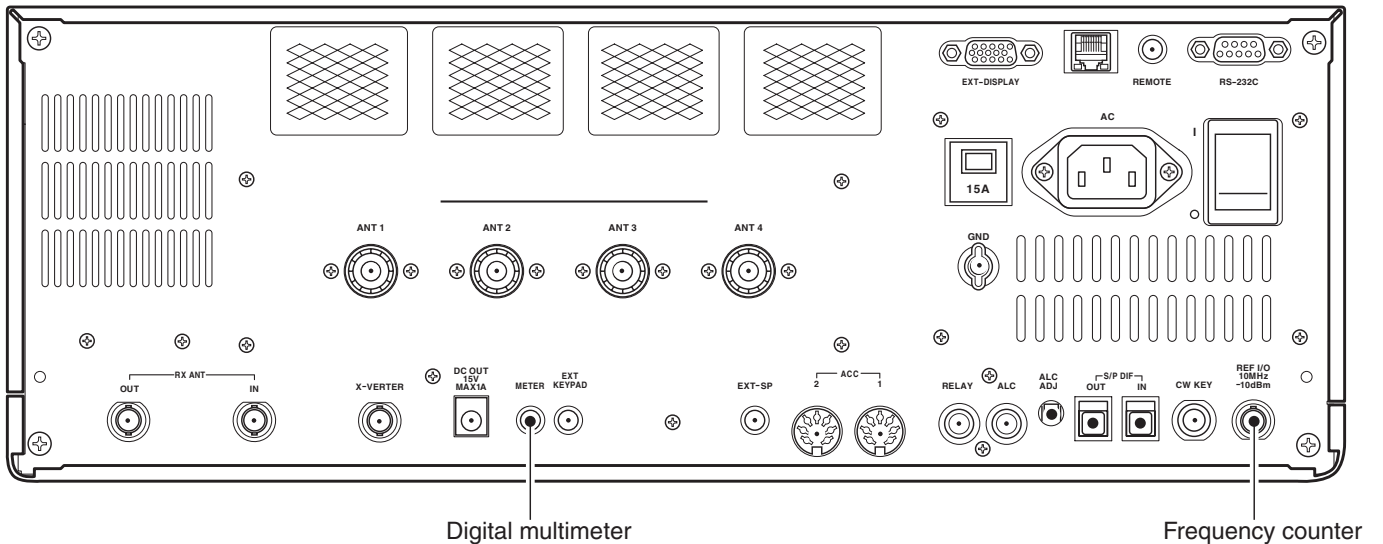

4-7-3 REFERENCE FREQUENCY

ADJUSTMENT		ADJUSTMENT CONDITION	OPERATION	ADJUSTMENT ITEM	VALUE
REFERENCE FREQUENCY	1	• Wait more than 5 min. from turning main power ON with [I/O] on the rear panel, then adjust the reference frequency.	1) Connect a Frequency Counter to the [REF I/O] connector. 2) Adjust the reference frequency using [MAIN DIAL].	[REF]	10.000000 MHz (±0.1 Hz)

4-7-4 OTHER ADJUSTMENTS

ADJUSTMENT		ADJUSTMENT CONDITION	OPERATION	ADJUSTMENT ITEM	VALUE
PRESET EXT. METER	1	–	1) Connect a Voltage meter to the [METER] terminal. 2) Adjust the voltage using [MAIN DIAL]. 3) Push [F-7] key.	[EXT. METER]	0 V
PRESET DIGISEL VR	1	–	1) Set the [DIGI-SEL] (on the front panel) to center. 2) Push [F-7] key.	[DIGISEL VR]	Center position

SECTION 5

PARTS LIST

[RF UNIT]

REF NO.	ORDER NO.	DESCRIPTION	M.	H/V LOCATION
IC101	1130011510	S.IC BU2099FV-E2	T	146.4/152.3
IC102	1130011510	S.IC BU2099FV-E2	T	153.5/152.3
IC501	1110006100	S.IC NJM5534MD-TE1	T	156.6/40.9
IC502	1110006100	S.IC NJM5534MD-TE1	T	144.4/40.9
IC503	1110005461	S.IC TA4107F (TE12L,F)	T	133.6/40.9
IC1051	1190002010	S.IC SD5400CY <TOMO>	T	7.1/100.2
IC1081	1110006180	S.IC UPG2009TB-E3	T	39.9/1.7
IC1402	1190002110	S.IC NJG1519KC1-TE3	T	30.5/49.3
IC1403	1190002110	S.IC NJG1519KC1-TE3	T	30/4.2
IC1501	1110006121	S.IC DBM9A41-G-TR	T	88/15.3
IC1502	1110006121	S.IC DBM9A41-G-TR	T	96.5/15.3
IC1503	1110006100	S.IC NJM5534MD-TE1	T	119.2/7.5
IC1504	1110006100	S.IC NJM5534MD-TE1	T	119.2/25.9
IC1505	1110006190	S.IC NJM074M-TE1	T	136.2/16.7
IC1506	1110006100	S.IC NJM5534MD-TE1	T	147.6/19.3
IC1651	1130011921	S.IC TC74LCX00F (EL,F)	T	89.7/26.5
IC1652	1110005420	S.IC BA15532F-E2	T	147.6/8.7
IC1653	1110005100	S.IC NJM072BM-TE1	B	156/8.7
IC1701	1130011530	S.IC CD74HC4094M96	T	129/142.5
IC1702	1130011530	S.IC CD74HC4094M96	T	129/133
IC1703	1160000131	S.IC TD62783AFG (S,EL)	T	117.3/143.1
IC1704	1180000790	S.IC AN78L10M (E1)	T	65.4/27.8
IC1901	1160000131	S.IC TD62783AFG (S,EL)	T	140.9/119.5
IC1902	1160000131	S.IC TD62783AFG (S,EL)	T	154.5/119.5
IC1903	1130011530	S.IC CD74HC4094M96	T	143.7/131.5
IC1904	1130011530	S.IC CD74HC4094M96	T	157.3/131.5
Q260	1590001330	S.TR DTA114EUA T106	T	63.8/211.2
Q320	1590001330	S.TR DTA114EUA T106	B	63.8/211.4
Q381	1590000680	S.TR DTC114EUA T106	B	86.4/237
Q383	1590000680	S.TR DTC114EUA T106	B	106.6/231.2
Q384	1590000680	S.TR DTC114EUA T106	B	110/231.2
Q385	1590000680	S.TR DTC114EUA T106	B	101.5/240
Q386	1590000680	S.TR DTC114EUA T106	B	105.4/236.8
Q387	1590000680	S.TR DTC114EUA T106	B	86.4/234.1
Q401	1530002841	S.TR 2SC4116-Y (TE85R,F)	B	50.8/233.9
Q402	1530002060	S.TR 2SC4081 T106 R	B	54.2/236.2
Q403	1590001330	S.TR DTA114EUA T106	B	54.2/233.4
Q404	1590000680	S.TR DTC114EUA T106	B	50.8/236.7
Q421	1590000680	S.TR DTC114EUA T106	B	88.8/145.7
Q422	1590000680	S.TR DTC114EUA T106	B	92.3/145.6
Q501	1580000751	S.FET 3SK294 (TE85L,F)	T	123.7/42.5
Q502	1590000680	S.TR DTC114EUA T106	B	118.1/52.2
Q503	1590002710	S.TR UMH11NTN	T	118/52.5
Q504	1560000561	S.FET 2SK882-GR (TE85L,F)	B	109.2/59
Q506	1560000561	S.FET 2SK882-GR (TE85L,F)	B	106.7/99.1
Q507	1530003151	S.TR 2SC4673D-TD-E	B	87.2/118.2
Q508	1530003841	S.TR 2SC5501-4-TR-E	B	121.7/120
Q509	1590001960	S.TR XP4311 (TX)	T	123.2/51.3
Q801	1530003851	S.TR 2SC5551F-TD-E	B	162.2/68.6
Q802	1520000531	S.TR 2SB1119S-TD-E	B	159/97.5
Q803	1590000680	S.TR DTC114EUA T106	B	166.6/96.9
Q804	1590002710	S.TR UMH11NTN	T	158.9/59.4
Q805	1590000680	S.TR DTC114EUA T106	T	157.3/56.6
Q901	1590001960	S.TR XP4311 (TX)	T	77.5/142.3
Q902	1530003851	S.TR 2SC5551F-TD-E	B	65/139.3
Q1005	1590001960	S.TR XP4311 (TX)	T	41.6/141.6
Q1006	1530003851	S.TR 2SC5551F-TD-E	B	25.9/142.3
Q1007	1530003851	S.TR 2SC5551F-TD-E	B	35.4/130.6
Q1008	1530003851	S.TR 2SC5551F-TD-E	B	35.4/116.8
Q1101	1530003860	TR 2SC3950D		
Q1102	1590000680	S.TR DTC114EUA T106	T	18.5/66.3
Q1103	1520000561	S.TR 2SB1123 T-TD-E	B	15.4/72.3
Q1104	1530003860	TR 2SC3950D		
Q1105	1530003841	S.TR 2SC5501-4-TR-E	T	17.5/58
Q1205	1590001960	S.TR XP4311 (TX)	T	21.2/135.7
Q1209	1530003851	S.TR 2SC5551F-TD-E	B	50.3/109.5
Q1210	1530003851	S.TR 2SC5551F-TD-E	B	64.5/109.5
Q1211	1560001311	S.FET MMBFU310LT1G	T	28/90.6
Q1212	1560001311	S.FET MMBFU310LT1G	T	34/90.6
Q1213	1590000680	S.TR DTC114EUA T106	B	30/63.2
Q1214	1520000561	S.TR 2SB1123 T-TD-E	B	32/73.4
Q1301	1530003151	S.TR 2SC4673D-TD-E	T	29.7/66.1
Q1352	1530003851	S.TR 2SC5551F-TD-E	B	60.9/77.5
Q1401	1530003841	S.TR 2SC5501-4-TR-E	B	58.4/15
Q1402	1530003021	S.TR 2SC4402-3-TL-E	T	64.7/17.8
Q1403	1530003021	S.TR 2SC4402-3-TL-E	T	64.7/10.9
Q1501	1530003450	S.TR 2SC4835-R (TX)	T	110.2/8.6
Q1502	1530003450	S.TR 2SC4835-R (TX)	T	110.2/20.8
Q1651	1530002601	S.TR 2SC4215-O (TE85R,F)	B	98.3/35.1
Q1701	1590001960	S.TR XP4311 (TX)	T	72.7/98.9
Q1702	1590001960	S.TR XP4311 (TX)	T	54.7/52
Q1703	1590001960	S.TR XP4311 (TX)	T	54.7/54.5
Q2001	1530002060	S.TR 2SC4081 T106 R	B	160.7/233.8
Q2002	1590001330	S.TR DTA114EUA T106	B	146.5/142.6
D1	1790001250	S.DIO MA2S111-(TX)	B	147/218.8
D21	1790001250	S.DIO MA2S111-(TX)	B	131.5/218.8
D51	1790001250	S.DIO MA2S111-(TX)	B	116/218.8
D81	1790001250	S.DIO MA2S111-(TX)	B	100.6/218.8
D111	1790001250	S.DIO MA2S111-(TX)	B	85/218.8
D141	1790001250	S.DIO MA2S111-(TX)	B	69.5/218.8
D171	1790001250	S.DIO MA2S111-(TX)	B	50/218.8
D201	1790001250	S.DIO MA2S111-(TX)	B	34.5/218.8
D231	1790001250	S.DIO MA2S111-(TX)	B	19.1/218.8
D260	1750000581	S.DIO 1SV307 (TPH3,F)	T	65.1/175.7

[RF UNIT]

REF NO.	ORDER NO.	DESCRIPTION	M.	H/V LOCATION
D261	1790001250	S.DIO MA2S111-(TX)	B	3.8/218.8
D262	1750000581	S.DIO 1SV307 (TPH3,F)	T	65/204.5
D320	1750000581	S.DIO 1SV307 (TPH3,F)	B	65.1/175.7
D321	1750000581	S.DIO 1SV307 (TPH3,F)	B	65/204.5
D351	1790001250	S.DIO MA2S111-(TX)	B	87/227.1
D352	1790001250	S.DIO MA2S111-(TX)	B	83.1/233.5
D353	1790001250	S.DIO MA2S111-(TX)	B	72.6/227.1
D373	1790001250	S.DIO MA2S111-(TX)	B	78.5/242.3
D391	1750000581	S.DIO 1SV307 (TPH3,F)	B	95.7/233
D392	1750000581	S.DIO 1SV307 (TPH3,F)	B	95.7/236.5
D393	1750000581	S.DIO 1SV307 (TPH3,F)	B	92.7/236.5
D401	1790001250	S.DIO MA2S111-(TX)	B	50.9/228.5
D402	1790000980	S.DIO MA742 (TX)	B	46.1/235.1
D410	1790001250	S.DIO MA2S111-(TX)	B	37/224.9
D421	1790000620	S.DIO MA77 (TX)	B	86/143
D422	1790000620	S.DIO MA77 (TX)	B	95/143
D423	1790000620	S.DIO MA77 (TX)	B	88.7/136.9
D424	1790000620	S.DIO MA77 (TX)	B	92.5/136.9
D431	1790001250	S.DIO MA2S111-(TX)	B	30.9/224.9
D501	1790000620	S.DIO MA77 (TX)	B	107.1/41
D502	1790000620	S.DIO MA77 (TX)	B	115/41
D503	1790000620	S.DIO MA77 (TX)	B	104.5/53.9
D504	1790000620	S.DIO MA77 (TX)	B	112.4/53.9
D505	1750000431	S.DIO HSB88WSTR-E	T	100.9/71.4
D506	1750000431	S.DIO HSB88WSTR-E	T	100.9/113
D536	1790001250	S.DIO MA2S111-(TX)	B	114.6/105.5
D601	1790000620	S.DIO MA77 (TX)	B	124.1/60.2
D602	1790000620	S.DIO MA77 (TX)	B	145.1/60.2
D603	1790000620	S.DIO MA77 (TX)	B	124.1/71
D604	1790000620	S.DIO MA77 (TX)	B	145.1/71
D605	1790000620	S.DIO MA77 (TX)	B	124.1/81.8
D606	1790000620	S.DIO MA77 (TX)	B	145.1/81.8
D607	1790000620	S.DIO MA77 (TX)	B	124.1/92.6
D608	1790000620	S.DIO MA77 (TX)	B	145.1/92.6
D609	1790000620	S.DIO MA77 (TX)	B	124.1/103.5
D610	1790000620	S.DIO MA77 (TX)	B	145.1/103.5
D611	1790000620	S.DIO MA77 (TX)	T	124.1/66.3
D612	1790000620	S.DIO MA77 (TX)	T	145.1/66.3
D613	1790000620	S.DIO MA77 (TX)	T	124.1/74.2
D614	1790000620	S.DIO MA77 (TX)	T	145.1/75.3
D615	1790000620	S.DIO MA77 (TX)	T	124.1/84.4
D616	1790000620	S.DIO MA77 (TX)	T	145.1/84.3
D617	1790000620	S.DIO MA77 (TX)	T	124.1/93.3
D618	1790000620	S.DIO MA77 (TX)	T	145.1/93.3
D619	1790000620	S.DIO MA77 (TX)	T	124.1/102.3
D620	1790000620	S.DIO MA77 (TX)	T	145.1/102.3
D801	1790000620	S.DIO MA77 (TX)	T	148.2/62
D802	1750000581	S.DIO 1SV307 (TPH3,F)	T	148.2/60.2
D806	1790000620	S.DIO MA77 (TX)	B	89.3/94.5
D873	1790001250	S.DIO MA2S111-(TX)	B	27.7/226.1
D1001	1750000581	S.DIO 1SV307 (TPH3,F)	T	18.9/136
D1101	1790000620	S.DIO MA77 (TX)	T	10.6/53.7
D1102	1790000620	S.DIO MA77 (TX)	T	25.5/53.7
D1201	1750000581	S.DIO 1SV307 (TPH3,F)	T	46.3/92.3
D1653	1750000550	S.DIO 1SS355 TE-17	B	149.6/11.4
D1654	1750000550	S.DIO 1SS355 TE-17	B	149.7/6
D1701	1790001670	S.DIO RB706F-40T106	B	161.9/14.3
D2001	1790001750	S.DIO DSM3MA4	T	120.2/241.3
D2002	1790001750	S.DIO DSM3MA4	T	115.6/241.3
D2003	1790001670	S.DIO RB706F-40T106	B	165.6/240.3
D2004	1750000550	S.DIO 1SS355 TE-17	B	154.7/234
FI501	2020001070	CER CFWLA455KJFA-B0 (CFWS455D)		
FI502	2020001510	CER CFWLA455KJFA-B0 (CFWS455IT)		
FI503	20100002580	S.FIL FL-348 (64.455 MHz)	T	112/87
L1	6200005521	S.COL NLV25T-470J	B	149.9/159.8
L2	6200005521	S.COL NLV25T-470J	B	143.9/159.8
L3	6200010830	S.COL C2520C-3R3G-A	T	147.8/183.8
L4	6200010830	S.COL C2520C-3R3G-A	T	147.8/195.9
L5	6200010830	S.COL C2520C-3R3G-A	T	147/188.1
L6	6200010830	S.COL C2520C-3R3G-A	T	147/200.2
L21	6200005521	S.COL NLV25T-470J	B	134.4/161
L22	6200005521	S.COL NLV25T-470J	B	128.4/161
L23	6140004040	COL LR-443		
L24	6140004050	COL LR-444		
L25	6140004050	COL LR-444		
L26	6140004050	COL LR-444		
L27	6140004040	COL LR-443		
L51	6200005521	S.COL NLV25T-470J	B	118.9/161
L52	6200005521	S.COL NLV25T-470J	B	112.9/161
L53	6140004060	COL LR-445		
L54	6140004080	COL LR-446		
L55	6140004080	COL LR-446		
L56	6140004080	COL LR-446		
L57	6140004060	COL LR-445		
L81	6200005521	S.COL NLV25T-470J	B	103.5/161
L82	6200005521	S.COL NLV25T-470J	B	97.5/161
L83	6140004090	COL LR-447		
L84	6140004230	COL LR-458		
L85	6140004230	COL LR-458		
L86	6140004230	COL LR-458		
L87	6140004090	COL LR-447		
L111	6200005521	S.COL NLV25T-470J	B	88/161
L112	6200005521	S.COL NLV25T-470J	B	82/161
L113	6140004090	COL LR-447		

M.=Mounted side (T: Mounted on the Top side B: Mounted on the Bottom side) S.=Surface mount

[RF UNIT]

REF NO.	ORDER NO.	DESCRIPTION	M.	H/V LOCATION
L114	6140004100	COL LR-448		
L115	6140004100	COL LR-448		
L116	6140004100	COL LR-448		
L117	6140004090	COL LR-447		
L141	6200005521	S.COL NLV25T-470J	B	72.5/161
L142	6200005521	S.COL NLV25T-470J	B	66.5/161
L143	6140004110	COL LR-449		
L144	6140004120	COL LR-450		
L145	6140004120	COL LR-450		
L146	6140004120	COL LR-450		
L147	6140004110	COL LR-449		
L171	6200005521	S.COL NLV25T-470J	B	53/161
L172	6200005521	S.COL NLV25T-470J	B	47/161
L173	6140004140	COL LR-451		
L174	6140004150	COL LR-452		
L175	6140004150	COL LR-452		
L176	6140004150	COL LR-452		
L177	6140004140	COL LR-451		
L201	6200007021	S.COL NLV25T-270J	B	37.5/161
L202	6200007021	S.COL NLV25T-270J	B	31.5/161
L203	6140004160	COL LR-453		
L204	6140004180	COL LR-454		
L205	6140004180	COL LR-454		
L206	6140004180	COL LR-454		
L207	6140004160	COL LR-453		
L231	6200005011	S.COL NLV25T-100J	B	22.1/161
L232	6200005011	S.COL NLV25T-100J	B	16.1/161
L233	6140004190	COL LR-455		
L234	6140004210	COL LR-456		
L235	6140004210	COL LR-456		
L236	6140004210	COL LR-456		
L237	6140004190	COL LR-455		
L260	6200003281	S.COL NLV25T-2R2J	T	63.7/169
L261	6200009141	S.COL NLV25T-6R8J	B	8.1/160.4
L262	6200009141	S.COL NLV25T-6R8J	B	2.1/160.4
L263	6140004220	COL LR-457		
L264	6140004160	COL LR-453		
L265	6140004160	COL LR-453		
L266	6140004160	COL LR-453		
L267	6140004220	COL LR-457		
L268	6200003281	S.COL NLV25T-2R2J	T	63.2/220.8
L291	6200003281	S.COL NLV25T-2R2J	T	64.1/191.4
L292	6200003281	S.COL NLV25T-2R2J	T	63.8/217.7
L293	6200010180	S.COL LQW2BHN82NG03L	T	64.1/180.7
L294	6200002981	S.COL NLV32T-R56J	T	64.4/185.2
L295	6200010180	S.COL LQW2BHN82NG03L	T	64.1/195
L296	6200010870	S.COL C2520C-R33G-A (0.33U)	T	63.7/201.1
L320	6200001831	S.COL NLV32T-100J	T	64.2/158.2
L321	6200003281	S.COL NLV25T-2R2J	B	68/195.8
L322	6200003281	S.COL NLV25T-2R2J	B	62.8/220.7
L323	6200003011	S.COL NLV32T-R27J	B	64.4/179.8
L324	6200003001	S.COL NLV32T-R22J	B	63.5/188.2
L325	6200003011	S.COL NLV32T-R27J	B	63.8/196.3
L326	6200001831	S.COL NLV32T-100J	T	53.1/221.6
L391	6200005491	S.COL NLV32T-331J	B	102.6/231.2
L392	6200005491	S.COL NLV32T-331J	B	83.5/239.9
L393	6200003211	S.COL NLV32T-820J	B	92.6/229.7
L394	6200005491	S.COL NLV32T-331J	B	103.5/227.8
L395	6200005491	S.COL NLV32T-331J	B	108.2/224.7
L421	6200008641	S.COL NLV32T-391J	B	95.7/148.9
L501	6200003261	S.COL NLV32T-101J	B	124.7/42.6
L502	6200003261	S.COL NLV32T-101J	B	128.7/39.2
L503	6200003261	S.COL NLV32T-101J	B	128.7/42.6
L504	6200003520	S.COL ELJFB 102K-F	T	120.4/39.5
L505	6150004090	COL LS-469 (C-13969)		
L507	6140003530	COL LR-395		
L508	6140003210	S.COL LR-358	T	100.9/77.3
L509	6140003770	S.COL LR-414 4KBL (STP-01435)	T	112/78.4
L510	6140003770	S.COL LR-414 4KBL (STP-01435)	T	112/95.6
L511	6200003031	S.COL NLV32T-R47J	B	110.7/100.7
L512	6150004280	COL LS-484B (C-14927)		
L513	6140002551	S.COL #617DB-1919=P3	T	100.9/106.9
L514	6140002551	S.COL #617DB-1919=P3	T	100.9/119.1
L515	6200003001	S.COL NLV32T-R22J	B	92.5/123.6
L516	6200003021	S.COL NLV32T-R33J	B	94.8/117.7
L517	6200001831	S.COL NLV32T-100J	B	98.8/123.6
L518	6200010720	S.COL C2520C-56NG-A	T	106.5/126.4
L519	6200010860	S.COL C2520C-R10G-A (0.1U)	T	110/128.2
L521	6140003900	COL LR-489		
L522	6140003890	COL LR-488		
L523	6200010381	S.COL ELJRE R15JFA	B	96.2/97
L524	6180002971	S.COL NLV32T-068J	B	88.5/108.5
L525	6180002971	S.COL NLV32T-068J	B	90.7/112.5
L526	6180002971	S.COL NLV32T-068J	B	95/113.2
L527	6200010660	S.COL C2520C-R15G-A (0.15U)	T	115/127.4
L528	6200003261	S.COL NLV32T-101J	B	120.1/36.8
L529	6200010381	S.COL ELJRE R15JFA	B	96.2/93.8
L601	6200003101	S.COL NLV32T-3R9J	B	125/63.7
L602	6200003131	S.COL NLV32T-120J	B	128.5/60.2
L603	6200003131	S.COL NLV32T-120J	B	134.9/64.4
L604	6200003131	S.COL NLV32T-120J	B	140.7/60.2
L605	6200003101	S.COL NLV32T-3R9J	B	144.3/63.7
L606	6200002961	S.COL NLV32T-4R7J	B	125/74.5
L607	6200001851	S.COL NLV32T-5R6J	B	128.5/71
L608	6200001851	S.COL NLV32T-5R6J	B	134.6/75.2
L609	6200001851	S.COL NLV32T-5R6J	B	140.7/71
L610	6200002961	S.COL NLV32T-4R7J	B	144.3/74.5
L611	6200002991	S.COL NLV32T-2R2J	B	125/85.3
L612	6200003111	S.COL NLV32T-6R8J	B	128.5/81.8
L613	6200003111	S.COL NLV32T-6R8J	B	134.6/86
L614	6200003111	S.COL NLV32T-6R8J	B	140.7/81.8
L615	6200002991	S.COL NLV32T-2R2J	B	144.3/85.3
L616	6200002991	S.COL NLV32T-2R2J	B	125/96.2
L617	6200003321	S.COL NLV32T-3R3J	B	128.5/92.6

[RF UNIT]

REF NO.	ORDER NO.	DESCRIPTION	M.	H/V LOCATION
L618	6200003321	S.COL NLV32T-3R3J	B	134.6/96.8
L619	6200003321	S.COL NLV32T-3R3J	B	140.7/92.6
L620	6200002991	S.COL NLV32T-2R2J	B	144.3/96.1
L621	6200003061	S.COL NLV32T-1R2J	B	125/107
L622	6200003091	S.COL NLV32T-2R7J	B	128.5/103.5
L623	6200003091	S.COL NLV32T-2R7J	B	134.6/107.7
L624	6200003091	S.COL NLV32T-2R7J	B	140.7/103.5
L625	6200003061	S.COL NLV32T-1R2J	B	144.3/107
L626	6200003331	S.COL NLV32T-1R0J	T	128.1/63.3
L627	6200003081	S.COL NLV32T-1R8J	T	128.1/66.3
L628	6200003081	S.COL NLV32T-1R8J	T	134.6/65.7
L629	6200003081	S.COL NLV32T-1R8J	T	141.2/66.3
L630	6200003331	S.COL NLV32T-1R0J	T	141.2/63.3
L631	6200003041	S.COL NLV32T-R68J	T	128.1/72.3
L632	6200003071	S.COL NLV32T-1R5J	T	128.1/75.3
L633	6200003071	S.COL NLV32T-1R5J	T	134.6/74.7
L634	6200003071	S.COL NLV32T-1R5J	T	141.2/75.3
L635	6200003041	S.COL NLV32T-R68J	T	141.2/72.3
L636	6200002981	S.COL NLV32T-R56J	T	128.1/81.3
L637	6200003051	S.COL NLV32T-R82J	T	128.1/84.4
L638	6200003051	S.COL NLV32T-R82J	T	134.6/83.7
L639	6200003051	S.COL NLV32T-R82J	T	141.2/84.3
L640	6200002981	S.COL NLV32T-R56J	T	141.2/81.3
L641	6200003021	S.COL NLV32T-R33J	T	128.1/90.3
L642	6200003041	S.COL NLV32T-R68J	T	128.1/93.3
L643	6200003041	S.COL NLV32T-R68J	T	134.6/92.7
L644	6200003041	S.COL NLV32T-R68J	T	141.2/93.3
L645	6200003021	S.COL NLV32T-R33J	T	141.2/90.3
L646	6200005491	S.COL NLV32T-331J	T	128.1/105.3
L647	6200007810	S.COL LQH31HN95NK03L	T	126.8/98.7
L648	6200009810	S.COL LQH31HNR61J03L	T	128.1/102.3
L649	6200009810	S.COL LQH31HNR61J03L	T	134.4/101
L650	6200009810	S.COL LQH31HNR61J03L	T	141.2/102.3
L651	6200007810	S.COL LQH31HN95NK03L	T	142.6/98.7
L801	6200005491	S.COL NLV32T-331J	T	155.2/62.9
L802	6200003261	S.COL NLV32T-101J	B	151.1/62.1
L803	6140003970	COL LR-494		
L804	6200003241	S.COL NLV32T-221J	B	152.1/76.8
L904	6200001831	S.COL NLV32T-100J	B	76.7/140.7
L905	6140004380	COL LR-498		
L906	6200009690	S.COL LQH43CN101K03L	B	77.6/137
L1004	6140003890	COL LR-488		
L1005	6180001000	COL LAL 04NA 102K		
L1006	6140003900	COL LR-489		
L1007	6140003800	COL LR-439		
L1008	6190001650	COL ELC06D102E		
L1009	6190001650	COL ELC06D102E		
L1010	6140003880	COL LR-486		
L1011	6140003880	COL LR-486		
L1012	6140003800	COL LR-439		
L1013	6200010680	S.COL C2520C-R22G-A (0.22U)	T	21.8/139.4
L1015	6200007790	S.COL LQW2BHN15J03L	T	47.6/117.6
L1052	6200010740	S.COL C2520C-R27G-A	T	6.7/139.9
L1053	6200010740	S.COL C2520C-R27G-A	T	6/136.1
L1054	6200010740	S.COL C2520C-R27G-A	T	6.7/132.3
L1055	6140003960	COL LR-495		
L1056	6200010730	S.COL C2520C-68NG-A	T	13/116.3
L1058	6190001631	COL #E544EN-100021		
L1060	6200010730	S.COL C2520C-68NG-A	T	51.2/87.5
L1062	6200011450	S.COL C2520C-R39G-A	T	53.4/83.7
L1063	6200010650	S.COL C2520C-R12G-A (0.12U)	T	53/79.9
L1071	6200007780	S.COL LQW2BHN12J03L	T	2.7/128
L1072	6200007780	S.COL LQW2BHN12J03L	T	3.3/130.8
L1101	6140003920	COL LR-491		
L1102	6200010650	S.COL C2520C-R12G-A (0.12U)	T	7.1/82.2
L1103	6180001250	COL LAL 04NA 3R3K		
L1104	6200010870	S.COL C2520C-R33G-A (0.33U)	T	5.6/64.2
L1105	6140003910	COL LR-490		
L1151	6140004640	COL LR-519		
L1201	6200007780	S.COL LQW2BHN12J03L	T	58.4/121
L1208	6140003800	COL LR-439		
L1209	6200001831	S.COL NLV32T-100J	B	56.9/115.2
L1210	6140004440	COL LR-503		
L1211	6200009690	S.COL LQH43CN101K03L	T	56.8/102.1
L1212	6200001831	S.COL NLV32T-100J	B	71.4/115.2
L1213	6140004440	COL LR-503		
L1214	6200009690	S.COL LQH43CN101K03L	T	71.4/102.1
L1216	6140003800	COL LR-439		
L1217	6200007750	S.COL LQW2BHN56NJ03L	T	49.7/94
L1218	6200007770	S.COL LQW2BHN10J03L	T	48.9/99.4
L1219	6200007790	S.COL LQW2BHN15J03L	T	44.9/100.3
L1220	6140000930	COL LR-116		
L1221	6200003261	S.COL NLV32T-101J	B	38.1/76.3
L1222	6150001770	COL LS-198		
L1223	6200007750	S.COL LQW2BHN56NJ03L	T	33.8/78.6
L1228	6200010870	S.COL C2520C-R33G-A (0.33U)	T	44.9/104.9
L1301	6200008090	S.COL LQW2BHN68NJ03L	T	30.3/75.1
L1302	6200008090	S.COL LQW2BHN68NJ03L	T	31/71.5
L1303	6200007790	S.COL LQW2BHN15J03L	T	34.1/69.5
L1304	6200010870	S.COL C2520C-R33G-A (0.33U)	T	33.8/64.2
L1305	6200003001	S.COL NLV32T-R22J	T	28.2/61.3
L1306	6200001831	S.COL NLV32T-100J	B	34.7/68.3
L1307	6200003001	S.COL NLV32T-R22J	T	34.2/75
L1351	6200001831	S.COL NLV32T-100J	B	69.1/77.9
L1353	6200010740	S.COL C2520C-R27G-A	T	65.1/76.1
L1405	6200007770	S.COL LQW2BHN10J03L	T	52.4/6
L1406	6200007750	S.COL LQW2BHN56NJ03L	T	52.4/9.6
L1407	6140003930	COL LR-492		
L1408	6190001621	COL #E544EN-100028		
L1409				

[RF UNIT]

REF NO.	ORDER NO.	DESCRIPTION	M.	H/V LOCATION
L1655	6200001831	S.COL NLV32T-100J	B	97.5/46.3
L1701	6200001831	S.COL NLV32T-100J	B	121.8/148.2
L1902	6200001831	S.COL NLV32T-100J	T	151.5/137.7
L2001	6200009790	S.COL BLM31PG121SN1	B	123.5/238.5
L2003	6200003261	S.COL NLV32T-101J	B	142/241.8
L2004	6200003261	S.COL NLV32T-101J	B	154.5/237.6
R1	7030003640	S.RES ERJ3GEYJ 473 V (47 k)	T	148.7/177.3
R3	7030003860	S.RES ERJ3GE JPW V	T	146.5/178.8
R101	7030003320	S.RES ERJ3GEYJ 101 V (100)	T	150/158.2
R102	7030003320	S.RES ERJ3GEYJ 101 V (100)	T	138/153.3
R103	7030003320	S.RES ERJ3GEYJ 101 V (100)	T	140.9/154.1
R104	7030003320	S.RES ERJ3GEYJ 101 V (100)	T	138/154.9
R105	7030003320	S.RES ERJ3GEYJ 101 V (100)	T	140.9/155.7
R106	7030003320	S.RES ERJ3GEYJ 101 V (100)	T	138/148.5
R107	7030003320	S.RES ERJ3GEYJ 101 V (100)	T	140.9/147.7
R108	7030003320	S.RES ERJ3GEYJ 101 V (100)	T	140.9/149.3
R117	7030003320	S.RES ERJ3GEYJ 101 V (100)	T	138/150.1
R118	7030003320	S.RES ERJ3GEYJ 101 V (100)	T	140.9/150.9
R119	7030003320	S.RES ERJ3GEYJ 101 V (100)	T	138/151.7
R120	7030003320	S.RES ERJ3GEYJ 101 V (100)	T	140.9/152.5
R121	7030003320	S.RES ERJ3GEYJ 101 V (100)	T	154.7/160.6
R122	7030003320	S.RES ERJ3GEYJ 101 V (100)	T	153.4/160.6
R123	7030003320	S.RES ERJ3GEYJ 101 V (100)	T	152.1/160.6
R133	7030003560	S.RES ERJ3GEYJ 103 V (10 k)	T	151.2/145.8
R134	7030003320	S.RES ERJ3GEYJ 101 V (100)	T	152.5/145.8
R135	7030003320	S.RES ERJ3GEYJ 101 V (100)	T	153.8/145.8
R260	7030003320	S.RES ERJ3GEYJ 101 V (100)	T	63.2/204.1
R261	7030003440	S.RES ERJ3GEYJ 102 V (1 k)	T	63.8/166.5
R262	7030003440	S.RES ERJ3GEYJ 102 V (1 k)	T	65.8/222
R263	7030003680	S.RES ERJ3GEYJ 104 V (100 k)	T	63.2/206.9
R264	7030003480	S.RES ERJ3GEYJ 222 V (2.2 k)	T	70/222.6
R320	7030008180	S.RES ERJ12YJ331U (330)	T	64.2/162.8
R321	7030003320	S.RES ERJ3GEYJ 101 V (100)	B	63.2/204.9
R322	7030008180	S.RES ERJ12YJ331U (330)	T	58.3/222
R323	7030003680	S.RES ERJ3GEYJ 104 V (100 k)	B	63.2/208.1
R351	7030003340	S.RES ERJ3GEYJ 151 V (150)	B	73.8/233.5
R352	7030003300	S.RES ERJ3GEYJ 680 V (68)	B	76.9/233.5
R354	7030003280	S.RES ERJ3GEYJ 470 V (47)	B	66.7/227.1
R355	7030003320	S.RES ERJ3GEYJ 101 V (100)	B	69.8/227.1
R381	7030003520	S.RES ERJ3GEYJ 472 V (4.7 k)	B	108.2/227.9
R382	7030003360	S.RES ERJ3GEYJ 221 V (220)	B	75.3/240.7
R383	7030003680	S.RES ERJ3GEYJ 104 V (100 k)	B	106.6/227.9
R384	7030003420	S.RES ERJ3GEYJ 681 V (680)	B	99.9/228.7
R385	7030003420	S.RES ERJ3GEYJ 681 V (680)	B	99/232.1
R386	7030003480	S.RES ERJ3GEYJ 222 V (2.2 k)	B	99.9/225.1
R387	7030003560	S.RES ERJ3GEYJ 103 V (10 k)	B	98.4/236.2
R388	7540000130	ABS 2P-50A-301		
R389	7030003420	S.RES ERJ3GEYJ 681 V (680)	B	87.4/239.2
R390	7030003560	S.RES ERJ3GEYJ 103 V (10 k)	B	101.4/237.8
R391	7030003680	S.RES ERJ3GEYJ 104 V (100 k)	B	101.5/236.2
R392	7030003420	S.RES ERJ3GEYJ 681 V (680)	B	99.9/227.1
R393	7030003420	S.RES ERJ3GEYJ 681 V (680)	B	99/230.5
R394	7030003420	S.RES ERJ3GEYJ 681 V (680)	B	87.4/240.8
R395	7030003420	S.RES ERJ3GEYJ 681 V (680)	B	98.4/239.4
R396	7030003420	S.RES ERJ3GEYJ 681 V (680)	B	98.4/237.8
R401	7030003360	S.RES ERJ3GEYJ 221 V (220)	B	55.3/230.7
R402	7030003680	S.RES ERJ3GEYJ 104 V (100 k)	B	50.9/231.7
R403	7030003480	S.RES ERJ3GEYJ 222 V (2.2 k)	B	48.3/236.5
R404	7030003860	S.RES ERJ3GE JPW V	B	48.3/233.7
R405	7540000130	ABS 2P-50A-301		
R421	7030003440	S.RES ERJ3GEYJ 102 V (1 k)	B	87.9/139.5
R422	7030003440	S.RES ERJ3GEYJ 102 V (1 k)	B	93.1/139.5
R423	7030003440	S.RES ERJ3GEYJ 102 V (1 k)	B	86.1/139.5
R424	7030003440	S.RES ERJ3GEYJ 102 V (1 k)	B	94.9/139.5
R425	7030003410	S.RES ERJ3GEYJ 561 V (560)	B	95.6/145.7
R426	7030003410	S.RES ERJ3GEYJ 561 V (560)	B	92.2/135
R427	7030003320	S.RES ERJ3GEYJ 101 V (100)	B	89.7/142.6
R428	7030003400	S.RES ERJ3GEYJ 471 V (470)	B	89.7/139.5
R429	7030003400	S.RES ERJ3GEYJ 471 V (470)	B	91.3/139.5
R501	7030003440	S.RES ERJ3GEYJ 102 V (1 k)	T	162.7/36.4
R502	7030003560	S.RES ERJ3GEYJ 103 V (10 k)	T	162.7/35.1
R503	7030003440	S.RES ERJ3GEYJ 102 V (1 k)	T	162.7/39
R504	7030003440	S.RES ERJ3GEYJ 102 V (1 k)	T	162.7/42.9
R505	7030003320	S.RES ERJ3GEYJ 101 V (100)	T	162.7/45.5
R506	7030003320	S.RES ERJ3GEYJ 101 V (100)	T	150.5/37.7
R507	7030003440	S.RES ERJ3GEYJ 102 V (1 k)	T	150.5/39
R508	7030003440	S.RES ERJ3GEYJ 102 V (1 k)	T	150.5/42.9
R509	7030003320	S.RES ERJ3GEYJ 101 V (100)	T	150.5/45.5
R510	7030003320	S.RES ERJ3GEYJ 101 V (100)	T	138.3/37.7
R511	7030003320	S.RES ERJ3GEYJ 101 V (100)	B	132.9/37.5
R513	7030003860	S.RES ERJ3GE JPW V	B	85.3/113.7
R514	7030003440	S.RES ERJ3GEYJ 102 V (1 k)	B	128.7/36.7
R515	7030003410	S.RES ERJ3GEYJ 561 V (560)	B	128.7/45.1
R516	7030003440	S.RES ERJ3GEYJ 102 V (1 k)	T	138.3/42.8
R517	7030009591	S.RES ERA3YED 472V (4.7 k)	T	138.3/41.5
R518	7030003400	S.RES ERJ3GEYJ 471 V (470)	T	126.6/44.5
R519	7030003560	S.RES ERJ3GEYJ 103 V (10 k)	T	126.6/43.2
R520	7030003630	S.RES ERJ3GEYJ 393 V (39 k)	B	124/38.4
R521	7030003600	S.RES ERJ3GEYJ 223 V (22 k)	B	125.6/38.4
R523	7030003360	S.RES ERJ3GEYJ 221 V (220)	T	123.7/39.3
R524	7030003560	S.RES ERJ3GEYJ 103 V (10 k)	T	117.8/39.5
R525	7030003480	S.RES ERJ3GEYJ 222 V (2.2 k)	T	118/43.2
R526	7030003440	S.RES ERJ3GEYJ 102 V (1 k)	T	118.1/35.8
R527	7030003560	S.RES ERJ3GEYJ 103 V (10 k)	T	116/36.6
R528	7030003560	S.RES ERJ3GEYJ 103 V (10 k)	B	106.3/44.5
R529	7030003560	S.RES ERJ3GEYJ 103 V (10 k)	B	114.3/44.5
R530	7030003560	S.RES ERJ3GEYJ 103 V (10 k)	B	107.9/52.2
R531	7030003560	S.RES ERJ3GEYJ 103 V (10 k)	B	115.9/52.2
R532	7030003440	S.RES ERJ3GEYJ 102 V (1 k)	B	115.9/54.7
R533	7030003560	S.RES ERJ3GEYJ 103 V (10 k)	B	114.3/55.7
R534	7030003560	S.RES ERJ3GEYJ 103 V (10 k)	T	118.9/55.7
R535	7030003480	S.RES ERJ3GEYJ 222 V (2.2 k)	B	103.8/58

[RF UNIT]

REF NO.	ORDER NO.	DESCRIPTION	M.	H/V LOCATION
R536	7030003490	S.RES ERJ3GEYJ 272 V (2.7 k)	B	107/58.4
R537	7030003320	S.RES ERJ3GEYJ 101 V (100)	T	115.8/59.4
R538	7310005400	S.TRI EVM-3VXS0 BE4 (223)	T	108.6/55.5
R539	7030003380	S.RES ERJ3GEYJ 331 V (330)	B	113/59
R540	7030003220	S.RES ERJ3GEYJ 150 V (15)	B	94.7/65.9
R541	7030003380	S.RES ERJ3GEYJ 331 V (330)	B	92.3/65.2
R543	7030003380	S.RES ERJ3GEYJ 331 V (330)	B	97.1/65.2
R545	7030004030	S.RES ERJ3GEYJ 5R6 V (5.6)	B	100.9/64.5
R546	7030003430	S.RES ERJ3GEYJ 821 V (820)	B	100.9/61.2
R547	7030003430	S.RES ERJ3GEYJ 821 V (820)	B	98.7/60.6
R548	7030004030	S.RES ERJ3GEYJ 5R6 V (5.6)	B	101/77.3
R550	7030003860	S.RES ERJ3GE JPW V	B	108.3/70.3
R552	7030004040	S.RES ERJ3GEYJ 4R7 V (4.7)	B	113.8/99
R553	7030003560	S.RES ERJ3GEYJ 103 V (10 k)	B	112.8/105.5
R554	7030003440	S.RES ERJ3GEYJ 102 V (1 k)	B	108.1/104
R556	7030003400	S.RES ERJ3GEYJ 471 V (470)	B	109.8/96.1
R558	7030003320	S.RES ERJ3GEYJ 101 V (100)	B	105.8/92.1
R562	7030003320	S.RES ERJ3GEYJ 101 V (100)	T	102.9/125.6
R563	7030003300	S.RES ERJ3GEYJ 680 V (68)	B	94.7/120.8
R564	7030003620	S.RES ERJ3GEYJ 333 V (33 k)	B	92.3/116.9
R566	7030003330	S.RES ERJ3GEYJ 121 V (120)	B	97.3/120
R567	7030003230	S.RES ERJ3GEYJ 180 V (180)	B	98.8/110.7
R568	7030009851	S.RES ERA3YED 271V (270)	B	98.1/108.2
R569	7030009851	S.RES ERA3YED 271V (270)	B	99.7/108.2
R570	7030003520	S.RES ERJ3GEYJ 472 V (4.7 k)	B	118.4/125.7
R571	7030003560	S.RES ERJ3GEYJ 103 V (10 k)	B	115.3/124.1
R572	7030004040	S.RES ERJ3GEYJ 4R7 V (4.7)	B	121.7/115.8
R573	7030003400	S.RES ERJ3GEYJ 471 V (470)	B	115.3/114.2
R574	7030003280	S.RES ERJ3GEYJ 470 V (470)	B	118.4/114.2
R575	7030009851	S.RES ERA3YED 271V (270)	T	119.2/113
R576	7030003230	S.RES ERJ3GEYJ 180 V (18)	T	120.5/113
R577	7030009851	S.RES ERA3YED 271V (270)	T	119.7/110.9
R578	7030003230	S.RES ERJ3GEYJ 180 V (18)	T	117.9/124.7
R579	7030009851	S.RES ERA3YED 271V (270)	T	118.6/126.6
R580	7030009851	S.RES ERA3YED 271V (270)	T	119.9/126.6
R581	7030003430	S.RES ERJ3GEYJ 821 V (820)	B	92/97.8
R582	7030004030	S.RES ERJ3GEYJ 5R6 V (5.6)	B	96.2/100.1
R583	7030003430	S.RES ERJ3GEYJ 821 V (820)	B	93.9/99.4
R585	7030003600	S.RES ERJ3GEYJ 223 V (22 k)	T	126.6/41.9
R587	7030003200	S.RES ERJ3GEYJ 100 V (10)	B	120.9/123
R589	7030003400	S.RES ERJ3GEYJ 471 V (470)	B	118.4/124.1
R590	7030003430	S.RES ERJ3GEYJ 821 V (820)	B	98.6/78.1
R591	7030003430	S.RES ERJ3GEYJ 821 V (820)	B	103.4/78.1
R592	7030000300	S.RES MCR10EZHJ 220 (221)	B	126.6/124.3
R601	7030000260	S.RES MCR10EZHJ 100 (101)	B	134.6/68.2
R602	7030000260	S.RES MCR10EZHJ 100 (101)	B	134.6/79
R603	7030000260	S.RES MCR10EZHJ 100 (101)	B	134.6/89.8
R604	7030000260	S.RES MCR10EZHJ 100 (101)	B	134.6/100.7
R605	7030000260	S.RES MCR10EZHJ 100 (101)	B	134.6/111.5
R606	7030000260	S.RES MCR10EZHJ 100 (101)	T	134.6/60
R607	7030000260	S.RES MCR10EZHJ 100 (101)	T	134.6/69
R608	7030000260	S.RES MCR10EZHJ 100 (101)	T	134.6/78
R609	7030000260	S.RES MCR10EZHJ 100 (101)	T	134.6/87
R610	7030003400	S.RES ERJ3GEYJ 471 V (470)	T	124.1/105.3
R611	7030000260	S.RES MCR10EZHJ 100 (101)	T	134.6/97
R612	7030009851	S.RES ERA3YED 271V (270)	T	124/69.5
R613	7030003230	S.RES ERJ3GEYJ 180 V (18)	T	124.7/71.7
R614	7030009851	S.RES ERA3YED 271V (270)	T	125.3/69.5
R801	7030003380	S.RES ERJ3GEYJ 331 V (330)	T	152.4/62.9
R802	7030003340	S.RES ERJ3GEYJ 151 V (150)	B	155.2/61.4
R803	7030003440	S.RES ERJ3GEYJ 102 V (1 k)	B	159.4/76.1
R804	7030003490	S.RES ERJ3GEYJ 272 V (2.7 k)	B	157/75.3
R805	7030003280	S.RES ERJ3GEYJ 470 V (47 k)	B	154.1/84.4
R806	7030003300	S.RES ERJ3GEYJ 680 V (68)	B	154.1/84.4
R806	7030003320	S.RES ERJ3GEYJ 101 V (100)	B	156.5/83.4
R806	7030003330	S.RES ERJ3GEYJ 121 V (120)	B	156.5/83.4
R807	7030003320	S.RES ERJ3GEYJ 101 V (100)	B	156.5/85.2
R807	7030003330	S.RES ERJ3GEYJ 121 V (120)	B	156.5/85.2
R808	7030003640	S.RES ERJ3GEYJ 473 V (4.7 k)	B	162.8/96.7
R809	7030003460	S.RES ERJ3GEYJ 152 V (15 k)	B	164.4/96.7
R810	7030003680	S.RES ERJ3GEYJ 104 V (100 k)	T	156.5/59.4
R811	7030003560	S.RES ERJ3GEYJ 103 V (10 k)	T	159.5/56.6
R812	7030009851	S.RES ERA3YED 271V (270)	T	151.1/59.4
R813	7030003230	S.RES ERJ3GEYJ 180 V (18)	T	152.4/59.4
R814	7030009851	S.RES ERA3YED 271V (270)	T	153.7/59.4
R815	7030003320	S.RES ERJ3GEYJ 101 V (100)	T	153.8/56.5

[RF UNIT]

REF NO.	ORDER NO.	DESCRIPTION	M.	H/V LOCATION
R1019	7030003560	S.RES ERJ3GEYJ 103 V (10 k)	T	15.4/133.9
R1023	7030010980	S.RES ERA3YHD 470V (47)	B	32.6/137.7
R1024	7030003200	S.RES ERJ3GEYJ 100 V (10)	T	27.3/142.6
R1027	7030003200	S.RES ERJ3GEYJ 100 V (10)	B	38.9/133.8
R1028	7030003200	S.RES ERJ3GEYJ 100 V (10)	B	38.9/119.9
R1029	7030010980	S.RES ERA3YHD 470V (47)	B	28.9/133.8
R1030	7030010980	S.RES ERA3YHD 470V (47)	B	28.9/120
R1051	7030003800	S.RES ERJ3GEYJ 105 V (1 M)	B	3.1/103.2
R1054	7030011500	S.RES ERA3YHD 270V (27)	T	48.9/88.3
R1055	7030000010	S.RES MCR10EZHZ JPW (000)	T	7.3/128
R1056	7030000010	S.RES MCR10EZHZ JPW (000)	T	6.5/144
R1071	7030010980	S.RES ERA3YHD 470V (47)	T	3.6/132.5
R1072	7030000010	S.RES MCR10EZHZ JPW (000)	T	3.6/45.2
R1073	7030000010	S.RES MCR10EZHZ JPW (000)	T	5.4/45.2
R1074	7030000010	S.RES MCR10EZHZ JPW (000)	B	1.9/45.3
R1075	7030000010	S.RES MCR10EZHZ JPW (000)	B	4.3/45.3
R1101	7310004860	S.TRI EVM-3YSX50 B53 (502)	T	3.9/109.9
R1102	7030005871	S.RES ERA3YKD 104V (100 k)	B	3.8/99.5
R1103	7030007680	S.RES ERJ8ENF 47R0V (47)	T	2.3/95.4
R1104	7030007680	S.RES ERJ8ENF 47R0V (47)	T	10.4/92.9
R1105	7030003500	S.RES ERJ3GEYJ 332 V (3.3 k)	T	7.3/112.4
R1106	7030009620	S.RES ERJ12YJ120U (12)	B	4.4/82.2
R1107	7030010980	S.RES ERA3YHD 470V (47)	T	8.4/79.8
R1109	7030007180	S.RES ERJ12YJ150U (15)	B	7.4/74.4
R1110	7030003480	S.RES ERJ3GEYJ 222 V (2.2 k)	B	15.5/68.5
R1111	7030003480	S.RES ERJ3GEYJ 222 V (2.2 k)	T	17.8/69.7
R1113	7030003480	S.RES ERJ3GEYJ 222 V (2.2 k)	T	17.8/68.4
R1114	7030004040	S.RES ERJ3GEYJ 4R7 V (4.7)	T	4.7/74.8
R1115	7030006240	S.RES ERJ12YJ181U (180)	B	7.4/70.2
R1116	7030007230	S.RES ERA3YED 102V (1 k)	T	8.3/64.8
R1117	7030004040	S.RES ERJ3GEYJ 4R7 V (4.7)	T	8.3/66.1
R1118	7030003480	S.RES ERJ3GEYJ 222 V (2.2 k)	T	8.6/68.1
R1119	7030003470	S.RES ERJ3GEYJ 182 V (1.8 k)	T	6/68.1
R1120	7030006070	S.RES ERJ12YJ101U (100)	B	6.6/59.1
R1121	7030003240	S.RES ERJ3GEYJ 220 V (22)	T	5.4/60.5
R1122	7030010980	S.RES ERA3YHD 470V (47)	T	12/69
R1123	7030003480	S.RES ERJ3GEYJ 222 V (2.2 k)	T	18.3/62.7
R1124	7030003460	S.RES ERJ3GEYJ 152 V (1.5 k)	T	18.3/60.1
R1125	7030003420	S.RES ERJ3GEYJ 681 V (680)	B	13/57.2
R1126	7030003200	S.RES ERJ3GEYJ 100 V (10)	T	15.6/57.9
R1127	7030010980	S.RES ERA3YHD 470V (47)	T	9.4/57.2
R1128	7030003470	S.RES ERJ3GEYJ 182 V (1.8 k)	T	10.6/52.1
R1129	7030003470	S.RES ERJ3GEYJ 182 V (1.8 k)	T	26.5/52.1
R1130	7030003480	S.RES ERJ3GEYJ 222 V (2.2 k)	T	16.5/1.8
R1131	7030003640	S.RES ERJ3GEYJ 473 V (47 k)	B	6.6/109.4
R1132	7310004860	S.TRI EVM-3YSX50 B53 (502)	T	4.6/115.8
R1133	7030003500	S.RES ERJ3GEYJ 332 V (3.3 k)	T	8.5/117.6
R1134	7030003640	S.RES ERJ3GEYJ 473 V (47 k)	T	8.5/116.3
R1135	7030005871	S.RES ERA3YKD 104V (100 k)	T	1.8/102.3
R1151	7030010980	S.RES ERA3YHD 470V (47)	T	55/74.2
R1152	7030010980	S.RES ERA3YHD 470V (47)	B	48.3/65
R1203	7030000010	S.RES MCR10EZHZ JPW (000)	T	41.6/103
R1208	7030003480	S.RES ERJ3GEYJ 222 V (2.2 k)	T	49.4/91
R1209	7030003560	S.RES ERJ3GEYJ 103 V (10 k)	T	52.8/91.7
R1210	7030003650	S.RES ERJ3GEYJ 563 V (56 k)	T	54.1/91.7
R1211	7030003860	S.RES ERJ3GE JPW V	T	58.8/124.7
R1212	7030003860	S.RES ERJ3GE JPW V	B	64.1/97.4
R1213	7030003200	S.RES ERJ3GEYJ 100 V (10)	B	57.1/111.7
R1214	7030003200	S.RES ERJ3GEYJ 100 V (10)	B	71.1/111.7
R1216	7030003280	S.RES ERJ3GEYJ 470 V (47)	B	55.3/109.5
R1217	7030003280	S.RES ERJ3GEYJ 470 V (47)	B	69.3/109.5
R1220	7030003280	S.RES ERJ3GEYJ 470 V (47)	B	57.8/119.1
R1221	7030003440	S.RES ERJ3GEYJ 102 V (1 k)	B	51.7/106
R1222	7030003530	S.RES ERJ3GEYJ 562 V (5.6 k)	B	54.9/104.5
R1223	7030003280	S.RES ERJ3GEYJ 470 V (47)	B	70.5/119.1
R1224	7030003440	S.RES ERJ3GEYJ 102 V (1 k)	B	65.7/106
R1225	7030003530	S.RES ERJ3GEYJ 562 V (5.6 k)	B	68.9/104.5
R1226	7030003410	S.RES ERJ3GEYJ 561 V (560)	T	28.5/94.3
R1227	7030003410	S.RES ERJ3GEYJ 561 V (560)	T	33.5/94.3
R1228	7310004860	S.TRI EVM-3YSX50 B53 (502)	T	31/94.3
R1229	7030003480	S.RES ERJ3GEYJ 222 V (2.2 k)	B	31.3/69.5
R1230	7030003480	S.RES ERJ3GEYJ 222 V (2.2 k)	B	31.3/67.7
R1231	7030003480	S.RES ERJ3GEYJ 222 V (2.2 k)	B	31.3/65.9
R1232	7030003600	S.RES ERJ3GEYJ 223 V (22 k)	T	31/89.5
R1233	7030010980	S.RES ERA3YHD 470V (47)	B	34.9/77.8
R1301	7030010980	S.RES ERA3YHD 470V (47)	B	31/89.5
R1302	7030003860	S.RES ERJ3GE JPW V	T	28.8/69.3
R1304	7030003620	S.RES ERJ3GEYJ 333 V (33 k)	T	31/62.9
R1306	7030006230	S.RES ERJ12YJ151U (150)	B	33.4/61.9
R1307	7030003300	S.RES ERJ3GEYJ 680 V (68)	T	32.1/57.3
R1314	7030000010	S.RES MCR10EZHZ JPW (000)	T	38.5/74
R1315	7030000010	S.RES MCR10EZHZ JPW (000)	T	45.1/89
R1316	7030000010	S.RES MCR10EZHZ JPW (000)	T	43/92
R1357	7030007230	S.RES ERA3YED 102V (1 k)	B	66/77.8
R1358	7030003530	S.RES ERJ3GEYJ 562 V (5.6 k)	B	66.7/75.4
R1359	7030010980	S.RES ERA3YHD 470V (47)	B	57.4/77.8
R1360	7030007230	S.RES ERA3YED 102V (1 k)	T	64.5/73.8
R1401	7030003200	S.RES ERJ3GEYJ 100 V (10)	B	59.6/10.9
R1402	7030003300	S.RES ERJ3GEYJ 680 V (68)	T	62.8/15
R1403	7030007230	S.RES ERA3YED 102V (1 k)	B	62.2/13.4
R1404	7030009861	S.RES ERA3YED 471V (470)	B	62.2/16.5
R1405	7030003340	S.RES ERJ3GEYJ 151 V (150)	B	62.2/19.6
R1406	7030009591	S.RES ERA3YED 472V (4.7 k)	B	58.1/18.4
R1407	7030003550	S.RES ERJ3GEYJ 822 V (8.2 k)	B	54.1/19.9
R1408	7030003200	S.RES ERJ3GEYJ 100 V (10)	T	64.1/15
R1409	7030009591	S.RES ERA3YED 472V (4.7 k)	T	69.3/15
R1410	7030006091	S.RES ERA3YED 822V (8.2 k)	B	68/13.6
R1411	7030005871	S.RES ERA3YKD 104V (100 k)	T	66.7/12.4
R1412	7030003200	S.RES ERJ3GEYJ 100 V (10)	T	67.3/17.1
R1413	7030003200	S.RES ERJ3GEYJ 100 V (10)	T	64.7/8.1
R1414	7030005871	S.RES ERA3YKD 104V (100 k)	B	69.6/13.6
R1415	7030010980	S.RES ERA3YHD 470V (47)	T	65.4/4.9
R1416	7030003320	S.RES ERJ3GEYJ 101 V (100)	B	70.7/5.4
R1419	7030003860	S.RES ERJ3GE JPW V	B	80.2/15

[RF UNIT]

REF NO.	ORDER NO.	DESCRIPTION	M.	H/V LOCATION
R1501	7030010980	S.RES ERA3YHD 470V (47)	T	88.7/10
R1502	7030009841	S.RES ERA3YHD 330V (33)	T	104/5.1
R1503	7030009851	S.RES ERA3YED 271V (270)	T	113.1/5.4
R1504	7030011050	S.RES ERA3YHD 100V (10)	T	110/6.7
R1505	7030006091	S.RES ERA3YED 822V (8.2 k)	B	106.5/23.5
R1506	7030007230	S.RES ERA3YED 102V (1 k)	T	113/12.7
R1507	7030007230	S.RES ERA3YED 102V (1 k)	T	113.1/8
R1508	7030007230	S.RES ERA3YED 102V (1 k)	T	113.1/9.3
R1509	7030007230	S.RES ERA3YED 102V (1 k)	T	118/3.8
R1510	7030005321	S.RES ERA3YED 103V (10 k)	T	124.4/3.8
R1511	7030007230	S.RES ERA3YED 102V (1 k)	T	125/6.2
R1512	7030003380	S.RES ERJ3GEYJ 331 V (330)	T	116.9/15.8
R1513	7030003380	S.RES ERJ3GEYJ 331 V (330)	T	125.2/15.8
R1514	7030005321	S.RES ERA3YED 103V (10 k)	T	129/15.8
R1515	7030005321	S.RES ERA3YED 103V (10 k)	T	129/11.9
R1516	7310005380	S.TRI EVM-3VSX50 B13 (102)	T	125.3/26
R1517	7030005321	S.RES ERA3YED 103V (10 k)	T	124.3/29.6
R1518	7030005321	S.RES ERA3YED 103V (10 k)	T	129/10.6
R1519	7030005321	S.RES ERA3YED 103V (10 k)	T	141/13.7
R1520	7030005321	S.RES ERA3YED 103V (10 k)	T	129/9.3
R1521	7030010980	S.RES ERA3YHD 470V (47)	T	96.5/9.9
R1522	7030009841	S.RES ERA3YHD 330V (33)	T	103.9/17.3
R1523	7030009851	S.RES ERA3YED 271V (270)	T	113.1/17.6
R1524	7030011050	S.RES ERA3YHD 100V (10)	T	110/18.9
R1525	7030007230	S.RES ERJ3GEYJ 331 V (1 k)	T	113/24.9
R1526	7030003460	S.RES ERJ3GEYJ 152 V (1.5 k)	B	106.5/21.5
R1527	7030007230	S.RES ERA3YED 102V (1 k)	T	113.1/21.5
R1528	7030007230	S.RES ERA3YED 102V (1 k)	T	113.1/20.2
R1529	7030007230	S.RES ERA3YED 102V (1 k)	T	117.9/29.6
R1530	7030003380	S.RES ERJ3GEYJ 331 V (330)	T	116.9/17.6
R1531	7030003380	S.RES ERJ3GEYJ 331 V (330)	T	125.2/17.6
R1532	7030005321	S.RES ERA3YED 103V (10 k)	T	129/21.5
R1533	7030005321	S.RES ERA3YED 103V (10 k)	T	129/17.6
R1534	7030005321	S.RES ERA3YED 103V (10 k)	T	129/22.8
R1535	7030005321	S.RES ERA3YED 103V (10 k)	T	129/24.1
R1536	7030005321	S.RES ERA3YED 103V (10 k)	T	141/16.5
R1537	7030003320	S.RES ERJ3GEYJ 101 V (100)	B	133.9/22.7
R1538	7030003320	S.RES ERJ3GEYJ 101 V (100)	B	139.1/22.7
R1539	7030008601	S.RES ERA3YED 222V (2.2 k)	T	146/14.5
R1540	7030010390	S.RES ERA3YED 821V (820)	T	144.2/19.5
R1541	7030003320	S.RES ERJ3GEYJ 101 V (100)	T	151.5/12.8
R1542	7030003320	S.RES ERJ3GEYJ 101 V (100)	B	145.5/22.7
R1543	7030009691	S.RES ERA3YED 101V (100)	T	151.5/19.5
R1544	7030007230	S.RES ERA3YED 102V (1 k)	T	126.3/6.2
R1651	7030003380	S.RES ERJ3GEYJ 331 V (330)	B	91.5/36.8
R1652	7030003220	S.RES ERJ3GEYJ 150 V (15)	B	92.4/34.4
R1653	7030003380	S.RES ERJ3GEYJ 331 V (330)	B	93.1/36.8
R1654	7030003280	S.RES ERJ3GEYJ 470 V (47)	B	95.6/38.3
R1655	7030003400	S.RES ERJ3GEYJ 471 V (470)	B	100.5/36.8
R1656	7030003630	S.RES ERJ3GEYJ 393 V (39 k)	B	95.7/34.3
R1657	7030003680	S.RES ERJ3GEYJ 104 V (100 k)	T	96.6/28.5
R1658	7030003320	S.RES ERJ3GEYJ 101 V (100)	T	96.6/25.9
R1659	7030009691	S.RES ERA3YED 101V (100)	T	87.8/20.6
R1660	7030009691	S.RES ERA3YED 101V (100)	T	92.2/20.6
R1661	7030003560	S.RES ERJ3GEYJ 103 V (10 k)	T	148.8/13.2
R1662	7030003560	S.RES ERJ3GEYJ 103 V (10 k)	T	143.3/13.2
R1663	7030003560	S.RES ERJ3GEYJ 103 V (10 k)	T	147.5/4.2
R1664	7030003560	S.RES ERJ3GEYJ 103 V (10 k)	B	146.9/8.7
R1665	7030003320	S.RES ERJ3GEYJ 101 V (100)	T	96.6/27.2
R1667	7030003360	S.RES ERJ3GEYJ 221 V (220)	B	149.3/9.5
R1668	7030003360	S.RES ERJ3GEYJ 221 V (220)	B	149.3/7.9
R1670	7030003800	S.RES ERJ3GEYJ 105 V (1 M)	B	152.3/10.3
R1673	7030003440	S.RES ERJ3GEYJ 102 V (1 k)	B	159.7/11.4
R1674	7030009851	S.RES ERA3YED 271V (270)	B	159.7/14.5
R1675	7030009591	S.RES ERA3YED 472V (4.7 k)	T	143.3/9.3
R1677	7030009591	S.RES ERA3YED 472V (4.7 k)	T	144.7/4.2
R1702	7030003320	S.RES ERJ3GEYJ 101 V (100)	B	108.7/138.6
R1703	7030003320	S.RES ERJ3GEYJ 101 V (100)	B	108.7/140.2
R1704	7030003320	S.RES ERJ3GEYJ 101 V (100)	B	108.7/141.8
R1705	7030003320	S.RES ERJ3GEYJ 101 V (100)	B	108.7/143.4
R1706	7030003320	S.RES ERJ3GEYJ 101 V (100)	T	108.7/145
R1707	7030003320	S.RES ERJ3GEYJ 101 V (100)	B	108.7/145
R1709	7030003480	S.RES ERJ3GEYJ 222 V (2.2 k)	T	121.9/130.2
R1710	7030003480	S.RES ERJ3GEYJ 222 V (2.2 k)	T	121.9/131.5
R1711	7030003540	S.RES ERJ3GEYJ 682 V (6.8 k)	T	121.9/132.8
R1712	7030003540	S.RES ERJ3GEY		

[RF UNIT]

REF NO.	ORDER NO.	DESCRIPTION	M.	H/V LOCATION
R1923	7030003560	S.RES ERJ3GEYJ 103 V (10 k)	B	140.9/115
R1924	7030003560	S.RES ERJ3GEYJ 103 V (10 k)	B	154.2/115
R1925	7030003560	S.RES ERJ3GEYJ 103 V (10 k)	B	142.5/115
R1926	7030003560	S.RES ERJ3GEYJ 103 V (10 k)	B	155.8/115
R1927	7030003560	S.RES ERJ3GEYJ 103 V (10 k)	B	144.1/115
R1928	7030003560	S.RES ERJ3GEYJ 103 V (10 k)	B	157.4/115
R1929	7030003560	S.RES ERJ3GEYJ 103 V (10 k)	B	145.7/115
R1930	7030003560	S.RES ERJ3GEYJ 103 V (10 k)	B	159/115
R1932	7030003560	S.RES ERJ3GEYJ 103 V (10 k)	B	160.6/115
R2001	7030003480	S.RES ERJ3GEYJ 222 V (2.2 k)	B	166.5/237.4
R2002	7030003520	S.RES ERJ3GEYJ 472 V (4.7 k)	B	155.8/231.4
R2003	7030003480	S.RES ERJ3GEYJ 222 V (2.2 k)	B	164.9/237.4
R2004	7030003620	S.RES ERJ3GEYJ 333 V (33 k)	B	156.6/233.8
R2005	7030003580	S.RES ERJ3GEYJ 153 V (15 k)	B	158.2/233.8
R2006	7030003520	S.RES ERJ3GEYJ 472 V (4.7 k)	B	158.9/231.4
R2007	7030003860	S.RES ERJ3GE JPW V	T	161.9/169.2
R2008	7030003860	S.RES ERJ3GE JPW V	T	161.9/167.9
R2009	7030003860	S.RES ERJ3GE JPW V	T	161.9/166.6
R2010	7030003860	S.RES ERJ3GE JPW V	T	161.9/165.3
R2011	7030003860	S.RES ERJ3GE JPW V	T	161.9/164
R2012	7030003860	S.RES ERJ3GE JPW V	T	161.9/162.7
C1	4030006880	S.CER C1608 JB 1H 472K-T	B	146.9/161.6
C2	4030006880	S.CER C1608 JB 1H 472K-T	B	146.1/159.2
C3	4030006880	S.CER C1608 JB 1H 472K-T	B	147.7/159.2
C4	4030006880	S.CER C1608 JB 1H 472K-T	B	147/222
C5	4030006880	S.CER C1608 JB 1H 472K-T	B	150/218.8
C6	4030006880	S.CER C1608 JB 1H 472K-T	B	147/220.4
C7	4030018620	S.CER C1608 CH 1H 222J-T	T	148.6/181.5
C8	4030018590	S.CER C1608 CH 1H 122J-T	T	148.6/192.3
C9	4030018590	S.CER C1608 CH 1H 122J-T	T	148.6/193.6
C10	4030018620	S.CER C1608 CH 1H 222J-T	T	148.6/203.1
C11	4030018600	S.CER C1608 CH 1H 152J-T	T	148.6/191
C21	4030006880	S.CER C1608 JB 1H 472K-T	B	131.4/161.6
C22	4030006880	S.CER C1608 JB 1H 472K-T	B	130.6/159.2
C23	4030006880	S.CER C1608 JB 1H 472K-T	B	132.2/159.2
C24	4030006880	S.CER C1608 JB 1H 472K-T	B	131.5/222
C25	4030006880	S.CER C1608 JB 1H 472K-T	B	134.5/218.8
C26	4030006880	S.CER C1608 JB 1H 472K-T	B	131.5/220.4
C27	4030017810	S.CER C1608 CH 1H 102J-T	B	139.2/170.3
C28	4030017810	S.CER C1608 CH 1H 102J-T	B	139.2/171.9
C29	4030010760	S.CER C1608 CH 1H 331J-T	B	138.6/185.4
C30	4030007140	S.CER C1608 CH 1H 121J-T	B	140.2/185.4
C31	4030007160	S.CER C1608 CH 1H 181J-T	B	130.9/185.4
C32	4030007060	S.CER C1608 CH 1H 270J-T	B	129.3/185.4
C33	4030010760	S.CER C1608 CH 1H 331J-T	B	134.1/190.1
C34	4030007090	S.CER C1608 CH 1H 470J-T	B	132.5/190.1
C35	4030007160	S.CER C1608 CH 1H 181J-T	B	130.9/190.1
C36	4030007060	S.CER C1608 CH 1H 270J-T	B	129.3/190.1
C37	4030010760	S.CER C1608 CH 1H 331J-T	B	138.6/195
C38	4030007140	S.CER C1608 CH 1H 121J-T	B	140.2/195
C39	4030017810	S.CER C1608 CH 1H 102J-T	B	139.2/209.9
C40	4030017810	S.CER C1608 CH 1H 102J-T	B	139.2/208.3
C51	4030006880	S.CER C1608 JB 1H 472K-T	B	115.9/161.6
C52	4030006880	S.CER C1608 JB 1H 472K-T	B	115.1/159.2
C53	4030006880	S.CER C1608 JB 1H 472K-T	B	116.7/159.2
C54	4030006880	S.CER C1608 JB 1H 472K-T	B	116/222
C55	4030006880	S.CER C1608 JB 1H 472K-T	B	119.2/18.8
C56	4030006880	S.CER C1608 JB 1H 472K-T	B	116/220.4
C57	4030017800	S.CER C1608 CH 1H 561J-T	B	123.7/170.3
C58	4030010760	S.CER C1608 CH 1H 331J-T	B	123.7/171.9
C59	4030010760	S.CER C1608 CH 1H 331J-T	B	123.1/185.4
C60	4030007080	S.CER C1608 CH 1H 390J-T	B	124.7/185.4
C61	4030007100	S.CER C1608 CH 1H 560J-T	B	115.4/185.4
C62	4030010760	S.CER C1608 CH 1H 331J-T	B	113.8/185.4
C63	4030010760	S.CER C1608 CH 1H 331J-T	B	118.6/190.1
C64	4030007090	S.CER C1608 CH 1H 470J-T	B	117/190.1
C65	4030010760	S.CER C1608 CH 1H 331J-T	B	115.4/190.1
C66	4030007100	S.CER C1608 CH 1H 560J-T	B	113.8/190.1
C67	4030010760	S.CER C1608 CH 1H 331J-T	B	123.1/195
C68	4030007080	S.CER C1608 CH 1H 390J-T	B	124.7/195
C69	4030017800	S.CER C1608 CH 1H 561J-T	B	123.7/209.9
C70	4030010760	S.CER C1608 CH 1H 331J-T	B	123.7/208.3
C81	4030006880	S.CER C1608 JB 1H 472K-T	B	100.5/161.6
C82	4030006880	S.CER C1608 JB 1H 472K-T	B	99.7/159.2
C83	4030006880	S.CER C1608 JB 1H 472K-T	B	101.3/159.2
C84	4030006880	S.CER C1608 JB 1H 472K-T	B	100.6/222
C85	4030006880	S.CER C1608 JB 1H 472K-T	B	103.7/218.8
C86	4030006880	S.CER C1608 JB 1H 472K-T	B	100.6/220.4
C87	4030017800	S.CER C1608 CH 1H 561J-T	B	108.3/170.3
C88	4030011330	S.CER C1608 CH 1H 391J-T	B	108.3/171.9
C89	4030007160	S.CER C1608 CH 1H 181J-T	B	107.7/185.4
C90	4030007070	S.CER C1608 CH 1H 330J-T	B	109.3/185.4
C91	4030007030	S.CER C1608 CH 1H 150J-T	B	100/185.4
C92	4030007120	S.CER C1608 CH 1H 820J-T	B	98.4/185.4
C93	4030007140	S.CER C1608 CH 1H 121J-T	B	103.2/190.1
C94	4030007100	S.CER C1608 CH 1H 560J-T	B	101.6/190.1
C95	4030007120	S.CER C1608 CH 1H 820J-T	B	100/190.1
C96	4030007030	S.CER C1608 CH 1H 150J-T	B	98.4/190.1
C97	4030007160	S.CER C1608 CH 1H 181J-T	B	107.7/195
C98	4030007070	S.CER C1608 CH 1H 330J-T	B	109.3/195
C99	4030017800	S.CER C1608 CH 1H 561J-T	B	108.3/209.9
C100	4030011330	S.CER C1608 CH 1H 391J-T	B	108.3/208.3
C111	4030006880	S.CER C1608 JB 1H 472K-T	B	85/161.6
C112	4030006880	S.CER C1608 JB 1H 472K-T	B	84.2/159.2
C113	4030006880	S.CER C1608 JB 1H 472K-T	B	85.8/159.2
C114	4030006880	S.CER C1608 JB 1H 472K-T	B	85/222
C115	4030006880	S.CER C1608 JB 1H 472K-T	B	87.1/219.6
C116	4030006880	S.CER C1608 JB 1H 472K-T	B	85/220.4
C117	4030010760	S.CER C1608 CH 1H 331J-T	B	92.8/170.3
C118	4030007150	S.CER C1608 CH 1H 151J-T	B	92.8/171.9
C119	4030007150	S.CER C1608 CH 1H 151J-T	B	93.7/185.4
C120	4030007060	S.CER C1608 CH 1H 270J-T	B	92.1/185.4

[RF UNIT]

REF NO.	ORDER NO.	DESCRIPTION	M.	H/V LOCATION
C121	4030007060	S.CER C1608 CH 1H 270J-T	B	84.4/185.4
C122	4030007140	S.CER C1608 CH 1H 121J-T	B	82.8/185.4
C123	4030007150	S.CER C1608 CH 1H 151J-T	B	87.6/190.1
C124	4030007010	S.CER C1608 CH 1H 100D-T	B	86/190.1
C125	4030007140	S.CER C1608 CH 1H 121J-T	B	84.4/190.1
C126	4030007060	S.CER C1608 CH 1H 270J-T	B	82.8/190.1
C127	4030007150	S.CER C1608 CH 1H 151J-T	B	92.1/195
C128	4030007060	S.CER C1608 CH 1H 270J-T	B	93.7/195
C129	4030010760	S.CER C1608 CH 1H 331J-T	B	92.8/209.9
C130	4030007150	S.CER C1608 CH 1H 151J-T	B	92.8/208.3
C141	4030006880	S.CER C1608 JB 1H 472K-T	B	69.5/161.6
C142	4030006880	S.CER C1608 JB 1H 472K-T	B	68.7/159.2
C143	4030006880	S.CER C1608 JB 1H 472K-T	B	70.3/159.2
C144	4030006880	S.CER C1608 JB 1H 472K-T	B	66.4/220.4
C145	4030006880	S.CER C1608 JB 1H 472K-T	B	72.6/218.8
C146	4030006880	S.CER C1608 JB 1H 472K-T	B	69.5/220.4
C147	4030007170	S.CER C1608 CH 1H 221J-T	B	77.2/170.3
C148	4030007170	S.CER C1608 CH 1H 221J-T	B	77.2/171.9
C149	4030007130	S.CER C1608 CH 1H 101J-T	B	78.2/185.4
C150	4030007050	S.CER C1608 CH 1H 220J-T	B	76.8/185.4
C151	4030007070	S.CER C1608 CH 1H 330J-T	B	68.8/185.4
C152	4030007080	S.CER C1608 CH 1H 390J-T	B	67.2/185.4
C153	4030007120	S.CER C1608 CH 1H 820J-T	B	72.1/190.1
C154	4030007050	S.CER C1608 CH 1H 220J-T	B	70.5/190.1
C155	4030007080	S.CER C1608 CH 1H 390J-T	B	68.8/190.1
C156	4030007070	S.CER C1608 CH 1H 330J-T	B	67.2/190.1
C157	4030007130	S.CER C1608 CH 1H 101J-T	B	76.6/195
C158	4030007050	S.CER C1608 CH 1H 220J-T	B	78.2/195
C159	4030007170	S.CER C1608 CH 1H 221J-T	B	77.2/209.9
C160	4030007170	S.CER C1608 CH 1H 221J-T	B	77.2/208.3
C171	4030006880	S.CER C1608 JB 1H 472K-T	B	50/161.6
C172	4030006880	S.CER C1608 JB 1H 472K-T	B	49.2/159.2
C173	4030006880	S.CER C1608 JB 1H 472K-T	B	50.8/159.2
C174	4030006880	S.CER C1608 JB 1H 472K-T	B	50/222
C175	4030006880	S.CER C1608 JB 1H 472K-T	B	53.1/218.8
C176	4030006880	S.CER C1608 JB 1H 472K-T	B	50/220.4
C177	4030007110	S.CER C1608 CH 1H 221J-T	B	57.8/170.3
C178	4030007110	S.CER C1608 CH 1H 680J-T	B	57.8/171.9
C179	4030007090	S.CER C1608 CH 1H 470J-T	B	58.7/185.4
C180	4030007090	S.CER C1608 CH 1H 470J-T	B	57.1/185.4
C181	4030007070	S.CER C1608 CH 1H 330J-T	B	49.4/185.4
C182	4030007070	S.CER C1608 CH 1H 330J-T	B	47.8/185.4
C183	4030007120	S.CER C1608 CH 1H 820J-T	B	52.6/190.1
C185	4030007070	S.CER C1608 CH 1H 330J-T	B	49.4/190.1
C186	4030007070	S.CER C1608 CH 1H 330J-T	B	47.8/190.1
C187	4030007090	S.CER C1608 CH 1H 470J-T	B	57.1/195
C188	4030007090	S.CER C1608 CH 1H 470J-T	B	58.7/195
C189	4030007170	S.CER C1608 CH 1H 221J-T	B	57.7/209.9
C190	4030007110	S.CER C1608 CH 1H 680J-T	B	57.7/208.3
C201	4030006880	S.CER C1608 JB 1H 472K-T	B	34.5/161.6
C202	4030006880	S.CER C1608 JB 1H 472K-T	B	33.7/159.2
C203	4030006880	S.CER C1608 JB 1H 472K-T	B	35.3/159.2
C204	4030006880	S.CER C1608 JB 1H 472K-T	B	34.5/222
C205	4030006880	S.CER C1608 JB 1H 472K-T	B	36.8/219.6
C206	4030006880	S.CER C1608 JB 1H 472K-T	B	34.5/220.4
C207	4030007160	S.CER C1608 CH 1H 181J-T	B	42.3/170.3
C208	4030007090	S.CER C1608 CH 1H 470J-T	B	43.2/171.9
C209	4030007090	S.CER C1608 CH 1H 470J-T	B	43.2/185.4
C210	4030007040	S.CER C1608 CH 1H 180J-T	B	41.6/185.4
C211	4030007030	S.CER C1608 CH 1H 150J-T	B	33.9/185.4
C212	4030007050	S.CER C1608 CH 1H 220J-T	B	32.3/185.4
C213	4030007090	S.CER C1608 CH 1H 470J-T	B	37.1/190.1
C214	4030006990	S.CER C1608 CH 1H 080D-T	B	35.5/190.1
C215	4030007050	S.CER C1608 CH 1H 220J-T	B	33.9/190.1
C216	4030007030	S.CER C1608 CH 1H 150J-T	B	32.3/190.1
C217	4030007090	S.CER C1608 CH 1H 470J-T	B	41.6/195
C218	4030007040	S.CER C1608 CH 1H 180J-T	B	43.2/195
C219	4030007160	S.CER C1608 CH 1H 181J-T	B	42.2/209.9
C220	4030007090	S.CER C1608 CH 1H 470J-T	B	42.2/208.3
C231	4030006880	S.CER C1608 JB 1H 472K-T	B	19.1/161.6
C232	4030006880	S.CER C1608 JB 1H 472K-T	B	18.3/159.2
C233	4030006880	S.CER C1608 JB 1H 472K-T	B	19.9/159.2
C234	4030006880	S.CER C1608 JB 1H 472K-T	B	19.1/222

[RF UNIT]

REF NO.	ORDER NO.	DESCRIPTION	M.	H/V LOCATION
C276	4030006880	S.CER C1608 JB 1H 472K-T	T	65.6/169.4
C277	4030007050	S.CER C1608 CH 1H 220J-T	B	10.9/195
C278	4030007020	S.CER C1608 CH 1H 120J-T	B	12.5/195
C279	4030007130	S.CER C1608 CH 1H 101J-T	B	11.5/209.9
C280	4030007030	S.CER C1608 CH 1H 150J-T	B	11.5/208.3
C283	4030011600	S.CER C1608 JB 1E 104K-T	T	63.8/193.3
C285	4030006880	S.CER C1608 JB 1H 472K-T	T	63.5/215.2
C286	4030006880	S.CER C1608 JB 1H 472K-T	T	63.5/213.4
C287	4030006880	S.CER C1608 JB 1H 472K-T	T	67.9/221.2
C297	4030007140	S.CER C1608 CH 1H 121J-T	T	64.5/182.4
C302	4030007040	S.CER C1608 CH 1H 180J-T	T	65.2/188.8
C303	4030007120	S.CER C1608 CH 1H 820J-T	T	63.9/197.5
C304	4030007040	S.CER C1608 CH 1H 180J-T	T	65.2/197.5
C320	4030011600	S.CER C1608 JB 1E 104K-T	B	63.5/185.8
C321	4030011600	S.CER C1608 JB 1E 104K-T	B	64.5/198.8
C322	4030006880	S.CER C1608 JB 1H 472K-T	B	63.2/217.7
C323	4030006880	S.CER C1608 JB 1H 472K-T	B	63.2/214.6
C324	4030011770	S.CER C1608 CH 1H 060B-T	B	63.7/190.7
C327	4030007100	S.CER C1608 CH 1H 560J-T	B	63.5/184.2
C329	4030007110	S.CER C1608 CH 1H 680J-T	B	63.7/193.9
C331	4030007100	S.CER C1608 CH 1H 560J-T	B	64.5/200.4
C353	4030006880	S.CER C1608 JB 1H 472K-T	B	87.1/225.4
C354	4030006880	S.CER C1608 JB 1H 472K-T	B	89.8/224.1
C355	4030006880	S.CER C1608 JB 1H 472K-T	B	84.5/225.4
C356	4030006880	S.CER C1608 JB 1H 472K-T	B	83.1/235.1
C357	4030006880	S.CER C1608 JB 1H 472K-T	B	83.2/236.7
C358	4030006880	S.CER C1608 JB 1H 472K-T	B	80/233.5
C359	4030006880	S.CER C1608 JB 1H 472K-T	B	69.8/225.4
C360	4030006880	S.CER C1608 JB 1H 472K-T	B	72.6/225.4
C361	4030006880	S.CER C1608 JB 1H 472K-T	B	75.4/225.4
C388	4030006880	S.CER C1608 JB 1H 472K-T	B	78.5/240.7
C389	4030010210	S.CER C3216 JB 1C 105M-T	B	92/240.3
C390	4030011600	S.CER C1608 JB 1E 104K-T	B	105.7/234.1
C391	4030011600	S.CER C1608 JB 1E 104K-T	B	98.4/241
C392	4030011600	S.CER C1608 JB 1E 104K-T	B	83.5/242.2
C393	4030008860	S.CER C1608 JB 1H 153K-T	B	96.2/229.5
C394	4030010210	S.CER C3216 JB 1C 105M-T	B	92.2/234.1
C395	4030008860	S.CER C1608 JB 1H 153K-T	B	95.5/224.2
C396	4030011600	S.CER C1608 JB 1E 104K-T	B	109.8/227.9
C397	4550006470	S.TAN TEESVB2 1D 106M8R	T	108.3/228.8
C398	4030011600	S.CER C1608 JB 1E 104K-T	T	158/152.3
C399	4030011600	S.CER C1608 JB 1E 104K-T	T	147.3/147.6
C401	4030006880	S.CER C1608 JB 1H 472K-T	B	50.9/230.1
C402	4030010210	S.CER C3216 JB 1C 105M-T	B	41.9/235.1
C403	4030009520	S.CER C1608 CH 1H 020B-T	B	43.9/233.7
C404	4030007050	S.CER C1608 CH 1H 220J-T	B	43.9/236.5
C405	4030010760	S.CER C1608 CH 1H 331J-T	B	46.1/237.3
C410	4030006880	S.CER C1608 JB 1H 472K-T	B	38.6/224.9
C411	4030006880	S.CER C1608 JB 1H 472K-T	B	40.2/224.9
C421	4030006880	S.CER C1608 JB 1H 472K-T	B	84.5/139.5
C422	4030006880	S.CER C1608 JB 1H 472K-T	B	96.5/139.5
C423	4030006880	S.CER C1608 JB 1H 472K-T	B	86/135.7
C424	4030006880	S.CER C1608 JB 1H 472K-T	B	95.2/135.7
C425	4030006880	S.CER C1608 JB 1H 472K-T	B	89/135
C426	4030006880	S.CER C1608 JB 1H 472K-T	B	91.3/142.6
C427	4030006880	S.CER C1608 JB 1H 472K-T	B	93.1/142.6
C428	4030006880	S.CER C1608 JB 1H 472K-T	B	87.9/142.6
C431	4030006880	S.CER C1608 JB 1H 472K-T	B	32.5/224.9
C432	4030006880	S.CER C1608 JB 1H 472K-T	B	34.1/224.9
C501	4030011600	S.CER C1608 JB 1E 104K-T	T	162.7/33.8
C502	4030018590	S.CER C1608 CH 1H 122J-T	T	162.7/37.7
C503	4030018600	S.CER C1608 CH 1H 152J-T	T	162.7/41.6
C505	4030011330	S.CER C1608 CH 1H 391J-T	T	162.7/44.2
C506	4030011600	S.CER C1608 JB 1E 104K-T	T	157.9/44.8
C507	4510008540	S.ELE EEE1CA100SR	T	156.6/47.9
C508	4510008540	S.ELE EEE1CA100SR	T	156.6/33.9
C509	4030011600	S.CER C1608 JB 1E 104K-T	T	155.3/37
C510	4030008470	S.CER C1608 JB 1H 272K-T	T	150.5/41.6
C511	4030011280	S.CER C1608 CH 1H 271J-T	T	150.5/44.2
C512	4030011600	S.CER C1608 JB 1E 104K-T	T	145.7/44.8
C513	4510008540	S.ELE EEE1CA100SR	T	144.4/47.9
C514	4030011600	S.CER C1608 JB 1E 104K-T	T	143.1/37
C515	4510008540	S.ELE EEE1CA100SR	T	144.4/33.9
C516	4030017810	S.CER C1608 CH 1H 102J-T	B	132.9/39.1
C517	4030011600	S.CER C1608 JB 1E 104K-T	T	133.6/38
C518	4030011600	S.CER C1608 JB 1E 104K-T	T	133.6/43.8
C519	4030011600	S.CER C1608 JB 1E 104K-T	T	133.6/45.1
C520	4510008540	S.ELE EEE1CA100SR	T	133.6/48.2
C521	4030011600	S.CER C1608 JB 1E 104K-T	T	138.3/40.2
C522	4030011600	S.CER C1608 JB 1E 104K-T	T	126.6/45.8
C523	4030011600	S.CER C1608 JB 1E 104K-T	T	126.6/38
C524	4510008540	S.ELE EEE1CA100SR	T	126.9/34.9
C525	4030006880	S.CER C1608 JB 1H 472K-T	T	129.4/41.9
C526	4030011600	S.CER C1608 JB 1E 104K-T	T	123.7/40.6
C527	4030006880	S.CER C1608 JB 1H 472K-T	T	120.8/43.2
C528	4030011600	S.CER C1608 JB 1E 104K-T	T	118.1/34.4
C529	4030011600	S.CER C1608 JB 1E 104K-T	T	115.9/44.5
C530	4030011600	S.CER C1608 JB 1E 104K-T	T	107.9/44.5
C531	4030006880	S.CER C1608 JB 1H 472K-T	B	104.7/42
C532	4030006880	S.CER C1608 JB 1H 472K-T	B	112.7/42
C533	4030006880	S.CER C1608 JB 1H 472K-T	B	106.3/52.2
C534	4030006880	S.CER C1608 JB 1H 472K-T	B	114.3/52.2
C535	4030006880	S.CER C1608 JB 1H 472K-T	B	108.5/55.7
C536	4030011600	S.CER C1608 JB 1E 104K-T	B	115.9/58.8
C538	4030008920	S.CER C1608 JB 1H 473K-T	B	105.4/58.4
C539	4030011600	S.CER C1608 JB 1E 104K-T	T	116.5/55.7
C540	4510008540	S.ELE EEE1CA100SR	T	113.4/55.7
C541	4030011600	S.CER C1608 JB 1E 104K-T	B	111.4/59
C544	4030009530	S.CER C1608 CH 1H 030B-T	B	112/81.2
C546	4030011340	S.CER C1608 CH 1H 471J-T	B	100.9/70.2
C551	4030006880	S.CER C1608 JB 1H 472K-T	B	111.2/98.2
C552	4030017810	S.CER C1608 CH 1H 102J-T	B	111.2/105.5
C553	4030011770	S.CER C1608 CH 1H 060B-T	B	110.5/103.2
C554	4030011600	S.CER C1608 JB 1E 104K-T	B	108.2/96.1

[RF UNIT]

REF NO.	ORDER NO.	DESCRIPTION	M.	H/V LOCATION
C555	4030007030	S.CER C1608 CH 1H 150J-T	B	105/96.1
C556	4030006880	S.CER C1608 JB 1H 472K-T	B	105.8/93.7
C558	4030007040	S.CER C1608 CH 1H 180J-T	B	100.9/116.7
C559	4030006880	S.CER C1608 JB 1H 472K-T	B	90/124.4
C560	4030007080	S.CER C1608 CH 1H 390J-T	B	92.3/119.5
C561	4030006880	S.CER C1608 JB 1H 472K-T	B	97.3/116.9
C562	4030011710	S.CER C1608 CH 1H 102J-T	B	87/111.7
C563	4030018600	S.CER C1608 JB 1E 104K-T	B	98.8/126.7
C564	4030007080	S.CER C1608 CH 1H 390J-T	T	104.2/125.6
C565	4030007130	S.CER C1608 CH 1H 101J-T	T	108.8/125.4
C566	4030007120	S.CER C1608 CH 1H 820J-T	T	106.6/129.1
C567	4030007090	S.CER C1608 CH 1H 470J-T	T	110.8/125.9
C568	4030007130	S.CER C1608 CH 1H 101J-T	T	112.7/128.2
C569	4030011600	S.CER C1608 JB 1E 104K-T	T	120.7/124.7
C570	4030006900	S.CER C1608 JB 1E 103K-T	B	115.3/125.7
C571	4030011600	S.CER C1608 JB 1E 104K-T	B	128/126.2
C572	4030006900	S.CER C1608 JB 1E 103K-T	B	124.9/126.2
C573	4030011600	S.CER C1608 JB 1E 104K-T	B	115.3/115.8
C574	4030011600	S.CER C1608 JB 1E 104K-T	T	121.8/111.6
C576	4610001590	S.TRI TZC3R100A110R00	T	106.6/87
C577	4030011600	S.CER C1608 JB 1E 104K-T	T	121.8/114.4
C578	4030007100	S.CER C1608 CH 1H 560J-T	B	92/96.2
C579	4030006980	S.CER C1608 CH 1H 070D-T	B	94.6/97
C580	4030007100	S.CER C1608 CH 1H 560J-T	B	93.8/94.6
C581	4030007050	S.CER C1608 CH 1H 220J-T	B	153.5/40.9
C582	4030007050	S.CER C1608 CH 1H 220J-T	B	141.3/40.9
C584	4030009650	S.CER C1608 CH 1H 240J-T	B	91.6/108.2
C585	4030006980	S.CER C1608 CH 1H 070D-T	B	93.2/109.9
C586	4030007070	S.CER C1608 CH 1H 330J-T	B	94.9/108.2
C587	4030007010	S.CER C1608 CH 1H 100D-T	B	95.7/110.7
C588	4030007060	S.CER C1608 CH 1H 270J-T	B	96.5/108.2
C589	4030007020	S.CER C1608 CH 1H 120J-T	T	113.5/124.7
C590	4030007100	S.CER C1608 CH 1H 560J-T	T	117.3/126.6
C595	4030006860	S.CER C1608 JB 1H 102K-T	B	116.3/106
C601	4030017810	S.CER C1608 CH 1H 102J-T	B	125.7/66.4
C602	4030017810	S.CER C1608 CH 1H 102J-T	B	125.7/68.2
C603	4030011600	S.CER C1608 JB 1E 104K-T	B	129/66.4
C604	4030007140	S.CER C1608 CH 1H 121J-T	B	128.3/63.6
C605	4030010760	S.CER C1608 CH 1H 331J-T	B	130.1/63.6
C606	4030007160	S.CER C1608 CH 1H 181J-T	B	132.6/59.3
C607	4030007060	S.CER C1608 CH 1H 270J-T	B	132.6/61.1
C608	4030010760	S.CER C1608 CH 1H 331J-T	B	131.9/63.6
C609	4030007090	S.CER C1608 CH 1H 470J-T	B	137.3/63.6
C610	4030007160	S.CER C1608 CH 1H 181J-T	B	136.6/61.1
C611	4030007060	S.CER C1608 CH 1H 270J-T	B	136.6/59.3
C612	4030007140	S.CER C1608 CH 1H 121J-T	B	141/63.6
C613	4030010760	S.CER C1608 CH 1H 331J-T	B	139.1/63.6
C614	4030017810	S.CER C1608 CH 1H 102J-T	B	143.6/66.4
C615	4030011600	S.CER C1608 JB 1E 104K-T	B	140.3/66.4
C616	4030017810	S.CER C1608 CH 1H 102J-T	B	143.6/68.2
C617	4030017800	S.CER C1608 CH 1H 561J-T	B	125.7/77.2
C618	4030010760	S.CER C1608 CH 1H 331J-T	B	125.7/79
C619	4030011600	S.CER C1608 JB 1E 104K-T	B	129/77.2
C620	4030010760	S.CER C1608 CH 1H 331J-T	B	128.3/74.4
C621	4030007080	S.CER C1608 CH 1H 390J-T	B	130.1/74.4
C622	4030007080	S.CER C1608 CH 1H 390J-T	B	132.6/70
C623	4030010760	S.CER C1608 CH 1H 331J-T	B	132.6/71.9
C624	4030007090	S.CER C1608 CH 1H 470J-T	B	131.9/74.4
C625	4030010760	S.CER C1608 CH 1H 331J-T	B	137.3/74.4
C626	4030007080	S.CER C1608 CH 1H 390J-T	B	136.6/71.9
C627	4030010760	S.CER C1608 CH 1H 331J-T	B	136.6/70.1
C628	4030007080	S.CER C1608 CH 1H 390J-T	B	141/74.4
C629	4030010760	S.CER C1608 CH 1H 331J-T	B	139.1/74.4
C630	4030010760	S.CER C1608 CH 1H 331J-T	B	143.6/77.2
C631	4030011600	S.CER C1608 JB 1E 104K-T	B	140.3/77.2
C632	4030017800	S.CER C1608 CH 1H 561J-T	B	143.6/79
C633	4030017800	S.CER C1608 CH 1H 561J-T	B	125.7/88
C634	4030011330	S.CER C1608 CH 1H 391J-T	B	125.7/89.8
C635	4030011600	S.CER C1608 JB 1E 104K-T	B	129/88
C636	4030007160	S.CER C1608 CH 1H 181J-T	B	128.3/85.2
C637	4030007070	S.CER C1608 CH 1H 330J-T	B	

[RF UNIT]

REF NO.	ORDER NO.	DESCRIPTION	M.	H/V LOCATION
C671	4030007070	S.CER C1608 CH 1H 330J-T	B	132.6/104.4
C672	4030007050	S.CER C1608 CH 1H 220J-T	B	137.3/106.9
C673	4030007120	S.CER C1608 CH 1H 820J-T	B	131.9/106.9
C674	4030007080	S.CER C1608 CH 1H 390J-T	B	136.6/104.4
C675	4030007070	S.CER C1608 CH 1H 330J-T	B	136.6/102.6
C676	4030007050	S.CER C1608 CH 1H 220J-T	B	141/106.9
C677	4030007130	S.CER C1608 CH 1H 101J-T	B	139.1/106.9
C678	4030007170	S.CER C1608 CH 1H 221J-T	B	143.6/109.7
C679	4030011600	S.CER C1608 JB 1E 104K-T	B	140.3/109.7
C680	4030007170	S.CER C1608 CH 1H 221J-T	B	143.6/111.5
C681	4030007170	S.CER C1608 CH 1H 221J-T	T	127.4/59.8
C682	4030007110	S.CER C1608 CH 1H 680J-T	T	127.4/61.1
C683	4030011600	S.CER C1608 JB 1E 104K-T	T	130.2/61.1
C684	4030007090	S.CER C1608 CH 1H 470J-T	T	131/63.8
C685	4030007090	S.CER C1608 CH 1H 470J-T	T	132.3/63.8
C686	4030007070	S.CER C1608 CH 1H 330J-T	T	131.7/65.9
C687	4030007070	S.CER C1608 CH 1H 330J-T	T	131.7/67.2
C688	4030007010	S.CER C1608 CH 1H 100D-T	T	134.6/61.6
C689	4030007120	S.CER C1608 CH 1H 820J-T	T	134.6/62.9
C690	4030007070	S.CER C1608 CH 1H 330J-T	T	137.6/67.2
C691	4030007070	S.CER C1608 CH 1H 330J-T	T	137.6/65.9
C692	4030007090	S.CER C1608 CH 1H 470J-T	T	137.1/63.3
C693	4030007090	S.CER C1608 CH 1H 470J-T	T	138.4/63.3
C694	4030007110	S.CER C1608 CH 1H 680J-T	T	141.9/59.8
C695	4030011600	S.CER C1608 JB 1E 104K-T	T	139.1/61.1
C696	4030007050	S.CER C1608 CH 1H 220J-T	T	141.9/61.1
C697	4030007160	S.CER C1608 CH 1H 181J-T	T	126.6/69.5
C698	4030007090	S.CER C1608 CH 1H 470J-T	T	127.9/69.5
C699	4030011600	S.CER C1608 JB 1E 104K-T	T	130.2/70.1
C700	4030007090	S.CER C1608 CH 1H 470J-T	T	131/72.3
C701	4030007040	S.CER C1608 CH 1H 180J-T	T	132.3/72.3
C702	4030007030	S.CER C1608 CH 1H 150J-T	T	131.7/74.8
C703	4030007050	S.CER C1608 CH 1H 220J-T	T	131.7/76.2
C704	4030006990	S.CER C1608 CH 1H 080D-T	T	134.6/71.9
C705	4030007090	S.CER C1608 CH 1H 470J-T	T	134.6/70.6
C706	4030007030	S.CER C1608 CH 1H 150J-T	T	137.6/74.8
C707	4030007050	S.CER C1608 CH 1H 220J-T	T	137.6/76.2
C708	4030007040	S.CER C1608 CH 1H 180J-T	T	137.1/72.3
C709	4030007090	S.CER C1608 CH 1H 470J-T	T	138.4/72.3
C710	4030007090	S.CER C1608 CH 1H 470J-T	T	141.9/68.8
C711	4030011600	S.CER C1608 JB 1E 104K-T	T	139.1/70.1
C712	4030007160	S.CER C1608 CH 1H 181J-T	T	141.9/70.1
C713	4030007140	S.CER C1608 CH 1H 121J-T	T	127.4/79.1
C714	4030007040	S.CER C1608 CH 1H 180J-T	T	127.4/77.8
C715	4030011600	S.CER C1608 JB 1E 104K-T	T	130.2/79.1
C716	4030007070	S.CER C1608 CH 1H 330J-T	T	131/81.3
C717	4030007040	S.CER C1608 CH 1H 180J-T	T	132.3/81.3
C718	4030007010	S.CER C1608 CH 1H 100D-T	T	131.7/83.9
C719	4030007070	S.CER C1608 CH 1H 330J-T	T	131.7/85.2
C720	4030007010	S.CER C1608 CH 1H 100D-T	T	134.6/79.6
C721	4030007090	S.CER C1608 CH 1H 470J-T	T	134.6/80.9
C722	4030007010	S.CER C1608 CH 1H 100D-T	T	137.6/83.9
C723	4030007070	S.CER C1608 CH 1H 330J-T	T	137.6/85.2
C724	4030007040	S.CER C1608 CH 1H 180J-T	T	137.1/81.3
C725	4030007070	S.CER C1608 CH 1H 330J-T	T	138.4/81.3
C726	4030007040	S.CER C1608 CH 1H 180J-T	T	141.9/77.8
C727	4030011600	S.CER C1608 JB 1E 104K-T	T	139.1/79.1
C728	4030007140	S.CER C1608 CH 1H 121J-T	T	141.9/79.1
C729	4030007130	S.CER C1608 CH 1H 101J-T	T	127.4/88.1
C730	4030007030	S.CER C1608 CH 1H 150J-T	T	127.4/86.8
C731	4030011600	S.CER C1608 JB 1E 104K-T	T	130.2/88.1
C732	4030007050	S.CER C1608 CH 1H 220J-T	T	131/90.3
C733	4030007020	S.CER C1608 CH 1H 120J-T	T	132.3/90.3
C734	4030009500	S.CER C1608 CH 1H 0R5B-T	T	131.7/92.9
C735	4030007050	S.CER C1608 CH 1H 220J-T	T	131.7/94.2
C736	4030006980	S.CER C1608 CH 1H 070D-T	T	134.6/88.6
C737	4030007050	S.CER C1608 CH 1H 220J-T	T	134.6/89.9
C738	4030009500	S.CER C1608 CH 1H 0R5B-T	T	137.6/92.9
C739	4030007050	S.CER C1608 CH 1H 220J-T	T	137.6/94.2
C740	4030007020	S.CER C1608 CH 1H 120J-T	T	137.1/90.3
C741	4030007050	S.CER C1608 CH 1H 220J-T	T	138.4/90.3
C742	4030007030	S.CER C1608 CH 1H 150J-T	T	141.9/86.8
C743	4030011600	S.CER C1608 JB 1E 104K-T	T	139.1/88.1
C744	4030007130	S.CER C1608 CH 1H 101J-T	T	141.9/88.1
C745	4030007140	S.CER C1608 CH 1H 121J-T	T	128.5/99
C747	4030011600	S.CER C1608 JB 1E 104K-T	T	129.3/97
C749	4030009550	S.CER C1608 CH 1H 2R5B-T	T	131.9/101.4
C750	4030011770	S.CER C1608 CH 1H 060B-T	T	131.2/99.3
C751	4030007010	S.CER C1608 CH 1H 100D-T	T	132.6/99.3
C755	4030009550	S.CER C1608 CH 1H 2R5B-T	T	137.1/101.4
C756	4030011770	S.CER C1608 CH 1H 060B-T	T	137.9/99.3
C758	4030011600	S.CER C1608 JB 1E 104K-T	T	140/97
C759	4030007140	S.CER C1608 CH 1H 121J-T	T	140.8/99
C760	4030011770	S.CER C1608 CH 1H 060B-T	T	129.9/99.3
C761	4030011770	S.CER C1608 CH 1H 060B-T	T	136.3/99.3
C801	4030006880	S.CER C1608 JB 1H 472K-T	T	158/62.9
C802	4030011600	S.CER C1608 JB 1E 104K-T	T	151.1/62.9
C803	4030011600	S.CER C1608 JB 1E 104K-T	B	153.6/61.4
C804	4030011600	S.CER C1608 JB 1E 104K-T	T	159.1/73.1
C805	4030011600	S.CER C1608 JB 1E 104K-T	B	153.8/79.6
C806	4030006900	S.CER C1608 JB 1H 103K-T	B	154.6/76.1
C807	4030011600	S.CER C1608 JB 1E 104K-T	T	153.4/74.7
C812	4030006900	S.CER C1608 JB 1H 103K-T	B	163.6/99.1
C813	4030006880	S.CER C1608 JB 1H 472K-T	T	150.6/56.5
C814	4030012600	S.CER C2012 JB 1A 105M-T	T	152.2/56.2
C815	4030006990	S.CER C1608 CH 1H 080D-T	B	158/70.1
C816	4030012600	S.CER C2012 JB 1A 105M-T	T	149/56.1
C839	4030006880	S.CER C1608 JB 1H 472K-T	B	89.1/98
C840	4030011600	S.CER C1608 JB 1E 104K-T	B	85/96.5
C841	4030006880	S.CER C1608 JB 1H 472K-T	B	87.4/92.6
C871	4030006880	S.CER C1608 JB 1H 472K-T	B	27.7/224.5
C872	4030006880	S.CER C1608 JB 1H 472K-T	B	24.6/225
C904	4030006900	S.CER C1608 JB 1H 103K-T	B	71/142.3
C906	4030006880	S.CER C1608 JB 1H 472K-T	B	62.2/135.6

[RF UNIT]

REF NO.	ORDER NO.	DESCRIPTION	M.	H/V LOCATION
C907	4030011600	S.CER C1608 JB 1E 104K-T	B	80.5/139.8
C909	4030011600	S.CER C1608 JB 1E 104K-T	B	65.7/135
C910	4030006880	S.CER C1608 JB 1H 472K-T	T	79.7/143.5
C911	4030009920	S.CER C1608 CH 1H 050B-T	B	60.3/139.3
C912	4030006900	S.CER C1608 JB 1H 103K-T	B	81.7/137
C913	4030011600	S.CER C1608 JB 1E 104K-T	B	75.1/134.2
C914	4030006880	S.CER C1608 JB 1H 472K-T	T	79.7/140.8
C915	4030006900	S.CER C1608 JB 1H 103K-T	B	68.8/134.2
C917	4030007010	S.CER C1608 CH 1H 100D-T	B	68.6/128.1
C919	4030006880	S.CER C1608 JB 1H 472K-T	B	60.3/145.6
C920	4030006880	S.CER C1608 JB 1H 472K-T	B	60.6/131
C1001	4030007170	S.CER C1608 CH 1H 221J-T	T	16.6/137.1
C1008	4030006880	S.CER C1608 JB 1H 472K-T	B	50.7/134.3
C1009	4030006880	S.CER C1608 JB 1H 472K-T	B	49.9/119.8
C1010	4030012600	S.CER C2012 JB 1A 105M-T	B	38.1/139.5
C1011	4030012600	S.CER C2012 JB 1A 105M-T	T	38.1/144.4
C1012	4030010210	S.CER C3216 JB 1C 105M-T	B	38.8/145.6
C1013	4030012600	S.CER C2012 JB 1A 105M-T	T	38.1/138.6
C1014	4030018810	S.CER C3216 CH 1H 333J-T	T	25.5/147.7
C1016	4030012600	S.CER C2012 JB 1A 105M-T	B	41.4/129.2
C1017	4030012600	S.CER C2012 JB 1A 105M-T	B	41.4/118.2
C1020	4030012600	S.CER C2012 JB 1A 105M-T	B	33.5/126.1
C1021	4030012600	S.CER C2012 JB 1A 105M-T	B	33.5/112.2
C1024	4030010210	S.CER C3216 JB 1C 105M-T	B	29.7/125.5
C1025	4030010210	S.CER C3216 JB 1C 105M-T	B	29.6/111.6
C1026	4030010210	S.CER C3216 JB 1C 105M-T	B	22.1/132.5
C1027	4030010210	S.CER C3216 JB 1C 105M-T	B	22.1/119.9
C1028	4030006880	S.CER C1608 JB 1H 472K-T	B	11.5/122.4
C1029	4030006880	S.CER C1608 JB 1H 472K-T	B	12.2/136.9
C1032	4030011600	S.CER C1608 JB 1E 104K-T	T	15.4/131.3
C1033	4550006470	S.TAN TEESVB2 1D 106M8R	B	38.2/150.2
C1034	4550006470	S.TAN TEESVB2 1D 106M8R	T	19.5/131.4
C1037	4030007090	S.CER C1608 CH 1H 470J-T	T	24.3/144.5
C1038	4030017810	S.CER C1608 CH 1H 102J-T	T	37.7/141.5
C1039	4030017810	S.CER C1608 CH 1H 102J-T	B	39.9/147.3
C1040	4030017810	S.CER C1608 CH 1H 102J-T	B	35.7/137.7
C1041	4030006990	S.CER C1608 CH 1H 080D-T	T	27.3/141.3
C1046	4030007010	S.CER C1608 CH 1H 100D-T	B	18.7/125.9
C1048	4030017810	S.CER C1608 CH 1H 102J-T	B	31.3/129.8
C1049	4030017810	S.CER C1608 CH 1H 102J-T	B	31.3/116
C1050	4030017810	S.CER C1608 CH 1H 102J-T	B	28.8/127.5
C1051	4030017810	S.CER C1608 CH 1H 102J-T	B	28.8/113.6
C1052	4030007100	S.CER C1608 CH 1H 560J-T	B	44.9/119.3
C1053	4030007110	S.CER C1608 CH 1H 680J-T	T	3.1/141.7
C1054	4030007010	S.CER C1608 CH 1H 100D-T	T	4.4/141.7
C1055	4030007140	S.CER C1608 CH 1H 121J-T	T	3.6/139.6
C1056	4030007050	S.CER C1608 CH 1H 220J-T	T	3.6/138.3
C1057	4030007130	S.CER C1608 CH 1H 101J-T	T	3.1/136.1
C1060	4030017810	S.CER C1608 CH 1H 102J-T	B	3.1/109
C1061	4030007090	S.CER C1608 CH 1H 470J-T	T	49.2/83.9
C1062	4030007170	S.CER C1608 CH 1H 221J-T	T	50.5/83.9
C1064	4030007090	S.CER C1608 CH 1H 470J-T	T	50/81.8
C1066	4030007010	S.CER C1608 CH 1H 100D-T	T	50/77.8
C1067	4030007010	S.CER C1608 CH 1H 100D-T	T	3.6/133.8
C1068	4030009510	S.CER C1608 CH 1H 010B-T	B	28.9/132.2
C1069	4030009510	S.CER C1608 CH 1H 010B-T	B	28.9/118.4
C1070	4030006990	S.CER C1608 CH 1H 070D-T	T	50/79.2
C1071	4030007100	S.CER C1608 CH 1H 560J-T	T	5.7/128.3
C1072	4030007170	S.CER C1608 CH 1H 221J-T	T	3.6/125.6
C1073	4030007080	S.CER C1608 CH 1H 390J-T	T	4.4/128.3
C1074	4030007060	S.CER C1608 CH 1H 270J-T	T	50/80.5
C1081	4030006900	S.CER C1608 JB 1H 103K-T	B	38.3/96.1
C1082	4030006900	S.CER C1608 JB 1H 103K-T	B	39.7/91.8
C1083	4030006900	S.CER C1608 JB 1H 103K-T	T	42.6/90.3
C1084	4030006880	S.CER C1608 JB 1H 472K-T	T	41/88.2
C1085	4030006880	S.CER C1608 JB 1H 472K-T	T	39.7/88.2
C1091	4030006880	S.CER C1608 JB 1H 472K-T	T	51.8/51.9
C1092	4030006880	S.CER C1608 JB 1H 472K-T	T	51.8/54.6
C1093	4030006880	S.CER C1608 JB 1H 472K-T	T	39.5/55.6
C1101	4030006900	S.CER C1608		

[RF UNIT]

REF NO.	ORDER NO.	DESCRIPTION	M.	H/V LOCATION
C1228	4030009920	S.CER C1608 CH 1H 050B-T	B	64.1/101.5
C1231	4030006900	S.CER C1608 JB 1H 103K-T	B	59.4/114.4
C1232	4030006900	S.CER C1608 JB 1H 103K-T	B	68.9/114.4
C1234	4030006900	S.CER C1608 JB 1H 103K-T	B	48.6/106
C1235	4030006880	S.CER C1608 JB 1H 472K-T	B	59.4/104.6
C1236	4030006900	S.CER C1608 JB 1H 103K-T	B	58.5/104.6
C1238	4030006900	S.CER C1608 JB 1H 103K-T	B	62.6/106
C1239	4030006880	S.CER C1608 JB 1H 472K-T	B	73.4/104.6
C1240	4030006900	S.CER C1608 JB 1H 103K-T	T	69.7/104.6
C1241	4030006900	S.CER C1608 JB 1H 103K-T	T	69.7/98.3
C1244	4030007040	S.CER C1608 CH 1H 180J-T	T	52.2/97
C1245	4030007130	S.CER C1608 CH 1H 101J-T	T	49.4/97
C1246	4030007120	S.CER C1608 CH 1H 820J-T	T	50.6/99.8
C1247	4030007090	S.CER C1608 CH 1H 470J-T	T	47.2/99.8
C1248	4030007130	S.CER C1608 CH 1H 101J-T	T	48/102
C1249	4030007020	S.CER C1608 CH 1H 120J-T	T	44.9/102
C1250	4030007040	S.CER C1608 CH 1H 180J-T	T	47.2/104.2
C1251	4030006900	S.CER C1608 JB 1H 103K-T	T	27.2/94.3
C1252	4030006900	S.CER C1608 JB 1H 103K-T	T	34.8/94.3
C1253	4030006900	S.CER C1608 JB 1H 103K-T	B	34.9/76
C1255	4030017810	S.CER C1608 CH 1H 102J-T	B	31/87.9
C1256	4030007010	S.CER C1608 CH 1H 100D-T	T	31/88.2
C1257	4030011600	S.CER C1608 JB 1E 104K-T	B	31/83.6
C1258	4030007080	S.CER C1608 CH 1H 390J-T	B	37/89.5
C1264	4030007110	S.CER C1608 CH 1H 680J-T	B	64.1/99.2
C1265	4610001830	S.TRI TZB4S100AB10R00	T	41/107.4
C1266	4030007020	S.CER C1608 CH 1H 120J-T	T	44.9/107.8
C1267	4030006880	S.CER C1608 JB 1H 472K-T	B	29.9/60.5
C1268	4030006980	S.CER C1608 CH 1H 070D-T	T	49.4/95.7
C1302	4030007060	S.CER C1608 CH 1H 270J-T	T	28.1/76.1
C1303	4030006980	S.CER C1608 CH 1H 070D-T	T	28.1/74.1
C1304	4030007070	S.CER C1608 CH 1H 330J-T	T	28.1/72.8
C1305	4030007010	S.CER C1608 CH 1H 100D-T	T	34/72.4
C1306	4030009650	S.CER C1608 CH 1H 240J-T	T	28.1/71.5
C1307	4030007030	S.CER C1608 CH 1H 150J-T	T	34/66.9
C1308	4030006900	S.CER C1608 JB 1H 103K-T	T	33.6/60.4
C1309	4030007080	S.CER C1608 CH 1H 390J-T	T	31/59.9
C1310	4030007080	S.CER C1608 CH 1H 390J-T	T	29.5/57.3
C1311	4030006900	S.CER C1608 JB 1H 103K-T	B	37.3/69
C1312	4030007060	S.CER C1608 CH 1H 270J-T	T	32/75.3
C1313	4030007060	S.CER C1608 CH 1H 270J-T	T	29.5/58.6
C1314	4030007030	S.CER C1608 CH 1H 150J-T	T	31.4/69.3
C1355	4030006880	S.CER C1608 JB 1H 472K-T	B	68.1/73.8
C1357	4030007000	S.CER C1608 CH 1H 090D-T	T	64.5/72.5
C1358	4030011600	S.CER C1608 JB 1E 104K-T	B	64.4/77.8
C1360	4030011600	S.CER C1608 JB 1E 104K-T	T	68/75.2
C1361	4030007020	S.CER C1608 CH 1H 120J-T	B	60.2/82.2
C1403	4030017810	S.CER C1608 CH 1H 102J-T	T	34.3/52.7
C1404	4030017810	S.CER C1608 CH 1H 102J-T	B	34.7/2.9
C1405	4030006900	S.CER C1608 JB 1H 103K-T	T	42.1/57.7
C1406	4030017810	S.CER C1608 CH 1H 102J-T	T	32.1/46.3
C1407	4030017810	S.CER C1608 CH 1H 102J-T	T	27.3/46.3
C1418	4030017810	S.CER C1608 CH 1H 102J-T	T	27.1/4.6
C1419	4030017810	S.CER C1608 CH 1H 102J-T	B	34.7/6.1
C1420	4030007120	S.CER C1608 CH 1H 820J-T	T	55.1/5
C1421	4030007150	S.CER C1608 CH 1H 151J-T	T	55.1/7.8
C1423	4030010750	S.CER C1608 CH 1H 201J-T	T	52.4/12.8
C1424	4030007010	S.CER C1608 CH 1H 100D-T	B	56.5/10.9
C1425	4030011600	S.CER C1608 JB 1E 104K-T	B	58.1/21.6
C1426	4030011600	S.CER C1608 JB 1E 104K-T	B	58.1/20
C1427	4030006900	S.CER C1608 JB 1H 103K-T	B	55.7/19.9
C1428	4030006980	S.CER C1608 CH 1H 070D-T	T	65.4/15
C1429	4030006900	S.CER C1608 JB 1H 103K-T	T	68/15
C1430	4030007040	S.CER C1608 CH 1H 180J-T	B	79.6/12.6
C1431	4030017810	S.CER C1608 CH 1H 102J-T	T	65.4/6.2
C1432	4030018600	S.CER C1608 CH 1H 152J-T	B	79.6/9.8
C1433	4030011600	S.CER C1608 JB 1E 104K-T	T	67.5/6.7
C1434	4030009920	S.CER C1608 CH 1H 050B-T	B	98.1/13.9
C1435	4030009920	S.CER C1608 CH 1H 050B-T	B	94.9/13.9
C1436	4030011600	S.CER C1608 JB 1E 104K-T	B	72.3/5.4
C1437	4030007170	S.CER C1608 CH 1H 221J-T	B	77.8/9.8
C1441	4030006880	S.CER C1608 JB 1H 472K-T	T	66.7/15
C1501	4030018640	S.CER C2012 CH 1H 103J-T	T	88/5.4
C1502	4550003220	S.TAN TEESVA 1E 105M8R	T	106/7.6
C1503	4030006900	S.CER C1608 JB 1H 103K-T	T	107.2/21.5
C1504	4030012610	S.CER C2012 JB 1C 474K-T	T	107/23.1
C1505	4030007010	S.CER C1608 CH 1H 100D-T	T	110/5.4
C1506	4030010760	S.CER C1608 CH 1H 331J-T	T	113.1/6.7
C1507	4510008540	S.ELE EEE1CA100SR	T	111.8/28.7
C1508	4030011600	S.CER C1608 JB 1E 104K-T	T	108.7/30.5
C1509	4030018800	S.CER C3216 CH 1H 223J-T	T	112/11
C1510	4030007110	S.CER C1608 CH 1H 680J-T	T	121.2/3.8
C1511	4510008540	S.ELE EEE1CA100SR	T	118.1/12.7
C1512	4030011600	S.CER C1608 JB 1E 104K-T	T	119.7/15.8
C1513	4030011600	S.CER C1608 JB 1E 104K-T	T	122.4/15.8
C1514	4510008540	S.ELE EEE1CA100SR	T	124/12.7
C1515	4030007160	S.CER C1608 CH 1H 181J-T	T	129/13.2
C1516	4030009350	S.CER C1608 CH 1H 3R5B-T	T	129/14.5
C1517	4030007110	S.CER C1608 CH 1H 680J-T	T	121.1/29.6
C1518	4030018640	S.CER C2012 CH 1H 103J-T	T	96.5/5.4
C1519	4550003220	S.TAN TEESVA 1E 105M8R	T	105.9/19.8
C1520	4030006900	S.CER C1608 JB 1H 103K-T	T	107.2/9.3
C1521	4030012610	S.CER C2012 JB 1C 474K-T	T	107/10.9
C1522	4030007010	S.CER C1608 CH 1H 100D-T	T	110/17.6
C1523	4030010760	S.CER C1608 CH 1H 331J-T	T	113.1/18.9
C1524	4030018800	S.CER C3216 CH 1H 223J-T	T	111.9/23.2
C1525	4510008540	S.ELE EEE1CA100SR	T	118.1/20.7
C1526	4030011600	S.CER C1608 JB 1E 104K-T	T	119.7/17.6
C1527	4030011600	S.CER C1608 JB 1E 104K-T	T	122.4/17.6
C1528	4510008540	S.ELE EEE1CA100SR	T	124/20.7
C1529	4030017870	S.CER C1608 CH 1H 681J-T	T	129/20.2
C1530	4030011330	S.CER C1608 CH 1H 391J-T	T	129/18.9
C1531	4510008500	S.ELE EEE1CA101WP	T	141.4/26.5
C1532	4030011600	S.CER C1608 JB 1E 104K-T	B	137.5/24.2

[RF UNIT]

REF NO.	ORDER NO.	DESCRIPTION	M.	H/V LOCATION
C1533	4030011600	S.CER C1608 JB 1E 104K-T	B	135.5/24.2
C1534	4510008500	S.ELE EEE1CA101WP	T	134.3/26.5
C1535	4030011600	S.CER C1608 JB 1E 104K-T	T	143.3/14.5
C1536	4030017870	S.CER C1608 CH 1H 681J-T	T	142.9/19.5
C1537	4510008500	S.ELE EEE1CA101WP	T	156.5/14.7
C1538	4030011600	S.CER C1608 JB 1E 104K-T	T	154.7/10.2
C1539	4030011600	S.CER C1608 JB 1E 104K-T	T	151.5/24.2
C1540	4510008500	S.ELE EEE1CA101WP	T	156.5/21.8
C1541	4030007050	S.CER C1608 CH 1H 220J-T	T	147.7/25.2
C1651	4030006880	S.CER C1608 JB 1H 472K-T	B	95.7/35.9
C1652	4030006880	S.CER C1608 JB 1H 472K-T	B	97.9/37.6
C1653	4030006880	S.CER C1608 JB 1H 472K-T	B	102.1/36.8
C1654	4030017810	S.CER C1608 CH 1H 102J-T	B	98.3/31.8
C1655	4030009530	S.CER C1608 CH 1H 030B-T	T	100.3/28.9
C1656	4610001970	S.TRI TZC3P200A110R00	T	99.7/25.6
C1657	4030017810	S.CER C1608 CH 1H 102J-T	T	85.9/19.9
C1658	4030017810	S.CER C1608 CH 1H 102J-T	T	94.1/19.9
C1659	4030011600	S.CER C1608 JB 1E 104K-T	T	83.5/28.7
C1660	4030011600	S.CER C1608 JB 1E 104K-T	B	158/14.5
C1661	4030011600	S.CER C1608 JB 1E 104K-T	B	153.4/3.6
C1662	4030011600	S.CER C1608 JB 1E 104K-T	T	150.3/4.2
C1663	4030011600	S.CER C1608 JB 1E 104K-T	T	143.3/11.9
C1665	4030006900	S.CER C1608 JB 1H 103K-T	B	152.3/7.1
C1666	4030006880	S.CER C1608 JB 1H 472K-T	B	82.9/35
C1701	4030006880	S.CER C1608 JB 1H 472K-T	B	75/100
C1702	4030006880	S.CER C1608 JB 1H 472K-T	B	75.8/104
C1703	4510004601	ELE 16 ME 1000 HC	T	66.9/24.1
C1704	4030011600	S.CER C1608 JB 1E 104K-T	T	64/24.1
C1705	4030011600	S.CER C1608 JB 1E 104K-T	T	58.1/27.8
C1706	4510009150	S.ELE EEE1EA470WP	T	117.3/148.2
C1707	4030011600	S.CER C1608 JB 1E 104K-T	T	104.9/138.6
C1717	4030006880	S.CER C1608 JB 1H 472K-T	T	104.9/140.2
C1718	4030006880	S.CER C1608 JB 1H 472K-T	T	104.9/143.4
C1720	4030006880	S.CER C1608 JB 1H 472K-T	T	104.9/141.8
C1721	4030006880	S.CER C1608 JB 1H 472K-T	T	104.9/145
C1722	4030006880	S.CER C1608 JB 1H 472K-T	T	104.9/146.6
C1723	4030006880	S.CER C1608 JB 1H 472K-T	T	126.6/147.5
C1724	4030011600	S.CER C1608 JB 1E 104K-T	B	121.3/137.3
C1725	4030011600	S.CER C1608 JB 1E 104K-T	T	136/126.9
C1901	4030011600	S.CER C1608 JB 1E 104K-T	T	149.6/126.9
C1902	4030011600	S.CER C1608 JB 1E 104K-T	T	143.7/137.7
C1903	4030011600	S.CER C1608 JB 1E 104K-T	T	157.1/137.7
C1904	4030011600	S.CER C1608 JB 1E 104K-T	B	129.3/242.3
C2001	4030007130	S.CER C1608 CH 1H 101J-T	B	142/238.7
C2002	4030006880	S.CER C1608 JB 1H 472K-T	B	146.5/139.7
C2003	4030006880	S.CER C1608 JB 1H 472K-T	T	159/173.7
C2004	4030011340	S.CER C1608 CH 1H 471J-T	T	172.8/171.6
C2006	4030011340	S.CER C1608 CH 1H 471J-T	T	167/189.7
C2007	4510009150	S.ELE EEE1EA470WP	T	159.1/175.2
C2009	4030011340	S.CER C1608 CH 1H 471J-T	T	167/218.4
C2010	4510009150	S.ELE EEE1EA470WP	T	172.8/178.8
C2012	4030011340	S.CER C1608 CH 1H 471J-T	T	163.5/209.3
C2013	4030006880	S.CER C1608 JB 1H 472K-T	T	163.5/206.7
C2015	4030006880	S.CER C1608 JB 1H 472K-T	T	163.5/204.1
C2016	4030006880	S.CER C1608 JB 1H 472K-T	T	163.5/201.5
C2017	4030006880	S.CER C1608 JB 1H 472K-T	T	172.8/156.9
C2018	4030006880	S.CER C1608 JB 1H 472K-T	T	163.5/198.9
C2019	4030006880	S.CER C1608 JB 1H 472K-T	T	172.8/161.5
C2020	4030006880	S.CER C1608 JB 1H 472K-T	T	172.8/168.9
C2021	4030011340	S.CER C1608 CH 1H 471J-T	T	159/170.7
C2022	4030011340	S.CER C1608 CH 1H 471J-T	T	159/172.2
C2023	4030011340	S.CER C1608 CH 1H 471J-T	T	
RL1	6330001860	RLY UA2-12NU		
RL2	6330001860	RLY UA2-12NU		
RL21	6330001860	RLY UA2-12NU		
RL22	6330001860	RLY UA2-12NU		
RL51	6330001860	RLY UA2-12NU		
RL52	6330001860	RLY UA2-12NU		
RL81	6330001860	RLY UA2-12NU		
RL82	6330001860	RLY UA2-12NU		
RL111	6330001860	RLY UA2-12NU		
RL112	6330001860	RLY UA2-12NU		
RL141	6330001860	RLY UA2-12NU		
RL142	6330001860	RLY UA2-12NU		
RL171	6330			

[RF UNIT]

REF NO.	ORDER NO.	DESCRIPTION	M.	H/V LOCATION
J103	6510023750	CNR 01K1971-10 ()		
J104	6510023750	CNR 01K1971-10 ()		
J105	6510023750	CNR 01K1971-10 ()		
J106	6510007020	CNR TMP-J01X-V6		
J108	6510007020	CNR TMP-J01X-V6		
J351	6510007020	CNR TMP-J01X-V6		
J352	6510007020	CNR TMP-J01X-V6		
J391	6510007020	CNR TMP-J01X-V6		
J501	6510007020	CNR TMP-J01X-V6		
J502	6510007020	CNR TMP-J01X-V6		
J503	6510007020	CNR TMP-J01X-V6		
J801	6510007020	CNR TMP-J01X-V6		
J808	6510007020	CNR TMP-J01X-V6		
J810	6510007020	CNR TMP-J01X-V6		
J1001	6510007020	CNR TMP-J01X-V6		
J1101	6510007020	CNR TMP-J01X-V6		
J1301	6510007020	CNR TMP-J01X-V6		
J1401	6910004741	CNR IMSA-9202B-1-03Z041-PT1		
J1402	6910004741	CNR IMSA-9202B-1-03Z041-PT1		
J1403	6910004741	CNR IMSA-9202B-1-03Z041-PT1		
J1404	6910004741	CNR IMSA-9202B-1-03Z041-PT1		
J1405	6910004741	CNR IMSA-9202B-1-03Z041-PT1		
J1406	6910004741	CNR IMSA-9202B-1-03Z041-PT1		
J1501	6510015541	S.CNR B4B-ZR-SM4-TF (LF) (SN)	T	168.2/21.6
J1651	6510007020	CNR TMP-J01X-V6		
J2001	6510024940	CNR HEC2305-016250		
J2002	6510023730	CNR LGY6502-0600C		
J2003	6510023730	CNR LGY6502-0600C		
J2004	6510007020	CNR TMP-J01X-V6		
J2006	6510019991	S.CNR 52808-2271 (2291)	T	168.3/166.7
J2007	6510018921	S.CNR B8B-PH-SM4-TB (LF) (SN)	T	168.2/204.1
F3	5210000041	FUS FGB 2A PBF (FGB0 125V)		
F2001	5220000230	HOL S-N5054 #01		
F2002	5220000230	HOL S-N5054 #01		
W1	8970024311	WIR 1.5D COAXIAL TUBE/C31		
W3	9030090170	WIR OPC-1805		
W1411	7120000480	S.JMP MJP-0.4-T	T	67.2/15
EP902	6910012350	S.BEA MMZ1608Y 102BT	B	60.6/134.1
EP903	6910012350	S.BEA MMZ1608Y 102BT	B	60.6/148.7
EP904	6910012350	S.BEA MMZ1608Y 102BT	B	104.9/141.8
EP1091	6910014690	S.BEA MPZ1608S221A-T	T	49/51.9
EP1092	6910014690	S.BEA MPZ1608S221A-T	T	49/53.2
EP1093	6910014690	S.BEA MPZ1608S221A-T	T	49/54.5
EP1201	6910012350	S.BEA MMZ1608Y 102BT	B	59/124.9
EP1202	6910012350	S.BEA MMZ1608Y 102BT	B	59/94.2
EP1210	6910012350	S.BEA MMZ1608Y 102BT	B	59/128
EP1229	6910014690	S.BEA MPZ1608S221A-T	B	28.2/69.2
EP1309	6910014690	S.BEA MPZ1608S221A-T	B	38.1/72.4
EP1504	6910014690	S.BEA MPZ1608S221A-T	B	132.3/22.7
EP1505	6910014690	S.BEA MPZ1608S221A-T	T	143.3/10.6
EP1654	6910012350	S.BEA MMZ1608Y 102BT	B	84.5/35
EP1801	6910012350	S.BEA MMZ1608Y 102BT	B	78.9/102.4
EP1802	6910012350	S.BEA MMZ1608Y 102BT	T	41.6/139.1
EP1803	6910014690	S.BEA MPZ1608S221A-T	B	75.8/102.4
EP1805	6910012350	S.BEA MMZ1608Y 102BT	B	104.9/143.4
EP1806	6910012350	S.BEA MMZ1608Y 102BT	B	78.9/105.6
EP1807	6910012350	S.BEA MMZ1608Y 102BT	B	75.8/105.6
EP1808	6910012350	S.BEA MMZ1608Y 102BT	B	154.1/14.5
EP1809	6910012350	S.BEA MMZ1608Y 102BT	B	104.9/145
EP1810	6910012350	S.BEA MMZ1608Y 102BT	T	23.1/132.8
EP1811	6910012350	S.BEA MMZ1608Y 102BT	T	23.1/135.6
EP1812	6910012350	S.BEA MMZ1608Y 102BT	B	104.9/146.6
EP1813	6910012350	S.BEA MMZ1608Y 102BT	T	55.2/131.7
EP1814	6910012350	S.BEA MMZ1608Y 102BT	T	55.2/130.4
EP1815	6910012350	S.BEA MMZ1608Y 102BT	T	6.8/124
EP1816	6910012350	S.BEA MMZ1608Y 102BT	T	55.2/133
EP1817	6910012350	S.BEA MMZ1608Y 102BT	B	15.4/140.2
EP1818	6910012350	S.BEA MMZ1608Y 102BT	B	104.9/138.6
EP1826	6910012350	S.BEA MMZ1608Y 102BT	B	104.9/140.2
EP1828	6910014690	S.BEA MPZ1608S221A-T	B	172.1/100
EP1830	6910012350	S.BEA MMZ1608Y 102BT	B	69.6/10.5
EP1831	6910012350	S.BEA MMZ1608Y 102BT	T	38.4/88.2
EP1832	6910012350	S.BEA MMZ1608Y 102BT	T	42.3/88.2
EP1833	6910012350	S.BEA MMZ1608Y 102BT	T	49/50.6
EP1834	6910012350	S.BEA MMZ1608Y 102BT	B	27.5/2.9
EP1835	6910012350	S.BEA MMZ1608Y 102BT	T	49/48
EP1836	6910012350	S.BEA MMZ1608Y 102BT	B	27.5/6.1
EP1837	6910012350	S.BEA MMZ1608Y 102BT	T	49/49.3
EP1838	6910012350	S.BEA MMZ1608Y 102BT	B	27.5/4.5
EP1901	6910014690	S.BEA MPZ1608S221A-T	T	136.8/137.7
EP2001	6910012350	S.BEA MMZ1608Y 102BT	B	166.5/245.8
EP2002	6910014690	S.BEA MPZ1608S221A-T	T	115.4/235.4
EP2003	6910012350	S.BEA MMZ1608Y 102BT	B	142.1/245.8
EP2004	6910012350	S.BEA MMZ1608Y 102BT	T	172.8/177.5
EP2005	6910012350	S.BEA MMZ1608Y 102BT	T	161.9/175.2
EP2006	6910012350	S.BEA MMZ1608Y 102BT	T	172.8/172.9
EP2007	6910012350	S.BEA MMZ1608Y 102BT	T	161.9/173.7
EP2008	6910012350	S.BEA MMZ1608Y 102BT	T	161.9/172.2
EP2009	6910012350	S.BEA MMZ1608Y 102BT	T	161.9/170.7
EP2010	6910012350	S.BEA MMZ1608Y 102BT	T	172.8/170.2
EP2011	6910012350	S.BEA MMZ1608Y 102BT	T	172.8/160.2
EP2012	6910012350	S.BEA MMZ1608Y 102BT	T	172.8/158.2
EP2013	6910014690	S.BEA MPZ1608S221A-T	T	163.5/208
EP2014	6910014690	S.BEA MPZ1608S221A-T	T	163.5/205.4
EP2015	6910014690	S.BEA MPZ1608S221A-T	T	163.5/202.8
EP2016	6910014690	S.BEA MPZ1608S221A-T	T	163.5/200.2
EP2017	6910014690	S.BEA MPZ1608S221A-T	T	163.5/197.6
EP2018	6910014690	S.BEA MPZ1608S221A-T	T	163.5/210.6

[MCF-W BOARD]

REF NO.	ORDER NO.	DESCRIPTION	M.	H/V LOCATION
F11401	2030000281	S.MLH FL-364A (64.455 MHz)	T	19.9/6.5
L1401	6150004280	COL LS-484B (C-14927)		
L1402	6150004280	COL LS-484B (C-14927)		
C1401	4030006900	S.CER C1608 JB 1H 103K-T	T	4.3/6.5
C1402	4030007030	S.CER C1608 CH 1H 150J-T	T	14.6/6.5
C1404	4030006990	S.CER C1608 CH 1H 080D-T	T	18.5/2.1
C1406	4030007030	S.CER C1608 CH 1H 150J-T	T	25.3/6.5
C1408	4030006900	S.CER C1608 JB 1H 103K-T	T	35.6/6.5

[MCF-M BOARD]

REF NO.	ORDER NO.	DESCRIPTION	M.	H/V LOCATION
F11401	2030000331	S.MLH FL-358A (64.455 MHz)	T	19.9/6.5
L1401	6150004280	COL LS-484B (C-14927)		
L1402	6150004280	COL LS-484B (C-14927)		
C1401	4030006900	S.CER C1608 JB 1H 103K-T	T	4.3/6.5
C1402	4030009920	S.CER C1608 CH 1H 050B-T	T	14.6/6.5
C1403	4030007020	S.CER C1608 CH 1H 120J-T	T	13.3/6.5
C1404	4030006990	S.CER C1608 CH 1H 080D-T	T	18.5/2.1
C1405	4030009920	S.CER C1608 CH 1H 050B-T	T	21.3/2.1
C1406	4030007020	S.CER C1608 CH 1H 120J-T	T	25.3/6.5
C1407	4030009920	S.CER C1608 CH 1H 050B-T	T	26.6/6.5
C1408	4030006900	S.CER C1608 JB 1H 103K-T	T	35.6/6.5

[MCF-N BOARD]

REF NO.	ORDER NO.	DESCRIPTION	M.	H/V LOCATION
F11401	2030000510	S.MLH FL-396 (64.455 MHz)	T	19.9/6.5
L1401	6150004280	COL LS-484B (C-14927)		
L1402	6150004280	COL LS-484B (C-14927)		
C1401	4030006900	S.CER C1608 JB 1H 103K-T	T	4.3/6.5
C1402	4030007020	S.CER C1608 CH 1H 120J-T	T	14.6/6.5
C1403	4030007020	S.CER C1608 CH 1H 120J-T	T	13.3/6.5
C1404	4030007030	S.CER C1608 CH 1H 150J-T	T	18.5/2.1
C1405	4030007030	S.CER C1608 CH 1H 150J-T	T	21.3/2.1
C1406	4030007020	S.CER C1608 CH 1H 120J-T	T	25.3/6.5
C1407	4030007020	S.CER C1608 CH 1H 120J-T	T	26.6/6.5
C1408	4030006900	S.CER C1608 JB 1H 103K-T	T	35.6/6.5

M.=Mounted side (T: Mounted on the Top side B: Mounted on the Bottom side)
S.=Surface mount

[MAIN UNIT]

REF NO.	ORDER NO.	DESCRIPTION	M.	H/V LOCATION
IC171	1110006300	S.IC NJM2172V-TE1	T	48.8/40.6
IC191	1110006300	S.IC NJM2172V-TE1	B	60.8/75.6
IC201	1130005641	S.IC TC4W53F (TE12L,F)	T	47/33.2
IC211	1130005641	S.IC TC4W53F (TE12L,F)	B	47/26.4
IC221	1110001901	S.IC uPC4570G2-E1-A	T	41.9/27.2
IC231	1110006300	S.IC NJM2172V-TE1	T	39.7/75.7
IC241	1110001901	S.IC uPC4570G2-E1-A	B	41.4/65
IC281	1110006141	S.IC LA4485-E	T	
IC311	1110006300	S.IC NJM2172V-TE1	T	24.6/29.1
IC331	1110001901	S.IC uPC4570G2-E1-A	B	24.5/22.6
IC361	1120002830	S.IC NJM2125F-TE1-#FZZB	T	33.6/18.4
IC701	1130011990	S.IC SN74LVC1G08DCKR	T	131.8/95.3
IC721	1190001930	S.IC PS7122AL-1A-E3	B	81.5/89.5
IC741	1180001541	S.IC TA78L08F (TE12L,F)	B	27.2/81.9
IC1001	1140014340	S.IC TMS320C672BZDH275	T	131.5/32.1
IC1101	1130014251	S.IC AT29LV040A-15TU [FRA], [ITR], [ESP], [KOR] only	T	133.5/12.2
IC1111	1130010461	S.IC TC7SH08F (TE85L,JF)	T	142.6/32.4
IC1112	1110006411	S.IC R3111N111A-TR-F	T	147.9/32
IC1131	1130008361	S.IC TC7SH04FU (TE85L,JF)	T	134.3/43.2
IC1132	1130008041	S.IC TC7SH04FU (TE85L,JF)	T	125.3/43.2
IC1201	1130009981	S.IC TC7W53FK (TE85L,F)	T	84.7/18.2
IC1211	1110006100	S.IC NJM5534MD-TE1	T	89.3/7.6
IC1221	1110006100	S.IC NJM5534MD-TE1	T	91.3/16.9
IC1231	1110006100	S.IC NJM5534MD-TE1	T	102.2/7.6
IC1251	1110006111	S.IC AK5394AVSP/P	T	107.4/20.7
IC1311	1110006100	S.IC NJM5534MD-TE1	T	92/25.8
IC1321	1110006100	S.IC NJM5534MD-TE1	T	109.2/33.9
IC1331	1110006100	S.IC NJM5534MD-TE1	T	97.3/37.7
IC1351	1110001901	S.IC uPC4570G2-E1-A	T	77/17.4
IC1361	1180001771	S.IC TA79L05F (TE12L,F)	B	73.5/7.1
IC1401	1110007190	S.IC AK5383VFP-E2/P	T	76.5/29.4
IC1431	1130006891	S.IC TC7S04FU (TE85R,F)	T	122.5/45
IC1441	1130012160	S.IC SN74LVC1GU04DCKR	T	119.4/46.3
IC1451	1110005610	S.IC NJM2058V-TE1	T	66/26.9
IC1501	1190002090	S.IC AD1854JRSZRL	T	108.4/42.5
IC1511	1110006100	S.IC NJM5534MD-TE1	T	96.5/40.4
IC1521	1110006100	S.IC NJM5534MD-TE1	T	96.5/47.2
IC1531	1110006100	S.IC NJM5534MD-TE1	T	87.3/34.7
IC1571	1110006100	S.IC NJM5534MD-TE1	T	106/55.3
IC1601	1130012580	S.IC AK4355-VF-E2	T	84.7/43.8
IC1611	1110005420	S.IC BA15532F-E2	B	81.2/44
IC1651	1180003110	S.REG TLV1117CDCYR	B	156.2/7.7
IC1801	1130011530	S.IC CD74HC4094M96	B	173.1/56.9
IC1841	1130011530	S.IC CD74HC4094M96	B	173.1/68.7
IC1921	1130012000	S.IC M62352AGP C60Q	T	81.9/75.6
IC1931	1110005610	S.IC NJM2058V-TE1	T	96.9/77.7
IC2001	1110005610	S.IC NJM2058V-TE1	T	115.5/78.5
IC2051	1110005610	S.IC NJM2058V-TE1	T	134.4/86.2
Q11	1530002060	S.TR 2SC4081 T106 R	B	35.9/73.4
Q11	1530002060	S.TR 2SC4081 T106 R	B	50.8/74.4
Q21	1540000441	S.TR 2SD1619T-TD-E	B	39.1/82.1
Q22	1590001330	S.TR DTA114EUA T106	B	43.6/86.1
Q31	1530002060	S.TR 2SC4081 T106 R	B	31.9/77.9
Q201	1590000680	S.TR DTC114EUA T106	B	39.5/36.9
Q211	1590000680	S.TR DTC114EUA T106	B	40.1/30.2
Q261	1530002060	S.TR 2SC4081 T106 R	B	14.8/75.9
Q281	1590001050	S.TR DTC114TUA T106	B	4.4/57.6
Q282	1540000471	S.TR 2SD1801S-TL-E	B	18.4/49.9
Q291	1560001131	S.FET CPH3403-TL-E	B	20.1/35.5
Q301	1560001131	S.FET CPH3403-TL-E	B	28.9/28.2
Q351	1550000010	S.FET 2SC364-Q (TX)	B	23.2/13.6
Q721	1590001050	S.TR DTC114TUA T106	B	97.2/92.9
Q722	1590001050	S.TR DTC114TUA T106	B	82/80.8
Q731	1590001050	S.TR DTC114TUA T106	B	47/79.7
Q761	1530002060	S.TR 2SC4081 T106 R	T	50.4/78.2
Q810	1530002060	S.TR 2SC4081 T106 R	B	40.8/56.1
Q1201	1590000680	S.TR DTC114EUA T106	T	117.3/35.5
Q2001	1510000510	S.TR 2SA1576A T106R	T	106.9/72.4
Q2002	1560001260	S.FET 2SK3018 T106	B	116.5/76.1
Q2003	1590002430	S.FET DTA144EE TL	B	119.3/72.9
Q2051	1510000510	S.TR 2SA1576A T106R	B	145/83.1
Q2052	1590001050	S.FET DTC114TUA T106	B	141.9/83.1
Q2055	1530003091	S.TR 2SC4213-B (TE85R,F)	T	137.3/70.7
Q2056	1590002430	S.FET DTA144EE TL	T	136.4/73
Q2057	1590002150	S.FET DTC144TE TL	T	134.4/73
Q2058	1560001260	S.FET 2SK3018 T106	T	140.6/77.1
Q2059	1530002060	S.TR 2SC4081 T106 R	T	143.5/77.7
Q2060	1590002710	S.TR UMH11NTN	T	136/77.1
D1	1750000550	S.DIO 1SS355 TE-17	B	36.8/78.5
D11	1750000550	S.DIO 1SS355 TE-17	B	50.7/80.1
D161	1730002280	S.ZEN MA8091-M (TX)	B	46/58.4
D261	1750000550	S.DIO 1SS355 TE-17	B	14.9/79.8
D361	1750000550	S.DIO 1SS355 TE-17	B	23.4/11.4
D721	1750000550	S.DIO 1SS355 TE-17	B	92.5/90.4
D1351	1730002320	S.ZEN MA8051-M (TX)	B	71.7/16.3
D2001	1750000550	S.DIO 1SS355 TE-17	T	109.1/72.9
D2002	1750000550	S.DIO 1SS355 TE-17	T	107.3/81.1
D2003	1730002340	S.ZEN MA8047-M (TX)	B	113.2/75.2
D2004	1750000550	S.DIO 1SS355 TE-17	T	105.9/74.8
D2005	1750000550	S.DIO 1SS355 TE-17	T	105.9/78.6
D2041	1750000550	S.DIO 1SS355 TE-17	T	142.8/82.6
D2051	1750000550	S.DIO 1SS355 TE-17	T	136.9/82.5
D2052	1790001240	S.DIO MA25728-(TX)	B	144.2/77.5
D2053	1790001260	S.DIO MA25077-(TX)	T	140.7/75.2
D2054	1790001250	S.DIO MA25111-(TX)	B	147/78.5
D2091	1750000550	S.DIO 1SS355 TE-17	T	128.5/90.6
FI1121	2040000790	S.LC EXCCE1103U	T	119.7/39.2

[MAIN UNIT]

REF NO.	ORDER NO.	DESCRIPTION	M.	H/V LOCATION
X1141	6050011660	S.XTL CR-754 (30.000 MHz)	T	132.7/47.5
L171	6200003261	S.COL NLV32T-101J	B	45.9/41.2
L191	6200003261	S.COL NLV32T-101J	B	60.4/77.2
L231	6200003261	S.COL NLV32T-101J	B	43.6/76
L311	6200003261	S.COL NLV32T-101J	B	36.1/26.1
L701	6200003191	S.COL NLV32T-470J	B	141.5/93.6
L702	6200003191	S.COL NLV32T-470J	B	138.1/93.6
L711	6200003261	S.COL NLV32T-101J	B	163.7/81.4
L721	6200003261	S.COL NLV32T-101J	B	55.7/80.6
L731	6200003261	S.COL NLV32T-101J	B	47.9/85.3
L732	6200003261	S.COL NLV32T-101J	B	51.9/85.3
L733	6200003261	S.COL NLV32T-101J	B	55.7/85.3
L734	6200003261	S.COL NLV32T-101J	B	51.4/95.2
L735	6200003261	S.COL NLV32T-101J	B	60.1/87.7
L741	6200003261	S.COL NLV32T-101J	B	31.6/87.5
L742	6200003261	S.COL NLV32T-101J	B	34.2/90.8
L1001	6180003501	S.COL SLF6028T-100M1R3-PF	T	145.9/24.7
R1	7030003520	S.RES ERJ3GEYJ 472 V (4.7 k)	B	40.1/78.6
R2	7030003620	S.RES ERJ3GEYJ 333 V (33 k)	B	36.1/75.7
R3	7030003580	S.RES ERJ3GEYJ 153 V (15 k)	B	38.4/73.3
R4	7030003520	S.RES ERJ3GEYJ 472 V (4.7 k)	B	32.6/73.4
R11	7030003520	S.RES ERJ3GEYJ 472 V (4.7 k)	B	51/78.2
R12	7030003620	S.RES ERJ3GEYJ 333 V (33 k)	B	51/76.7
R13	7030003580	S.RES ERJ3GEYJ 153 V (15 k)	B	53.2/74.3
R14	7030003520	S.RES ERJ3GEYJ 472 V (4.7 k)	B	47.7/74.2
R21	7030003560	S.RES ERJ3GEYJ 103 V (10 k)	B	43.6/82
R22	7030009891	S.RES ERA3YED 151V (150)	B	43.7/83.8
R31	7030003640	S.RES ERJ3GEYJ 473 V (47 k)	B	31.7/75.6
R32	7030003560	S.RES ERJ3GEYJ 103 V (10 k)	B	31.5/84.3
R161	7030003360	S.RES ERJ3GEYJ 221 V (220)	B	38.6/60.3
R162	7030003440	S.RES ERJ3GEYJ 102 V (1 k)	B	41.8/60.3
R163	7030003420	S.RES ERJ3GEYJ 681 V (680)	B	40.9/53.9
R171	7030003860	S.RES ERJ3GE JPW V	T	37/61.5
R172	7030003520	S.RES ERJ3GEYJ 472 V (4.7 k)	T	47.6/51.7
R173	7030003860	S.RES ERJ3GE JPW V	B	52.7/41.9
R174	7030003560	S.RES ERJ3GEYJ 103 V (10 k)	B	50/43.7
R175	7030003720	S.RES ERJ3GEYJ 224 V (220 k)	B	49.8/45.9
R176	7030003560	S.RES ERJ3GEYJ 103 V (10 k)	T	50.9/46.6
R177	7030003550	S.RES ERJ3GEYJ 822 V (8.2 k)	T	49.6/46.6
R178	7030003640	S.RES ERJ3GEYJ 473 V (47 k)	T	47/46.6
R179	7030003620	S.RES ERJ3GEYJ 333 V (33 k)	T	48.3/46.6
R180	7030003560	S.RES ERJ3GEYJ 103 V (10 k)	T	52.2/42.3
R181	7030003560	S.RES ERJ3GEYJ 103 V (10 k)	T	52.2/39.7
R182	7030003440	S.RES ERJ3GEYJ 102 V (1 k)	T	57.7/33
R192	7030003560	S.RES ERJ3GEYJ 103 V (10 k)	T	60.8/70.4
R193	7030003520	S.RES ERJ3GEYJ 472 V (4.7 k)	B	61.7/74.4
R194	7030003440	S.RES ERJ3GEYJ 102 V (1 k)	T	64.2/73.7
R195	7030003580	S.RES ERJ3GEYJ 153 V (15 k)	T	55.6/66.5
R196	7030003600	S.RES ERJ3GEYJ 223 V (22 k)	B	61.2/80
R198	7030003620	S.RES ERJ3GEYJ 333 V (33 k)	B	61.2/81.8
R201	7030003320	S.RES ERJ3GEYJ 101 V (100)	B	48.8/40.6
R202	7030003320	S.RES ERJ3GEYJ 101 V (100)	B	42.7/36.6
R203	7030003440	S.RES ERJ3GEYJ 102 V (1 k)	B	43/32.9
R208	7030003620	S.RES ERJ3GEYJ 473 V (47 k)	B	41.2/34.9
R211	7030003560	S.RES ERJ3GEYJ 103 V (10 k)	B	51.6/27.6
R212	7030003560	S.RES ERJ3GEYJ 103 V (10 k)	B	51.6/25.8
R213	7030003580	S.RES ERJ3GEYJ 153 V (15 k)	T	39.2/30.7
R214	7030003320	S.RES ERJ3GEYJ 101 V (100)	B	41.2/32.9
R215	7030003520	S.RES ERJ3GEYJ 472 V (4.7 k)	B	43/26.1
R216	7030003620	S.RES ERJ3GEYJ 333 V (33 k)	B	41.2/26.1
R217	7030003860	S.RES ERJ3GE JPW V	B	44.4/16.3
R218	7030003640	S.RES ERJ3GEYJ 473 V (47 k)	B	40/28.2
R221	7030003680	S.RES ERJ3GEYJ 104 V (100 k)	T	49/25.8
R222	7030003560	S.RES ERJ3GEYJ 103 V (10 k)	T	50.3/25.8
R223	7030003440	S.RES ERJ3GEYJ 102 V (1 k)	T	46.5/28.4
R224	7030003320	S.RES ERJ3GEYJ 101 V (100)	T	51.6/28.4
R225	7030003320	S.RES ERJ3GEYJ 101 V (100)	T	48.4/23.9
R226	7030003320	S.RES ERJ3GEYJ 101 V (100)	T	38.6/23.6
R231	7030003440	S.RES ERJ3GEYJ 102 V (1 k)	T	52.5/75.5
R232	7030003620	S.RES ERJ3GEYJ 333 V (33 k)	T	45.5/77.3
R233	7030003560	S.RES ERJ3GEYJ 103 V (10 k)	T	45.7/76
R234	7030003620	S.RES ERJ3GEYJ 333 V (33 k)	T	42.5/80
R235	7030003560	S.RES ERJ3GEYJ 103 V (10 k)	B	39.9/76.9
R236	7030003560	S.RES ERJ3GEYJ 103 V (10 k)	T	35.1/76.3
R241	7030003440	S.RES ERJ3GEYJ 102 V (1 k)	B	33.2/67.5
R242	7030003660	S.RES ERJ3GEYJ 683 V (68 k)	B	34.6/64.7
R243	7030003560	S.RES ERJ3GEYJ 103 V (10 k)	B	32.2/63.9
R244	7030003560	S.RES ERJ3GEYJ 103 V (10 k)	B	35.6/62.3
R245	7030003320	S.RES ERJ3GEYJ 101 V (100)	T	40.7/66
R246	7030003320	S.RES ERJ3GEYJ 101 V (100)	T	46.2/70.7
R251	7030003680	S.RES ERJ3GEYJ 104 V (100 k)	B	48/65.9
R252	7030003680	S.RES ERJ3GEYJ 104 V (100 k)	B	46.4/65.9
R253	7030003470	S.RES ERJ3GEYJ 471 V (470)	B	47.1/68.2
R254	7030003440	S.RES ERJ3GEYJ 102 V (1 k)	B	11.2/93
R255	7030003480	S.RES ERJ3GEYJ 222 V (2.2 k)	B	11.2/90.1
R256	7030003680	S.RES ERJ3GEYJ 104 V (100 k)	B	47.1/63.5
R257	7030003570	S.RES ERJ3GEYJ 123 V (12 k)	B	45.5/61.7
R261	703000			

[MAIN UNIT]

REF NO.	ORDER NO.	DESCRIPTION	M.	H/V LOCATION
R311	7030003520	S.RES ERJ3GEYJ 472 V (4.7 k)	B	28.7/33.4
R312	7030003440	S.RES ERJ3GEYJ 102 V (1 k)	B	32/32.7
R313	7030003560	S.RES ERJ3GEYJ 103 V (10 k)	B	26.2/26.2
R314	7030003560	S.RES ERJ3GEYJ 103 V (10 k)	B	23.1/26.2
R315	7030003520	S.RES ERJ3GEYJ 472 V (4.7 k)	B	14/35
R316	7030003480	S.RES ERJ3GEYJ 222 V (2.2 k)	B	31.3/36.9
R317	7030003470	S.RES ERJ3GEYJ 182 V (1.8 k)	B	35.3/35.5
R318	7030003470	S.RES ERJ3GEYJ 182 V (1.8 k)	B	35.2/37.2
R319	7030003470	S.RES ERJ3GEYJ 182 V (1.8 k)	B	34.6/33.2
R320	7030003470	S.RES ERJ3GEYJ 182 V (1.8 k)	B	35.9/33.2
R321	7030003480	S.RES ERJ3GEYJ 222 V (2.2 k)	B	36/31.2
R331	7030003580	S.RES ERJ3GEYJ 153 V (15 k)	B	30.4/22.1
R335	7030003640	S.RES ERJ3GEYJ 473 V (47 k)	B	33.5/22.9
R336	7030003440	S.RES ERJ3GEYJ 102 V (1 k)	B	20.6/19.3
R337	7030003560	S.RES ERJ3GEYJ 103 V (10 k)	B	17.9/21.4
R338	7030003440	S.RES ERJ3GEYJ 102 V (1 k)	B	16.3/21.4
R339	7030003560	S.RES ERJ3GEYJ 103 V (10 k)	B	22.5/16.6
R340	7030003320	S.RES ERJ3GEYJ 101 V (100)	B	26.7/18.4
R341	7030003320	S.RES ERJ3GEYJ 101 V (100)	B	19.5/25.3
R351	7030003560	S.RES ERJ3GEYJ 103 V (10 k)	B	20.7/16.6
R353	7030003440	S.RES ERJ3GEYJ 102 V (1 k)	B	24.3/16.6
R354	7030003500	S.RES ERJ3GEYJ 332 V (3.3 k)	B	26.6/15.8
R361	7030003600	S.RES ERJ3GEYJ 223 V (22 k)	B	20.7/12.9
R362	7030003700	S.RES ERJ3GEYJ 154 V (150 k)	B	23.4/9.7
R363	7030003460	S.RES ERJ3GEYJ 152 V (1.5 k)	B	28.5/11.4
R364	7030003320	S.RES ERJ3GEYJ 101 V (100)	B	35.9/19.1
R365	7030003640	S.RES ERJ3GEYJ 473 V (47 k)	B	38.9/19.7
R366	7030003560	S.RES ERJ3GEYJ 103 V (10 k)	B	32.5/11.4
R401	7030003320	S.RES ERJ3GEYJ 101 V (100)	T	147.3/7.7
R402	7030003320	S.RES ERJ3GEYJ 101 V (100)	T	147.3/12.6
R403	7030003320	S.RES ERJ3GEYJ 101 V (100)	B	65.1/44.3
R404	7030003320	S.RES ERJ3GEYJ 101 V (100)	T	147.3/11.3
R405	7030003320	S.RES ERJ3GEYJ 101 V (100)	B	147.6/35.3
R406	7030003320	S.RES ERJ3GEYJ 101 V (100)	B	65.1/39.5
R407	7030003320	S.RES ERJ3GEYJ 101 V (100)	B	65.1/42.7
R408	7030003320	S.RES ERJ3GEYJ 101 V (100)	B	65.1/33.1
R409	7030003320	S.RES ERJ3GEYJ 101 V (100)	B	65.1/41.1
R410	7030003320	S.RES ERJ3GEYJ 101 V (100)	B	65.1/34.7
R411	7030003320	S.RES ERJ3GEYJ 101 V (100)	B	65.1/37.9
R412	7030003320	S.RES ERJ3GEYJ 101 V (100)	B	65.1/36.3
R413	7030003320	S.RES ERJ3GEYJ 101 V (100)	B	122.6/50.8
R414	7030003320	S.RES ERJ3GEYJ 101 V (100)	B	147.6/36.9
R415	7030003320	S.RES ERJ3GEYJ 101 V (100)	T	147.3/8.9
R416	7030003320	S.RES ERJ3GEYJ 101 V (100)	B	144.5/36.3
R417	7030003320	S.RES ERJ3GEYJ 101 V (100)	T	147.3/10.1
R418	7030003320	S.RES ERJ3GEYJ 101 V (100)	T	147.3/16.5
R419	7030003320	S.RES ERJ3GEYJ 101 V (100)	T	147.3/13.9
R420	7030003320	S.RES ERJ3GEYJ 101 V (100)	T	147.3/15.2
R421	7030003320	S.RES ERJ3GEYJ 101 V (100)	B	147.6/42.9
R422	7030003320	S.RES ERJ3GEYJ 101 V (100)	B	147.6/40.9
R424	7030003320	S.RES ERJ3GEYJ 101 V (100)	B	144.5/39.8
R425	7030003320	S.RES ERJ3GEYJ 101 V (100)	B	147.6/38.9
R426	7030003320	S.RES ERJ3GEYJ 101 V (100)	T	147.3/5.1
R427	7030003320	S.RES ERJ3GEYJ 101 V (100)	T	147.3/6.4
R428	7030003320	S.RES ERJ3GEYJ 101 V (100)	B	132.8/20.9
R473	7030003860	S.RES ERJ3GE JPW V	T	55.6/32.2
R560	7030003680	S.RES ERJ3GEYJ 104 V (100 k)	B	10/32.8
R721	7310003820	TRI EVN-D2AA03 B14		
R722	7030003560	S.RES ERJ3GEYJ 103 V (10 k)	B	112/100.7
R723	7540000270	S.ASB ERZVF2M201	B	69.5/97.9
R724	7030003200	S.RES ERJ3GEYJ 100 V (10)	B	91.7/87.6
R725	7030003390	S.RES ERJ3GEYJ 391 V (390)	B	88/91.3
R741	7030003550	S.RES ERJ3GEYJ 822 V (8.2 k)	B	47.1/81.9
R745	7030006230	S.RES ERJ12YJ151U (150)	B	28.4/75
R761	7030003320	S.RES ERJ3GEYJ 101 V (100)	T	48.4/77.7
R762	7030003580	S.RES ERJ3GEYJ 153 V (15 k)	T	50.6/76.3
R763	7030003390	S.RES ERJ3GEYJ 391 V (390)	T	50.7/80.2
R764	7030003580	S.RES ERJ3GEYJ 153 V (15 k)	T	52.5/78.2
R801	7030003410	S.RES ERJ3GEYJ 561 V (560)	B	125.8/52.7
R802	7030007860	S.RES ERJ3GEYJ 8R2V (8.2)	B	123.9/52.3
R803	7030003410	S.RES ERJ3GEYJ 561 V (560)	B	125.8/50.5
R841	7030003860	S.RES ERJ3GE JPW V	B	21.3/72.2
R890	7030003320	S.RES ERJ3GEYJ 101 V (100)	T	157.7/17.1
R891	7030003320	S.RES ERJ3GEYJ 101 V (100)	T	166/18
R892	7030003320	S.RES ERJ3GEYJ 101 V (100)	T	157.7/15
R893	7030003320	S.RES ERJ3GEYJ 101 V (100)	T	166.2/16
R901	7030003320	S.RES ERJ3GEYJ 101 V (100)	B	117.1/95.1
R902	7030003320	S.RES ERJ3GEYJ 101 V (100)	B	115.5/95.1
R911	7030003320	S.RES ERJ3GEYJ 101 V (100)	T	157.7/19
R912	7030003320	S.RES ERJ3GEYJ 101 V (100)	T	166/20
R913	7030003320	S.RES ERJ3GEYJ 101 V (100)	T	157.7/21
R914	7030003320	S.RES ERJ3GEYJ 101 V (100)	T	166/22
R915	7030003320	S.RES ERJ3GEYJ 101 V (100)	T	157.7/23
R916	7030003320	S.RES ERJ3GEYJ 101 V (100)	T	166/24
R917	7030003320	S.RES ERJ3GEYJ 101 V (100)	T	157.7/25
R918	7030003320	S.RES ERJ3GEYJ 101 V (100)	T	166/26
R919	7030003320	S.RES ERJ3GEYJ 101 V (100)	T	157.7/27
R920	7030003320	S.RES ERJ3GEYJ 101 V (100)	T	157.7/31
R921	7030003320	S.RES ERJ3GEYJ 101 V (100)	T	166.1/30
R922	7030003320	S.RES ERJ3GEYJ 101 V (100)	T	166/32
R923	7030003320	S.RES ERJ3GEYJ 101 V (100)	T	157.7/33
R924	7030003320	S.RES ERJ3GEYJ 101 V (100)	T	166/34
R925	7030003320	S.RES ERJ3GEYJ 101 V (100)	T	157.7/35
R926	7030003320	S.RES ERJ3GEYJ 101 V (100)	T	166/36
R927	7030003320	S.RES ERJ3GEYJ 101 V (100)	T	157.7/37
R945	7030003860	S.RES ERJ3GE JPW V	B	10/27
R946	7030003860	S.RES ERJ3GE JPW V	T	4.8/26
R947	7030003860	S.RES ERJ3GE JPW V	B	10/25
R948	7030003860	S.RES ERJ3GE JPW V	T	4.8/24
R949	7030003860	S.RES ERJ3GE JPW V	B	10/23
R950	7030003860	S.RES ERJ3GE JPW V	T	4.8/22
R951	7030003320	S.RES ERJ3GEYJ 101 V (100)	T	4.8/20
R952	7030003320	S.RES ERJ3GEYJ 101 V (100)	B	10/20.9
R953	7030003320	S.RES ERJ3GEYJ 101 V (100)	T	4.8/18

[MAIN UNIT]

REF NO.	ORDER NO.	DESCRIPTION	M.	H/V LOCATION
R956	7030003860	S.RES ERJ3GE JPW V	B	10/17.5
R961	7030003320	S.RES ERJ3GEYJ 101 V (100)	T	172.1/13
R962	7030003320	S.RES ERJ3GEYJ 101 V (100)	T	180.4/14
R963	7030003320	S.RES ERJ3GEYJ 101 V (100)	T	172.1/15
R964	7030003320	S.RES ERJ3GEYJ 101 V (100)	T	180.4/16
R965	7030003320	S.RES ERJ3GEYJ 101 V (100)	T	172.1/17
R966	7030003860	S.RES ERJ3GE JPW V	T	180.4/18
R967	7030003860	S.RES ERJ3GE JPW V	T	172.1/19
R968	7030003860	S.RES ERJ3GE JPW V	T	180.4/20
R969	7030003320	S.RES ERJ3GEYJ 101 V (100)	T	172.1/21
R970	7030003320	S.RES ERJ3GEYJ 101 V (100)	T	180.4/22
R971	7030003320	S.RES ERJ3GEYJ 101 V (100)	T	172.1/23
R972	7030003320	S.RES ERJ3GEYJ 101 V (100)	T	180.4/24
R973	7030003320	S.RES ERJ3GEYJ 101 V (100)	T	172.1/25
R974	7030003320	S.RES ERJ3GEYJ 101 V (100)	T	180.4/26
R975	7030003320	S.RES ERJ3GEYJ 101 V (100)	T	172.1/27
R976	7030003320	S.RES ERJ3GEYJ 101 V (100)	T	180.4/28
R977	7030003320	S.RES ERJ3GEYJ 101 V (100)	T	172.1/29
R978	7030003320	S.RES ERJ3GEYJ 101 V (100)	T	180.4/30
R979	7030003320	S.RES ERJ3GEYJ 101 V (100)	T	172.1/31
R981	7030003320	S.RES ERJ3GEYJ 101 V (100)	T	172.1/33
R982	7030003320	S.RES ERJ3GEYJ 101 V (100)	T	180.4/34
R983	7030003320	S.RES ERJ3GEYJ 101 V (100)	T	172.1/35
R984	7030003860	S.RES ERJ3GE JPW V	T	180.4/36
R985	7030003860	S.RES ERJ3GE JPW V	T	172.1/37
R986	7030003860	S.RES ERJ3GE JPW V	T	180.4/38
R992	7030003320	S.RES ERJ3GEYJ 101 V (100)	T	157.7/39
R1001	7030003640	S.RES ERJ3GEYJ 473 V (47 k)	B	140.6/23.8
R1002	7030003640	S.RES ERJ3GEYJ 473 V (47 k)	B	136.4/21.6
R1003	7030003640	S.RES ERJ3GEYJ 473 V (47 k)	B	142.6/25.2
R1004	7030003640	S.RES ERJ3GEYJ 473 V (47 k)	B	141.6/32.6
R1005	7030003640	S.RES ERJ3GEYJ 473 V (47 k)	B	143.8/37.9
R1006	7030003640	S.RES ERJ3GEYJ 473 V (47 k)	B	147.5/30.5
R1007	7030003640	S.RES ERJ3GEYJ 473 V (47 k)	B	147.3/26.2
R1008	7030003640	S.RES ERJ3GEYJ 473 V (47 k)	B	147.3/24.6
R1009	7030003640	S.RES ERJ3GEYJ 473 V (47 k)	B	147.5/32.3
R1010	7030008240	S.RES ERJ12Y0R00U	T	117.4/55.1
R1011	7030003860	S.RES ERJ3GE JPW V	T	114.2/57
R1012	7030008240	S.RES ERJ12Y0R00U	T	123.2/60.3
R1013	7030008240	S.RES ERJ12Y0R00U	B	150/18.4
R1014	7030003640	S.RES ERJ3GEYJ 473 V (47 k)	B	120.5/24.3
R1015	7030003640	S.RES ERJ3GEYJ 473 V (47 k)	B	120.5/26.9
R1016	7030003640	S.RES ERJ3GEYJ 473 V (47 k)	B	120.5/25.6
R1017	7030003640	S.RES ERJ3GEYJ 473 V (47 k)	B	120.5/29.5
R1018	7030003640	S.RES ERJ3GEYJ 473 V (47 k)	B	117.9/30.2
R1019	7030003640	S.RES ERJ3GEYJ 473 V (47 k)	B	120.5/31.5
R1020	7030003640	S.RES ERJ3GEYJ 473 V (47 k)	B	117.9/32.4
R1021	7030003640	S.RES ERJ3GEYJ 473 V (47 k)	B	120.5/33
R1111	7030003640	S.RES ERJ3GEYJ 473 V (47 k)	T	145.4/33.2
R1112	7030003640	S.RES ERJ3GEYJ 473 V (47 k)	B	143.4/32.6
R1113	7030003640	S.RES ERJ3GEYJ 473 V (47 k)	T	147.4/35.4
R1131	7030003320	S.RES ERJ3GEYJ 101 V (100)	T	137.5/43.2
R1132	7030003320	S.RES ERJ3GEYJ 101 V (100)	T	128.5/43.2
R1141	7030003800	S.RES ERJ3GEYJ 105 V (1 M)	T	130.4/44
R1151	7030004040	S.RES ERJ3GEYJ 4R7 V (4.7)	B	133.5/42.3
R1152	7030003520	S.RES ERJ3GEYJ 472 V (4.7 k)	B	127.3/41.5
R1153	7030003520	S.RES ERJ3GEYJ 472 V (4.7 k)	B	126/41.5
R1201	7030003800	S.RES ERJ3GEYJ 332 V (3.3 k)	B	97.5/11.9
R1202	7030003480	S.RES ERJ3GEYJ 222 V (2.2 k)	B	95.3/9.2
R1203	7030003640	S.RES ERJ3GEYJ 473 V (47 k)	T	86.6/18.5
R1204	7030003860	S.RES ERJ3GE JPW V	T	82/14.2
R1211	7030009591	S.RES ERA3YED 472V (4.7 k)	T	83.9/4.8
R1212	7030009591	S.RES ERA3YED 472V (4.7 k)	T	85.9/4.8
R1213	7030003860	S.RES ERJ3GE JPW V	T	85.9/7.5
R1214	7030003320	S.RES ERJ3GEYJ 101 V (100)	T	83.1/11
R1215	7030003320	S.RES ERJ3GEYJ 101 V (100)	T	92.7/5.6
R1221	7030003320	S.RES ERJ3GEYJ 101 V (100)	T	87.9/17.4
R1222	7030003320	S.RES ERJ3GEYJ 101 V (100)	T	94.7/14.4
R1223	7030006601	S.RES ERA3YED 272V (2.7 k)	T	87.9/14.3
R1224	7030010390	S.RES ERA3YED 821V (820)	T	96/18.1
R1225	7030009691	S.RES ERA3YED 101V (100)	T	95.4/20
R1231	7030003320	S.RES ERJ3GEYJ 101 V (100)	T	98.4/7.9
R1232	7030003320	S.RES ERJ3GEYJ 101 V (100)	T	106.3/5.4
R1233	7030006601	S.RES ERA3YED 272V (2.7 k)	T	98.2/6.1
R1234	7030010390	S.RES ERA3YED 821V (820)	T	107.2/9.9
R1235	7030009691	S.RES ERA3YED 101V (100)	T	105.6/12
R1241	7030009591	S.RES ERA3YED 472V (4.7 k)	T	108.5/9.2
R1242	7030009591	S.RES		

[MAIN UNIT]

REF NO.	ORDER NO.	DESCRIPTION	M.	H/V LOCATION
R1351	7030006521	S.RES ERA3YED 561V (560)	B	74.5/12.2
R1352	7030003360	S.RES ERJ3GEYJ 221 V (220)	B	77.3/13.6
R1353	7030003680	S.RES ERJ3GEYJ 104 V (100 k)	T	78.2/13.4
R1354	7030003680	S.RES ERJ3GEYJ 104 V (100 k)	T	72/13.9
R1355	7030003680	S.RES ERJ3GEYJ 104 V (100 k)	B	77.8/17.1
R1356	7030003380	S.RES ERJ3GEYJ 331 V (330)	B	76.6/17.9
R1361	7030003560	S.RES ERJ3GEYJ 103 V (10 k)	B	77.6/12
R1362	7030003560	S.RES ERJ3GEYJ 103 V (10 k)	T	76.5/9.4
R1363	7030003410	S.RES ERJ3GEYJ 561 V (560)	B	77.9/8.5
R1401	7030003520	S.RES ERJ3GEYJ 472 V (4.7 k)	B	76.2/32.3
R1402	7030003520	S.RES ERJ3GEYJ 472 V (4.7 k)	B	80.7/29.9
R1407	7030003640	S.RES ERJ3GEYJ 473 V (47 k)	T	82.3/27.7
R1408	7030003200	S.RES ERJ3GEYJ 100 V (10)	T	85/27.4
R1409	7030003320	S.RES ERJ3GEYJ 101 V (100)	T	82.3/30.6
R1410	7030003640	S.RES ERJ3GEYJ 473 V (47 k)	T	82.3/31.8
R1411	7030003640	S.RES ERJ3GEYJ 473 V (47 k)	T	82.7/33.7
R1421	7030003640	S.RES ERJ3GEYJ 473 V (47 k)	T	70.6/30.9
R1422	7030003640	S.RES ERJ3GEYJ 473 V (47 k)	T	70.6/32.1
R1423	7030003640	S.RES ERJ3GEYJ 473 V (47 k)	T	71.2/34
R1441	7030003800	S.RES ERJ3GEYJ 105 V (1 M)	T	119.4/44.4
R1451	7030009691	S.RES ERA3YED 101V (100)	T	62.8/20.4
R1452	7030009591	S.RES ERA3YED 472V (4.7 k)	T	64/20.4
R1453	7030003520	S.RES ERJ3GEYJ 472 V (4.7 k)	B	69.2/20.6
R1454	7030003520	S.RES ERJ3GEYJ 472 V (4.7 k)	B	69.3/16.8
R1455	7030005321	S.RES ERA3YED 103V (10 k)	B	69.2/34.9
R1461	7030009691	S.RES ERA3YED 101V (100)	T	69/20.4
R1462	7030009591	S.RES ERA3YED 472V (4.7 k)	T	67.8/20.4
R1463	7030005321	S.RES ERA3YED 103V (10 k)	B	69.2/23.8
R1471	7030009591	S.RES ERA3YED 472V (4.7 k)	T	67.8/32.3
R1472	7030009591	S.RES ERA3YED 472V (4.7 k)	B	70.8/34.9
R1481	7030003320	S.RES ERJ3GEYJ 101 V (100)	B	69.2/22.2
R1482	7030003320	S.RES ERJ3GEYJ 101 V (100)	T	73.5/38.2
R1491	7030003860	S.RES ERJ3GE JPW V	T	63.7/32.3
R1492	7030003860	S.RES ERJ3GE JPW V	T	66/33.9
R1501	7030003360	S.RES ERJ3GEYJ 221 V (220)	T	102.6/38.9
R1511	7030005351	S.RES ERA3YED 182V (1.8 k)	B	102/39.6
R1512	7030007230	S.RES ERA3YED 102V (1 k)	B	98.9/39.6
R1513	7030007230	S.RES ERA3YED 102V (1 k)	B	99/37.2
R1514	7030010770	S.RES ERA3YED 681V (680)	B	94.5/40.6
R1521	7030005351	S.RES ERA3YED 182V (1.8 k)	B	101.6/45.7
R1522	7030007230	S.RES ERA3YED 102V (1 k)	B	98.5/45.7
R1523	7030007230	S.RES ERA3YED 102V (1 k)	B	98.5/44.1
R1524	7030010770	S.RES ERA3YED 681V (680)	B	94.4/44.3
R1525	7030007230	S.RES ERA3YED 102V (1 k)	B	97.5/41.7
R1531	7030006461	S.RES ERA3YED 152V (1.5 k)	B	90.6/40.2
R1532	7030007230	S.RES ERA3YED 102V (1 k)	B	87.4/36.3
R1533	7030006461	S.RES ERA3YED 152V (1.5 k)	B	90.6/41.8
R1534	7030007230	S.RES ERA3YED 102V (1 k)	T	92/35
R1535	7030009691	S.RES ERA3YED 101V (100)	B	83.1/33.3
R1541	7030003320	S.RES ERJ3GEYJ 101 V (100)	B	90.6/38.6
R1542	7030003320	S.RES ERJ3GEYJ 101 V (100)	B	107/36.1
R1551	7030003320	S.RES ERJ3GEYJ 101 V (100)	B	96.4/50.6
R1552	7030003320	S.RES ERJ3GEYJ 101 V (100)	B	103.8/47.3
R1561	7030003320	S.RES ERJ3GEYJ 101 V (100)	B	90.1/36.2
R1562	7030003320	S.RES ERJ3GEYJ 101 V (100)	T	88.8/38.8
R1571	7030003520	S.RES ERJ3GEYJ 472 V (4.7 k)	T	104.9/44.4
R1572	7030003520	S.RES ERJ3GEYJ 472 V (4.7 k)	T	103.7/48.8
R1573	7030003360	S.RES ERJ3GEYJ 221 V (220)	B	108.1/52.1
R1574	7030003520	S.RES ERJ3GEYJ 472 V (4.7 k)	T	111.5/48.5
R1575	7030003360	S.RES ERJ3GEYJ 221 V (220)	B	107.8/54.3
R1576	7030003520	S.RES ERJ3GEYJ 472 V (4.7 k)	B	107.8/55.9
R1577	7030003320	S.RES ERJ3GEYJ 101 V (100)	B	109.8/52.1
R1578	7030003320	S.RES ERJ3GEYJ 101 V (100)	B	99.6/57.1
R1579	7030009691	S.RES ERA3YED 101V (100)	T	101.9/52
R1601	7030003320	S.RES ERJ3GEYJ 101 V (100)	B	86/41.8
R1605	7030007230	S.RES ERA3YED 102V (1 k)	B	97.4/37.2
R1611	7030009591	S.RES ERA3YED 472V (4.7 k)	T	78.6/41.1
R1612	7030009591	S.RES ERA3YED 472V (4.7 k)	B	76.9/38.7
R1613	7030009961	S.RES ERA3YED 221V (220)	B	76.9/40.5
R1614	7030009591	S.RES ERA3YED 472V (4.7 k)	B	78.6/39.8
R1615	7030009591	S.RES ERA3YED 472V (4.7 k)	T	74.4/39.9
R1616	7030009961	S.RES ERA3YED 221V (220)	B	81.6/37
R1617	7030009691	S.RES ERA3YED 101V (100)	B	74.6/39.4
R1621	7030005321	S.RES ERA3YED 103V (10 k)	T	78.6/43.6
R1622	7030005321	S.RES ERA3YED 103V (10 k)	T	78.6/42.4
R1623	7030005341	S.RES ERA3YED 332V (3.3 k)	T	74.7/42
R1624	7030007661	S.RES ERA3YED 331V (330)	B	75.2/45.7
R1625	7030006521	S.RES ERA3YED 561V (560)	B	72.2/47.3
R1626	7030006461	S.RES ERA3YED 152V (1.5 k)	B	72.2/44.2
R1627	7030007661	S.RES ERA3YED 331V (330)	B	75.5/49.5
R1628	7030005341	S.RES ERA3YED 332V (3.3 k)	B	75.5/51.1
R1631	7030003320	S.RES ERJ3GEYJ 101 V (100)	B	84.2/47.5
R1641	7030003320	S.RES ERJ3GEYJ 101 V (100)	B	83.9/40
R1651	7030003330	S.RES ERJ3GEYJ 121 V (120)	B	160.5/4.9
R1652	7030011740	S.RES ERJ12YJ1R5U	B	170.6/10.3
R1653	7030011740	S.RES ERJ12YJ1R5U	B	166.6/10.3
R1701	7030003860	S.RES ERJ3GE JPW V	B	114.8/23.6
R1822	7030003320	S.RES ERJ3GEYJ 101 V (100)	B	165.9/56.7
R1823	7030003320	S.RES ERJ3GEYJ 101 V (100)	B	166.9/58.2
R1824	7030003320	S.RES ERJ3GEYJ 101 V (100)	B	165.9/59.7
R1833	7030003320	S.RES ERJ3GEYJ 101 V (100)	B	166.8/61.2
R1834	7030003320	S.RES ERJ3GEYJ 101 V (100)	B	179.1/54.4
R1835	7030003320	S.RES ERJ3GEYJ 101 V (100)	B	179.9/56.1
R1859	7030003320	S.RES ERJ3GEYJ 101 V (100)	B	166/67.5
R1860	7030003320	S.RES ERJ3GEYJ 101 V (100)	B	166.8/69.1
R1861	7030003320	S.RES ERJ3GEYJ 101 V (100)	B	165.9/70.7
R1863	7030003320	S.RES ERJ3GEYJ 101 V (100)	B	179.8/65.9
R1881	7030003860	S.RES ERJ3GE JPW V	B	178.7/62.8
R1882	7030003860	S.RES ERJ3GE JPW V	B	172.6/47.1
R1883	7030003860	S.RES ERJ3GE JPW V	B	174.5/47.2
R1884	7030003860	S.RES ERJ3GE JPW V	B	170.6/47.1
R1885	7030003860	S.RES ERJ3GE JPW V	T	82.3/80.4
R1886	7030003860	S.RES ERJ3GE JPW V	B	176.8/47.2
R1887	7030003860	S.RES ERJ3GE JPW V	B	163.8/61.2

[MAIN UNIT]

REF NO.	ORDER NO.	DESCRIPTION	M.	H/V LOCATION
R1888	7030003860	S.RES ERJ3GE JPW V	B	182.3/54.4
R1889	7030003860	S.RES ERJ3GE JPW V	B	182.7/56.1
R1890	7030003860	S.RES ERJ3GE JPW V	B	162.8/67.5
R1891	7030003860	S.RES ERJ3GE JPW V	B	166.7/72.3
R1892	7030003320	S.RES ERJ3GEYJ 101 V (100)	T	93.2/81.8
R1893	7030003320	S.RES ERJ3GEYJ 101 V (100)	T	100.1/82.1
R1894	7030003320	S.RES ERJ3GEYJ 101 V (100)	T	100.5/72.1
R1895	7030003320	S.RES ERJ3GEYJ 101 V (100)	T	93.2/72.1
R1896	7030003860	S.RES ERJ3GE JPW V	T	82.5/70
R1897	7030003860	S.RES ERJ3GE JPW V	T	81.3/70
R1898	7030003860	S.RES ERJ3GE JPW V	T	80.1/70
R1899	7030003860	S.RES ERJ3GE JPW V	T	78.9/70
R1900	7030003860	S.RES ERJ3GE JPW V	T	79.3/70
R1901	7030003860	S.RES ERJ3GE JPW V	T	81.7/81.6
R1902	7030003860	S.RES ERJ3GE JPW V	B	135.8/69.3
R1903	7030003860	S.RES ERJ3GE JPW V	B	107.9/72.3
R1904	7030003860	S.RES ERJ3GE JPW V	B	110.6/72.8
R1905	7030003860	S.RES ERJ3GE JPW V	B	135.9/81.5
R1906	7030003860	S.RES ERJ3GE JPW V	B	125.4/71.7
R1907	7030003860	S.RES ERJ3GE JPW V	B	104.8/72.4
R1908	7030003860	S.RES ERJ3GE JPW V	B	136.9/71.8
R1909	7030003860	S.RES ERJ3GE JPW V	B	124.9/75.6
R1910	7030003860	S.RES ERJ3GE JPW V	B	127.7/86.6
R1911	7030003860	S.RES ERJ3GE JPW V	T	143.5/89.8
R1912	7030003860	S.RES ERJ3GE JPW V	B	123.5/80.3
R1913	7030003860	S.RES ERJ3GE JPW V	B	123.3/72.7
R1914	7030003860	S.RES ERJ3GE JPW V	B	76.1/78.5
R1921	7030009851	S.RES ERA3YED 271V (270)	T	87.3/73.4
R1922	7030009891	S.RES ERA3YED 151V (150)	T	86.1/70
R1930	7030003320	S.RES ERJ3GEYJ 101 V (100)	T	100.5/79.1
R1931	7030003320	S.RES ERJ3GEYJ 101 V (100)	T	100.5/76
R1932	7030003560	S.RES ERJ3GEYJ 103 V (10 k)	T	95/83.5
R1933	7030003560	S.RES ERJ3GEYJ 103 V (10 k)	T	98.6/83.5
R1934	7030003560	S.RES ERJ3GEYJ 103 V (10 k)	T	98.7/72.1
R1935	7030003560	S.RES ERJ3GEYJ 103 V (10 k)	T	95.1/72.1
R2001	7030003440	S.RES ERJ3GEYJ 102 V (1 k)	T	108.6/70.6
R2002	7030003440	S.RES ERJ3GEYJ 102 V (1 k)	T	104.9/71.7
R2003	7030003620	S.RES ERJ3GEYJ 333 V (33 k)	T	120.2/85
R2004	7030003680	S.RES ERJ3GEYJ 104 V (100 k)	T	118/86.1
R2005	7030003520	S.RES ERJ3GEYJ 472 V (4.7 k)	T	116.5/82.7
R2006	7310005390	S.TRI EVM-3VXS50 BQ3 (472)	T	113.5/86.6
R2007	7030003320	S.RES ERJ3GEYJ 101 V (100)	T	110.7/72.6
R2008	7030003450	S.RES ERJ3GEYJ 122 V (1.2 k)	T	113.3/82.6
R2009	7030003520	S.RES ERJ3GEYJ 472 V (4.7 k)	T	109.9/79.8
R2010	7030003720	S.RES ERJ3GEYJ 224 V (220 k)	T	110.7/75.2
R2011	7030003640	S.RES ERJ3GEYJ 473 V (47 k)	T	116.1/76.6
R2012	7030003720	S.RES ERJ3GEYJ 224 V (220 k)	T	110.7/81.8
R2013	7030003480	S.RES ERJ3GEYJ 222 V (2.2 k)	T	108.8/77.2
R2014	7030003380	S.RES ERJ3GEYJ 331 V (330)	T	109.5/81.8
R2015	7030000340	S.RES MCR10EZHJ 470 (471)	T	112.2/71.6
R2016	7030000340	S.RES MCR10EZHJ 470 (471)	T	114/71.6
R2017	7030003560	S.RES ERJ3GEYJ 103 V (10 k)	T	108.8/76
R2018	7030003660	S.RES ERJ3GEYJ 683 V (68 k)	T	110.7/77.9
R2019	7030003680	S.RES ERJ3GEYJ 104 V (100 k)	T	106.9/76.7
R2020	7510001511	S.TMR NTCG16 4LH 223J	T	108.8/78.6
R2021	7030003320	S.RES ERJ3GEYJ 101 V (100)	B	120.1/80.3
R2022	7030003740	S.RES ERJ3GEYJ 334 V (330 k)	T	120.3/81.2
R2023	7030003320	S.RES ERJ3GEYJ 101 V (100)	T	140.8/87.8
R2024	7030005681	S.RES ERA3YKD 473V (47 k)	T	122.1/81.7
R2025	7030008121	S.RES ERA3YED 682V (6.8 k)	T	122.1/80.5
R2026	7030003320	S.RES ERJ3GEYJ 101 V (100)	T	125.8/86
R2027	7030009861	S.RES ERA3YED 471V (470)	T	125.8/81.5
R2028	7310005370	S.TRI EVM-3VXS50 BQ2 (471)	T	125.3/78.5
R2029	7030008121	S.RES ERA3YED 682V (6.8 k)	T	121.8/79.3
R2030	7030005681	S.RES ERA3YKD 473V (47 k)	T	121.8/78.1
R2041	7030003860	S.RES ERJ3GE JPW V	T	118.1/87.8
R2042	7310005420	S.TRI EVM-3VXS50 B15 (104)	T	122.3/88.2
R2043	7030003560	S.RES ERJ3GEYJ 103 V (10 k)	T	129.1/84.3
R2044	7030003560	S.RES ERJ3GEYJ 103 V (10 k)	T	128.9/86.1
R2045	7030003660	S.RES ERJ3GEYJ 474 V (470 k)	T	130.6/83
R2046	7030003380	S.RES ERJ3GEYJ 331 V (330)	T	139.9/81
R2048	7030003660	S.RES ERJ3GEYJ 683 V (68 k)	B	118.3/80.3
R2051	7030009920	S.RES ERJ3GEYJ 335 V (3.3 M)	T	140.4/83.4
R2052	7030003600	S.RES ERJ3GEYJ 223 V (22 k)	B	145.1/85.3
R2053	7030003820	S.RES ERJ3GEYJ 155 V (1.5 M)	T	142.3/84.1
R2054	7030003840	S.RES ERJ3GEYJ 225 V (2.2 M)	T	140/85.4
R2055	7030003			

[MAIN UNIT]

REF NO.	ORDER NO.	DESCRIPTION	M.	H/V LOCATION
C11	4030006880	S.CER C1608 JB 1H 472K-T	B	50.8/72.2
C21	4030006880	S.CER C1608 JB 1H 472K-T	B	43.6/80.2
C31	4030006880	S.CER C1608 JB 1H 472K-T	B	32.2/80.2
C101	4030011600	S.CER C1608 JB 1E 104K-T	T	131.6/93.4
C161	4510008510	S.ELE EEE1CA471P	T	44.7/59.5
C162	4510008540	S.ELE EEE1CA100SR	T	47.9/67.5
C163	4030011600	S.CER C1608 JB 1E 104K-T	B	44/55
C164	4510008500	S.ELE EEE1CA101WP	T	53.8/54.7
C171	4510008550	S.ELE EEE1HA010SR	T	43.3/51.7
C172	4030011600	S.CER C1608 JB 1E 104K-T	B	52.3/44.4
C173	4030007120	S.CER C1608 CH 1H 820J-T	B	49.8/47.7
C174	4510008550	S.ELE EEE1HA010SR	T	43.5/46.9
C175	4510008550	S.ELE EEE1HA010SR	T	54/47.6
C176	4510008540	S.ELE EEE1CA100SR	T	43.2/42.1
C177	4510008540	S.ELE EEE1CA100SR	T	55.3/40.7
C178	4510008550	S.ELE EEE1HA010SR	T	54.6/35.4
C179	4510008550	S.ELE EEE1HA010SR	T	49.3/32.6
C191	4510008550	S.ELE EEE1HA010SR	T	65.1/69.8
C192	4030017840	S.CER C2012 CH 1H 222J-T	B	61.6/72.6
C193	4030019090	S.CER C2012 JB 1C 225M-T	T	66.9/76
C194	4510008540	S.ELE EEE1CA100SR	T	55.4/70.6
C195	4510008550	S.ELE EEE1HA010SR	T	60.2/67.3
C196	4510008540	S.ELE EEE1CA100SR	T	55.6/76.1
C197	4510008550	S.ELE EEE1HA010SR	T	63/82.8
C198	4510008540	S.ELE EEE1CA100SR	T	58.2/82.8
C201	4510008550	S.ELE EEE1HA010SR	T	43.2/37.3
C202	4030011600	S.CER C1608 JB 1E 104K-T	B	45.8/36.6
C211	4030011600	S.CER C1608 JB 1E 104K-T	B	51.6/24
C212	4030011600	S.CER C1608 JB 1E 104K-T	B	46.3/29.8
C213	4030012600	S.CER C2012 JB 1A 105M-T	B	41.2/22.6
C221	4030007170	S.CER C1608 CH 1H 221J-T	T	47.7/25.8
C222	4030011600	S.CER C1608 JB 1E 104K-T	T	51.6/25.8
C223	4510008500	S.ELE EEE1CA101WP	T	56.1/25.9
C224	4510008540	S.ELE EEE1CA100SR	T	49.8/20.4
C225	4510008500	S.ELE EEE1CA101WP	T	43.3/20.7
C226	4030011600	S.CER C1608 JB 1E 104K-T	T	51.5/23.9
C231	4510008540	S.ELE EEE1CA100SR	T	39.9/70.5
C232	4030012600	S.CER C2012 JB 1A 105M-T	T	45.9/74.5
C233	4030012600	S.CER C2012 JB 1A 105M-T	T	45.8/78.9
C234	4510008540	S.ELE EEE1CA100SR	T	40.3/83.3
C235	4030012600	S.CER C2012 JB 1A 105M-T	T	40.1/79.3
C236	4510008540	S.ELE EEE1CA100SR	T	30.7/83.2
C237	4510008540	S.ELE EEE1CA100SR	T	35.5/81.2
C241	4030010760	S.CER C1608 CH 1H 331J-T	B	36.4/64.7
C242	4510008540	S.ELE EEE1CA100SR	T	37.2/65.2
C243	4510008540	S.ELE EEE1CA100SR	T	50.1/72.4
C261	4030006880	S.CER C1608 JB 1H 472K-T	B	19/80.5
C262	4030006880	S.CER C1608 JB 1H 472K-T	B	14.7/77.8
C271	4510008180	ELE EUUFC1E102S		
C272	4030011600	S.CER C1608 JB 1E 104K-T	B	18.6/58.4
C281	4510008180	ELE EUUFC1E102S		
C282	4030009000	S.CER C2012 JB 1C 224K-T	T	5.3/58.3
C283	4510008500	S.ELE EEE1CA101WP	T	9.8/43.9
C284	4510008550	S.ELE EEE1HA010SR	T	5.2/37.8
C285	4510008550	S.ELE EEE1HA010SR	T	10.6/37.5
C286	4510008550	S.ELE EEE1HA010SR	T	16.8/43
C287	4510008190	ELE EUUFC1E222S		
C288	4030011600	S.CER C1608 JB 1E 104K-T	B	18.7/69.5
C291	4030011600	S.CER C1608 JB 1E 104K-T	B	22.7/35.7
C292	4030008950	S.CER C2012 JB 1C 823K-T	B	16.8/37.3
C293	4030008880	S.CER C1608 JB 1H 223K-T	B	16.6/33.9
C301	4030008950	S.CER C2012 JB 1C 823K-T	B	28.9/30.8
C302	4030011600	S.CER C1608 JB 1E 104K-T	B	32.2/28.6
C311	4510008500	S.ELE EEE1CA101WP	T	32.6/31.8
C313	4510008550	S.ELE EEE1HA010SR	T	24.4/34.3
C314	4510008540	S.ELE EEE1CA100SR	T	26.1/23
C315	4510008540	S.ELE EEE1CA100SR	T	21.3/23
C316	4510008540	S.ELE EEE1CA100SR	T	17.6/32.8
C317	4510008550	S.ELE EEE1HA010SR	T	17.3/26.9
C318	4510008540	S.ELE EEE1CA100SR	T	20.2/38.1
C319	4030012600	S.CER C2012 JB 1A 105M-T	B	33/37.8
C320	4030012600	S.CER C2012 JB 1A 105M-T	B	36.2/29.5
C331	4030008650	S.CER C1608 JB 1H 332K-T	B	19.5/21.4
C332	4030019090	S.CER C2012 JB 1C 225M-T	T	18.9/18.3
C333	4510008540	S.ELE EEE1CA100SR	T	24.3/17.7
C334	4510008540	S.ELE EEE1CA100SR	T	15.8/21.5
C351	4030011600	S.CER C1608 JB 1E 104K-T	B	18.9/14.4
C354	4550007480	S.TAN F930J106MAABMA	B	32.8/15.7
C355	4550007480	S.TAN F930J106MAABMA	B	29/13.7
C361	4030011600	S.CER C1608 JB 1E 104K-T	T	36/18.6
C400	4030006880	S.CER C1608 JB 1H 472K-T	T	19.2/4.5
C426	4510008800	S.ELE EEE1EA100SR	T	65.1/46.5
C427	4030011600	S.CER C1608 JB 1E 104K-T	B	64.7/49.8
C428	4030006880	S.CER C1608 JB 1H 472K-T	B	66.3/49.8
C429	4030006880	S.CER C1608 JB 1H 472K-T	B	67.9/49.8
C430	4030006880	S.CER C1608 JB 1H 472K-T	B	69.7/49.8
C464	4510008540	S.ELE EEE1CA100SR	T	43.2/32.5
C701	4030011600	S.CER C1608 JB 1E 104K-T	B	139/99.5
C702	4030011600	S.CER C1608 JB 1E 104K-T	B	124/99.5
C703	4030011600	S.CER C1608 JB 1E 104K-T	T	131.6/92.1
C711	4030006880	S.CER C1608 JB 1H 472K-T	B	163.7/77.8
C721	4030006880	S.CER C1608 JB 1H 472K-T	B	54.9/77.5
C722	4010005380	CER HMI3SJ YB 472K 500V		
C723	4030006880	S.CER C1608 JB 1H 472K-T	B	90.6/90.5
C724	4030006880	S.CER C1608 JB 1H 472K-T	B	90.6/93.8
C731	4030006880	S.CER C1608 JB 1H 472K-T	B	63.8/90.8
C732	4030006880	S.CER C1608 JB 1H 472K-T	B	62.8/85.2
C733	4030006880	S.CER C1608 JB 1H 472K-T	B	52.1/98.6
C734	4030006880	S.CER C1608 JB 1H 472K-T	B	42.2/97.7
C735	4030006880	S.CER C1608 JB 1H 472K-T	B	53.4/81.2
C736	4030006880	S.CER C1608 JB 1H 472K-T	B	50.9/81.9
C737	4030006880	S.CER C1608 JB 1H 472K-T	B	47.1/77.5
C741	4030006880	S.CER C1608 JB 1H 472K-T	B	36.4/88.6
C742	4030006880	S.CER C1608 JB 1H 472K-T	B	28.7/97.8

[MAIN UNIT]

REF NO.	ORDER NO.	DESCRIPTION	M.	H/V LOCATION
C743	4030006880	S.CER C1608 JB 1H 472K-T	B	33.1/84.3
C745	4510008540	S.ELE EEE1CA100SR	T	25.9/83.3
C746	4030011600	S.CER C1608 JB 1E 104K-T	B	28.2/85.2
C747	4030011600	S.CER C1608 JB 1E 104K-T	B	28.1/78.6
C748	4510008540	S.ELE EEE1CA100SR	T	21.1/83.3
C761	4510008500	S.ELE EEE1CA101WP	T	46.8/83.4
C762	4510008540	S.ELE EEE1CA100SR	T	53.3/81.5
C842	4030006880	S.CER C1608 JB 1H 472K-T	T	35.7/61.5
C843	4030006880	S.CER C1608 JB 1H 472K-T	T	35/56.3
C844	4030006880	S.CER C1608 JB 1H 472K-T	T	37/58.5
C851	4030006880	S.CER C1608 JB 1H 472K-T	B	72.1/71.7
C852	4030006880	S.CER C1608 JB 1H 472K-T	B	72.1/73.5
C853	4030006880	S.CER C1608 JB 1H 472K-T	B	72.1/75.3
C854	4030006880	S.CER C1608 JB 1H 472K-T	B	72.1/77.1
C855	4030006880	S.CER C1608 JB 1H 472K-T	B	72.2/79.8
C911	4030006880	S.CER C1608 JB 1H 472K-T	B	159/19.6
C912	4030006880	S.CER C1608 JB 1H 472K-T	B	168.2/21
C913	4030006880	S.CER C1608 JB 1H 472K-T	B	158/21
C914	4030006880	S.CER C1608 JB 1H 472K-T	B	168.2/23
C915	4030006880	S.CER C1608 JB 1H 472K-T	B	154.4/24.3
C916	4030006880	S.CER C1608 JB 1H 472K-T	B	168.2/25
C917	4030006880	S.CER C1608 JB 1H 472K-T	B	154.4/26.1
C918	4030006880	S.CER C1608 JB 1H 472K-T	B	168.2/27
C919	4030006880	S.CER C1608 JB 1H 472K-T	B	154.4/27.9
C921	4030006880	S.CER C1608 JB 1H 472K-T	B	168.3/31
C922	4030006880	S.CER C1608 JB 1H 472K-T	B	168.2/33
C923	4030006880	S.CER C1608 JB 1H 472K-T	B	154.8/34.1
C924	4030006880	S.CER C1608 JB 1H 472K-T	B	168.2/35
C925	4030006880	S.CER C1608 JB 1H 472K-T	B	154.8/35.9
C928	4030006880	S.CER C1608 JB 1H 472K-T	T	166.1/41.9
C943	4030006880	S.CER C1608 JB 1H 472K-T	B	12.9/28.1
C944	4030006880	S.CER C1608 JB 1H 472K-T	B	3.2/29.1
C974	4030006880	S.CER C1608 JB 1H 472K-T	B	180.4/26
C975	4030006880	S.CER C1608 JB 1H 472K-T	B	172.1/27
C978	4030006880	S.CER C1608 JB 1H 472K-T	B	180.4/30
C979	4030006880	S.CER C1608 JB 1H 472K-T	B	172.1/31
C981	4030006880	S.CER C1608 JB 1H 472K-T	B	172.1/33
C982	4030006880	S.CER C1608 JB 1H 472K-T	B	172.1/35
C987	4030006880	S.CER C1608 JB 1H 472K-T	B	172.1/39
C991	4030006880	S.CER C1608 JB 1H 472K-T	T	166.1/39.3
C1001	4510007130	S.ELE EEFCD OJ 470R	B	142.2/14.7
C1002	4510007130	S.ELE EEFCD OJ 470R	B	137.4/14.7
C1003	4030011600	S.CER C1608 JB 1E 104K-T	B	120.5/23
C1004	4030011600	S.CER C1608 JB 1E 104K-T	B	119.7/39
C1005	4030011600	S.CER C1608 JB 1E 104K-T	B	124.5/21.6
C1006	4030011600	S.CER C1608 JB 1E 104K-T	B	123.7/41.1
C1007	4030011600	S.CER C1608 JB 1E 104K-T	B	120.5/34.7
C1008	4030011600	S.CER C1608 JB 1E 104K-T	B	120.5/28.2
C1009	4030011600	S.CER C1608 JB 1E 104K-T	B	120.5/36
C1010	4030011600	S.CER C1608 JB 1E 104K-T	B	127.4/21.6
C1011	4030011600	S.CER C1608 JB 1E 104K-T	B	128.6/41.5
C1012	4030011600	S.CER C1608 JB 1E 104K-T	B	130/21.6
C1013	4030011600	S.CER C1608 JB 1E 104K-T	B	134.8/21.5
C1014	4030011600	S.CER C1608 JB 1E 104K-T	B	134.9/42.3
C1015	4030011600	S.CER C1608 JB 1E 104K-T	B	140.6/26.8
C1016	4030011600	S.CER C1608 JB 1E 104K-T	B	140.5/28.4
C1017	4030011600	S.CER C1608 JB 1E 104K-T	B	145.3/33
C1018	4030011600	S.CER C1608 JB 1E 104K-T	B	136.4/42.3
C1019	4030011600	S.CER C1608 JB 1E 104K-T	B	138/21.5
C1020	4030011600	S.CER C1608 JB 1E 104K-T	B	138/42.3
C1021	4030011600	S.CER C1608 JB 1E 104K-T	B	140.6/25.2
C1022	4030011600	S.CER C1608 JB 1E 104K-T	B	140.5/39.5
C1023	4030016930	S.CER ECJ0EB1A104K	B	128.5/29.1
C1024	4030016930	S.CER ECJ0EB1A104K	B	128.5/30.1
C1025	4030016930	S.CER ECJ0EB1A104K	B	128.5/31.1
C1026	4030016930	S.CER ECJ0EB1A104K	B	128.5/32.1
C1027	4030016930	S.CER ECJ0EB1A104K	B	128.5/33.1
C1028	4030016930	S.CER ECJ0EB1A104K	B	128.5/34.1
C1029	4030016930	S.CER ECJ0EB1A104K	B	133.4/29.1
C1030	4030016930	S.CER ECJ0EB1A104K	B	133.4/30.1
C1031	4030016930	S.CER ECJ0EB1A104K	B	133.4/31.1
C1032	4030016930	S.CER ECJ0EB1A104K	B	133.4/32.1
C1033	4030016930	S.CER ECJ0EB1A104K	B	133.4/33.1
C1034	4030016930	S.CER ECJ0EB1A104K	B	133.4/34.1
C1035	4030016930	S.CER ECJ0EB1A104K	B	132.2/29.1
C1036	4030016930	S.CER ECJ0EB1A104K	B	131.3/30.7
C1037	4030016930	S.CER ECJ0EB1A104K	B	130.3/29.1
C1038	4030016930	S.CER ECJ0EB1A104K	B	129.8/30.7
C1039	4030016930			

[MAIN UNIT]

REF NO.	ORDER NO.	DESCRIPTION	M.	H/V LOCATION
C1223	4550007500	S.TAN F931D106MBABMA	B	88.4/13.6
C1224	4030011600	S.CER C1608 JB 1E 104K-T	T	96/14.4
C1225	4030018580	S.CER C1608 CH 1H 821J-T	T	94.7/18.1
C1226	4030007050	S.CER C1608 CH 1H 220J-T	T	90.5/22.4
C1227	4030011600	S.CER C1608 JB 1E 104K-T	T	95.5/16.2
C1231	4550007500	S.TAN F931D106MBABMA	B	102.6/11.2
C1232	4030011600	S.CER C1608 JB 1E 104K-T	T	98.4/9.1
C1233	4550007500	S.TAN F931D106MBABMA	B	110.8/9.7
C1234	4030011600	S.CER C1608 JB 1E 104K-T	T	108.2/6.2
C1235	4030018580	S.CER C1608 CH 1H 821J-T	T	105.6/8.6
C1236	4030007050	S.CER C1608 CH 1H 220J-T	B	101.5/6.8
C1237	4030011600	S.CER C1608 JB 1E 104K-T	T	106.3/6.7
C1241	4550007520	S.TAN F931A106MAABMA	B	106.7/7.8
C1251	4550007480	S.TAN F930J106MAABMA	B	97.5/16.4
C1252	4550007480	S.TAN F930J106MAABMA	B	103.3/17.1
C1253	4030011810	S.CER C1608 JB 1A 224K-T	B	99.9/16.8
C1254	4030011810	S.CER C1608 JB 1A 224K-T	T	98.1/15
C1255	4030017840	S.CER C2012 CH 1H 222J-T	T	103.5/14.1
C1256	4550007480	S.TAN F930J106MAABMA	B	111.2/15.6
C1257	4030011600	S.CER C1608 JB 1E 104K-T	T	107.5/14.3
C1261	4550007480	S.TAN F930J106MAABMA	B	98.5/23.3
C1262	4550007480	S.TAN F930J106MAABMA	B	103.3/22.6
C1263	4030009000	S.CER C2012 JB 1C 224K-T	T	99.5/27.5
C1264	4030009000	S.CER C2012 JB 1C 224K-T	T	100.8/29.2
C1265	4030017840	S.CER C2012 CH 1H 222J-T	B	103.6/27.4
C1266	4030011600	S.CER C1608 JB 1E 104K-T	T	107.4/27.2
C1267	4550007520	S.TAN F931A106MAABMA	B	108.6/25.2
C1301	4550007480	S.TAN F930J106MAABMA	B	108.6/27.7
C1311	4030017810	S.CER C1608 CH 1H 102J-T	B	92.7/26.5
C1312	4030007050	S.CER C1608 CH 1H 220J-T	T	96.2/22.8
C1313	4030011600	S.CER C1608 JB 1E 104K-T	T	87.1/24.5
C1314	4550007520	S.TAN F931A106MAABMA	B	86.2/25.4
C1315	4030011600	S.CER C1608 JB 1E 104K-T	T	97/25.4
C1316	4550007500	S.TAN F931D106MBABMA	B	95.6/24.1
C1317	4030011600	S.CER C1608 JB 1E 104K-T	T	87.9/22.4
C1318	4550007500	S.TAN F931D106MBABMA	B	90/25.1
C1321	4030017810	S.CER C1608 CH 1H 102J-T	T	109.5/30.5
C1322	4030007050	S.CER C1608 CH 1H 220J-T	T	113.8/32.4
C1323	4030011600	S.CER C1608 JB 1E 104K-T	T	103.4/30.5
C1324	4550007520	S.TAN F931A106MAABMA	B	104.2/32.1
C1325	4030011600	S.CER C1608 JB 1E 104K-T	T	113.8/35.2
C1326	4550007500	S.TAN F931D106MBABMA	B	113.7/32.1
C1327	4030011600	S.CER C1608 JB 1E 104K-T	T	104.6/30.5
C1328	4550007500	S.TAN F931D106MBABMA	B	107.2/32.1
C1330	4030007170	S.CER C1608 CH 1H 221J-T	B	83.7/26.6
C1331	4030007050	S.CER C1608 CH 1H 220J-T	T	101.9/35.5
C1333	4030011600	S.CER C1608 JB 1E 104K-T	T	101.9/31.9
C1334	4550007500	S.TAN F931D106MBABMA	B	100/34.1
C1335	4030011600	S.CER C1608 JB 1E 104K-T	T	92.7/32.4
C1336	4550007500	S.TAN F931D106MBABMA	B	97.7/30.1
C1351	4030011600	S.CER C1608 JB 1E 104K-T	T	75.1/13.9
C1352	4550007500	S.TAN F931D106MBABMA	B	74.3/16.1
C1353	4030011600	S.CER C1608 JB 1E 104K-T	T	79/21.3
C1354	4550007500	S.TAN F931D106MBABMA	B	81.8/16.2
C1355	4030007090	S.CER C1608 CH 1H 470J-T	B	77.3/15.2
C1361	4030011600	S.CER C1608 JB 1E 104K-T	B	79.5/7
C1362	4510008540	S.ELE EEE1CA100SR	T	79.6/7.9
C1363	4030011600	S.CER C1608 JB 1E 104K-T	B	73.4/10.6
C1401	4550007480	S.TAN F930J106MAABMA	B	81.8/26.3
C1402	4030011600	S.CER C1608 JB 1E 104K-T	T	82.3/24.8
C1403	4030011810	S.CER C1608 JB 1A 224K-T	T	82.3/26.4
C1404	4550007520	S.TAN F931A106MAABMA	B	79.5/32.8
C1405	4030011600	S.CER C1608 JB 1E 104K-T	B	80.7/31.1
C1406	4030017840	S.CER C2012 CH 1H 222J-T	B	79.8/27.6
C1407	4030011600	S.CER C1608 JB 1E 104K-T	T	82.3/29
C1408	4550007480	S.TAN F930J106MAABMA	B	76.7/27.5
C1421	4550007480	S.TAN F930J106MAABMA	B	74.4/22.9
C1422	4030011600	S.CER C1608 JB 1E 104K-T	T	72.2/23.9
C1423	4030011810	S.CER C1608 JB 1A 224K-T	T	70.7/25.1
C1424	4030017840	S.CER C2012 CH 1H 222J-T	B	71.9/27.1
C1425	4030011600	S.CER C1608 JB 1E 104K-T	T	70.5/29.3
C1426	4550007520	S.TAN F931A106MAABMA	B	74.2/26.4
C1431	4030011600	S.CER C1608 JB 1E 104K-T	T	122.5/46.9
C1441	4030011600	S.CER C1608 JB 1E 104K-T	T	119.4/48.2
C1442	4030006860	S.CER C1608 JB 1H 102K-T	B	121.2/47
C1451	4030006860	S.CER C1608 JB 1H 102K-T	T	63.5/22.4
C1453	4030011600	S.CER C1608 JB 1E 104K-T	T	65.4/21.7
C1454	4550007480	S.TAN F930J106MAABMA	B	65.7/16.9
C1455	4030011600	S.CER C1608 JB 1E 104K-T	B	64.4/23.3
C1456	4550007480	S.TAN F930J106MAABMA	B	69.4/38.9
C1461	4030006860	S.CER C1608 JB 1H 102K-T	T	68.5/22.4
C1463	4030011600	S.CER C1608 JB 1E 104K-T	T	66.6/21.7
C1464	4550007480	S.TAN F930J106MAABMA	B	69.5/27.4
C1472	4550007660	S.TAN F931E105MAABMA	B	71.8/38.9
C1481	4030011600	S.CER C1608 JB 1E 104K-T	T	69.4/27.4
C1482	4550007520	S.TAN F931A106MAABMA	B	66.4/22.1
C1483	4030011600	S.CER C1608 JB 1E 104K-T	T	66/32.3
C1484	4550007500	S.TAN F931D106MBABMA	T	70.2/38.3
C1501	4030011600	S.CER C1608 JB 1E 104K-T	T	113.6/45.9
C1502	4550007520	S.TAN F931A106MAABMA	B	108.9/48.4
C1503	4030011600	S.CER C1608 JB 1E 104K-T	T	102.1/43.7
C1504	4550007520	S.TAN F931A106MAABMA	B	108.9/46
C1505	4550007520	S.TAN F931A106MAABMA	B	105.1/43.1
C1506	4030011600	S.CER C1608 JB 1E 104K-T	T	102.3/44.9
C1507	4030011600	S.CER C1608 JB 1E 104K-T	T	102.9/41.9
C1512	4030018610	S.CER C1608 CH 1H 182J-T	B	94.8/42.5
C1513	4030018610	S.CER C1608 CH 1H 182J-T	B	101.7/37.7
C1514	4030007050	S.CER C1608 CH 1H 220J-T	T	90.6/39.5
C1522	4030018610	S.CER C1608 CH 1H 182J-T	B	94.8/46.4
C1523	4030018610	S.CER C1608 CH 1H 182J-T	B	101.6/43.9
C1524	4030007050	S.CER C1608 CH 1H 220J-T	T	90.6/45.9
C1531	4030017800	S.CER C1608 CH 1H 561J-T	B	87.5/38
C1532	4030017800	S.CER C1608 CH 1H 561J-T	B	92/36.1
C1533	4030007050	S.CER C1608 CH 1H 220J-T	B	84.7/36.6

[MAIN UNIT]

REF NO.	ORDER NO.	DESCRIPTION	M.	H/V LOCATION
C1541	4030011600	S.CER C1608 JB 1E 104K-T	T	91.9/38.7
C1542	4550007500	S.TAN F931D106MBABMA	B	94.8/36.6
C1543	4030011600	S.CER C1608 JB 1E 104K-T	T	97.9/43.8
C1544	4550007500	S.TAN F931D106MBABMA	B	108.1/38.7
C1551	4030011600	S.CER C1608 JB 1E 104K-T	T	91.9/45.3
C1552	4550007500	S.TAN F931D106MBABMA	B	93.8/51.5
C1553	4030011600	S.CER C1608 JB 1E 104K-T	T	101.4/48.3
C1554	4550007500	S.TAN F931D106MBABMA	B	103.8/51.2
C1561	4030011600	S.CER C1608 JB 1E 104K-T	B	87.4/34.7
C1562	4550007500	S.TAN F931D106MBABMA	B	88.5/32.1
C1563	4030011600	S.CER C1608 JB 1E 104K-T	T	92.7/36.9
C1564	4550007500	S.TAN F931D106MBABMA	T	89.2/30.2
C1571	4030019130	S.CER C2012 CH 1H 562JT-NS	T	108.5/48.7
C1572	4030018580	S.CER C1608 CH 1H 821J-T	B	107.8/57.5
C1573	4030018580	S.CER C1608 CH 1H 821J-T	B	105.3/56
C1574	4030011600	S.CER C1608 JB 1E 104K-T	B	111.6/53.7
C1575	4510008540	S.ELE EEE1CA100SR	T	111.9/55.2
C1576	4030011600	S.CER C1608 JB 1E 104K-T	T	102.6/56.8
C1577	4510008540	S.ELE EEE1CA100SR	T	99.5/55.2
C1578	4030007050	S.CER C1608 CH 1H 220J-T	T	106/60
C1601	4510008540	S.ELE EEE1CA100SR	T	94.2/54.3
C1602	4030011600	S.CER C1608 JB 1E 104K-T	T	89.7/48.4
C1603	4030011600	S.CER C1608 JB 1E 104K-T	T	90.5/42.1
C1604	4030011600	S.CER C1608 JB 1E 104K-T	T	78.6/38.4
C1605	4510008540	S.ELE EEE1CA100SR	T	87.8/53.9
C1611	4030019130	S.CER C2012 CH 1H 562JT-NS	T	76.5/39.5
C1612	4030018580	S.CER C1608 CH 1H 821J-T	B	81.5/38.7
C1613	4030018580	S.CER C1608 CH 1H 821J-T	B	79.1/39.7
C1621	4030018620	S.CER C1608 CH 1H 222J-T	T	76.7/43.2
C1622	4030011600	S.CER C1608 JB 1E 104K-T	B	70.8/47.3
C1623	4510008540	S.ELE EEE1CA101WP	T	71.6/46.1
C1624	4030017870	S.CER C1608 CH 1H 681J-T	B	73.8/47.3
C1625	4030017870	S.CER C1608 CH 1H 681J-T	B	77.6/50.3
C1631	4510008540	S.ELE EEE1CA100SR	T	81.5/53.9
C1632	4030011600	S.CER C1608 JB 1E 104K-T	B	84.2/49.1
C1641	4030011600	S.CER C1608 JB 1E 104K-T	B	81.8/40.5
C1642	4510008540	S.ELE EEE1CA100SR	T	77.8/47.2
C1651	4030011600	S.CER C1608 JB 1E 104K-T	B	162.6/12.9
C1652	4510008540	S.ELE EEE1CA100SR	T	153.8/3.4
C1653	4030011600	S.CER C1608 JB 1E 104K-T	B	152.5/3.9
C1654	4030017490	S.CER C1608 JB 1A 105K-T	B	161.8/4.9
C1655	4550007460	S.TAN F930G107MBABMA	B	149.6/11.8
C1801	4030011600	S.CER C1608 JB 1E 104K-T	B	175.5/50.1
C1841	4030011600	S.CER C1608 JB 1E 104K-T	B	175/62.8
C1921	4030011600	S.CER C1608 JB 1E 104K-T	T	86.1/77.8
C1922	4030011600	S.CER C1608 JB 1E 104K-T	T	86.1/73.4
C1930	4030011600	S.CER C1608 JB 1E 104K-T	T	101.9/79
C1931	4030011600	S.CER C1608 JB 1E 104K-T	T	101.9/76
C2001	4030011600	S.CER C1608 JB 1E 104K-T	B	112.9/72.6
C2002	4030011600	S.CER C1608 JB 1E 104K-T	T	118.2/73.2
C2003	4030011600	S.CER C1608 JB 1E 104K-T	T	140.8/86.6
C2004	4030011600	S.CER C1608 JB 1E 104K-T	T	127/85.9
C2045	4030006860	S.CER C1608 JB 1H 102K-T	T	130.6/81.8
C2051	4030006860	S.CER C1608 JB 1H 102K-T	T	139.2/83.4
C2053	4030012600	S.CER C2012 JB 1A 105M-T	B	143.8/74.3
C2056	4030012600	S.CER C2012 JB 1A 105M-T	B	139.2/74.2
C2057	4030012600	S.CER C2012 JB 1A 105M-T	B	139.9/72.3
C2058	4510008540	S.ELE EEE1CA100SR	T	142.3/72
C2059	4030009530	S.CER C1608 CH 1H 030B-T	T	121.4/75
C2060	4030011600	S.CER C1608 JB 1E 104K-T	T	138.6/77.2
C2061	4030012600	S.CER C2012 JB 1A 105M-T	B	139.6/76.2
RL261	6330001860	RLY UA2-12NU		
RL721	6330000540	RLY 2-1419131-2 (OMR-109F)		
CP2041	6910009670	S.CHK HK3-S-T	T	150.7/72.8
CP2051	6910009670	S.CHK HK3-S-T	T	123.6/71
J701	6510023701	CNR TORX178S (F)		
J702	6510023711	CNR TOTX178S (F)		
J711	6510023740	CNR LGR4609-7000		
J721	6450001130	CNR JPJ2042-01-110		
J731	6510023671	CNR TCS4480-0141577		
J741	6510023661	CNR TCS4470-0141577		
J751	6510023720	CNR LGY6501-0600C		
J761	6510023750	CNR 01K1971-10 (I)		
J762	6510007020	CNR TMP-J01X-V6		
J801	6510007020	CNR TMP-J01X-V6		
J811	6510020251	S.CNR		

[MAIN UNIT]

REF NO.	ORDER NO.	DESCRIPTION	M.	H/V LOCATION
EP752	6910014730	S.BEA MPZ2012S331A-T	T	8.9/95.9
EP811	6910014690	S.BEA MPZ1608S221A-T	T	32.2/5.3
EP812	6910014690	S.BEA MPZ1608S221A-T	T	30.8/5.4
EP813	6910014690	S.BEA MPZ1608S221A-T	T	26.2/5.3
EP814	6910012350	S.BEA MMZ1608Y 102BT	T	24.2/5.3
EP815	6910014690	S.BEA MPZ1608S221A-T	T	22.2/5.4
EP816	6910014690	S.BEA MPZ1608S221A-T	T	19.4/16.6
EP842	6910014690	S.BEA MPZ1608S221A-T	T	35/59.6
EP843	6910014690	S.BEA MPZ1608S221A-T	T	35/57.6
EP851	6910012350	S.BEA MMZ1608Y 102BT	B	75.3/71.7
EP852	6910012350	S.BEA MMZ1608Y 102BT	B	75.3/73.5
EP853	6910012350	S.BEA MMZ1608Y 102BT	B	75.3/75.3
EP854	6910014690	S.BEA MPZ1608S221A-T	B	75.3/77.1
EP855	6910012350	S.BEA MMZ1608Y 102BT	B	75.3/80.1
EP941	6910012350	S.BEA MMZ1608Y 102BT	B	10/31
EP942	6910012350	S.BEA MMZ1608Y 102BT	T	4.8/30
EP943	6910012350	S.BEA MMZ1608Y 102BT	B	9.9/29
EP944	6910012350	S.BEA MMZ1608Y 102BT	T	4.8/28
EP954	6910012350	S.BEA MMZ1608Y 102BT	B	10/19.3
EP987	6910012350	S.BEA MMZ1608Y 102BT	T	172.1/39
EP991	6910012350	S.BEA MMZ1608Y 102BT	T	166.1/38
EP992	6910012350	S.BEA MMZ1608Y 102BT	T	166.1/40.6
EP1001	6910014690	S.BEA MPZ1608S221A-T	B	119.2/17
EP1251	6910014690	S.BEA MPZ1608S221A-T	T	112.3/8.1
EP1401	6910014690	S.BEA MPZ1608S221A-T	T	85/31
EP1498	6910014690	S.BEA MPZ1608S221A-T	T	103.6/71.7
EP1651	6910014690	S.BEA MPZ1608S221A-T	B	162.6/11.1
EP1911	6910014690	S.BEA MPZ1608S221A-T	B	120.1/83.4

[PLL UNIT]

REF NO.	ORDER NO.	DESCRIPTION	M.	H/V LOCATION
IC1	1130011530	S.IC CD74HC4094M96	B	151.5/16.9
IC2	1130009691	S.IC TC74HCT7007AF (F)	T	152.7/17.7
IC51	1180001251	S.IC TA7808F (TE16L,Q)	T	164.8/92.2
IC61	1180000421	S.IC TA78L05F (TE12R,F)	B	168.5/68.5
IC101	1190002101	S.IC AD9951YSVZ	T	101.2/27.2
IC102	1130010560	S.IC SN74AHC244PWR	T	113/33
IC103	1180003190	S.REG uPD120N33TA-E1-A	T	111.4/40.1
IC104	1180003200	S.REG uPD120N18TA-E1-A	T	103.2/40.1
IC201	1130013270	S.IC ADF4116BRUZ	T	149.5/36.7
IC501	1140007881	S.IC TC190G08EFG0046JDZ/SC1246A	T	50.1/42.7
IC503	1130003831	S.IC TC7S04F (TE85R,F)	T	38.5/43.1
IC602	1130006441	S.IC TC7S08F (TE85R,F)	T	98.2/50.6
IC651	1140007881	S.IC TC190G08EFG0046JDZ/SC1246A	T	12.7/71
IC652	1130003831	S.IC TC7S04F (TE85R,F)	T	10.2/58.4
IC1651	1130003831	S.IC TC7S04F (TE85R,F)	T	30.7/26.5
IC1652	1140007881	S.IC TC190G08EFG0046JDZ/SC1246A	T	16.7/22.8
IC1701	1130006441	S.IC TC7S08F (TE85R,F)	T	30.4/20.3
Q1	1590001050	S.TR DTC114TUA T106	B	158.2/17.2
Q30	1530002060	S.TR 2SC4081 T106 R	B	74.5/32.1
Q41	1590000680	S.TR DTC114EUA T106	T	142.8/8.9
Q101	1530003151	S.TR 2SC4673D-TD-E	T	89.7/30.3
Q151	1530002060	S.TR 2SC4081 T106 R	B	130.9/43.8
Q201	1590000680	S.TR DTC114EUA T106	T	154.3/38.1
Q220	1560000331	S.FET 2SK210-GR (TE85R,F)	T	150.8/83
Q230	1560000331	S.FET 2SK210-GR (TE85R,F)	T	138.3/83
Q240	1560000331	S.FET 2SK210-GR (TE85R,F)	T	125.8/83
Q250	1560000331	S.FET 2SK210-GR (TE85R,F)	T	113.3/83
Q260	1560000331	S.FET 2SK210-GR (TE85R,F)	T	100.8/83
Q270	1560000331	S.FET 2SK210-GR (TE85R,F)	T	88.9/83
Q280	1590000680	S.TR DTC114EUA T106	T	150.3/92.8
Q281	1590000680	S.TR DTC114EUA T106	T	137.8/92.8
Q282	1590000680	S.TR DTC114EUA T106	T	125.3/92.8
Q283	1590000680	S.TR DTC114EUA T106	T	112.8/92.8
Q284	1590000680	S.TR DTC114EUA T106	T	100.3/92.8
Q285	1590000680	S.TR DTC114EUA T106	T	88.3/92.8
Q301	1530003431	S.TR 2SC5226-4-TL-E	T	154.6/102.6
Q302	1530003431	S.TR 2SC5226-4-TL-E	B	141.5/99.6
Q303	1530003431	S.TR 2SC5226-4-TL-E	B	158/101.7
Q341	1590000680	S.TR DTC114EUA T106	T	148/96.8
Q351	1580000751	S.FET 3SK294 (TE85L,F)	T	127.8/103.2
Q352	1530003431	S.TR 2SC5226-4-TL-E	B	121/99.6
Q441	1590000680	S.TR DTC114EUA T106	T	111/97
Q502	1590000680	S.TR DTC114EUA T106	T	63.3/52.9
Q540	1530002060	S.TR 2SC4081 T106 R	T	57.7/75.9
Q541	1560000331	S.FET 2SK210-GR (TE85R,F)	T	41.1/73.5
Q561	1530003431	S.TR 2SC5226-4-TL-E	T	41.4/82.4
Q580	1530003431	S.TR 2SC5226-4-TL-E	T	45.2/53.1
Q591	1530003151	S.TR 2SC4673D-TD-E	B	64.9/84.2
Q592	1520000561	S.TR 2SB1123 T-TD-E	B	73/87.3
Q593	1590000680	S.TR DTC114EUA T106	B	72.8/97.5
Q680	1530002060	S.TR 2SC4081 T106 R	T	8.5/85.5
Q702	1530002601	S.TR 2SC4215-O (TE85R,F)	B	78.1/38.7
Q801	1560000561	S.FET 2SK882-GR (TE85L,F)	T	61.1/92.1
Q811	1560000561	S.FET 2SK882-GR (TE85L,F)	T	18.3/92.7
Q831	1560000561	S.FET 2SK882-GR (TE85L,F)	T	22.1/102.6
Q832	1520000561	S.TR 2SB1123 T-TD-E	T	53/99.4
Q833	1590000680	S.TR DTC114EUA T106	B	51.7/106.6
Q1601	1530002601	S.TR 2SC4215-O (TE85R,F)	T	80.7/56.2
Q1680	1530002060	S.TR 2SC4081 T106 R	T	15.9/51.6
D201	1750000520	S.DIO DAN222TL	T	144.7/6.6
D205	1790001250	S.DIO MA2S111-(TX)	T	154.3/30.7
D220	1720000590	S.VCP MA357 (TX)	T	152.9/61.3
D221	1720000590	S.VCP MA357 (TX)	T	152.9/63.4
D222	1790000620	S.DIO MA77 (TX)	T	154.9/93.4
D230	1720000590	S.VCP MA357 (TX)	T	140.5/61.3
D231	1720000590	S.VCP MA357 (TX)	T	140.5/63.4
D232	1790000620	S.DIO MA77 (TX)	T	142.5/93.1
D240	1720000590	S.VCP MA357 (TX)	T	128/61.3
D242	1790000620	S.DIO MA77 (TX)	T	129.9/93.4
D250	1720000590	S.VCP MA357 (TX)	T	115.5/61.3
D252	1790000620	S.DIO MA77 (TX)	T	117.4/93.4
D261	1720000590	S.VCP MA357 (TX)	T	103/63.4
D262	1790000620	S.DIO MA77 (TX)	T	104.9/93.4
D263	1720000590	S.VCP MA357 (TX)	T	100.3/62.9
D270	1720000590	S.VCP MA357 (TX)	T	90.5/61.3
D271	1720000590	S.VCP MA357 (TX)	T	88/62.9
D272	1790000620	S.DIO MA77 (TX)	T	92.7/93.4
D341	1790000620	S.DIO MA77 (TX)	T	147.5/100.5
D342	1160000070	S.DIO DAN202K T146	B	136/91.6
D441	1790000620	S.DIO MA77 (TX)	T	110.3/100.1
D501	1750000520	S.DIO DAN222TL	T	60.5/53.4
D542	1720000590	S.VCP MA357 (TX)	T	45.5/62.1
D821	1750000431	S.DIO HSB88WSTR-E	T	43.4/97.3
FI101	2020001820	S.CER SFECV10M5FA00-R0	T	112.2/22.2
FI831	2030000300	S.MLH FL-356 (64.491 MHz)	T	27/103
L1	6200003261	S.COL NLV32T-101J	B	156.6/23.9
L2	6200003261	S.COL NLV32T-101J	T	155.8/24.7
L20	6200003321	S.COL NLV32T-3R3J	T	79.6/102.1
L30	6200005491	S.COL NLV32T-331J	T	73.1/27.7
L101	6200001831	S.COL NLV32T-100J	T	114.6/39.5
L102	6200002641	S.COL NLV25T-R15J	T	90.4/23.4
L103	6140002810	S.COL LR-317 (T	104/15.2
L123	6200004951	S.COL NLV25T-1R8J	T	113.7/16.7
L161	6200001981	S.COL NLV25T-1R0J	B	123.4/35.6
L201	6200005011	S.COL NLV25T-100J	T	143.3/31
L211	6200003661	S.COL NLV25T-R68J	B	153/54.3

M.=Mounted side (T: Mounted on the Top side B: Mounted on the Bottom side)
S.=Surface mount

[PLL UNIT]

REF NO.	ORDER NO.	DESCRIPTION	M.	H/V LOCATION
L220	6200010790	S.COL C2520C-3R9G-A	T	147.2/62.4
L221	6190001421	COL #E526GN-110502		
L222	6200010790	S.COL C2520C-3R9G-A	T	147/86.7
L230	6200010830	S.COL C2520C-3R3G-A	T	134.7/62.4
L231	6190001421	COL #E526GN-110502		
L232	6200010830	S.COL C2520C-3R3G-A	T	134.5/86.7
L240	6200010830	S.COL C2520C-3R3G-A	T	122.3/62.4
L241	6190001421	COL #E526GN-110502		
L242	6200010830	S.COL C2520C-3R3G-A	T	122/86.7
L250	6200010820	S.COL C2520C-2R7G-A	T	109.8/62.4
L251	6190001421	COL #E526GN-110502		
L252	6200010820	S.COL C2520C-2R7G-A	T	109.5/86.7
L260	6200010820	S.COL C2520C-2R7G-A	T	97.3/62.4
L261	6190001411	COL #E526GN-110501		
L262	6200010820	S.COL C2520C-2R7G-A	T	97/86.7
L270	6200010810	S.COL C2520C-2R2G-A	T	84.9/62.4
L271	6190001411	COL #E526GN-110501		
L272	6200010810	S.COL C2520C-2R2G-A	T	85.8/86.6
L280	6200005011	S.COL NLV25T-100J	T	160/74.6
L302	6200001831	S.COL NLV32T-100J	T	142.1/99.8
L331	6200002641	S.COL NLV25T-F15J	T	150.6/105.6
L332	6200002411	S.COL NLV25T-056J	T	149/102.7
L341	6200003261	S.COL NLV32T-101J	T	145.1/97.5
L351	6200001831	S.COL NLV32T-100J	T	122.7/101.8
L441	6200002601	S.COL NLV25T-047J	T	112.4/102.4
L442	6200010730	S.COL C2520C-68NG-A	T	106.5/101
L451	6200002641	S.COL NLV25T-F15J	T	103.7/105.5
L452	6200003261	S.COL NLV32T-101J	T	106.3/97.9
L501	6200001831	S.COL NLV32T-100J	T	66.8/42.4
L530	6200003171	S.COL NLV32T-330J	T	57.7/26
L531	6200003171	S.COL NLV32T-330J	T	61.8/26
L532	6200003171	S.COL NLV32T-330J	T	65.5/26.9
L541	6200010790	S.COL C2520C-3R9G-A	T	46.9/65.3
L542	6190001421	COL #E526GN-110502		
L543	6200010790	S.COL C2520C-3R9G-A	T	39.8/76.6
L544	6200003261	S.COL NLV32T-101J	B	45.2/66.1
L545	6200003261	S.COL NLV32T-101J	B	55.4/78.2
L561	6200003261	S.COL NLV32T-101J	B	76/92
L562	6200001831	S.COL NLV32T-100J	T	51.6/105.4
L565	6150004250	COL LS-471A (C-14922)		
L566	6150004250	COL LS-471A (C-14922)		
L591	6200007790	S.COL LQW2BHN1R15J03L	B	69/81.9
L651	6200001831	S.COL NLV32T-100J	B	4.4/60.7
L681	6200005491	S.COL NLV32T-331J	T	30.2/78.1
L682	6200008641	S.COL NLV32T-391J	T	29.2/81.5
L683	6200008641	S.COL NLV32T-391J	T	18.7/85.7
L701	6200003261	S.COL NLV32T-101J	T	73.1/31.8
L702	6150004971	S.COL LS-522-LF	T	77.2/38.1
L703	6150004971	S.COL LS-522-LF	T	77.2/48.2
L801	6150004280	COL LS-484B (C-14927)		
L812	6200003231	S.COL NLV32T-181J	T	22.8/92.2
L821	6140003530	COL LR-395		
L822	6140003530	COL LR-395		
L831	6140003770	S.COL LR-414 4KBL (STP-01435)	T	34.4/104.5
L834	6150004280	COL LS-484B (C-14927)		
L1601	6200001831	S.COL NLV32T-100J	B	87.4/55.3
L1602	6200002641	S.COL NLV25T-F15J	T	76.9/57.8
L1603	6200002841	S.COL NLV25T-R22J	T	77.2/63.4
L1651	6200001831	S.COL NLV32T-100J	B	29.1/11.5
L1681	6200002981	S.COL NLV32T-R56J	T	12.3/40.5
L1682	6200003041	S.COL NLV32T-R68J	T	8.7/39.7
L1683	6200003051	S.COL NLV32T-R82J	B	21.3/44.1
R1	7030003680	S.RES ERJ3GEYJ 104 V (100 k)	B	160.9/17.1
R2	7030003560	S.RES ERJ3GEYJ 103 V (10 k)	B	158.1/19.4
R3	7030003550	S.RES ERJ3GEYJ 822 V (8.2 k)	T	153.3/10.3
R4	7030003550	S.RES ERJ3GEYJ 822 V (8.2 k)	T	149.3/10.3
R5	7030003550	S.RES ERJ3GEYJ 822 V (8.2 k)	T	148/10.3
R6	7030003550	S.RES ERJ3GEYJ 822 V (8.2 k)	T	146.7/10.3
R7	7030003500	S.RES ERJ3GEYJ 332 V (3.3 k)	B	162.3/22.3
R9	7030003680	S.RES ERJ3GEYJ 104 V (100 k)	B	164.7/23.1
R10	7030003360	S.RES ERJ3GEYJ 221 V (220)	T	160/16.8
R11	7030003360	S.RES ERJ3GEYJ 221 V (220)	T	160/18.1
R13	7030003360	S.RES ERJ3GEYJ 221 V (220)	T	160/20.7
R14	7030003360	S.RES ERJ3GEYJ 221 V (220)	T	160/22
R15	7030003360	S.RES ERJ3GEYJ 221 V (220)	T	160/23.3
R16	7030003360	S.RES ERJ3GEYJ 221 V (220)	T	160/26.1
R17	7030003360	S.RES ERJ3GEYJ 221 V (220)	T	160/28.2
R18	7030003550	S.RES ERJ3GEYJ 822 V (8.2 k)	B	152.8/22.2
R19	7030003550	S.RES ERJ3GEYJ 822 V (8.2 k)	T	152/10.3
R30	7030003240	S.RES ERJ3GEYJ 220 V (22)	B	78/29.7
R31	7030003600	S.RES ERJ3GEYJ 223 V (22 k)	B	74.7/27.9
R32	7030003320	S.RES ERJ3GEYJ 101 V (100)	B	74.7/34.5
R33	7030003340	S.RES ERJ3GEYJ 151 V (150)	B	78/26.1
R51	7030011030	S.RES ERJ1TYJ 270U (27)	T	172.7/91.9
R52	7030010550	S.RES ERJ1TYJ 820U (82)	B	169.5/91.9
R61	7030011030	S.RES ERJ1TYJ 270U (27)	T	169.9/73.2
R101	7030003290	S.RES ERJ3GEYJ 560 V (56)	T	87.5/34.1
R102	7030003360	S.RES ERJ3GEYJ 221 V (220)	T	90.3/34.1
R103	7030003290	S.RES ERJ3GEYJ 560 V (56)	T	94.3/34.1
R104	7030003560	S.RES ERJ3GEYJ 103 V (10 k)	T	93.6/32.1
R105	7030003480	S.RES ERJ3GEYJ 222 V (2.2 k)	T	94.9/32.1
R106	7030003320	S.RES ERJ3GEYJ 101 V (100)	T	91.5/27.1
R107	7030003320	S.RES ERJ3GEYJ 101 V (100)	T	93.6/21.2
R108	7030003440	S.RES ERJ3GEYJ 102 V (1 k)	T	96.6/32
R109	7030003440	S.RES ERJ3GEYJ 102 V (1 k)	T	101.8/34.1
R110	7030003440	S.RES ERJ3GEYJ 102 V (1 k)	T	103.1/34.1
R111	7030003440	S.RES ERJ3GEYJ 102 V (1 k)	T	104.4/34.1
R112	7030003440	S.RES ERJ3GEYJ 102 V (1 k)	T	107.4/31.1
R113	7030003510	S.RES ERJ3GEYJ 392 V (3.9 k)	T	105.1/21.4
R114	7030003320	S.RES ERJ3GEYJ 101 V (100)	B	103.5/22.6
R115	7030003320	S.RES ERJ3GEYJ 101 V (100)	B	101.3/22.6
R131	7030003320	S.RES ERJ3GEYJ 101 V (100)	T	114.3/27.9

[PLL UNIT]

REF NO.	ORDER NO.	DESCRIPTION	M.	H/V LOCATION
R132	7030003410	S.RES ERJ3GEYJ 561 V (560)	T	111.5/27.9
R133	7030003320	S.RES ERJ3GEYJ 101 V (100)	T	111.5/26.6
R138	7030003860	S.RES ERJ3GE JPW V	T	108.7/15.1
R159	7030003200	S.RES ERJ3GEYJ 100 V (10)	B	126.4/43.2
R160	7030003370	S.RES ERJ3GEYJ 271 V (270)	B	128.2/43.2
R161	7030003640	S.RES ERJ3GEYJ 473 V (47 k)	B	133.6/43.2
R201	7030003520	S.RES ERJ3GEYJ 472 V (4.7 k)	T	154.4/40
R202	7030003440	S.RES ERJ3GEYJ 102 V (1 k)	B	146.8/30
R203	7030003440	S.RES ERJ3GEYJ 102 V (1 k)	B	148.8/30
R204	7030003360	S.RES ERJ3GEYJ 221 V (220)	B	150.4/30
R205	7030003560	S.RES ERJ3GEYJ 103 V (10 k)	T	154.3/32
R206	7030003860	S.RES ERJ3GE JPW V	T	142.6/39.9
R210	7030003860	S.RES ERJ3GE JPW V	T	150.8/46
R217	7030009861	S.RES ERA3YED 471V (470)	B	147.3/49.2
R219	7030009861	S.RES ERA3YED 471V (470)	B	152.6/48.9
R220	7030003680	S.RES ERJ3GEYJ 104 V (100 k)	T	147.1/83.7
R221	7030003680	S.RES ERJ3GEYJ 104 V (100 k)	T	153.8/82.8
R222	7030003360	S.RES ERJ3GEYJ 221 V (220)	T	146.4/92.4
R223	7030003440	S.RES ERJ3GEYJ 102 V (1 k)	T	152.8/92.4
R224	7030003320	S.RES ERJ3GEYJ 101 V (100)	T	144.5/83.7
R230	7030003680	S.RES ERJ3GEYJ 104 V (100 k)	T	134.6/83.7
R231	7030003680	S.RES ERJ3GEYJ 104 V (100 k)	T	141.4/82.8
R232	7030003360	S.RES ERJ3GEYJ 221 V (220)	T	133.9/92.4
R233	7030003440	S.RES ERJ3GEYJ 102 V (1 k)	T	140.3/92.4
R234	7030003320	S.RES ERJ3GEYJ 101 V (100)	T	132/83.7
R240	7030003680	S.RES ERJ3GEYJ 104 V (100 k)	T	122.1/83.7
R241	7030003680	S.RES ERJ3GEYJ 104 V (100 k)	T	128.9/82.8
R242	7030003360	S.RES ERJ3GEYJ 221 V (220)	T	121.4/92.4
R243	7030003440	S.RES ERJ3GEYJ 102 V (1 k)	T	127.8/92.4
R244	7030003320	S.RES ERJ3GEYJ 101 V (100)	T	119.5/83.7
R250	7030003680	S.RES ERJ3GEYJ 104 V (100 k)	T	109.6/83.7
R251	7030003680	S.RES ERJ3GEYJ 104 V (100 k)	T	116.3/82.8
R252	7030003360	S.RES ERJ3GEYJ 221 V (220)	T	108.9/92.4
R253	7030003440	S.RES ERJ3GEYJ 102 V (1 k)	T	115.3/92.4
R254	7030003320	S.RES ERJ3GEYJ 101 V (100)	T	107/83.7
R260	7030003680	S.RES ERJ3GEYJ 104 V (100 k)	T	97.1/83.7
R261	7030003680	S.RES ERJ3GEYJ 104 V (100 k)	T	103.8/82.8
R262	7030003360	S.RES ERJ3GEYJ 221 V (220)	T	96.4/92.4
R263	7030003440	S.RES ERJ3GEYJ 102 V (1 k)	T	102.8/92.4
R264	7030003320	S.RES ERJ3GEYJ 101 V (100)	T	94.5/83.7
R270	7030003680	S.RES ERJ3GEYJ 104 V (100 k)	T	85.2/83.5
R271	7030003680	S.RES ERJ3GEYJ 104 V (100 k)	T	91.9/82.8
R272	7030003360	S.RES ERJ3GEYJ 221 V (220)	T	83.9/93.4
R273	7030003440	S.RES ERJ3GEYJ 102 V (1 k)	T	90.8/92.4
R274	7030003320	S.RES ERJ3GEYJ 101 V (100)	T	82.6/83.7
R281	7030003440	S.RES ERJ3GEYJ 102 V (1 k)	B	76.1/68.8
R282	7030003440	S.RES ERJ3GEYJ 102 V (1 k)	B	73/67.9
R283	7030003440	S.RES ERJ3GEYJ 102 V (1 k)	B	76.1/67
R284	7030003440	S.RES ERJ3GEYJ 102 V (1 k)	B	73/66.1
R285	7030003440	S.RES ERJ3GEYJ 102 V (1 k)	B	76.1/65.2
R286	7030003440	S.RES ERJ3GEYJ 102 V (1 k)	B	73/64.3
R301	7030003200	S.RES ERJ3GEYJ 100 V (10)	T	154.1/97
R302	7030003440	S.RES ERJ3GEYJ 102 V (1 k)	T	155.4/97
R303	7030003360	S.RES ERJ3GEYJ 221 V (220)	T	156.7/102.6
R304	7030003490	S.RES ERJ3GEYJ 272 V (2.7 k)	T	154.6/104.5
R305	7030003510	S.RES ERJ3GEYJ 392 V (3.9 k)	T	154.6/105.8
R306	7030003360	S.RES ERJ3GEYJ 221 V (220)	T	152.5/105.2
R307	7030003260	S.RES ERJ3GEYJ 330 V (33)	T	152.5/102.6
R308	7030003370	S.RES ERJ3GEYJ 271 V (270)	B	141.2/102.1
R309	7030003540	S.RES ERJ3GEYJ 682 V (6.8 k)	B	136.2/99.6
R310	7030003500	S.RES ERJ3GEYJ 332 V (3.3 k)	B	136.6/101.9
R311	7030003350	S.RES ERJ3GEYJ 181 V (180)	B	138.1/98.8
R312	7030003360	S.RES ERJ3GEYJ 221 V (220)	B	155.4/102.9
R313	7030003490	S.RES ERJ3GEYJ 272 V (2.7 k)	B	160.4/101.6
R314	7030003510	S.RES ERJ3GEYJ 392 V (3.9 k)	B	160.4/98.9
R315	7030003360	S.RES ERJ3GEYJ 221 V (220)	B	158.2/98.1
R316	7030003280	S.RES ERJ3GEYJ 470 V (47)	B	159.3/85.5
R317	7030006220	S.RES ERJ12YJ470U (47)	B	151.2/100.5
R318	7030003260	S.RES ERJ3GEYJ 330 V (33)	B	144.1/102.1
R341	7030003440	S.RES ERJ3GEYJ 102 V (1 k)	T	144.6/102.6
R342	7030003560	S.RES ERJ3GEYJ 103 V (10 k)	T	152.5/97
R343	7030003440	S.RES ERJ3GEYJ 102 V (1 k)	T	149.9/99.8
R351	7030003200	S.RES ERJ3GEYJ 100 V (10)	B	131.2/101.1
R352	7030003280	S.RES ERJ3GEYJ 470 V (47)	T	128.9/99.8
R353	7030003520	S.RES ERJ3GEYJ 472 V (4.7 k)	T	130.2/99.8
R354	7030003520	S.RES ERJ3GEYJ 472 V (4.7 k)	T	134.3/99.8
R355	7030003520	S.RES ERJ3GEYJ 472 V (4.7 k)	T	131.5/99.8
R356	7030003320	S.RES ERJ3GEYJ 101 V (100)	T	127.6/99.8
R357	7310005390	S.TRI EVM-3V5X50 BQ3 (472)	T	132/104.1
R358	7030003280	S.RES ERJ3GEYJ 470 V (47)	T	128.2/105.7
R359	7030003320	S.RES ERJ3GEYJ 101 V (100)	T	125.6/105.7
R360	7030003320	S.RES ERJ3GEYJ 101 V (100)	B	121/103.1
R361				

[PLL UNIT]

REF NO.	ORDER NO.	DESCRIPTION	M.	H/V LOCATION
R544	7030003680	S.RES ERJ3GEYJ 104 V (100 k)	T	41.3/71.2
R545	7030003680	S.RES ERJ3GEYJ 104 V (100 k)	T	41.3/69.9
R546	7030003400	S.RES ERJ3GEYJ 471 V (470)	T	38.4/79.4
R548	7030009591	S.RES ERA3YED 472V (4.7 k)	T	56.6/64.4
R550	7030009691	S.RES ERA3YED 101V (100)	T	55.3/64.4
R554	7030009891	S.RES ERA3YED 151V (150)	T	52.5/65.1
R555	7030003380	S.RES ERJ3GEYJ 331 V (330)	T	60.1/775
R556	7030006561	S.RES ERA3YED 223V (22 k)	T	49.8/62.3
R561	7030003200	S.RES ERJ3GEYJ 100 V (10)	T	43.5/78.5
R562	7030003360	S.RES ERJ3GEYJ 221 V (220)	B	45.5/81.5
R563	7030003490	S.RES ERJ3GEYJ 272 V (2.7 k)	T	41.5/80.5
R564	7030003510	S.RES ERJ3GEYJ 392 V (3.9 k)	T	41.5/79.2
R565	7030003360	S.RES ERJ3GEYJ 221 V (220)	T	39.2/83.6
R570	7030003230	S.RES ERJ3GEYJ 180 V (18)	T	45.6/81.8
R571	7030003230	S.RES ERJ3GEYJ 180 V (18)	T	46.4/79.9
R572	7030003290	S.RES ERJ3GEYJ 560 V (56)	T	48.2/79.2
R573	7030003260	S.RES ERJ3GEYJ 330 V (33)	T	48.2/81.8
R574	7030003300	S.RES ERJ3GEYJ 680 V (68)	T	50.1/79.9
R575	7030003220	S.RES ERJ3GEYJ 150 V (15)	T	50.1/82.5
R580	7030003380	S.RES ERJ3GEYJ 331 V (330)	T	38.9/53.3
R581	7030003360	S.RES ERJ3GEYJ 221 V (220)	T	47.1/53.3
R582	7030003600	S.RES ERJ3GEYJ 223 V (22 k)	T	43.1/53.3
R583	7030000010	S.RES MCR10EZHZ JPW (000)	B	56.1/39.6
R584	7030000010	S.RES MCR10EZHZ JPW (000)	B	56/47.4
R587	7030003370	S.RES ERJ3GEYJ 271 V (270)	B	57/81.8
R588	7030003230	S.RES ERJ3GEYJ 180 V (18)	B	59.6/83.3
R589	7030003370	S.RES ERJ3GEYJ 271 V (270)	B	60.6/88.6
R591	7030003320	S.RES ERJ3GEYJ 101 V (100)	B	70.4/79.7
R592	7030003560	S.RES ERJ3GEYJ 103 V (10 k)	B	61.7/83.4
R593	7030003480	S.RES ERJ3GEYJ 222 V (2.2 k)	B	62.4/88.6
R594	7030003320	S.RES ERJ3GEYJ 101 V (100)	B	69/85.9
R595	7030003640	S.RES ERJ3GEYJ 473 V (47 k)	B	71.9/91.2
R596	7030003540	S.RES ERJ3GEYJ 682 V (6.8 k)	B	72.8/94
R603	7030003480	S.RES ERJ3GEYJ 222 V (2.2 k)	T	101.6/49.5
R604	7030003440	S.RES ERJ3GEYJ 102 V (1 k)	T	94.9/50.6
R605	7030003320	S.RES ERJ3GEYJ 101 V (100)	B	103.5/47.3
R651	7030003440	S.RES ERJ3GEYJ 102 V (1 k)	B	12.5/81.9
R652	7030003360	S.RES ERJ3GEYJ 221 V (220)	B	12.9/58.3
R653	7030003440	S.RES ERJ3GEYJ 102 V (1 k)	B	14.7/58.3
R654	7030003440	S.RES ERJ3GEYJ 102 V (1 k)	B	16.5/58.3
R655	7030007220	S.RES ERA3YED 202V (2 k)	T	30.1/58.6
R656	7030003800	S.RES ERJ3GEYJ 105 V (1 M)	T	12.5/58.8
R657	7030003400	S.RES ERJ3GEYJ 471 V (470)	T	17.5/58.1
R658	7030007220	S.RES ERA3YED 202V (2 k)	T	27.5/58.6
R659	7030007220	S.RES ERA3YED 202V (2 k)	T	27.5/59.9
R660	7030007230	S.RES ERA3YED 102V (1 k)	T	30.1/59.9
R661	7030007220	S.RES ERA3YED 202V (2 k)	T	27.5/61.2
R662	7030007230	S.RES ERA3YED 102V (1 k)	T	30.1/61.2
R663	7030007220	S.RES ERA3YED 202V (2 k)	T	27.5/62.5
R664	7030007230	S.RES ERA3YED 102V (1 k)	T	30.1/62.5
R665	7030007220	S.RES ERA3YED 202V (2 k)	T	27.5/63.8
R666	7030007230	S.RES ERA3YED 102V (1 k)	T	30.1/63.8
R667	7030007220	S.RES ERA3YED 202V (2 k)	T	27.5/65.1
R668	7030007230	S.RES ERA3YED 102V (1 k)	T	30.1/65.1
R669	7030007220	S.RES ERA3YED 202V (2 k)	T	27.5/66.4
R670	7030007230	S.RES ERA3YED 102V (1 k)	T	30.1/66.4
R671	7030007200	S.RES ERA3YED 202V (2 k)	T	27.5/67.7
R672	7030007210	S.RES ERA3YEB 102V (1 k)	T	30.1/67.7
R673	7030007200	S.RES ERA3YEB 202V (2 k)	T	27.5/70.3
R674	7030007210	S.RES ERA3YEB 102V (1 k)	T	30.1/70.3
R675	7030007200	S.RES ERA3YEB 202V (2 k)	T	27.5/71.6
R676	7030007210	S.RES ERA3YEB 102V (1 k)	T	30.1/71.6
R677	7030007200	S.RES ERA3YEB 202V (2 k)	T	27.5/72.9
R678	7030007210	S.RES ERA3YEB 102V (1 k)	T	30.1/72.9
R679	7030007200	S.RES ERA3YEB 202V (2 k)	T	27.5/74.2
R680	7030007210	S.RES ERA3YEB 102V (1 k)	T	30.1/74.2
R682	7030003860	S.RES ERJ3GE JPW V	B	74/100.9
R685	7030003460	S.RES ERJ3GEYJ 152 V (1.5 k)	T	16.1/85.4
R686	7030003320	S.RES ERJ3GEYJ 101 V (100)	T	4.5/83.5
R687	7030003470	S.RES ERJ3GEYJ 182 V (1.8 k)	T	8.7/83.5
R688	7030003480	S.RES ERJ3GEYJ 222 V (2.2 k)	T	11.3/84.8
R689	7030003360	S.RES ERJ3GEYJ 221 V (220)	T	11.3/86.1
R690	7030003370	S.RES ERJ3GEYJ 271 V (270)	T	2.6/91.7
R691	7030003230	S.RES ERJ3GEYJ 180 V (18)	T	4.5/92.4
R692	7030003370	S.RES ERJ3GEYJ 271 V (270)	T	2.6/93.2
R693	7030003500	S.RES ERJ3GEYJ 332 V (3.3 k)	T	15.4/83.5
R704	7030003260	S.RES ERJ3GEYJ 330 V (33)	T	72.7/37.3
R705	7030003600	S.RES ERJ3GEYJ 223 V (22 k)	B	78/36.3
R706	7030003560	S.RES ERJ3GEYJ 103 V (10 k)	B	78/32.7
R707	7030003400	S.RES ERJ3GEYJ 471 V (470)	B	78/41.1
R708	7030003410	S.RES ERJ3GEYJ 561 V (560)	T	82.4/47.6
R709	7030007860	S.RES ERJ3GEYJ 8R2V (8.2)	T	83.2/49.6
R710	7030003410	S.RES ERJ3GEYJ 561 V (560)	T	83.2/45.5
R711	7030003400	S.RES ERJ3GEYJ 471 V (470)	T	38.9/50.1
R712	7030000010	S.RES MCR10EZHZ JPW (000)	T	73.3/52.1
R802	7030003400	S.RES ERJ3GEYJ 471 V (470)	T	59.6/87.3
R803	7030003560	S.RES ERJ3GEYJ 103 V (10 k)	T	59.6/88.6
R804	7030003320	S.RES ERJ3GEYJ 101 V (100)	B	58.7/90.5
R805	7030003370	S.RES ERJ3GEYJ 271 V (270)	B	50.6/91
R806	7030003230	S.RES ERJ3GEYJ 180 V (18)	B	48/91.7
R807	7030003370	S.RES ERJ3GEYJ 271 V (270)	B	44.8/91.7
R812	7030003440	S.RES ERJ3GEYJ 102 V (1 k)	T	14.1/93.6
R814	7030003560	S.RES ERJ3GEYJ 103 V (10 k)	T	16.4/92.9
R815	7030003320	S.RES ERJ3GEYJ 101 V (100)	B	23.3/90.6
R831	7030003320	S.RES ERJ3GEYJ 101 V (100)	B	37.2/103.9
R832	7030003300	S.RES ERJ3GEYJ 680 V (68)	B	38.3/101.3
R833	7030003320	S.RES ERJ3GEYJ 101 V (100)	B	39/103.9
R834	7030003380	S.RES ERJ3GEYJ 331 V (330)	T	22.7/99.8
R835	7030003320	S.RES ERJ3GEYJ 101 V (100)	T	22.7/97
R836	7030003300	S.RES ERJ3GEYJ 680 V (68)	B	15.3/99.8
R837	7030003330	S.RES ERJ3GEYJ 121 V (120)	B	13.4/100.6
R838	7030003300	S.RES ERJ3GEYJ 680 V (68)	B	12.6/98.7
R839	7030003560	S.RES ERJ3GEYJ 103 V (10 k)	T	52.3/102.7
R840	7030003540	S.RES ERJ3GEYJ 682 V (6.8 k)	B	51.7/103.4

[PLL UNIT]

REF NO.	ORDER NO.	DESCRIPTION	M.	H/V LOCATION
R1601	7030003370	S.RES ERJ3GEYJ 271 V (270)	B	81.5/55.3
R1602	7030003470	S.RES ERJ3GEYJ 182 V (1.8 k)	T	82.6/56.4
R1606	7030003360	S.RES ERJ3GEYJ 221 V (220)	T	82.6/53.6
R1607	7030003480	S.RES ERJ3GEYJ 222 V (2.2 k)	T	85.2/56.4
R1608	7030003440	S.RES ERJ3GEYJ 102 V (1 k)	T	78.5/54.6
R1651	7030003400	S.RES ERJ3GEYJ 471 V (470)	T	30.2/30.5
R1652	7030003800	S.RES ERJ3GEYJ 105 V (1 M)	T	28.3/26.6
R1653	7030003360	S.RES ERJ3GEYJ 221 V (220)	B	28.9/23.6
R1654	7030003440	S.RES ERJ3GEYJ 102 V (1 k)	B	28.9/25.2
R1655	7030003440	S.RES ERJ3GEYJ 102 V (1 k)	B	28.9/26.8
R1656	7030007220	S.RES ERA3YED 202V (2 k)	T	30.5/40.4
R1657	7030007220	S.RES ERA3YED 202V (2 k)	T	30.5/37.8
R1658	7030007220	S.RES ERA3YED 202V (2 k)	T	29.2/37.8
R1659	7030007230	S.RES ERA3YED 102V (1 k)	T	29.2/40.4
R1660	7030007220	S.RES ERA3YED 202V (2 k)	T	27.9/37.8
R1661	7030007230	S.RES ERA3YED 102V (1 k)	T	27.9/40.4
R1662	7030007220	S.RES ERA3YED 202V (2 k)	T	26.6/37.8
R1663	7030007230	S.RES ERA3YED 102V (1 k)	T	26.6/40.4
R1664	7030007220	S.RES ERA3YED 202V (2 k)	T	25.3/37.8
R1665	7030007230	S.RES ERA3YED 102V (1 k)	T	25.3/40.4
R1666	7030007220	S.RES ERA3YED 202V (2 k)	T	24.3/37.8
R1667	7030007230	S.RES ERA3YED 102V (1 k)	T	24.4/40.4
R1668	7030007220	S.RES ERA3YED 202V (2 k)	T	22.7/37.8
R1669	7030007230	S.RES ERA3YED 102V (1 k)	T	22.7/40.4
R1670	7030007200	S.RES ERA3YEB 202V (2 k)	T	21.4/37.8
R1671	7030007210	S.RES ERA3YEB 102V (1 k)	T	21.4/40.4
R1672	7030007200	S.RES ERA3YEB 202V (2 k)	T	18.8/37.8
R1673	7030007210	S.RES ERA3YEB 102V (1 k)	T	20.1/40.4
R1674	7030007200	S.RES ERA3YEB 202V (2 k)	T	17.5/37.8
R1675	7030007210	S.RES ERA3YEB 102V (1 k)	T	18.8/40.4
R1676	7030007200	S.RES ERA3YEB 202V (2 k)	T	16.2/37.8
R1677	7030007210	S.RES ERA3YEB 102V (1 k)	T	17.5/40.4
R1678	7030007200	S.RES ERA3YEB 202V (2 k)	T	14.9/37.8
R1679	7030007210	S.RES ERA3YEB 102V (1 k)	T	16.2/40.4
R1680	7030003440	S.RES ERJ3GEYJ 102 V (1 k)	T	5.4/27.9
R1685	7030003460	S.RES ERJ3GEYJ 152 V (1.5 k)	T	20.6/47.8
R1686	7030003320	S.RES ERJ3GEYJ 101 V (100)	T	17.1/48.6
R1687	7030003470	S.RES ERJ3GEYJ 182 V (1.8 k)	T	17.8/51.5
R1688	7030003480	S.RES ERJ3GEYJ 222 V (2.2 k)	T	19.1/50.4
R1689	7030003360	S.RES ERJ3GEYJ 221 V (220)	T	15/46.8
R1690	7030003370	S.RES ERJ3GEYJ 271 V (270)	T	13.5/46.8
R1691	7030003230	S.RES ERJ3GEYJ 180 V (18)	T	12.8/49.9
R1692	7030003370	S.RES ERJ3GEYJ 271 V (270)	T	12/48.1
R1693	7030003360	S.RES ERJ3GEYJ 221 V (220)	T	20.6/50.4
R1694	7030003360	S.RES ERJ3GEYJ 221 V (220)	T	29/23.4
R1703	7030003440	S.RES ERJ3GEYJ 102 V (1 k)	B	30.9/18.6
R1705	7030003860	S.RES ERJ3GE JPW V	T	28.1/19.2
R1706	7030003860	S.RES ERJ3GE JPW V	T	6.1/17.4
R1707	7030003860	S.RES ERJ3GE JPW V	T	6.1/18.7
R1708	7030003360	S.RES ERJ3GEYJ 221 V (220)	B	12.1/11.8
C2	4030006880	S.CER C1608 JB 1H 472K-T	T	148.9/23.7
C3	4030011600	S.CER C1608 JB 1E 104K-T	B	153.2/23.9
C14	4030006880	S.CER C1608 JB 1H 472K-T	T	164/43.9
C15	4030006880	S.CER C1608 JB 1H 472K-T	T	172.3/26
C16	4030006880	S.CER C1608 JB 1H 472K-T	T	172.3/28
C17	4030006880	S.CER C1608 JB 1H 472K-T	T	172.3/16.8
C18	4030006880	S.CER C1608 JB 1H 472K-T	T	172.3/18.1
C19	4030006880	S.CER C1608 JB 1H 472K-T	T	173.6/39
C20	4030006880	S.CER C1608 JB 1H 472K-T	T	72.8/106.7
C21	4030006880	S.CER C1608 JB 1H 472K-T	T	74.1/106.7
C22	4030006880	S.CER C1608 JB 1H 472K-T	T	75.4/106.7
C30	4030011600	S.CER C1608 JB 1E 104K-T	B	74.7/26.1
C31	4030011600	S.CER C1608 JB 1E 104K-T	B	74.7/29.7
C32	4030011600	S.CER C1608 JB 1E 104K-T	B	78/34.5
C51	4510008520	S.ELE EEE1CA470SP	T	170.5/101.2
C52	4030011600	S.CER C1608 JB 1E 104K-T	T	165.9/99.2
C53	4030011600	S.CER C1608 JB 1E 104K-T	T	163.3/99.2
C54	4510008500	S.ELE EEE1CA101WP	T	162.5/103.9
C61	4510008520	S.ELE EEE1CA470SP	T	164.1/62
C62	4030011600	S.CER C1608 JB 1E 104K-T	B	167.2/64.3
C63	4030011600	S.CER C1608 JB 1E 104K-T	B	169.8/64.3
C64	4510008500	S.ELE EEE1CA101WP	T	171.2/62
C101	4030006880	S.CER C1608 JB 1H 472K-T	T	92.3/33.4
C102	4030006880	S.CER C1608 JB 1H 472K-T	T	91.5/25.8
C103	4030007110	S.CER C1608 CH 1H 680J-T	T	92.3/33.4
C104	4030007070	S.CER C1608 CH 1H 330J-T	T	94.3/24.5
C105	4030006880	S.CER C1608 JB 1H 472K-T	T	94.3/23.2
C106				

[PLL UNIT]

REF NO.	ORDER NO.	DESCRIPTION	M.	H/V LOCATION
C202	4510009280	S.ELE EEE1EA4R7SR	T	144.3/35.3
C203	4030006900	S.CER C1608 JB 1H 103K-T	T	150/41.3
C204	4030006880	S.CER C1608 JB 1H 472K-T	T	153/34.2
C205	4030006880	S.CER C1608 JB 1H 472K-T	T	154.3/34.2
C206	4030006880	S.CER C1608 JB 1H 472K-T	T	145.3/39.9
C207	4030007030	S.CER C1608 CH 1H 150J-T	B	155.9/56.4
C208	4030007030	S.CER C1608 CH 1H 150J-T	T	147.3/41.3
C209	4030011340	S.CER C1608 CH 1H 471J-T	T	157.2/57
C210	4550000510	S.TAN TEESVA 1V 473M8R	T	159/58.8
C211	4550002960	S.TAN TEESVA 1C 155M8R	B	146.7/55.4
C212	4030011810	S.CER C1608 JB 1A 224K-T	T	154.3/36.2
C219	4550000510	S.TAN TEESVA 1V 473M8R	T	150/44.3
C220	4030007130	S.CER C1608 CH 1H 101J-T	T	147.1/65.2
C221	4030009520	S.CER C1608 CH 1H 020B-T	T	152.7/65.2
C222	4610001830	S.TRI TZB4S100AB10R00	T	152.1/78.6
C223	4030007080	S.CER C1608 CH 1H 390J-T	T	148.4/83.7
C224	4030009920	S.CER C1608 CH 1H 050B-T	T	145.8/83.7
C225	4030007020	S.CER C1608 CH 1H 120J-T	T	153.8/84.1
C226	4030006880	S.CER C1608 JB 1H 472K-T	T	153.8/81.5
C227	4030009920	S.CER C1608 CH 1H 050B-T	T	152.1/85.6
C228	4550006250	S.TAN TEESVA 1A 106M8R	T	146.9/79.3
C229	4030006990	S.CER C1608 CH 1H 080D-T	T	152.1/88.3
C230	4030007070	S.CER C1608 CH 1H 330J-T	T	134.7/65.2
C232	4610001830	S.TRI TZB4S100AB10R00	T	139.6/78.6
C233	4030007070	S.CER C1608 CH 1H 330J-T	T	135.9/83.7
C234	4030009920	S.CER C1608 CH 1H 050B-T	T	133.3/83.7
C235	4030009920	S.CER C1608 CH 1H 050B-T	T	141.4/84.1
C236	4030006880	S.CER C1608 JB 1H 472K-T	T	141.4/81.5
C237	4030009520	S.CER C1608 CH 1H 020B-T	T	139.7/85.6
C238	4550006250	S.TAN TEESVA 1A 106M8R	T	134.4/79.3
C239	4030009910	S.CER C1608 CH 1H 040B-T	T	139.7/88.3
C240	4030007100	S.CER C1608 CH 1H 560J-T	T	122.2/65.2
C241	4030009520	S.CER C1608 CH 1H 020B-T	T	127.6/65.2
C242	4610001830	S.TRI TZB4S100AB10R00	T	127.1/78.6
C243	4030007070	S.CER C1608 CH 1H 330J-T	T	123.4/83.7
C244	4030009520	S.CER C1608 CH 1H 020B-T	T	120.8/83.7
C245	4030011770	S.CER C1608 CH 1H 060B-T	T	128.9/84.1
C246	4030006880	S.CER C1608 JB 1H 472K-T	T	128.8/81.5
C247	4030007040	S.CER C1608 CH 1H 180J-T	T	127.2/85.6
C248	4550006250	S.TAN TEESVA 1A 106M8R	T	121.8/79.3
C250	4030007100	S.CER C1608 CH 1H 560J-T	T	109.7/65.2
C252	4610001860	S.TRI TZB4Z060AB10R00	T	114.6/78.6
C253	4030007080	S.CER C1608 CH 1H 390J-T	T	110.9/83.7
C254	4030009530	S.CER C1608 CH 1H 030B-T	T	108.3/83.7
C255	4030006980	S.CER C1608 CH 1H 070D-T	T	116.3/84.1
C256	4030006880	S.CER C1608 JB 1H 472K-T	T	116.3/81.5
C257	4030007050	S.CER C1608 CH 1H 220J-T	T	114.7/85.6
C258	4550006250	S.TAN TEESVA 1A 106M8R	T	109.3/79.3
C259	4030006880	S.CER C1608 JB 1H 472K-T	T	160.4/51.7
C260	4030007090	S.CER C1608 CH 1H 470J-T	T	97.2/65.2
C262	4610001860	S.TRI TZB4Z060AB10R00	T	102.1/78.6
C263	4030007080	S.CER C1608 CH 1H 390J-T	T	98.4/83.7
C264	4030009530	S.CER C1608 CH 1H 030B-T	T	95.8/83.7
C265	4030006980	S.CER C1608 CH 1H 070D-T	T	103.8/84.1
C266	4030006880	S.CER C1608 JB 1H 472K-T	T	103.8/81.5
C267	4030007050	S.CER C1608 CH 1H 220J-T	T	102.2/85.6
C268	4550006250	S.TAN TEESVA 1A 106M8R	T	96.8/79.3
C272	4610001860	S.TRI TZB4Z060AB10R00	T	89.6/78.6
C273	4030007050	S.CER C1608 CH 1H 220J-T	T	86.5/83.5
C274	4030009530	S.CER C1608 CH 1H 030B-T	T	83.9/83.5
C275	4030009530	S.CER C1608 CH 1H 030B-T	T	91.9/84.1
C276	4030006880	S.CER C1608 JB 1H 472K-T	T	91.9/81.5
C277	4030007050	S.CER C1608 CH 1H 220J-T	T	89.7/85.6
C278	4550006250	S.TAN TEESVA 1A 106M8R	T	84.3/79.3
C283	4030017810	S.CER C1608 CH 1H 102J-T	T	148.4/92.6
C284	4030006880	S.CER C1608 JB 1H 472K-T	T	150.4/95
C285	4030017810	S.CER C1608 CH 1H 102J-T	T	135.9/92.6
C286	4030006880	S.CER C1608 JB 1H 472K-T	T	137.8/95
C287	4030017810	S.CER C1608 CH 1H 102J-T	T	123.4/92.6
C288	4030006880	S.CER C1608 JB 1H 472K-T	T	127.2/94.4
C289	4030017810	S.CER C1608 CH 1H 102J-T	T	110.9/92.6
C290	4030006880	S.CER C1608 JB 1H 472K-T	T	114.3/94.8
C291	4030017810	S.CER C1608 CH 1H 102J-T	T	98.4/92.6
C292	4030006880	S.CER C1608 JB 1H 472K-T	T	100.3/94.9
C293	4030017810	S.CER C1608 CH 1H 102J-T	T	86.9/92.6
C294	4030006880	S.CER C1608 JB 1H 472K-T	T	90.8/93.7
C296	4030007060	S.CER C1608 CH 1H 270J-T	T	137.7/63.1
C301	4030006880	S.CER C1608 JB 1H 472K-T	T	153.8/99.8
C302	4030006880	S.CER C1608 JB 1H 472K-T	T	156.7/105.4
C303	4030006880	S.CER C1608 JB 1H 472K-T	B	147.2/102.1
C304	4030006880	S.CER C1608 JB 1H 472K-T	B	138.7/101.2
C305	4030006880	S.CER C1608 JB 1H 472K-T	B	134.4/99.6
C306	4030006880	S.CER C1608 JB 1H 472K-T	B	132.6/99.6
C308	4030006880	S.CER C1608 JB 1H 472K-T	T	156.2/99.1
C309	4030017810	S.CER C1608 CH 1H 102J-T	T	142/105.4
C310	4030011600	S.CER C1608 JB 1E 104K-T	T	142.6/103.3
C311	4510008520	S.ELE EEE1CA470SP	T	137.3/103.9
C312	4030006880	S.CER C1608 JB 1H 472K-T	B	155/98.3
C313	4030006880	S.CER C1608 JB 1H 472K-T	B	160.4/104.2
C314	4030006880	S.CER C1608 JB 1H 472K-T	B	161.1/95.7
C331	4030007110	S.CER C1608 CH 1H 680J-T	T	152.5/99.8
C332	4030007160	S.CER C1608 CH 1H 181J-T	T	151.2/102.6
C333	4030007110	S.CER C1608 CH 1H 680J-T	T	151.2/99.8
C334	4030007050	S.CER C1608 CH 1H 220J-T	T	148.7/105.4
C335	4030006980	S.CER C1608 CH 1H 070D-T	T	147.3/105.4
C336	4030007030	S.CER C1608 CH 1H 150J-T	T	146.7/102.6
C337	4030007050	S.CER C1608 CH 1H 220J-T	T	145.9/105.4
C341	4030006880	S.CER C1608 JB 1H 472K-T	T	144.6/105.4
C342	4030006880	S.CER C1608 JB 1H 472K-T	T	151.2/97
C344	4030011600	S.CER C1608 JB 1E 104K-T	T	143.3/105.4
C351	4030017810	S.CER C1608 CH 1H 102J-T	T	123.5/105.4
C352	4030011600	S.CER C1608 JB 1E 104K-T	T	122.2/105.4
C353	4510008520	S.ELE EEE1CA470SP	T	117.6/103.9
C354	4030006880	S.CER C1608 JB 1H 472K-T	T	133/99.8

[PLL UNIT]

REF NO.	ORDER NO.	DESCRIPTION	M.	H/V LOCATION
C355	4030006880	S.CER C1608 JB 1H 472K-T	T	129.5/105.7
C356	4030006880	S.CER C1608 JB 1H 472K-T	T	126.3/99.7
C357	4030006880	S.CER C1608 JB 1H 472K-T	T	126.9/105.7
C358	4030006880	S.CER C1608 JB 1H 472K-T	B	126/100.5
C359	4030006880	S.CER C1608 JB 1H 472K-T	B	122.8/103.1
C360	4030006880	S.CER C1608 JB 1H 472K-T	B	117.1/100.1
C361	4030006880	S.CER C1608 JB 1H 472K-T	T	100.5/100.5
C441	4030007040	S.CER C1608 CH 1H 180J-T	T	113.4/105.4
C442	4030007040	S.CER C1608 CH 1H 180J-T	T	112.1/105.4
C443	4030007020	S.CER C1608 CH 1H 120J-T	T	110.5/102.6
C444	4030007080	S.CER C1608 CH 1H 390J-T	T	110.8/105.4
C445	4030011770	S.CER C1608 CH 1H 060B-T	T	109.5/105.4
C446	4030007060	S.CER C1608 CH 1H 270J-T	T	105.6/105.4
C447	4030007110	S.CER C1608 CH 1H 680J-T	T	105.8/103.3
C448	4030006880	S.CER C1608 JB 1H 472K-T	T	108.2/105.4
C449	4030006880	S.CER C1608 JB 1H 472K-T	T	115.6/98.6
C451	4030007110	S.CER C1608 CH 1H 680J-T	T	102.6/102.5
C452	4030007160	S.CER C1608 CH 1H 181J-T	T	103.9/102.5
C453	4030011600	S.CER C1608 JB 1E 104K-T	T	106.9/105.4
C501	4030006880	S.CER C1608 JB 1H 472K-T	T	61.4/50.3
C502	4030011600	S.CER C1608 JB 1E 104K-T	T	62.7/50.3
C503	4510008540	S.ELE EEE1CA100SR	T	65.9/48
C504	4030011600	S.CER C1608 JB 1E 104K-T	T	44/32.9
C505	4550007470	S.TAN F931A107MNM8MMA	B	46/31
C506	4030011600	S.CER C1608 JB 1E 104K-T	T	46.8/32.9
C507	4030011600	S.CER C1608 JB 1E 104K-T	T	55.5/32.8
C509	4030011600	S.CER C1608 JB 1E 104K-T	T	60/37.2
C510	4030011600	S.CER C1608 JB 1E 104K-T	T	60/39.8
C511	4030011600	S.CER C1608 JB 1E 104K-T	T	60/43.6
C512	4030011600	S.CER C1608 JB 1E 104K-T	T	60/46.2
C513	4030011600	S.CER C1608 JB 1E 104K-T	T	60/48.8
C514	4030011600	S.CER C1608 JB 1E 104K-T	T	56.6/52.6
C515	4030011600	S.CER C1608 JB 1E 104K-T	T	52.9/52.7
C516	4030011600	S.CER C1608 JB 1E 104K-T	T	50.3/52.7
C517	4030011600	S.CER C1608 JB 1E 104K-T	T	40.8/49
C518	4030011600	S.CER C1608 JB 1E 104K-T	T	40.8/46.2
C519	4030011600	S.CER C1608 JB 1E 104K-T	T	40.8/42.6
C520	4030011600	S.CER C1608 JB 1E 104K-T	T	42/35.2
C521	4030011600	S.CER C1608 JB 1E 104K-T	T	58.6/53
C522	4550007220	S.TAN F931A476MCM8MMA	B	47.6/52
C525	4030006880	S.CER C1608 JB 1H 472K-T	T	38.1/46.8
C526	4030011600	S.CER C1608 JB 1E 104K-T	T	38.1/48.1
C532	4030007070	S.CER C1608 CH 1H 330J-T	T	55.1/28.6
C533	4030007110	S.CER C1608 CH 1H 680J-T	T	59.2/28.7
C534	4030007110	S.CER C1608 CH 1H 680J-T	T	62.5/28.2
C535	4030007070	S.CER C1608 CH 1H 330J-T	T	64.8/29.5
C540	4030006880	S.CER C1608 JB 1H 472K-T	T	57.8/73.8
C541	4510008540	S.ELE EEE1CA100SR	T	58.7/69.5
C542	4340000260	S.MLR ECU1C104MA5	T	48.2/62
C543	4030007060	S.CER C1608 CH 1H 270J-T	T	42.2/63.1
C545	4030008560	S.CER C1608 CH 1H 300J-T	T	40/63.8
C546	4610001830	S.TRI TZB4S100AB10R00	T	40.2/66.8
C547	4030007130	S.CER C1608 CH 1H 101J-T	T	43.5/69.1
C548	4030007010	S.CER C1608 CH 1H 100D-T	T	43.5/73.3
C549	4030007050	S.CER C1608 CH 1H 220J-T	T	38.8/73.8
C550	4030006880	S.CER C1608 JB 1H 472K-T	T	38.4/70.5
C551	4030009520	S.CER C1608 CH 1H 020B-T	T	43.5/75.9
C552	4030017810	S.CER C1608 CH 1H 102J-T	T	60.1/76.8
C553	4030006880	S.CER C1608 JB 1H 472K-T	T	52.6/80.6
C554	4510008500	S.ELE EEE1CA101WP	T	57.5/81.2
C555	4030006880	S.CER C1608 JB 1H 472K-T	B	62.6/76.2
C556	4550007220	S.TAN F931A476MCM8MMA	B	39.8/66.4
C558	4550007520	S.TAN F931A106MA8BMA	T	53.6/62
C559	4550007400	S.TAN F931A225MA8BMA	T	51.5/62
C561	4550007520	S.TAN F931A106MA8BMA	B	41.4/79.9
C562	4030006880	S.CER C1608 JB 1H 472K-T	B	43.1/80.7
C563	4030017810	S.CER C1608 CH 1H 102J-T	B	75.3/94.8
C564	4030006880	S.CER C1608 JB 1H 472K-T	B	75.3/96.3
C565	4510008520	S.ELE EEE1CA470SP	T	75/89
C566	4030006880	S.CER C1608 JB 1H 472K-T	T	44.1/83.1
C571	4030006880	S.CER C1608 JB 1H 472K-T	B	60.7/85.9
C573	4030007040	S.CER C1608 CH 1H 180J-T	B	71/94

[PLL UNIT]

REF NO.	ORDER NO.	DESCRIPTION	M.	H/V LOCATION
C671	4030011600	S.CER C1608 JB 1E 104K-T	T	14.5/80.9
C672	4030011600	S.CER C1608 JB 1E 104K-T	T	18.4/80.9
C680	4030006880	S.CER C1608 JB 1H 472K-T	T	30.1/75.5
C681	4030011340	S.CER C1608 CH 1H 471J-T	T	27.5/76.6
C682	4030007120	S.CER C1608 CH 1H 820J-T	T	28.1/78.8
C683	4030017870	S.CER C1608 CH 1H 681J-T	T	26.8/78.8
C684	4030007070	S.CER C1608 CH 1H 330J-T	T	30.1/83.6
C685	4030017800	S.CER C1608 CH 1H 561J-T	T	27.5/83.6
C686	4030011280	S.CER C1608 CH 1H 271J-T	T	23.2/83.5
C687	4030017810	S.CER C1608 CH 1H 102J-T	T	21.3/84.3
C688	4030011280	S.CER C1608 CH 1H 271J-T	T	18.9/83.5
C689	4030011600	S.CER C1608 JB 1E 104K-T	T	12.8/83.5
C690	4030011600	S.CER C1608 JB 1E 104K-T	T	6.4/84.3
C691	4030011600	S.CER C1608 JB 1E 104K-T	T	6.2/90.8
C692	4030006880	S.CER C1608 JB 1H 472K-T	T	4.5/85.1
C693	4030006880	S.CER C1608 JB 1H 472K-T	B	72.2/104.2
C694	4030006880	S.CER C1608 JB 1H 472K-T	B	74/104.2
C703	4030017810	S.CER C1608 CH 1H 102J-T	T	72.4/35.2
C704	4030006880	S.CER C1608 JB 1H 472K-T	T	72.4/33.9
C705	4510008500	S.ELE EEE1CA101WP	T	79.3/29.7
C707	4030011600	S.CER C1608 JB 1E 104K-T	B	74.7/36.3
C708	4030011600	S.CER C1608 JB 1E 104K-T	B	75.4/40.7
C709	4030007070	S.CER C1608 CH 1H 330J-T	T	77.2/42.4
C710	4030006880	S.CER C1608 JB 1H 472K-T	T	75.2/43.2
C711	4030009540	S.CER C1608 CH 1H 1R5B-T	T	79.3/43.2
C712	4030007070	S.CER C1608 CH 1H 330J-T	T	77.2/43.9
C713	4030006880	S.CER C1608 JB 1H 472K-T	T	81.7/50.9
C801	4030006880	S.CER C1608 JB 1H 472K-T	T	62.4/87.3
C802	4030007030	S.CER C1608 CH 1H 150J-T	T	58.9/92
C803	4030006900	S.CER C1608 JB 1H 103K-T	T	59.6/89.9
C811	4030011600	S.CER C1608 JB 1E 104K-T	T	9.8/90.8
C812	4030011600	S.CER C1608 JB 1E 104K-T	T	19.4/90.6
C813	4030017800	S.CER C1608 CH 1H 561J-T	T	25.4/93.6
C831	4030009910	S.CER C1608 CH 1H 040B-T	T	30.4/106.8
C832	4030009510	S.CER C1608 CH 1H 010B-T	T	26.5/98.1
C834	4030007030	S.CER C1608 CH 1H 150J-T	T	21.4/99.8
C835	4030006900	S.CER C1608 JB 1H 103K-T	T	21.4/97
C836	4510008540	S.ELE EEE1CA100SR	T	59.5/97.3
C837	4030006880	S.CER C1608 JB 1H 472K-T	T	57.6/100.3
C838	4030007020	S.CER C1608 CH 1H 120J-T	T	30.4/100.9
C1601	4030006880	S.CER C1608 JB 1H 472K-T	T	83.9/56.4
C1602	4030006880	S.CER C1608 JB 1H 472K-T	B	84.1/56.1
C1607	4030006880	S.CER C1608 JB 1H 472K-T	T	80.6/54
C1608	4030006880	S.CER C1608 JB 1H 472K-T	T	78.8/57.4
C1609	4030007100	S.CER C1608 CH 1H 560J-T	T	77.2/54.6
C1610	4030008750	S.CER C1608 CH 1H 360J-T	T	78.8/60.2
C1611	4030007140	S.CER C1608 CH 1H 121J-T	T	76.8/60.2
C1612	4030007020	S.CER C1608 CH 1H 120J-T	T	76.8/61.5
C1613	4030007110	S.CER C1608 CH 1H 680J-T	T	74.7/62.3
C1651	4030006880	S.CER C1608 JB 1H 472K-T	T	30.2/29
C1652	4030011600	S.CER C1608 JB 1E 104K-T	T	31/24.2
C1653	4030006880	S.CER C1608 JB 1H 472K-T	B	26.3/12.3
C1654	4030011600	S.CER C1608 JB 1E 104K-T	B	24.5/12.3
C1655	4030011600	S.CER C1608 JB 1E 104K-T	T	26.6/17.2
C1656	4030011600	S.CER C1608 JB 1E 104K-T	T	26.6/20.2
C1658	4510008540	S.ELE EEE1CA100SR	T	29.2/14.2
C1659	4030011600	S.CER C1608 JB 1E 104K-T	T	26.6/22.8
C1660	4030011600	S.CER C1608 JB 1E 104K-T	T	26.6/28.1
C1661	4030011600	S.CER C1608 JB 1E 104K-T	T	22.8/32.7
C1662	4550007470	S.TAN F931A107MNBMA	B	19/33
C1663	4550007220	S.TAN F931A476MNCBMA	B	15.2/14.6
C1664	4030011600	S.CER C1608 JB 1E 104K-T	T	20.1/12.9
C1665	4030011600	S.CER C1608 JB 1E 104K-T	T	14.5/12.9
C1666	4030011600	S.CER C1608 JB 1E 104K-T	T	12.7/33.5
C1667	4030011600	S.CER C1608 JB 1E 104K-T	T	11.5/12.9
C1668	4030011600	S.CER C1608 JB 1E 104K-T	T	10/32.7
C1669	4030011600	S.CER C1608 JB 1E 104K-T	T	6.4/15.9
C1670	4030011600	S.CER C1608 JB 1E 104K-T	T	6.1/20.2
C1671	4030011600	S.CER C1608 JB 1E 104K-T	T	6.8/22
C1672	4030011600	S.CER C1608 JB 1E 104K-T	T	6.8/24.6
C1673	4030011600	S.CER C1608 JB 1E 104K-T	T	6.8/28.6
C1680	4030006880	S.CER C1608 JB 1H 472K-T	T	14.9/40.4
C1681	4030007160	S.CER C1608 CH 1H 181J-T	T	13.6/37.8
C1682	4030007140	S.CER C1608 CH 1H 121J-T	T	11.5/38.4
C1683	4030011330	S.CER C1608 CH 1H 391J-T	T	11.5/37.1
C1684	4030007080	S.CER C1608 CH 1H 390J-T	T	6.4/40.5
C1685	4030011280	S.CER C1608 CH 1H 271J-T	T	6.4/37.9
C1686	4030010760	S.CER C1608 CH 1H 331J-T	B	19.4/47
C1687	4030018580	S.CER C1608 CH 1H 821J-T	B	23.7/46.3
C1688	4030010760	S.CER C1608 CH 1H 331J-T	B	21.9/47.8
C1689	4030011600	S.CER C1608 JB 1E 104K-T	T	19.9/52.2
C1690	4030011600	S.CER C1608 JB 1E 104K-T	T	17.8/46.8
C1691	4030011600	S.CER C1608 JB 1E 104K-T	T	14.3/48.6
C1692	4030006880	S.CER C1608 JB 1H 472K-T	T	16.3/46.8
C1701	4030006880	S.CER C1608 JB 1H 472K-T	B	20.2/25.9
C1702	4030006880	S.CER C1608 JB 1H 472K-T	B	18.4/25.9
C1703	4030006880	S.CER C1608 JB 1H 472K-T	B	16.6/25.9
C1704	4030006880	S.CER C1608 JB 1H 472K-T	B	15.4/23.7
C1705	4030006880	S.CER C1608 JB 1H 472K-T	B	15.4/21.9
C1706	4030006880	S.CER C1608 JB 1H 472K-T	B	15.4/20.1
C1707	4030006880	S.CER C1608 JB 1H 472K-T	B	15.4/18.3
C1709	4030006880	S.CER C1608 JB 1H 472K-T	B	9.9/18.3
C1710	4030006880	S.CER C1608 JB 1H 472K-T	B	29.1/18.6
C1711	4030011600	S.CER C1608 JB 1E 104K-T	T	30.1/18
C1751	4030006880	S.CER C1608 JB 1H 472K-T	T	70/16.9
C1752	4030006880	S.CER C1608 JB 1H 472K-T	T	70/15.6
C1753	4030006880	S.CER C1608 JB 1H 472K-T	T	70/14.3
C1754	4030006880	S.CER C1608 JB 1H 472K-T	T	70/13
C1755	4030006880	S.CER C1608 JB 1H 472K-T	T	70/11.7
C1756	4030006880	S.CER C1608 JB 1H 472K-T	T	71.2/10.4
C1757	4030006880	S.CER C1608 JB 1H 472K-T	T	72/9.1
J31	6510007020	CNR TMP-J01X-V6		

[PLL UNIT]

REF NO.	ORDER NO.	DESCRIPTION	M.	H/V LOCATION
J351	6510007020	CNR TMP-J01X-V6		
J561	6510007020	CNR TMP-J01X-V6		
J601	6510007020	CNR TMP-J01X-V6		
J681	6510007020	CNR TMP-J01X-V6		
J831	6510007020	CNR TMP-J01X-V6		
J1601	6510007020	CNR TMP-J01X-V6		
J1681	6510007020	CNR TMP-J01X-V6		
J2018	6510019981	S.CNR 52808-1671 (1690)	T	167.7/22.5
J2019	6510018971	S.CNR B4B-PH-SM4-TB (LF) (SN)	T	167.7/40.8
EP10	6910014690	S.BEA MPZ1608S221A-T	T	173.8/45.7
EP11	6910014690	S.BEA MPZ1608S221A-T	T	160/14.2
EP12	6910014690	S.BEA MPZ1608S221A-T	T	160/15.5
EP13	6910014690	S.BEA MPZ1608S221A-T	T	163.2/39.8
EP20	6910012350	S.BEA MMZ1608Y 102BT	T	78.8/104.9
EP21	6910012350	S.BEA MMZ1608Y 102BT	T	78.8/106.2
EP22	6910012350	S.BEA MMZ1608Y 102BT	T	78.8/107.5
EP101	6910012350	S.BEA MMZ1608Y 102BT	B	94.7/35
EP102	6910012350	S.BEA MMZ1608Y 102BT	B	96.6/35
EP1701	6910012350	S.BEA MMZ1608Y 102BT	T	43.2/18.4
EP1702	6910012350	S.BEA MMZ1608Y 102BT	T	43.2/17
EP1703	6910012350	S.BEA MMZ1608Y 102BT	T	43.2/15.6
EP1704	6910012350	S.BEA MMZ1608Y 102BT	T	43.2/14.2
EP1705	6910012350	S.BEA MMZ1608Y 102BT	T	43.2/12.5
EP1706	6910012350	S.BEA MMZ1608Y 102BT	T	43.2/11.4
EP1707	6910012350	S.BEA MMZ1608Y 102BT	T	43.2/10
EP1708	6910012350	S.BEA MMZ1608Y 102BT	T	43.2/19.8
EP1709	6910012350	S.BEA MMZ1608Y 102BT	T	43.2/8.6

M.=Mounted side (T: Mounted on the Top side B: Mounted on the Bottom side)
S.=Surface mount

[SCOPE UNIT]

REF NO.	ORDER NO.	DESCRIPTION	M.	H/V LOCATION
IC2	1180001771	S.IC TA79L05F (TE12L,F)	T	52.1/75.5
IC31	1110006180	S.IC UPG2009TB-E3	T	20.7/72.8
IC201	1180003110	S.REG TLV1117CDCYR	T	155.7/69.2
IC401	1110006131	S.IC uPC4094G2-E1-A	T	41.6/68.1
IC403	1110006131	S.IC uPC4094G2-E1-A	T	54.5/69.7
IC404	1110006131	S.IC uPC4094G2-E1-A	T	71.6/69
IC405	1110002700	S.IC NJM2904M-TE1-#FMZB	T	29.3/11.7
IC501	1190002031	S.IC AD7650ASTZ	T	83.1/60.3
IC502	1130006891	S.IC TC7S04FU (TE85R,F)	T	85.3/69.1
IC505	1180003030	S.REG S-812C25AJA-C2FT2G	T	84.2/77.1
IC601	1140014320	S.IC TMS320C6720BRFP200	T	118.4/57.7
IC602	1130011930	S.IC SN74LVC1G04DCKR	T	96.1/53.5
IC603	1130011930	S.IC SN74LVC1G04DCKR	T	98.6/56.4
IC607	1110006411	S.IC R3111N111A-TR-F	T	104.9/70.3
IC671	1130014240	S.IC AT49BV040B-TU (SX-3009D)	T	140.4/62
IC801	1130013270	S.IC ADF4116BRUZ	T	109.2/15.1
IC803	1130009691	S.IC TC74HCT7007AF (F)	T	166.3/18.2
IC820	1190001961	S.IC AD9857ASTZ	T	138.7/17.1
IC821	1130010461	S.IC TC7SH08FU (TE85L,JF)	T	105.3/60.9
Q1	1530002060	S.TR 2SC4081 T106 R	T	26.9/54.1
Q2	1530003851	S.TR 2SC5551F-TD-E	T	30.9/23.4
Q101	1530003151	S.TR 2SC4673D-TD-E	T	56.7/5.4
Q201	1560000561	S.FET 2SK882-GR (TE85L,F)	T	47.7/29.5
Q202	1560000561	S.FET 2SK882-GR (TE85L,F)	T	45.7/37.2
Q301	1530003151	S.TR 2SC4673D-TD-E	T	65.3/51.5
Q701	1530003221	S.TR 2SC4406-4-TL-E	T	130.9/33.3
Q720	1530003221	S.TR 2SC4406-4-TL-E	T	146.9/27.2
Q810	1530003221	S.TR 2SC4406-4-TL-E	T	116.8/16.3
Q821	1560000331	S.FET 2SK210-GR (TE85R,F)	T	86.9/24.3
Q841	1530002060	S.TR 2SC4081 T106 R	T	85.1/15.8
Q842	1530003431	S.TR 2SC5226-4-TL-E	T	72.8/15.5
Q843	1530003431	S.TR 2SC5226-4-TL-E	T	71.2/21.9
Q872	1590000680	S.TR DTC114EUA T106	T	70.5/12.4
D1	1750000971	S.DIO CPH5513-TL-E	T	19.9/66.1
D2	1750000971	S.DIO CPH5513-TL-E	T	17.3/59.2
D3	1750000441	S.DIO 1SV263-TL-E	T	20.4/58.8
D4	1750000431	S.DIO HSB88WSTR-E	T	54.2/51.8
D101	1750000431	S.DIO HSB88WSTR-E	T	51.1/19.3
D821	1750000681	S.VCP 1SV232 (TPH2,F)	T	101.5/21.8
D822	1750000681	S.VCP 1SV232 (TPH2,F)	T	101.5/23.5
FI201	2030000290	S.MLH FL-357 (45 MHz)	T	53.1/33
FI501	2040000790	S.LC EXCCET103U	T	97.2/49.4
L1	6200001831	S.COL NLV32T-100J	T	20.4/62.9
L2	6200001831	S.COL NLV32T-100J	T	14.1/61.8
L3	6200001831	S.COL NLV32T-100J	T	10.8/60.2
L4	6200001831	S.COL NLV32T-100J	T	21.1/54
L5	6150004280	COL LS-484B (C-14927)		
L6	6150004280	COL LS-484B (C-14927)		
L7	6200003261	S.COL NLV32T-101J	T	36.4/32.8
L8	6140003790	COL LR-442		
L9	6200001831	S.COL NLV32T-100J	T	25.9/30.5
L10	6200001831	S.COL NLV32T-100J	T	34.9/17.3
L11	6200001831	S.COL NLV32T-100J	T	29.6/45.9
L12	6200010450	S.COL C2520C-R82G-A (0.82U)	T	17.7/44.3
L13	6200010940	S.COL C2520C-39NG-A	T	13.2/55
L14	6200010860	S.COL C2520C-R10G-A (0.1U)	T	14/50.8
L51	6200001831	S.COL NLV32T-100J	T	143/32.4
L52	6200001831	S.COL NLV32T-100J	T	174.5/43.3
L53	6200001831	S.COL NLV32T-100J	T	74.5/44.9
L54	6200001831	S.COL NLV32T-100J	T	78/44.9
L101	6140003530	COL LR-395		
L102	6140003530	COL LR-395		
L103	6200003021	S.COL NLV32T-R33J	T	50.8/6.9
L104	6200001920	S.COL ELJNC R15K-F	T	51.1/10.6
L201	6150004250	COL LS-471A (C-14922)		
L202	6150004280	COL LS-484B (C-14927)		
L203	6150004280	COL LS-484B (C-14927)		
L204	6200001831	S.COL NLV32T-100J	T	38.4/47.7
L205	6200002431	S.COL NLV25T-082J	T	55.4/27.2
L301	6140003530	COL LR-395		
L302	6140003530	COL LR-395		
L303	6200003041	S.COL NLV32T-R68J	T	64.8/56.2
L304	6200001831	S.COL NLV32T-100J	T	64.8/59.2
L401	6200003171	S.COL NLV32T-330J	T	45/61.5
L501	6200001831	S.COL NLV32T-100J	T	81.3/44.9
L502	6200001831	S.COL NLV32T-100J	T	84.3/48.1
L551	6180003501	S.COL SLF6028T-100M1R3-PF	T	144.3/40.7
L552	6200001831	S.COL NLV32T-100J	T	141.6/45.5
L671	6200001831	S.COL NLV32T-100J	T	145.8/47.5
L701	6200005491	S.COL NLV32T-331J	T	138/34.6
L720	6200011610	S.COL NLC453232T-100K-PF	T	126.7/15.4
L721	6200011610	S.COL NLC453232T-100K-PF	T	153.7/22.4
L722	6200001831	S.COL NLV32T-100J	T	152/25.8
L761	6200003011	S.COL NLV32T-R27J	T	152.4/11.1
L762	6200003021	S.COL NLV32T-R33J	T	155.8/9.6
L763	6200003251	S.COL NLV32T-R39J	T	151.5/5.9
L764	6200003251	S.COL NLV32T-R39J	T	131.5/4.1
L801	6200005491	S.COL NLV32T-331J	T	113.3/19.5
L802	6200005491	S.COL NLV32T-331J	T	169/11.1
L821	6200001831	S.COL NLV32T-100J	T	105.4/24.3
L822	6190001441	COL #E526GN-110504		
L823	6200001851	S.COL NLV32T-5R6J	T	84.4/20.8
L825	6200003261	S.COL NLV32T-101J	T	93.5/31.9
L841	6200003261	S.COL NLV32T-101J	T	81/31.4
L842	6200003031	S.COL NLV32T-R47J	T	68.8/16.8
L851	6200003431	S.COL NLV32T-R10J	T	71/25.7

[SCOPE UNIT]

REF NO.	ORDER NO.	DESCRIPTION	M.	H/V LOCATION
L852	6200001471	S.COL NLV32T-R12J	T	70.6/29.5
R1	7030003360	S.RES ERJ3GEYJ 221 V (220)	T	22.3/65.9
R2	7030003440	S.RES ERJ3GEYJ 222 V (220 k)	T	22.4/57.4
R3	7030003480	S.RES ERJ3GEYJ 102 V (1 k)	T	23.7/57.4
R4	7030003460	S.RES ERJ3GEYJ 152 V (1.5 k)	T	25/54.5
R5	7030003520	S.RES ERJ3GEYJ 472 V (4.7 k)	T	29.6/54
R5	7030003580	S.RES ERJ3GEYJ 153 V (15 k)	T	29.6/54
R6	7030003440	S.RES ERJ3GEYJ 102 V (1 k)	T	28.2/56.1
R7	7030003290	S.RES ERJ3GEYJ 560 V (56)	T	31.2/35.4
R8	7030003440	S.RES ERJ3GEYJ 102 V (1 k)	T	31/19.8
R9	7030003500	S.RES ERJ3GEYJ 332 V (3.3 k)	T	33.4/19.8
R11	7310005400	S.TRI EVM-3VSX50 BE4 (223)	T	29.9/49.6
R12	7030003320	S.RES ERJ3GEYJ 101 V (100)	T	32.4/26.5
R36	7030003520	S.RES ERJ3GEYJ 472 V (4.7 k)	T	18.1/71.7
R38	7030003520	S.RES ERJ3GEYJ 472 V (4.7 k)	T	20.9/68.4
R53	7030003320	S.RES ERJ3GEYJ 101 V (100)	T	163.3/41.8
R60	7030003320	S.RES ERJ3GEYJ 101 V (100)	T	163.3/59.8
R61	7030003320	S.RES ERJ3GEYJ 101 V (100)	T	152.4/60.8
R62	7030003320	S.RES ERJ3GEYJ 101 V (100)	T	152.4/54.8
R63	7030003320	S.RES ERJ3GEYJ 101 V (100)	T	163.3/55.8
R64	7030003320	S.RES ERJ3GEYJ 101 V (100)	T	152.4/56.8
R65	7030003320	S.RES ERJ3GEYJ 101 V (100)	T	163.3/49.8
R66	7030003320	S.RES ERJ3GEYJ 101 V (100)	T	152.4/48.8
R71	7030003320	S.RES ERJ3GEYJ 101 V (100)	T	152.4/42.8
R72	7030003320	S.RES ERJ3GEYJ 101 V (100)	T	163.3/53.8
R73	7030003320	S.RES ERJ3GEYJ 101 V (100)	T	153.7/50.3
R74	7030003320	S.RES ERJ3GEYJ 101 V (100)	T	152.4/52.8
R75	7030003320	S.RES ERJ3GEYJ 101 V (100)	T	163.3/51.8
R76	7030003320	S.RES ERJ3GEYJ 101 V (100)	T	152.4/47.6
R77	7030003320	S.RES ERJ3GEYJ 101 V (100)	T	163.3/48.6
R78	7030003320	S.RES ERJ3GEYJ 101 V (100)	T	163.3/45.8
R79	7030003320	S.RES ERJ3GEYJ 101 V (100)	T	163.3/57.8
R81	7030010520	S.RES ERJ1TYJ 101U (100)	T	52.3/79.9
R103	7030003480	S.RES ERJ3GEYJ 222 V (2.2 k)	T	60.6/49
R104	7030003320	S.RES ERJ3GEYJ 101 V (100)	T	51.1/4.3
R105	7030003370	S.RES ERJ3GEYJ 271 V (270)	T	51.3/14.9
R106	7030003230	S.RES ERJ3GEYJ 180 V (18)	T	53.4/15.8
R107	7030003370	S.RES ERJ3GEYJ 271 V (270)	T	51.3/16.1
R108	7030003370	S.RES ERJ3GEYJ 271 V (270)	T	52.4/26.2
R109	7030003230	S.RES ERJ3GEYJ 180 V (18)	T	55.8/25.3
R110	7030003370	S.RES ERJ3GEYJ 271 V (270)	T	52.4/27.4
R111	7030003550	S.RES ERJ3GEYJ 822 V (8.2 k)	T	54.1/3.6
R112	7030003320	S.RES ERJ3GEYJ 101 V (100)	T	60.6/6.3
R113	7030003860	S.RES ERJ3GE JPW V	T	53.3/13.2
R201	7030003430	S.RES ERJ3GEYJ 821 V (820)	T	47.5/32.6
R202	7030003430	S.RES ERJ3GEYJ 821 V (820)	T	47.5/31.4
R203	7030003280	S.RES ERJ3GEYJ 470 V (47)	T	47.5/26.4
R204	7030003560	S.RES ERJ3GEYJ 103 V (10 k)	T	43.6/36.2
R205	7030003280	S.RES ERJ3GEYJ 470 V (47)	T	39.9/37.1
R206	7030003380	S.RES ERJ3GEYJ 331 V (330)	T	46/48.7
R207	7030003220	S.RES ERJ3GEYJ 150 V (15)	T	46.7/46.8
R208	7030003380	S.RES ERJ3GEYJ 331 V (330)	T	47.5/48.7
R209	7030003640	S.RES ERJ3GEYJ 473 V (47 k)	T	41.7/36.6
R210	7030003330	S.RES ERJ3GEYJ 121 V (120)	T	152.1/65.5
R211	7030011130	S.RES ERJ1TYJ 1R0U (1)	T	163.7/65.8
R301	7030003320	S.RES ERJ3GEYJ 101 V (100)	T	47/64.1
R302	7030003370	S.RES ERJ3GEYJ 271 V (270)	T	59.2/52.2
R303	7030003230	S.RES ERJ3GEYJ 180 V (18)	T	60/54
R304	7030003370	S.RES ERJ3GEYJ 271 V (270)	T	60.7/52.2
R305	7030003320	S.RES ERJ3GEYJ 101 V (100)	T	67.6/57.5
R306	7030003480	S.RES ERJ3GEYJ 222 V (2.2 k)	T	65.2/47
R307	7030003550	S.RES ERJ3GEYJ 822 V (8.2 k)	T	62.1/50.5
R308	7030003340	S.RES ERJ3GEYJ 151 V (150)	T	68.2/47
R402	7030003440	S.RES ERJ3GEYJ 102 V (1 k)	T	45/67
R403	7030003440	S.RES ERJ3GEYJ 102 V (1 k)	T	44.1/72.6
R404	7030003440	S.RES ERJ3GEYJ 102 V (1 k)	T	45.4/71.4
R405	7030003440	S.RES ERJ3GEYJ 102 V (1 k)	T	46.9/70.2
R410	7030003560	S.RES ERJ3GEYJ 103 V (10 k)	T	49.9/68.5
R411	7030003560	S.RES ERJ3GEYJ 103 V (10 k)	T	40.9/60.6
R412	7030003560	S.RES ERJ3GEYJ 103 V (10 k)	T	38.1/66
R413	7030003730	S.RES ERJ3GEYJ 274 V (270 k)	T	41.6/62.4
R414	7030003560	S.RES ERJ3GEYJ 103 V (10 k)	T	55.3/66.3
R415	7030003560	S.RES ERJ3GEYJ 103 V (10 k)	T	59/71.1
R416	7310005410	S.TRI EVM-3VSX50 BQ4 (473)	T	62.1/68.1
R417	7030003630	S.RES ERJ3GEYJ 104 V (100 k)	T	66.4/67.3
R418	7030003570	S.RES ERJ3GEYJ 123 V (12 k)	T	73.1/73.6
R419	7030003220	S.RES ERJ3GEYJ 150 V (15)	T	75.5/73.7
R421	7030003860	S.RES ERJ3GE JPW V	T	68.1/66.9
R422	7030003560	S.RES ERJ3GEYJ 103 V (10 k)	T	69.9/73.6
R423	7030003540	S.RES ERJ3GEYJ 682 V (6.8 k)	T	70.7/75.5
R424	7030003860	S.RES ERJ3GE JPW V	T	72.8/64.1
R429	7030003860	S.RES ERJ3GE JPW V	T	24.7/9
R431	7030003860	S.RES ERJ3GE JPW V	T	26.3/15.1
R433	7030005631	S.RES ERA3YKD 154V (150 k)	T	28.9/7.6
R435	7030005501	S.RES ERA3YKD 124V (120 k)	T	30.2/7.6
R436	7030005501	S.RES ERA3YKD 124V (120 k)	T	27/8.2
R437	7030003680	S.RES ERJ3GEYJ 104 V (100 k)	T	33.9/9
R438	7030003680	S.RES ERJ3GEYJ 104 V (100 k)	T	33.9/11.7
R500	7030003860	S.RES ERJ3GE JPW V	T	89.5/66.4
R501	7030003320	S.RES ERJ3GEYJ 101 V (100)	T	82.7/54.1
R502	7030003560	S.RES ERJ3GEYJ 103 V (10 k)	T	83.2/51.6
R503	7030003560	S.RES ERJ3GEYJ 103 V (10 k)	T	86

[SCOPE UNIT]

REF NO.	ORDER NO.	DESCRIPTION	M.	H/V LOCATION
R607	7030003560	S.RES ERJ3GEYJ 103 V (10 k)	T	127/70.7
R610	7030003800	S.RES ERJ3GEYJ 105 V (1 M)	T	98/53.7
R611	7030004040	S.RES ERJ3GEYJ 4R7 V (4.7)	T	94.2/56.4
R612	7030004040	S.RES ERJ3GEYJ 4R7 V (4.7)	T	95.4/57.9
R615	7030003320	S.RES ERJ3GEYJ 101 V (100)	T	99.2/53.6
R616	7030003520	S.RES ERJ3GEYJ 472 V (4.7 k)	T	103.9/43.1
R617	7030003520	S.RES ERJ3GEYJ 472 V (4.7 k)	T	105.1/43.1
R618	7030003520	S.RES ERJ3GEYJ 472 V (4.7 k)	T	105.9/45.1
R620	7030003560	S.RES ERJ3GEYJ 103 V (10 k)	T	125.4/73.4
R621	7030003560	S.RES ERJ3GEYJ 103 V (10 k)	T	122.6/73.8
R622	7030003860	S.RES ERJ3GE JPW V	T	108.8/45
R623	7030003860	S.RES ERJ3GE JPW V	T	103.9/66.9
R624	7030003560	S.RES ERJ3GEYJ 103 V (10 k)	T	122.6/72.5
R625	7030003560	S.RES ERJ3GEYJ 103 V (10 k)	T	123.1/70.7
R626	7030003560	S.RES ERJ3GEYJ 103 V (10 k)	T	121.7/70.7
R627	7030003560	S.RES ERJ3GEYJ 103 V (10 k)	T	105.5/47.9
R628	7030003560	S.RES ERJ3GEYJ 103 V (10 k)	T	123.2/40.6
R629	7030003560	S.RES ERJ3GEYJ 103 V (10 k)	T	122.6/43.2
R630	7030003560	S.RES ERJ3GEYJ 103 V (10 k)	T	121.1/43.2
R631	7030003560	S.RES ERJ3GEYJ 103 V (10 k)	T	120.5/39.2
R632	7030003560	S.RES ERJ3GEYJ 103 V (10 k)	T	119.7/41.8
R633	7030003560	S.RES ERJ3GEYJ 103 V (10 k)	T	118.7/39.5
R634	7030003860	S.RES ERJ3GE JPW V	T	101.9/58.5
R635	7030003560	S.RES ERJ3GEYJ 103 V (10 k)	T	118/42.1
R636	7030003560	S.RES ERJ3GEYJ 103 V (10 k)	T	105.1/66.9
R701	7030003240	S.RES ERJ3GEYJ 220 V (22)	T	134.7/34.3
R702	7030003560	S.RES ERJ3GEYJ 103 V (10 k)	T	129/34.3
R703	7030003320	S.RES ERJ3GEYJ 101 V (100)	T	132.8/34.3
R704	7030003280	S.RES ERJ3GEYJ 470 V (47)	T	136/32.4
R705	7030003340	S.RES ERJ3GEYJ 151 V (150)	T	128.5/32.4
R720	7030003370	S.RES ERJ3GEYJ 271 V (270)	T	148.9/28.3
R721	7030003560	S.RES ERJ3GEYJ 103 V (10 k)	T	150.1/28.3
R722	7030003340	S.RES ERJ3GEYJ 151 V (150)	T	152.5/28.3
R723	7030003440	S.RES ERJ3GEYJ 102 V (1 k)	T	141.6/6.6
R724	7030003440	S.RES ERJ3GEYJ 102 V (1 k)	T	141.6/5.4
R725	7030003440	S.RES ERJ3GEYJ 102 V (1 k)	T	138.4/4.8
R726	7030003440	S.RES ERJ3GEYJ 102 V (1 k)	T	141.6/4
R727	7030003440	S.RES ERJ3GEYJ 102 V (1 k)	T	137/28.6
R729	7030003280	S.RES ERJ3GEYJ 470 V (47)	T	144.5/26.3
R730	7030003560	S.RES ERJ3GEYJ 103 V (10 k)	T	145/29
R731	7030003460	S.RES ERJ3GEYJ 152 V (1.5 k)	T	150.2/20
R732	7030003510	S.RES ERJ3GEYJ 392 V (3.9 k)	T	151.5/15.7
R734	7030003510	S.RES ERJ3GEYJ 392 V (3.9 k)	T	147.6/24.2
R735	7030003280	S.RES ERJ3GEYJ 470 V (47)	T	151.1/13.2
R736	7030003280	S.RES ERJ3GEYJ 470 V (47)	T	151.5/14.4
R737	7030003440	S.RES ERJ3GEYJ 102 V (1 k)	T	138.2/6.6
R738	7030003640	S.RES ERJ3GEYJ 473 V (47 k)	T	133.2/27.6
R739	7030003510	S.RES ERJ3GEYJ 392 V (3.9 k)	T	151.5/17
R742	7030003860	S.RES ERJ3GE JPW V	T	131.9/27.5
R745	7030003860	S.RES ERJ3GE JPW V	T	130.9/9
R764	7030003370	S.RES ERJ3GEYJ 271 V (270)	T	121.7/2
R765	7030003230	S.RES ERJ3GEYJ 180 V (18)	T	119.9/1.2
R766	7030003370	S.RES ERJ3GEYJ 271 V (270)	T	118/2
R771	7030003860	S.RES ERJ3GE JPW V	T	110.8/1.2
R801	7030003440	S.RES ERJ3GEYJ 102 V (1 k)	T	113.6/16.5
R802	7030003440	S.RES ERJ3GEYJ 102 V (1 k)	T	114.8/13.1
R803	7030003440	S.RES ERJ3GEYJ 102 V (1 k)	T	114.7/14.6
R806	7030003520	S.RES ERJ3GEYJ 472 V (4.7 k)	T	106.1/18.7
R808	7030003600	S.RES ERJ3GEYJ 223 V (22 k)	T	105.3/21.2
R809	7030003840	S.RES ERJ3GEYJ 225 V (2.2 M)	T	107.6/20.2
R810	7030003370	S.RES ERJ3GEYJ 271 V (270)	T	117.7/13.8
R811	7030003560	S.RES ERJ3GEYJ 103 V (10 k)	T	117.5/18.8
R812	7030003280	S.RES ERJ3GEYJ 470 V (47)	T	114.6/10.2
R813	7030003340	S.RES ERJ3GEYJ 151 V (150)	T	117.5/24
R814	7030003500	S.RES ERJ3GEYJ 332 V (3.3 k)	T	103.9/19.7
R821	7030003680	S.RES ERJ3GEYJ 104 V (100 k)	T	83/24.5
R822	7030003680	S.RES ERJ3GEYJ 104 V (100 k)	T	90.5/23.2
R823	7030003370	S.RES ERJ3GEYJ 271 V (270)	T	87.1/20.3
R841	7030003200	S.RES ERJ3GEYJ 100 V (10)	T	81.6/18.5
R842	7030003360	S.RES ERJ3GEYJ 221 V (220)	T	85.8/13.6
R843	7030003500	S.RES ERJ3GEYJ 332 V (3.3 k)	T	83.8/17.7
R844	7030003540	S.RES ERJ3GEYJ 682 V (6.8 k)	T	82.3/16.4
R845	7030003360	S.RES ERJ3GEYJ 221 V (220)	T	82.3/15.1
R846	7030003380	S.RES ERJ3GEYJ 331 V (330)	T	84/10.6
R847	7030003370	S.RES ERJ3GEYJ 271 V (270)	T	74.7/15.5
R848	7030003540	S.RES ERJ3GEYJ 682 V (6.8 k)	T	70.2/14.6
R849	7030003500	S.RES ERJ3GEYJ 332 V (3.3 k)	T	73/12
R850	7030003390	S.RES ERJ3GEYJ 391 V (390)	T	72.4/17.7
R851	7030003360	S.RES ERJ3GEYJ 221 V (220)	T	68.8/18.9
R852	7030003490	S.RES ERJ3GEYJ 272 V (2.7 k)	T	74.4/21.1
R853	7030003510	S.RES ERJ3GEYJ 392 V (3.9 k)	T	74.4/24
R854	7030003360	S.RES ERJ3GEYJ 221 V (220)	T	68.8/21.5
R855	7030008180	S.RES ERJ12VJ331U (330)	T	87.5/32.2
R856	7030003370	S.RES ERJ3GEYJ 271 V (270)	T	66.8/43.9
R857	7030003230	S.RES ERJ3GEYJ 180 V (18)	T	64.5/43.1
R858	7030003320	S.RES ERJ3GEYJ 101 V (100)	T	64.5/44.6
R859	7030003260	S.RES ERJ3GEYJ 330 V (33)	T	68/24.7
R860	7030003400	S.RES ERJ3GEYJ 471 V (470)	T	86.1/10.6
R861	7030003860	S.RES ERJ3GE JPW V	T	68.2/43.9
R862	7030003320	S.RES ERJ3GEYJ 101 V (100)	T	1.7/25.1
R863	7030003320	S.RES ERJ3GEYJ 101 V (100)	T	12.7/30.9
R864	7030003320	S.RES ERJ3GEYJ 101 V (100)	T	21/29.9
R865	7030003320	S.RES ERJ3GEYJ 101 V (100)	T	10/24.1
R866	7030003320	S.RES ERJ3GEYJ 101 V (100)	T	1.7/23.1
R867	7030003320	S.RES ERJ3GEYJ 101 V (100)	T	1.7/27.1
R868	7030003320	S.RES ERJ3GEYJ 101 V (100)	T	10/28.1
R869	7030003860	S.RES ERJ3GE JPW V	T	10/22.1
R870	7030003320	S.RES ERJ3GEYJ 101 V (100)	T	12.7/26.9
R871	7030003320	S.RES ERJ3GEYJ 101 V (100)	T	21/27.9
R872	7030003320	S.RES ERJ3GEYJ 101 V (100)	T	21/31.9
R873	7030003320	S.RES ERJ3GEYJ 101 V (100)	T	12.7/32.9
R874	7030003320	S.RES ERJ3GEYJ 101 V (100)	T	21/33.9
R876	7030003320	S.RES ERJ3GEYJ 101 V (100)	T	12.7/28.9
R877	7030003860	S.RES ERJ3GE JPW V	T	12.7/34.9

[SCOPE UNIT]

REF NO.	ORDER NO.	DESCRIPTION	M.	H/V LOCATION
R878	7030003320	S.RES ERJ3GEYJ 101 V (100)	T	165.9/46.8
R879	7030003320	S.RES ERJ3GEYJ 101 V (100)	T	174.2/47.8
R880	7030003320	S.RES ERJ3GEYJ 101 V (100)	T	174.2/49.8
R881	7030003320	S.RES ERJ3GEYJ 101 V (100)	T	165.9/50.8
R882	7030003320	S.RES ERJ3GEYJ 101 V (100)	T	174.2/51.8
R883	7030003320	S.RES ERJ3GEYJ 101 V (100)	T	174.2/53.8
R884	7030003320	S.RES ERJ3GEYJ 101 V (100)	T	165.9/54.8
R885	7030003320	S.RES ERJ3GEYJ 101 V (100)	T	174.2/55.8
R886	7030003320	S.RES ERJ3GEYJ 101 V (100)	T	165.9/56.8
R887	7030003320	S.RES ERJ3GEYJ 101 V (100)	T	174.2/57.8
R888	7030003320	S.RES ERJ3GEYJ 101 V (100)	T	165.9/58.8
R889	7030003320	S.RES ERJ3GEYJ 101 V (100)	T	174.2/59.8
R890	7030003860	S.RES ERJ3GE JPW V	T	165.9/60.8
R891	7030003860	S.RES ERJ3GE JPW V	T	174.2/45.9
C1	4030006880	S.CER C1608 JB 1H 472K-T	T	23.5/72.1
C3	4030006880	S.CER C1608 JB 1H 472K-T	T	19/69.1
C4	4030011340	S.CER C1608 CH 1H 471J-T	T	17.1/63.8
C5	4030011340	S.CER C1608 CH 1H 471J-T	T	20.3/60.8
C6	4030006880	S.CER C1608 JB 1H 472K-T	T	17.1/61.6
C7	4030006880	S.CER C1608 JB 1H 472K-T	T	20.4/56.8
C8	4030006880	S.CER C1608 JB 1H 472K-T	T	13.2/58
C9	4030006880	S.CER C1608 JB 1H 472K-T	T	17.5/56.7
C10	4030011600	S.CER C1608 JB 1E 104K-T	T	23.7/54.5
C11	4030009510	S.CER C1608 CH 1H 010B-T	T	16.9/47.4
C12	4030007040	S.CER C1608 CH 1H 180J-T	T	22.4/44.1
C13	4030007040	S.CER C1608 CH 1H 180J-T	T	18.2/40.9
C14	4030011340	S.CER C1608 CH 1H 471J-T	T	28.2/35.4
C15	4030006880	S.CER C1608 JB 1H 472K-T	T	26.4/33.2
C16	4030006880	S.CER C1608 JB 1H 472K-T	T	32.2/19.8
C17	4030006880	S.CER C1608 JB 1H 472K-T	T	36.4/25.2
C18	4030006960	S.CER C1608 CH 1H 050C-T	T	29.8/26.5
C21	4030006880	S.CER C1608 JB 1H 472K-T	T	125.9/32.4
C22	4030006880	S.CER C1608 JB 1H 472K-T	T	23.5/73.6
C23	4030011600	S.CER C1608 JB 1E 104K-T	T	152.4/44.8
C24	4030011600	S.CER C1608 JB 1E 104K-T	T	23.5/70.9
C39	4030011600	S.CER C1608 JB 1E 104K-T	T	20.8/74.7
C40	4030011600	S.CER C1608 JB 1E 104K-T	T	20.9/70.9
C41	4610001830	S.TRI TZB4S100AB10R00	T	13.9/44.2
C42	4030007030	S.CER C1608 CH 1H 150J-T	T	17.5/55.4
C43	4030007120	S.CER C1608 CH 1H 820J-T	T	15.5/54.6
C44	4030007100	S.CER C1608 CH 1H 560J-T	T	17.5/53.7
C45	4030007400	S.CER C1608 CH 1H 180J-T	T	16.8/51.6
C46	4030008750	S.CER C1608 CH 1H 360J-T	T	18.3/51.6
C53	4510008540	S.ELE EEE1CA100SR	T	59.3/76.9
C54	4510008540	S.ELE EEE1CA100SR	T	74.4/50.4
C55	4030011600	S.CER C1608 JB 1E 104K-T	T	48/75.9
C56	4510008540	S.ELE EEE1CA100SR	T	44.2/76.9
C57	4030011600	S.CER C1608 JB 1E 104K-T	T	55.3/76.3
C101	4030006880	S.CER C1608 JB 1H 472K-T	T	60.6/37.7
C102	4030007150	S.CER C1608 CH 1H 151J-T	T	53/5.4
C103	4030011600	S.CER C1608 JB 1E 104K-T	T	48.7/6.5
C106	4030006880	S.CER C1608 JB 1H 472K-T	T	60.6/7.5
C107	4030007100	S.CER C1608 CH 1H 560J-T	T	53/8
C108	4030007110	S.CER C1608 CH 1H 680J-T	T	54.8/9.9
C109	4030007110	S.CER C1608 CH 1H 121J-T	T	53/10.6
C110	4030007140	S.CER C1608 CH 1H 680J-T	T	54.8/11.4
C201	4030007040	S.CER C1608 CH 1H 180J-T	T	58.4/35.2
C202	4030007040	S.CER C1608 CH 1H 180J-T	T	53.7/37.6
C204	4030006880	S.CER C1608 JB 1H 472K-T	T	47.5/33.8
C205	4030007070	S.CER C1608 CH 1H 330J-T	T	44/25.2
C206	4030006880	S.CER C1608 JB 1H 472K-T	T	47.5/27.6
C207	4030006960	S.CER C1608 CH 1H 050C-T	T	44.8/34.8
C208	4030007070	S.CER C1608 CH 1H 330J-T	T	41.7/37.8
C209	4030006880	S.CER C1608 JB 1H 472K-T	T	39.2/39.7
C210	4030011600	S.CER C1608 JB 1E 104K-T	T	37.7/44.8
C211	4030009550	S.CER C1608 CH 1E 2R5B-T	T	59.6/35.2
C212	4030006940	S.CER C1608 CH 1H 030C-T	T	52.5/37.6
C213	4550007640	S.TAN F930G107MBABMA	T	155.7/74.6
C214	4510009270	S.ELE EEEH1C220UR	T	162.4/70.5
C215	4030011600	S.CER C1608 JB 1E 104K-T	T	157/64.7
C216	4030017490	S.CER C1608 JB 1A 105K-T	T	154.3/64.7
C301	4030007040	S.CER C1608 CH 1H 180J-T	T	62.6/54
C302	4030006880	S.CER C1608 JB 1H 472K-T	T	67.6/54.7
C303	4030006880	S.CER C1608 JB 1H 472K-T	T	63.8/47
C304	4030006880	S.CER C1608 JB 1H 472K-T	T	66.8/47
C401	4030008850	S.CER C1608 JB 1H 123K-T	T	44.2/63.6

[RF-B UNIT]

REF NO.	ORDER NO.	DESCRIPTION	M.	H/V LOCATION
C506	4030011600	S.CER C1608 JB 1E 104K-T	T	89.1/62.9
C507	4510008580	S.ELE EEE0JA470SR	T	78.6/68.5
C508	4030017490	S.CER C1608 JB 1A 105K-T	T	76.9/64
C509	4030011600	S.CER C1608 JB 1E 104K-T	T	87.2/69
C521	4510008540	S.ELE EEE1CA100SR	T	91.4/79.3
C522	4030011600	S.CER C1608 JB 1E 104K-T	T	87.3/79.4
C523	4550006250	S.TAN TEESVA 1A 106M8R	T	79.4/77.2
C524	4030011600	S.CER C1608 JB 1E 104K-T	T	81.1/77.6
C551	4550007460	S.TAN F930G107MBA BMA	T	126.8/41.6
C601	4030011600	S.CER C1608 JB 1E 104K-T	T	113.7/70.6
C602	4030011600	S.CER C1608 JB 1E 104K-T	T	115.5/70.8
C603	4030011600	S.CER C1608 JB 1E 104K-T	T	117.8/70.6
C604	4030011600	S.CER C1608 JB 1E 104K-T	T	119.1/70.6
C605	4030011600	S.CER C1608 JB 1E 104K-T	T	120.5/70.7
C606	4030011600	S.CER C1608 JB 1E 104K-T	T	125.7/70.8
C607	4030011600	S.CER C1608 JB 1E 104K-T	T	131.4/64.5
C608	4030011600	S.CER C1608 JB 1E 104K-T	T	131.4/62.9
C609	4030011600	S.CER C1608 JB 1E 104K-T	T	130.6/59.2
C610	4030011600	S.CER C1608 JB 1E 104K-T	T	131.4/57.1
C611	4030011600	S.CER C1608 JB 1E 104K-T	T	131.4/54.9
C612	4030011600	S.CER C1608 JB 1E 104K-T	T	131.4/52.9
C613	4030011600	S.CER C1608 JB 1E 104K-T	T	130.6/50.2
C614	4030011600	S.CER C1608 JB 1E 104K-T	T	129.4/47.4
C615	4030011600	S.CER C1608 JB 1E 104K-T	T	125.6/44.5
C616	4030011600	S.CER C1608 JB 1E 104K-T	T	124.4/44.7
C617	4030011600	S.CER C1608 JB 1E 104K-T	T	121.9/45.1
C618	4030011600	S.CER C1608 JB 1E 104K-T	T	119.4/44.4
C619	4030011600	S.CER C1608 JB 1E 104K-T	T	117/44.7
C620	4030011600	S.CER C1608 JB 1E 104K-T	T	115.8/44.7
C621	4030011600	S.CER C1608 JB 1E 104K-T	T	113.9/45.5
C622	4030011600	S.CER C1608 JB 1E 104K-T	T	111.3/45.5
C623	4030011600	S.CER C1608 JB 1E 104K-T	T	105.2/50.2
C624	4030011600	S.CER C1608 JB 1E 104K-T	T	105.2/51.6
C625	4030011600	S.CER C1608 JB 1E 104K-T	T	105.1/56.6
C626	4030011600	S.CER C1608 JB 1E 104K-T	T	105.5/58.9
C627	4030011600	S.CER C1608 JB 1E 104K-T	T	105/63.7
C628	4030011600	S.CER C1608 JB 1E 104K-T	T	106.2/63.7
C629	4030011600	S.CER C1608 JB 1E 104K-T	T	105.5/54.7
C660	4510008540	S.ELE EEE1CA100SR	T	96.5/45.9
C661	4030011600	S.CER C1608 JB 1E 104K-T	T	98/51.5
C662	4030011600	S.CER C1608 JB 1E 104K-T	T	127.2/44.7
C663	4030011600	S.CER C1608 JB 1E 104K-T	T	96.7/56.4
C664	4030011600	S.CER C1608 JB 1E 104K-T	T	94.2/53.8
C666	4550007310	S.TAN F930J227MNM BMA	T	132.5/43.7
C667	4550007310	S.TAN F930J227MNM BMA	T	137.3/43.7
C671	4030011600	S.CER C1608 JB 1E 104K-T	T	148/48.2
C672	4030006880	S.CER C1608 JB 1H 472K-T	T	100.4/53.6
C702	4030011600	S.CER C1608 JB 1E 104K-T	T	130.9/35.3
C703	4030011600	S.CER C1608 JB 1E 104K-T	T	133.4/32.4
C720	4030006880	S.CER C1608 JB 1H 472K-T	T	127.9/19.6
C721	4030011600	S.CER C1608 JB 1E 104K-T	T	128.3/21.7
C722	4510008540	S.ELE EEE1CA100SR	T	127.6/25.6
C723	4030006880	S.CER C1608 JB 1H 472K-T	T	155/18.7
C724	4030011600	S.CER C1608 JB 1E 104K-T	T	155/19.9
C725	4510008540	S.ELE EEE1CA100SR	T	155.2/15.2
C726	4030006880	S.CER C1608 JB 1H 472K-T	T	149.4/25.7
C727	4030006880	S.CER C1608 JB 1H 472K-T	T	151.3/28.3
C730	4030011600	S.CER C1608 JB 1E 104K-T	T	129.2/16.8
C731	4030011600	S.CER C1608 JB 1E 104K-T	T	129.2/19.6
C733	4030011600	S.CER C1608 JB 1E 104K-T	T	138.5/7.8
C734	4030011600	S.CER C1608 JB 1E 104K-T	T	148.2/11.4
C736	4030011600	S.CER C1608 JB 1E 104K-T	T	141.9/26.3
C737	4030011600	S.CER C1608 JB 1E 104K-T	T	148.1/22.3
C738	4030011600	S.CER C1608 JB 1E 104K-T	T	141.8/7.8
C739	4030011600	S.CER C1608 JB 1E 104K-T	T	144.6/7.8
C740	4030011600	S.CER C1608 JB 1E 104K-T	T	148.1/18.9
C741	4030011600	S.CER C1608 JB 1E 104K-T	T	137.7/26.6
C742	4030011600	S.CER C1608 JB 1E 104K-T	T	135/26.6
C750	4030006900	S.CER C1608 JB 1H 103K-T	T	148.2/16
C751	4030006900	S.CER C1608 JB 1H 103K-T	T	150.2/18.8
C761	4030007150	S.CER C1608 CH 1H 151J-T	T	149.8/11.4
C762	4030007110	S.CER C1608 CH 1H 680J-T	T	151.8/8.9
C763	4030011280	S.CER C1608 CH 1H 271J-T	T	149.1/8.9
C764	4030007080	S.CER C1608 CH 1H 390J-T	T	153.6/8.4
C765	4030011830	S.CER C1608 CH 1H 301J-T	T	148.9/7.7
C766	4030007020	S.CER C1608 CH 1H 120J-T	T	149.3/5.9
C767	4030007170	S.CER C1608 CH 1H 221J-T	T	148.1/5.9
C768	4030011280	S.CER C1608 CH 1H 271J-T	T	137.1/1.9
C769	4030006860	S.CER C1608 JB 1H 102K-T	T	134.1/2.7
C770	4030011280	S.CER C1608 CH 1H 271J-T	T	132.2/2
C801	4030006880	S.CER C1608 JB 1H 472K-T	T	109.9/18.6
C802	4510008540	S.ELE EEE1CA100SR	T	112.7/23.4
C803	4030006900	S.CER C1608 JB 1H 103K-T	T	104/15.7
C805	4550003220	S.TAN TEESVA 1E 105M8R	T	102.1/17.3
C806	4340000240	S.MLR ECHU 1C 682JX5	T	107.8/21.9
C807	4030006880	S.CER C1608 JB 1H 472K-T	T	113.2/11.9
C808	4030006880	S.CER C1608 JB 1H 472K-T	T	160.9/15.2
C809	4510008540	S.ELE EEE1CA100SR	T	164/10.1
C810	4030006880	S.CER C1608 JB 1H 472K-T	T	117.5/21.4
C811	4030006880	S.CER C1608 JB 1H 472K-T	T	117/11.5
C812	4030006880	S.CER C1608 JB 1H 472K-T	T	117.5/9.5
C813	4030011600	S.CER C1608 JB 1E 104K-T	T	109.6/10.4
C821	4030007060	S.CER C1608 CH 1H 270J-T	T	101.4/25.1
C822	4030007100	S.CER C1608 CH 1H 560J-T	T	98/24.3
C823	4030006960	S.CER C1608 CH 1H 050C-T	T	99.3/24.3
C824	4610001850	S.TRI T2B4R200AB10R00	T	94.3/23.3
C825	4030007130	S.CER C1608 CH 1H 101J-T	T	90.6/25.4
C826	4030007060	S.CER C1608 CH 1H 270J-T	T	84.5/24.5
C827	4030007020	S.CER C1608 CH 1H 120J-T	T	89.1/23.2
C828	4030006880	S.CER C1608 JB 1H 472K-T	T	87.1/21.7
C829	4030009500	S.CER C1608 CH 1H 0R5B-T	T	81.6/21.5
C830	4030006860	S.CER C1608 JB 1H 102K-T	T	83.2/35.1
C831	4030006880	S.CER C1608 JB 1H 472K-T	T	83.2/33.9
C832	4510008500	S.ELE EEE1CA101WP	T	87.6/38.1

[SCOPE UNIT]

REF NO.	ORDER NO.	DESCRIPTION	M.	H/V LOCATION
C833	4510008540	S.ELE EEE1CA100SR	T	81.6/39.2
C842	4030006880	S.CER C1608 JB 1H 472K-T	T	83.1/13.6
C843	4030006880	S.CER C1608 JB 1H 472K-T	T	67.3/12.4
C844	4030006880	S.CER C1608 JB 1H 472K-T	T	68.6/12.4
C845	4510008520	S.ELE EEE1CA470SP	T	75.7/37.8
C846	4030006880	S.CER C1608 JB 1H 472K-T	T	82.1/19.9
C847	4030006880	S.CER C1608 JB 1H 472K-T	T	73/13.3
C848	4030006880	S.CER C1608 JB 1H 472K-T	T	73.1/19
C849	4030006880	S.CER C1608 JB 1H 472K-T	T	73.1/21.1
C850	4030006880	S.CER C1608 JB 1H 472K-T	T	68.8/20.2
C851	4030006880	S.CER C1608 JB 1H 472K-T	T	68.8/22.8
C852	4030007120	S.CER C1608 CH 1H 820J-T	T	68/26.5
C853	4030007070	S.CER C1608 CH 1H 330J-T	T	67.9/28.4
C854	4030007140	S.CER C1608 CH 1H 121J-T	T	73.7/26.5
C855	4030007020	S.CER C1608 CH 1H 120J-T	T	73.7/28.8
C856	4030007090	S.CER C1608 CH 1H 470J-T	T	73.8/31
C862	4030006880	S.CER C1608 JB 1H 472K-T	T	104/13.1
J1	6510007020	CNR TMP-J01X-V6		
J3	6510007020	CNR TMP-J01X-V6		
J11	6510007020	CNR TMP-J01X-V6		
J601	6510019971	S.CNR 52808-1071	T	102.1/32.4
J2013	6510023261	S.CNR B6B-PH-SM4-TB (LF) (SN)	T	173.1/32.6
J2016	6510020091	S.CNR 52808-0871 (0890)	T	5.9/25.6
J2017	6510019971	S.CNR 52808-1071	T	16.9/30.4
J2020	6510019991	S.CNR 52808-2271 (2291)	T	157.8/50.3
J2021	6510019981	S.CNR 52808-1671 (1690)	T	170.1/53.3
EP54	6910014690	S.BEA MPZ1608S221A-T	T	166.6/32.2
EP55	6910014690	S.BEA MPZ1608S221A-T	T	171.4/13.5
EP56	6910014690	S.BEA MPZ1608S221A-T	T	141.4/34.8
EP57	6910014690	S.BEA MPZ1608S221A-T	T	166.6/29.6
EP58	6910014690	S.BEA MPZ1608S221A-T	T	157.5/23.6
EP59	6910014690	S.BEA MPZ1608S221A-T	T	166.6/33.6
EP60	6910014690	S.BEA MPZ1608S221A-T	T	166.6/31

M.=Mounted side (T: Mounted on the Top side B: Mounted on the Bottom side)
S.=Surface mount

[LOGIC UNIT]

REF NO.	ORDER NO.	DESCRIPTION	M.	H/V LOCATION
IC1	1140011551	S.IC MT48LC16M16A2P-75	T	94.7/50.3
IC2	1140011551	S.IC MT48LC16M16A2P-75	T	94.7/34.2
IC51	1130011591	S.IC IDT70V24L15PFG	B	168/84.3
IC52	1140009781	S.IC XC9572XL-10TQG100C	B	139.7/86.9
IC53	1110005821	S.IC R3112N281A-TR-F	B	15/60.9
IC54	1130007431	S.IC TC7S14FU (TE85R,F)	B	19.8/61.9
IC55	1130008041	S.IC TC7SH04FU (TE85L,JF)	B	22.7/62.6
IC56	1130010111	S.IC TC7WH04FU (TE12L,F)	T	265/70.9
IC101	1130011010	S.IC SN74C85TLV3257PWR <ACE>	T	206.5/48.9
IC102	1130006441	S.IC TC7S08F (TE85R,F)	B	148.2/67.8
IC103	1140011561	S.IC HD6417751RBP200V	T	132.4/39.2
IC104	1130008361	S.IC TC7SHU04FU (TE85L,JF)	T	161.4/46.2
IC105	1130012241	S.IC CY2292FXC (SX-2590J)	B	158.2/43.8
IC106	1130011110	S.IC TC74VCX04FT (EL)	T	159.2/39.9
IC201	1140011551	S.IC MT48LC16M16A2P-75	T	78.8/82.8
IC202	1140011551	S.IC MT48LC16M16A2P-75	T	62.7/82.8
IC203	1140011571	S.IC HD64404BTDV	T	61/51.6
IC204	1140011581	S.IC ADV7123KSTZ50	B	77/9.2
IC205	1130011941	S.IC TC7SZ04F (TE85L,F)	B	82.1/16.3
IC206	1130012150	S.IC SN74ACT04PWR	B	104.5/4.8
IC208	1130014030	S.IC BD6516F-E2	T	22.3/73.4
IC209	1190001920	S.IC AK5355-VT-E2	B	94.3/78.7
IC210	1190001920	S.IC AK5355-VT-E2	B	104/78.7
IC211	1190001910	S.IC AK4384-VT-E2	B	110.7/78.7
IC212	1190001910	S.IC AK4384-VT-E2	B	116.6/78.7
IC403	1130009570	S.IC BR93LC46F-WE2	T	169/40.2
IC404	1130010990	S.IC RTL8139F <GMI>	B	180.9/41.9
IC601	1130008041	S.IC TC7SH04FU (TE85L,JF)	T	251.7/64
IC602	1130008711	S.IC TC7SET04FU (T5L,JF)	T	256.5/65
IC603	1110004770	S.IC BU9480F-E2	B	219.6/69.9
IC604	1140011590	S.IC HD64F2377VFG33V	B	198.4/77.7
IC605	1140009781	S.IC XC9572XL-10TQG100C	T	175.5/104
IC607	1130006441	S.IC TC7S08F (TE85R,F)	B	206.9/63.3
IC608	1130006441	S.IC TC7S08F (TE85R,F)	B	212.6/63.3
IC609	1130005252	S.IC TC74HC08AF (EL,F)	T	178/63.5
IC610	1140008650	S.IC HN58X2464T1	T	194.9/63.8
IC801	1180003170	S.REG uPC2933BT-E1-AZ	T	21.9/42.4
IC802	1180001541	S.IC TA78L08F (TE12L,F)	T	21.9/56.4
IC821	1110002700	S.IC NJM2904M-TE1-#FMZB	T	253.4/33.2
IC851	1110003870	S.IC NJM2058M-TE1	B	235.6/63.4
IC852	1110003870	S.IC NJM2058M-TE1	B	114.6/96.2
IC853	1110003870	S.IC NJM2058M-TE1	B	97.8/94.3
IC854	1130005721	S.IC TC7W04F (TE12L,F)	T	51.2/102.5
IC2051	1130009831	S.IC TC74VHCT04AF (F)	T	264.9/88.4
IC2052	1130005252	S.IC TC74HC08AF (EL,F)	B	264.9/94.7
IC2053	1130005721	S.IC TC7W04F (TE12L,F)	T	265/99.2
IC2054	1120002921	S.IC ADM202EARNZ	T	275.1/94.6
Q601	1530002060	S.TR 2SC4081 T106 R	T	256.8/71.4
Q602	1510000510	S.TR 2SA1576A T106R	T	251.7/67
Q802	1530002060	S.TR 2SC4081 T106 R	T	242.6/83.7
Q803	1540000441	S.TR 2SD1619T-TD-E	T	238.6/85.5
Q804	1540000441	S.TR 2SD1619T-TD-E	T	238.6/78.3
Q805	1530002060	S.TR 2SC4081 T106 R	T	242.6/76.5
Q810	1540000550	S.TR 2SD1664 T100Q	T	238.6/91.3
Q821	1520000651	S.TR 2SB1201S-TL-E	T	242.2/34.9
Q822	1530002060	S.TR 2SC4081 T106 R	T	247.8/38
Q901	1590001960	S.TR XP4311 (TX)	B	15.6/100.9
Q902	1590001960	S.TR XP4311 (TX)	B	5.7/100.2
Q2051	1510000510	S.TR 2SA1576A T106R	T	258.9/85.5
Q2052	1530002280	S.TR 2SC4081 T106 S	T	254.9/79.4
D51	1750000550	S.DIO 1SS355 TE-17	T	143.6/99.8
D52	1750000550	S.DIO 1SS355 TE-17	T	141.9/99.8
D53	1750000550	S.DIO 1SS355 TE-17	T	140.3/99.8
D54	1750000550	S.DIO 1SS355 TE-17	T	138.6/99.8
D55	1750000550	S.DIO 1SS355 TE-17	T	137/99.8
D56	1750000550	S.DIO 1SS355 TE-17	T	135.3/99.8
D57	1750000550	S.DIO 1SS355 TE-17	T	133.7/99.8
D58	1750000550	S.DIO 1SS355 TE-17	T	132/99.8
D59	1750000550	S.DIO 1SS355 TE-17	T	130.4/99.8
D60	1750000550	S.DIO 1SS355 TE-17	T	143.6/103.6
D61	1750000550	S.DIO 1SS355 TE-17	T	141.9/103.6
D62	1750000550	S.DIO 1SS355 TE-17	T	140.3/103.6
D63	1750000550	S.DIO 1SS355 TE-17	T	138.6/103.6
D64	1750000550	S.DIO 1SS355 TE-17	T	137/103.6
D65	1750000550	S.DIO 1SS355 TE-17	T	135.3/103.6
D66	1750000550	S.DIO 1SS355 TE-17	T	133.7/103.6
D67	1750000550	S.DIO 1SS355 TE-17	T	132/103.6
D68	1750000550	S.DIO 1SS355 TE-17	T	130.4/103.6
D201	1790000980	S.DIO MA742 (TX)	B	91.7/11.1
D202	1790000980	S.DIO MA742 (TX)	B	91.7/11.1
D203	1790000980	S.DIO MA742 (TX)	B	91.7/16.8
D204	1790000980	S.DIO MA742 (TX)	B	110.1/7.9
D205	1790000980	S.DIO MA742 (TX)	B	110.1/3
D206	1790000980	S.DIO MA742 (TX)	B	16/71.7
D207	1790000980	S.DIO MA742 (TX)	B	16/68.2
D208	1790000980	S.DIO MA742 (TX)	B	16/79.3
D209	1790000980	S.DIO MA742 (TX)	B	16/75.8
D601	1750000550	S.DIO 1SS355 TE-17	T	254.7/71.3
D801	1750000370	S.DIO DA221 TL	B	238.7/89.2
D802	1750000370	S.DIO DA221 TL	B	238.7/82
D805	1790001611	S.DIO 1SS385 (TE85L,F)	B	194.1/113.5
D821	1730002340	S.ZEN MA8047-M (TX)	T	247.9/35.1
D851	1750000550	S.DIO 1SS355 TE-17	B	241.9/67.6

[LOGIC UNIT]

REF NO.	ORDER NO.	DESCRIPTION	M.	H/V LOCATION
D852	1750000550	S.DIO 1SS355 TE-17	B	230.4/67.6
D853	1790000980	S.DIO MA742 (TX)	T	99.2/94
D854	1790000980	S.DIO MA742 (TX)	B	104.9/92.7
D855	1790000980	S.DIO MA742 (TX)	B	88.4/86.7
D856	1790000980	S.DIO MA742 (TX)	T	99.1/89.3
D857	1750000550	S.DIO 1SS355 TE-17	B	230.8/57.3
D858	1750000550	S.DIO 1SS355 TE-17	B	239.3/57.1
D860	1790000980	S.DIO MA742 (TX)	B	188.2/108.2
D861	1790000980	S.DIO MA742 (TX)	B	188.2/110.7
D862	1790000980	S.DIO MA742 (TX)	B	188.2/113.2
D863	1790000980	S.DIO MA742 (TX)	B	188.2/115.7
D864	1790000980	S.DIO MA742 (TX)	B	194.4/101.2
D865	1790000980	S.DIO MA742 (TX)	B	194.4/106.2
D866	1790000980	S.DIO MA742 (TX)	B	194.4/103.7
D867	1790000980	S.DIO MA742 (TX)	B	194.4/108.7
D901	1790000980	S.DIO MA742 (TX)	B	194.4/115.9
D2051	1750000550	S.DIO 1SS355 TE-17	T	257.1/79.5
X101	6050011610	S.XTL CR-751 (25.000 MHz)	T	160.6/52.4
X201	6050010690	S.XTL CR-628 (24.576 MHz)	T	42.9/56.6
X202	6050011910	S.XTL CR-780 (48 MHz)	T	79.6/52.9
X601	6050011810	S.XTL CR-755 (15.9744 MHz)	T	201.3/94.5
L203	6200002631	S.COL NLV25T-R10J	B	96/10.8
L204	6200002631	S.COL NLV25T-R10J	B	96/13.7
L205	6200002631	S.COL NLV25T-R10J	B	96/16.5
L801	6200003261	S.COL NLV32T-101J	T	223.7/32.2
L803	6180003321	S.COL SLF6028T-150M1R0-PF	T	200.8/35.7
L804	6180003321	S.COL SLF6028T-150M1R0-PF	T	198.2/27.6
L805	6180003321	S.COL SLF6028T-150M1R0-PF	T	191.7/27.7
L806	6180003321	S.COL SLF6028T-150M1R0-PF	T	176.6/16.1
L807	6180003321	S.COL SLF6028T-150M1R0-PF	T	200.8/5.9
L808	6200013300	S.COL SLF12555T-150M2R8-PF	T	197.8/16.4
L811	6200001831	S.COL NLV32T-100J	T	203.5/27.5
L826	6180003321	S.COL SLF6028T-150M1R0-PF	T	21.2/14.6
L2051	6200003241	S.COL NLV32T-221J	T	257.7/101.6
R1	7030003520	S.RES ERJ3GEYJ 472 V (4.7 k)	T	89.5/69.8
R51	7030003520	S.RES ERJ3GEYJ 472 V (4.7 k)	B	129.4/93.4
R52	7030003560	S.RES ERJ3GEYJ 103 V (10 k)	B	17.6/61.1
R55	7030003440	S.RES ERJ3GEYJ 102 V (1 k)	B	144.1/96.4
R56	7030003440	S.RES ERJ3GEYJ 102 V (1 k)	B	147.1/95.6
R57	7030003680	S.RES ERJ3GEYJ 104 V (100 k)	T	260.7/71.9
R58	7030003680	S.RES ERJ3GEYJ 104 V (100 k)	T	260.7/70.6
R101	7030003680	S.RES ERJ3GEYJ 104 V (100 k)	T	266.3/68.6
R102	7030003520	S.RES ERJ3GEYJ 472 V (4.7 k)	T	201.1/50.5
R103	7030003520	S.RES ERJ3GEYJ 472 V (4.7 k)	T	201.2/48.6
R104	7030003520	S.RES ERJ3GEYJ 472 V (4.7 k)	T	211.2/50.7
R105	7030003520	S.RES ERJ3GEYJ 472 V (4.7 k)	T	212/49.7
R106	7030003560	S.RES ERJ3GEYJ 103 V (10 k)	B	137.2/40.3
R107	7030003560	S.RES ERJ3GEYJ 103 V (10 k)	B	137.2/35.1
R108	7030003560	S.RES ERJ3GEYJ 103 V (10 k)	B	148.1/36.1
R109	7030003560	S.RES ERJ3GEYJ 103 V (10 k)	B	138.5/37.7
R110	7030003560	S.RES ERJ3GEYJ 103 V (10 k)	T	148/38.1
R111	7030003560	S.RES ERJ3GEYJ 103 V (10 k)	B	138.5/40.3
R112	7030003560	S.RES ERJ3GEYJ 103 V (10 k)	T	148/36.8
R113	7030003560	S.RES ERJ3GEYJ 103 V (10 k)	B	138.5/35.1
R114	7030003560	S.RES ERJ3GEYJ 103 V (10 k)	B	148.1/33.5
R115	7030003560	S.RES ERJ3GEYJ 103 V (10 k)	B	134.6/35.1
R116	7030003560	S.RES ERJ3GEYJ 103 V (10 k)	B	135.9/35.1
R117	7030003260	S.RES ERJ3GEYJ 330 V (33)	B	148.1/29.7
R118	7030003560	S.RES ERJ3GEYJ 103 V (10 k)	B	133.3/35.1
R119	7030003560	S.RES ERJ3GEYJ 103 V (10 k)	B	147.5/27.6
R120	7030003560	S.RES ERJ3GEYJ 103 V (10 k)	B	132/35.1
R121	7030003560	S.RES ERJ3GEYJ 103 V (10 k)	B	152/29.7
R122	7030003560	S.RES ERJ3GEYJ 103 V (10 k)	B	150.7/29.7
R123	7030003560	S.RES ERJ3GEYJ 103 V (10 k)	B	142.2/25
R124	7030003680	S.RES ERJ3GEYJ 104 V (100 k)	T	148/34.2
R125	7030003520	S.RES ERJ3GEYJ 472 V (4.7 k)	T	148/35.5
R126	7030003560	S.RES ERJ3GEYJ 103 V (10 k)	B	135.9/37.7
R127	7030003560	S.RES ERJ3GEYJ 103 V (10 k)	B	137.2/37.7
R128	7030003560	S.RES ERJ3GEYJ 103 V (10 k)	T	151.4/36.8
R129	7030003560	S.RES ERJ3GEYJ 103 V (10 k)	T	151.4/38.1
R130	7030003560	S.RES ERJ3GEYJ 103 V (10 k)	B	146.8/42
R131	7030003560	S.RES ERJ3GEYJ 103 V (10 k)	B	135.9/40.3
R132	7030003560	S.RES ERJ3GEYJ 103 V (10 k)	T	148/39.4
R133	7030003560	S.RES ERJ3GEYJ 103 V (10 k)	T	151.4/39.4
R134	7030003200	S.RES ERJ3GEYJ 100 V (10)	B	138.5/42.9
R135	7030003200	S.RES ERJ3GEYJ 100 V (10)	B	137.2/42.9
R136	7030003200	S.RES ERJ3GEYJ 100 V (10)	B	146.8/55.3
R137	7030004050	S.RES ERJ3GEYJ 1R0 V (1)	B	129.3/35.1
R138	7030003560	S.RES ERJ3GEYJ 103 V (10 k)	B	128/35.1
R139	7030003560	S.RES ERJ3GEYJ 103 V (10 k)	B	119.2/34.2
R140	7410000990	S.ARY EXB-V8V 470JV (47)	T	114.6/33.1
R141	7410000990	S.ARY EXB-V8V 470JV (47)	T	114.6/29.5
R142	7410000990	S.ARY EXB-V8V 470JV (47)	T	114.6/40.3
R143	7410000990	S.ARY EXB-V8V 470JV (47)	T	114.6/47.5
R144	7410000990	S.ARY EXB-V8V 470JV (47)	T	114.6/36.7
R145	7410000990	S.ARY EXB-V8V 470JV (47)	T	114.6/43.9
R146	7030003280	S.RES ERJ3GEYJ 470 V (47)	T	116/56.9
R147	7030003280	S.RES ERJ3GEYJ 470 V (47)	T	117.2/56.9
R148	7410000990	S.ARY EXB-V8V 470JV (47)	T	114.6/51.1
R149	7410000990	S.ARY EXB-V8V 470JV (47)	T	142.4/57
R150	7410000990	S.ARY EXB-V8V 470JV (47)	T	138.8/57
R151	7410000990			

[LOGIC UNIT]

REF NO.	ORDER NO.	DESCRIPTION	M.	H/V LOCATION
R158	7030003560	S.RES ERJ3GEYJ 103 V (10 k)	T	147.8/67.9
R159	7030003560	S.RES ERJ3GEYJ 103 V (10 k)	T	147.8/69.2
R161	7030003250	S.RES ERJ3GEYJ 270 V (27)	B	160.2/49.5
R162	7030003800	S.RES ERJ3GEYJ 105 V (1 M)	T	159.9/48
R163	7030003320	S.RES ERJ3GEYJ 101 V (100)	T	154.5/40.3
R164	7030003250	S.RES ERJ3GEYJ 270 V (27)	B	162.7/42.6
R165	7030003340	S.RES ERJ3GEYJ 151 V (150)	T	159.9/49.2
R166	7030003860	S.RES ERJ3GE JPW V	T	159.4/35.9
R167	7030003860	S.RES ERJ3GE JPW V	T	158.2/35.9
R170	7030003600	S.RES ERJ3GEYJ 223 V (22 k)	T	134.5/23.5
R171	7030003600	S.RES ERJ3GEYJ 223 V (22 k)	T	133.2/23.5
R172	7030003600	S.RES ERJ3GEYJ 223 V (22 k)	T	128/23.5
R173	7030003600	S.RES ERJ3GEYJ 223 V (22 k)	T	129.3/23.5
R174	7030003600	S.RES ERJ3GEYJ 223 V (22 k)	T	130.6/23.5
R175	7030003600	S.RES ERJ3GEYJ 223 V (22 k)	T	131.9/23.5
R176	7030003600	S.RES ERJ3GEYJ 223 V (22 k)	T	126.7/23.5
R201	7030003560	S.RES ERJ3GEYJ 103 V (10 k)	T	50.4/68.8
R202	7030003560	S.RES ERJ3GEYJ 103 V (10 k)	T	50.4/65.6
R203	7030003560	S.RES ERJ3GEYJ 103 V (10 k)	T	49.1/72.7
R204	7030003560	S.RES ERJ3GEYJ 103 V (10 k)	T	50.4/72.7
R205	7030003560	S.RES ERJ3GEYJ 103 V (10 k)	T	53/68.8
R206	7030003560	S.RES ERJ3GEYJ 103 V (10 k)	T	51.7/65.6
R207	7030003560	S.RES ERJ3GEYJ 103 V (10 k)	T	51.7/72.7
R208	7030003560	S.RES ERJ3GEYJ 103 V (10 k)	T	53/72.7
R209	7030003560	S.RES ERJ3GEYJ 103 V (10 k)	T	51.7/68.8
R212	7030003640	S.RES ERJ3GEYJ 473 V (47 k)	T	56.9/37.3
R213	7030003640	S.RES ERJ3GEYJ 473 V (47 k)	T	54.3/37.3
R218	7030003520	S.RES ERJ3GEYJ 472 V (4.7 k)	T	80.8/63.5
R219	7030003520	S.RES ERJ3GEYJ 472 V (4.7 k)	T	82/64.8
R220	7030003520	S.RES ERJ3GEYJ 472 V (4.7 k)	B	64.9/48.4
R221	7030003560	S.RES ERJ3GEYJ 103 V (10 k)	T	67.2/38
R225	7030003560	S.RES ERJ3GEYJ 103 V (10 k)	B	59.7/48.4
R226	7030003560	S.RES ERJ3GEYJ 103 V (10 k)	B	58.4/48.4
R227	7030003560	S.RES ERJ3GEYJ 103 V (10 k)	T	41.4/44.6
R228	7030003560	S.RES ERJ3GEYJ 103 V (10 k)	T	44.4/44.6
R229	7030003560	S.RES ERJ3GEYJ 103 V (10 k)	T	47.5/43.9
R230	7030003560	S.RES ERJ3GEYJ 103 V (10 k)	T	44.4/45.9
R231	7030003560	S.RES ERJ3GEYJ 103 V (10 k)	T	47.5/45.2
R232	7030003560	S.RES ERJ3GEYJ 103 V (10 k)	B	56.1/47.6
R233	7030003560	S.RES ERJ3GEYJ 103 V (10 k)	T	41.4/45.9
R234	7030003560	S.RES ERJ3GEYJ 103 V (10 k)	T	47.5/46.5
R235	7030003560	S.RES ERJ3GEYJ 103 V (10 k)	T	44.4/47.2
R236	7030003560	S.RES ERJ3GEYJ 103 V (10 k)	T	41.4/47.2
R237	7030003560	S.RES ERJ3GEYJ 103 V (10 k)	B	56.1/48.9
R238	7030003560	S.RES ERJ3GEYJ 103 V (10 k)	T	47.5/47.8
R239	7030003560	S.RES ERJ3GEYJ 103 V (10 k)	T	44.4/48.5
R240	7030003560	S.RES ERJ3GEYJ 103 V (10 k)	T	41.4/48.5
R241	7030003560	S.RES ERJ3GEYJ 103 V (10 k)	B	50/51.9
R242	7030003560	S.RES ERJ3GEYJ 103 V (10 k)	T	47.5/49.2
R243	7030003560	S.RES ERJ3GEYJ 103 V (10 k)	B	56.1/50.2
R244	7030003560	S.RES ERJ3GEYJ 103 V (10 k)	T	74.6/49.2
R245	7030003560	S.RES ERJ3GEYJ 103 V (10 k)	T	74.6/42.7
R246	7030003560	S.RES ERJ3GEYJ 103 V (10 k)	T	78.3/41.4
R247	7030003560	S.RES ERJ3GEYJ 103 V (10 k)	B	64.9/51
R248	7030003560	S.RES ERJ3GEYJ 103 V (10 k)	T	74.6/44
R249	7030003560	S.RES ERJ3GEYJ 103 V (10 k)	T	74.6/38.8
R250	7030003560	S.RES ERJ3GEYJ 103 V (10 k)	T	74.6/40.1
R251	7030003560	S.RES ERJ3GEYJ 103 V (10 k)	T	78.3/42.7
R252	7030003560	S.RES ERJ3GEYJ 103 V (10 k)	T	78.3/40.1
R253	7030003560	S.RES ERJ3GEYJ 103 V (10 k)	T	68.4/38
R254	7030003560	S.RES ERJ3GEYJ 103 V (10 k)	T	74.6/41.4
R255	7030003560	S.RES ERJ3GEYJ 103 V (10 k)	T	78.3/38.8
R256	7030003560	S.RES ERJ3GEYJ 103 V (10 k)	B	62.3/51
R257	7030003560	S.RES ERJ3GEYJ 103 V (10 k)	T	74.6/45.3
R258	7030003560	S.RES ERJ3GEYJ 103 V (10 k)	B	61/51
R259	7030003560	S.RES ERJ3GEYJ 103 V (10 k)	T	78.3/45.3
R260	7030003560	S.RES ERJ3GEYJ 103 V (10 k)	B	59.7/51
R261	7030003560	S.RES ERJ3GEYJ 103 V (10 k)	T	78.3/46.6
R262	7030003560	S.RES ERJ3GEYJ 103 V (10 k)	B	58.4/51
R263	7030003560	S.RES ERJ3GEYJ 103 V (10 k)	B	72.9/47.4
R264	7030003560	S.RES ERJ3GEYJ 103 V (10 k)	B	66.8/52.3
R265	7030003560	S.RES ERJ3GEYJ 103 V (10 k)	T	80.9/46.6
R266	7030003560	S.RES ERJ3GEYJ 103 V (10 k)	T	80.9/45.3
R267	7030003560	S.RES ERJ3GEYJ 103 V (10 k)	T	74.6/47.9
R268	7030003560	S.RES ERJ3GEYJ 103 V (10 k)	B	72.9/44.8
R269	7030003560	S.RES ERJ3GEYJ 103 V (10 k)	T	74.6/46.6
R270	7030003560	S.RES ERJ3GEYJ 103 V (10 k)	T	78.3/44
R271	7030003560	S.RES ERJ3GEYJ 103 V (10 k)	T	80.9/44
R272	7030003560	S.RES ERJ3GEYJ 103 V (10 k)	T	77.4/62
R273	7030003560	S.RES ERJ3GEYJ 103 V (10 k)	T	77.4/60.8
R274	7030003560	S.RES ERJ3GEYJ 103 V (10 k)	B	59.7/54.1
R275	7030003560	S.RES ERJ3GEYJ 103 V (10 k)	T	74.6/63.2
R276	7030003560	S.RES ERJ3GEYJ 103 V (10 k)	T	74.6/60.8
R277	7030003560	S.RES ERJ3GEYJ 103 V (10 k)	T	74.6/59.6
R278	7030003560	S.RES ERJ3GEYJ 103 V (10 k)	T	74.6/58.4
R279	7030003560	S.RES ERJ3GEYJ 103 V (10 k)	B	58.4/54.1
R280	7030003560	S.RES ERJ3GEYJ 103 V (10 k)	T	77.4/63.2
R281	7030003560	S.RES ERJ3GEYJ 103 V (10 k)	B	64.2/54.9
R282	7030003560	S.RES ERJ3GEYJ 103 V (10 k)	B	64.2/53.6
R283	7030003560	S.RES ERJ3GEYJ 103 V (10 k)	B	73.7/59.7
R284	7030003560	S.RES ERJ3GEYJ 103 V (10 k)	B	73.7/58.4
R285	7030003560	S.RES ERJ3GEYJ 103 V (10 k)	B	61/54.1
R286	7030003560	S.RES ERJ3GEYJ 103 V (10 k)	T	77.4/59.6
R287	7030003560	S.RES ERJ3GEYJ 103 V (10 k)	T	74.6/56
R288	7030003560	S.RES ERJ3GEYJ 103 V (10 k)	T	77.4/57.2
R289	7030003560	S.RES ERJ3GEYJ 103 V (10 k)	T	74.6/54.8
R290	7030003560	S.RES ERJ3GEYJ 103 V (10 k)	B	62.3/54.1
R291	7030003560	S.RES ERJ3GEYJ 103 V (10 k)	T	74.6/57.2
R292	7030003560	S.RES ERJ3GEYJ 103 V (10 k)	B	63.6/48.4
R293	7030003560	S.RES ERJ3GEYJ 103 V (10 k)	B	62.3/48.4
R294	7030003560	S.RES ERJ3GEYJ 103 V (10 k)	B	61/48.4
R295	7030003640	S.RES ERJ3GEYJ 473 V (47 k)	B	63.6/51
R296	7030003560	S.RES ERJ3GEYJ 103 V (10 k)	T	47.8/65.6
R297	7030003560	S.RES ERJ3GEYJ 103 V (10 k)	T	43.9/65.6

[LOGIC UNIT]

REF NO.	ORDER NO.	DESCRIPTION	M.	H/V LOCATION
R298	7030003560	S.RES ERJ3GEYJ 103 V (10 k)	T	43.9/72.7
R299	7030003560	S.RES ERJ3GEYJ 103 V (10 k)	T	45.2/65.6
R300	7030003560	S.RES ERJ3GEYJ 103 V (10 k)	T	45.2/68.8
R301	7030003560	S.RES ERJ3GEYJ 103 V (10 k)	T	45.2/72.7
R302	7030003560	S.RES ERJ3GEYJ 103 V (10 k)	T	43.9/68.8
R303	7030003560	S.RES ERJ3GEYJ 103 V (10 k)	T	46.5/72.7
R304	7030003560	S.RES ERJ3GEYJ 103 V (10 k)	T	46.5/68.8
R305	7030003560	S.RES ERJ3GEYJ 103 V (10 k)	T	46.5/65.6
R306	7030003560	S.RES ERJ3GEYJ 103 V (10 k)	T	49.1/65.6
R307	7030003560	S.RES ERJ3GEYJ 103 V (10 k)	T	49.1/68.8
R308	7030003560	S.RES ERJ3GEYJ 103 V (10 k)	T	47.8/72.7
R309	7030003560	S.RES ERJ3GEYJ 103 V (10 k)	T	47.8/68.8
R310	7030003560	S.RES ERJ3GEYJ 103 V (10 k)	T	74.6/62
R311	7030003560	S.RES ERJ3GEYJ 103 V (10 k)	T	77.4/58.4
R313	7030003410	S.RES ERJ3GEYJ 561 V (560)	B	79/3.2
R314	7030003340	S.RES ERJ3GEYJ 151 V (150)	B	88.5/11.3
R315	7030003340	S.RES ERJ3GEYJ 151 V (150)	B	89.8/11.3
R316	7030003340	S.RES ERJ3GEYJ 151 V (150)	B	88.5/13.9
R317	7030003340	S.RES ERJ3GEYJ 151 V (150)	B	89.8/13.9
R318	7030003340	S.RES ERJ3GEYJ 151 V (150)	B	88.5/16.5
R319	7030003340	S.RES ERJ3GEYJ 151 V (150)	B	93.6/16.7
R320	7030003240	S.RES ERJ3GEYJ 220 V (22)	B	110/6.1
R321	7030003240	S.RES ERJ3GEYJ 220 V (22)	B	110/4.8
R322	7030003250	S.RES ERJ3GEYJ 270 V (27)	B	13.2/70.6
R323	7030003250	S.RES ERJ3GEYJ 270 V (27)	B	13.2/69.3
R324	7030003580	S.RES ERJ3GEYJ 153 V (15 k)	B	12.5/72.4
R325	7030003580	S.RES ERJ3GEYJ 153 V (15 k)	B	12.5/67.4
R326	7030003250	S.RES ERJ3GEYJ 270 V (27)	B	13.2/78.2
R327	7030003250	S.RES ERJ3GEYJ 270 V (27)	B	13.2/76.9
R328	7030003580	S.RES ERJ3GEYJ 153 V (15 k)	B	12.5/80
R329	7030003580	S.RES ERJ3GEYJ 153 V (15 k)	B	12.5/75
R330	7030003560	S.RES ERJ3GEYJ 103 V (10 k)	B	21.6/70.6
R331	7030003560	S.RES ERJ3GEYJ 103 V (10 k)	B	22.9/70.6
R332	7030003640	S.RES ERJ3GEYJ 473 V (47 k)	B	96.9/84.2
R333	7030003640	S.RES ERJ3GEYJ 473 V (47 k)	B	93.7/73.3
R334	7030003640	S.RES ERJ3GEYJ 473 V (47 k)	T	94/78.7
R335	7030003280	S.RES ERJ3GEYJ 470 V (47)	B	95.5/73.3
R336	7030003640	S.RES ERJ3GEYJ 473 V (47 k)	B	106.4/84.2
R337	7030003640	S.RES ERJ3GEYJ 473 V (47 k)	B	103.4/73.3
R338	7030003640	S.RES ERJ3GEYJ 473 V (47 k)	T	103.5/78.7
R339	7030003280	S.RES ERJ3GEYJ 470 V (47)	B	105.2/73.3
R340	7030003280	S.RES ERJ3GEYJ 470 V (47)	B	113/73.3
R341	7030003640	S.RES ERJ3GEYJ 473 V (47 k)	B	110.1/73.3
R342	7030003280	S.RES ERJ3GEYJ 470 V (47)	B	118.9/73.3
R343	7030003640	S.RES ERJ3GEYJ 473 V (47 k)	B	116.1/73.3
R344	7030003520	S.RES ERJ3GEYJ 472 V (4.7 k)	B	108.2/84.2
R345	7030003520	S.RES ERJ3GEYJ 472 V (4.7 k)	B	113.7/84.2
R346	7030003560	S.RES ERJ3GEYJ 103 V (10 k)	B	109.4/84.2
R347	7030003860	S.RES ERJ3GE JPW V	T	20.4/66.7
R348	7030003860	S.RES ERJ3GE JPW V	T	24.2/67.1
R350	7030003860	S.RES ERJ3GE JPW V	T	80.7/62.6
R351	7030003860	S.RES ERJ3GE JPW V	B	56.1/54.9
R353	7030003860	S.RES ERJ3GE JPW V	T	60.7/28.5
R355	7030003860	S.RES ERJ3GE JPW V	T	59.3/28.5
R356	7030003860	S.RES ERJ3GE JPW V	T	62/25.4
R357	7030003860	S.RES ERJ3GE JPW V	B	99.8/11.4
R358	7030003860	S.RES ERJ3GE JPW V	B	99.8/14.4
R359	7030003860	S.RES ERJ3GE JPW V	B	99.8/17.4
R360	7030003860	S.RES ERJ3GE JPW V	B	117.6/3.2
R361	7030003320	S.RES ERJ3GEYJ 101 V (100)	B	79.7/16.6
R371	7030003200	S.RES ERJ3GEYJ 100 V (10)	B	46.5/47.7
R372	7030003200	S.RES ERJ3GEYJ 100 V (10)	B	43.2/44.5
R373	7030003200	S.RES ERJ3GEYJ 100 V (10)	B	44.3/47.7
R374	7030003200	S.RES ERJ3GEYJ 100 V (10)	B	42.1/47.7
R375	7030003200	S.RES ERJ3GEYJ 100 V (10)	B	37.7/47.7
R376	7030003200	S.RES ERJ3GEYJ 100 V (10)	B	41/44.5
R377	7030003200	S.RES ERJ3GEYJ 100 V (10)	B	39.9/47.7
R378	7030003200	S.RES ERJ3GEYJ 100 V (10)	B	36.6/44.5
R379	7030003200	S.RES ERJ3GEYJ 100 V (10)	B	38.8/44.5
R380	7030003200	S.RES ERJ3GEYJ 100 V (10)	B	35.5/47.7
R381	7030003200	S.RES ERJ3GEYJ 100 V (10)	B	45.4/44.5
R382	7030003200	S.RES ERJ3GEYJ 100 V (10)	B	52.8/37.1
R383	7030003200	S.RES ERJ3GEYJ 100 V (10)	B	49.6/34.1
R384	7030003200	S.RES ERJ3GEYJ 100 V (10)	B	50.6/37.1
R385	7030003200	S.RES ERJ3GEYJ 100 V (10)	B	47.4/34.1
R386	7030003200	S.RES ERJ3GEYJ 100 V (10)	B	48.4/37.1
R387	7030003200	S.RES ERJ3GEYJ 100 V (10)		

[LOGIC UNIT]

REF NO.	ORDER NO.	DESCRIPTION	M.	H/V LOCATION
R601	7030003620	S.RES ERJ3GEYJ 333 V (33 k)	T	254.7/68.3
R602	7030003590	S.RES ERJ3GEYJ 183 V (18 k)	T	257.1/67.9
R603	7030003540	S.RES ERJ3GEYJ 682 V (6.8 k)	T	253.5/66.8
R604	7030003640	S.RES ERJ3GEYJ 473 V (47 k)	T	249.9/65.4
R605	7030003680	S.RES ERJ3GEYJ 104 V (100 k)	T	255.8/62.8
R606	7030003680	S.RES ERJ3GEYJ 104 V (100 k)	T	251.8/61.6
R607	7030003350	S.RES ERJ3GEYJ 181 V (180)	B	198.6/92
R608	7030003520	S.RES ERJ3GEYJ 472 V (4.7 k)	B	196/92
R609	7030003440	S.RES ERJ3GEYJ 102 V (1 k)	B	216.6/85.1
R610	7030003440	S.RES ERJ3GEYJ 102 V (1 k)	B	216.6/83.9
R611	7030003440	S.RES ERJ3GEYJ 102 V (1 k)	B	216.6/82.7
R612	7030003440	S.RES ERJ3GEYJ 102 V (1 k)	B	216.6/81.5
R613	7030003440	S.RES ERJ3GEYJ 102 V (1 k)	B	216.6/80.3
R614	7030003440	S.RES ERJ3GEYJ 102 V (1 k)	B	216.6/79.1
R615	7030003440	S.RES ERJ3GEYJ 102 V (1 k)	B	216.6/77.9
R616	7030003440	S.RES ERJ3GEYJ 102 V (1 k)	B	216.6/76.7
R617	7030003800	S.RES ERJ3GEYJ 105 V (1 M)	T	217.9/76.7
R618	7030003800	S.RES ERJ3GEYJ 105 V (1 M)	T	217.9/77.9
R619	7030003800	S.RES ERJ3GEYJ 105 V (1 M)	T	217.9/79.1
R620	7030003800	S.RES ERJ3GEYJ 105 V (1 M)	T	217.9/80.3
R621	7030003800	S.RES ERJ3GEYJ 105 V (1 M)	T	217.9/81.5
R622	7030003800	S.RES ERJ3GEYJ 105 V (1 M)	T	217.9/82.7
R623	7030003800	S.RES ERJ3GEYJ 105 V (1 M)	T	217.9/83.9
R624	7030003800	S.RES ERJ3GEYJ 105 V (1 M)	T	217.9/85.1
R625	7030003640	S.RES ERJ3GEYJ 223 V (22 k)	B	212.5/77.3
R626	7030003600	S.RES ERJ3GEYJ 223 V (22 k)	B	212.5/76
R627	7030003640	S.RES ERJ3GEYJ 473 V (47 k)	T	205.3/73.2
R628	7030003640	S.RES ERJ3GEYJ 473 V (47 k)	T	205.3/74.6
R629	7030003640	S.RES ERJ3GEYJ 473 V (47 k)	B	212.4/72.5
R630	7030003520	S.RES ERJ3GEYJ 472 V (4.7 k)	T	229.2/86.5
R631	7030003520	S.RES ERJ3GEYJ 472 V (4.7 k)	T	229.2/85.3
R632	7030003520	S.RES ERJ3GEYJ 472 V (4.7 k)	T	229.2/84.1
R633	7030003520	S.RES ERJ3GEYJ 472 V (4.7 k)	T	229.2/82.9
R634	7030003520	S.RES ERJ3GEYJ 472 V (4.7 k)	T	229.2/81.7
R635	7030003520	S.RES ERJ3GEYJ 472 V (4.7 k)	T	229.2/80.5
R636	7030003640	S.RES ERJ3GEYJ 473 V (47 k)	B	209.2/62.9
R637	7030003640	S.RES ERJ3GEYJ 473 V (47 k)	B	214.9/62.9
R639	7030003640	S.RES ERJ3GEYJ 473 V (47 k)	T	211.8/59.2
R640	7030003640	S.RES ERJ3GEYJ 473 V (47 k)	T	216.7/52.2
R641	7030003640	S.RES ERJ3GEYJ 473 V (47 k)	T	218/52.2
R642	7030003640	S.RES ERJ3GEYJ 473 V (47 k)	T	219.2/52.2
R643	7030003600	S.RES ERJ3GEYJ 223 V (22 k)	T	200.7/64.2
R644	7030003560	S.RES ERJ3GEYJ 103 V (10 k)	T	201.9/64.2
R645	7030003520	S.RES ERJ3GEYJ 472 V (4.7 k)	B	190.4/63.5
R646	7030003720	S.RES ERJ3GEYJ 224 V (220 k)	B	183.7/88.4
R647	7030003720	S.RES ERJ3GEYJ 224 V (220 k)	B	183.7/86.5
R648	7030003720	S.RES ERJ3GEYJ 224 V (220 k)	B	183.7/85.2
R649	7030003720	S.RES ERJ3GEYJ 224 V (220 k)	B	183.7/83.9
R650	7030003720	S.RES ERJ3GEYJ 224 V (220 k)	B	183.7/82.6
R651	7030003720	S.RES ERJ3GEYJ 224 V (220 k)	B	183.7/81.3
R652	7030003720	S.RES ERJ3GEYJ 224 V (220 k)	B	183.7/80
R653	7030003720	S.RES ERJ3GEYJ 224 V (220 k)	B	183.7/78.7
R654	7030003520	S.RES ERJ3GEYJ 472 V (4.7 k)	B	183.7/67.3
R655	7030003520	S.RES ERJ3GEYJ 472 V (4.7 k)	B	183.7/66.6
R656	7030003520	S.RES ERJ3GEYJ 472 V (4.7 k)	T	181.9/114.5
R657	7030003720	S.RES ERJ3GEYJ 224 V (220 k)	B	212.5/78.6
R658	7030003640	S.RES ERJ3GEYJ 473 V (47 k)	T	195.4/71.3
R660	7030003640	S.RES ERJ3GEYJ 473 V (47 k)	T	193.7/79.4
R661	7030003640	S.RES ERJ3GEYJ 473 V (47 k)	T	205.3/77.4
R662	7030003640	S.RES ERJ3GEYJ 473 V (47 k)	T	195.9/83.2
R663	7030003640	S.RES ERJ3GEYJ 473 V (47 k)	T	207.7/84.2
R665	7030003560	S.RES ERJ3GEYJ 103 V (10 k)	T	194.3/83.2
R666	7030003560	S.RES ERJ3GEYJ 103 V (10 k)	T	206.3/84.2
R668	7030003640	S.RES ERJ3GEYJ 473 V (47 k)	B	200.5/92
R669	7030003640	S.RES ERJ3GEYJ 473 V (47 k)	T	205.3/76
R670	7030003640	S.RES ERJ3GEYJ 473 V (47 k)	B	189.1/63.5
R671	7030003640	S.RES ERJ3GEYJ 473 V (47 k)	B	187.8/63.5
R672	7030003640	S.RES ERJ3GEYJ 473 V (47 k)	B	206.6/92
R674	7030003640	S.RES ERJ3GEYJ 473 V (47 k)	B	194.3/63.5
R675	7030003640	S.RES ERJ3GEYJ 473 V (47 k)	B	193/63.5
R676	7030003640	S.RES ERJ3GEYJ 473 V (47 k)	B	193.4/92
R677	7030003520	S.RES ERJ3GEYJ 472 V (4.7 k)	T	171.5/115
R678	7030003720	S.RES ERJ3GEYJ 224 V (220 k)	B	212.5/79.9
R679	7030003640	S.RES ERJ3GEYJ 473 V (47 k)	B	194.7/92
R680	7030003520	S.RES ERJ3GEYJ 472 V (4.7 k)	T	172.8/115
R681	7030003520	S.RES ERJ3GEYJ 472 V (4.7 k)	T	169.9/115
R687	7030003520	S.RES ERJ3GEYJ 472 V (4.7 k)	T	164.5/101.7
R689	7030003520	S.RES ERJ3GEYJ 472 V (4.7 k)	T	164.5/105.1
R690	7030003520	S.RES ERJ3GEYJ 472 V (4.7 k)	T	164.5/103.8
R691	7030003640	S.RES ERJ3GEYJ 473 V (47 k)	T	172.7/64.1
R692	7030003520	S.RES ERJ3GEYJ 472 V (4.7 k)	T	164.5/108.5
R693	7030003520	S.RES ERJ3GEYJ 472 V (4.7 k)	T	164.5/109.8
R694	7030003640	S.RES ERJ3GEYJ 473 V (47 k)	T	28.3/87.7
R695	7030003640	S.RES ERJ3GEYJ 473 V (47 k)	T	19.5/88.7
R696	7030003520	S.RES ERJ3GEYJ 472 V (4.7 k)	T	164.5/100.2
R697	7030003520	S.RES ERJ3GEYJ 472 V (4.7 k)	T	166.2/112.8
R701	7030003860	S.RES ERJ3GE JPW V	B	191.7/63.5
R703	7030003640	S.RES ERJ3GEYJ 473 V (47 k)	B	197.5/63.9
R801	7030003560	S.RES ERJ3GEYJ 103 V (10 k)	T	245.6/83
R802	7030006210	S.RES ERJ12YJ4R7U (4.7)	B	236.9/85.2
R803	7030003440	S.RES ERJ3GEYJ 102 V (1 k)	B	238.6/87.6
R804	7030006210	S.RES ERJ12YJ4R7U (4.7)	B	236.9/78
R805	7030003440	S.RES ERJ3GEYJ 102 V (1 k)	B	238.6/80.4
R806	7030003560	S.RES ERJ3GEYJ 103 V (10 k)	T	242.7/74.7
R808	7030003860	S.RES ERJ3GE JPW V	T	196.1/6.6
R811	7030008240	S.RES ERJ12Y0R00U	T	41.7/30.8
R812	7030010440	S.RES ERJ1TYJ 680U (68)	T	30/44.2
R813	7030003560	S.RES ERJ3GEYJ 103 V (10 k)	T	10.4/12.6
R814	7030003440	S.RES ERJ3GEYJ 102 V (1 k)	T	209.1/34.6
R816	7030003560	S.RES ERJ3GEYJ 103 V (10 k)	T	242.5/93.1
R817	7030003560	S.RES ERJ3GEYJ 103 V (10 k)	T	242.5/91.9
R818	7030000140	S.RES MCR10EZJH 10 (100)	T	235.3/90.1
R819	7030007190	S.RES ERJ12YJ220U (22)	T	28.9/51.6
R821	7030003370	S.RES ERJ3GEYJ 271 V (270)	T	258.7/37.2

[LOGIC UNIT]

REF NO.	ORDER NO.	DESCRIPTION	M.	H/V LOCATION
R822	7030009720	S.RES ERJ12YJ102U (1 k)	T	258.7/32.5
R823	7030003810	S.RES ERJ3GEYJ 125 V (1.2 M)	T	254.5/28
R824	7030003810	S.RES ERJ3GEYJ 125 V (1.2 M)	T	250/33.4
R825	7030008170	S.RES ERJ12YJ1R0U (1)	T	247.5/29.9
R826	7030003610	S.RES ERJ3GEYJ 273 V (27 k)	T	251.9/28
R827	7030003610	S.RES ERJ3GEYJ 273 V (27 k)	T	250/30.7
R828	7030003560	S.RES ERJ3GEYJ 103 V (10 k)	T	257.1/38.8
R829	7030000340	S.RES MCR10EZJH 470 (47)	T	247.8/40.1
R830	7030003600	S.RES ERJ3GEYJ 223 V (22 k)	T	255.2/38.1
R832	7030003600	S.RES ERJ3GEYJ 223 V (22 k)	T	254.4/39.9
R833	7030003560	S.RES ERJ3GEYJ 103 V (10 k)	T	252.6/38.1
R841	7030003480	S.RES ERJ3GEYJ 222 V (2.2 k)	B	113.3/101.9
R842	7030003640	S.RES ERJ3GEYJ 473 V (47 k)	B	111.4/101.2
R843	7030003380	S.RES ERJ3GEYJ 331 V (330)	B	110.2/102.7
R850	7030003860	S.RES ERJ3GE JPW V	B	239.9/68.4
R851	7030003680	S.RES ERJ3GEYJ 104 V (100 k)	B	235.3/55.9
R854	7030003770	S.RES ERJ3GEYJ 564 V (560 k)	B	233.8/57.3
R855	7030003520	S.RES ERJ3GEYJ 472 V (4.7 k)	B	230.5/55.8
R857	7030003560	S.RES ERJ3GEYJ 103 V (10 k)	B	111.1/87.7
R858	7030003460	S.RES ERJ3GEYJ 152 V (1.5 k)	B	111.1/88.9
R859	7030003470	S.RES ERJ3GEYJ 182 V (1.8 k)	B	112.6/90.1
R860	7030003500	S.RES ERJ3GEYJ 332 V (3.3 k)	B	108.8/94.9
R861	7030003480	S.RES ERJ3GEYJ 222 V (2.2 k)	B	111.4/91.3
R862	7030003480	S.RES ERJ3GEYJ 222 V (2.2 k)	B	108.8/91.3
R863	7030003560	S.RES ERJ3GEYJ 103 V (10 k)	B	118.1/87.7
R864	7030003460	S.RES ERJ3GEYJ 152 V (1.5 k)	B	118.1/88.9
R865	7030003470	S.RES ERJ3GEYJ 182 V (1.8 k)	B	116.6/90.1
R866	7030003500	S.RES ERJ3GEYJ 332 V (3.3 k)	B	120.4/94.9
R867	7030003480	S.RES ERJ3GEYJ 222 V (2.2 k)	B	117.9/91.3
R868	7030003380	S.RES ERJ3GEYJ 331 V (330)	B	120.5/91.3
R869	7030003560	S.RES ERJ3GEYJ 103 V (10 k)	B	114.9/84.2
R871	7030003680	S.RES ERJ3GEYJ 104 V (100 k)	B	236.9/57.8
R872	7030003770	S.RES ERJ3GEYJ 564 V (560 k)	B	238.9/58.5
R873	7030003520	S.RES ERJ3GEYJ 472 V (4.7 k)	B	241.5/56.3
R874	7030003540	S.RES ERJ3GEYJ 682 V (6.8 k)	B	240.3/55.1
R876	7030003410	S.RES ERJ3GEYJ 561 V (560)	B	91.8/97.8
R877	7030003700	S.RES ERJ3GEYJ 154 V (150 k)	B	94.5/99.2
R878	7030003520	S.RES ERJ3GEYJ 472 V (4.7 k)	B	95.3/101.1
R879	7030003550	S.RES ERJ3GEYJ 822 V (8.2 k)	B	103.7/99.2
R880	7030003690	S.RES ERJ3GEYJ 124 V (120 k)	B	101.1/99.2
R881	7030003520	S.RES ERJ3GEYJ 472 V (4.7 k)	B	101.1/101.6
R882	7030003410	S.RES ERJ3GEYJ 561 V (560)	B	91.6/87.2
R883	7030003550	S.RES ERJ3GEYJ 822 V (8.2 k)	B	92.1/89.3
R884	7030003520	S.RES ERJ3GEYJ 472 V (4.7 k)	B	92.9/87.2
R885	7030003410	S.RES ERJ3GEYJ 561 V (560)	B	103.7/89.4
R886	7030003550	S.RES ERJ3GEYJ 822 V (8.2 k)	B	101.1/89.4
R887	7030003520	S.RES ERJ3GEYJ 472 V (4.7 k)	B	101.1/87.9
R888	7030003360	S.RES ERJ3GEYJ 221 V (220)	B	241.1/69.8
R889	7030003640	S.RES ERJ3GEYJ 473 V (47 k)	B	241.4/71.8
R890	7030003360	S.RES ERJ3GEYJ 221 V (220)	B	231.2/69.8
R891	7030003560	S.RES ERJ3GEYJ 103 V (10 k)	B	231.9/71.6
R892	7030003730	S.RES ERJ3GEYJ 274 V (270 k)	B	232.4/68.3
R893	7030003680	S.RES ERJ3GEYJ 104 V (100 k)	B	239.1/70.2
R894	7030003200	S.RES ERJ3GEYJ 100 V (10)	B	237.9/69.1
R895	7030003680	S.RES ERJ3GEYJ 104 V (100 k)	B	233.1/70.2
R896	7030003200	S.RES ERJ3GEYJ 100 V (10)	B	234.3/69.1
R901	7030003200	S.RES ERJ3GEYJ 100 V (10)	T	230.7/110.6
R902	7030003200	S.RES ERJ3GEYJ 100 V (10)	B	229.7/116.4
R903	7030003200	S.RES ERJ3GEYJ 100 V (10)	T	228.7/110.6
R904	7030003200	S.RES ERJ3GEYJ 100 V (10)	T	227.7/116.4
R905	7030003200	S.RES ERJ3GEYJ 100 V (10)	T	226.7/110.6
R906	7030003200	S.RES ERJ3GEYJ 100 V (10)	B	225.7/116.4
R907	7030003200	S.RES ERJ3GEYJ 100 V (10)	T	224.7/110.6
R908	7030003200	S.RES ERJ3GEYJ 100 V (10)	B	223.7/116.4
R910	7030003200	S.RES ERJ3GEYJ 100 V (10)	B	221.7/116.4
R911	7030003200	S.RES ERJ3GEYJ 100 V (10)	T	220.7/110.6
R912	7030003200	S.RES ERJ3GEYJ 100 V (10)	T	219.7/116.4
R913	7030003200	S.RES ERJ3GEYJ 100 V (10)	T	218.7/110.6
R914	7030003200	S.RES ERJ3GEYJ 100 V (10)	T	217.7/116.4
R915	7030003200	S.RES ERJ3GEYJ 100 V (10)	T	216.7/110.6
R916	7030003200	S.RES ERJ3GEYJ 100 V (10)	B	215.7/116.4
R917	7030003200	S.RES ERJ3GEYJ 100 V (10)	T	214.7/110.6
R918	7			

[LOGIC UNIT]

REF NO.	ORDER NO.	DESCRIPTION	M.	H/V LOCATION
R972	7030003860	S.RES ERJ3GE JPW V	B	59.1/11
R973	7030003860	S.RES ERJ3GE JPW V	B	58.1/5.1
R974	7030003860	S.RES ERJ3GE JPW V	B	52/14
R975	7030003200	S.RES ERJ3GEYJ 100 V (10)	T	59.9/13.4
R976	7030003200	S.RES ERJ3GEYJ 100 V (10)	T	58.6/13.4
R982	7030003200	S.RES ERJ3GEYJ 100 V (10)	T	49.5/13.4
R983	7030003200	S.RES ERJ3GEYJ 100 V (10)	T	46.9/13.4
R996	7030003200	S.RES ERJ3GEYJ 100 V (10)	T	44.3/13.4
R997	7030003860	S.RES ERJ3GE JPW V	T	33.5/8
R1016	7030003200	S.RES ERJ3GEYJ 100 V (10)	T	52.8/107.5
R1017	7030003200	S.RES ERJ3GEYJ 100 V (10)	T	54.1/107.5
R1018	7030003200	S.RES ERJ3GEYJ 100 V (10)	T	55.4/107.5
R1019	7030003200	S.RES ERJ3GEYJ 100 V (10)	T	56.7/107.5
R1020	7030003200	S.RES ERJ3GEYJ 100 V (10)	T	58/107.5
R1021	7030003200	S.RES ERJ3GEYJ 100 V (10)	T	59.3/107.5
R1022	7030003200	S.RES ERJ3GEYJ 100 V (10)	T	60.6/107.5
R1023	7030003200	S.RES ERJ3GEYJ 100 V (10)	T	61.9/107.5
R1025	7030003320	S.RES ERJ3GEYJ 101 V (100)	T	114.6/90.5
R1026	7030003320	S.RES ERJ3GEYJ 101 V (100)	B	116.4/101.2
R1027	7030003320	S.RES ERJ3GEYJ 101 V (100)	T	98.9/97.1
R1028	7030003320	S.RES ERJ3GEYJ 101 V (100)	B	95.9/88.6
R1029	7030003520	S.RES ERJ3GEYJ 472 V (4.7 k)	B	96.5/100
R1030	7030003520	S.RES ERJ3GEYJ 472 V (4.7 k)	B	99.1/100
R1031	7030003520	S.RES ERJ3GEYJ 472 V (4.7 k)	B	94.2/88.6
R1032	7030003520	S.RES ERJ3GEYJ 472 V (4.7 k)	B	99.1/88.6
R1033	7030003860	S.RES ERJ3GE JPW V	T	238.5/55.1
R1035	7030003540	S.RES ERJ3GEYJ 682 V (6.8 k)	B	229.8/59.3
R1041	7030003520	S.RES ERJ3GEYJ 472 V (4.7 k)	B	206.5/113.3
R1042	7030003550	S.RES ERJ3GEYJ 822 V (8.2 k)	B	104.7/96.8
R1052	7030008240	S.RES ERJ12Y0R00U	T	102.3/73.2
R1053	7030008240	S.RES ERJ12Y0R00U	T	269.3/36.4
R1054	7030008240	S.RES ERJ12Y0R00U	T	156.3/112.5
R1056	7030003860	S.RES ERJ3GE JPW V	T	230.7/97.2
R1057	7030003860	S.RES ERJ3GE JPW V	B	101.1/102.8
R1101	7030003200	S.RES ERJ3GEYJ 100 V (10)	T	28.3/89
R1102	7030003200	S.RES ERJ3GEYJ 100 V (10)	T	19.5/90
R1103	7030003200	S.RES ERJ3GEYJ 100 V (10)	T	19.5/92.2
R1104	7030003200	S.RES ERJ3GEYJ 100 V (10)	T	28.3/93
R1105	7030003200	S.RES ERJ3GEYJ 100 V (10)	T	19.5/94.6
R1106	7030003200	S.RES ERJ3GEYJ 100 V (10)	T	28.2/95
R1107	7030003200	S.RES ERJ3GEYJ 100 V (10)	T	19.5/96
R1108	7030003200	S.RES ERJ3GEYJ 100 V (10)	T	28.2/97
R1109	7030003200	S.RES ERJ3GEYJ 100 V (10)	T	19.5/98
R1110	7030003200	S.RES ERJ3GEYJ 100 V (10)	T	28.2/99
R1111	7030003200	S.RES ERJ3GEYJ 100 V (10)	T	19.5/100
R1112	7030003200	S.RES ERJ3GEYJ 100 V (10)	T	28.2/101
R1113	7030003200	S.RES ERJ3GEYJ 100 V (10)	T	19.5/103.4
R1115	7030003200	S.RES ERJ3GEYJ 100 V (10)	T	28.2/107.3
R1118	7030003440	S.RES ERJ3GEYJ 102 V (1 k)	T	5.6/94.5
R1119	7030003440	S.RES ERJ3GEYJ 102 V (1 k)	T	14.4/95.5
R1120	7030003440	S.RES ERJ3GEYJ 102 V (1 k)	T	5.6/96.5
R1121	7030003440	S.RES ERJ3GEYJ 102 V (1 k)	T	14.4/97.5
R1122	7030003440	S.RES ERJ3GEYJ 102 V (1 k)	T	5.6/98.5
R1125	7030003200	S.RES ERJ3GEYJ 100 V (10)	T	5.6/104.5
R1126	7030003200	S.RES ERJ3GEYJ 100 V (10)	T	14.4/103.5
R1127	7030003200	S.RES ERJ3GEYJ 100 V (10)	T	5.6/102.8
R1128	7030003200	S.RES ERJ3GEYJ 100 V (10)	T	5.6/106.5
R1129	7030003200	S.RES ERJ3GEYJ 100 V (10)	T	14.3/107.5
R1151	7030003290	S.RES ERJ3GEYJ 560 V (56)	B	11.2/30.4
R1152	7030003320	S.RES ERJ3GEYJ 101 V (100)	B	14.3/30.4
R1153	7030003320	S.RES ERJ3GEYJ 101 V (100)	B	16.9/29.6
R1154	7030003320	S.RES ERJ3GEYJ 101 V (100)	B	14.3/28.9
R1155	7030003320	S.RES ERJ3GEYJ 101 V (100)	B	16.9/28.1
R1156	7030003320	S.RES ERJ3GEYJ 101 V (100)	B	14.3/27.4
R1157	7030003320	S.RES ERJ3GEYJ 101 V (100)	B	16.9/26.6
R1158	7030003320	S.RES ERJ3GEYJ 101 V (100)	B	14.3/25.9
R1159	7030003320	S.RES ERJ3GEYJ 101 V (100)	B	16.9/25.1
R1160	7030003320	S.RES ERJ3GEYJ 101 V (100)	B	14.3/24.4
R1161	7030003320	S.RES ERJ3GEYJ 101 V (100)	B	16.9/23.6
R1162	7030003320	S.RES ERJ3GEYJ 101 V (100)	B	14.3/22.9
R1163	7030003320	S.RES ERJ3GEYJ 101 V (100)	B	16.9/22.1
R1164	7030003320	S.RES ERJ3GEYJ 101 V (100)	B	14.3/21.4
R1165	7030003320	S.RES ERJ3GEYJ 101 V (100)	B	16.9/20.6
R1166	7030003320	S.RES ERJ3GEYJ 101 V (100)	B	14.3/19.9
R1167	7030003320	S.RES ERJ3GEYJ 101 V (100)	B	16.9/19.1
R1168	7030003320	S.RES ERJ3GEYJ 101 V (100)	B	14.3/18.4
R1169	7030003320	S.RES ERJ3GEYJ 101 V (100)	B	16.9/17.6
R1170	7030003320	S.RES ERJ3GEYJ 101 V (100)	B	11.2/17.4
R2001	7030003860	S.RES ERJ3GE JPW V	T	278.3/72.9
R2051	7030003200	S.RES ERJ3GEYJ 100 V (10)	T	257.1/76.4
R2052	7030003620	S.RES ERJ3GEYJ 333 V (33 k)	T	257.1/82.6
R2053	7030003540	S.RES ERJ3GEYJ 682 V (6.8 k)	T	259/83.3
R2054	7030003640	S.RES ERJ3GEYJ 473 V (47 k)	T	258.2/87.5
R2055	7030003580	S.RES ERJ3GEYJ 153 V (15 k)	T	255.6/82.6
R2057	7030003860	S.RES ERJ3GE JPW V	T	274/84.6
R2058	7030003860	S.RES ERJ3GE JPW V	B	281.7/97.1
R2059	7030003860	S.RES ERJ3GE JPW V	B	281.7/103.8
R2101	7030003860	S.RES ERJ3GE JPW V	T	274.1/54.8
R2102	7030003860	S.RES ERJ3GE JPW V	T	274.1/52.4
R2201	7030003860	S.RES ERJ3GE JPW V	T	274.2/26.8
R2202	7030003860	S.RES ERJ3GE JPW V	T	274.2/24.4
R2203	7030003860	S.RES ERJ3GE JPW V	T	274.2/25.6
R2204	7030003860	S.RES ERJ3GE JPW V	T	274.2/22
R2205	7030003860	S.RES ERJ3GE JPW V	T	274.2/23.2
R2206	7030003860	S.RES ERJ3GE JPW V	T	274.2/20.8
R2207	7030003860	S.RES ERJ3GE JPW V	T	274.2/19.6
R2208	7030003860	S.RES ERJ3GE JPW V	T	274.2/18.4
R2209	7030003860	S.RES ERJ3GE JPW V	T	274.2/17.2
C1	4030011600	S.CER C1608 JB 1E 104K-T	T	84.8/42.4
C2	4030011600	S.CER C1608 JB 1E 104K-T	T	86.6/43.1
C3	4030011600	S.CER C1608 JB 1E 104K-T	T	91.4/43.1
C4	4030011600	S.CER C1608 JB 1E 104K-T	T	94/43.1

[LOGIC UNIT]

REF NO.	ORDER NO.	DESCRIPTION	M.	H/V LOCATION
C5	4030011600	S.CER C1608 JB 1E 104K-T	T	105.8/43.1
C6	4030011600	S.CER C1608 JB 1E 104K-T	T	93.8/57.5
C7	4030011600	S.CER C1608 JB 1E 104K-T	T	89/57.5
C8	4030011600	S.CER C1608 JB 1E 104K-T	T	84/27
C9	4030011600	S.CER C1608 JB 1E 104K-T	T	86.6/27
C10	4030011600	S.CER C1608 JB 1E 104K-T	T	91.4/27
C11	4030011600	S.CER C1608 JB 1E 104K-T	T	94/27
C12	4030011600	S.CER C1608 JB 1E 104K-T	T	105.8/27
C13	4030011600	S.CER C1608 JB 1E 104K-T	T	93.8/41.4
C14	4030011600	S.CER C1608 JB 1E 104K-T	T	89/41.4
C51	4030011600	S.CER C1608 JB 1E 104K-T	B	168.5/73.1
C52	4030011600	S.CER C1608 JB 1E 104K-T	B	178.2/84.3
C53	4030011600	S.CER C1608 JB 1E 104K-T	B	167.5/95.5
C54	4030011600	S.CER C1608 JB 1E 104K-T	T	143.7/78.8
C55	4030011600	S.CER C1608 JB 1E 104K-T	B	129.1/80.9
C56	4030011600	S.CER C1608 JB 1E 104K-T	B	129.9/87.6
C57	4030011600	S.CER C1608 JB 1E 104K-T	T	133.7/91.6
C58	4030011600	S.CER C1608 JB 1E 104K-T	T	136.7/91.6
C59	4030011600	S.CER C1608 JB 1E 104K-T	B	149.6/87.6
C60	4030011600	S.CER C1608 JB 1E 104K-T	B	150.3/81.9
C61	4030009990	S.CER C1608 CH 1H 200J-T	B	129.4/92.1
C62	4030011600	S.CER C1608 JB 1E 104K-T	B	17/58.8
C63	4030008890	S.CER C1608 JB 1H 273K-T	B	14.7/63.2
C64	4030011600	S.CER C1608 JB 1E 104K-T	B	19.9/60
C65	4030011600	S.CER C1608 JB 1E 104K-T	B	22.9/60.8
C66	4030011600	S.CER C1608 JB 1E 104K-T	T	263.7/68.6
C101	4030011600	S.CER C1608 JB 1E 104K-T	T	208.7/52.4
C102	4030011600	S.CER C1608 JB 1E 104K-T	B	149.4/29.7
C103	4030011600	S.CER C1608 JB 1E 104K-T	B	119.2/31.6
C104	4030011600	S.CER C1608 JB 1E 104K-T	B	138.5/32.5
C105	4030011600	S.CER C1608 JB 1E 104K-T	B	126.3/35.1
C106	4030011600	S.CER C1608 JB 1E 104K-T	B	139.8/32.5
C107	4030011600	S.CER C1608 JB 1E 104K-T	B	139.8/37.7
C108	4030011600	S.CER C1608 JB 1E 104K-T	B	139.8/42.9
C109	4030011600	S.CER C1608 JB 1E 104K-T	B	136.5/45.3
C110	4030011600	S.CER C1608 JB 1E 104K-T	B	129.3/32.5
C111	4550007520	S.TAN F931A106MAABMA	B	148.4/43.3
C112	4030011600	S.CER C1608 JB 1E 104K-T	B	146.8/44.6
C113	4550007520	S.TAN F931A106MAABMA	B	148.4/48.9
C114	4030011600	S.CER C1608 JB 1E 104K-T	B	146.8/47.7
C115	4550007520	S.TAN F931A106MAABMA	B	148.4/54
C116	4030011600	S.CER C1608 JB 1E 104K-T	B	146.8/50.8
C117	4030011600	S.CER C1608 JB 1E 104K-T	B	126.3/32.5
C118	4030011600	S.CER C1608 JB 1E 104K-T	B	135.9/32.5
C119	4030011600	S.CER C1608 JB 1E 104K-T	B	128/32.5
C120	4030011600	S.CER C1608 JB 1E 104K-T	B	127.9/45.3
C121	4030011600	S.CER C1608 JB 1E 104K-T	B	127.1/43.5
C122	4030011600	S.CER C1608 JB 1E 104K-T	B	127.1/42.2
C123	4030006860	S.CER C1608 JB 1H 102K-T	B	119.2/43.1
C124	4030011600	S.CER C1608 JB 1E 104K-T	B	126.3/37.7
C125	4030011600	S.CER C1608 JB 1E 104K-T	B	126.3/40.3
C126	4030011600	S.CER C1608 JB 1E 104K-T	B	130.6/32.5
C127	4030011600	S.CER C1608 JB 1E 104K-T	B	146.8/29.7
C128	4030011600	S.CER C1608 JB 1E 104K-T	B	146.8/38.5
C129	4030011600	S.CER C1608 JB 1E 104K-T	B	132.5/31.8
C130	4030011600	S.CER C1608 JB 1E 104K-T	B	130.5/45.3
C131	4030011600	S.CER C1608 JB 1E 104K-T	B	127.9/52.2
C132	4030011600	S.CER C1608 JB 1E 104K-T	B	133.7/45.3
C133	4030011600	S.CER C1608 JB 1E 104K-T	B	146.8/33.5
C134	4030011600	S.CER C1608 JB 1E 104K-T	B	139.5/25
C135	4030011600	S.CER C1608 JB 1E 104K-T	B	137.2/32.5
C136	4030011600	S.CER C1608 JB 1E 104K-T	B	139.8/40.3
C137	4030011600	S.CER C1608 JB 1E 104K-T	B	139.8/35.1
C138	4030011600	S.CER C1608 JB 1E 104K-T	B	128/40.3
C139	4030011600	S.CER C1608 JB 1E 104K-T	B	139.1/45.3
C140	4030006900	S.CER C1608 JB 1H 103K-T	B	139.1/52.2
C141	4030011600	S.CER C1608 JB 1E 104K-T	B	147.8/71.3
C142	4030011600	S.CER C1608 JB 1E 104K-T	T	147.1/71.9
C144	4030011600	S.CER C1608 JB 1E 104K-T	T	161.3/44.4
C145	4030007100	S.CER C1608 CH 1H 560J-T	T	158/46.2
C146	4030008560	S.CER C1608 CH 1H 300J-T	T	162.5/48
C147	4030007060	S.CER C1608 CH 1H 270J-T	T	162.5/49.2
C148	4030011600	S.CER C1608 JB 1E 104K-T	B	153.7/47.5
C149	4030011600	S.CER C1608 JB 1E 104K-T	T	161.3/43.2
C201	4030011600	S.CER C1608 JB 1E 104K-T	T	71.6/93.4
C202	4030011600	S.CER C1608 JB 1E 104K-T	T	71.6/90.8
C203	4030011600	S.CER C1608 JB 1E 104K-T	T	71.6/86.6
C204	4030			

[LOGIC UNIT]

REF NO.	ORDER NO.	DESCRIPTION	M.	H/V LOCATION
C231	4030011600	S.CER C1608 JB 1E 104K-T	B	55.8/56.7
C232	4030011600	S.CER C1608 JB 1E 104K-T	B	58.4/45.8
C233	4030011600	S.CER C1608 JB 1E 104K-T	B	62.3/56.7
C234	4030011600	S.CER C1608 JB 1E 104K-T	B	66.8/53.6
C235	4030011600	S.CER C1608 JB 1E 104K-T	B	72.7/55.7
C236	4030011600	S.CER C1608 JB 1E 104K-T	B	57.1/56.7
C237	4030011600	S.CER C1608 JB 1E 104K-T	B	58.4/56.7
C238	4030011600	S.CER C1608 JB 1E 104K-T	B	59.7/56.7
C239	4030011600	S.CER C1608 JB 1E 104K-T	B	57.2/39.2
C240	4030011600	S.CER C1608 JB 1E 104K-T	B	63.6/56.7
C241	4030011600	S.CER C1608 JB 1E 104K-T	B	64.9/56.7
C242	4030011600	S.CER C1608 JB 1E 104K-T	B	66.8/57.5
C243	4030011600	S.CER C1608 JB 1E 104K-T	B	66.8/56.2
C244	4030011600	S.CER C1608 JB 1E 104K-T	B	61/45.8
C245	4030011600	S.CER C1608 JB 1E 104K-T	B	56.1/46.3
C246	4030011600	S.CER C1608 JB 1E 104K-T	B	61/56.7
C247	4030011600	S.CER C1608 JB 1E 104K-T	B	56.1/53.6
C248	4030011600	S.CER C1608 JB 1E 104K-T	B	66.8/54.9
C249	4030011600	S.CER C1608 JB 1E 104K-T	B	66.8/47.6
C250	4030007050	S.CER C1608 CH 1H 220J-T	T	46.1/55.4
C251	4030007050	S.CER C1608 CH 1H 220J-T	T	46.1/52.8
C252	4030006990	S.CER C1608 CH 1H 080D-T	T	77.1/51
C253	4030006990	S.CER C1608 CH 1H 080D-T	T	77.1/53.6
C254	4030006900	S.CER C1608 JB 1H 103K-T	T	51.8/37.3
C255	4510008520	S.ELE EEE1CA470SP	T	44.4/38
C256	4030006900	S.CER C1608 JB 1H 103K-T	T	72.6/37.1
C257	4510007130	S.ELE EEFCD 0J 470R	T	75/33.9
C258	4030011600	S.CER C1608 JB 1E 104K-T	T	78.3/37.5
C259	4030011600	S.CER C1608 JB 1E 104K-T	B	61.3/39.8
C260	4030011600	S.CER C1608 JB 1E 104K-T	B	83.1/5.5
C261	4030011600	S.CER C1608 JB 1E 104K-T	B	84.3/5.5
C262	4030011600	S.CER C1608 JB 1E 104K-T	B	82/14
C263	4030011600	S.CER C1608 JB 1E 104K-T	B	82/12.8
C264	4030011600	S.CER C1608 JB 1E 104K-T	B	75/15.2
C265	4510008540	S.ELE EEE1CA100SR	T	80.8/4.8
C266	4030011600	S.CER C1608 JB 1E 104K-T	B	81.7/18.6
C267	4030007100	S.CER C1608 CH 1H 560J-T	B	93.6/11
C268	4030007100	S.CER C1608 CH 1H 560J-T	B	93.6/13.8
C269	4030007100	S.CER C1608 CH 1H 560J-T	B	89.8/16.5
C270	4030007050	S.CER C1608 CH 1H 220J-T	B	98.5/10.7
C271	4030007050	S.CER C1608 CH 1H 220J-T	B	98.5/13.8
C272	4030007050	S.CER C1608 CH 1H 220J-T	B	98.5/16.7
C273	4030011600	S.CER C1608 JB 1E 104K-T	B	103.3/8.2
C274	4030007170	S.CER C1608 CH 1H 221J-T	B	115.5/6.6
C275	4030007170	S.CER C1608 CH 1H 221J-T	B	116.4/4
C276	4030007050	S.CER C1608 CH 1H 220J-T	B	147/2.2
C277	4030007050	S.CER C1608 CH 1H 220J-T	B	14/67.4
C278	4510008500	S.ELE EEE1CA101WP	T	15.4/68.7
C279	4030007050	S.CER C1608 CH 1H 220J-T	B	14/80
C280	4030007050	S.CER C1608 CH 1H 220J-T	B	14/75
C281	4510008500	S.ELE EEE1CA101WP	T	15.4/77.3
C283	4510008550	S.ELE EEE1HA010SR	T	22.4/80.6
C284	4030011600	S.CER C1608 JB 1E 104K-T	B	92/84.2
C285	4510008540	S.ELE EEE1CA100SR	T	92.3/83.6
C286	4510008540	S.ELE EEE1CA100SR	T	97/83.6
C287	4030011600	S.CER C1608 JB 1E 104K-T	B	95.7/84.2
C288	4510008540	S.ELE EEE1CA100SR	T	97/77.6
C289	4030011600	S.CER C1608 JB 1E 104K-T	B	94.5/84.2
C290	4030011600	S.CER C1608 JB 1E 104K-T	B	101.7/84.2
C291	4510008540	S.ELE EEE1CA100SR	T	101.7/83.6
C292	4510008540	S.ELE EEE1CA100SR	T	106.4/83.6
C293	4030011600	S.CER C1608 JB 1E 104K-T	B	104/84.2
C294	4510008540	S.ELE EEE1CA100SR	T	106.6/77.6
C295	4030011600	S.CER C1608 JB 1E 104K-T	B	105.2/84.2
C296	4030011600	S.CER C1608 JB 1E 104K-T	B	112.5/84.2
C297	4510008540	S.ELE EEE1CA100SR	T	111.6/77.6
C298	4030011600	S.CER C1608 JB 1E 104K-T	B	110.6/84.2
C299	4510008540	S.ELE EEE1CA100SR	T	111.1/83.6
C300	4030011600	S.CER C1608 JB 1E 104K-T	B	118/84.2
C301	4510008540	S.ELE EEE1CA100SR	T	116.6/77.6
C302	4030011600	S.CER C1608 JB 1E 104K-T	B	116.4/84.2
C303	4510008540	S.ELE EEE1CA100SR	T	115.8/83.6
C422	4030011600	S.CER C1608 JB 1E 104K-T	T	168.9/44.8
C423	4030011600	S.CER C1608 JB 1E 104K-T	B	184.6/30.6
C424	4030011600	S.CER C1608 JB 1E 104K-T	B	178.1/30.6
C425	4030011600	S.CER C1608 JB 1E 104K-T	B	173.1/30.6
C426	4030011600	S.CER C1608 JB 1E 104K-T	B	166.8/38.9
C427	4030011600	S.CER C1608 JB 1E 104K-T	B	166.8/44.8
C428	4030011600	S.CER C1608 JB 1E 104K-T	B	166.8/46
C429	4030011600	S.CER C1608 JB 1E 104K-T	T	191.3/57.8
C430	4030011600	S.CER C1608 JB 1E 104K-T	T	192.5/57.8
C431	4030011600	S.CER C1608 JB 1E 104K-T	B	177.5/53.7
C432	4030011600	S.CER C1608 JB 1E 104K-T	B	184.1/53.7
C433	4030011600	S.CER C1608 JB 1E 104K-T	B	186.5/53.7
C434	4030011600	S.CER C1608 JB 1E 104K-T	B	195.3/46.7
C435	4030011600	S.CER C1608 JB 1E 104K-T	B	195.3/45.2
C436	4030011600	S.CER C1608 JB 1E 104K-T	B	195.3/40.2
C437	4030011600	S.CER C1608 JB 1E 104K-T	T	262.6/42.2
C438	4030011600	S.CER C1608 JB 1E 104K-T	T	268/43.1
C439	4030011600	S.CER C1608 JB 1E 104K-T	T	249.4/51.6
C440	4010008500	CER DEBB3D102KA2B		
C601	4030011600	S.CER C1608 JB 1E 104K-T	T	254.7/65.1
C602	4030011600	S.CER C1608 JB 1E 104K-T	T	253.5/63.9
C603	4030011600	S.CER C1608 JB 1E 104K-T	B	212.4/69.5
C604	4030011600	S.CER C1608 JB 1E 104K-T	B	202.7/92
C605	4030011600	S.CER C1608 JB 1E 104K-T	B	183.7/89.7
C606	4030011600	S.CER C1608 JB 1E 104K-T	B	183.7/71.9
C607	4030011600	S.CER C1608 JB 1E 104K-T	B	183.7/70.5
C608	4510008540	S.ELE EEE1CA100SR	T	210.1/89.7
C609	4510008540	S.ELE EEE1CA100SR	T	214.8/89.7
C610	4030006900	S.CER C1608 JB 1H 103K-T	B	211.9/88.1
C611	4030006900	S.CER C1608 JB 1H 103K-T	B	213.2/88.1
C612	4030007010	S.CER C1608 CH 1H 100D-T	T	202.7/91.3
C613	4030007010	S.CER C1608 CH 1H 100D-T	T	200.1/91.3

[LOGIC UNIT]

REF NO.	ORDER NO.	DESCRIPTION	M.	H/V LOCATION
C614	4030011600	S.CER C1608 JB 1E 104K-T	B	197.3/92
C615	4030006880	S.CER C1608 JB 1H 472K-T	T	215.3/76.7
C616	4030006880	S.CER C1608 JB 1H 472K-T	T	215.3/77.9
C617	4030006880	S.CER C1608 JB 1H 472K-T	T	215.3/79.1
C618	4030006880	S.CER C1608 JB 1H 472K-T	T	215.3/80.3
C619	4030006880	S.CER C1608 JB 1H 472K-T	T	215.3/81.5
C620	4030006880	S.CER C1608 JB 1H 472K-T	T	215.3/82.7
C621	4030006880	S.CER C1608 JB 1H 472K-T	T	215.3/83.9
C622	4030006880	S.CER C1608 JB 1H 472K-T	T	215.3/85.1
C623	4510008540	S.ELE EEE1CA100SR	T	226/67.5
C624	4030011600	S.CER C1608 JB 1E 104K-T	B	223.4/69.9
C625	4510008540	S.ELE EEE1CA100SR	T	221.2/67.5
C626	4030011600	S.CER C1608 JB 1E 104K-T	B	210.4/62.9
C627	4030011600	S.CER C1608 JB 1E 104K-T	B	216.1/62.9
C628	4030011600	S.CER C1608 JB 1E 104K-T	T	175.1/57.2
C629	4030011600	S.CER C1608 JB 1E 104K-T	T	199.5/64.3
C630	4030011600	S.CER C1608 JB 1E 104K-T	T	170.8/92.8
C631	4030011600	S.CER C1608 JB 1E 104K-T	T	186.6/98
C632	4030011600	S.CER C1608 JB 1E 104K-T	T	186.6/104
C633	4030011600	S.CER C1608 JB 1E 104K-T	T	183.1/114.5
C634	4030011600	S.CER C1608 JB 1E 104K-T	T	178.5/114.5
C635	4030011600	S.CER C1608 JB 1E 104K-T	T	164.5/106.4
C636	4030011600	S.CER C1608 JB 1E 104K-T	T	164.5/99
C801	4510008540	S.ELE EEE1CA100SR	T	28.3/39.3
C802	4030011600	S.CER C1608 JB 1E 104K-T	T	23.4/48.3
C803	4030011600	S.CER C1608 JB 1E 104K-T	T	20.4/48.3
C804	4510008520	S.ELE EEE1CA470SP	T	14.3/40.3
C805	4510008870	S.ELE EEE1AA471UP	T	191.2/37
C806	4510008870	S.ELE EEE1AA471UP	T	182.4/25.4
C807	4510008870	S.ELE EEE1AA471UP	T	168.9/17.9
C808	4510008870	S.ELE EEE1AA471UP	T	189.2/5.6
C809	4510008560	S.ELE EEE1HAR47SR	T	244.1/87.2
C810	4510008560	S.ELE EEE1HAR47SR	T	244.1/80.1
C811	4510008870	S.ELE EEE1AA471UP	T	185.3/16.4
C816	4030006860	S.CER C1608 JB 1H 102K-T	T	205/31.1
C817	4030006860	S.CER C1608 JB 1H 102K-T	T	203/24.1
C818	4030006860	S.CER C1608 JB 1H 102K-T	T	205.4/18
C819	4030006860	S.CER C1608 JB 1H 102K-T	T	218.5/17.5
C820	4030006860	S.CER C1608 JB 1H 102K-T	T	218.5/14.8
C821	4510008520	S.ELE EEE1CA470SP	T	14.5/14.3
C822	4510008500	S.ELE EEE1CA101WP	T	255.9/23.7
C823	4030006880	S.CER C1608 JB 1H 472K-T	T	250/27.3
C825	4030011600	S.CER C1608 JB 1E 104K-T	T	240.8/40.3
C826	4030006860	S.CER C1608 JB 1H 102K-T	T	2.5/54.5
C827	4030006860	S.CER C1608 JB 1H 102K-T	T	2.5/57.1
C828	4030007130	S.CER C1608 CH 1H 101J-T	T	2.5/58.4
C829	4030006860	S.CER C1608 JB 1H 102K-T	T	2.5/51.5
C830	4030007130	S.CER C1608 CH 1H 101J-T	T	2.5/52.8
C831	4030006860	S.CER C1608 JB 1H 102K-T	T	2.5/48.9
C832	4030007130	S.CER C1608 CH 1H 101J-T	T	2.5/50.2
C833	4030006860	S.CER C1608 JB 1H 102K-T	T	2.5/45
C834	4030007130	S.CER C1608 CH 1H 101J-T	T	2.5/46.3
C835	4030011600	S.CER C1608 JB 1E 104K-T	T	20.4/52.6
C836	4510008540	S.ELE EEE1CA100SR	T	16.5/56.6
C837	4030011600	S.CER C1608 JB 1E 104K-T	T	23.4/52.6
C838	4510008540	S.ELE EEE1CA100SR	T	27.4/56.5
C850	4030011600	S.CER C1608 JB 1E 104K-T	T	54.9/102.5
C851	4510008540	S.ELE EEE1CA100SR	T	110.9/90.3
C852	4030009490	S.CER C1608 JB 1H 821K-T	B	113.3/88.2
C853	4030009490	S.CER C1608 JB 1H 821K-T	B	110/90.1
C855	4510008540	S.ELE EEE1CA100SR	T	118.3/90.2
C856	4030009490	S.CER C1608 JB 1H 821K-T	B	115.8/88.2
C857	4030009490	S.CER C1608 JB 1H 821K-T	B	119.2/90.1
C865	4510008540	S.ELE EEE1CA100SR	T	95.2/96.6
C866	4030007160	S.CER C1608 CH 1H 181J-T	B	101.1/100.4
C867	4030009880	S.CER C1608 JB 1H 682K-T	B	104/95
C868	4030008880	S.CER C1608 JB 1H 223K-T	B	104.7/98
C869	4510008540	S.ELE EEE1CA100SR	T	88.9/91.2
C871	4510008540	S.ELE EEE1CA100SR	T	103.2/91.2
C873	4030011600	S.CER C1608 JB 1E 104K-T	B	114.6/90.5
C874	4030011600	S.CER C1608 JB 1E 104K-T	B	114.5/101.9
C875	4510008540	S.ELE EEE1CA100SR	T	112.2/95.8
C876	4510008540	S.ELE EEE1CA100SR	T	116.9/95.8
C877	4030011600	S.CER C1608 JB 1E 104K-T	B	97.8/100
C878	4030011600	S.CER C1608 JB 1E 104K-T	B	97.2/88.6
C879	4510008540	S.ELE EEE1CA100SR	T	102.

[LOGIC UNIT]

REF NO.	ORDER NO.	DESCRIPTION	M.	H/V LOCATION
C936	4030006860	S.CER C1608 JB 1H 102K-T	B	223.7/106.1
C937	4030006860	S.CER C1608 JB 1H 102K-T	T	222.7/94.6
C938	4030006860	S.CER C1608 JB 1H 102K-T	B	217.7/106.1
C939	4030006860	S.CER C1608 JB 1H 102K-T	T	216.7/94.6
C940	4030006860	S.CER C1608 JB 1H 102K-T	B	215.7/106.1
C941	4030006860	S.CER C1608 JB 1H 102K-T	T	214.7/94.6
C942	4030006860	S.CER C1608 JB 1H 102K-T	B	213.7/106.1
C943	4030006860	S.CER C1608 JB 1H 102K-T	T	212.8/94.6
C944	4030006860	S.CER C1608 JB 1H 102K-T	B	211.7/106.1
C945	4030006860	S.CER C1608 JB 1H 102K-T	T	211.5/94.6
C946	4030006860	S.CER C1608 JB 1H 102K-T	B	209.7/106.1
C947	4030006860	S.CER C1608 JB 1H 102K-T	T	59.9/16.2
C948	4030006860	S.CER C1608 JB 1H 102K-T	T	58.6/16.2
C949	4030006860	S.CER C1608 JB 1H 102K-T	T	57.3/16.2
C950	4030006860	S.CER C1608 JB 1H 102K-T	T	49.5/16.2
C951	4030006860	S.CER C1608 JB 1H 102K-T	T	46.9/16.2
C952	4030006860	S.CER C1608 JB 1H 102K-T	T	68.2/5.3
C953	4030006860	S.CER C1608 JB 1H 102K-T	B	59.5/8.7
C954	4030006860	S.CER C1608 JB 1H 102K-T	B	58/2.5
C955	4030006860	S.CER C1608 JB 1H 102K-T	B	49.6/13.3
C963	4030006860	S.CER C1608 JB 1H 102K-T	T	28.2/103.4
C964	4030006860	S.CER C1608 JB 1H 102K-T	T	19.5/104.7
C965	4030006860	S.CER C1608 JB 1H 102K-T	T	28.2/106
C966	4030006860	S.CER C1608 JB 1H 102K-T	T	19.5/109.3
C967	4030006860	S.CER C1608 JB 1H 102K-T	T	28.2/110.3
C968	4030006860	S.CER C1608 JB 1H 102K-T	T	16.5/101.1
C969	4030006860	S.CER C1608 JB 1H 102K-T	T	5.6/101.5
C970	4030006860	S.CER C1608 JB 1H 102K-T	T	5.6/107.8
C971	4030006860	S.CER C1608 JB 1H 102K-T	T	14.3/106.2
C977	4030006860	S.CER C1608 JB 1H 102K-T	T	51.5/107.5
C979	4030006860	S.CER C1608 JB 1H 102K-T	T	71.4/117.1
C980	4030006860	S.CER C1608 JB 1H 102K-T	T	71.4/112.1
C991	4030006880	S.CER C1608 JB 1H 472K-T	T	43.5/2.7
C998	4030006880	S.CER C1608 JB 1H 472K-T	T	33.4/4.9
C999	4030006860	S.CER C1608 JB 1H 102K-T	T	33.7/10.2
C1001	4030006880	S.CER C1608 JB 1H 472K-T	T	15.1/100.9
C1002	4030006880	S.CER C1608 JB 1H 472K-T	T	98.9/100.4
C2051	4030011600	S.CER C1608 JB 1E 104K-T	T	262/82.3
C2052	4030011600	S.CER C1608 JB 1E 104K-T	B	264.9/101.4
C2053	4030011600	S.CER C1608 JB 1E 104K-T	T	265/95.7
C2054	4030008680	S.CER C2012 JF 1C 105Z-T	T	270.5/89.5
C2055	4030008680	S.CER C2012 JF 1C 105Z-T	T	273.6/88.5
C2056	4030008680	S.CER C2012 JF 1C 105Z-T	T	279.9/91.2
C2057	4030008680	S.CER C2012 JF 1C 105Z-T	T	279.9/95
C2058	4030008680	S.CER C2012 JF 1C 105Z-T	T	274.6/100.7
J1	6510022490	S.CNR AXK5S30045P	T	94/19.9
J2	6510019870	S.CNR AXK5S40045P	T	94/64.9
J52	6510023261	S.CNR B6B-PH-SM4-TB (LF) (SN)	T	153.9/103.6
J102	6510019981	S.CNR 52808-1671 (1690)	T	153.6/65
J602	6510019971	S.CNR 52808-1071	T	218.9/57
J604	6510019971	S.CNR 52808-1071	T	224.1/82
J804	6510022031	S.CNR B10B-ZR-SM4-TF (LF) (SN)	T	6.2/72
J805	6510020081	S.CNR 52808-2071 (2090)	T	6.8/48
J806	6510022471	S.CNR 40FLT-SM2-TB (LF) (SN)	T	6.9/21.1
J808	6510020001	S.CNR 52808-3071 (3090)	T	217.2/114.8
J809	6510020001	S.CNR 52808-3071 (3090)	T	217.2/101.7
J810	6510020251	S.CNR B9B-PH-SM4-TB (LF) (SN)	T	113.9/115.9
J811	6510021561	S.CNR 52808-2470 (2490)	T	50/6.8
J813	6510019991	S.CNR 52808-2271 (2291)	T	23.9/99.5
J814	6510019981	S.CNR 52808-1671 (1690)	T	10/101
J816	6510019981	S.CNR 52808-1671 (1690)	T	60.2/112.4
J820	6510022801	S.CNR B10B-PH-SM4-TB (LF) (SN)	T	232.5/23.3
J821	6510020251	S.CNR B9B-PH-SM4-TB (LF) (SN)	T	214.8/22.3
J824	6510018971	S.CNR B4B-PH-SM4-TB (LF) (SN)	T	244.6/21.7
J826	6510015541	S.CNR B4B-ZR-SM4-TF (LF) (SN)	T	81.6/115.8
J2001	6510023720	CNR LGY6501-0600C		
J2052	6510023120	CNR CD6109SA1JO <CVI>		
J2101	6510024040	CNR TM11R-5M2-88-LP		
J2201	6450001941	CNR KEY-15S-2A3A (LF) (SN)		
DS403	5040002930	S.LED SML-512MW T86	T	187.7/53.7
DS491	5040002930	S.LED SML-512MW T86	T	282.5/46.4
DS492	5040002930	S.LED SML-512MW T86	T	282.5/57.5
S51	2260002740	S.SW LS8J2M-T	T	15.9/62.2
T401	5920000841	S.TSM H1102NL	T	259.2/49.4
EP102	6910013310	S.BEA MMZ1608D121B	T	159.4/33.3
EP103	6910013310	S.BEA MMZ1608D121B	T	158.2/33.3
EP201	6910012350	S.BEA MMZ1608Y 102BT	B	81.7/21.3
EP202	6910012350	S.BEA MMZ1608Y 102BT	B	81.7/19.8
EP203	6910012350	S.BEA MMZ1608Y 102BT	T	50.6/37.3
EP204	6910012350	S.BEA MMZ1608Y 102BT	T	69.6/35.4
EP401	6910013310	S.BEA MMZ1608D121B	T	184.1/53.7
EP402	6910013310	S.BEA MMZ1608D121B	T	177.5/53.7
EP403	6910013310	S.BEA MMZ1608D121B	T	186.5/53.7
EP801	6910013310	S.BEA MMZ1608D121B	B	5.7/30.4
EP802	6910013310	S.BEA MMZ1608D121B	B	8/29.4
EP803	6910013310	S.BEA MMZ1608D121B	B	11.2/28.9
EP804	6910013310	S.BEA MMZ1608D121B	B	5.7/28.4
EP805	6910013310	S.BEA MMZ1608D121B	B	8/27.4
EP806	6910013310	S.BEA MMZ1608D121B	B	11.2/26.9
EP807	6910013310	S.BEA MMZ1608D121B	B	5.7/26.4
EP808	6910013310	S.BEA MMZ1608D121B	B	8/25.4
EP809	6910013310	S.BEA MMZ1608D121B	B	11.2/24.9
EP810	6910013310	S.BEA MMZ1608D121B	B	5.7/24.4
EP811	6910013310	S.BEA MMZ1608D121B	B	8/23.4

[LOGIC UNIT]

REF NO.	ORDER NO.	DESCRIPTION	M.	H/V LOCATION
EP812	6910013310	S.BEA MMZ1608D121B	B	11.2/22.9
EP813	6910013310	S.BEA MMZ1608D121B	B	5.7/22.4
EP814	6910013310	S.BEA MMZ1608D121B	B	8/21.4
EP815	6910013310	S.BEA MMZ1608D121B	B	11.2/20.9
EP816	6910013310	S.BEA MMZ1608D121B	B	5.7/20.4
EP817	6910013310	S.BEA MMZ1608D121B	B	8/19.4
EP818	6910013310	S.BEA MMZ1608D121B	B	11.2/18.9
EP819	6910013310	S.BEA MMZ1608D121B	B	5.7/18.4
EP820	6910013310	S.BEA MMZ1608D121B	B	8/17.4
EP821	6910015980	S.BEA MMZ1608S 181CT-AS	T	224.4/28.9
EP822	6910015980	S.BEA MMZ1608S 181CT-AS	T	224.4/27.7
EP824	6910014730	S.BEA MPZ2012S331A-T	T	12/50.5
EP825	6910014730	S.BEA MPZ2012S331A-T	T	12/46.5
EP826	6910012350	S.BEA MMZ1608Y 102BT	B	12.5/44.5
EP827	6910012350	S.BEA MMZ1608Y 102BT	B	12.5/41.8
EP828	6910012350	S.BEA MMZ1608Y 102BT	B	12.5/40.5
EP829	6910012350	S.BEA MMZ1608Y 102BT	B	12.5/43.2
EP832	6910014730	S.BEA MPZ2012S331A-T	T	224.1/25.6
EP833	6910014730	S.BEA MPZ2012S331A-T	T	224.1/23.9
EP834	6910014730	S.BEA MPZ2012S331A-T	T	208.5/15.8
EP835	6910014730	S.BEA MPZ2012S331A-T	T	206.8/15.8
EP836	6910014730	S.BEA MPZ2012S331A-T	T	224.1/20.3
EP837	6910014730	S.BEA MPZ2012S331A-T	T	224.1/16.2
EP838	6910014730	S.BEA MPZ2012S331A-T	T	12/57.5
EP839	6910014730	S.BEA MPZ2012S331A-T	T	12/53.5
EP840	6910014730	S.BEA MPZ2012S331A-T	T	12/55.7
EP851	6910015970	S.BEA MMZ1608B 301CT-AS	T	107.9/109.4
EP852	6910015970	S.BEA MMZ1608B 301CT-AS	T	111.9/109.4
EP853	6910015970	S.BEA MMZ1608B 301CT-AS	T	115.9/109.4
EP854	6910015970	S.BEA MMZ1608B 301CT-AS	T	119.9/109.4
EP901	6910014730	S.BEA MPZ2012S331A-T	T	65.6/7.9
EP902	6910014730	S.BEA MPZ2012S331A-T	B	57.1/11.1
EP903	6910014730	S.BEA MPZ2012S331A-T	B	55.1/15.1
EP904	6910014730	S.BEA MPZ2012S331A-T	B	54.2/11.9
EP905	6910014730	S.BEA MPZ2012S331A-T	T	35.4/5.9
EP907	6910015980	S.BEA MMZ1608S 181CT-AS	T	57.3/13.4
EP908	6910015980	S.BEA MMZ1608S 181CT-AS	T	56/13.4
EP909	6910015980	S.BEA MMZ1608S 181CT-AS	T	54.7/13.4
EP910	6910015980	S.BEA MMZ1608S 181CT-AS	T	53.4/13.4
EP911	6910015980	S.BEA MMZ1608S 181CT-AS	T	52.1/13.4
EP912	6910015980	S.BEA MMZ1608S 181CT-AS	T	50.8/13.4
EP918	6910014730	S.BEA MPZ2012S331A-T	T	71.8/115.5
EP919	6910014730	S.BEA MPZ2012S331A-T	T	71.8/113.7
EP920	6910014730	S.BEA MPZ2012S331A-T	T	64.7/107.7
EP932	6910014690	S.BEA MPZ1608S221A-T	T	229.7/106.1
EP933	6910014690	S.BEA MPZ1608S221A-T	T	228.7/97.2
EP972	6910015970	S.BEA MMZ1608B 301CT-AS	T	79.3/110.1
EP973	6910015970	S.BEA MMZ1608B 301CT-AS	T	82.1/109.9
EP1113	6910014690	S.BEA MPZ1608S221A-T	T	28.2/104.7
EP1114	6910014690	S.BEA MPZ1608S221A-T	T	19.5/106
EP1116	6910014690	S.BEA MPZ1608S221A-T	T	19.5/108
EP1117	6910014690	S.BEA MPZ1608S221A-T	T	28.2/109
EP1123	6910015970	S.BEA MMZ1608B 301CT-AS	T	14.4/98.8
EP1124	6910015970	S.BEA MMZ1608B 301CT-AS	T	5.6/100.2
EP2001	6910012350	S.BEA MMZ1608Y 102BT	T	276.2/70.7
EP2002	6910012350	S.BEA MMZ1608Y 102BT	T	276.2/72.1
EP2051	6910014730	S.BEA MPZ2012S331A-T	T	256.3/98.1

[MEMORY BOARD]

REF NO.	ORDER NO.	DESCRIPTION	M.	H/V LOCATION
IC1	1130014290	S.IC JS28F128J3D-75 (SX-3009A) [EUR]		
	1130014291	S.IC JS28F128J3D-75 (SX-3009A-1) [USA], [UK]		
	1130014292	S.IC JS28F128J3D-75 (SX-3009A-2) [FRA], [ITR], [ESP], [KOR]		
IC2	1130013480	S.IC JS28F128J3D-75		
C1	4030011600	S.CER C1608 JB 1E 104K-T		
C2	4030011600	S.CER C1608 JB 1E 104K-T		
C3	4030011600	S.CER C1608 JB 1E 104K-T		
C4	4030011600	S.CER C1608 JB 1E 104K-T		
C5	4030011600	S.CER C1608 JB 1E 104K-T		
C6	4030011600	S.CER C1608 JB 1E 104K-T		
J1	6510024410	S.CNR AXK6S30545		
J2	6510020220	S.CNR AXK6S40545P		

M.=Mounted side (T: Mounted on the Top side B: Mounted on the Bottom side) S.=Surface mount

[PA200W BOARD]

REF NO.	ORDER NO.	DESCRIPTION	M.	H/V LOCATION
IC2	1180001541	S.IC TA78L08F (TE12L,F)	T	58.8/15.1
Q1	1520000531	S.TR 2SB1119S-TD-E	T	42.8/19.2
Q2	1590000680	S.TR DTC114EUA T106	T	45.8/13.5
Q101	1560001241	S.FET RD01MUS1-T113	T	5.9/66.4
Q201	1590003051	S.FET PDS5003-E	T	20.5/53.1
Q301	1590003840	FET MRF148A	T	64/45.8
Q401	1560001211	FET MRF150 (SRFJ150MP) M/A		
D1	1730000561	S.ZEN RD2.7M-T2B-A B1	T	100.6/22.8
D401	1750000271	S.DIO 1SS301 (TE85L,F)	T	116.8/99.1
D402	1750000271	S.DIO 1SS301 (TE85L,F)	T	118.3/35.9
D403	1750000271	S.DIO 1SS301 (TE85L,F)	T	104/98.3
D404	1750000271	S.DIO 1SS301 (TE85L,F)	T	104/35.7
D551	1790000491	S.DIO HSM88ASTR-E	T	150.1/35.3
L1	6200005011	S.COL NLV25T-100J	T	14.7/18
L2	6200005011	S.COL NLV25T-100J	T	14.7/20.5
L3	6200005011	S.COL NLV25T-100J	T	14.7/23
L4	6200005011	S.COL NLV25T-100J	T	14.7/29
L6	6200005011	S.COL NLV25T-100J	T	14.7/25.5
L7	6200010881	S.COL CDRH124NP-330MC	T	77.3/11
L101	6200005131	S.COL NLC453232T-101K-PF	T	5.6/59.6
L102	6200007220	S.COL EXCLCL4532U1	T	6/38.4
L201	6180001240	COL LAL 04NA 820K		
L202	6140004350	COL LR-475		
L301	6200003261	S.COL NLV32T-101J	T	46.1/36.4
L303	6200001831	S.COL NLV32T-100J	T	86.9/26.2
L304	2040000490	COL EXC-ELDR25C		
L305	2040000490	COL EXC-ELDR25C		
L306	6140004340	COL LR-474		
L307	6200001831	S.COL NLV32T-100J	T	75.7/100.2
L401	6200003261	S.COL NLV32T-101J	T	100.4/98.3
L402	6200003261	S.COL NLV32T-101J	T	100.1/35.8
L403	6140002590	COL LR-296 (TR18X8X8 D12A)		
L404	6140000720	COL LR-95	T	166.4/67
L501	6140002030	COL LR-230 (SK-10M-15Y 120)		
R1	7030003440	S.RES ERJ3GEYJ 102 V (1 k)	T	42.8/12.8
R2	7030003560	S.RES ERJ3GEYJ 103 V (10 k)	T	42.8/14.2
R3	7510001740	TMR DTN-C103F3H-STS-40		
R4	7030000380	S.RES MCR10EZHHJ 1 k	T	39.7/22.5
R5	7030008061	S.RES ERA3YED 222V (2.2 k)	T	104.3/23.1
R6	7030007210	S.RES ERA3YEB 102V (1 k)	T	103.6/16.5
R7	7030007210	S.RES ERA3YEB 102V (1 k)	T	103.6/17.8
R101	7030003370	S.RES ERJ3GEYJ 271 V (270)	T	6/87.2
R102	7030003220	S.RES ERJ3GEYJ 150 V (15)	T	3.9/86.1
R103	7030003370	S.RES ERJ3GEYJ 271 V (270)	T	6/85
R104	7030003360	S.RES ERJ3GEYJ 221 V (220)	T	4.8/71.3
R105	7030003430	S.RES ERJ3GEYJ 821 V (820)	T	6/73.3
R106	7030003480	S.RES ERJ3GEYJ 222 V (2.2 k)	T	9.2/73.8
R107	7030003440	S.RES ERJ3GEYJ 102 V (1 k)	T	2.2/64.7
R108	7030003200	S.RES ERJ3GEYJ 100 V (10)	T	9.2/68.3
R110	7030000230	S.RES MCR10EZHHJ 56 (560)	T	11.3/56.6
R111	7030003420	S.RES ERJ3GEYJ 681 V (680)	T	13.3/58.6
R112	7030003510	S.RES ERJ3GEYJ 392 V (3.9 k)	T	12.6/60.6
R113	7030003500	S.RES ERJ3GEYJ 332 V (3.3 k)	T	6.8/75.2
R115	7030003520	S.RES ERJ3GEYJ 472 V (4.7 k)	T	13.1/40.8
R117	7030003530	S.RES ERJ3GEYJ 562 V (5.6 k)	T	7.7/76.5
R118	7030003550	S.RES ERJ3GEYJ 822 V (8.2 k)	T	11.7/40.8
R119	7030008240	S.RES ERJ12Y0R00U	T	5/49.6
R201	7030004050	S.RES ERJ3GEYJ 1R0 V (1)	T	13.8/48.6
R202	7030003410	S.RES ERJ3GEYJ 561 V (560)	T	23.1/43.1
R203	7030010800	S.RES ERJ1TYJ 2R7U (2.7)	T	18.4/65.5
R205	7030006260	S.RES ERJ12YJ471U (470)	T	30.3/55.7
R301	7310005210	TRI VM5CK-PVB 20 k		
R302	7030008180	S.RES ERJ12YJ331U (330)	T	48.3/40.6
R305	7030003530	S.RES ERJ3GEYJ 562 V (5.6 k)	T	49.6/43.5
R307	7070000830	RES ERG3SJ 101 (100)		
R309	7030010570	S.RES ERJ1TYJ 4R7U (4.7)	T	80/45.8
R310	7310005200	TRI VM5CK-PVB 2 k		
R312	7070000830	RES ERG3SJ 101 (100)		
R401	7030010960	S.RES ERJ1TYJ 120U (12)	T	89.8/90.7
R402	7030010960	S.RES ERJ1TYJ 120U (12)	T	93.5/90.7
R403	7030010960	S.RES ERJ1TYJ 120U (12)	T	97.2/90.7
R404	7030010960	S.RES ERJ1TYJ 120U (12)	T	90.8/43.3
R405	7030010960	S.RES ERJ1TYJ 120U (12)	T	94.5/43.3
R406	7030010960	S.RES ERJ1TYJ 120U (12)	T	98.2/43.3
R407	7310005230	TRI VM5CK-PVB 10 k		
R408	7030000420	S.RES MCR10EZHHJ 2.2 k	T	116.3/96
R409	7030000420	S.RES MCR10EZHHJ 2.2 k	T	116.3/38
R410	7310005230	TRI VM5CK-PVB 10 k		
R411	7030010520	S.RES ERJ1TYJ 101U (100)	T	107.6/93.9
R412	7030010520	S.RES ERJ1TYJ 101U (100)	T	107.5/40.2
R413	7030010520	S.RES ERJ1TYJ 101U (100)	T	111.3/93.9
R414	7030010520	S.RES ERJ1TYJ 101U (100)	T	111.2/40.2
R416	7070000890	RES ERG3SJ 150 (15)		
R418	7070001190	RES ERG3SJ180 (18)		
R420	7070000890	RES ERG3SJ 150 (15)		
R422	7070001190	RES ERG3SJ180 (18)		
R423	7030003460	S.RES ERJ3GEYJ 152 V (1.5 k)	T	95.9/98.4
R424	7030003460	S.RES ERJ3GEYJ 152 V (1.5 k)	T	99.4/33.6
R425	7310005200	TRI VM5CK-PVB 2 k		
R426	7310005200	TRI VM5CK-PVB 2 k		
R427	7070001200	RES ERG3SJ100P (10)		
R501	7070000890	RES ERG3SJ 150 (15)		
R502	7070000890	RES ERG3SJ 150 (15)		
R503	7030003500	S.RES ERJ3GEYJ 332 V (3.3 k)	T	171.8/16.7
R504	7030003500	S.RES ERJ3GEYJ 332 V (3.3 k)	T	169.9/15.9
R507	7030003500	S.RES ERJ3GEYJ 332 V (3.3 k)	T	139.1/17.9
R508	7030003500	S.RES ERJ3GEYJ 332 V (3.3 k)	T	137.3/19.2
R511	7070000890	RES ERG3SJ 150 (15)		
R512	7070000890	RES ERG3SJ 150 (15)		
R513	7070001000	RES ERG3SJ 821 (820)		

[PA200W BOARD]

REF NO.	ORDER NO.	DESCRIPTION	M.	H/V LOCATION
R514	7070001000	RES ERG3SJ 821 (820)		
R521	7030011160	S.RES RL7520WT-R010-F	T	165.2/20.2
R522	7030011160	S.RES RL7520WT-R010-F	T	159.6/20.2
R523	7030011160	S.RES RL7520WT-R010-F	T	154/20.2
R551	7030010650	S.RES ERJ12YJ823U (82 k)	T	144.5/34.2
R552	7030008020	S.RES ERJ12YJ472U (4.7 k)	T	141.2/28.3
R554	7030003560	S.RES ERJ3GEYJ 103 V (10 k)	T	154.5/34.2
R563	7030008240	S.RES ERJ12Y0R00U	T	137.5/28.9
R564	7030008240	S.RES ERJ12Y0R00U	T	156.6/30
R565	7030008240	S.RES ERJ12Y0R00U	T	146/29.4
C1	4030011600	S.CER C1608 JB 1E 104K-T	T	18.9/18
C2	4030006880	S.CER C1608 JB 1H 472K-T	T	18.9/20.5
C3	4030006880	S.CER C1608 JB 1H 472K-T	T	18.9/23
C4	4030006880	S.CER C1608 JB 1H 472K-T	T	18.9/29
C6	4030006880	S.CER C1608 JB 1H 472K-T	T	18.9/25.5
C7	4030006900	S.CER C1608 JB 1H 103K-T	T	70/6.8
C8	4030006880	S.CER C1608 JB 1H 472K-T	T	42.8/15.6
C9	4030011600	S.CER C1608 JB 1E 104K-T	T	57.6/11.4
C10	4510008520	S.ELE EEE1CA470SP	T	52/15.5
C11	4030006900	S.CER C1608 JB 1H 103K-T	T	60.4/11.4
C12	4510008520	S.ELE EEE1CA470SP	T	64.9/15.5
C15	4030006880	S.CER C1608 JB 1H 472K-T	T	104.3/20.4
C16	4030006880	S.CER C1608 JB 1H 472K-T	T	103/23.1
C17	4510008550	S.ELE EEE1HA010SR	T	95.9/22.8
C102	4030017810	S.CER C1608 CH 1H 102J-T	T	4.1/76.2
C103	4030011600	S.CER C1608 JB 1E 104K-T	T	9.2/72.5
C104	4030011600	S.CER C1608 JB 1E 104K-T	T	9.5/75.2
C106	4030017320	S.CER GRM21BB11H104KA01L	T	2.2/67.7
C107	4030011600	S.CER C1608 JB 1E 104K-T	T	9.2/70.9
C108	4030017810	S.CER C1608 CH 1H 102J-T	T	9.2/69.6
C109	4030017320	S.CER GRM21BB11H104KA01L	T	8.1/62.6
C110	4030017810	S.CER C1608 CH 1H 102J-T	T	9/64.2
C111	4030017810	S.CER C1608 CH 1H 102J-T	T	9/56.4
C112	4030017320	S.CER GRM21BB11H104KA01L	T	8.7/54.8
C113	4030011600	S.CER C1608 JB 1E 104K-T	T	5.3/102.4
C114	4030011600	S.CER C1608 JB 1E 104K-T	T	13.9/60.6
C201	4030017320	S.CER GRM21BB11H104KA01L	T	18.2/43.1
C202	4030017810	S.CER C1608 CH 1H 102J-T	T	15.7/61.3
C204	4030008490	S.CER C2012 JB 1H 682K-T	T	31.2/61.6
C206	4030008700	S.CER GRM21BB11H473KA01L	T	29.3/61.6
C207	4030008700	S.CER GRM21BB11H473KA01L	T	34.4/36.7
C301	4030004760	S.CER C2012 JF 1H 104Z-T	T	49.4/45.5
C303	4030011600	S.CER C1608 JB 1E 104K-T	T	43.4/35.4
C305	4030004760	S.CER C2012 JF 1H 104Z-T	T	44.4/42.6
C307	4030017810	S.CER C1608 CH 1H 102J-T	T	39.7/31.7
C309	4030011600	S.CER C1608 JB 1E 104K-T	T	41.1/31.7
C311	4030018750	S.CER C3225 CH 2J 682K-T	T	54.1/58.9
C313	4030011600	S.CER C1608 JB 1E 104K-T	T	89.1/26.9
C314	4510008050	ELE 63 ME 220 CZ		
C317	4030018790	S.CER C3225 JB 2E 104K-T	T	76.8/34
C318	4030011600	S.CER C1608 JB 1E 104K-T	T	77.2/96.7
C319	4030018790	S.CER C3225 JB 2E 104K-T	T	70.4/79
C401	4030011790	S.CER GRM55RF52A684ZD01L	T	92.4/82.2
C402	4030011790	S.CER GRM55RF52A684ZD01L	T	92.4/51.8
C403	4030011600	S.CER C1608 JB 1E 104K-T	T	79.9/100.1
C404	4030011600	S.CER C1608 JB 1E 104K-T	T	88.6/30.3
C405	4030006900	S.CER C1608 JB 1H 103K-T	T	79.9/98.0
C406	4030006900	S.CER C1608 JB 1H 103K-T	T	88.6/31.6
C407	4030017810	S.CER C1608 CH 1H 102J-T	T	79.9/97.5
C408	4030017810	S.CER C1608 CH 1H 102J-T	T	88.6/32.9
C409	4030018790	S.CER C3225 JB 2E 104K-T	T	111.3/100.2
C410	4030018790	S.CER C3225 JB 2E 104K-T	T	111.2/33.9
C411	4030006880	S.CER C1608 JB 1H 472K-T	T	114.9/99.1
C412	4030006880	S.CER C1608 JB 1H 472K-T	T	116.3/35
C413	4030011600	S.CER C1608 JB 1E 104K-T	T	97.8/99.1
C414	4030011600	S.CER C1608 JB 1E 104K-T	T	97.4/36.5
C415	4030011790	S.CER GRM55RF52A684ZD01L	T	102.8/88.8
C416	4030011790	S.CER GRM55RF52A684ZD01L	T	103.8/49
C417	4030018760	S.CER C4532 CH 2A 104K-T	T	190.2/82.6
C418	4030018760	S.CER C4532 CH 2A 104K-T	T	193.9/82.6
C419	4030018760	S.CER C4532 CH 2		

[FILTER UNIT]

REF NO.	ORDER NO.	DESCRIPTION	M.	H/V LOCATION
D402	1750000271	S.DIO 1SS301 (TE85L,F)	T	11.8/24.3
D452	1750000271	S.DIO 1SS301 (TE85L,F)	T	32/20.5
D502	1750000271	S.DIO 1SS301 (TE85L,F)	T	54.8/30.3
D552	1750000271	S.DIO 1SS301 (TE85L,F)	T	155.6/29.1
D602	1750000271	S.DIO 1SS301 (TE85L,F)	T	130.1/20.3
D652	1750000271	S.DIO 1SS301 (TE85L,F)	T	93.8/33
D702	1750000271	S.DIO 1SS301 (TE85L,F)	T	69.6/20.3
D752	1750000271	S.DIO 1SS301 (TE85L,F)	T	113.1/33
D802	1750000271	S.DIO 1SS301 (TE85L,F)	T	173.6/25.9
L401	6200005131	S.COL NLC453232T-101K-PF	T	25.4/136.7
L402	6140004310	COL LR-471		
L403	6140004300	COL LR-470		
L404	6140004300	COL LR-470		
L405	6200005131	S.COL NLC453232T-101K-PF	T	7.3/24.6
L451	6200005131	S.COL NLC453232T-101K-PF	T	4.4/143.9
L452	6140004270	COL LR-467		
L453	6140004290	COL LR-469		
L454	6140004290	COL LR-469		
L455	6200005131	S.COL NLC453232T-101K-PF	T	28.4/29.9
L501	6200005131	S.COL NLC453232T-101K-PF	T	46.3/133.8
L502	6140004280	COL LR-468		
L503	6140004270	COL LR-467		
L504	6140004270	COL LR-467		
L505	6200005131	S.COL NLC453232T-101K-PF	T	50.2/29.6
L551	6200005131	S.COL NLC453232T-101K-PF	T	150.7/133.8
L552	6140004260	COL LR-466		
L553	6140004280	COL LR-468		
L554	6140004280	COL LR-468		
L555	6200005131	S.COL NLC453232T-101K-PF	T	151/29.7
L601	6200005131	S.COL NLC453232T-101K-PF	T	129.9/133.8
L602	6140004250	COL LR-465		
L603	6140004240	COL LR-464		
L604	6140004240	COL LR-464		
L605	6200005131	S.COL NLC453232T-101K-PF	T	130.1/14.2
L651	6200005131	S.COL NLC453232T-101K-PF	T	88.2/133.8
L652	6140004200	COL LR-463		
L653	6140004170	COL LR-462		
L654	6140004170	COL LR-462		
L655	6200005131	S.COL NLC453232T-101K-PF	T	92.3/29.8
L701	6200005131	S.COL NLC453232T-101K-PF	T	67.2/133.8
L702	6140004130	COL LR-461		
L703	6140004070	COL LR-460		
L704	6140004070	COL LR-460		
L705	6200005131	S.COL NLC453232T-101K-PF	T	69.6/14.1
L751	6200005131	S.COL NLC453232T-101K-PF	T	109.1/133.8
L752	6110003900	COL LA-592		
L753	6110003890	COL LA-591		
L754	6110003890	COL LA-591		
L755	6200005131	S.COL NLC453232T-101K-PF	T	111.4/29.8
L801	6200001831	S.COL NLV32T-100J	T	165.9/163.4
L802	6110003880	COL LA-590		
L803	6110003870	COL LA-589		
L804	6110003870	COL LA-589		
L805	6200001831	S.COL NLV32T-100J	T	173.9/22.8
C401	4030006880	S.CER C1608 JB 1H 472K-T	T	25.4/130.4
C402	4010008200	CER HM11TJ SL 331J 500V		
C403	4010008200	CER HM11TJ SL 331J 500V		
C404	4010008300	CER HM11TJ SL 391J 500V		
C405	4010008300	CER HM11TJ SL 391J 500V		
C406	4010008210	CER HM60TJ SL 560J 500V		
C407	4010007590	CER HM15SJ SL 681J 500V		
C408	4010007590	CER HM15SJ SL 681J 500V		
C409	4010007590	CER HM15SJ SL 681J 500V		
C410	4010005870	CER HM95TJ SL 221J 500V		
C411	4010008280	CER HM95TJ SL 221J 500V		
C412	4010008370	CER HM60TJ SL 150J 500V		
C413	4010007590	CER HM15SJ SL 681J 500V		
C414	4010007590	CER HM15SJ SL 681J 500V		
C415	4010007590	CER HM15SJ SL 681J 500V		
C416	4010008300	CER HM11TJ SL 391J 500V		
C417	4010008230	CER HM60TJ SL 820J 500V		
C418	4010007590	CER HM15SJ SL 681J 500V		
C419	4010007590	CER HM15SJ SL 681J 500V		
C420	4030006880	S.CER C1608 JB 1H 472K-T	T	11.6/26.3
C451	4030006880	S.CER C1608 JB 1H 472K-T	T	26.6/127.9
C452	4010008290	CER HM95TJ SL 221J 500V		
C453	4010008280	CER HM95TJ SL 221J 500V		
C454	4010008240	CER HM60TJ SL 101J 500V		
C455	4010005810	CER HM74SJ SL 111J 500V		
C456	4010007490	CER HM15SJ SL 561J 500V		
C457	4010006410	CER HM13SJ SL 471J 500V		
C458	4010008250	CER HM74TJ SL 121J 500V		
C459	4010005810	CER HM74SJ SL 111J 500V		
C461	4010007490	CER HM15SJ SL 561J 500V		
C462	4010007490	CER HM15SJ SL 561J 500V		
C463	4010008340	CER HM60TJ SL 270J 500V		
C464	4010008320	CER HM60TJ SL 390J 500V		
C465	4010007490	CER HM15SJ SL 561J 500V		
C466	4010008220	CER HM60TJ SL 680J 500V		
C467	4030006880	S.CER C1608 JB 1H 472K-T	T	32.4/23.4
C468	4010008230	CER HM60TJ SL 820J 500V		
C501	4030006880	S.CER C1608 JB 1H 472K-T	T	47.6/127.3
C502	4010008280	CER HM95TJ SL 221J 500V		
C503	4010008260	CER HM74TJ SL 151J 500V		
C504	4010008280	CER HM95TJ SL 221J 500V		
C506	4010008200	CER HM11TJ SL 331J 500V		
C507	4010008280	CER HM95TJ SL 221J 500V		
C508	4010008280	CER HM95TJ SL 221J 500V		
C509	4010005810	CER HM74SJ SL 111J 500V		
C511	4010008300	CER HM11TJ SL 391J 500V		
C512	4010008300	CER HM11TJ SL 391J 500V		
C513	4010008260	CER HM74TJ SL 151J 500V		
C514	4010008320	CER HM60TJ SL 390J 500V		
C515	4010008280	CER HM95TJ SL 221J 500V		
C516	4010008280	CER HM95TJ SL 221J 500V		
C517	4030006880	S.CER C1608 JB 1H 472K-T	T	54.7/28.4
C518	4010008340	CER HM60TJ SL 270J 500V		
C551	4030006880	S.CER C1608 JB 1H 472K-T	T	149.9/122.5
C552	4010005860	CER HM95SJ SL 201J 500V		
C554	4010008230	CER HM60TJ SL 820J 500V		

[FILTER UNIT]

REF NO.	ORDER NO.	DESCRIPTION	M.	H/V LOCATION
C555	4010008370	CER HM60TJ SL 150J 500V		
C556	4010008290	CER HM95TJ SL 271J 500V		
C557	4010008290	CER HM95TJ SL 271J 500V		
C558	4010008320	CER HM60TJ SL 390J 500V		
C559	4010008330	CER HM60TJ SL 330J 500V		
C560	4010008340	CER HM60TJ SL 270J 500V		
C561	4010008200	CER HM11TJ SL 331J 500V		
C562	4010008290	CER HM95TJ SL 271J 500V		
C563	4010008330	CER HM60TJ SL 330J 500V		
C564	4010005650	CER HM60SJ SL 200J 500V		
C565	4010008280	CER HM95TJ SL 221J 500V		
C566	4010008350	CER HM60TJ SL 220J 500V		
C567	4030006880	S.CER C1608 JB 1H 472K-T	T	152.2/32.2
C601	4030006880	S.CER C1608 JB 1H 472K-T	T	130.2/125
C604	4010008230	CER HM60TJ SL 820J 500V		
C605	4010008370	CER HM60TJ SL 150J 500V		
C606	4010008280	CER HM95TJ SL 221J 500V		
C607	4010008220	CER HM60TJ SL 680J 500V		
C608	4010008350	CER HM60TJ SL 220J 500V		
C609	4010008340	CER HM60TJ SL 270J 500V		
C610	4010008200	CER HM11TJ SL 331J 500V		
C611	4010008230	CER HM60TJ SL 820J 500V		
C612	4010008360	CER HM60TJ SL 180J 500V		
C613	4010008260	CER HM74TJ SL 151J 500V		
C614	4010008230	CER HM60TJ SL 820J 500V		
C615	4030006880	S.CER C1608 JB 1H 472K-T	T	130.2/18.3
C651	4030006880	S.CER C1608 JB 1H 472K-T	T	88.3/124.9
C654	4010008360	CER HM60TJ SL 180J 500V		
C655	4010008320	CER HM60TJ SL 390J 500V		
C656	4010008280	CER HM95TJ SL 221J 500V		
C657	4010008220	CER HM60TJ SL 680J 500V		
C658	4010008360	CER HM60TJ SL 180J 500V		
C659	4010008380	CER HM60TJ SL 120J 500V		
C660	4010008280	CER HM95TJ SL 221J 500V		
C661	4010008240	CER HM60TJ SL 101J 500V		
C662	4010008390	CER HM60TJ SL 100D 500V		
C663	4010008250	CER HM74TJ SL 121J 500V		
C664	4010008320	CER HM60TJ SL 390J 500V		
C665	4030006880	S.CER C1608 JB 1H 472K-T	T	96.6/28.6
C701	4030006880	S.CER C1608 JB 1H 472K-T	T	68.6/127.5
C703	4010008370	CER HM60TJ SL 150J 500V		
C704	4010008350	CER HM60TJ SL 220J 500V		
C705	4010005650	CER HM60SJ SL 200J 500V		
C706	4010005860	CER HM95SJ SL 201J 500V		
C707	4010008310	CER HM60TJ SL 470J 500V		
C708	4010008370	CER HM60TJ SL 150J 500V		
C709	4010008280	CER HM95TJ SL 221J 500V		
C710	4010008350	CER HM60TJ SL 220J 500V		
C712	4010008330	CER HM60TJ SL 330J 500V		
C713	4010008310	CER HM60TJ SL 470J 500V		
C714	4030006880	S.CER C1608 JB 1H 472K-T	T	69.6/18.3
C715	4010008360	CER HM60TJ SL 180J 500V		
C751	4030006880	S.CER C1608 JB 1H 472K-T	T	109.1/125
C755	4010008240	CER HM60TJ SL 101J 500V		
C756	4010008210	CER HM60TJ SL 560J 500V		
C756	4010008230	CER HM60TJ SL 820J 500V		
C757	4010008360	CER HM60TJ SL 180J 500V		
C758	4010008210	CER HM60TJ SL 560J 500V		
C759	4010008240	CER HM60TJ SL 101J 500V		
C760	4010008400	CER HM60TJ SL 060D 500V		
C761	4010008310	CER HM60TJ SL 470J 500V		
C763	4030006880	S.CER C1608 JB 1H 472K-T	T	115.6/28.6
C764	4010005650	CER HM60SJ SL 200J 500V		
C765	4010008370	CER HM60TJ SL 150J 500V		
C801	4030006880	S.CER C1608 JB 1H 472K-T	T	168.6/158.6
C804	4010008360	CER HM60TJ SL 180J 500V		
C805	4010008320	CER HM60TJ SL 390J 500V		
C806	4010008310	CER HM60TJ SL 470J 500V		
C807	4010005600	CER HM60SJ SL 090D 500V		
C808	4010008330	CER HM60TJ SL 330J 500V		
C809	4010008320	CER HM60TJ SL 390J 500V		
C810	4010008410	CER HM60TJ SL 030C 500V		
C811	4010005650	CER HM60SJ SL 050C 500V		
C813	4030006880	S.CER C1608 JB 1H 472K-T	T	175.6/26
RL401	6330001471	RLY AJS1311F-K2		
RL402	6330001471	RLY AJS1311F-K2		
RL451	6330001471	RLY AJS1311F-K2		
RL452	6330001471	RLY AJS1311F-K2		
RL501	6330001471	RLY AJS1311F-K2		
RL502	6330001471	RLY AJS1311F-K2		
RL551	6330001471	RLY AJS1311F-K2		
RL552	6330001471	RLY AJS1311F-K2		
RL601	6330001471	RLY AJS1311F-K2		
RL602	6330001471	RLY AJS1311F-K2		
RL651	6330001471	RLY AJS1311F-K2		
RL652	6330001471	RLY AJS1311F-K2		
RL701	6330001471	RLY AJS1311F-K2		
RL702	6330001471	RLY AJS1311F-K2		
RL751	6330001471	RLY AJS1311F-K2		
RL752	6330001471	RLY AJS1311F-K2		
RL801	6330001460	RLY FTR-F1CA012V		
RL802	6330001460	RLY FTR-F1CA012V		
J901	6510017930	CNR 1771P145-20		
J902	6510022031	S.CNR B10B-ZR-SM4-TF (LF) (SN)	T	145.3/165.2
J903	6510019971	S.CNR 52808-1071	T	4/156
J904	6510017930	CNR 1771P145-20		
J905	6510019421	S.CNR B8B-ZR-SM4-TF (LF) (SN)	T	146.8/160.2

[DC-DC UNIT]

REF NO.	ORDER NO.	DESCRIPTION	M.	H/V LOCATION
IC201	1180003100	S.REG BD9302FP-E2	T	124.4/52.7
IC401	1180003100	S.REG BD9302FP-E2	T	51.4/52.3
IC601	1180003100	S.REG BD9302FP-E2	T	87.9/52.3
IC801	1180002530	S.REG LM2594M-12	T	160.2/59.4
Q141	1590003310	S.TR DTD113ZK T146	T	28.4/79.8
D141	1750000520	S.DIO DAN222TL	T	26.2/77.8
D201	1750000960	S.DIO RB081L-20	T	122.8/61.3
D301	1750000960	S.DIO RB081L-20	T	124.7/44.2
D401	1750000960	S.DIO RB081L-20	T	49.8/61.9
D501	1750000960	S.DIO RB081L-20	T	53.8/43.6
D601	1750000960	S.DIO RB081L-20	T	86.4/60.8
D801	1710000840	S.DIO 1SR154-400 TE25	T	149.2/41.5
D802	1750001011	S.DIO MBRD835LT4G	T	150.5/57.5
D803	1750000960	S.DIO RB081L-20	T	156.8/67.5
L141	6200001831	S.COL NLV32T-100J	T	30.4/74.4
L201	6200013280	S.COL SFLF10145T-330M1R6-PF	T	118.5/68.1
L211	6200010881	S.COL CDRH124NP-330MC	T	132.7/66.9
L301	6200013280	S.COL SFLF10145T-330M1R6-PF	T	132.2/37.6
L302	6200010901	S.COL CDRH104RNP-100NC	T	116.7/37.5
L401	6200013280	S.COL SFLF10145T-330M1R6-PF	T	45.8/68.9
L411	6200010881	S.COL CDRH124NP-330MC	T	59.6/66.2
L501	6200013280	S.COL SFLF10145T-330M1R6-PF	T	46.2/37
L601	6200013280	S.COL SFLF10145T-330M1R6-PF	T	82.4/67.6
L611	6200010881	S.COL CDRH124NP-330MC	T	96.2/65.9
L801	6190001640	S.COL SFLF12555T-101M1R1-PF	T	159/47.5
L802	6190001191	S.COL D10F-#A814AY-101K	T	166.3/33
L803	6200013280	S.COL SFLF10145T-330M1R6-PF	T	147.2/30.8
R141	7030008190	S.RES ERJ12YJ330U (33)	T	27/73.6
R201	7030003680	S.RES ERJ3GEYJ 104 V (100 k)	T	114.1/59.1
R202	7030003600	S.RES ERJ3GEYJ 223 V (22 k)	T	116.9/59.1
R204	7030003610	S.RES ERJ3GEYJ 273 V (27 k)	T	117.6/57.2
R205	7030005451	S.RES ERA3YED 153V (15 k)	T	118/55.4
R301	7030003670	S.RES ERJ3GEYJ 823 V (82 k)	T	113.4/47.4
R302	7030003530	S.RES ERJ3GEYJ 562 V (5.6 k)	T	116.4/47.4
R303	7030003530	S.RES ERJ3GEYJ 562 V (5.6 k)	T	118.3/46.5
R304	7030003610	S.RES ERJ3GEYJ 273 V (27 k)	T	117.6/48.4
R401	7030003670	S.RES ERJ3GEYJ 823 V (82 k)	T	41.3/58.8
R402	7030003530	S.RES ERJ3GEYJ 562 V (5.6 k)	T	43.3/58.1
R403	7030003530	S.RES ERJ3GEYJ 562 V (5.6 k)	T	44/60
R404	7030003610	S.RES ERJ3GEYJ 273 V (27 k)	T	44.6/57.2
R405	7030005451	S.RES ERA3YED 153V (15 k)	T	45/55
R501	7030003610	S.RES ERJ3GEYJ 273 V (27 k)	T	41.5/46
R502	7030003590	S.RES ERJ3GEYJ 183 V (18 k)	T	44.3/46
R504	7030003610	S.RES ERJ3GEYJ 273 V (27 k)	T	44.9/47.8
R601	7030003680	S.RES ERJ3GEYJ 104 V (100 k)	T	78.1/58.7
R602	7030003600	S.RES ERJ3GEYJ 223 V (22 k)	T	80.8/58.7
R604	7030003610	S.RES ERJ3GEYJ 273 V (27 k)	T	81.3/56.8
R605	7030005451	S.RES ERA3YED 153V (15 k)	T	81.9/54.9
R706	7030003860	S.RES ERJ3GE JPW V	T	81.8/49.6
R801	7030003640	S.RES ERJ3GEYJ 473 V (47 k)	T	155.9/61.4
R802	7030003640	S.RES ERJ3GEYJ 473 V (47 k)	T	158.1/62.8
C8	4030006880	S.CER C1608 JB 1H 472K-T	T	112.7/17.9
C9	4510008700	S.ELE 25 CV 330 BS	T	111.6/11.9
C141	4030011600	S.CER C1608 JB 1E 104K-T	T	30.7/79.6
C201	4030011280	S.CER C1608 CH 1H 271J-T	T	114.1/57.9
C202	4030006860	S.CER C1608 JB 1H 102K-T	T	116.1/57.2
C203	4030011600	S.CER C1608 JB 1E 104K-T	T	118/54.2
C204	4030011600	S.CER C1608 JB 1E 104K-T	T	129.8/57.3
C205	4030018970	S.CER C3225 JB 1C 226MT-N	T	114.9/61.3
C206	4030007130	S.CER C1608 CH 1H 101J-T	T	118.9/57.4
C207	4030018970	S.CER C3225 JB 1C 226MT-N	T	114.4/54
C211	4030011600	S.CER C1608 JB 1E 104K-T	T	129.9/54.5
C212	4550007140	S.TAN TEESVD 1C 107M12R	T	134.1/49.5
C213	4030018970	S.CER C3225 JB 1C 226MT-N	T	133.1/56.6
C214	4030011600	S.CER C1608 JB 1E 104K-T	T	137.3/74.4
C301	4030011280	S.CER C1608 CH 1H 271J-T	T	114.7/47.4
C302	4030006860	S.CER C1608 JB 1H 102K-T	T	115.5/49.4
C303	4030011600	S.CER C1608 JB 1E 104K-T	T	118.5/50.3
C304	4030011600	S.CER C1608 JB 1E 104K-T	T	129.6/48.1
C305	4030018970	S.CER C3225 JB 1C 226MT-N	T	125.3/39.7
C306	4030007130	S.CER C1608 CH 1H 101J-T	T	119/48.4
C307	4030018970	S.CER C3225 JB 1C 226MT-N	T	116.3/44.4
C308	4030011600	S.CER C1608 JB 1E 104K-T	T	106.9/36.2
C401	4030011280	S.CER C1608 CH 1H 271J-T	T	41.3/60
C402	4030006860	S.CER C1608 JB 1H 102K-T	T	41.9/56.9
C403	4030011600	S.CER C1608 JB 1E 104K-T	T	45/53.8
C404	4030011600	S.CER C1608 JB 1E 104K-T	T	56.8/56.6
C405	4030018970	S.CER C3225 JB 1C 226MT-N	T	41.9/62.1
C406	4030007130	S.CER C1608 CH 1H 101J-T	T	46/57.2
C408	4030011600	S.CER C1608 JB 1E 104K-T	T	34.6/60
C411	4030011600	S.CER C1608 JB 1E 104K-T	T	56.8/53.8
C412	4550007140	S.TAN TEESVD 1C 107M12R	T	61/45.3
C413	4030018970	S.CER C3225 JB 1C 226MT-N	T	59.6/54.3
C501	4030011280	S.CER C1608 CH 1H 271J-T	T	41.5/47.3
C502	4030006860	S.CER C1608 JB 1H 102K-T	T	43.5/47.8
C503	4030011600	S.CER C1608 JB 1E 104K-T	T	45.3/49.8
C504	4030011600	S.CER C1608 JB 1E 104K-T	T	56.7/47.6
C505	4030018970	S.CER C3225 JB 1C 226MT-N	T	43.6/43.8
C506	4030007130	S.CER C1608 CH 1H 101J-T	T	46.1/47.8
C508	4030011600	S.CER C1608 JB 1E 104K-T	T	35.4/47.1
C601	4030011280	S.CER C1608 CH 1H 271J-T	T	78.1/57.4
C602	4030006860	S.CER C1608 JB 1H 102K-T	T	80.1/56.8
C603	4030011600	S.CER C1608 JB 1E 104K-T	T	82.2/52.9
C604	4030011600	S.CER C1608 JB 1E 104K-T	T	93.2/56.6

[DC-DC UNIT]

REF NO.	ORDER NO.	DESCRIPTION	M.	H/V LOCATION
C605	4030018970	S.CER C3225 JB 1C 226MT-N	T	78.9/60.8
C606	4030007130	S.CER C1608 CH 1H 101J-T	T	82.5/56.8
C607	4030018970	S.CER C3225 JB 1C 226MT-N	T	77.3/55.3
C608	4030018970	S.CER C3225 JB 1C 226MT-N	T	79/52.3
C611	4030011600	S.CER C1608 JB 1E 104K-T	T	93.2/54
C612	4550007140	S.TAN TEESVD 1C 107M12R	T	97.7/45.3
C613	4030018970	S.CER C3225 JB 1C 226MT-N	T	95.9/54.4
C801	4510008910	S.ELE EEFC1C101P	T	148.1/48.1
C802	4030011600	S.CER C1608 JB 1E 104K-T	T	160.7/62.8
C803	4510008940	S.ELE EEFC1V470P	T	147.6/66.3
C805	4030018970	S.CER C3225 JB 1C 226MT-N	T	150/23.5
RL142	6330001760	RLY AW3023		
J1	6510022801	S.CNR B10B-PH-SM4-TB (LF) (SN)	T	24.5/23.9
J2	6510020251	S.CNR B9B-PH-SM4-TB (LF) (SN)	T	24.5/54.1
J3	6510018941	S.CNR B13B-PH-SM4-TB (LF) (SN)	T	60.2/24.5
J5	6510018951	S.CNR B7B-PH-SM4-TB (LF) (SN)	T	55.9/10.2
J6	6510023261	S.CNR B6B-PH-SM4-TB (LF) (SN)	T	80.3/10.2
J7	6510018921	S.CNR B8B-PH-SM4-TB (LF) (SN)	T	91/24.5
J8	6510018971	S.CNR B4B-PH-SM4-TB (LF) (SN)	T	112.9/24.5
W1	9030090150	WIR OPC-1803		
EP201	6910014730	S.BEA MPZ2012S331A-T	T	112/57.1
EP211	6910014730	S.BEA MPZ2012S331A-T	T	128.3/74.2
EP301	6910014730	S.BEA MPZ2012S331A-T	T	124.8/33.2
EP302	6910014730	S.BEA MPZ2012S331A-T	T	103.6/28.4
EP401	6910014730	S.BEA MPZ2012S331A-T	T	38.9/60.3
EP402	6910014730	S.BEA MPZ2012S331A-T	T	33.4/57.6
EP501	6910014730	S.BEA MPZ2012S331A-T	T	40/48.8
EP502	6910014730	S.BEA MPZ2012S331A-T	T	34.3/49.3
EP601	6910014730	S.BEA MPZ2012S331A-T	T	75.7/58.3
EP602	6910014730	S.BEA MPZ2012S331A-T	T	75.7/52.2

[TUNER UNIT]

REF NO.	ORDER NO.	DESCRIPTION	M.	H/V LOCATION
MF1	2710000780	MTR MP24Z (STEPPING MOTOR		
MF2	2710000780	MTR MP24Z (STEPPING MOTOR		
MF3	2710000470	FAN MF60B-12H901		
W1	8900012901	CBL OPC-1345R		
W2	8900012901	CBL OPC-1345R		
W3	8900017140	CBL OPC-927A (P1,N24,L100)		
W51	8600037090	CBL SX2590 P51*P52*P53TU		

M.=Mounted side (T: Mounted on the Top side B: Mounted on the Bottom side)
S.=Surface mount

[CTRL BOARD]

REF NO.	ORDER NO.	DESCRIPTION	M.	H/V LOCATION
IC1	1140004120	S.IC M38022M2-138FP	T	65.7/81.8
IC2	1130010390	S.IC HN58X2416TI	T	54/86.9
IC3	1130003921	S.IC TC4S69F (TE85R,F)	T	62/59.5
IC4	1180001071	S.IC TA7805F (TE16L,Q)	B	71.5/47.5
IC5	1130009691	S.IC TC74HCT7007AF (F)	B	92.5/91.6
IC6	1130006441	S.IC TC7S08F (TE85R,F)	T	81.7/70.3
IC51	1130011530	S.IC CD74HC4094M96	T	42.2/72.4
IC52	1130007690	S.IC BU4066BCF-E2	B	12.5/76.9
IC55	1130011530	S.IC CD74HC4094M96	B	100.2/76.1
IC56	1130011530	S.IC CD74HC4094M96	B	114.3/76.1
IC57	1160000131	S.IC TD62783AFG (S,EL)	T	99.6/73.1
IC58	1160000131	S.IC TD62783AFG (S,EL)	T	113.7/73.1
IC101	1110000960	S.IC NJM4558M-TE1-#FMZB	T	18.3/47.8
IC151	1120002301	S.IC TC74AC04F (F)	B	32.8/53.1
IC153	1130012011	S.IC TC7S232F (TE85L,F)	T	27.8/48.6
IC154	1130012011	S.IC TC7S232F (TE85L,F)	T	40.4/48.6
IC155	1130012011	S.IC TC7S232F (TE85L,F)	T	34.2/51.9
IC156	1130012021	S.IC TC74ACT112F (EL,F)	T	35.4/58.9
IC201	1110000960	S.IC NJM4558M-TE1-#FMZB	B	61.3/58.2
IC301	1110002690	S.IC NJM2903M-TE1-#FMZB	T	80/59
IC401	1160000131	S.IC TD62783AFG (S,EL)	T	13.6/86.1
IC402	1160000131	S.IC TD62783AFG (S,EL)	T	31.6/84.7
IC403	1160000131	S.IC TD62783AFG (S,EL)	B	24.7/88
Q1	1590001330	S.TR DTA114EUA T106	T	78.5/75.2
Q2	1590000680	S.TR DTC114EUA T106	T	77.8/71.2
Q3	1590000680	S.TR DTC114EUA T106	T	128.4/74.5
Q4	1590000680	S.TR DTC114EUA T106	T	128.4/77
Q5	1590000680	S.TR DTC114EUA T106	T	128.4/81.3
Q6	1590000680	S.TR DTC114EUA T106	T	128.4/83.8
Q7	1590000680	S.TR DTC114EUA T106	T	128.4/88.5
Q8	1590000680	S.TR DTC114EUA T106	T	128.4/91
Q9	1590000680	S.TR DTC114EUA T106	T	128.4/95.7
Q10	1590000680	S.TR DTC114EUA T106	T	128.4/100.5
Q11	1590000680	S.TR DTC114EUA T106	B	85.7/99.8
Q51	1590000680	S.TR DTC114EUA T106	T	6.1/78.6
Q52	1590000680	S.TR DTC114EUA T106	T	12.5/78.6
Q53	1590000680	S.TR DTC114EUA T106	B	6.6/72.8
Q54	1560001260	S.FET 2SK3018 T106	B	121.8/80.4
Q55	1590000680	S.TR DTC114EUA T106	B	130.2/68.9
Q59	1590000680	S.TR DTC114EUA T106	T	56.8/69.5
Q151	1590000680	S.TR DTC114EUA T106	B	39.8/42.3
Q152	1590000680	S.TR DTC114EUA T106	B	39.8/39.5
Q153	1590001330	S.TR DTA114EUA T106	B	39.8/45.1
Q201	1560000871	S.FET 2SK515-T1B-A (X33)	B	50.4/51.8
Q252	1520000561	S.TR 2SB1123 T-TD-E	T	18.8/6.7
Q253	1540000441	S.TR 2SD1619T-TD-E	B	26.6/6.7
Q254	1590000680	S.TR DTC114EUA T106	T	24.9/5.4
Q255	1590002420	S.TR UMD3N TR	T	97.4/12.1
Q256	1590000680	S.TR DTC114EUA T106	T	101.4/12.4
D1	1730000411	S.ZEN RD5.1M-T2B-A B2	T	69.8/58.7
D2	1710000780	S.DIO MA114 (TX)	T	73.8/58.7
D3	1750000201	S.DIO 1SS319 (TE85R,F)	B	129.5/98.1
D4	1750000201	S.DIO 1SS319 (TE85R,F)	B	129.5/90
D5	1750000201	S.DIO 1SS319 (TE85R,F)	B	129.5/82.8
D6	1750000201	S.DIO 1SS319 (TE85R,F)	B	129.5/76
D7	1730000031	S.ZEN RD5.6M-T2B-A B2	T	69.8/55.3
D101	1790000491	S.DIO HSM88A-STR-E	B	16.5/37.1
D102	1790000491	S.DIO HSM88A-STR-E	B	20.5/37.1
D103	1750000201	S.DIO 1SS319 (TE85R,F)	B	18.5/57
D151	1790000491	S.DIO HSM88A-STR-E	B	33.5/45.3
D152	1790000491	S.DIO HSM88A-STR-E	T	37/44.2
D153	1790000491	S.DIO HSM88A-STR-E	B	27.6/61.1
D154	1790000491	S.DIO HSM88A-STR-E	B	39.4/61.1
D201	1790000491	S.DIO HSM88A-STR-E	B	50.3/45.6
D202	1790000491	S.DIO HSM88A-STR-E	T	44.9/45.5
D203	1750000201	S.DIO 1SS319 (TE85R,F)	B	54.5/58.2
D301	1790000491	S.DIO HSM88A-STR-E	B	82.8/52.5
D302	1790000491	S.DIO HSM88A-STR-E	B	89.2/58
D303	1710000140	S.DIO U05G	T	94.6/12.3
D304	1750000271	S.DIO 1SS301 (TE85L,F)	T	94.6/12.3
X1	6050009890	S.XTL CR-569 (6.144 MHz)	T	83.2/79.5
L1	6200003261	S.COL NLV32T-101J	T	51.1/76.5
L2	6200003261	S.COL NLV32T-101J	T	54.5/77.8
L5	6200005131	S.COL NLC453232T-101K-PF	T	121.6/100.3
L51	6200003261	S.COL NLV32T-101J	T	106.3/86.9
L52	6200005131	S.COL NLC453232T-101K-PF	T	114.9/88.1
L101	6140004410	S.COL LR-502	T	26.7/56.3
L102	6200001831	S.COL NLV32T-100J	T	14/56.3
L103	6200003261	S.COL NLV32T-101J	T	14/56.3
L151	6140004410	S.COL LR-502	T	43.1/62.7
L152	6200001831	S.COL NLV32T-100J	T	43.1/62.7
L201	6140004410	S.COL LR-502	T	76.9/60.8
L202	6180003300	S.COL T6-222J (2.2M)	T	76.9/60.8
L301	6140004410	S.COL LR-502	T	76.9/60.8
L302	6200003261	S.COL NLV32T-101J	T	76.9/60.8
L403	6140004670	S.COL LR-527 (CH160808TR271)	T	76.9/60.8
L404	6140004670	S.COL LR-527 (CH160808TR271)	T	76.9/60.8
R2	7030003680	S.RES ERJ3GEYJ 104 V (100 k)	T	63/71
R3	7030003680	S.RES ERJ3GEYJ 104 V (100 k)	T	64.3/71
R4	7030003680	S.RES ERJ3GEYJ 104 V (100 k)	T	65.6/71
R5	7030003680	S.RES ERJ3GEYJ 104 V (100 k)	T	66.9/71
R6	7030003560	S.RES ERJ3GEYJ 103 V (10 k)	T	74.7/71
R7	7030003440	S.RES ERJ3GEYJ 102 V (1 k)	T	73.4/71
R8	7030003680	S.RES ERJ3GEYJ 104 V (100 k)	T	55.4/72.8
R9	7030003680	S.RES ERJ3GEYJ 104 V (100 k)	T	54.7/74.7
R10	7030003680	S.RES ERJ3GEYJ 104 V (100 k)	T	57.3/72.9
R11	7030003680	S.RES ERJ3GEYJ 104 V (100 k)	T	53.4/74.7
R12	7030003440	S.RES ERJ3GEYJ 102 V (1 k)	T	78.3/83.9
R13	7030003680	S.RES ERJ3GEYJ 104 V (100 k)	T	76.6/75.6
R14	7030003680	S.RES ERJ3GEYJ 104 V (100 k)	T	78.5/78.2
R15	7030003440	S.RES ERJ3GEYJ 102 V (1 k)	T	61.7/62
R16	7030003220	S.RES ERJ3GEYJ 101 V (100 k)	T	62.2/55.8
R17	7030003560	S.RES ERJ3GEYJ 103 V (10 k)	T	54.1/82.2
R18	7030003560	S.RES ERJ3GEYJ 103 V (10 k)	T	54.1/80.9
R19	7030003680	S.RES ERJ3GEYJ 104 V (100 k)	T	64.7/59
R20	7030003570	S.RES ERJ3GEYJ 123 V (12 k)	T	67.7/61.1
R21	7030003650	S.RES ERJ3GEYJ 563 V (56 k)	T	66/59
R22	7030003450	S.RES ERJ3GEYJ 122 V (1.2 k)	T	73.3/61.1
R23	7030003380	S.RES ERJ3GEYJ 471 V (470)	B	105.1/100
R24	7030003440	S.RES ERJ3GEYJ 102 V (1 k)	B	102.9/98.8
R25	7030003380	S.RES ERJ3GEYJ 331 V (330)	B	126/99.1
R26	7030003380	S.RES ERJ3GEYJ 331 V (330)	B	126/97.1
R27	7030003380	S.RES ERJ3GEYJ 331 V (330)	B	126/91
R28	7030003380	S.RES ERJ3GEYJ 331 V (330)	B	126/89
R29	7030003380	S.RES ERJ3GEYJ 331 V (330)	B	126/83.8
R30	7030003380	S.RES ERJ3GEYJ 331 V (330)	B	126/81.8
R31	7030003380	S.RES ERJ3GEYJ 331 V (330)	B	126/77
R32	7030003380	S.RES ERJ3GEYJ 331 V (330)	B	126/75
R40	7030003440	S.RES ERJ3GEYJ 102 V (1 k)	T	61.2/99.9
R42	7030003860	S.RES ERJ3GE JPW V	T	60.4/71
R43	7030003860	S.RES ERJ3GE JPW V	T	60.7/69
R44	7030003860	S.RES ERJ3GE JPW V	T	68.2/71
R45	7030003860	S.RES ERJ3GE JPW V	T	65.7/68.5
R46	7030003860	S.RES ERJ3GE JPW V	T	70.6/68.9
R51	7030003440	S.RES ERJ3GEYJ 102 V (1 k)	T	35.5/77.3
R52	7030003440	S.RES ERJ3GEYJ 102 V (1 k)	T	34.2/77.3
R53	7030003860	S.RES ERJ3GE JPW V	T	32.9/77.3
R54	7030003860	S.RES ERJ3GE JPW V	T	31.6/77.3
R55	7030003860	S.RES ERJ3GE JPW V	B	29.6/80.1
R56	7030003860	S.RES ERJ3GE JPW V	B	28/80.1
R57	7030003860	S.RES ERJ3GE JPW V	B	26.4/80.1
R58	7030003860	S.RES ERJ3GE JPW V	B	24.8/80.1
R59	7030003860	S.RES ERJ3GE JPW V	T	18.3/78.7
R60	7030003860	S.RES ERJ3GE JPW V	T	17/76
R61	7030003860	S.RES ERJ3GE JPW V	T	15.7/76
R62	7030003860	S.RES ERJ3GE JPW V	T	14.4/78.7
R63	7030003860	S.RES ERJ3GE JPW V	T	10.6/78.7
R64	7030003860	S.RES ERJ3GE JPW V	T	9.3/78.4
R65	7030003860	S.RES ERJ3GE JPW V	T	8/74.8
R66	7030003520	S.RES ERJ3GEYJ 472 V (4.7 k)	B	15.6/81.6
R67	7030003200	S.RES ERJ3GEYJ 100 V (10)	T	99.8/90.4
R68	7030003200	S.RES ERJ3GEYJ 100 V (10)	T	98.5/90.4
R69	7030003200	S.RES ERJ3GEYJ 100 V (10)	T	97.2/90.4
R70	7030004040	S.RES ERJ3GEYJ 4R7 V (4.7)	T	104.8/65.9
R71	7030004040	S.RES ERJ3GEYJ 4R7 V (4.7)	T	103.5/65.9
R72	7030004040	S.RES ERJ3GEYJ 4R7 V (4.7)	T	102.2/65.9
R73	7030004040	S.RES ERJ3GEYJ 4R7 V (4.7)	T	100.9/65.9
R74	7030004040	S.RES ERJ3GEYJ 4R7 V (4.7)	T	99.6/65.9
R75	7030004040	S.RES ERJ3GEYJ 4R7 V (4.7)	T	98.3/65.9
R76	7030004040	S.RES ERJ3GEYJ 4R7 V (4.7)	T	97/65.9
R77	7030004040	S.RES ERJ3GEYJ 4R7 V (4.7)	T	95.7/65.9
R78	7030004040	S.RES ERJ3GEYJ 4R7 V (4.7)	B	120.1/64.6
R84	7030003240	S.RES ERJ3GEYJ 220 V (22)	B	110.5/64.6
R85	7030003240	S.RES ERJ3GEYJ 220 V (22)	B	108.9/64.6
R86	7030003560	S.RES ERJ3GEYJ 103 V (10 k)	B	116.1/83.6
R87	7030003440	S.RES ERJ3GEYJ 102 V (1 k)	T	71.8/94.4
R88	7030003440	S.RES ERJ3GEYJ 102 V (1 k)	T	75.7/88.1
R89	7030003440	S.RES ERJ3GEYJ 102 V (1 k)	T	73.3/94.4
R90	7030003440	S.RES ERJ3GEYJ 102 V (1 k)	T	77.2/88.1
R91	7030003440	S.RES ERJ3GEYJ 102 V (1 k)	T	74.8/94.4
R92	7030003440	S.RES ERJ3GEYJ 102 V (1 k)	T	78.7/88.1
R93	7030003440	S.RES ERJ3GEYJ 102 V (1 k)	T	76.3/94.4
R95	7030003860	S.RES ERJ3GE JPW V	T	15.7/78.7
R97	7030003860	S.RES ERJ3GE JPW V	T	8/78.7
R101	7030010950	S.RES ERJ1TYJ 100U (10)	T	16.4/39.4
R102	7030010950	S.RES ERJ1TYJ 100U (10)	T	20.2/39.4
R103	7030003560	S.RES ERJ3GEYJ 103 V (10 k)	B	16.7/42.9
R104	7030003560	S.RES ERJ3GEYJ 103 V (10 k)	B	20.3/42.9
R105	7030003720	S.RES ERJ3GEYJ 224 V (220 k)	B	15.1/44.5
R106	7030003720	S.RES ERJ3GEYJ 224 V (220 k)	B	21.9/44.5
R107	7030003660	S.RES ERJ3GEYJ 683 V (68 k)	T	12.4/45.8
R108	7030003660	S.RES ERJ3GEYJ 683 V (68 k)	T	24.1/45.8
R109	7030003720	S.RES ERJ3GEYJ 224 V (220 k)	T	12.4/47.1
R110	7030003720	S.RES ERJ3GEYJ 224 V (220 k)	T	24.1/47.1
R111	7030009340	S.RES ERJ3GEYJ 275V (2.7 M)	T	12.4/48.4
R112	7030003810	S.RES ERJ3GEYJ 125 V (1.2 M)	T	24.1/48.4
R113	7030003440	S.RES ERJ3GEYJ 102 V (1 k)	B	14.5/51.4
R114	7030003440	S.RES ERJ3GEYJ 102 V (1 k)	B	22.4/51.4
R115	7030009340	S.RES ERJ3GEYJ 275V (2.7 M)	T	12.4/49.7
R118	7030003860	S.RES ERJ3GE JPW V	B	17.5/40.5
R119	7030003860	S.RES ERJ3GE JPW V	B	19.5/40.5
R131	7030003440	S.RES ERJ3GEYJ 102 V (1 k)	B	73.1/81
R132	7030003440	S.RES ERJ3GEYJ 102 V (1 k)	B	70.1/81.9
R133	7030003440	S.RES ERJ3GEYJ 102 V (1 k)	B	73.2/82.8
R134	7030003440	S.RES ERJ3GEYJ 102 V (1 k)	B	70.1/83.7
R135	7030003440	S.RES ERJ3GEYJ 102 V (1 k)	B	73.2/84.6
R136	7030003440	S.RES ERJ3GEYJ 102 V (1 k)	B	70.1/85.5
R137	7030003440	S.RES ERJ3GEYJ 102 V (1 k)	B	73.1/86.4
R138	7030003440	S.RES ERJ3GEYJ 102 V (1 k)	B	70.1/87.5
R139	7030003440	S.RES ERJ3GEYJ 102 V (1 k)	T	63.8/94.4
R140	7030003440	S.RES ERJ3GEYJ 102 V (

[CTRL BOARD]

REF NO.	ORDER NO.	DESCRIPTION	M.	H/V LOCATION
R153	7030007190	S.RES ERJ12YJ220U (22)	T	32.8/41.4
R154	7030010620	S.RES ERJ12YJ180U (18)	B	33.2/41.4
R155	7030003320	S.RES ERJ3GEYJ 101 V (100)	T	33.9/45.5
R157	7030003320	S.RES ERJ3GEYJ 101 V (100)	B	27.9/47.4
R158	7030003560	S.RES ERJ3GEYJ 103 V (10 k)	B	27.1/49.8
R159	7030003560	S.RES ERJ3GEYJ 103 V (10 k)	B	38.5/51.2
R160	7030003280	S.RES ERJ3GEYJ 470 V (47)	B	27.1/52.9
R161	7030003280	S.RES ERJ3GEYJ 470 V (47)	B	38.5/54.3
R162	7030003440	S.RES ERJ3GEYJ 102 V (1 k)	B	25.5/56
R163	7030003440	S.RES ERJ3GEYJ 102 V (1 k)	B	40.1/54.3
R164	7030003280	S.RES ERJ3GEYJ 470 V (47)	T	30.5/48.6
R165	7030003280	S.RES ERJ3GEYJ 470 V (47)	T	37.9/48.6
R166	7030003440	S.RES ERJ3GEYJ 102 V (1 k)	T	31.8/48.6
R167	7030003440	S.RES ERJ3GEYJ 102 V (1 k)	T	36.6/48.6
R168	7030003280	S.RES ERJ3GEYJ 470 V (47)	T	37.3/53
R169	7030003440	S.RES ERJ3GEYJ 102 V (1 k)	T	37.3/51.7
R170	7030003280	S.RES ERJ3GEYJ 470 V (47)	B	31.9/60.8
R171	7030003280	S.RES ERJ3GEYJ 470 V (47)	B	33.5/60.8
R172	7030003480	S.RES ERJ3GEYJ 222 V (2.2 k)	B	36.7/60.8
R173	7030003500	S.RES ERJ3GEYJ 332 V (3.3 k)	B	30.3/63.9
R174	7030003360	S.RES ERJ3GEYJ 221 V (220)	B	44.2/61.6
R201	7030010420	S.RES ERJ1TYJ 560U (56)	T	47.3/37.5
R202	7030010420	S.RES ERJ1TYJ 560U (56)	B	47.9/37.2
R203	7030010420	S.RES ERJ1TYJ 560U (56)	T	47.3/41.5
R204	7030010420	S.RES ERJ1TYJ 560U (56)	B	47.9/41.8
R205	7030003560	S.RES ERJ3GEYJ 103 V (10 k)	T	47.8/49.1
R206	7030003560	S.RES ERJ3GEYJ 103 V (10 k)	B	51.5/48.4
R207	7030003800	S.RES ERJ3GEYJ 105 V (1 M)	T	50.2/49.1
R208	7030003560	S.RES ERJ3GEYJ 103 V (10 k)	B	53.1/51.5
R209	7030003520	S.RES ERJ3GEYJ 472 V (4.7 k)	B	54.8/48.1
R209	7030003600	S.RES ERJ3GEYJ 223 V (22 k)	B	54.8/48.1
R210	7030003440	S.RES ERJ3GEYJ 102 V (1 k)	B	55.5/50.6
R211	7030003480	S.RES ERJ3GEYJ 222 V (2.2 k)	B	60.7/67.4
R212	7030003560	S.RES ERJ3GEYJ 103 V (10 k)	B	59.1/49
R213	7030005331	S.RES ERA3YED 562V (5.6 k)	B	63.8/64.2
R214	7030005331	S.RES ERA3YED 562V (5.6 k)	B	62.2/64.2
R215	7030005871	S.RES ERA3YKD 104V (100 k)	B	59.8/65
R216	7030005331	S.RES ERA3YED 562V (5.6 k)	B	62.2/52.3
R216	7030008121	S.RES ERA3YED 682V (6.8 k)	B	62.2/52.3
R217	7030008121	S.RES ERA3YED 682V (6.8 k)	B	63.8/52
R218	7030005871	S.RES ERA3YKD 104V (100 k)	B	59.8/51.4
R221	7030003670	S.RES ERJ3GEYJ 823 V (82 k)	B	57.4/58.2
R222	7030003680	S.RES ERJ3GEYJ 104 V (100 k)	B	65.4/52.7
R223	7030003820	S.RES ERJ3GEYJ 155 V (1.5 M)	B	59.8/63.4
R224	7030003820	S.RES ERJ3GEYJ 155 V (1.5 M)	B	59.8/53
R225	7030003560	S.RES ERJ3GEYJ 103 V (10 k)	B	57.6/61.9
R226	7030003560	S.RES ERJ3GEYJ 103 V (10 k)	B	57.6/54.5
R227	7030003560	S.RES ERJ3GEYJ 103 V (10 k)	B	54.4/61.7
R228	7030003560	S.RES ERJ3GEYJ 103 V (10 k)	B	52.8/61.7
R251	7540000100	ABS SRYH-350L		
R301	7030003560	S.RES ERJ3GEYJ 103 V (10 k)	B	82.8/49.8
R302	7030003670	S.RES ERJ3GEYJ 823 V (82 k)	B	83.4/55.9
R302	7030003680	S.RES ERJ3GEYJ 104 V (100 k)	B	83.4/55.9
R303	7030010910	S.RES ERJ1TYJ 150U (15)	B	95.9/60.6
R304	7030003670	S.RES ERJ3GEYJ 823 V (82 k)	B	84.1/59.9
R305	7030003720	S.RES ERJ3GEYJ 224 V (220 k)	B	81.7/57.8
R306	7030003660	S.RES ERJ3GEYJ 683 V (68 k)	T	85.2/60.5
R307	7030003660	S.RES ERJ3GEYJ 683 V (68 k)	B	80.1/55.1
R308	7030003840	S.RES ERJ3GEYJ 225 V (2.2 M)	T	81.6/55.1
R309	7030003720	S.RES ERJ3GEYJ 224 V (220 k)	T	88.6/59.8
R310	7030003840	S.RES ERJ3GEYJ 225 V (2.2 M)	T	87.8/57.7
R311	7030003440	S.RES ERJ3GEYJ 102 V (1 k)	T	85.2/57.7
R311	7030003560	S.RES ERJ3GEYJ 103 V (10 k)	T	85.2/57.7
R312	7030003560	S.RES ERJ3GEYJ 103 V (10 k)	T	86.5/57.7
R312	7030003680	S.RES ERJ3GEYJ 104 V (100 k)	T	86.5/57.7
R313	7030003700	S.RES ERJ3GEYJ 154 V (150 k)	B	81.7/55.1
R345	7030003560	S.RES ERJ3GEYJ 103 V (10 k)	T	88.3/82.8
R346	7030003680	S.RES ERJ3GEYJ 104 V (100 k)	B	105.1/96.5
R351	7030003440	S.RES ERJ3GEYJ 102 V (1 k)	T	103.2/9.9
R401	7030003240	S.RES ERJ3GEYJ 220 V (22)	T	17.5/93.4
R402	7030003240	S.RES ERJ3GEYJ 220 V (22)	T	16.2/93.4
R403	7030003240	S.RES ERJ3GEYJ 220 V (22)	T	14.9/93.4
R404	7030003240	S.RES ERJ3GEYJ 220 V (22)	T	13.6/93.4
R405	7030003240	S.RES ERJ3GEYJ 220 V (22)	T	12.3/93.4
R406	7030003240	S.RES ERJ3GEYJ 220 V (22)	T	11.9/93.4
R407	7030003240	S.RES ERJ3GEYJ 220 V (22)	T	9.7/93.4
R408	7030003240	S.RES ERJ3GEYJ 220 V (22)	T	8.4/93.4
R409	7030003240	S.RES ERJ3GEYJ 220 V (22)	B	36.6/86.7
R410	7030003240	S.RES ERJ3GEYJ 220 V (22)	B	35.1/86.7
R411	7030003240	S.RES ERJ3GEYJ 220 V (22)	B	33.6/86.7
R412	7030003240	S.RES ERJ3GEYJ 220 V (22)	B	32/86.7
R413	7030003240	S.RES ERJ3GEYJ 220 V (22)	B	33.2/93
R414	7030003240	S.RES ERJ3GEYJ 220 V (22)	B	36.9/92.2
R415	7030003240	S.RES ERJ3GEYJ 220 V (22)	B	33.2/91.3
R416	7030003240	S.RES ERJ3GEYJ 220 V (22)	B	36.8/90.5
R417	7030003480	S.RES ERJ3GEYJ 222 V (2.2 k)	B	30.8/98.5
R418	7030003480	S.RES ERJ3GEYJ 222 V (2.2 k)	B	46.4/98.5
R419	7030003480	S.RES ERJ3GEYJ 222 V (2.2 k)	B	32.4/98.5
R420	7030003480	S.RES ERJ3GEYJ 222 V (2.2 k)	B	48/98.5
R421	7030003480	S.RES ERJ3GEYJ 222 V (2.2 k)	B	34/98.5
R422	7030003480	S.RES ERJ3GEYJ 222 V (2.2 k)	B	49.6/98.5
R423	7030003480	S.RES ERJ3GEYJ 222 V (2.2 k)	B	35.6/98.5
R424	7030003480	S.RES ERJ3GEYJ 222 V (2.2 k)	B	51.2/98.5
R425	7030003480	S.RES ERJ3GEYJ 222 V (2.2 k)	B	37.2/98.5
R426	7030003480	S.RES ERJ3GEYJ 222 V (2.2 k)	B	52.8/98.5
R427	7030003480	S.RES ERJ3GEYJ 222 V (2.2 k)	B	38.8/98.5
R428	7030003480	S.RES ERJ3GEYJ 222 V (2.2 k)	B	54.4/98.5
R429	7030003480	S.RES ERJ3GEYJ 222 V (2.2 k)	B	40.4/98.5
R430	7030003480	S.RES ERJ3GEYJ 222 V (2.2 k)	B	56/98.5
R431	7030003480	S.RES ERJ3GEYJ 222 V (2.2 k)	B	42/98.5
R432	7030003480	S.RES ERJ3GEYJ 222 V (2.2 k)	B	57.6/98.5
R433	7030003720	S.RES ERJ3GEYJ 224 V (220 k)	B	46.5/7.9
R434	7030010580	S.RES ERJ1TYJ 1R5U (1.5)	T	31/4.6
R434	7030011130	S.RES ERJ1TYJ 1R0U (1)	T	31/4.6

[CTRL BOARD]

REF NO.	ORDER NO.	DESCRIPTION	M.	H/V LOCATION
R435	7030010580	S.RES ERJ1TYJ 1R5U (1.5)	T	31/8.8
R435	7030011130	S.RES ERJ1TYJ 1R0U (1)	T	31/8.8
R436	7030010580	S.RES ERJ1TYJ 1R5U (1.5)	B	38.8/8.8
R436	7030011130	S.RES ERJ1TYJ 1R0U (1)	B	38.8/8.8
R437	7030010580	S.RES ERJ1TYJ 1R5U (1.5)	B	38.8/4.6
R437	7030011130	S.RES ERJ1TYJ 1R0U (1)	B	38.8/4.6
R438	7030003640	S.RES ERJ3GEYJ 473 V (47 k)	T	22.7/8.3
R439	7030003340	S.RES ERJ3GEYJ 151 V (15 k)	T	22.7/5.2
R439	7030003400	S.RES ERJ3GEYJ 471 V (470)	T	22.7/5.2
R440	7030003400	S.RES ERJ3GEYJ 471 V (470)	B	30.5/8.3
R440	7030003440	S.RES ERJ3GEYJ 102 V (1 k)	B	30.5/8.3
R441	7030003560	S.RES ERJ3GEYJ 103 V (10 k)	B	30.5/5.2
R442	7030003640	S.RES ERJ3GEYJ 473 V (47 k)	B	32.1/8.3
R443	7030003640	S.RES ERJ3GEYJ 473 V (47 k)	T	99.5/13.5
C1	4510008540	S.ELE EEE1CA100SR	T	42.6/80.3
C2	4030011600	S.CER C1608 JB 1E 104K-T	T	45.8/82.3
C3	4030006880	S.CER C1608 JB 1H 472K-T	B	83.5/100
C4	4030006900	S.CER C1608 JB 1H 103K-T	T	56/74.7
C5	4030006900	S.CER C1608 JB 1H 103K-T	T	58.6/72.9
C7	4030017810	S.CER C1608 CH 1H 102J-T	T	75.3/76.6
C8	4030011600	S.CER C1608 JB 1E 104K-T	T	56/81.3
C9	4030009990	S.CER C1608 CH 1H 200J-T	T	75.3/80.5
C10	4030011600	S.CER C1608 JB 1E 104K-T	T	51.7/79.8
C11	4030006880	S.CER C1608 JB 1H 472K-T	T	76.6/78.2
C12	4030009990	S.CER C1608 CH 1H 200J-T	T	76.6/81.5
C13	4510008870	S.ELE EEE1AA471UP	T	48.6/56.7
C14	4030011600	S.CER C1608 JB 1E 104K-T	T	67.4/56.2
C15	4030011600	S.CER C1608 JB 1E 104K-T	T	72.9/56.3
C16	4510008500	S.ELE EEE1CA101WP	T	75.3/50.5
C17	4510008550	S.ELE EEE1HA010SR	T	133.3/100.5
C18	4510008550	S.ELE EEE1HA010SR	T	133.3/95.7
C19	4510008550	S.ELE EEE1HA010SR	T	138.4/91.9
C20	4510008550	S.ELE EEE1HA010SR	T	133.3/89.7
C21	4510008550	S.ELE EEE1HA010SR	T	138.4/85.3
C22	4510008550	S.ELE EEE1HA010SR	T	133.3/83.1
C23	4510008550	S.ELE EEE1HA010SR	T	138.4/78.6
C24	4510008550	S.ELE EEE1HA010SR	T	133.3/76.5
C25	4030011600	S.CER C1608 JB 1E 104K-T	T	62.2/57.1
C26	4030006880	S.CER C1608 JB 1H 472K-T	T	67.4/59
C40	4030011600	S.CER C1608 JB 1E 104K-T	T	84/70.6
C41	4030011600	S.CER C1608 JB 1E 104K-T	T	78.5/73.2
C43	4030006880	S.CER C1608 JB 1H 472K-T	B	85.7/97.3
C45	4030011600	S.CER C1608 JB 1E 104K-T	T	92.2/88.2
C46	4510008870	S.ELE EEE1AA471UP	T	66.9/49.2
C48	4030011600	S.CER C1608 JB 1E 104K-T	B	118.9/97.7
C66	4510008540	S.ELE EEE1CA100SR	T	106.6/81.6
C68	4030011600	S.CER C1608 JB 1E 104K-T	B	106.7/78.4
C69	4030011600	S.CER C1608 JB 1E 104K-T	T	118.4/79.9
C70	4030011600	S.CER C1608 JB 1E 104K-T	T	95.8/80.5
C71	4030011600	S.CER C1608 JB 1E 104K-T	T	106.9/77.6
C72	4510008540	S.ELE EEE1CA100SR	T	111.6/83.3
C88	4030011600	S.CER C1608 JB 1E 104K-T	B	6.9/78.2
C101	4030011070	S.CER GRM31M2C2H5R0CY21L	B	10.8/12.6
C102	4010005530	CER HM60SJ SL 020C 500V		
C103	4010005530	CER HM60SJ SL 020C 500V		
C105	4030007070	S.CER C1608 CH 1H 330J-T	B	11.4/35.6
C106	4030011540	S.CER C1608 CH 1H 750J-T	B	20.3/34
C107	4030017810	S.CER C1608 CH 1H 102J-T	B	13.6/42.9
C108	4030017810	S.CER C1608 CH 1H 102J-T	B	23.4/42.9
C109	4030006880	S.CER C1608 JB 1H 472K-T	B	20/47.9
C110	4030006880	S.CER C1608 JB 1H 472K-T	B	16.9/47.9
C111	4510008540	S.ELE EEE1CA100SR	T	22.8/54.1
C112	4510008540	S.ELE EEE1CA100SR	T	18/54.1
C113	4030006880	S.CER C1608 JB 1H 472K-T	B	16.9/50.7
C114	4030006880	S.CER C1608 JB 1H 472K-T	B	20/50.7
C115	4030007070	S.CER C1608 CH 1H 330J-T	B	11.4/34
C116	4030011540	S.CER C1608 CH 1H 750J-T	B	20.3/32.4
C119	4030007100	S.CER C1608 CH 1H 560J-T	B	14.7/34
C119	4030007110	S.CER C1608 CH 1H 680J-T	B	14.7/34
C120	4030007070	S.CER C1608 CH 1H 330J-T	B	11.4/32.4
C121	4030007070	S.CER C1608 CH 1H 330J-T	B	10.7/37
C122	4030009530	S.CER C1608 CH 1H 030B-T	B	10.6/38.6
C151	4010005540	CER HM60SJ SL 030C 500V		
C152	4030007070	S.CER C1608 CH 1H 330J-T	B	27.6/45
C153	4030007120	S.CER C1608 CH 1H 820J-T	B	29.2/45
C154	4030007070	S.CER C1608 CH 1H 330J-T	T	31.1/44.2
C155	4030007120	S.CER C1608 CH 1H 820J-T	T	33.9/44.2
C156	4030006880	S.CER C1608 JB 1H 472K-T	B	30.8/45</

[CTRL BOARD]

REF NO.	ORDER NO.	DESCRIPTION	M.	H/V LOCATION
C211	4030006880	S.CER C1608 JB 1H 472K-T	B	59.1/67.4
C212	4030006880	S.CER C1608 JB 1H 472K-T	B	60.7/49
C213	4030006880	S.CER C1608 JB 1H 472K-T	B	65.4/56.6
C214	4030007170	S.CER C1608 CH 1H 221J-T	B	56.7/64.1
C215	4030007170	S.CER C1608 CH 1H 221J-T	B	56.7/52.3
C216	4030011340	S.CER C1608 CH 1H 471J-T	B	56/61.9
C217	4030011340	S.CER C1608 CH 1H 471J-T	B	56/54.5
C218	4030006880	S.CER C1608 JB 1H 472K-T	B	65.4/59.7
C221	4030009530	S.CER C1608 CH 1H 030B-T	T	51.2/45.7
C222	4030009910	S.CER C1608 CH 1H 040B-T	T	49.9/45.7
C251	4030011020	S.CER GRM31M4C2H1R0CY21L	B	88.3/32.5
C253	4030006880	S.CER C1608 JB 1H 472K-T	B	76.3/25.9
C254	4030006880	S.CER C1608 JB 1H 472K-T	B	76.3/39.2
C255	4030011090	S.CER GRM31M2C2H7R0DVO1L	B	107.7/49.3
C301	4010005520	CER HM60SJL 010C 500V [USA], [EUR], [UK] [FRA], [ITR], [ESP], [KOR]		
C302	4030007030	S.CER C1608 CH 1H 150J-T	T	82.1/51.7
C303	4030007050	S.CER C1608 CH 1H 220J-T	T	82.1/49.1
C304	4030017810	S.CER C1608 CH 1H 102J-T	B	85.7/55.1
C305	4030017810	S.CER C1608 CH 1H 102J-T	B	86.5/57.7
C307	4030006880	S.CER C1608 JB 1H 472K-T	T	86.5/60.5
C308	4030011600	S.CER C1608 JB 1E 104K-T	B	78.5/55.1
C309	4030011600	S.CER C1608 JB 1E 104K-T	T	78.4/55.1
C310	4030009530	S.CER C1608 CH 1H 030B-T	T	82.1/50.4
C311	4030012600	S.CER C2012 JB 1A 105M-T	T	86.2/55.4
C417	4510008540	S.ELE EEE1CA100SR	T	22.6/77.6
C418	4510008540	S.ELE EEE1CA100SR	T	40.6/85.6
C419	4030011600	S.CER C1608 JB 1E 104K-T	T	19.6/78.7
C420	4030011600	S.CER C1608 JB 1E 104K-T	T	38.4/79.2
C425	4030018790	S.CER C3225 JB 2E 104K-T	B	77.4/12.1
C426	4030018790	S.CER C3225 JB 2E 104K-T	B	60.3/17
C427	4030006880	S.CER C1608 JB 1H 102K-T	B	67.1/7.9
C428	4030006880	S.CER C1608 JB 1H 102K-T	B	50.1/7.9
C429	4030011600	S.CER C1608 JB 1E 104K-T	B	68.9/7.9
C430	4030011600	S.CER C1608 JB 1E 104K-T	B	48.3/7.9
C431	4030006880	S.CER C1608 JB 1H 472K-T	B	70.7/7.9
C432	4030018790	S.CER C3225 JB 2E 104K-T	B	86/12.3
C433	4030018790	S.CER C3225 JB 2E 104K-T	B	82.7/11.7
C434	4030006880	S.CER C1608 JB 1H 472K-T	T	92.7/11.7
C435	4030011600	S.CER C1608 JB 1E 104K-T	B	20.5/80.1
C436	4030011600	S.CER C1608 JB 1E 104K-T	B	19.5/101.6
RL252	6330001460	RLY FTR-F1CA012V		
RL253	6330001460	RLY FTR-F1CA012V		
RL254	6330001770	RLY SIP-1A-12Y		
CP1	6910009670	S.CHK HK3-S-T	T	67.7/100.1
CP101	6910009670	S.CHK HK3-S-T	T	5/83.4
J1	6510023771	S.CNR 52793-2470 (2490)	T	101.8/99.6
J2	6510023761	S.CNR S10B-PH-SM4-TB (LF) (SN)	T	148.3/82.8
J51	6510023771	S.CNR 52793-2470 (2490)	T	43.9/99.6
J52	6510022031	S.CNR B10B-ZR-SM4-TF (LF) (SN)	T	133/2.9
J53	6510021431	S.CNR S8B-ZR-SM4-TF (LF) (SN)	T	134.6/65
J101	6510017920	CNR 1811P342		
J251	6510017920	CNR 1811P342		
J252	6510017920	CNR 1811P342		
J301	6510017920	CNR 1811P342		
J351	6510007020	CNR TMP-J01X-V6		
W1	9029804001	WIR 72/99/040/X98/X98		
EP1	9040902903	TUB IRRAX 0.7 (d) L=22 mm		
EP3	6910014690	S.BEA MPZ1608S221A-T	B	115.7/68.2
EP4	6910014690	S.BEA MPZ1608S221A-T	B	113.5/62.3
EP5	6910014730	S.BEA MPZ2012S331A-T	B	117.9/95.2
EP6	6910014730	S.BEA MPZ2012S331A-T	T	109.7/91.2
EP7	6910014730	S.BEA MPZ2012S331A-T	T	106.7/91.2
EP8	6910014730	S.BEA MPZ2012S331A-T	T	103.8/91.2
EP9	6910014690	S.BEA MPZ1608S221A-T	T	94/91.7
EP10	6910014730	S.BEA MPZ2012S331A-T	T	90.8/90.6
EP12	6910015970	S.BEA MMZ1608B 301CT-AS	B	95.2/63.3
EP13	6910015970	S.BEA MMZ1608B 301CT-AS	T	79.4/63.1
EP14	6910014730	S.BEA MPZ2012S331A-T	B	56.3/95.6
EP15	6910014730	S.BEA MPZ2012S331A-T	B	44.6/97.9
EP16	6910014730	S.BEA MPZ2012S331A-T	T	28.7/95.5
EP401	6910014690	S.BEA MPZ1608S221A-T	B	28.1/100.9
EP402	6910014690	S.BEA MPZ1608S221A-T	B	21.9/100.9

[NETWORK BOARD]

REF NO.	ORDER NO.	DESCRIPTION	M.	H/V LOCATION
Q300	1520000561	S.TR 2SB1123 T-TD-E	T	205.7/10.5
Q301	1590000680	S.TR DTC114EUA T106	T	201.4/9.1
L50	6110003950	COL LA-598		
L60	6110003910	COL LA-593		
L70	6110003050	COL LA-492		
L80	6110003050	COL LA-492		
L90	6110003060	COL LA-493		
L100	6110003070	COL LA-494		
L110	6110003920	COL LA-594		
L120	6140004460	COL LR-504		
L130	6140004470	COL LR-505		
L131	6140004470	COL LR-505		
L300	6180000990	COL LAL 04NA 101K		
R300	7030000420	S.RES MCR10EZHZ 2.2 k	T	202.8/6.9
R301	7030000420	S.RES MCR10EZHZ 2.2 k	T	201.5/11.3
R302	7030000420	S.RES MCR10EZHZ 2.2 k	T	206.2/6.9
R303	7030009800	S.RES ERJ12YJ121U (120)	T	209.7/5
C1	4620000120	VAR UV44 150P		
C2	4620000120	VAR UV44 150P		
C3	4010007580	CER HT20SJ SL 201J 3KV		
C4	4010007580	CER HT20SJ SL 201J 3KV		
C5	4010007580	CER HT20SJ SL 201J 3KV		
C6	4010007580	CER HT20SJ SL 201J 3KV		
C7	4010007580	CER HT20SJ SL 201J 3KV		
C8	4010007580	CER HT20SJ SL 201J 3KV		
C9	4010007580	CER HT20SJ SL 201J 3KV		
C10	4010007580	CER HT20SJ SL 201J 3KV		
C18	4030006880	S.CER C1608 JB 1H 472K-T	T	92.6/102.4
C19	4030006880	S.CER C1608 JB 1H 472K-T	T	95.2/1.3
C20	4010007570	CER HT15SJ SL 151J 3KV		
C21	4010007570	CER HT15SJ SL 151J 3KV		
C22	4010007570	CER HT15SJ SL 151J 3KV		
C23	4010007570	CER HT15SJ SL 151J 3KV		
C24	4010007570	CER HT15SJ SL 151J 3KV		
C25	4010007570	CER HT15SJ SL 151J 3KV		
C26	4010007570	CER HT15SJ SL 151J 3KV		
C27	4010007570	CER HT15SJ SL 151J 3KV		
C28	4030006880	S.CER C1608 JB 1H 472K-T	T	84.3/102.4
C29	4030006880	S.CER C1608 JB 1H 472K-T	T	85.3/1.3
C30	4010007550	CER HT11SJ SL 820J 3KV		
C31	4010007550	CER HT11SJ SL 820J 3KV		
C32	4010007550	CER HT11SJ SL 820J 3KV		
C33	4010007550	CER HT11SJ SL 820J 3KV		
C34	4010007550	CER HT11SJ SL 820J 3KV		
C35	4010007550	CER HT11SJ SL 820J 3KV		
C36	4010007550	CER HT11SJ SL 820J 3KV		
C37	4010007550	CER HT11SJ SL 820J 3KV		
C38	4030006880	S.CER C1608 JB 1H 472K-T	T	65.7/102.4
C39	4030006880	S.CER C1608 JB 1H 472K-T	T	71.8/1.3
C40	4010008550	CER DEA1X3F390JC3B		
C41	4010008550	CER DEA1X3F390JC3B		
C42	4010008550	CER DEA1X3F390JC3B		
C43	4010008550	CER DEA1X3F390JC3B		
C44	4010008550	CER DEA1X3F390JC3B		
C45	4010008550	CER DEA1X3F390JC3B		
C46	4010008550	CER DEA1X3F390JC3B		
C47	4010008550	CER DEA1X3F390JC3B		
C48	4030006880	S.CER C1608 JB 1H 472K-T	T	106.1/102.4
C49	4030006880	S.CER C1608 JB 1H 472K-T	T	112.1/1.3
C50	4030006880	S.CER C1608 JB 1H 472K-T	T	140.7/12
C60	4030006880	S.CER C1608 JB 1H 472K-T	T	154.1/12
C70	4030006880	S.CER C1608 JB 1H 472K-T	T	167.5/16.1
C80	4030006880	S.CER C1608 JB 1H 472K-T	T	181.9/21.5
C90	4030006880	S.CER C1608 JB 1H 472K-T	T	195.3/21.3
C100	4030006880	S.CER C1608 JB 1H 472K-T	T	204.4/20.7
C110	4030006880	S.CER C1608 JB 1H 472K-T	T	205.8/20.7
C120	4030006880	S.CER C1608 JB 1H 472K-T	T	207.2/20.6
C211	4030006880	S.CER C1608 JB 1H 472K-T	T	196.2/16.4
C212	4030006880	S.CER C1608 JB 1H 472K-T	T	194.1/19.6
C213	4030006880	S.CER C1608 JB 1H 472K-T	T	192.1/19.6
C214	4030006880	S.CER C1608 JB 1H 472K-T	T	190.7/19.6
C301	4030006880	S.CER C1608 JB 1H 472K-T	T	210.5/10.1
C303	4030006880	S.CER C1608 JB 1H 472K-T	T	199.3/9
RL10	6330001200	RLY VS-12MBU-UC		
RL11	6330001200	RLY VS-12MBU-UC		
RL20	6330001200	RLY VS-12MBU-UC		
RL21	6330001200	RLY VS-12MBU-UC		
RL30	6330001200	RLY VS-12MBU-UC		
RL31	6330001200	RLY VS-12MBU-UC		
RL40	6330001200	RLY VS-12MBU-UC		
RL41	6330001200	RLY VS-12MBU-UC		
RL50	6330001460	RLY FTR-F1CA012V		
RL60	6330001200	RLY VS-12MBU-UC		
RL70	6330001200	RLY VS-12MBU-UC		
RL80	6330001200	RLY VS-12MBU-UC		
RL90	6330001200	RLY VS-12MBU-UC		
RL100	6330001200	RLY VS-12MBU-UC		
RL110	6330001200	RLY VS-12MBU-UC		
RL120	6330001200	RLY VS-12MBU-UC		
J1	6510021561	S.CNR 52808-2470 (2490)	T	184.9/7.4
J2	6510017930	CNR 1771P145-20		
J3	6510017930	CNR 1771P145-20		
J4	6510003521	CNR S04B-EH-S (LF) (SN)		

M.=Mounted side (T: Mounted on the Top side B: Mounted on the Bottom side) S.=Surface mount

[NETWORK BOARD]

REF NO.	ORDER NO.	DESCRIPTION	M.	H/V LOCATION
EP2	6910014730	S.BEA MPZ2012S331A-T	T	198.2/3.3
EP3	6910014730	S.BEA MPZ2012S331A-T	T	183.9/2.7
EP4	6910014730	S.BEA MPZ2012S331A-T	T	170.7/4
EP202	6910015970	S.BEA MMZ1608B 301CT-AS	T	187.4/11.9
EP203	6910015970	S.BEA MMZ1608B 301CT-AS	T	188.4/14.6
EP204	6910015970	S.BEA MMZ1608B 301CT-AS	T	189.4/11.9
EP205	6910015970	S.BEA MMZ1608B 301CT-AS	T	190.4/14.6
EP206	6910015970	S.BEA MMZ1608B 301CT-AS	T	191.4/11.9
EP207	6910015970	S.BEA MMZ1608B 301CT-AS	T	192.4/14.6
EP208	6910015970	S.BEA MMZ1608B 301CT-AS	T	193.4/11.9
EP209	6910015970	S.BEA MMZ1608B 301CT-AS	T	194.4/14.6
EP252	6910015970	S.BEA MMZ1608B 301CT-AS	T	175.4/11.8
EP253	6910015970	S.BEA MMZ1608B 301CT-AS	T	176.4/14.2
EP254	6910015970	S.BEA MMZ1608B 301CT-AS	T	177.4/11.8
EP255	6910015970	S.BEA MMZ1608B 301CT-AS	T	178.4/14.2
EP256	6910015970	S.BEA MMZ1608B 301CT-AS	T	179.4/11.8
EP257	6910015970	S.BEA MMZ1608B 301CT-AS	T	180.4/14.2
EP258	6910015970	S.BEA MMZ1608B 301CT-AS	T	181.4/11.8
EP259	6910015970	S.BEA MMZ1608B 301CT-AS	T	182.4/14.2
EP300	6910015970	S.BEA MMZ1608B 301CT-AS	T	185/11.8

[ANT-SW BOARD]

REF NO.	ORDER NO.	DESCRIPTION	M.	H/V LOCATION
IC11	1130011510	S.IC BU2099FV-E2	T	160.6/33.6
IC12	1180002391	S.REG S-812C33AMC-C2N-G	T	152.4/28.7
Q11	1590001001	S.TR RN2427 (TE85L,F)	T	156.9/38.6
Q12	1590001001	S.TR RN2427 (TE85L,F)	T	152.3/36.9
Q13	1590001001	S.TR RN2427 (TE85L,F)	T	164.7/38.5
Q14	1590001001	S.TR RN2427 (TE85L,F)	T	164.7/17.5
D51	1750000550	S.DIO 1SS355 TE-17	T	161.9/13.3
D61	1750000550	S.DIO 1SS355 TE-17	T	118.9/19.7
D71	1750000550	S.DIO 1SS355 TE-17	T	68.7/21.4
D81	1750000550	S.DIO 1SS355 TE-17	T	36.9/19.7
D83	1750000550	S.DIO 1SS355 TE-17	T	28.2/45.3
D84	1750000550	S.DIO 1SS355 TE-17	T	25.8/43
L2	6110001670	COL LA-253		
R3	7540000130	ABS 2P-50A-301		
R11	7030003320	S.RES ERJ3GEYJ 101 V (100)	T	165.5/27.4
R12	7030003320	S.RES ERJ3GEYJ 101 V (100)	T	164.2/27.4
R13	7030003320	S.RES ERJ3GEYJ 101 V (100)	T	162.9/27.4
R14	7030003320	S.RES ERJ3GEYJ 101 V (100)	T	166.2/33.9
R15	7030003320	S.RES ERJ3GEYJ 101 V (100)	T	153.9/32.6
R17	7030003320	S.RES ERJ3GEYJ 101 V (100)	T	154.7/39.4
R18	7030003320	S.RES ERJ3GEYJ 101 V (100)	T	153.9/34
R20	7030003320	S.RES ERJ3GEYJ 101 V (100)	T	152.1/39.1
R21	7030003320	S.RES ERJ3GEYJ 101 V (100)	T	154.7/36.6
R23	7030003320	S.RES ERJ3GEYJ 101 V (100)	T	162.3/39.1
R24	7030003320	S.RES ERJ3GEYJ 101 V (100)	T	161/39.1
R26	7030003320	S.RES ERJ3GEYJ 101 V (100)	T	162.7/15.6
C1	4010005610	CER HM60SJ SL 100D 500V		
C2	4010005660	CER HM60SJ SL 220J 500V		
C11	4030011600	S.CER C1608 JB 1E 104K-T	T	160.7/29.4
C12	4030011600	S.CER C1608 JB 1E 104K-T	T	154.9/27.9
C51	4030006880	S.CER C1608 JB 1H 472K-T	T	163.5/13.6
C61	4030006880	S.CER C1608 JB 1H 472K-T	T	119.2/21.3
C71	4030006880	S.CER C1608 JB 1H 472K-T	T	69/19.9
C81	4030006880	S.CER C1608 JB 1H 472K-T	T	37.2/21.3
C83	4030006880	S.CER C1608 JB 1H 472K-T	T	26.6/45.6
C84	4030006880	S.CER C1608 JB 1H 472K-T	T	25/45.6
RL51	6330001460	RLY FTR-F1CA012V		
RL61	6330001460	RLY FTR-F1CA012V		
RL71	6330001460	RLY FTR-F1CA012V		
RL81	6330001460	RLY FTR-F1CA012V		
RL83	6330001780	RLY FTR-MYAA012D		
RL84	6330001780	RLY FTR-MYAA012D		
J1	6510017930	CNR 1771P145-20		
J3	6510007020	CNR TMP-J01X-V6		
J4	6510019971	S.CNR 52808-1071	T	153/22
J51	6510000410	CNR MR-DS-E 02		
J61	6510000410	CNR MR-DS-E 02		
J71	6510000410	CNR MR-DS-E 02		
J81	6510000410	CNR MR-DS-E 02		
EP2	6910014730	S.BEA MPZ2012S331A-T	T	151.5/26.1

[OSC UNIT]

REF NO.	ORDER NO.	DESCRIPTION	M.	H/V LOCATION
IC10	1180002610	S.REG BA12FP-E2	T	59.9/37.5
IC1091	1190002001	S.IC AD5260BRUZ50	T	26.8/12
IC1092	1130005721	S.IC TC7W04F (TE12L,F)	T	23.7/6.1
Q1010	1590000680	S.TR DTC114EUA T106	T	30.7/17.9
Q1011	1590000680	S.TR DTC114EUA T106	T	24.9/36.4
Q1012	1590000680	S.TR DTC114EUA T106	T	44.4/32.8
Q1013	1590000680	S.TR DTC114EUA T106	T	41.8/32.8
Q1021	1530002060	S.TR 2SC4081 T106 R	T	11.3/6.3
Q1022	1530002601	S.TR 2SC4215-O (TE85R,F)	T	10.4/17.8
Q1023	1590000680	S.TR DTC114EUA T106	T	13.1/11
Q1042	1530002601	S.TR 2SC4215-O (TE85R,F)	T	18.8/18.0
Q1043	1590000680	S.TR DTC114EUA T106	T	19.7/11.7
Q1061	1530002060	S.TR 2SC4081 T106 R	T	29.8/29.6
Q1062	1530002060	S.TR 2SC4081 T106 R	T	24/32
Q1070	1530002060	S.TR 2SC4081 T106 R	T	18.3/41.3
Q1101	1530002700	S.TR 2SC4097 T106Q	T	66.1/17.8
D1010	1790001250	S.DIO MA2S111-(TX)	T	30.5/16
D1011	1790001250	S.DIO MA2S111-(TX)	T	21.7/37.4
D1071	1750000381	S.DIO 1SS312 (TE85L,F)	T	32.4/27
D1072	1750000381	S.DIO 1SS312 (TE85L,F)	T	32.7/30.4
X10	6050012210	XTL CR-772.OCVXO-148A		
L1020	6200005491	S.COL NLV32T-331J	T	14.7/1.9
L1021	6200003261	S.COL NLV32T-101J	T	7.7/10.9
L1022	6200003261	S.COL NLV32T-101J	T	6.2/16
L1023	6200003051	S.COL NLV32T-R82J	T	6.9/20.3
L1024	6200003051	S.COL NLV32T-R82J	T	6.2/23.8
L1041	6200003261	S.COL NLV32T-101J	T	15.3/13.7
L1042	6200003261	S.COL NLV32T-101J	T	14.7/17.2
L1043	6200003051	S.COL NLV32T-R82J	T	15.3/22.4
L1044	6200003051	S.COL NLV32T-R82J	T	18.8/24.2
L1061	6150004170	COL LS-476		
L1062	6150004170	COL LS-476		
R1011	7030003200	S.RES ERJ3GEYJ 100 V (10)	T	32.7/17
R1012	7030003200	S.RES ERJ3GEYJ 100 V (10)	T	23.8/38.4
R1013	7030003440	S.RES ERJ3GEYJ 102 V (1)	T	16.9/11.6
R1020	7030003240	S.RES ERJ3GEYJ 220 V (22 k)	T	11.3/1.8
R1021	7030003560	S.RES ERJ3GEYJ 103 V (10 k)	T	11.1/4.4
R1022	7030003370	S.RES ERJ3GEYJ 271 V (270)	T	15.5/7.9
R1023	7030004040	S.RES ERJ3GEYJ 4R7 V (4.7)	T	11.4/14
R1024	7030003370	S.RES ERJ3GEYJ 271 V (270)	T	12.3/17.7
R1025	7030003500	S.RES ERJ3GEYJ 332 V (3.3 k)	T	10.1/14.2
R1026	7030003480	S.RES ERJ3GEYJ 222 V (2.2 k)	T	13/9.1
R1027	7030003360	S.RES ERJ3GEYJ 221 V (220)	T	8.8/14.3
R1028	7030003440	S.RES ERJ3GEYJ 102 V (1 k)	T	10.2/11.9
R1043	7030003240	S.RES ERJ3GEYJ 220 V (22)	T	19.7/14.2
R1044	7030003370	S.RES ERJ3GEYJ 271 V (270)	T	20.7/18.6
R1045	7030003500	S.RES ERJ3GEYJ 332 V (3.3 k)	T	17.9/15.1
R1046	7030003480	S.RES ERJ3GEYJ 222 V (2.2 k)	T	19.5/9.8
R1047	7030003290	S.RES ERJ3GEYJ 560 V (56)	T	16.8/17.9
R1061	7030003240	S.RES ERJ3GEYJ 220 V (22)	T	27.8/28.4
R1062	7030003560	S.RES ERJ3GEYJ 103 V (10 k)	T	29.6/27.7
R1063	7030003380	S.RES ERJ3GEYJ 331 V (330)	T	29.9/31.5
R1064	7030003280	S.RES ERJ3GEYJ 470 V (47)	T	25.2/34
R1065	7030003400	S.RES ERJ3GEYJ 471 V (470)	T	24.3/27.5
R1067	7030003560	S.RES ERJ3GEYJ 103 V (10 k)	T	24.3/30.1
R1068	7030003550	S.RES ERJ3GEYJ 822 V (8.2 k)	T	26/32.2
R1071	7030003340	S.RES ERJ3GEYJ 151 V (150)	T	32.9/33.7
R1072	7030003270	S.RES ERJ3GEYJ 390 V (39)	T	34.8/32.8
R1073	7030003340	S.RES ERJ3GEYJ 151 V (150)	T	32.9/32.4
R1074	7030003320	S.RES ERJ3GEYJ 101 V (100)	T	24.2/41
R1075	7030003280	S.RES ERJ3GEYJ 470 V (47)	T	26.2/41.8
R1077	7030003320	S.RES ERJ3GEYJ 101 V (100)	T	11.8/41.7
R1078	7030003480	S.RES ERJ3GEYJ 222 V (2.2 k)	T	16.4/41.2
R1079	7030003590	S.RES ERJ3GEYJ 183 V (18 k)	T	15.1/41.2
R1080	7030003360	S.RES ERJ3GEYJ 221 V (220)	T	21.6/41
R1091	7030006091	S.RES ERA3YED 822V (8.2 k)	T	19.4/7.2
R1092	7030005341	S.RES ERA3YED 332V (3.3 k)	T	19.5/8.5
R1093	7030003560	S.RES ERJ3GEYJ 103 V (10 k)	T	25.6/1.4
R1094	7030003540	S.RES ERJ3GEYJ 682 V (6.8 k)	T	25.6/2.7
R1095	7030003320	S.RES ERJ3GEYJ 101 V (100)	T	22.4/16.7
R1096	7030003440	S.RES ERJ3GEYJ 102 V (1 k)	T	32/13.6
R1097	7030003440	S.RES ERJ3GEYJ 102 V (1 k)	T	32/12.1
R1098	7030003640	S.RES ERJ3GEYJ 473 V (47 k)	T	27.4/16
R1099	7030003480	S.RES ERJ3GEYJ 222 V (2.2 k)	T	22.4/10.1
R1100	7030003640	S.RES ERJ3GEYJ 473 V (47 k)	T	27.2/6.4
R1101	7030003360	S.RES ERJ3GEYJ 221 V (220)	T	66/15.9
R1102	7030005981	S.RES ERA3YED 333V (33 k)	T	32/8.8
R2016	7030003440	S.RES ERJ3GEYJ 102 V (1 k)	T	48.5/36.1
R2017	7030003440	S.RES ERJ3GEYJ 102 V (1 k)	T	45.1/35.7
R2018	7030003440	S.RES ERJ3GEYJ 102 V (1 k)	T	42.5/35.7
C1004	4030006880	S.CER C1608 JB 1H 472K-T	T	29.9/8.4
C1005	4550007670	S.TAN F931C105MAABMA	T	29.2/3.2
C1006	4030006880	S.CER C1608 JB 1H 472K-T	T	33/4
C1007	4550007670	S.TAN F931C105MAABMA	T	31.3/3.2
C1008	4030011600	S.CER C1608 JB 1E 104K-T	T	17.3/2.1
C1010	4510008680	S.ELE EEE1EA220SP	T	52.8/35.2
C1011	4030011600	S.CER C1608 JB 1E 104K-T	T	58.3/32
C1012	4030011600	S.CER C1608 JB 1E 104K-T	T	65.1/34.7
C1013	4030006880	S.CER C1608 JB 1H 472K-T	T	63.8/34.7
C1014	4510008680	S.ELE EEE1EA220SP	T	69/31.2
C1015	4030006880	S.CER C1608 JB 1H 472K-T	T	60.9/32
C1016	4030011600	S.CER C1608 JB 1E 104K-T	T	28.7/16

M.=Mounted side (T: Mounted on the Top side B: Mounted on the Bottom side) S.=Surface mount

[OSC UNIT]

REF NO.	ORDER NO.	DESCRIPTION	M.	H/V LOCATION
C1017	4030011600	S.CER C1608 JB 1E 104K-T	T	21.7/34.8
C1018	4030011600	S.CER C1608 JB 1E 104K-T	T	23/36.6
C1019	4030011600	S.CER C1608 JB 1E 104K-T	T	32.3/14.9
C1020	4030011600	S.CER C1608 JB 1E 104K-T	T	13.3/5.2
C1021	4030011600	S.CER C1608 JB 1E 104K-T	T	11.3/3.1
C1022	4030011600	S.CER C1608 JB 1E 104K-T	T	15.1/11
C1023	4030011600	S.CER C1608 JB 1E 104K-T	T	11.9/15.8
C1024	4030011600	S.CER C1608 JB 1E 104K-T	T	12.7/14
C1025	4030011600	S.CER C1608 JB 1E 104K-T	T	10.2/19.8
C1026	4030011330	S.CER C1608 CH 1H 391J-T	T	10.2/21.1
C1027	4030007050	S.CER C1608 CH 1H 220J-T	T	7.7/18.2
C1028	4030017800	S.CER C1608 CH 1H 561J-T	T	8.9/22.5
C1030	4030007110	S.CER C1608 CH 1H 680J-T	T	8.4/24.5
C1031	4030010760	S.CER C1608 CH 1H 331J-T	T	10.2/25.1
C1032	4030011600	S.CER C1608 JB 1E 104K-T	T	11.1/9.1
C1033	4030011600	S.CER C1608 JB 1E 104K-T	T	9.8/10.1
C1042	4030011600	S.CER C1608 JB 1E 104K-T	T	22/12.7
C1043	4030011600	S.CER C1608 JB 1E 104K-T	T	20.1/16.8
C1044	4030011600	S.CER C1608 JB 1E 104K-T	T	19.9/15.5
C1045	4030011600	S.CER C1608 JB 1E 104K-T	T	13.2/20.6
C1046	4030011330	S.CER C1608 CH 1H 391J-T	T	15/19.8
C1047	4030007050	S.CER C1608 CH 1H 220J-T	T	13.2/23.2
C1048	4030017800	S.CER C1608 CH 1H 561J-T	T	17.5/21.5
C1050	4030007110	S.CER C1608 CH 1H 680J-T	T	20.6/22.1
C1051	4030010760	S.CER C1608 CH 1H 331J-T	T	21.7/24.4
C1052	4030011600	S.CER C1608 JB 1E 104K-T	T	17.7/8.8
C1053	4030011600	S.CER C1608 JB 1E 104K-T	T	16.4/9.7
C1062	4030011600	S.CER C1608 JB 1E 104K-T	T	27/30.3
C1063	4030011600	S.CER C1608 JB 1E 104K-T	T	29.9/32.8
C1064	4030011600	S.CER C1608 JB 1E 104K-T	T	24.3/28.8
C1066	4030007010	S.CER C1608 CH 1H 100D-T	T	12.8/25.1
C1067	4030011600	S.CER C1608 JB 1E 104K-T	T	26.5/28.4
C1069	4030006880	S.CER C1608 JB 1H 472K-T	T	66/21
C1070	4030006880	S.CER C1608 JB 1H 472K-T	T	66/22.3
C1071	4030006880	S.CER C1608 JB 1H 472K-T	T	36.6/32.8
C1072	4030006880	S.CER C1608 JB 1H 472K-T	T	28.8/41.8
C1073	4030006880	S.CER C1608 JB 1H 472K-T	T	13.8/41.2
C1074	4030006880	S.CER C1608 JB 1H 472K-T	T	20.2/41.1
C1075	4030006880	S.CER C1608 JB 1H 472K-T	T	22.9/41
C1077	4030011600	S.CER C1608 JB 1E 104K-T	T	11.8/40.4
C1091	4030006880	S.CER C1608 JB 1H 472K-T	T	25.6/15.5
C1092	4030006880	S.CER C1608 JB 1H 472K-T	T	18.9/5.3
C1093	4030006880	S.CER C1608 JB 1H 472K-T	T	22.1/2.7
C1094	4030006880	S.CER C1608 JB 1H 472K-T	T	27.9/8.6
C1101	4550006480	S.TAN TEESVA 1C 475M8R	T	65.4/12.7
C2016	4030006880	S.CER C1608 JB 1H 472K-T	T	43.8/35.7
C2017	4030006880	S.CER C1608 JB 1H 472K-T	T	41.2/35.7
C6110	4030011600	S.CER C1608 JB 1E 104K-T	T	28.7/26.1
RL1010	6330001860	R.LY UA2-12NU		
RL1011	6330001860	R.LY UA2-12NU		
J1071	6510007020	C.NR TMP-J01X-V6		
J1072	6510007020	C.NR TMP-J01X-V6		
J2016	6510020091	S.C.NR 52808-0871 (0890)	T	44.4/40.4
J2017	6510003401	C.NR B04B-EH-S (LF) (SN)		
EP1010	6910012350	S.BEA MMZ1608Y 102BT	T	63.5/32
EP1069	6910014690	S.BEA MPZ1608S221A-T	T	66/19.7
EP1070	6910014690	S.BEA MPZ1608S221A-T	T	66/23.6
EP1091	6910012350	S.BEA MMZ1608Y 102BT	T	20.2/5.3
EP1092	6910012350	S.BEA MMZ1608Y 102BT	T	25.6/16.8

[DIGISEL UNIT]

REF NO.	ORDER NO.	DESCRIPTION	M.	H/V LOCATION
IC1	1130011141	S.IC CAT24WC256X-1.8-T13		
		[USA], [EUR], [UK]	B	98/31.1
	1130014370	S.IC CAT24C256XI-T2		
		[FRA], [ITR], [ESP], [KOR]	B	98/31.1
IC4	1130011510	S.IC BU2099FV-E2	T	86/38.6
IC5	1130011510	S.IC BU2099FV-E2	T	85.9/30.3
Q201	1530003851	S.TR 2SC5551F-TD-E	T	72.2/60.4
D21	1750000550	S.DIO 1SS355 TE-17	B	79.5/8.5
D51	1750000550	S.DIO 1SS355 TE-17	B	60.2/48.3
D52	1750000550	S.DIO 1SS355 TE-17	B	69.4/51.8
D53	1750000550	S.DIO 1SS355 TE-17	B	47.8/48.3
D54	1750000550	S.DIO 1SS355 TE-17	B	54.7/40
D55	1750000550	S.DIO 1SS355 TE-17	T	32.6/42.1
D56	1750000550	S.DIO 1SS355 TE-17	B	78.1/38.1
D57	1750000550	S.DIO 1SS355 TE-17	B	54.7/36.2
D58	1750000550	S.DIO 1SS355 TE-17	B	53.4/18.4
D59	1750000550	S.DIO 1SS355 TE-17	B	53.1/25.3
D60	1750000550	S.DIO 1SS355 TE-17	B	51/25.3
D61	1750000550	S.DIO 1SS355 TE-17	B	50.7/18.5
D62	1750000550	S.DIO 1SS355 TE-17	B	77.9/12
D63	1750000550	S.DIO 1SS355 TE-17	B	77.9/25.3
D64	1750000550	S.DIO 1SS355 TE-17	B	28/27.7
D65	1750000550	S.DIO 1SS355 TE-17	B	28/20.7
D66	1750000550	S.DIO 1SS355 TE-17	B	77.9/18.6
D67	1750000550	S.DIO 1SS355 TE-17	T	51.7/13.6
D68	1750000550	S.DIO 1SS355 TE-17	B	28/13.7
D69	1750000550	S.DIO 1SS355 TE-17	B	24.6/64.7
D70	1750000550	S.DIO 1SS355 TE-17	B	25.3/41.8
D71	1750000550	S.DIO 1SS355 TE-17	B	19/41.8
D72	1750000550	S.DIO 1SS355 TE-17	B	28.1/40.3
D73	1750000550	S.DIO 1SS355 TE-17	B	21.8/40.2
D74	1750000550	S.DIO 1SS355 TE-17	B	24.5/11.7
D75	1750000550	S.DIO 1SS355 TE-17	B	21/28.7
D201	1710001240	DIO L204BBB		
D202	1710001240	DIO L204BBB		
D203	1750000550	S.DIO 1SS355 TE-17	T	42.6/62.4
D204	1750000550	S.DIO 1SS355 TE-17	T	42.6/60.7
D205	1750000550	S.DIO 1SS355 TE-17	B	77.5/46.3
L1	6200003261	S.COL NLV32T-101J	T	94/37.4
L2	6180000990	COL LAL 04NA 101K		
L3	6200003261	S.COL NLV32T-101J	T	94/29.9
L4	6200003261	S.COL NLV32T-101J	T	94/32.9
L101	6140003980	COL LR-476		
L102	6140003990	COL LR-477		
L103	6140004001	COL LR-478A		
L104	6140004010	COL LR-479		
L105	6140004020	COL LR-480		
L106	6140004030	COL LR-481		
L107	6110003930	COL LA-595		
L201	6180000920	COL LAL 03NA 221K		
L203	6140003940	COL LR-493		
R1	7030003680	S.RES ERJ3GEYJ 104 V (100 k)	T	92.3/14.1
R2	7030003680	S.RES ERJ3GEYJ 103 V (10 k)	B	96.6/24.1
R3	7030003680	S.RES ERJ3GEYJ 103 V (10 k)	B	96.6/22.5
R4	7030003440	S.RES ERJ3GEYJ 102 V (1 k)	T	93.2/25.1
R5	7030003440	S.RES ERJ3GEYJ 102 V (1 k)	T	93.2/26.4
R6	7030003440	S.RES ERJ3GEYJ 102 V (1 k)	T	93.2/27.7
R7	7030003440	S.RES ERJ3GEYJ 102 V (1 k)	B	99/24.9
R8	7030003440	S.RES ERJ3GEYJ 102 V (1 k)	B	100.6/24.9
R9	7030003360	S.RES ERJ3GEYJ 221 V (220)	B	82.3/7.6
R10	7030003360	S.RES ERJ3GEYJ 221 V (220)	B	86.7/46.3
R35	7030003360	S.RES ERJ3GEYJ 221 V (220)	B	84.3/39.2
R36	7030003360	S.RES ERJ3GEYJ 221 V (220)	B	83.5/42.6
R37	7030003360	S.RES ERJ3GEYJ 221 V (220)	B	83.5/41
R38	7030003360	S.RES ERJ3GEYJ 221 V (220)	B	86.6/41
R39	7030003360	S.RES ERJ3GEYJ 221 V (220)	B	86.6/42.6
R40	7030003360	S.RES ERJ3GEYJ 221 V (220)	T	80.1/42.6
R41	7030003360	S.RES ERJ3GEYJ 221 V (220)	T	79.9/39.6
R42	7030003360	S.RES ERJ3GEYJ 221 V (220)	T	79.9/38.4
R43	7030003360	S.RES ERJ3GEYJ 221 V (220)	T	79.9/37.2
R44	7030003360	S.RES ERJ3GEYJ 221 V (220)	T	80.2/35.6
R45	7030003360	S.RES ERJ3GEYJ 221 V (220)	T	80.2/34.3
R46	7030003360	S.RES ERJ3GEYJ 221 V (220)	T	79.5/40.8
R47	7030003360	S.RES ERJ3GEYJ 221 V (220)	T	78.7/25.8
R48	7030003360	S.RES ERJ3GEYJ 221 V (220)	T	79.4/23.2
R49	7030003360	S.RES ERJ3GEYJ 221 V (220)	T	80.1/26.2
R50	7030003360	S.RES ERJ3GEYJ 221 V (220)	T	80.8/23.6
R51	7030003360	S.RES ERJ3GEYJ 221 V (220)	T	81.5/26.5
R52	7030003360	S.RES ERJ3GEYJ 221 V (220)	T	86.8/25.4
R53	7030003360	S.RES ERJ3GEYJ 221 V (220)	T	86.1/22.8
R54	7030003360	S.RES ERJ3GEYJ 221 V (220)	T	85.4/25.4
R55	7030003360	S.RES ERJ3GEYJ 221 V (220)	T	84.7/22.8
R56	7030003360	S.RES ERJ3GEYJ 221 V (220)	T	84/25.4
R57	7030003360	S.RES ERJ3GEYJ 221 V (220)	T	83.3/22.8
R58	7030003360	S.RES ERJ3GEYJ 221 V (220)	T	88.4/25.4
R59	7030003440	S.RES ERJ3GEYJ 102 V (1 k)	T	93.2/23.8
R100	7030000010	S.RES MCR10EZJH JPW (000)	B	96.1/38
R104	7030003560	S.RES ERJ3GEYJ 103 V (10 k)	B	24.4/34.3
R105	7030003560	S.RES ERJ3GEYJ 103 V (10 k)	B	17.7/34
R201	7030000380	S.RES MCR10EZJH 1 k	T	57.6/62.7
R202	7030000290	S.RES MCR10EZJH 180 (181)	T	57.6/59.2
R203	7030000220	S.RES MCR10EZJH 47 (470)	T	57.6/60.9
R204	7030003360	S.RES ERJ3GEYJ 221 V (220)	B	80.6/45.3
R205	7030003350	S.RES ERJ3GEYJ 181 V (180)	T	47.3/60.7
R206	7030003370	S.RES ERJ3GEYJ 271 V (270)	T	45/61.4
R207	7030003560	S.RES ERJ3GEYJ 103 V (10 k)	T	48.1/62.7

M.=Mounted side (T: Mounted on the Top side B: Mounted on the Bottom side) S.=Surface mount

[DIGISEL UNIT]

REF NO.	ORDER NO.	DESCRIPTION	M.	H/V LOCATION
R208	703000200	S.RES MCR10EZHZ 33 (330)	T	79.8/60
R209	7030003240	S.RES ERJ3GEYJ 220 V (22)	T	76.8/59.7
R210	7030003370	S.RES ERJ3GEYJ 271 V (270)	T	71.5/56.6
R211	7030003370	S.RES ERJ3GEYJ 271 V (270)	T	72.7/56.5
R213	7030000220	S.RES MCR10EZHZ 47 (470)	T	64.6/56
R214	7030003460	S.RES ERJ3GEYJ 152 V (1.5 k)	T	60.2/59.3
R215	7030003460	S.RES ERJ3GEYJ 152 V (1.5 k)	T	73.3/53.9
R216	7030003680	S.RES ERJ3GEYJ 104 V (100 k)	T	92.6/52.8
C1	4030011600	S.CER C1608 JB 1E 104K-T	B	96.6/25.7
C4	4030011600	S.CER C1608 JB 1E 104K-T	T	87.7/34.4
C5	4030011600	S.CER C1608 JB 1E 104K-T	T	84.4/34.4
C21	4030006880	S.CER C1608 JB 1H 472K-T	B	79.6/6.8
C35	4030006880	S.CER C1608 JB 1H 472K-T	B	83.5/46.3
C51	4030006880	S.CER C1608 JB 1H 472K-T	T	60.5/47.6
C52	4030006880	S.CER C1608 JB 1H 472K-T	T	72.9/47.5
C53	4030006880	S.CER C1608 JB 1H 472K-T	T	48.1/47.6
C54	4030006880	S.CER C1608 JB 1H 472K-T	T	54.7/39.7
C55	4030006880	S.CER C1608 JB 1H 472K-T	T	32.6/43.7
C56	4030006880	S.CER C1608 JB 1H 472K-T	B	80/38.1
C57	4030006880	S.CER C1608 JB 1H 472K-T	T	54.7/36.5
C58	4030006880	S.CER C1608 JB 1H 472K-T	T	51.9/20.1
C59	4030006880	S.CER C1608 JB 1H 472K-T	T	52/27.2
C60	4030006880	S.CER C1608 JB 1H 472K-T	T	52/23.8
C61	4030006880	S.CER C1608 JB 1H 472K-T	T	52/16.8
C62	4030006880	S.CER C1608 JB 1H 472K-T	B	76.3/11.9
C63	4030006880	S.CER C1608 JB 1H 472K-T	B	76.2/25.3
C64	4030006880	S.CER C1608 JB 1H 472K-T	B	28/24.2
C65	4030006880	S.CER C1608 JB 1H 472K-T	B	28/17.2
C66	4030006880	S.CER C1608 JB 1H 472K-T	B	76.2/18.5
C67	4030006880	S.CER C1608 JB 1H 472K-T	T	53.3/13.9
C68	4030006880	S.CER C1608 JB 1H 472K-T	B	28/10.2
C69	4030006880	S.CER C1608 JB 1H 472K-T	B	20.9/64.7
C70	4030006880	S.CER C1608 JB 1H 472K-T	B	28.4/42.1
C71	4030006880	S.CER C1608 JB 1H 472K-T	B	18.6/39.9
C72	4030006880	S.CER C1608 JB 1H 472K-T	B	24.9/39.9
C73	4030006880	S.CER C1608 JB 1H 472K-T	B	22.1/42
C74	4030006880	S.CER C1608 JB 1H 472K-T	B	24.5/8.2
C75	4030006880	S.CER C1608 JB 1H 472K-T	B	16.9/25.5
C101	4030011340	S.CER C1608 CH 1H 471J-T	B	50.5/52.4
C102	4030011280	S.CER C1608 CH 1H 271J-T	B	38.1/52.4
C103	4030011280	S.CER C1608 CH 1H 271J-T	B	40.3/52.4
C104	4030007130	S.CER C1608 CH 1H 101J-T	B	65.1/52.4
C105	4030006940	S.CER C1608 CH 1H 030C-T	B	65.1/44
C106	4030007150	S.CER C1608 CH 1H 151J-T	B	40.4/44
C107	4030007150	S.CER C1608 CH 1H 151J-T	B	50.5/44
C108	4030007150	S.CER C1608 CH 1H 151J-T	B	52.3/44
C109	4030007150	S.CER C1608 CH 1H 151J-T	B	37.2/44
C110	4030009520	S.CER C1608 CH 1H 020B-T	B	62.5/34
C111	4030009550	S.CER C1608 CH 1H 2R5B-T	B	64.3/34
C113	4030007000	S.CER C1608 CH 1H 090D-T	B	40.3/34
C114	4030007040	S.CER C1608 CH 1H 180J-T	B	70.9/34
C115	4030007040	S.CER C1608 CH 1H 180J-T	B	46.9/34
C116	4030007040	S.CER C1608 CH 1H 180J-T	B	48.7/34
C117	4030007070	S.CER C1608 CH 1H 330J-T	B	65.9/31
C118	4030007090	S.CER C1608 CH 1H 470J-T	B	66.9/42.4
C119	4030007040	S.CER C1608 CH 1H 180J-T	B	45.1/42.4
C120	4030007040	S.CER C1608 CH 1H 180J-T	B	46.9/42.4
C121	4030007040	S.CER C1608 CH 1H 180J-T	B	70.9/42.4
C122	4030007000	S.CER C1608 CH 1H 090D-T	B	42/42.4
C124	4030009520	S.CER C1608 CH 1H 020B-T	B	60.7/42.4
C125	4030009550	S.CER C1608 CH 1H 2R5B-T	B	62.5/42.4
C126	4030008360	S.CER C1608 UJ 1H 101J-T	B	40.3/7.5
C128	4030009500	S.CER C1608 CH 1H 0R5B-T	B	60.5/14.4
C129	4030009510	S.CER C1608 CH 1H 010B-T	B	59.7/21.8
C130	4030009520	S.CER C1608 CH 1H 020B-T	B	44.3/21.8
C131	4030009910	S.CER C1608 CH 1H 040B-T	B	44.6/15.1
C132	4030006990	S.CER C1608 CH 1H 080D-T	B	68.6/7.6
C133	4030007040	S.CER C1608 CH 1H 180J-T	B	76/28.6
C134	4030008750	S.CER C1608 CH 1H 360J-T	B	31.4/15
C135	4030007110	S.CER C1608 CH 1H 680J-T	B	34.1/15.2
C136	4030007140	S.CER C1608 CH 1H 121J-T	B	76/21.8
C137	4030007140	S.CER C1608 CH 1H 121J-T	B	42.1/7.5
C138	4030007130	S.CER C1608 CH 1H 101J-T	B	43.9/7.5
C139	4030007160	S.CER C1608 CH 1H 181J-T	B	34.9/7.5
C140	4030007160	S.CER C1608 CH 1H 181J-T	B	36.7/7.5
C141	4030008330	S.CER C1608 UJ 1H 560J-T	B	17.7/59.1
C142	4030008330	S.CER C1608 UJ 1H 560J-T	B	13.7/43.7
C143	4030007090	S.CER C1608 CH 1H 470J-T	B	17.6/48
C201	4030011600	S.CER C1608 JB 1E 104K-T	T	60.2/62.1
C202	4030006900	S.CER C1608 JB 1H 103K-T	T	46.5/64.2
C203	4030011600	S.CER C1608 JB 1E 104K-T	T	45/64.2
C204	4030011600	S.CER C1608 JB 1E 104K-T	T	48/58.6
C205	4030011600	S.CER C1608 JB 1E 104K-T	B	61/63
C206	4030011600	S.CER C1608 JB 1E 104K-T	T	76.8/61
C207	4030006880	S.CER C1608 JB 1H 472K-T	B	59.2/63
C208	4030007010	S.CER C1608 CH 1H 100D-T	T	76.8/58.4
C209	4030006880	S.CER C1608 JB 1H 472K-T	T	62.9/56.3
C210	4030006900	S.CER C1608 JB 1H 103K-T	T	70.2/56.6
C211	4030009000	S.CER C2012 JB 1C 224K-T	T	68.6/56.1
C212	4030006880	S.CER C1608 JB 1H 472K-T	T	71.7/53.9
C213	4030006880	S.CER C1608 JB 1H 472K-T	T	46.5/58.6
C214	4030006880	S.CER C1608 JB 1H 472K-T	T	45/58.6
C215	4030006880	S.CER C1608 JB 1H 472K-T	B	77.8/44.4
RL2	6330001860	RLY UA2-12NU		
RL21	6330001860	RLY UA2-12NU		
RL51	6330001860	RLY UA2-12NU		
RL52	6330001860	RLY UA2-12NU		
RL53	6330001860	RLY UA2-12NU		
RL54	6330001860	RLY UA2-12NU		
RL55	6330001860	RLY UA2-12NU		

[DIGISEL UNIT]

REF NO.	ORDER NO.	DESCRIPTION	M.	H/V LOCATION
RL56	6330001860	RLY UA2-12NU		
RL57	6330001860	RLY UA2-12NU		
RL58	6330001860	RLY UA2-12NU		
RL59	6330001860	RLY UA2-12NU		
RL60	6330001860	RLY UA2-12NU		
RL61	6330001860	RLY UA2-12NU		
RL62	6330001860	RLY UA2-12NU		
RL63	6330001860	RLY UA2-12NU		
RL64	6330001860	RLY UA2-12NU		
RL65	6330001860	RLY UA2-12NU		
RL66	6330001860	RLY UA2-12NU		
RL67	6330001860	RLY UA2-12NU		
RL69	6330001860	RLY UA2-12NU		
RL70	6330001860	RLY UA2-12NU		
RL71	6330001860	RLY UA2-12NU		
RL72	6330001860	RLY UA2-12NU		
RL73	6330001860	RLY UA2-12NU		
RL74	6330001860	RLY UA2-12NU		
RL75	6330001860	RLY UA2-12NU		
RL76	6330001860	RLY UA2-12NU		
RL201	6330001860	RLY UA2-12NU		
J1	6510007020	CNR TMP-J01X-V6		
J2	6510007020	CNR TMP-J01X-V6		
J2017	6510019971	S.CNR 52808-1071	T	99.4/27.4
J2018	6510003391	CNR B03B-EH-S (LF) (SN)		
W11	8600037250	CBL SX3009 J11*J12D1		
EP2	6910014690	S.BEA MPZ1608S221A-T		

M.=Mounted side (T: Mounted on the Top side B: Mounted on the Bottom side)
S.=Surface mount

[FRONT UNIT]

REF NO.	ORDER NO.	DESCRIPTION	M.	H/V LOCATION
W1	8900017300	CBL OPC-1838 (P1,N16,L140)		
W2	8900015940	CBL OPC-875A (P1,N20,L70)		
W3	8900015930	CBL OPC-886A (P1,N10,L75)		
W4	8900017280	CBL OPC-1836 (P1,N10,L60)		
W5	8900014720	CBL OPC-909A (P1,N10,L110)		
W6	8900017290	CBL OPC-1837 (P1,N10,L170)		
W7	8900017100	CBL OPC-1825 (P1,N18,L70)		
W8	8900015930	CBL OPC-886A (P1,N10,L75)		
W9	8900014871	CBL OPC-1332A-1 (P0.5,N40,L100)		
W10	8900014720	CBL OPC-909A (P1,N10,L110)		
W11	8900015930	CBL OPC-886A (P1,N10,L75)		
W12	8900015930	CBL OPC-886A (P1,N10,L75)		
W13	8900014871	CBL OPC-1332A-1 (P0.5,N40,L100)		
EP1	6910015291	UBD LTA070B790F		
EP11	6910011090	SUT RMS20-250-201-P		
EP12	0880001460	UBD EX-2500 [EUR]		
EP101	6910015650	E.OTH S-G2218-3#01 (MOUNT PLATE)		
EP102	6910015650	E.OTH S-G2218-3#01 (MOUNT PLATE)		

[DISPLAY BOARD]

REF NO.	ORDER NO.	DESCRIPTION	M.	H/V LOCATION
IC1	1130009640	S.IC BU4051BCFV-E2	T	113/15
IC3	1130009640	S.IC BU4051BCFV-E2	T	85.2/18.4
IC4	1130009640	S.IC BU4051BCFV-E2	T	43.4/78.7
IC5	1130009640	S.IC BU4051BCFV-E2	T	44.7/68.7
IC6	1140014420	S.IC M30620FCMGP (SX-3009B)	T	52.4/39
IC7	1130011510	S.IC BU2099FV-E2	T	72.2/59.8
IC201	1130009301	S.IC TC7SET08FU (T5L,JF)	T	81/40.5
IC202	1130009301	S.IC TC7SET08FU (T5L,JF)	T	117.2/58.5
IC601	1130011551	S.IC RX-4581NB-F	T	35.5/29.3
IC651	1110005821	S.IC R3112N281A-TR-F	T	120.7/71.8
Q200	1590000430	S.TR DTC144EUA T106	T	117.7/80.1
Q201	1530003301	S.TR 2SC3647S-TD-E	T	100.7/47.1
Q202	1530003301	S.TR 2SC3647S-TD-E	T	98.1/26.5
Q203	1530002060	S.TR 2SC4081 T106 R	T	85.4/50.2
Q204	1520000651	S.TR 2SB1201S-TL-E	T	91/53.9
Q205	1590000680	S.TR DTC114EUA T106	T	82.3/45.9
Q206	1590000680	S.TR DTC114EUA T106	T	134.4/14.6
Q209	1520000651	S.TR 2SB1201S-TL-E	T	123.9/59.9
Q210	1530002060	S.TR 2SC4081 T106 R	T	117.3/55.3
Q211	1590001330	S.TR DTA114EUA T106	T	131.8/63.5
Q212	1590000680	S.TR DTC114EUA T106	T	84/43.1
Q501	1590000680	S.TR DTC114EUA T106	T	131.5/73.3
Q502	1590000680	S.TR DTC114EUA T106	T	29.6/46
Q503	1590000680	S.TR DTC114EUA T106	T	29.6/48.5
Q504	1590001330	S.TR DTA114EUA T106	T	131.5/68.3
Q505	1590000680	S.TR DTC114EUA T106	T	131.5/70.8
Q601	1510000501	S.TR 2SA1162-GR (TE85R,F)	T	113.6/80.4
D7	1750000520	S.DIO DAN222TL	T	130.4/18.3
D8	1160000140	S.DIO DAP222 TL	T	130.4/16.2
D9	1730002340	S.ZEN MA8043-H (TX)	T	85.8/48.1
D10	1730002590	S.ZEN MA8033-H (TX)	T	119.5/56.9
D11	1790001670	S.DIO RB706F-40T106	T	135.2/17.1
D12	1790001670	S.DIO RB706F-40T106	T	50.7/54
D601	1790001250	S.DIO MA2S111-(TX)	T	111.5/81.6
D602	1790001250	S.DIO MA2S111-(TX)	T	113.3/78
D603	1790001250	S.DIO MA2S111-(TX)	T	111.5/78.9
X1	6050009870	S.XTL CR-567 (9.8304 MHz)	T	35.6/40.5
L201	6200001831	S.COL NLV32T-100J	T	31.1/58.1
L204	6200001831	S.COL NLV32T-100J	T	25.9/73.2
L210	6190001191	S.COL D10F-#A814AY-101K	T	88.9/64.9
L211	6190001191	S.COL D10F-#A814AY-101K	T	89.6/30.2
L601	6200001831	S.COL NLV32T-100J	T	116.7/77.3
R200	7030003440	S.RES ERJ3GEYJ 102 V (1 k)	T	84.6/40.4
R201	7030003470	S.RES ERJ3GEYJ 182 V (1.8 k)	T	103.6/43.6
R202	7030003470	S.RES ERJ3GEYJ 182 V (1.8 k)	T	103.6/32.9
R203	7030003800	S.RES ERJ3GEYJ 105 V (1 M)	T	38.9/40.5
R208	7030003360	S.RES ERJ3GEYJ 221 V (220)	T	86.5/45.7
R209	7030003860	S.RES ERJ3GE JPW V	T	16.1/24.6
R210	7030003860	S.RES ERJ3GE JPW V	T	23.7/24
R212	7030003660	S.RES ERJ3GEYJ 683 V (68 k)	T	80.1/45.5
R213	7030003580	S.RES ERJ3GEYJ 153 V (15 k)	T	81.8/43.4
R214	7030003440	S.RES ERJ3GEYJ 102 V (1 k)	T	50.7/13.4
R215	7030003440	S.RES ERJ3GEYJ 102 V (1 k)	T	49.4/13.4
R216	7030003440	S.RES ERJ3GEYJ 102 V (1 k)	T	48.1/13.4
R217	7030003440	S.RES ERJ3GEYJ 102 V (1 k)	T	46.8/13.4
R218	7030003440	S.RES ERJ3GEYJ 102 V (1 k)	T	45.5/13.4
R219	7030003440	S.RES ERJ3GEYJ 102 V (1 k)	T	44.2/13.4
R220	7030003440	S.RES ERJ3GEYJ 102 V (1 k)	T	41.6/13.6
R221	7030003440	S.RES ERJ3GEYJ 102 V (1 k)	T	42.9/13.4
R222	7030003440	S.RES ERJ3GEYJ 102 V (1 k)	T	40.6/16.1
R223	7030003440	S.RES ERJ3GEYJ 102 V (1 k)	T	39.8/13.5
R224	7030003440	S.RES ERJ3GEYJ 102 V (1 k)	T	39.1/16.1
R225	7030003440	S.RES ERJ3GEYJ 102 V (1 k)	T	38.3/13.4
R226	7030003440	S.RES ERJ3GEYJ 102 V (1 k)	T	37.6/16.1
R227	7030003440	S.RES ERJ3GEYJ 102 V (1 k)	T	36.8/13.4
R228	7030003440	S.RES ERJ3GEYJ 102 V (1 k)	T	35.5/13.4
R229	7030003440	S.RES ERJ3GEYJ 102 V (1 k)	T	32.9/13.4
R230	7030003440	S.RES ERJ3GEYJ 102 V (1 k)	T	34.2/13.4
R232	7030003440	S.RES ERJ3GEYJ 102 V (1 k)	T	83.9/13.5
R233	7030003440	S.RES ERJ3GEYJ 102 V (1 k)	T	85.2/13.5
R234	7030003440	S.RES ERJ3GEYJ 102 V (1 k)	T	86.5/13.5
R235	7030003440	S.RES ERJ3GEYJ 102 V (1 k)	T	87.8/13.5
R236	7030003440	S.RES ERJ3GEYJ 102 V (1 k)	T	89.1/13.5
R237	7030003440	S.RES ERJ3GEYJ 102 V (1 k)	T	90.4/13.5
R238	7030003440	S.RES ERJ3GEYJ 102 V (1 k)	T	91.7/13.5
R239	7030003440	S.RES ERJ3GEYJ 102 V (1 k)	T	30.8/53.2
R240	7030003440	S.RES ERJ3GEYJ 102 V (1 k)	T	30.8/51.9
R241	7030003680	S.RES ERJ3GEYJ 104 V (100 k)	T	30.9/54.6
R242	7030003680	S.RES ERJ3GEYJ 104 V (100 k)	T	33.5/52.3
R246	7030003440	S.RES ERJ3GEYJ 102 V (1 k)	T	65.3/13.4
R247	7030003440	S.RES ERJ3GEYJ 102 V (1 k)	T	64/13.4
R248	7030003440	S.RES ERJ3GEYJ 102 V (1 k)	T	62.7/13.4
R249	7030003440	S.RES ERJ3GEYJ 102 V (1 k)	T	61.4/13.4
R250	7030003440	S.RES ERJ3GEYJ 102 V (1 k)	T	60.1/13.4
R251	7030003320	S.RES ERJ3GEYJ 101 V (100)	T	58.8/13.4
R252	7030003440	S.RES ERJ3GEYJ 102 V (1 k)	T	57.5/13.4
R253	7030003440	S.RES ERJ3GEYJ 102 V (1 k)	T	56.2/13.4
R254	7030003680	S.RES ERJ3GEYJ 104 V (100 k)	T	54.9/13.4
R255	7030003640	S.RES ERJ3GEYJ 473 V (47 k)	T	22.6/14.1
R256	7030003640	S.RES ERJ3GEYJ 473 V (47 k)	T	26.5/14.1
R257	7030003670	S.RES ERJ3GEYJ 823 V (82 k)	T	23.9/14.1
R258	7030003670	S.RES ERJ3GEYJ 823 V (82 k)	T	25.2/14.1
R259	7030003440	S.RES ERJ3GEYJ 102 V (1 k)	T	40.9/63.4
R260	7030003440	S.RES ERJ3GEYJ 102 V (1 k)	T	16.4/59.4
R261	7030003440	S.RES ERJ3GEYJ 102 V (1 k)	T	6.3/58.7
R262	7030003440	S.RES ERJ3GEYJ 102 V (1 k)	T	16/56
R263	7030003440	S.RES ERJ3GEYJ 102 V (1 k)	T	6.3/55.6
R264	7030003440	S.RES ERJ3GEYJ 102 V (1 k)	T	16/54.7
R265	7030003440	S.RES ERJ3GEYJ 102 V (1 k)	T	6.3/54.3
R266	7030003440	S.RES ERJ3GEYJ 102 V (1 k)	T	16/53.4
R267	7030003440	S.RES ERJ3GEYJ 102 V (1 k)	T	6.3/53
R268	7030003440	S.RES ERJ3GEYJ 102 V (1 k)	T	15.2/52.1
R270	7030003440	S.RES ERJ3GEYJ 102 V (1 k)	T	15.2/50.8
R272	7030003440	S.RES ERJ3GEYJ 102 V (1 k)	T	6.3/51.7
R273	7030003440	S.RES ERJ3GEYJ 102 V (1 k)	T	6.3/50.4
R274	7030003440	S.RES ERJ3GEYJ 102 V (1 k)	T	15.2/49.5
R275	7030003440	S.RES ERJ3GEYJ 102 V (1 k)	T	6.3/49.1
R276	7030003440	S.RES ERJ3GEYJ 102 V (1 k)	T	15.9/72.6
R278	7030003440	S.RES ERJ3GEYJ 102 V (1 k)	T	15.9/62.2
R279	7030003440	S.RES ERJ3GEYJ 102 V (1 k)	T	6.3/62
R280	7030003440	S.RES ERJ3GEYJ 102 V (1 k)	T	15.9/63.5
R281	7030003440	S.RES ERJ3GEYJ 102 V (1 k)	T	6.3/63.3
R282	7030003440	S.RES ERJ3GEYJ 102 V (1 k)	T	15.9/64.8
R295	7030003440	S.RES ERJ3GEYJ 102 V (1 k)	T	15.9/67.4
R296	7030003440	S.RES ERJ3GEYJ 102 V (1 k)	T	6.2/67.2
R297	7030003440	S.RES ERJ3GEYJ 102 V (1 k)	T	15.9/68.7
R298	7030003440	S.RES ERJ3GEYJ 102 V (1 k)	T	6.3/68.5
R299	7030003440	S.RES ERJ3GEYJ 102 V (1 k)	T	6.3/64.6
R300	7030003440	S.RES ERJ3GEYJ 102 V (1 k)	T	15.9/71.3
R301	7030003440	S.RES ERJ3GEYJ 102 V (1 k)	T	6.3/71.1
R302	7030003560	S.RES ERJ3GEYJ 103 V (10 k)	T	6.3/69.8
R303	7030003560	S.RES ERJ3GEYJ 103 V (10 k)	T	15.9/70
R304	7030003560	S.RES ERJ3GEYJ 103 V (10 k)	T	6.3/65.9
R305	7030003560	S.RES ERJ3GEYJ 103 V (10 k)	T	15.9/66.1
R310	7030003440	S.RES ERJ3GEYJ 102 V (1 k)	T	14.6/22.4
R311	7030003440	S.RES ERJ3GEYJ 102 V (1 k)	T	14.6/21.1
R312	7030003440	S.RES ERJ3GEYJ 102 V (1 k)	T	135/20.4
R313	7030003440	S.RES ERJ3GEYJ 102 V (1 k)	T	135/19.1
R320	7030003440	S.RES ERJ3GEYJ 102 V (1 k)	T	135/26.9
R321	7030003440	S.RES ERJ3GEYJ 102 V (1 k)	T	135/25.6
R322	7030003440	S.RES ERJ3GEYJ 102 V (1 k)	T	135/24.3
R323	7030003560	S.RES ERJ3GEYJ 103 V (10 k)	T	135/28.2
R326	7030003360	S.RES ERJ3GEYJ 221 V (220)	T	119.8/54.4
R327	7030003580	S.RES ERJ3GEYJ 153 V (15 k)	T	115.4/55.1
R328	7030003660	S.RES ERJ3GEYJ 683 V (68 k)	T	115/61.2
R329	7030003560	S.RES ERJ3GEYJ 103 V (10 k)	T	52/21.3
R330	7030003500	S.RES ERJ3GEYJ 332 V (3.3 k)	T	134.4/63
R333	7030003640	S.RES ERJ3GEYJ 473 V (47 k)	T	16/57.3
R334	7030003640	S.RES ERJ3GEYJ 473 V (47 k)	T	6.3/56.9
R337	7030003670	S.RES ERJ3GEYJ 823 V (82 k)	T	19.7/57.3
R338	7030003670	S.RES ERJ3GEYJ 823 V (82 k)	T	2.8/56.9
R339	7070000261	RES ERG2SJ 220 (22)		
R340	7070000261	RES ERG2SJ 220 (22)		
R342	7030003640	S.RES ERJ3GEYJ 473 V (47 k)	T	80.2/38.1
R343	7030003640	S.RES ERJ3GEYJ 473 V (47 k)	T	115.1/57.7
R351	7030003440	S.RES ERJ3GEYJ 102 V (1 k)	T	135.3/74.9
R352	7030003440	S.RES ERJ3GEYJ 102 V (1 k)	T	135.3/76.2
R353	7030003440	S.RES ERJ3GEYJ 102 V (1 k)	T	50/69.5
R354	7030003440	S.RES ERJ3GEYJ 102 V (1 k)	T	50/66.8
R355	7030003440	S.RES ERJ3GEYJ 102 V (1 k)	T	50/68.2
R356	7030003440	S.RES ERJ3GEYJ 102 V (1 k)	T	128.4/9.8
R357	7030003440	S.RES ERJ3GEYJ 102 V (1 k)	T	119.4/10
R358	7030003440	S.RES ERJ3GEYJ 102 V (1 k)	T	128.5/11.8
R359	7030003440	S.RES ERJ3GEYJ 102 V (1 k)	T	119.4/11.3
R360	7030003440	S.RES ERJ3GEYJ 102 V (1 k)	T	128.5/13.8
R361	7030003440	S.RES ERJ3GEYJ 102 V (1 k)	T	119.4/12.6
R362	7030003440	S.RES ERJ3GEYJ 102 V (1 k)	T	135/23
R363	7030003440	S.RES ERJ3GEYJ 102 V (1 k)	T	135/21.7
R364	7030003640	S.RES ERJ3GEYJ 473 V (47 k)	T	51.1/51.6
R365	7030004730	S.RES ERJ3GEYF 222 V (2.2 k)	T	49.8/51.6
R366	7030003440	S.RES ERJ3GEYJ 102 V (1 k)	T	134.4/70.6
R369	7030003860	S.RES ERJ3GE JPW V	T	44.8/51.7
R501	7030003640	S.RES ERJ3GEYJ 473 V (47 k)	T	52/22.6
R502	7030003640	S.RES ERJ3GEYJ 473 V (47 k)	T	52/23.9
R503	7030003640	S.RES ERJ3GEYJ 473 V (47 k)	T	54.7/20.6
R504	7030003440	S.RES ERJ3GEYJ 102 V (1 k)	T	134.4/69.3
R505	7030003330	S.RES ERJ3GEYJ 121 V (120)	T	134.4/68
R506	7030003640	S.RES ERJ3GEYJ 473 V (47 k)	T	52/20
R601	70			

[DISPLAY BOARD]

REF NO.	ORDER NO.	DESCRIPTION	M.	H/V LOCATION
R603	7030003640	S.RES ERJ3GEYJ 473 V (47 k)	T	30.3/28.6
R604	7030003560	S.RES ERJ3GEYJ 103 V (10 k)	T	30.3/30.1
R651	7030003650	S.RES ERJ3GEYJ 563 V (56 k)	T	117.9/74.4
R652	7030003620	S.RES ERJ3GEYJ 333 V (33 k)	T	116.6/71.8
R653	7030003520	S.RES ERJ3GEYJ 472 V (4.7 k)	T	116.6/74.4
R654	7030003540	S.RES ERJ3GEYJ 682 V (6.8 k)	T	144/77.2
R655	7030003540	S.RES ERJ3GEYJ 682 V (6.8 k)	T	144/77.2
R656	7030003540	S.RES ERJ3GEYJ 682 V (6.8 k)	T	144/77.2
R657	7030003540	S.RES ERJ3GEYJ 682 V (6.8 k)	T	144/74.6
C201	4310001170	MLR ECQE1A 124JBB		
C202	4030016880	S.CER C4520 CH 3F 150KT-A	T	134.5/44.3
C203	4030007020	S.CER C1608 CH 1H 120J-T	T	40.2/41.3
C204	4030007020	S.CER C1608 CH 1H 120J-T	T	40.1/38.7
C205	4030011600	S.CER C1608 JB 1E 104K-T	T	43.2/82.3
C206	4030011600	S.CER C1608 JB 1E 104K-T	T	43.4/65.2
C207	4030011600	S.CER C1608 JB 1E 104K-T	T	83.9/22
C209	4030011600	S.CER C1608 JB 1E 104K-T	T	115.2/18.5
C210	4030011600	S.CER C1608 JB 1E 104K-T	T	83/40.4
C211	4030011600	S.CER C1608 JB 1E 104K-T	T	117.6/61.2
C212	4510008800	S.ELE EEE1EA100SR	T	80.3/50
C213	4510009150	S.ELE EEE1EA470WP	T	89.3/40.8
C214	4510008800	S.ELE EEE1EA100SR	T	83.7/55.8
C215	4030011600	S.CER C1608 JB 1E 104K-T	T	32.4/62.7
C216	4030011600	S.CER C1608 JB 1E 104K-T	T	66.1/6.2
C217	4030011600	S.CER C1608 JB 1E 104K-T	T	34.2/54.3
C218	4510009150	S.ELE EEE1EA470WP	T	36.6/61.8
C219	4030006860	S.CER C1608 JB 1H 102K-T	T	34.2/55.7
C220	4030011600	S.CER C1608 JB 1E 104K-T	T	28.7/72.1
C221	4030011600	S.CER C1608 JB 1E 104K-T	T	113.2/55.1
C222	4030011600	S.CER C1608 JB 1E 104K-T	T	82.6/13.5
C223	4030011600	S.CER C1608 JB 1E 104K-T	T	144.6/33.9
C224	4030011600	S.CER C1608 JB 1E 104K-T	T	41.9/39
C225	4030011600	S.CER C1608 JB 1E 104K-T	T	70/55.6
C226	4030011600	S.CER C1608 JB 1E 104K-T	T	18.7/60.7
C227	4030011600	S.CER C1608 JB 1E 104K-T	T	33.1/66.2
C228	4510008800	S.ELE EEE1EA100SR	T	32.6/70.4
C229	4030011600	S.CER C1608 JB 1E 104K-T	T	6.3/73.7
C230	4030006880	S.CER C1608 JB 1H 472K-T	T	50.6/55.9
C231	4030011600	S.CER C1608 JB 1E 104K-T	T	64.6/38.9
C232	4030011600	S.CER C1608 JB 1E 104K-T	T	47.4/53
C241	4030011600	S.CER C1608 JB 1E 104K-T	T	106.5/17.3
C242	4030011600	S.CER C1608 JB 1E 104K-T	T	106.5/16
C243	4030011600	S.CER C1608 JB 1E 104K-T	T	106.5/14.7
C244	4030011600	S.CER C1608 JB 1E 104K-T	T	106.5/13.4
C245	4030011600	S.CER C1608 JB 1E 104K-T	T	119.4/17.8
C246	4030011600	S.CER C1608 JB 1E 104K-T	T	119.4/16.5
C247	4030011600	S.CER C1608 JB 1E 104K-T	T	119.4/15.2
C248	4030011600	S.CER C1608 JB 1E 104K-T	T	119.4/13.9
C254	4030011600	S.CER C1608 JB 1E 104K-T	T	50.2/79.6
C255	4030011600	S.CER C1608 JB 1E 104K-T	T	50.2/80.9
C257	4030011600	S.CER C1608 JB 1E 104K-T	T	79.2/19.4
C258	4030011600	S.CER C1608 JB 1E 104K-T	T	79.2/20.7
C259	4030011600	S.CER C1608 JB 1E 104K-T	T	79.2/16.8
C260	4030011600	S.CER C1608 JB 1E 104K-T	T	79.2/18.1
C261	4030011600	S.CER C1608 JB 1E 104K-T	T	93.1/16.8
C262	4030011600	S.CER C1608 JB 1E 104K-T	T	93.1/18.1
C263	4030011600	S.CER C1608 JB 1E 104K-T	T	93.1/19.4
C264	4030011600	S.CER C1608 JB 1E 104K-T	T	93.1/20.7
C265	4030011600	S.CER C1608 JB 1E 104K-T	T	50.2/77
C266	4030011600	S.CER C1608 JB 1E 104K-T	T	50.2/78.3
C601	4510008800	S.ELE EEE1EA100SR	T	113/73.1
C602	4030011600	S.CER C1608 JB 1E 104K-T	T	30.3/27.3
C651	4030008890	S.CER C1608 JB 1H 273K-T	T	123.3/72
C652	4030011600	S.CER C1608 JB 1E 104K-T	T	117.9/71.8
J1	6510022471	S.CNR 40FLT-SM2-TB (LF) (SN)	T	11/59.6
J4	6510020531	S.CNR 52808-1871	T	40.8/8.8
J5	6510019971	S.CNR 52808-1071	T	87.7/8.8
J7	6510019971	S.CNR 52808-1071	T	60.7/8.8
J8	6510019971	S.CNR 52808-1071	T	124/12.3
J201	6510022471	S.CNR 40FLT-SM2-TB (LF) (SN)	T	9.5/28.4
J202	6510022471	S.CNR 40FLT-SM2-TB (LF) (SN)	T	19.9/28.4
J203	6510020081	S.CNR 52808-2071 (2090)	T	26/59.7
J205	6510003401	CNR B04B-EH-S (LF) (SN)		
J301	6510021181	S.CNR SM2 (8.0) B-BHS1TB(LF)(SN)	T	141.7/44.8
J601	6510021861	CNR BH-800.4GG <LTC>		
J602	6510020081	S.CNR 52808-2071 (2090)	T	139.7/70.5
J603	6510019971	S.CNR 52808-1071	T	102.7/8.8
J604	6510019981	S.CNR 52808-1671 (1690)	T	140.1/27.4
J605	6510018961	S.CNR B2B-PH-SM4-TB (LF) (SN)	T	87.5/81.9
J606	6510022191	S.CNR B3B-PH-SM4-TB (LF) (SN)	T	99.4/82.9
T201	5910000981	TSM 3319-T088-LF		
BT601	3020000110	LTM CR2032		
EP203	6910014690	S.BEA MPZ1608S221A-T	T	30.4/62.3
EP205	6910014690	S.BEA MPZ1608S221A-T	T	47.4/54.3
EP207	6910014690	S.BEA MPZ1608S221A-T	T	143.9/32
EP208	6910014690	S.BEA MPZ1608S221A-T	T	31/64.9
EP209	6910014690	S.BEA MPZ1608S221A-T	T	6.3/72.4

[VR-A BOARD]

REF NO.	ORDER NO.	DESCRIPTION	M.	H/V LOCATION
R1	7210002970	VAR RV-314 (RK0972210 10KB/10KB)		
R2	7210002970	VAR RV-314 (RK0972210 10KB/10KB)		
R3	7030003520	S.RES ERJ3GEYJ 472 V (4.7 k)	T	22.7/61.5
R4	7030003520	S.RES ERJ3GEYJ 472 V (4.7 k)	T	18.2/61.5
R5	7030003520	S.RES ERJ3GEYJ 472 V (4.7 k)	T	24.2/39
R6	7030003520	S.RES ERJ3GEYJ 472 V (4.7 k)	T	19.5/39
R101	7030003860	S.RES ERJ3GE JPW V	T	8.8/56.1
R102	7030003860	S.RES ERJ3GE JPW V	T	4.6/56.1
R103	7030003860	S.RES ERJ3GE JPW V	T	3.3/56
R104	7030003860	S.RES ERJ3GE JPW V	T	9.4/9
R105	7030003860	S.RES ERJ3GE JPW V	T	8.2/9
R106	7030003860	S.RES ERJ3GE JPW V	T	6.2/9
R107	7030003860	S.RES ERJ3GE JPW V	T	4.2/8.1
R108	7030003860	S.RES ERJ3GE JPW V	T	12/23.5
C1	4030006880	S.CER C1608 JB 1H 472K-T	T	20.7/39
C2	4030006880	S.CER C1608 JB 1H 472K-T	T	23/39
C3	4030006880	S.CER C1608 JB 1H 472K-T	T	19.5/61.5
C4	4030006880	S.CER C1608 JB 1H 472K-T	T	21.5/61.5
J103	6510019971	S.CNR 52808-1071	T	9.5/60.6
J104	6510020711	S.CNR 52793-1070 (1090)	T	9.7/2.4
J106	6510019981	S.CNR 52808-1671 (1690)	T	4.8/40.9
J107	6510025270	S.CNR S6B-PH-SM4-TB (LF) (SN)	T	3.7/18.5
EP107	6910012350	S.BEA MMZ1608Y 102BT	T	13.1/56.1
EP108	6910012350	S.BEA MMZ1608Y 102BT	T	14.4/56.1
EP111	6910012350	S.BEA MMZ1608Y 102BT	T	10.1/56.1
EP112	6910012350	S.BEA MMZ1608Y 102BT	T	7.4/56.1
EP113	6910012350	S.BEA MMZ1608Y 102BT	T	6/56.1
EP114	6910012350	S.BEA MMZ1608Y 102BT	T	16.1/83.9
EP115	6910012350	S.BEA MMZ1608Y 102BT	T	16.1/13.5
EP116	6910012350	S.BEA MMZ1608Y 102BT	T	14.8/13.5
EP117	6910012350	S.BEA MMZ1608Y 102BT	T	13.5/13.5
EP118	6910012350	S.BEA MMZ1608Y 102BT	T	12.2/13.5
EP119	6910012350	S.BEA MMZ1608Y 102BT	T	10.9/13.5
EP120	6910012350	S.BEA MMZ1608Y 102BT	T	15.5/21.7
EP121	6910012350	S.BEA MMZ1608Y 102BT	T	15.5/22.9
EP122	6910012350	S.BEA MMZ1608Y 102BT	T	15.5/20.5

[VR-B BOARD]

REF NO.	ORDER NO.	DESCRIPTION	M.	H/V LOCATION
R1	7210002970	VAR RV-314 (RK0972210 10KB/10KB)		
R2	7210002970	VAR RV-314 (RK0972210 10KB/10KB)		
R3	7210002970	VAR RV-314 (RK0972210 10KB/10KB)		
R4	7030003520	S.RES ERJ3GEYJ 472 V (4.7 k)	T	12.7/78
R5	7030003520	S.RES ERJ3GEYJ 472 V (4.7 k)	T	11.3/78
R6	7030003520	S.RES ERJ3GEYJ 472 V (4.7 k)	T	12.7/42.4
R7	7030003520	S.RES ERJ3GEYJ 472 V (4.7 k)	T	11.3/42.4
R8	7030003520	S.RES ERJ3GEYJ 472 V (4.7 k)	T	12.2/14
R9	7030003520	S.RES ERJ3GEYJ 472 V (4.7 k)	T	10.9/14
C1	4030006880	S.CER C1608 JB 1H 472K-T	T	10/42.4
C2	4030006880	S.CER C1608 JB 1H 472K-T	T	12.7/39.7
C3	4030006880	S.CER C1608 JB 1H 472K-T	T	10.1/78
C4	4030006880	S.CER C1608 JB 1H 472K-T	T	13.9/78
C5	4030006880	S.CER C1608 JB 1H 472K-T	T	9.7/14
C6	4030006880	S.CER C1608 JB 1H 472K-T	T	12.2/16.6
J1	6510019971	S.CNR 52808-1071	T	4/42.4

[VR-C BOARD]

REF NO.	ORDER NO.	DESCRIPTION	M.	H/V LOCATION
R1	7210001130	VAR RK097111T005A (10KB)		
R2	7210001130	VAR RK097111T005A (10KB)		
R3	7210001130	VAR RK097111T005A (10KB)		
R4	7210001130	VAR RK097111T005A (10KB)		
R5	7210001130	VAR RK097111T005A (10KB)		
R6	7210001130	VAR RK097111T005A (10KB)		
R7	7210001130	VAR RK097111T005A (10KB)		
R11	7030003520	S.RES ERJ3GEYJ 472 V (4.7 k)	B	139.3/11
R12	7030003520	S.RES ERJ3GEYJ 472 V (4.7 k)	B	117.2/11
R13	7030003520	S.RES ERJ3GEYJ 472 V (4.7 k)	B	95.1/11
R14	7030003520	S.RES ERJ3GEYJ 472 V (4.7 k)	B	74.5/11
R15	7030003520	S.RES ERJ3GEYJ 472 V (4.7 k)	B	8.2/11
R16	7030003520	S.RES ERJ3GEYJ 472 V (4.7 k)	B	30.3/11
R17	7030003520	S.RES ERJ3GEYJ 472 V (4.7 k)	B	52.4/11
C11	4030006880	S.CER C1608 JB 1H 472K-T	B	139.3/9.7
C12	4030006880	S.CER C1608 JB 1H 472K-T	B	117.2/9.7
C13	4030006880	S.CER C1608 JB 1H 472K-T	B	95.1/9.7
C14	4030006880	S.CER C1608 JB 1H 472K-T	B	74.5/9.7
C15	4030006880	S.CER C1608 JB 1H 472K-T	B	8.2/9.7
C16	4030006880	S.CER C1608 JB 1H 472K-T	B	30.3/9.7
C17	4030006880	S.CER C1608 JB 1H 472K-T	B	52.4/9.7
J1	6510019971	S.CNR 52808-1071	B	81.8/5.5

M.=Mounted side (T: Mounted on the Top side B: Mounted on the Bottom side) S.=Surface mount

[SW-A BOARD]

REF NO.	ORDER NO.	DESCRIPTION	M.	H/V LOCATION
R2	7030003400	S.RES ERJ3GEYJ 471 V (470)	B	9.3/83.2
R3	7030003420	S.RES ERJ3GEYJ 681 V (680)	B	8.6/61.5
R4	7030003390	S.RES ERJ3GEYJ 391 V (390)	B	8.6/60.2
R12	7030003400	S.RES ERJ3GEYJ 471 V (470)	B	36.7/81.7
R13	7030003480	S.RES ERJ3GEYJ 222 V (2.2 k)	B	10.8/47
R14	7030003520	S.RES ERJ3GEYJ 472 V (4.7 k)	B	21.2/71
R22	7030003480	S.RES ERJ3GEYJ 222 V (2.2 k)	B	97.7/81.5
R23	7030003520	S.RES ERJ3GEYJ 472 V (4.7 k)	B	99.3/63.3
R24	7030003580	S.RES ERJ3GEYJ 153 V (15 k)	B	99.3/55
R25	7030003480	S.RES ERJ3GEYJ 222 V (2.2 k)	B	99.3/30.1
R26	7030003520	S.RES ERJ3GEYJ 472 V (4.7 k)	B	99.3/19.9
R27	7030003580	S.RES ERJ3GEYJ 153 V (15 k)	B	98.1/19.9
R29	7030003580	S.RES ERJ3GEYJ 153 V (15 k)	B	43/71
R30	7030003400	S.RES ERJ3GEYJ 471 V (470)	B	56.5/81.7
R31	7030003400	S.RES ERJ3GEYJ 471 V (470)	B	76.3/81.7
C2	4030011600	S.CER C1608 JB 1E 104K-T	B	91.2/72.7
C4	4030011600	S.CER C1608 JB 1E 104K-T	B	99.2/71.1
C5	4030011600	S.CER C1608 JB 1E 104K-T	B	90.5/69.9
C9	4030011600	S.CER C1608 JB 1E 104K-T	B	96.8/52.4
J1	6510020081	S.CNR 52808-2071 (2090)	B	95/65.4
DS5	5040002980	S.LED SML-512DW-T86	T	9.5/93.7
DS6	5040002930	S.LED SML-512MW T86	T	9/92.4
DS7	5040002930	S.LED SML-512MW T86	T	9.5/45.3
DS12	5040002930	S.LED SML-512MW T86	T	35.9/76.2
DS15	5040002990	S.LED SML-512UWT86	T	9/62.1
DS16	5040002930	S.LED SML-512MW T86	T	9/60.8
DS17	5040002930	S.LED SML-512MW T86	T	55.7/76.2
DS18	5040002930	S.LED SML-512MW T86	T	75.5/76.2
S1	2260002740	S.SW LS8J2M-T	T	8.3/85.2
S2	2260002740	S.SW LS8J2M-T	T	9.8/70.1
S3	2260002740	S.SW LS8J2M-T	T	8.3/54.7
S4	2260002740	S.SW LS8J2M-T	T	8.3/39.3
S11	2260002740	S.SW LS8J2M-T	T	35.7/70.8
S14	2260002740	S.SW LS8J2M-T	T	100.2/81.3
S15	2260002740	S.SW LS8J2M-T	T	100.2/69.3
S16	2260002740	S.SW LS8J2M-T	T	100.2/57.3
S17	2260002740	S.SW LS8J2M-T	T	100.2/45.3
S18	2260002740	S.SW LS8J2M-T	T	100.2/33.3
S19	2260002740	S.SW LS8J2M-T	T	100.2/21.3
S20	2260002740	S.SW LS8J2M-T	T	100.2/9.3
S21	2260002740	S.SW LS8J2M-T	T	55.5/70.8
S22	2260002740	S.SW LS8J2M-T	T	75.3/70.8

[SW-B BOARD]

REF NO.	ORDER NO.	DESCRIPTION	M.	H/V LOCATION
J1	6510020531	S.CNR 52808-1871	B	117/18.5
S1	2260002740	S.SW LS8J2M-T	T	22.1/22.8
S2	2260002740	S.SW LS8J2M-T	T	44.1/22.8
S3	2260002740	S.SW LS8J2M-T	T	66.1/22.8
S4	2260002740	S.SW LS8J2M-T	T	88.1/22.8
S5	2260002740	S.SW LS8J2M-T	T	110.1/22.8
S6	2260002740	S.SW LS8J2M-T	T	132.1/22.8
S7	2260002740	S.SW LS8J2M-T	T	154.1/22.8
S8	2260002740	S.SW LS8J2M-T	T	22.1/13.9
S9	2260002740	S.SW LS8J2M-T	T	44.1/13.9
S10	2260002740	S.SW LS8J2M-T	T	66.1/13.9
S11	2260002740	S.SW LS8J2M-T	T	88.1/13.9
S12	2260002740	S.SW LS8J2M-T	T	110.1/13.9
S13	2260002740	S.SW LS8J2M-T	T	132.1/13.9
S14	2260002740	S.SW LS8J2M-T	T	154.1/13.9
S15	2260002740	S.SW LS8J2M-T	T	146.3/2.3
S16	2260002740	S.SW LS8J2M-T	T	158.1/2.3
S17	2260002740	S.SW LS8J2M-T	T	175.6/4.5

[JACK BOARD]

REF NO.	ORDER NO.	DESCRIPTION	M.	H/V LOCATION
L4	6180000900	COL LAL 03NA 101K		
L5	6180000900	COL LAL 03NA 101K		
L6	6180000900	COL LAL 03NA 101K		
L101	6180000900	COL LAL 03NA 101K		
L102	6180000900	COL LAL 03NA 101K		
L103	6180000900	COL LAL 03NA 101K		
R1	7030006240	S.RES ERJ12YJ181U (180)	B	5.8/30.9
R2	7030006240	S.RES ERJ12YJ181U (180)	B	6.1/21.8
C1	4030006880	S.CER C1608 JB 1H 472K-T	T	18.9/41.2
C2	4030006880	S.CER C1608 JB 1H 472K-T	T	3.3/36.9
C101	4030006880	S.CER C1608 JB 1H 472K-T	B	3/19
C102	4030006880	S.CER C1608 JB 1H 472K-T	T	6.9/19
J1	6510020711	S.CNR 52793-1070 (1090)	T	9.2/42.6
J2	6510023891	CNR S-G4617#01F		
J102	6510023900	CNR LGR4619-7000		
EP1	6910014690	S.BEA MPZ1608S221A-T	B	27.5/30.8
EP2	6910014690	S.BEA MPZ1608S221A-T	B	4.3/28.4
EP3	6910014690	S.BEA MPZ1608S221A-T	B	4/24.3
EP101	6910012350	S.BEA MMZ1608Y 102BT	T	3/16.4
EP102	6910012350	S.BEA MMZ1608Y 102BT	T	6.9/16.4

[MIC BOARD]

REF NO.	ORDER NO.	DESCRIPTION	M.	H/V LOCATION
L1	6200003261	S.COL NLV32T-101J	B	4.5/17.8
L2	6200003261	S.COL NLV32T-101J	B	2.4/12.5
L3	6200003261	S.COL NLV32T-101J	B	4.5/2
C1	4030006880	S.CER C1608 JB 1H 472K-T	B	8.6/16.1
C2	4030006880	S.CER C1608 JB 1H 472K-T	B	2.8/5.5
C3	4030006880	S.CER C1608 JB 1H 472K-T	B	14.2/12.4
C4	4030007130	S.CER C1608 CH 1H 101J-T	B	10.1/11.2
C5	4030006880	S.CER C1608 JB 1H 472K-T	B	1.5/5.5
C6	4030006880	S.CER C1608 JB 1H 472K-T	B	9.6/9
C7	4030006880	S.CER C1608 JB 1H 472K-T	B	7.7/10.1
C8	4030007090	S.CER C1608 CH 1H 470J-T	B	9.4/13.9
J1	6510000191	CNR FM214-8SS (P) -1		
J2	6510019971	S.CNR 52808-1071	B	12.7/20.2
EP2	6910012350	S.BEA MMZ1608Y 102BT	B	4.1/6.3
EP3	6910012350	S.BEA MMZ1608Y 102BT	B	7.6/2
EP4	6910012350	S.BEA MMZ1608Y 102BT	B	10.5/16
EP5	6910012350	S.BEA MMZ1608Y 102BT	B	2.7/8.1
EP6	6910012350	S.BEA MMZ1608Y 102BT	B	7.7/7.7
EP7	6910015130	S.BEA MMZ1608D 301BT	B	17.2/10.8
EP8	6910015130	S.BEA MMZ1608D 301BT	B	15.9/10.8
EP9	6910015130	S.BEA MMZ1608D 301BT	B	10.2/6.9
EP10	6910015130	S.BEA MMZ1608D 301BT	B	11.5/9.1
EP11	6910012350	S.BEA MMZ1608Y 102BT	B	5.4/14.1
EP12	6910014690	S.BEA MPZ1608S221A-T	B	15.2/15

M.=Mounted side (T: Mounted on the Top side B: Mounted on the Bottom side)
S.=Surface mount

[USB BOARD]

REF NO.	ORDER NO.	DESCRIPTION	M.	H/V LOCATION
R1	7030003380	S.RES ERJ3GEYJ 331 V (330)	B	52/36.1
R2	7030003380	S.RES ERJ3GEYJ 331 V (330)	B	46.2/36.1
R3	7030003380	S.RES ERJ3GEYJ 331 V (330)	B	28/36.1
R4	7030003450	S.RES ERJ3GEYJ 122 V (1.2 k)	B	22.5/28.2
R5	7030003580	S.RES ERJ3GEYJ 153 V (15 k)	B	47.4/30.6
R6	7030003520	S.RES ERJ3GEYJ 472 V (4.7 k)	B	32.7/30.6
R7	7030003480	S.RES ERJ3GEYJ 222 V (2.2 k)	B	22.7/22.3
R103	7030003860	S.RES ERJ3GE JPW V	B	12.8/23.5
R104	7030003860	S.RES ERJ3GE JPW V	B	11.5/23.5
R113	7030003860	S.RES ERJ3GE JPW V	B	11.6/12.2
R114	7030003860	S.RES ERJ3GE JPW V	B	12.8/12.2
C1	4030011600	S.CER C1608 JB 1E 104K-T	B	33.4/25
J106	6510019971	S.CNR 52808-1071	B	27.2/22.5
J107	6510026080	CNR XM7A-0441		
J108	6510026080	CNR XM7A-0441		
J109	6510022031	S.CNR B10B-ZR-SM4-TF (LF) (SN)	B	2.6/27.8
DS8	5040002930	S.LED SML-512MW T86	T	12.4/36.1
DS9	5040002930	S.LED SML-512MW T86	T	39.1/36.1
DS10	5040002930	S.LED SML-512MW T86	T	58.6/36.1
DS11	5040002990	S.LED SML-512UWT86	T	12.4/23.8
S1	2260002740	S.SW LS8J2M-T	T	58.9/31.5
S2	2260002740	S.SW LS8J2M-T	T	38.9/31.5
S3	2260002740	S.SW LS8J2M-T	T	12.2/31.5
EP102	6910014730	S.BEA MPZ2012S331A-T	B	10/23.5
EP105	6910014730	S.BEA MPZ2012S331A-T	B	14.4/23.5
EP112	6910014730	S.BEA MPZ2012S331A-T	B	10/12.2
EP115	6910014730	S.BEA MPZ2012S331A-T	B	14.4/12.2

[TENKEY BOARD]

REF NO.	ORDER NO.	DESCRIPTION	M.	H/V LOCATION
IC1	1130011510	S.IC BU2099FV-E2	B	23.2/113.2
R1	7030003480	S.RES ERJ3GEYJ 222 V (2.2 k)	B	14.9/121.7
R2	7030003520	S.RES ERJ3GEYJ 472 V (4.7 k)	B	15.9/112
R3	7030003580	S.RES ERJ3GEYJ 153 V (15 k)	B	16/101.9
R4	7030003540	S.RES ERJ3GEYJ 682 V (6.8 k)	B	16.1/121.7
R5	7030003480	S.RES ERJ3GEYJ 222 V (2.2 k)	B	31.5/121.7
R6	7030003520	S.RES ERJ3GEYJ 472 V (4.7 k)	B	32.7/112.2
R7	7030003580	S.RES ERJ3GEYJ 153 V (15 k)	B	32.7/102.7
R8	7030003540	S.RES ERJ3GEYJ 682 V (6.8 k)	B	30.3/121.7
R9	7030003480	S.RES ERJ3GEYJ 222 V (2.2 k)	B	53/121.7
R10	7030003520	S.RES ERJ3GEYJ 472 V (4.7 k)	B	54.2/112.2
R11	7030003580	S.RES ERJ3GEYJ 153 V (15 k)	B	54.2/102.7
R12	7030003540	S.RES ERJ3GEYJ 682 V (6.8 k)	B	51.8/121.7
R51	7030003540	S.RES ERJ3GEYJ 682 V (6.8 k)	B	85.7/117.8
R52	7030003420	S.RES ERJ3GEYJ 681 V (680)	B	88.2/116.7
R53	7030003480	S.RES ERJ3GEYJ 222 V (2.2 k)	B	86.5/112
R54	7030003520	S.RES ERJ3GEYJ 472 V (4.7 k)	B	86.2/92.3
R55	7030003420	S.RES ERJ3GEYJ 681 V (680)	B	91/95.1
R56	7030003420	S.RES ERJ3GEYJ 681 V (680)	B	91/85.6
R57	7030003580	S.RES ERJ3GEYJ 153 V (15 k)	B	86.2/82.7
R58	7030003540	S.RES ERJ3GEYJ 682 V (6.8 k)	B	84.6/73.3
R59	7030003420	S.RES ERJ3GEYJ 681 V (680)	B	91/76.1
R60	7030003480	S.RES ERJ3GEYJ 222 V (2.2 k)	B	84.6/60.1
R61	7030003520	S.RES ERJ3GEYJ 472 V (4.7 k)	B	84.6/47.4
R62	7030003580	S.RES ERJ3GEYJ 153 V (15 k)	B	84.6/41.7
R63	7030003540	S.RES ERJ3GEYJ 682 V (6.8 k)	B	85.7/24
R65	7030003480	S.RES ERJ3GEYJ 222 V (2.2 k)	B	85.7/10
R66	7030003520	S.RES ERJ3GEYJ 472 V (4.7 k)	B	75.4/6.6
C1	4030011600	S.CER C1608 JB 1E 104K-T	B	13.7/121.7
C2	4030011600	S.CER C1608 JB 1E 104K-T	B	32.7/121.7
C3	4030011600	S.CER C1608 JB 1E 104K-T	B	54.3/121.7
C4	4030011600	S.CER C1608 JB 1E 104K-T	B	25.4/109
C51	4030011600	S.CER C1608 JB 1E 104K-T	B	87/10
C52	4030011600	S.CER C1608 JB 1E 104K-T	B	85.8/60.1
C53	4030011600	S.CER C1608 JB 1E 104K-T	B	87.2/119.2
J1	6510022471	S.CNR 40FLT-SM2-TB (LF) (SN)	B	9/93.8
J4	6510019971	S.CNR 52808-1071	B	98/101
J5	6510019971	S.CNR 52808-1071	B	6.5/120.5
J7	6510018971	S.CNR B4B-PH-SM4-TB (LF) (SN)	B	93.7/53.6
J8	6510019971	S.CNR 52808-1071	B	97.7/12.5
DS51	5040002930	S.LED SML-512MW T86	T	91/115.6
DS52	5040002930	S.LED SML-512MW T86	T	91/95.1
DS53	5040002930	S.LED SML-512MW T86	T	91/85.6
DS54	5040002930	S.LED SML-512MW T86	T	91/76.1
S1	2260002740	S.SW LS8J2M-T	T	12/86.7
S2	2260002740	S.SW LS8J2M-T	T	12/78.7
S3	2260002740	S.SW LS8J2M-T	T	55.5/78.7
S4	2260002740	S.SW LS8J2M-T	T	34/86.7
S5	2260002740	S.SW LS8J2M-T	T	34/78.7
S6	2260002740	S.SW LS8J2M-T	T	55.5/86.7
S7	2260002740	S.SW LS8J2M-T	T	12/66.3
S8	2260002740	S.SW LS8J2M-T	T	34/67.9
S11	2260002740	S.SW LS8J2M-T	T	12.5/126.6
S12	2260002740	S.SW LS8J2M-T	T	12.5/117.1
S13	2260002740	S.SW LS8J2M-T	T	12.5/107.6
S14	2260002740	S.SW LS8J2M-T	T	12.5/98.1
S15	2260002740	S.SW LS8J2M-T	T	34/126.6
S16	2260002740	S.SW LS8J2M-T	T	34/117.1
S17	2260002740	S.SW LS8J2M-T	T	34/107.6
S18	2260002740	S.SW LS8J2M-T	T	34/98.1
S19	2260002740	S.SW LS8J2M-T	T	55.5/126.6
S20	2260002740	S.SW LS8J2M-T	T	55.5/117.1
S21	2260002740	S.SW LS8J2M-T	T	55.5/107.6
S22	2260002740	S.SW LS8J2M-T	T	55.5/98.1
S23	2260002740	S.SW LS8J2M-T	T	55.5/67.9
S24	2260002740	S.SW LS8J2M-T	T	60.4/56.5
S51	2260002740	S.SW LS8J2M-T	T	90.8/122.7
S52	2260002740	S.SW LS8J2M-T	T	90.8/111.7
S53	2260002740	S.SW LS8J2M-T	T	90.8/91.2
S54	2260002740	S.SW LS8J2M-T	T	90.8/81.7
S55	2260002740	S.SW LS8J2M-T	T	90.8/72.2
S56	2260002740	S.SW LS8J2M-T	T	90.8/55.7
S57	2260002740	S.SW LS8J2M-T	T	90.8/46.2
S58	2260002740	S.SW LS8J2M-T	T	90.8/36.7
S59	2260002740	S.SW LS8J2M-T	T	90.8/22.8
S60	2260002740	S.SW LS8J2M-T	T	90.8/4.4
S61	2260002740	S.SW LS8J2M-T	T	69.7/4.2

M.=Mounted side (T: Mounted on the Top side B: Mounted on the Bottom side)
S.=Surface mount

[PBT BOARD]

REF NO.	ORDER NO.	DESCRIPTION	M.	H/V LOCATION
R1	7210003290	VAR RV-321 (RK0972210C1K 10KB/10KB)		
R2	7030003520	S.RES ERJ3GEYJ 472 V (4.7 k)	T	12.6/12.5
R3	7030003520	S.RES ERJ3GEYJ 472 V (4.7 k)	T	11.4/12.5
C1	4030006880	S.CER C1608 JB 1H 472K-T	T	10.2/12.5
C2	4030006880	S.CER C1608 JB 1H 472K-T	T	13.8/12.5
J1	6510019971	S.CNR 52808-1071	T	7/23
S1	2250000410	ECR TP90D96E20-30F-2178-1		

[PITCH BOARD]

REF NO.	ORDER NO.	DESCRIPTION	M.	H/V LOCATION
R1	7210003170	VAR RV-318 (RK09L1120CON)		
R2	7030003520	S.RES ERJ3GEYJ 472 V (4.7 k)	T	7.8/7.5
C1	4030006880	S.CER C1608 JB 1H 472K-T	T	7.8/4.9
J1	6510019971	S.CNR 52808-1071	T	4.1/7.5

[LED BOARD]

REF NO.	ORDER NO.	DESCRIPTION	M.	H/V LOCATION
R1	7030003450	S.RES ERJ3GEYJ 122 V (1.2 k)	T	124/2.9
R2	7030003420	S.RES ERJ3GEYJ 681 V (680)	T	100/2.9
R3	7030003460	S.RES ERJ3GEYJ 152 V (1.5 k)	T	19.9/2.9
R4	7030003400	S.RES ERJ3GEYJ 471 V (470)	T	59.9/2.9
J1	6510020711	S.CNR 52793-1070 (1090)	T	24/12.2
DS1	5040003000	S.LED SML-A12UT-T86	T	124/1.3
DS2	5040002961	S.LED SML-A12MT T86J	T	100/1.3
DS3	5040003010	S.LED SML-A12WT	T	19.9/1.3
DS4	5040002970	S.LED CL-270WB-D-TS	T	59.9/1.3

M.=Mounted side (T: Mounted on the Top side B: Mounted on the Bottom side)
S.=Surface mount

SECTION 6

MECHANICAL PARTS

[FRONT UNIT] (FR)

REF NO.	ORDER NO.	DESCRIPTION	QTY.
W1†	8900017300	OPC-1838	1
W2†	8900015940	OPC-875A	1
W3†	8900015930	OPC-886A	1
W4†	8900017280	OPC-1836	1
W5†	8900014720	OPC-909A	1
W6†	8900017290	OPC-1837	1
W7†	8900017100	OPC-1825	1
W8†	8900015930	OPC-886A	1
W9†	8900014871	OPC-1332A-1	1
W10†	8900014720	OPC-909A	1
W11†	8900015930	OPC-886A	1
W12†	8900015930	OPC-886A	1
W13†	8900014871	OPC-1332A-1	1
EP1	6910015291	LTA070B790F	1
EP11	6910011090	RMS20-250-201-1P	1
EP12	0880001460	ROTARY ENCODER EX-2500 #03	1
EP101	6910015650	MOUNT PLATE (S-G2218-3#01)	1
EP102	6910015650	MOUNT PLATE (S-G2218-3#01)	1
MP1	8210024170	3009 FRONT PANEL	1
MP2	8210024180	3009 TENKEY PANEL	1
MP3	8930073070	3009 LENS HOLDER	1
MP4	8930073080	3009 A-LENS	1
MP5	8930073090	3009 B-LENS	3
MP6	8610013460	KNOB N-311 (A)	1
MP7	8610011790	KNOB N-305	1
MP8	8610013320	KNOB N-362 RING	2
MP9	8610013290	KNOB N-361	6
MP10	8610013340	KNOB N-359	6
MP11	8610013300	KNOB N-359 COVER	7
MP12	8610013350	KNOB N-360	1
MP18	8610013260	KNOB K-267	1
MP19	8610013230	KNOB K-268	1
MP20	8610013240	KNOB K-269	1
MP21	8610013490	KNOB K-270	1
MP22	8610013500	KNOB K-271	1
MP23	8610013360	KNOB K-272	1
MP24	8610013370	KNOB K-273	1
MP25	8610013400	KNOB K-274	1
MP26	8610013410	KNOB K-274 (A)	1
MP27	8610013420	KNOB K-274 (B)	1
MP28	8610013430	KNOB K-275	1
MP29	8610013440	KNOB K-275 (A)	1
MP30	8610013380	KNOB K-276	1
MP31	8610013510	KNOB K-277	1
MP32	8610013250	KNOB K-278	1
MP33	8610013390	KNOB K-279	1
MP34	8610013450	KNOB K-280	1
MP35	8310069970	3009 WINDOW PLATE	1
MP36	8010020932	3009 SUB CHASSIS-2	1
MP37	8930073040	3009 JACK PLATE	1
MP38	8930075651	3009 FRONT PLATE-1	1
MP39	8930073060	3009 VR PLATE	1
MP40	8930073100	3009 CLICK PLATE	1
MP41	8310069830	3009 NAME PLATE	1
MP42	8930073210	DOUBLE SIDE TAPE (AS)	2
MP43	8930073220	DOUBLE SIDE TAPE (AT)	2
MP45	8930061620	2590 LCD SPONGE	1
MP46	8610011830	KNOB N-301	1
MP47	8610011741	KNOB N-307-1	7
MP48	8930072990	2844 AL SHEET	1
MP49	8930061460	2590 BRAKE SPACER	1
MP50	8930061470	2590 BRAKE PLATE	1
MP51	8930061731	SPONGE (HI)-1	2
MP52	8850002010	PLAIN WASHER (AG)	1
MP53	8930061450	2590 BRAKE BUTTON	1
MP56	8810008971	OTAP 1FLAT WASHERB0 2X3.5NI-ZC3 (BT)	2
MP57	8810005701	0-SCREW PH M2X4 ZK3	2
MP58	8810008761	SCREW BT B0 2X8 NI-ZC3 (BT)	9
MP59	8810008761	SCREW BT B0 2X8 NI-ZC3 (BT)	10
MP60	8810008761	SCREW BT B0 2X8 NI-ZC3 (BT)	10
MP61	8810008761	SCREW BT B0 2X8 NI-ZC3 (BT)	4
MP62	8810008761	SCREW BT B0 2X8 NI-ZC3 (BT)	2
MP63	8810009561	SCREW BT B0 2X6 NI-ZK3 (BT)	4
MP64	8810009561	SCREW BT B0 2X6 NI-ZK3 (BT)	2
MP66	8810008661	SCREW BT B0 3X8 NI-ZC3 (BT)	11
MP67	8810008661	SCREW BT B0 3X8 NI-ZC3 (BT)	4
MP68	8810008790	SCREW M3X6 NI	18
MP69	8810008661	SCREW BT B0 3X8 NI-ZC3 (BT)	2
MP70	8810008761	SCREW BT B0 2X8 NI-ZC3 (BT)	3
MP72	8610007420	KNOB SPRING NO.6601	9
MP73	8610009240	KNOB SPRING NO.7800P	7
MP81	8930074280	SPONGE (JU)	1
MP82	8930074810	3009 D-SPONGE	3
MP83	8930074820	3009 E-SPONGE	4
MP85	8930074330	3009 KEY RUBBER	3
MP86	8930074290	INSULATION SHEET (LY)	1
MP87	8930060200	HIMELON SHEET (CJ)	2
MP88	8930074760	DOUBLE SIDE TAPE (AX)	7
MP89	8930074830	INSULATION SHEET (LZ)	2
MP90	8930062950	SHIELD SPONGE (AF)	1
MP91	8930071560	SHIELD SPONGE (BN)	1
MP92	8930075050	SHIELD TAPE (T)	1

†: Refer to "GENERAL WIRING" for the connection.

*: Refer to "BOARD LAYOUTS" for the location.

Screw abbreviations

A, B0, BT: Self-tapping PH: Pan head ZK: Black NI-ZU: Nickel-Zinc SUS: Stainless

[FRONT UNIT] (FR)

REF NO.	ORDER NO.	DESCRIPTION	QTY.
MP93	8930075040	INSULATION SHEET (MA)	1
MP94	8930075060	SHIELD TAPE (U)	1
MP95	8930043121	RUBBER SHEET (AE)-1	1
MP96	8930075170	3009 VR SPRING	1
MP97	8930017190	EARTH SPRING (F)	3
MP98	8930028840	SPONGE (DF)	2
MP99	8930028840	SPONGE (DF)	2
MP100	8930075990	AL SHEET (AP)	1

[DISPLAY BOARD] (DIS)

REF NO.	ORDER NO.	DESCRIPTION	QTY.
J1*	6510022471	40FLT-SM2-TB (LF) (SN)	1
J4*	6510020531	52808-1871	1
J5*	6510019971	52808-1071	1
J7*	6510019971	52808-1071	1
J8*	6510019971	52808-1071	1
J201*	6510022471	40FLT-SM2-TB (LF) (SN)	1
J202*	6510022471	40FLT-SM2-TB (LF) (SN)	1
J203*	6510020081	52808-2071	1
J205	6510003401	B04B-EH-S (LF) (SN)	1
J301*	6510021181	SM02 (8.0)B-BHS-1-TB (LF) (SN)	1
J601	6510021861	BH-800-4GG	1
J602*	6510020081	52808-2071	1
J603*	6510019971	52808-1071	1
J604*	6510019981	52808-1671	1
J605*	6510018961	B2B-PH-SM4-TB (LF) (SN)	1
J606*	6510022191	B3B-PH-SM4-TB (LF) (SN)	1
BT601*	3020000110	CR2032	1
T201*	5910000981	3319-T088-LF	1
MP209	8510015390	2591 REG PLATE	1
MP301	8510015390	2591 REG PLATE	1

[JACK BOARD] (JCK)

REF NO.	ORDER NO.	DESCRIPTION	QTY.
J1*	6510020711	52793-1070	1
J2*	6510023891	S-G4617#01F	1
J102*	6510023900	LGR4619-7000	1

[LED BOARD] (LED)

REF NO.	ORDER NO.	DESCRIPTION	QTY.
J1*	6510020711	52793-1070	1

[MIC BOARD] (MIC)

REF NO.	ORDER NO.	DESCRIPTION	QTY.
J1*	6510000191	FM214-8SS (P)-1	1
J2*	6510019971	52808-1071	1

[PBT BOARD] (PBT)

REF NO.	ORDER NO.	DESCRIPTION	QTY.
R1	7210003290	RV-321 (RK0972210C1K 10KB/10KB)	1
J1*	6510019971	52808-1071	1
S1	2250000410	TP90D96E20-30F-2178-1	1

[PITCH BOARD] (PIT)

REF NO.	ORDER NO.	DESCRIPTION	QTY.
R1	7210003170	RV-318	1
J1*	6510019971	52808-1071	1

[SW-A BOARD] (SWA)

REF NO.	ORDER NO.	DESCRIPTION	QTY.
J1*	6510020081	52808-2071	1
MP1	8930074270	3009 C-SPONGE	3
MP2	8930055010	RUBBER SHEET (AX)	1

[SW-B BOARD] (SWB)

REF NO.	ORDER NO.	DESCRIPTION	QTY.
J1*	6510020531	52808-1871	1

[TENKEY BOARD] (TEN)

REF NO.	ORDER NO.	DESCRIPTION	QTY.
J1*	6510022471	40FLT-SM2-TB (LF) (SN)	1
J4*	6510019971	52808-1071	1
J5*	6510019971	52808-1071	1
J7*	6510018971	B4B-PH-SM4-TB (LF) (SN)	1
J8*	6510019971	52808-1071	1

[VR-A BOARD] (VRA)

REF NO.	ORDER NO.	DESCRIPTION	QTY.
R1	7210002970	RV-314 (RK0972210 10KB/10KB)	1
R2	7210002970	RV-314 (RK0972210 10KB/10KB)	1
J103*	6510019971	52808-1071	1
J104*	6510020711	52793-1070	1
J106*	6510019981	52808-1671	1
J107*	6510025270	S6B-PH-SM4-TB (LF) (SN)	1

[VR-B BOARD] (VRB)

REF NO.	ORDER NO.	DESCRIPTION	QTY.
R1	7210002970	RV-314 (RK0972210 10KB/10KB)	1
R2	7210002970	RV-314 (RK0972210 10KB/10KB)	1
R3	7210002970	RV-314 (RK0972210 10KB/10KB)	1
J1*	6510019971	52808-1071	1

[VR-C BOARD] (VRC)

REF NO.	ORDER NO.	DESCRIPTION	QTY.
R1	7210001130	RK097111T005A 10KB	1
R2	7210001130	RK097111T005A 10KB	1
R3	7210001130	RK097111T005A 10KB	1
R4	7210001130	RK097111T005A 10KB	1
R5	7210001130	RK097111T005A 10KB	1
R6	7210001130	RK097111T005A 10KB	1
R7	7210001130	RK097111T005A 10KB	1
J1*	6510019971	52808-1071	1

[USB BOARD] (USB)

REF NO.	ORDER NO.	DESCRIPTION	QTY.
J106*	6510019971	52808-1071	1
J107	6510026080	XM7A-0441	1
J108	6510026080	XM7A-0441	1
J109:*	6510022031	B10B-ZR-SM4-TF (LF) (SN)	1

*: Refer to "BOARD LAYOUTS" for the location.

†: Refer to "GENERAL WIRING" for the connection.

• OVERALL

UNIT ABBREVIATIONS:

FR: FRONT UNIT
 CH: CHASSIS
 MAN: MAIN UNIT
 LG: LOGIC UNIT
 DIS: DISPLAY BOARD
 JCK: JACK BOARD
 LED: BOARD
 MIC: MIC BOARD
 PBT: PBT BOARD
 PIT: PITCH BOARD
 TUN: TUNER UNIT
 ANT: ANT-SW BOARD
 CTL: CTRL BOARD
 DCD: DC-DC UNIT
 DGL: DIGISEL UNIT
 FIL: FILTER UNIT
 NET: NETWORK BOARD
 PA: PA UNIT
 PA2: PA200W BOARD
 PLL: PLL UNIT
 REG: REG UNIT
 RF: RF UNIT
 SCP: SCOPE UNIT

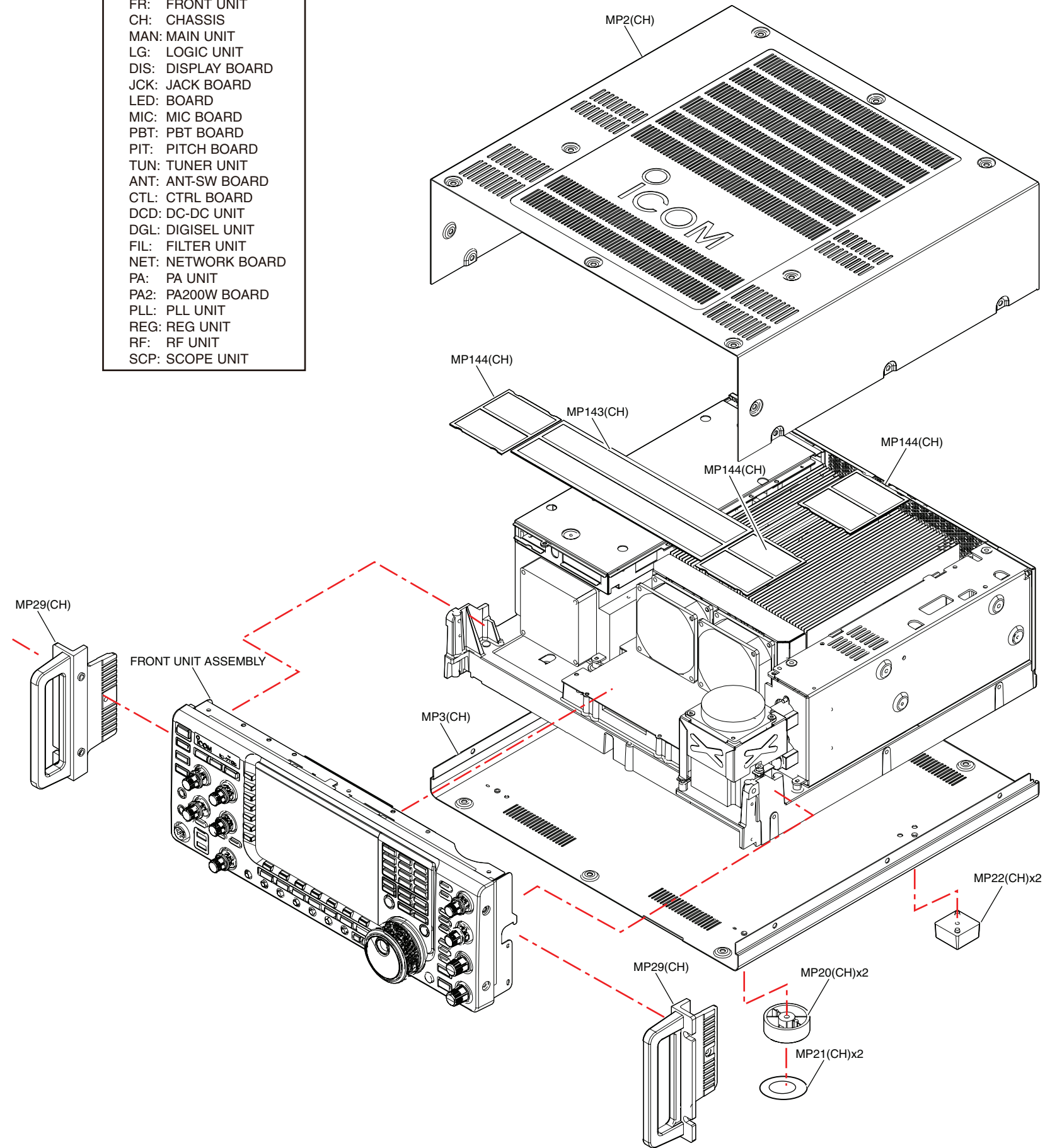

• FRONT UNIT

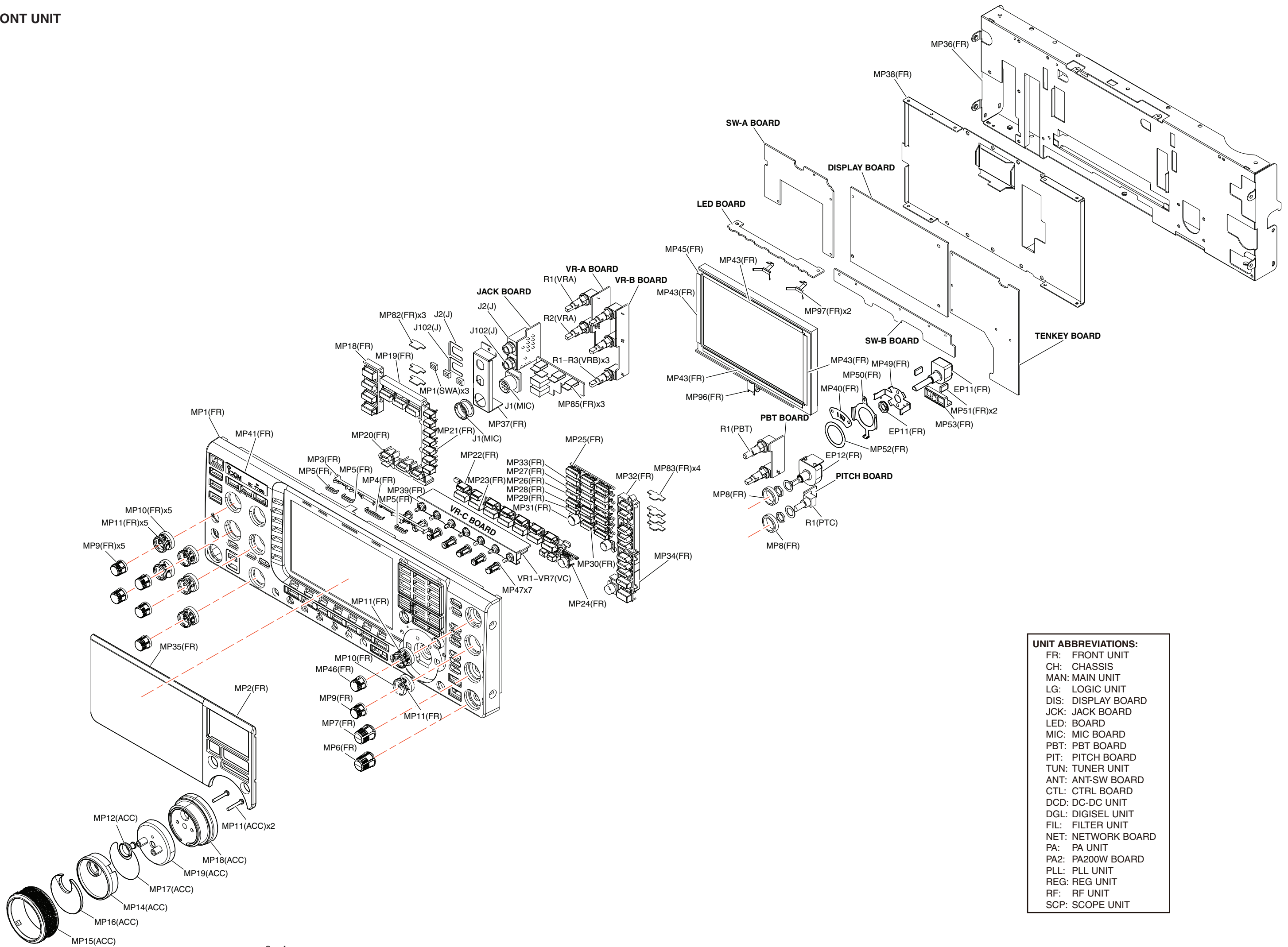

UNIT ABBREVIATIONS:

FR:	FRONT UNIT
CH:	CHASSIS
MAN:	MAIN UNIT
LG:	LOGIC UNIT
DIS:	DISPLAY BOARD
JCK:	JACK BOARD
LED:	BOARD
MIC:	MIC BOARD
PBT:	PBT BOARD
PIT:	PITCH BOARD
TUN:	TUNER UNIT
ANT:	ANT-SW BOARD
CTL:	CTRL BOARD
DCD:	DC-DC UNIT
DGL:	DIGISEL UNIT
FIL:	FILTER UNIT
NET:	NETWORK BOARD
PA:	PA UNIT
PA2:	PA200W BOARD
PLL:	PLL UNIT
REG:	REG UNIT
RF:	RF UNIT
SCP:	SCOPE UNIT

[CHASSIS PARTS] (CH)

REF NO.	ORDER NO.	DESCRIPTION	QTY.
P111*	6510003240	TMP-P01X-A1	1
P112*	6510003240	TMP-P01X-A1	1
P115*	6510003240	TMP-P01X-A1	1
P116*	6510003240	TMP-P01X-A1	1
P117*	6510003240	TMP-P01X-A1	1
P118*	6510003240	TMP-P01X-A1	1
P119*	6510003240	TMP-P01X-A1	1
P120*	6510003240	TMP-P01X-A1	1
P121*	6510003240	TMP-P01X-A1	1
P122*	6510003240	TMP-P01X-A1	1
P123*	6510003240	TMP-P01X-A1	1
P124*	6510003240	TMP-P01X-A1	1
P131*	6510003240	TMP-P01X-A1	1
P132*	6510003240	TMP-P01X-A1	1
P134*	6510003240	TMP-P01X-A1	1
P135*	6510003240	TMP-P01X-A1	1
P136*	6510003240	TMP-P01X-A1	1
P137*	6510003240	TMP-P01X-A1	1
P138*	6510003240	TMP-P01X-A1	1
P139*	6510003240	TMP-P01X-A1	1
P140*	6510003240	TMP-P01X-A1	1
P141*	6510003240	TMP-P01X-A1	1
P201*	6510019130	PHR-8	1
P202*	6510019130	PHR-8	1
P211*	6510018990	PHR-4	1
P212*	6510020280	PHR-9	1
P213*	6510019010	PHR-13	1
P231*	5610000490	PHR-6	1
P232*	5610000490	PHR-6	1
P241*	6510003630	EHR-03	1
P242*	6510003640	EHR-04	1
P243*	6510019000	PHR-7	1
P251*	5610000350	PHR-10	1
P252*	5610000350	PHR-10	1
P261*	6510020280	PHR-9	1
P262*	6510020280	PHR-9	1
P301*	6510009600	ZHR-4	1
P302*	6510009600	ZHR-4	1
P331*	5610000490	PHR-6	1
P332*	5610000490	PHR-6	1
P341*	5610000490	PHR-6	1
P342*	6510019130	PHR-8	1
P343*	6510020750	PHR-3	1
P381*	6510009660	ZHR-10	1
P382*	6510009660	ZHR-10	1
SP1	2510001390	2844 SP BOX	1
W1†	8900015500	OPC-1113A	1
W2†	8900017320	OPC-1840	1
W3†	8900017270	OPC-1835	1
W4†	8900017330	OPC-1841	1
W5†	8900017510	OPC-1851	1
W6†	8900015120	OPC-942B	1
W7†	8900017080	OPC-1806	1
W8†	8900017240	OPC-1832	1
W9†	8900017250	OPC-1833	1
W10†	8900017110	OPC-1814	1
W11†	8900017310	OPC-1839	1
W12†	8900017090	OPC-1826	1
W101†	8900013031	OPC-1346R	1
W102†	8900013041	OPC-1347R	1
W103†	8900013051	OPC-1348R	1
W111†	9025900220	62/99/300/C31/C31	1
W112†	9086700300	WIRE 8	1
W113†	9030090320	OPC-1859	1
W115†	9025900590	62/99/360/C31/C31	1
W116†	9086700300	WIRE 8	1
W117†	9025900590	62/99/360/C31/C31	1
W118†	9086700300	WIRE 8	1
W119†	9025900590	62/99/360/C31/C31	1
W120†	9086700300	WIRE 8	1
W121†	9025900620	62/99/510/C31/C31	1
W122†	9086700300	WIRE 8	1
W123†	9025900620	62/99/510/C31/C31	1
W124†	9086700300	WIRE 8	1
W125†	9030090310	OPC-1850	1
W127†	9030090330	OPC-1860	1
W129†	9030090450	OPC-1881	1
W131†	9025900590	62/99/360/C31/C31	1
W132†	9086700300	WIRE 8	1
W133†	9030090160	OPC-1804	1
W134†	9025900280	62/99/600/C31/C31	1
W135†	9086700300	WIRE 8	1
W136†	9025900110	62/99/300/C31/C31	1
W137†	9086700300	WIRE 8	1
W138†	9025900110	62/99/300/C31/C31	1
W139†	9086700300	WIRE 8	1
W140†	9025900210	62/99/450/C31/C31	1
W141†	9086700300	WIRE 8	1
W201†	9030090350	17/02/470/B11/B11	1
W202†	9030090350	17/02/470/B11/B11	1
W203†	9030090350	17/02/470/B11/B11	1
W204†	9030090350	17/02/470/B11/B11	1
W205†	9030090350	17/02/470/B11/B11	1
W206†	9030090360	15/09/470/B11/B11	1
W207†	9030090360	15/09/470/B11/B11	1
W208†	9030090350	17/02/470/B11/B11	1
W211†	9030090280	17/01/490/B11/B11	1
W212†	9030090280	17/01/490/B11/B11	1
W213†	9030090280	17/01/490/B11/B11	1
W214†	9030090280	17/01/490/B11/B11	1
W221†	9030090370	17/03/430/B11/B11	1

*: Refer to "BOARD LAYOUTS" for the location.

†: Refer to "GENERAL WIRING" for the connection.

[CHASSIS PARTS] (CH)

REF NO.	ORDER NO.	DESCRIPTION	QTY.
W222†	9030090370	17/03/430/B11/B11	1
W223†	9030090370	17/03/430/B11/B11	1
W224†	9030090370	17/03/430/B11/B11	1
W225†	9030090370	17/03/430/B11/B11	1
W226†	9030090370	17/03/430/B11/B11	1
W227†	9030090370	17/03/430/B11/B11	1
W228†	9030090370	17/03/430/B11/B11	1
W229†	9030090370	17/03/430/B11/B11	1
W231†	9030090410	17/06/360/B11/B11	1
W232†	9030090410	17/06/360/B11/B11	1
W233†	9030090410	17/06/360/B11/B11	1
W234†	9030090420	15/09/360/B11/B11	1
W235†	9030090410	17/06/360/B11/B11	1
W236†	9030090410	17/06/360/B11/B11	1
W241†	9030090430	17/07/250/B06/B11	1
W242†	9030090430	17/07/250/B06/B11	1
W243†	9030090430	17/07/250/B06/B11	1
W244†	9030090440	17/10/180/B06/B11	1
W245†	9030090440	17/10/180/B06/B11	1
W246†	9030090440	17/10/180/B06/B11	1
W247†	9030090440	17/10/180/B06/B11	1
W251†	9030090190	17/04/600/B11/B11	1
W252†	9030090190	17/04/600/B11/B11	1
W253†	9030090190	17/04/600/B11/B11	1
W254†	9030090190	17/04/600/B11/B11	1
W255†	9030090190	17/04/600/B11/B11	1
W256†	9030090190	17/04/600/B11/B11	1
W257†	9030090190	17/04/600/B11/B11	1
W258†	9030090190	17/04/600/B11/B11	1
W259†	9030090190	17/04/600/B11/B11	1
W261†	9030090180	15/05/600/B11/B11	1
W262†	9030090180	15/05/600/B11/B11	1
W263†	9030090180	15/05/600/B11/B11	1
W264†	9030090180	15/05/600/B11/B11	1
W265†	9030090180	15/05/600/B11/B11	1
W266†	9030090180	15/05/600/B11/B11	1
W267†	9030090180	15/05/600/B11/B11	1
W268†	9030090180	15/05/600/B11/B11	1
W269†	9030090180	15/05/600/B11/B11	1
W271†	9030090341	OPC-1861A	1
W301†	9030090290	51/99/360/B09A/B09A	1
W302†	9086400440	WIRE 08 A A	1
W303†	9030090290	51/99/360/B09A/B09A	1
W304†	9086400440	WIRE 08 A A	1
W311†	9030090120	OPC-1800	1
W321†	9030090130	OPC-1801	1
W331†	9030090260	17/01/370/B11/B11	1
W332†	9030090250	17/02/370/B11/B11	1
W333†	9030090240	17/03/370/B11/B11	1
W334†	9030090230	17/04/370/B11/B11	1
W335†	9030090220	17/05/370/B11/B11	1
W336†	9030090380	17/06/370/B11/B11	1
W341†	9030090390	51/99/730/B11A/B11A	1
W342†	9086400440	WIRE 08 A A	1
W343†	9030090390	51/99/730/B11A/B11A	1
W344†	9086400440	WIRE 08 A A	1
W345†	9030090390	51/99/730/B11A/B11A	1
W346†	9086400440	WIRE 08 A A	1
W347†	9030090400	51/99/640/B11A/B11A	1
W348†	9086400440	WIRE 08 A A	1
W351†	9030090140	OPC-1802	1
W371†	8900013060	OPC-1349	1
W381†	9025900300	23/01/070/B09/B09	1
W382†	9025900310	23/02/070/B09/B09	1
W383†	9025900320	23/03/070/B09/B09	1
W384†	9025900330	23/04/070/B09/B09	1
W385†	9025900340	23/05/070/B09/B09	1
W386†	9025900350	23/06/070/B09/B09	1
W387†	9025900360	23/07/070/B09/B09	1
W388†	9025900370	23WIRE /08/070/B09/B09	1
W389†	9025900380	23/09/070/B09/B09	1
W390†	9025900390	23/00/070/B09/B09	1
EP5	6910011941	ZCAT2436-1330A (-BK)	1
MP1	8010020910	3009 CHASSIS	1
MP2	8110009271	3009 U-COVER-1	1
MP3	8110009281	3009 L-COVER-1	1
MP4	8210024160	3009 REAR PANEL	1
MP5	8930074920	3009 A-SP ANGLE	1
MP6	8510018430	3009 DC-DC COVER	1
MP7	8930073120	3009 RF CONNECTOR ANGLE	1
MP8	8510018490	3009 RF COVER	1
MP9	8930073130	3009 MAIN CONNECTOR ANGLE	1
MP10	8510018440	3009 LOGIC CASE	1
MP11	8510018450	3009 LOGIC COVER	1
MP12	8510018500	3009 SCOPE PLATE	1
MP13	8510018510	3009 RF PLATE	1
MP14	8510018520	3009 A-RF PLATE	1
MP15	8510018530	3009 OSC PLATE	1
MP16	8510018480	3009 PLL COVER	1
MP19	8930061281	2590 ANT ANGLE-1	1
MP20	8930061350	2590 MAIN STAND	2
MP21	8930061840	2590 A-STAND SHEET	2
MP22	8930011680	RUBBER REG (G)	2
MP23	8510016281	2590 K-PLATE-1	1
MP24	8930056160	DOUBLESIDED TAPE (AG)	4
MP25	8510015851	2590 FILTER CASE-1	1
MP26	8930062770	HIMELON SHEET (CN)	1
MP29	8930073801	RACK MOUNT ANGLE (B)-1	2
MP101	8810008451	SCREW BIH M4X8 ZK3	14
MP102	8810008451	SCREW BIH M4X8 ZK3	7
MP103	8810008451	SCREW BIH M4X8 ZK3	4

[CHASSIS PARTS] (CH)

REF NO.	ORDER NO.	DESCRIPTION	QTY.
MP104	8810008451	SCREW BiH M4X8 ZK3	4
MP105	8810008451	SCREW BiH M4X8 ZK3	2
MP106	8810000391	SCREW PH M4X12 ZC3	2
MP107	8830000360	PAIRNUT M5 NI	1
MP108	8850000150	FLAT WASHER M5 BS NI	2
MP109	8810009991	SCREW BT B0 3X8 NI-ZK3 (BT)	1
MP110	8810005771	SCREW BiH M3X8 ZK3	2
MP111	8810005771	SCREW BiH M3X8 ZK3	4
MP112	8810005771	SCREW BiH M3X8 ZK3	3
MP113	8810005771	SCREW BiH M3X8 ZK3	8
MP114	8810008661	SCREW BT B0 3X8 NI-ZC3 (BT)	2
MP115	8810008661	SCREW BT B0 3X8 NI-ZC3 (BT)	4
MP116	8810008661	SCREW BT B0 3X8 NI-ZC3 (BT)	2
MP117	8810009061	SCREW M3X6 ZK3	4
MP118	8810009311	SCREW FLAT B0 3X6 NI-ZC3 (BT)	4
MP119	8810009311	SCREW FLAT B0 3X6 NI-ZC3 (BT)	4
MP120	8810009311	SCREW FLAT B0 3X6 NI-ZC3 (BT)	11
MP121	8810008661	SCREW BT B0 3X8 NI-ZC3 (BT)	10
MP122	8810008661	SCREW BT B0 3X8 NI-ZC3 (BT)	8
MP123	8810009391	SCREW BT B0 3X18NI-ZC3 (BT)	3
MP124	8810008661	SCREW BT B0 3X8 NI-ZC3 (BT)	2
MP125	8810008661	SCREW BT B0 3X8 NI-ZC3 (BT)	4
MP126	8810008661	SCREW BT B0 3X8 NI-ZC3 (BT)	2
MP127	8810008661	SCREW BT B0 3X8 NI-ZC3 (BT)	14
MP128	8810008631	SCREW BT B0 3X6 NI-ZC3 (BT)	8
MP129	8810008631	SCREW BT B0 3X6 NI-ZC3 (BT)	11
MP130	8810008661	SCREW BT B0 3X8 NI-ZC3 (BT)	6
MP131	8810008661	SCREW BT B0 3X8 NI-ZC3 (BT)	7
MP132	8810007231	SETSCREW (H) 3X8 ZC3	4
MP133	8810008661	SCREW BT B0 3X8 NI-ZC3 (BT)	7
MP134	8930040720	1768 B-CLIP	1
MP135	8810008661	SCREW BT B0 3X8 NI-ZC3 (BT)	9
MP136	8930020860	IC-HOLDER (FX-969)	2
MP137	8810008661	SCREW BT B0 3X8 NI-ZC3 (BT)	9
MP138	8810008661	SCREW BT B0 3X8 NI-ZC3 (BT)	6
MP139	8810008661	SCREW BT B0 3X8 NI-ZC3 (BT)	4
MP140	8950003640	COATING CLIP CS-2	4
MP141	8810008661	SCREW BT B0 3X8 NI-ZC3 (BT)	1
MP142	8930056160	DOUBLESIDED TAPE (AG)	1
MP143	8930073240	3009 A-NET	1
MP144	8930073250	3009 B-NET	3
MP145	8930071680	ANP-1D	3
MP146	8930058170	SHIELD SPONGE (O)	1
MP149	8930073900	3009 SPACER	3
MP150	8930075530	2590 RUBBER (A)	3
MP151	8930068760	2590 MAGNETIC SHIELD	1
MP152	8860001460	3009 EARTH PLATE	1
MP153	8860001460	3009 EARTH PLATE	1
MP154	8810006111	SCREW ROUND FLAT M4X9 ZK3	4
MP155	8810010281	SCREW ROUND FLAT M4X15 ZK3	2
MP156	8930058170	SHIELD SPONGE (O)	1
MP157	8930071890	SHIELD SPONGE (BT)	1
MP158	8930071890	SHIELD SPONGE (BT)	1
MP159	8930071890	SHIELD SPONGE (BT)	1
MP160	8930074770	3009 DC-DC SPRING	1
MP161	8930074550	SPONGE (JT)	1
MP162	8930015640	CODE HOLDER (SX-713)	1
MP163	8860001460	3009 EARTH PLATE	1
MP164	8930071550	SHIELD SPONGE (BM)	1
MP165	8930071550	SHIELD SPONGE (BM)	1
MP166	8860001460	3009 EARTH PLATE	1
MP171	8930048121	SHIELD TAPE (A)-1	1
MP172	8930048961	SHIELD TAPE (B)-1	1
MP173	8930049131	SHIELD TAPE (D)-1	1
MP174	8930048121	SHIELD TAPE (A)-1	1
MP175	8930048961	SHIELD TAPE (B)-1	1
MP176	8930048971	SHIELD TAPE (C)-1	1
MP177	8930049131	SHIELD TAPE (D)-1	1
MP178	8930049131	SHIELD TAPE (D)-1	1
MP179	8930049131	SHIELD TAPE (D)-1	2
MP180	8930074740	SHIELD SPONGE (CE)	4
MP181	8930074750	FERRITE SHEET (V)	1
MP185	8930071810	SPONGE (JK)	1
MP186	8930071810	SPONGE (JK)	1
MP187	8930074910	SPONGE (JZ)	4
MP188	8930006960	SPONGE (Y)	2
MP189	8930073230	RUBBER SHEET (BZ)	2
MP190	8930006960	SPONGE (Y)	3
MP191	8930060310	SHIELD TAPE (P)	2
MP192	8930049131	SHIELD TAPE (D)-1	1
MP193	8850001710	SEALING WASHER (R)	4
MP194	8930039620	LEG CUSHION (A)	2

• CHASSIS (TOP SIDE)

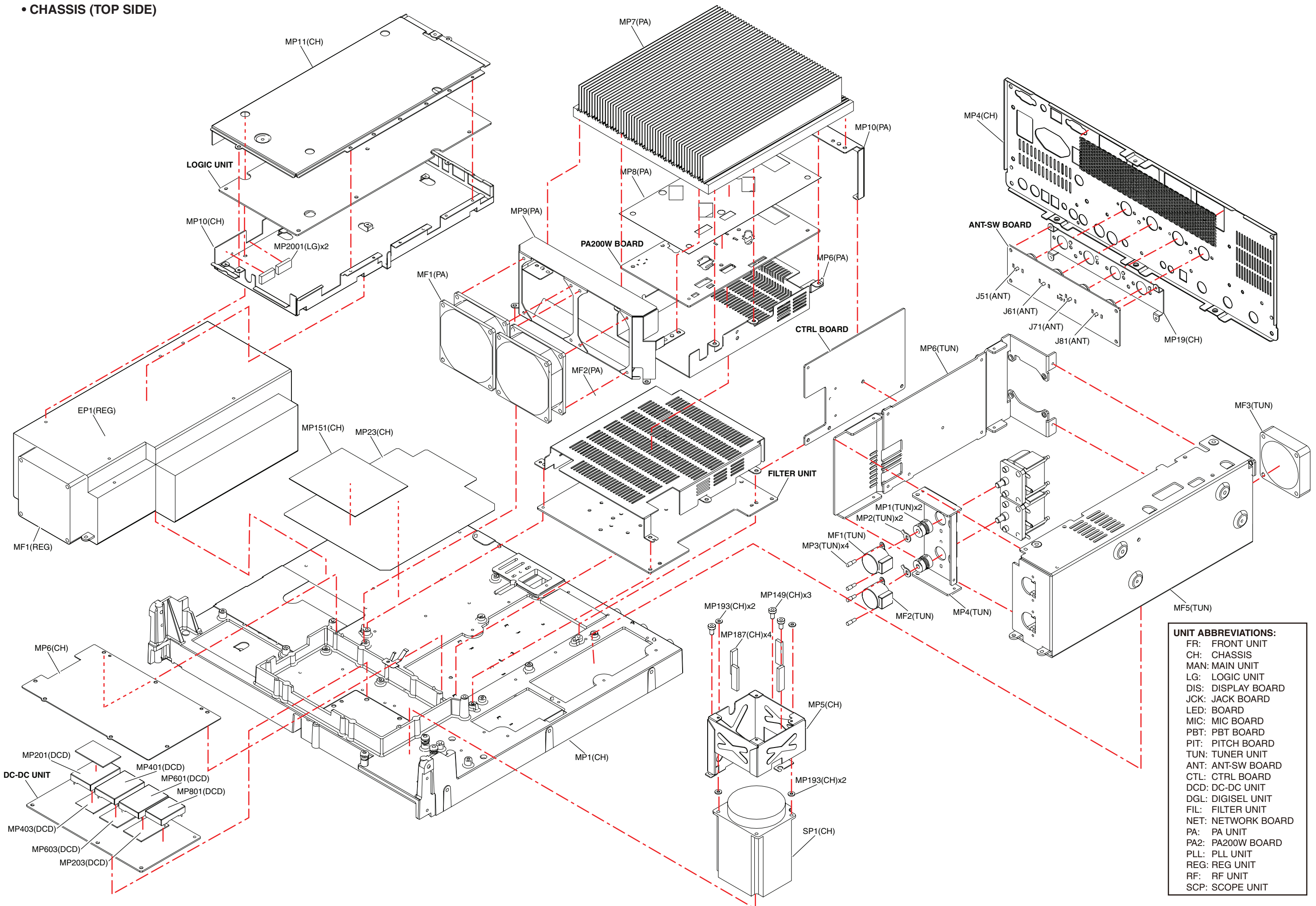

UNIT ABBREVIATIONS:

FR:	FRONT UNIT
CH:	CHASSIS
MAN:	MAIN UNIT
LG:	LOGIC UNIT
DIS:	DISPLAY BOARD
JCK:	JACK BOARD
LED:	BOARD
MIC:	MIC BOARD
PBT:	PBT BOARD
PIT:	PITCH BOARD
TUN:	TUNER UNIT
ANT:	ANT-SW BOARD
CTL:	CTRL BOARD
DCD:	DC-DC UNIT
DGL:	DIGISEL UNIT
FIL:	FILTER UNIT
NET:	NETWORK BOARD
PA:	PA UNIT
PA2:	PA200W BOARD
PLL:	PLL UNIT
REG:	REG UNIT
RF:	RF UNIT
SCP:	SCOPE UNIT

• CHASSIS (BOTTOM SIDE)

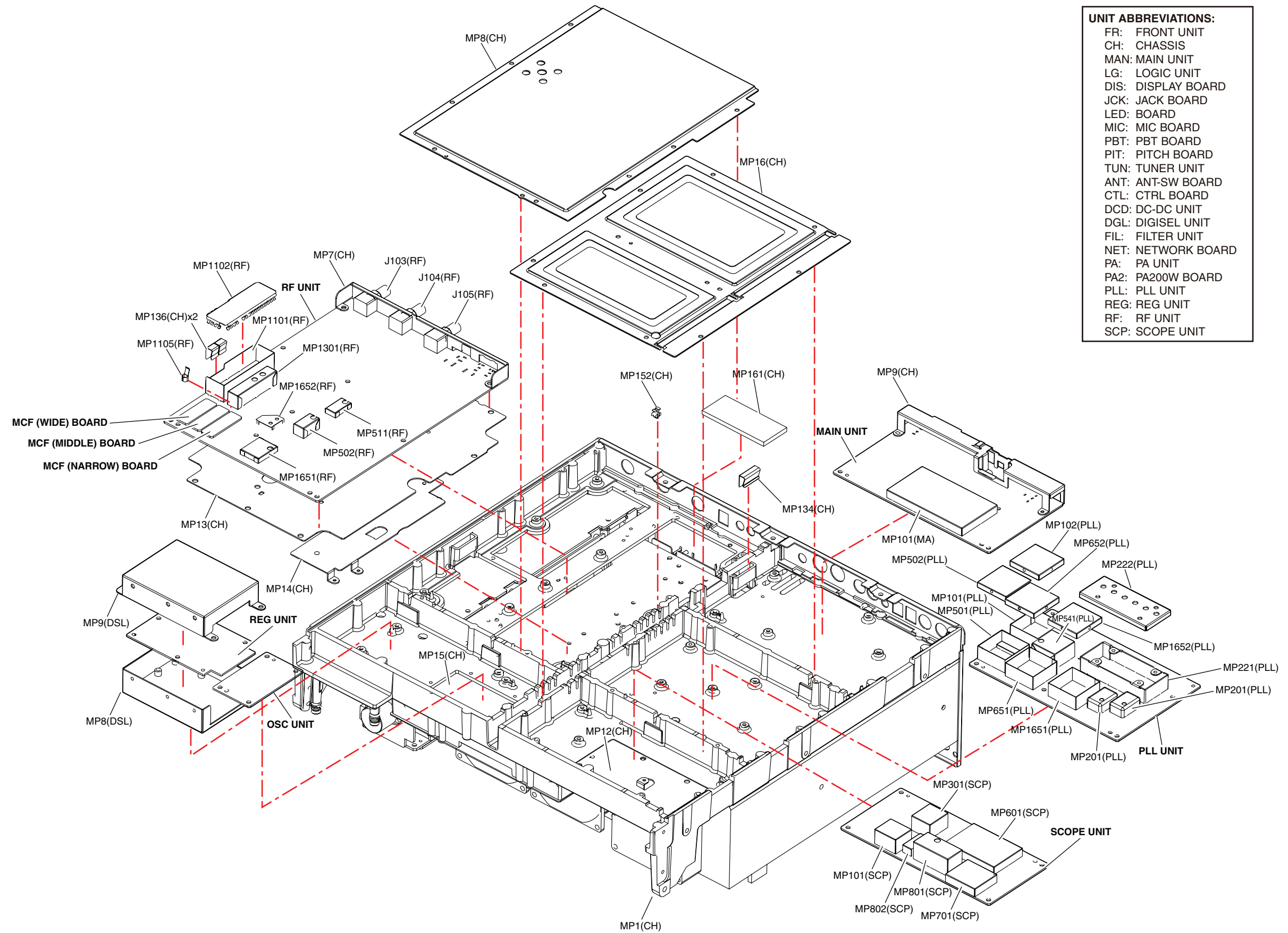

[ANT-SW BOARD] (ANT)

REF NO.	ORDER NO.	DESCRIPTION	QTY.
J1*	6510017930	1771P145-20	1
J3*	6510007020	TMP-J01X-V6	1
J4*	6510019971	52808-1071	1
J51*	6510000410	MR-DSE-02	1
J61*	6510000410	MR-DSE-02	1
J71*	6510000410	MR-DSE-02	1
J81*	6510000410	MR-DSE-02	1

[CTRL BOARD] (CTR)

REF NO.	ORDER NO.	DESCRIPTION	QTY.
CP1*	6910009670	HK3-S-T	1
CP101*	6910009670	HK3-S-T	1
J1*	6510023771	52793-2470	1
J2*	6510023761	S10B-PH-SM4-TB (LF) (SN)	1
J51*	6510023771	52793-2470	1
J52*	6510022031	B10B-ZR-SM4-TF (LF) (SN)	1
J53*	6510021431	S8B-ZR-SM4A-TF (LF) (SN)	1
J101*	6510017920	1811P342	1
J251*	6510017920	1811P342	1
J252*	6510017920	1811P342	1
J301*	6510017920	1811P342	1
J351*	6510007020	TMP-J01X-V6	1
W1	9029804001	72/99/040/X98/X98	1
EP1	9040902903	IRRAX D=0.7 L=22MM	1
MP1	8510015760	2590 A-CTRL CASE	1
MP2	8930014140	EARTH SPRING (D)	1
MP3	8930048681	INSULATION PIPE (K)-1	1
MP4	8930048681	INSULATION PIPE (K)-1	1
MP5	8930048681	INSULATION PIPE (K)-1	1
MP6	8930048681	INSULATION PIPE (K)-1	1
MP7	8930014140	EARTH SPRING (D)	1

[DC-DC UNIT] (DCD)

REF NO.	ORDER NO.	DESCRIPTION	QTY.
J1*	6510022801	B10B-PH-SM4-TB (LF) (SN)	1
J2*	6510020251	B9B-PH-SM4-TB (LF) (SN)	1
J3*	6510018941	B13B-PH-SM4-TB (LF) (SN)	1
J5*	6510018951	B7B-PH-SM4-TB (LF) (SN)	1
J6*	6510023261	B6B-PH-SM4-TB (LF) (SN)	1
J7*	6510018921	B8B-PH-SM4-TB (LF) (SN)	1
J8*	6510018971	B4B-PH-SM4-TB (LF) (SN)	1
W1†	9030090150	OPC-1803	1
MP201	8510015720	2590 DC-DC A-CASE	1
MP203	8930074750	FERRITE SHEET (V)	1
MP401	8510015720	2590 DC-DC A-CASE	1
MP403	8930074750	FERRITE SHEET (V)	1
MP601	8510015720	2590 DC-DC A-CASE	1
MP603	8930074750	FERRITE SHEET (V)	1
MP801	8510015740	2590 DC-DC B-CASE	1

[DIGISEL UNIT] (DSL)

REF NO.	ORDER NO.	DESCRIPTION	QTY.
J1*	6510007020	TMP-J01X-V6	1
J2*	6510007020	TMP-J01X-V6	1
J11*	6510009870	PD054-02M	1
J12*	6510009870	PD054-02M	1
J2017*	6510019971	52808-1071	1
J2018*	6510003391	B03B-EH-S (LF) (SN)	1
W11†	9030090110	61/99/070/D33D/D33D	1
W12†	9011130220	WIRE 08 DD	1
MP1	8930062740	2590 M-SPRING	1
MP2	8930062740	2590 M-SPRING	1
MP3	8930062740	2590 M-SPRING	1
MP4	8930062740	2590 M-SPRING	1
MP5	8930062740	2590 M-SPRING	1
MP8	8510018460	3009 DIGISEL CASE	1
MP9	8510018470	3009 DIGISEL COVER	1
MP14	8810007231	SETSCREW (H) 3X8 ZC3	7
MP15	8810007231	SETSCREW (H) 3X8 ZC3	6

[FILTER UNIT] (FIL)

REF NO.	ORDER NO.	DESCRIPTION	QTY.
J901*	6510017930	1771P145-20	1
J902*	6510022031	B10B-ZR-SM4-TF (LF) (SN)	1
J903*	6510019971	52808-1071	1
J904*	6510017930	1771P145-20	1
J905*	6510019421	B8B-ZR-SM4-TF (LF) (SN)	1

[LOGIC UNIT] (LG)

REF NO.	ORDER NO.	DESCRIPTION	QTY.
J1*	6510022490	AXK5S30045P	1
J2*	6510019870	AXK5S40045P	1
J52*	6510023261	B6B-PH-SM4-TB (LF) (SN)	1
J102*	6510019981	52808-1671	1
J602*	6510019971	52808-1071	1
J604*	6510019971	52808-1071	1
J804*	6510022031	B10B-ZR-SM4-TF (LF) (SN)	1
J805*	6510020081	52808-2071	1
J806*	6510022471	40FLT-SM2-TB (LF) (SN)	1
J808*	6510020001	52808-3071	1
J809*	6510020001	52808-3071	1
J810*	6510020251	B9B-PH-SM4-TB (LF) (SN)	1
J811*	6510021561	52808-2470	1
J813*	6510019991	52808-2271	1
J814*	6510019981	52808-1671	1
J816*	6510019981	52808-1671	1
J820*	6510022801	B10B-PH-SM4-TB (LF) (SN)	1
J821*	6510020251	B9B-PH-SM4-TB (LF) (SN)	1
J824*	6510018971	B4B-PH-SM4-TB (LF) (SN)	1
J826*	6510015541	B4B-ZR-SM4-TF (LF) (SN)	1
J2001*	6510023720	LG56501-0600C	1
J2052*	6510023120	CD6109SA1J0	1
J2101*	6510024040	TM11R-5M2-88-LP	1
J2201*	6450001941	KEY-15S-2A3A (LF) (SN)	1
MP201	8930065740	2590 D-EARTH SPRING	1
MP2001	8930049470	RUBBER SHEET (AS)	2
MP2051	8850001860	FLAT WASHER M3 SUS 3X6X0.5	2
MP2052	8850000420	S-WASHER M3 NI	2

[MEMORY BOARD] (MEM)

REF NO.	ORDER NO.	DESCRIPTION	QTY.
J1*	6510024410	AXK6S30545	1
J2*	6510020120	AXK6S40545P	1
MP1	8930025070	SPONGE (CW)	1
MP2	8930025070	SPONGE (CW)	1
MP3	8930063720	AL SHEET (AN)	1

[NETWORK BOARD] (NET)

REF NO.	ORDER NO.	DESCRIPTION	QTY.
J1*	6510021561	52808-2470	1
J2*	6510017930	1771P145-20	1
J3*	6510017930	1771P145-20	1
J4*	6510003521	S04B-EH-S (LF) (SN)	1
MP1	8510011480	1900 AL COVER	1

[OSC UNIT] (OSC)

REF NO.	ORDER NO.	DESCRIPTION	QTY.
J1071*	6510007020	TMP-J01X-V6	1
J1072*	6510007020	TMP-J01X-V6	1
J2016*	6510020091	52808-0871	1
J2017*	6510003401	B04B-EH-S (LF) (SN)	1

[PA UNIT] (PA)

REF NO.	ORDER NO.	DESCRIPTION	QTY.
P2*	6510018990	PHR-4	1
P3*	5610000500	179228-3	1
P4*	5610000500	179228-3	1
MF1	2710000860	FBA08A12H	1
MF2	2710000860	FBA08A12H	1
W1†	8900012790	OPC-1299	1
W2†	9030090030	16/00/320/B11/V05	1
W3†	9030090030	16/00/320/B11/V05	1
W4†	9030090040	16WIRE /08/400/B11/V05	1
W5†	9030090040	16WIRE /08/400/B11/V05	1
MP1	8820000551	CAP BOLTM4X8 ZK3	8
MP2	8930047252	1900 SPACER-2	7
MP6	8510015991	2590 PA COVER-1	1
MP7	8410002550	2590 PA HEATSINK	1
MP8	8930062121	2590 PA SHEET-1	1
MP9	8930073140	3009 PA ANGLE	1
MP10	8930061221	2590 R-PA ANGLE-1	1
MP12	8930062210	THERMALLY SHEET (AL)	1
MP13	8810009040	SETSCREW (H) 2.6X10 NI	6
MP14	8810007231	SETSCREW (H) 3X8 ZC3	10
MP15	8810008661	SCREW BT B0 3X8 NI-ZC3 (BT)	8
MP16	8810008661	SCREW BT B0 3X8 NI-ZC3 (BT)	5
MP20	8930063150	THERMALLY SHEET (AR)	2
MP21	8950003640	COATING CLIP CS-2	2

*: Refer to "BOARD LAYOUTS" for the location.

†: Refer to "GENERAL WIRING" for the connection.

[PA200W BOARD] (PA2)

REF NO.	ORDER NO.	DESCRIPTION	QTY.
J1*	6510007020	TMP-J01X-V6	1
J2*	6510023261	B6B-PH-SM4-TB (LF) (SN)	1
J5*	6510020421	S4B-PH-SM4-TB (LF) (SN)	1
J401*	6510017920	1811P342	1
J402*	6910001040	IPS-1136	1
W401†	9025900670	23/05/060/B21/W07	1
W501†	9040401001	74/98/050/X98/X98	1
EP501	6910011330	OT-009 M3	1
EP502	6910011330	OT-009 M3	1

[PLL UNIT] (PLL)

REF NO.	ORDER NO.	DESCRIPTION	QTY.
J31*	6510007020	TMP-J01X-V6	1
J351*	6510007020	TMP-J01X-V6	1
J561*	6510007020	TMP-J01X-V6	1
J601*	6510007020	TMP-J01X-V6	1
J681*	6510007020	TMP-J01X-V6	1
J831*	6510007020	TMP-J01X-V6	1
J1601*	6510007020	TMP-J01X-V6	1
J1681*	6510007020	TMP-J01X-V6	1
J2018*	6510019981	52808-1671	1
J2019*	6510018971	B4B-PH-SM4-TB (LF) (SN)	1
MP1	8930074860	RUBBER SHEET (CA)	5
MP101	8510010760	1876 DDS CASE	1
MP102	8510010770	1876 DDS COVER	1
MP201	8510013510	2355 VCO CASE	1
MP221	8510018760	3009 VCO CASE	1
MP222	8510015790	2590 VCO COVER	1
MP223	8810007231	SETSCREW (H) 3X8 ZC3	4
MP224	8930062300	RUBBER SHEET (BI)	1
MP501	8510010760	1876 DDS CASE	1
MP502	8510010770	1876 DDS COVER	1
MP541	8510018770	3009 PLL CASE	1
MP561	8930065740	2590 D-EARTH SPRING	1
MP601	8930065740	2590 D-EARTH SPRING	1
MP651	8510010760	1876 DDS CASE	1
MP652	8510010770	1876 DDS COVER	1
MP653	8510010850	1897 D/A CASE	1
MP821	8510015800	2590 2LO CASE	1
MP1651	8510010760	1876 DDS CASE	1
MP1652	8510010770	1876 DDS COVER	1
MP1653	8510010850	1897 D/A CASE	1

[REG UNIT] (REG)

REF NO.	ORDER NO.	DESCRIPTION	QTY.
MF1	2710000520	SB0812H-ICOM-00	1
EP1	6910016052	FP2212B-2	1
	6910016062	FP2212C-2	1

*: Refer to "BOARD LAYOUTS" for the location.
 †: Refer to "GENERAL WIRING" for the connection.

[RF UNIT] (RF)

REF NO.	ORDER NO.	DESCRIPTION	QTY.
J101*	6510007020	TMP-J01X-V6	1
J102*	6510007020	TMP-J01X-V6	1
J103*	6510023750	01K1971-10	1
J104*	6510023750	01K1971-10	1
J105*	6510023750	01K1971-10	1
J106*	6510007020	TMP-J01X-V6	1
J108*	6510007020	TMP-J01X-V6	1
J351*	6510007020	TMP-J01X-V6	1
J352*	6510007020	TMP-J01X-V6	1
J391*	6510007020	TMP-J01X-V6	1
J501*	6510007020	TMP-J01X-V6	1
J502*	6510007020	TMP-J01X-V6	1
J503*	6510007020	TMP-J01X-V6	1
J801*	6510007020	TMP-J01X-V6	1
J808*	6510007020	TMP-J01X-V6	1
J810*	6510007020	TMP-J01X-V6	1
J1001*	6510007020	TMP-J01X-V6	1
J1101*	6510007020	TMP-J01X-V6	1
J1301*	6510007020	TMP-J01X-V6	1
J1401*	6910004741	IMSA-9202B-1-03Z041-PT1	1
J1402*	6910004741	IMSA-9202B-1-03Z041-PT1	1
J1403*	6910004741	IMSA-9202B-1-03Z041-PT1	1
J1404*	6910004741	IMSA-9202B-1-03Z041-PT1	1
J1405*	6910004741	IMSA-9202B-1-03Z041-PT1	1
J1406*	6910004741	IMSA-9202B-1-03Z041-PT1	1
J1501*	6510015541	B4B-ZR-SM4-TF (LF) (SN)	1
J1651*	6510007020	TMP-J01X-V6	1
J2001*	6510024940	HEC2305-016250	1
J2002*	6510023730	LGY6502-0600C	1
J2003*	6510023730	LGY6502-0600C	1
J2004*	6510007020	TMP-J01X-V6	1
J2006*	6510019991	52808-2271	1
J2007*	6510018921	B8B-PH-SM4-TB (LF) (SN)	1
P1*	6510003240	TMP-P01X-A1	1
P2*	6510003240	TMP-P01X-A1	1
F3*	5210000041	FGB 2A PBF	1
F2001	5220000230	S-N5054 #01	1
F2002	5220000230	S-N5054 #01	1
W1†	9024940010	62/99/420/C31/C31	1
W2†	9086700300	WIRE 8	1
W3†	9030090170	OPC-1805	1
MP501	8930065740	2590 D-EARTH SPRING	1
MP502	8510015800	2590 2LO CASE	1
MP504	8510016490	2590 LOGIC B-PLATE	1
MP505	8930065740	2590 D-EARTH SPRING	1
MP506	8930063270	2590 EARTH SPRING	1
MP511	8510015900	2590 M-2LO CASE	1
MP551	8930065740	2590 D-EARTH SPRING	1
MP552	8510017200	2427 A-SHIELD PLATE	1
MP801	8930065740	2590 D-EARTH SPRING	1
MP1058	6910001130	10M SHIELD CASE	1
MP1101	8510016060	2590 HF CASE	1
MP1102	8510018610	3009 HF COVER	1
MP1105	8930073570	3009 RF SPRING	1
MP1301	8510018600	3009 50M CASE	1
MP1302	8930058170	SHIELD SPONGE (O)	1
MP1303	8930065740	2590 D-EARTH SPRING	1
MP1408	6910001130	10M SHIELD CASE	1
MP1501	8930065740	2590 D-EARTH SPRING	1
MP1502	8930065740	2590 D-EARTH SPRING	1
MP1504	8930065740	2590 D-EARTH SPRING	1
MP1505	8510017200	2427 A-SHIELD PLATE	1
MP1651	8510016340	2590 2MIX CASE	1
MP1652	8510016390	2590 SHIELD PLATE	1
MP1653	8510017200	2427 A-SHIELD PLATE	1
MP1654	8930025070	SPONGE (CW)	1

[SCOPE UNIT] (SCP)

REF NO.	ORDER NO.	DESCRIPTION	QTY.
J1*	6510007020	TMP-J01X-V6	1
J3*	6510007020	TMP-J01X-V6	1
J11*	6510007020	TMP-J01X-V6	1
J601*	6510019971	52808-1071	1
J2013*	6510023261	B6B-PH-SM4-TB (LF) (SN)	1
J2016*	6510020091	52808-0871	1
J2017*	6510019971	52808-1071	1
J2020*	6510019991	52808-2271	1
J2021*	6510019981	52808-1671	1
MP101	8510015810	2590 MIX CASE	1
MP301	8510015810	2590 MIX CASE	1
MP601	8510015770	2590 DSP CASE	1
MP701	8510015880	2590 S2LO CASE	1
MP801	8510015891	2590 S3LO CASE-1	1
MP802	8510014870	2577 RX-VCO CASE	1

[TUNER UNIT] (TUN)

REF NO.	ORDER NO.	DESCRIPTION	QTY.
P51*	5610000350	PHR-10	1
P52*	6510009610	ZHR-5	1
P53*	6510009610	ZHR-5	1
MF1	2710000780	MP24Z	1
MF2	2710000780	MP24Z	1
MF3	2710000470	MF60B-12H901	1
W1†	8900012901	OPC-1345R	1
W2†	8900012901	OPC-1345R	1
W3†	8900017140	OPC-927A	1
W51†	9025900490	23/00/230/B11/B09	1
W52†	9025900490	23/00/230/B11/B09	1
W53†	9025900490	23/00/230/B11/B09	1
W54†	9025900490	23/00/230/B11/B09	1
W55†	9025900490	23/00/230/B11/B09	1
W56†	9025900500	23WIRE /08/230/B11/B09	1
W57†	9025900500	23WIRE /08/230/B11/B09	1
W58†	9025900500	23WIRE /08/230/B11/B09	1
W59†	9025900500	23WIRE /08/230/B11/B09	1
W60†	9025900500	23WIRE /08/230/B11/B09	1
MP1	8950003200	UJ6-5 (UNIVERSAL COUPLINGS)	2
MP2	8930030112	1414 PLATE-2	2
MP3	8820000881	1528 SCREW-1	4
MP4	8930061271	2590 MOTOR ANGLE-1	1
MP5	8510015832	2590 TUNER CASE-2	1
MP6	8510015870	2590 TUNER COVER	1
MP7	8810005161	CAP BOLT M3X20 ZK3	4
MP8	8810007231	SETSCREW (H) 3X8 ZC3	6
MP9	8810007231	SETSCREW (H) 3X8 ZC3	4
MP10	8810008631	SCREW BT B0 3X6 NI-ZC3 (BT)	6
MP11	8810008631	SCREW BT B0 3X6 NI-ZC3 (BT)	6
MP12	8810008631	SCREW BT B0 3X6 NI-ZC3 (BT)	4
MP13	8850000130	FLAT WASHER M3 BS NI 3X8X0.5	4
MP14	8930006960	SPONGE (Y)	1
MP16	8930058760	SHIELD SPONGE (S)	1

[ACCESSORIES] (ACC)

REF NO.	ORDER NO.	DESCRIPTION	QTY.
J1	6510023200	P031010	2
J2	5610000280	MP-12M	1
J3	6450001271	TCP0577-715267	1
J4	6450001281	TCP0587-715467	1
P1	5610000410	AP-319	3
P2	5610000430	AP331	3
P3	5610000420	AP-338	1
F1	5210000041	FGB 2A PBF	1
W1	8900005250	OPC-510 [USA], [KOR]	1
	8900005130	OPC-492 [EUR], [FRA], [ITR], [ESP]	1
	8900005120	OPC-491 [UK]	1
MP2	8810008451	SCREW BiH M4X8 ZK3	6
MP3	8960000630	HEX DRIVER DH-20	1
MP4	8930061360	2590 SUB STAND	2
MP5	8930061840	2590 A-STAND SHEET	2
MP6	8930072140	MR PROTECTION CAP	4
MP11	8810010591	SCREW BT B0 3X20NI-ZC3 (BT)	2
MP12	8610010040	KNOBN-239 FINGER REST	1
MP13	8810003560	HEX TOP SCREW M4X6 SUS	1
MP14	8610013270	KNOB N-363 BASE	1
MP15	8610013310	KNOB N-363 COVER	1
MP16	8610013280	KNOB N-363 PLATE	1
MP17	8930073200	KNOB N-363 SHEET	1
MP18	8610013590	KNOB N-363 RING	1
MP19	8610013710	KNOB N-363 A-SPACER	1

*: Refer to "BOARD LAYOUTS" for the location.

†: Refer to "GENERAL WIRING" for the connection.

<FRONT UNIT>

• DISPLAY BOARD (TOP VIEW)

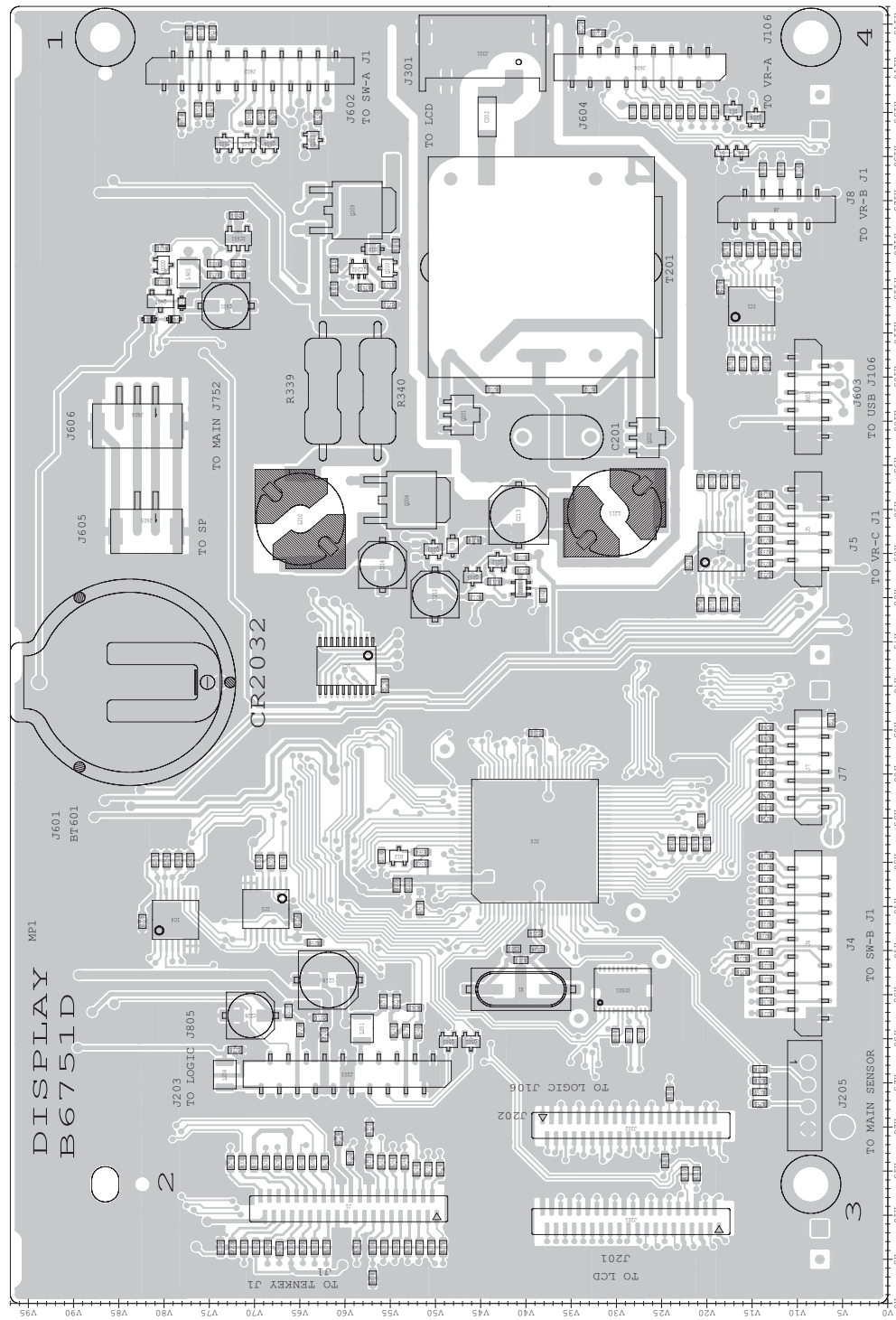

• LED BOARD (TOP VIEW)

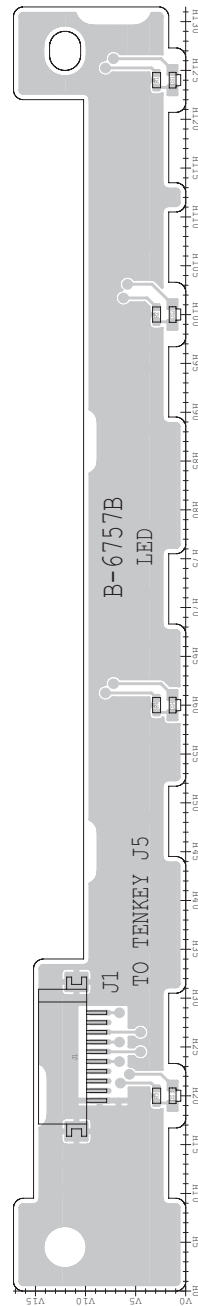

• PBT BOARD (TOP VIEW)

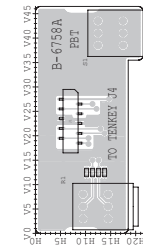

• PITCH BOARD (TOP VIEW)

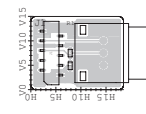

• MIC BOARD (TOP VIEW)

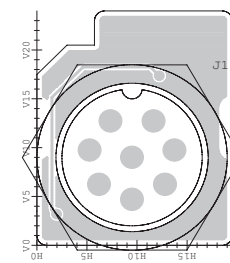

• JACK BOARD (TOP VIEW)

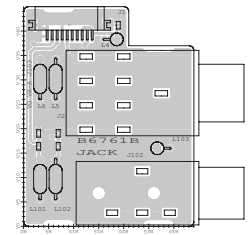

• TENKEY BOARD (TOP VIEW)

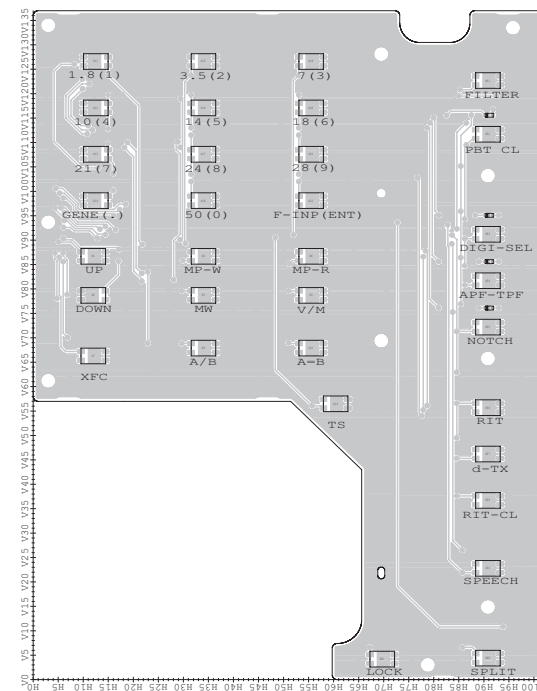

• USB BOARD (TOP VIEW)

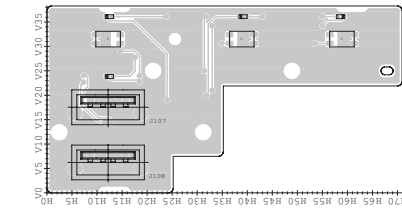

• VR-A BOARD (TOP VIEW)

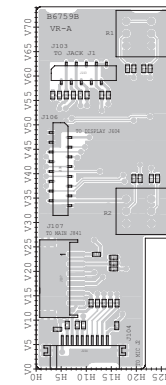

• VR-B BOARD (TOP VIEW)

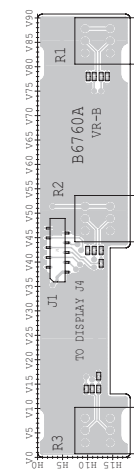

• VR-C BOARD (TOP VIEW)

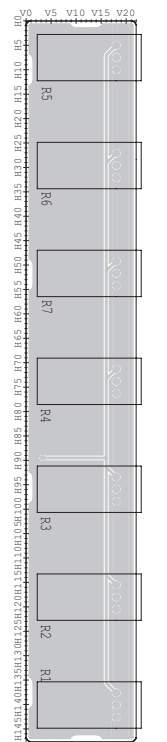

• SW-A BOARD (TOP VIEW)

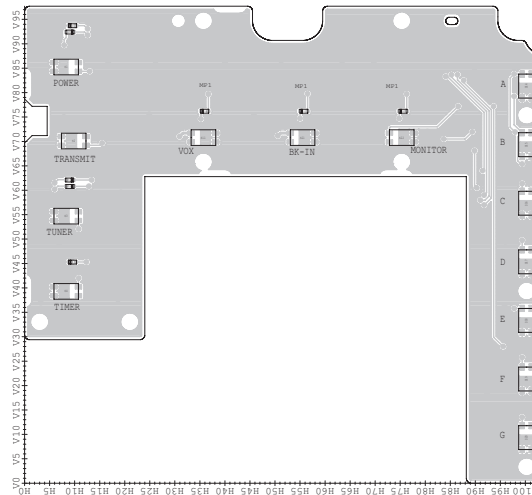

• SW-B BOARD (TOP VIEW)

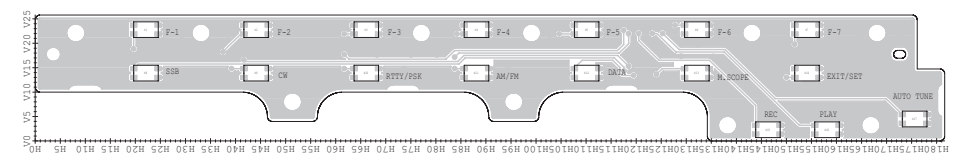

• JACK BOARD
(BOTTOM VIEW)

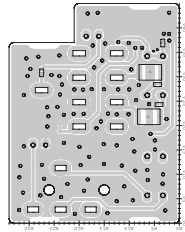

• MIC BOARD
(BOTTOM VIEW)

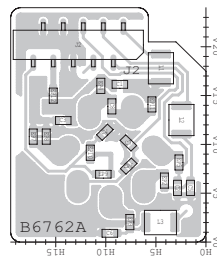

• PITCH BOARD
(BOTTOM VIEW)

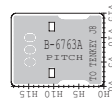

• PBT BOARD
(BOTTOM VIEW)

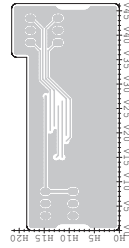

• LED BOARD
(BOTTOM VIEW)

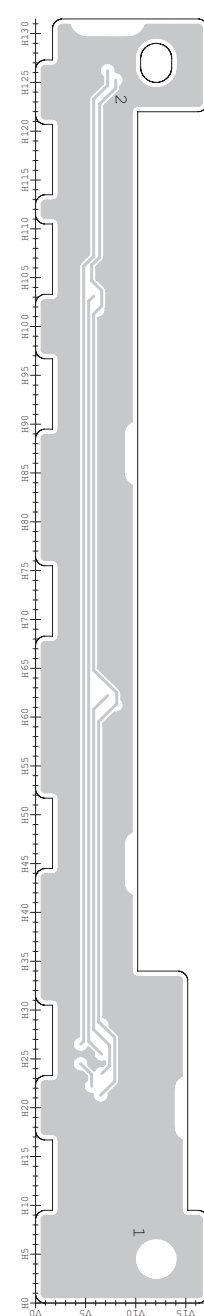

• DISPLAY BOARD
(BOTTOM VIEW)

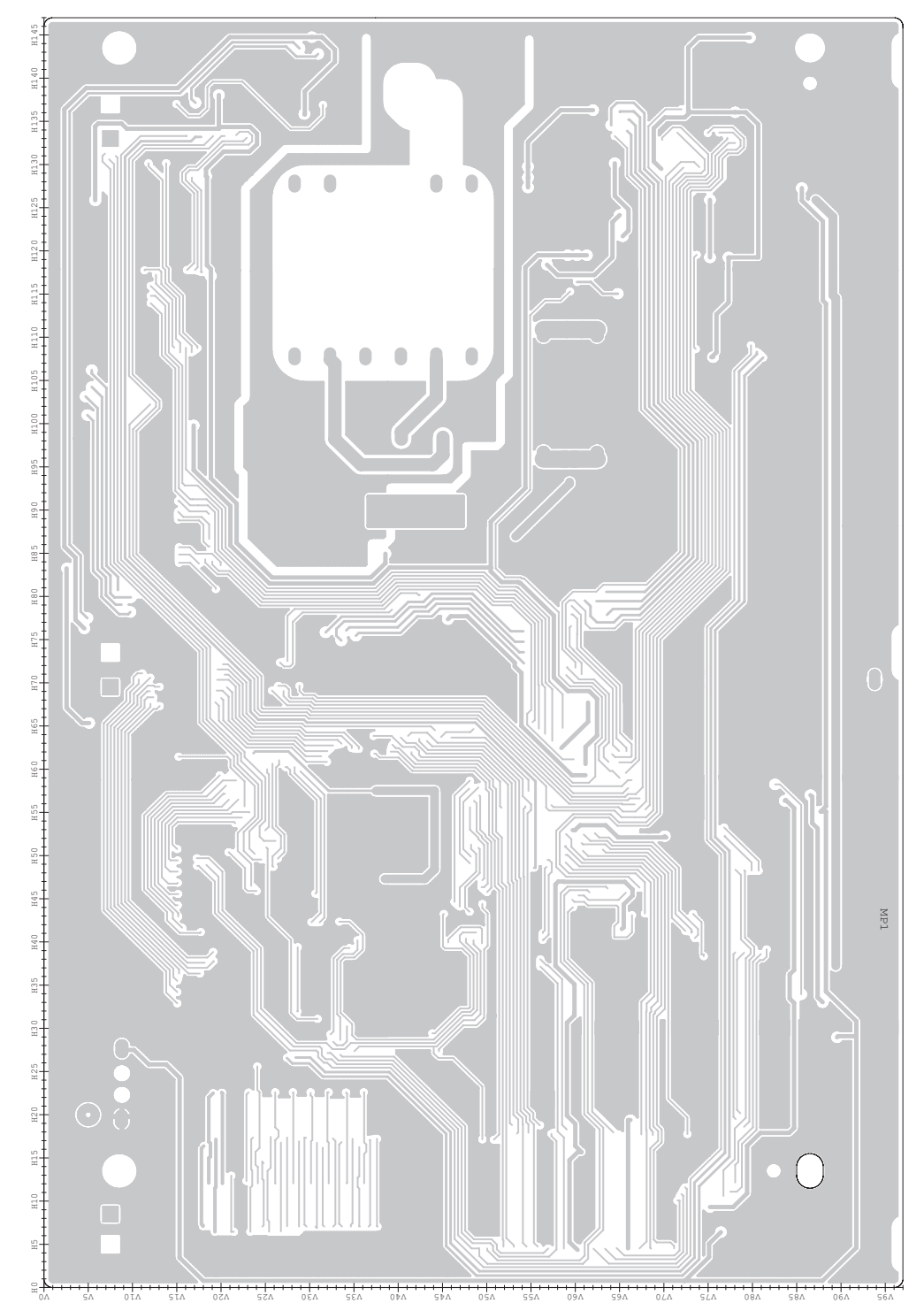

• USB BOARD
(BOTTOM VIEW)

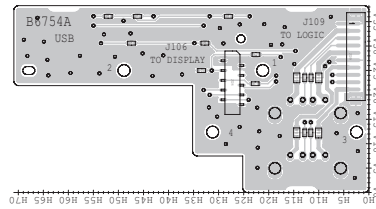

• TENKEY BOARD
(BOTTOM VIEW)

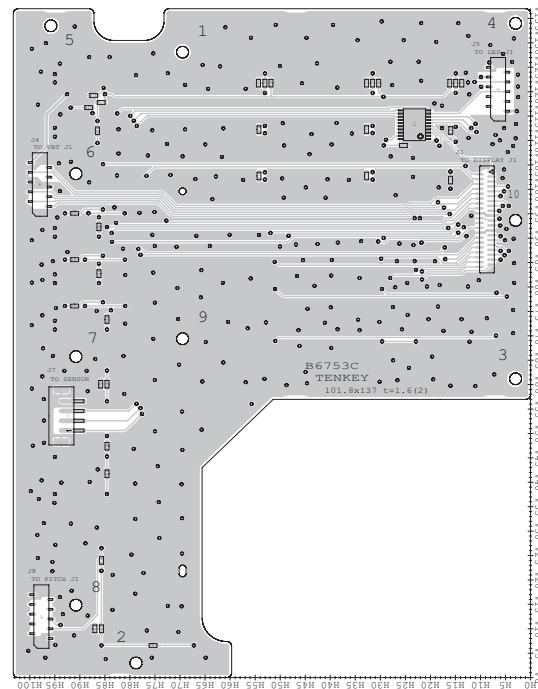

• VR-C BOARD
(BOTTOM VIEW)

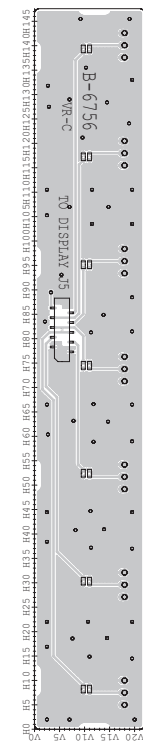

• VR-B BOARD
(BOTTOM VIEW)

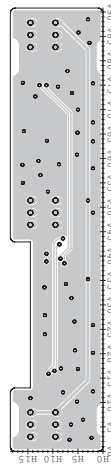

• VR-A BOARD
(BOTTOM VIEW)

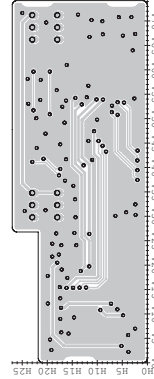

• SW-A BOARD
(BOTTOM VIEW)

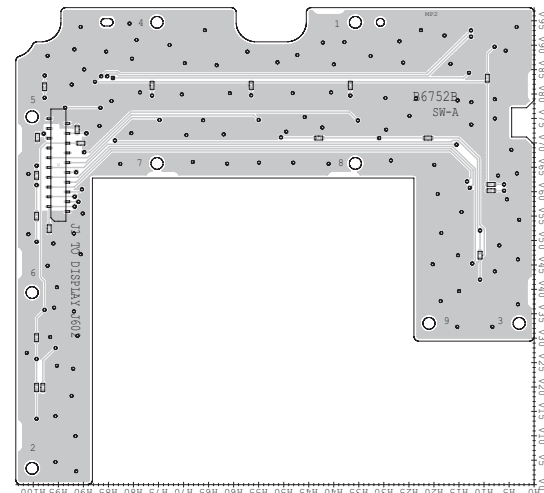

• SW-B BOARD
(BOTTOM VIEW)

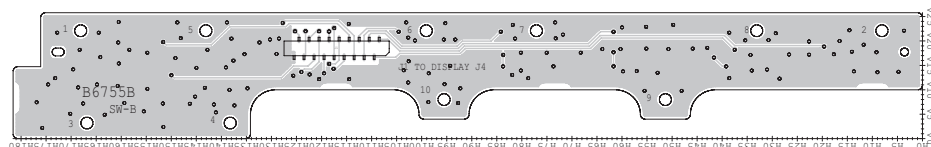

V120V11SV110V10SV100V95 V90 V85 V80 V75 V70 V65 V60 V55 V50 V45 V40 V35 V30 V25 V20 V15 V10 V5

• LOGIC UNIT
(BOTTOM VIEW)

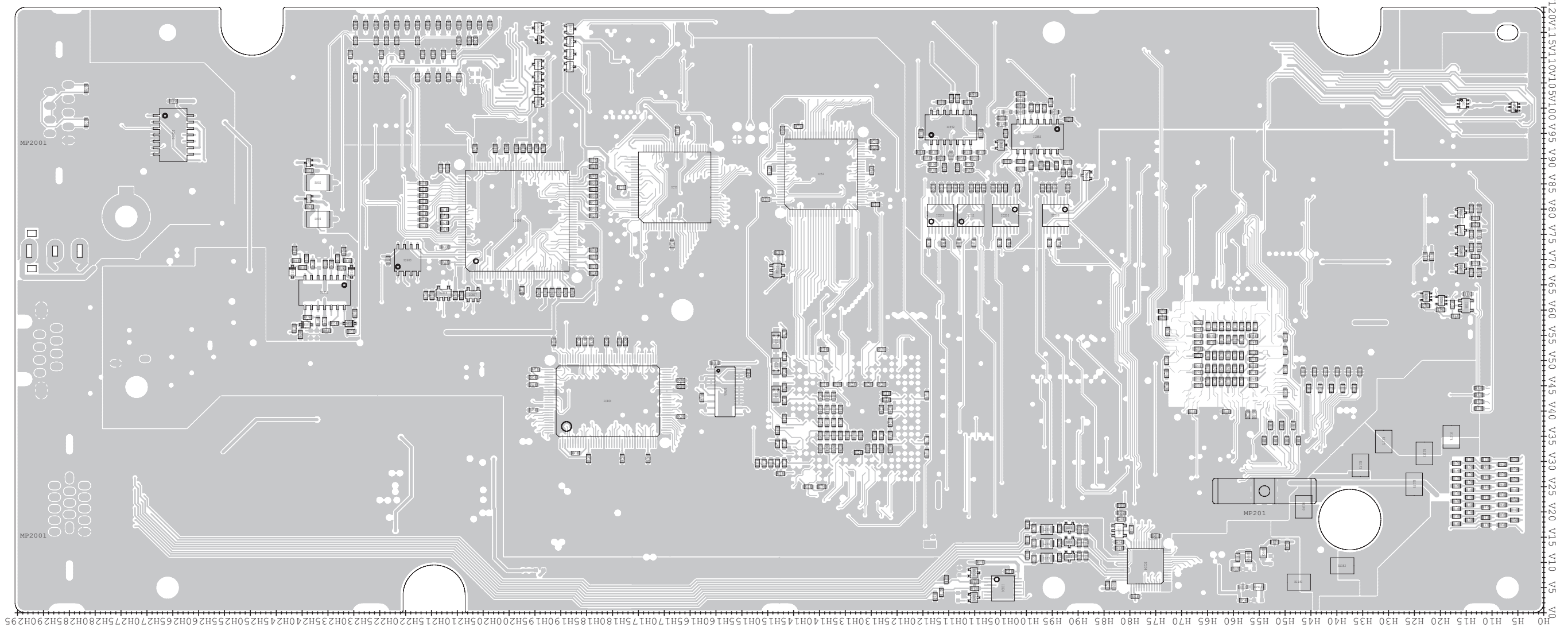

• MEMMORY BOARD
(BOTTOM VIEW)

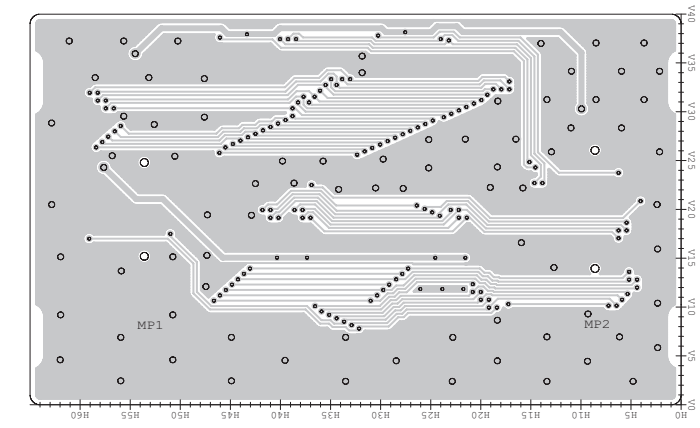

• SCOPE UNIT (TOP VIEW)

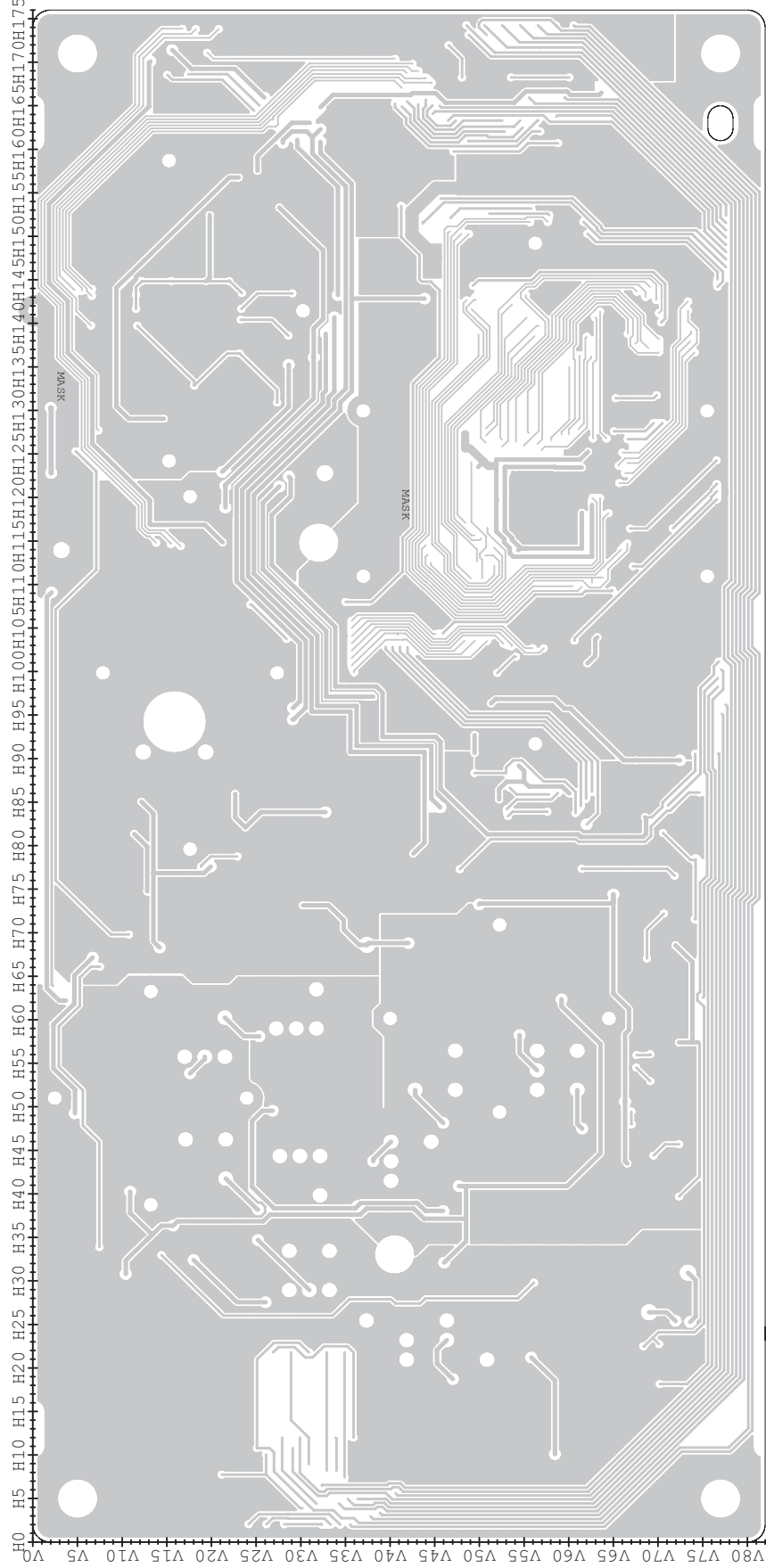

• MAIN UNIT (TOP VIEW)

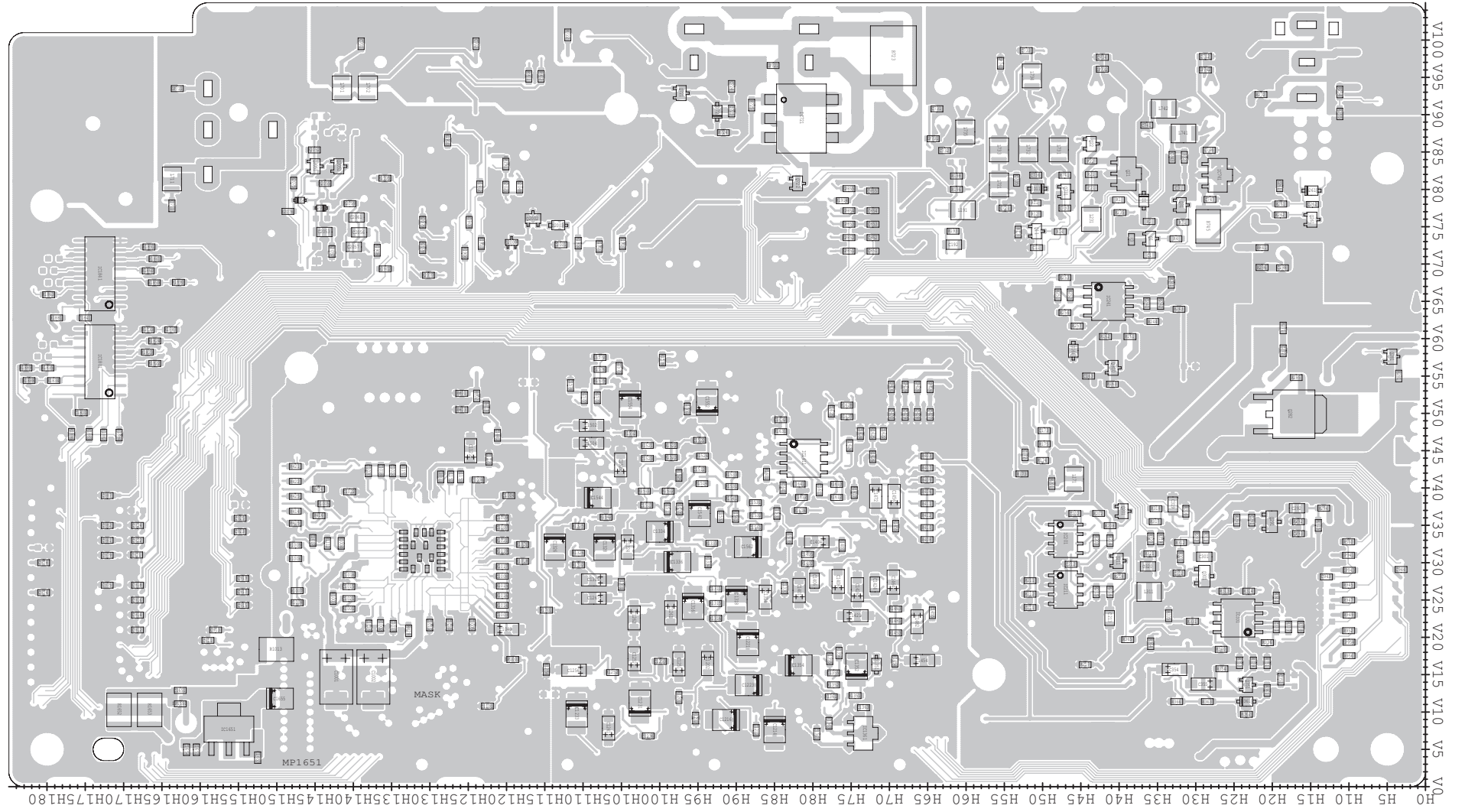

• ANT-SW UNIT
(TOP VIEW)

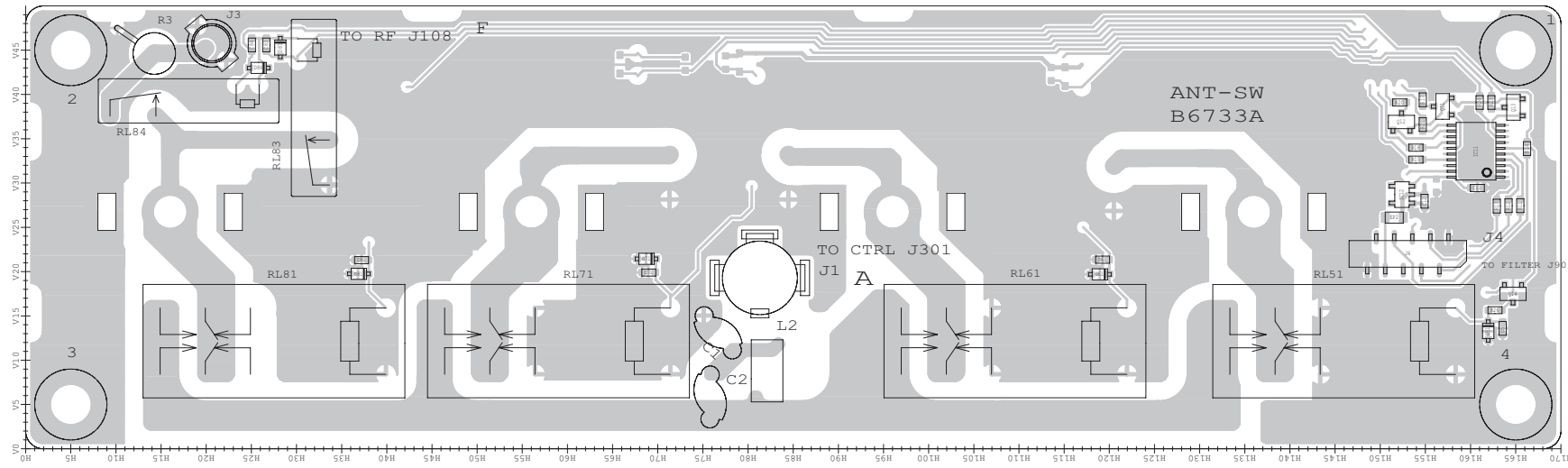

• NETWORK BOARD
(TOP VIEW)

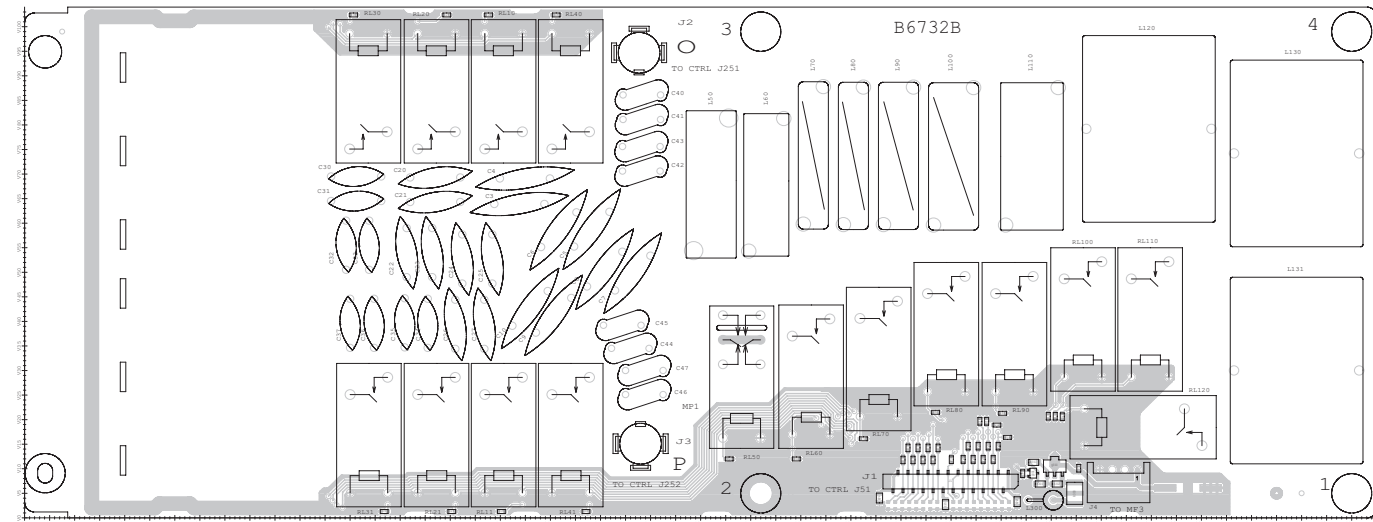

• CTRL UNIT
(TOP VIEW)

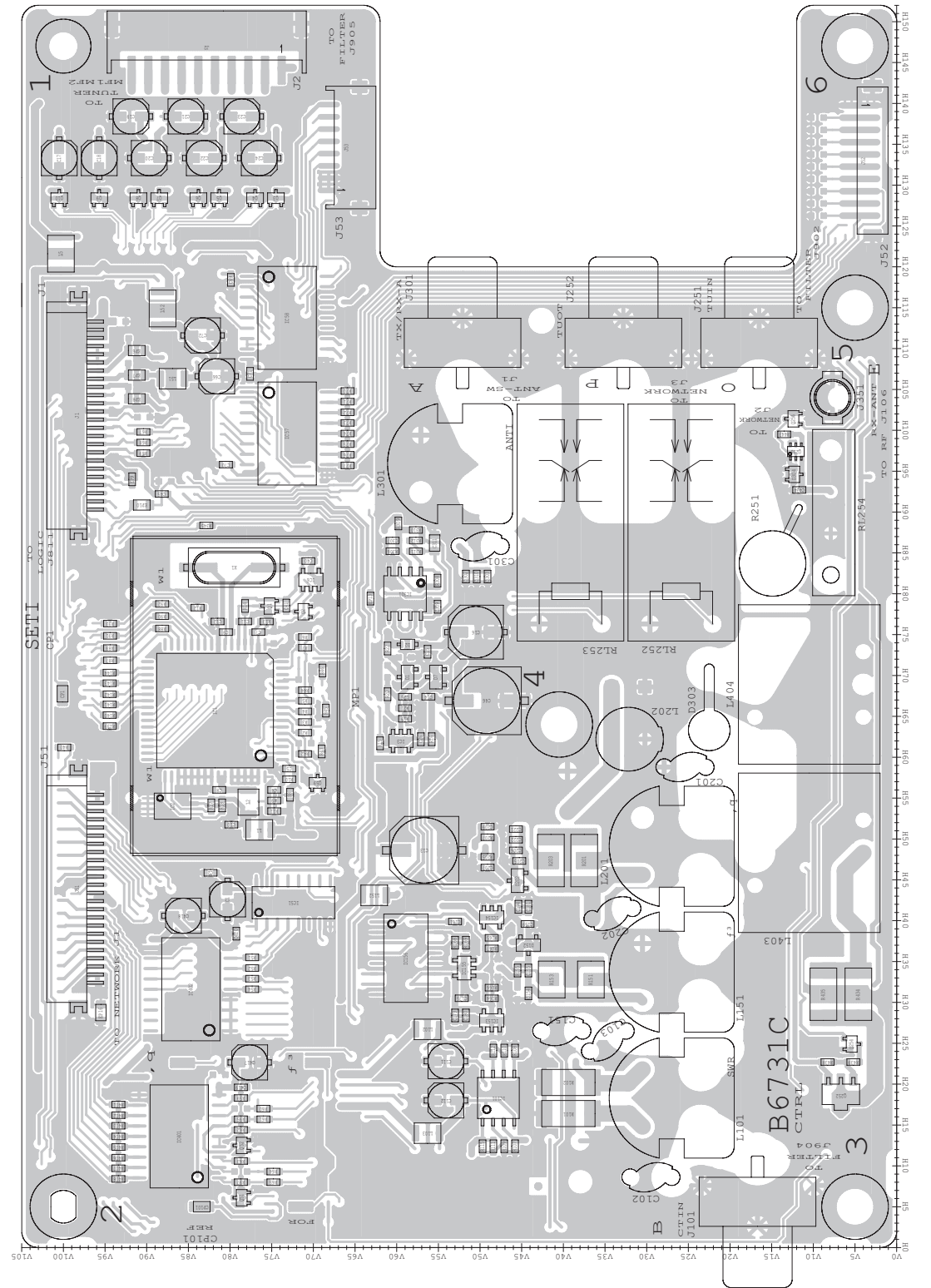

• CTRL UNIT
(BOTTOM VIEW)

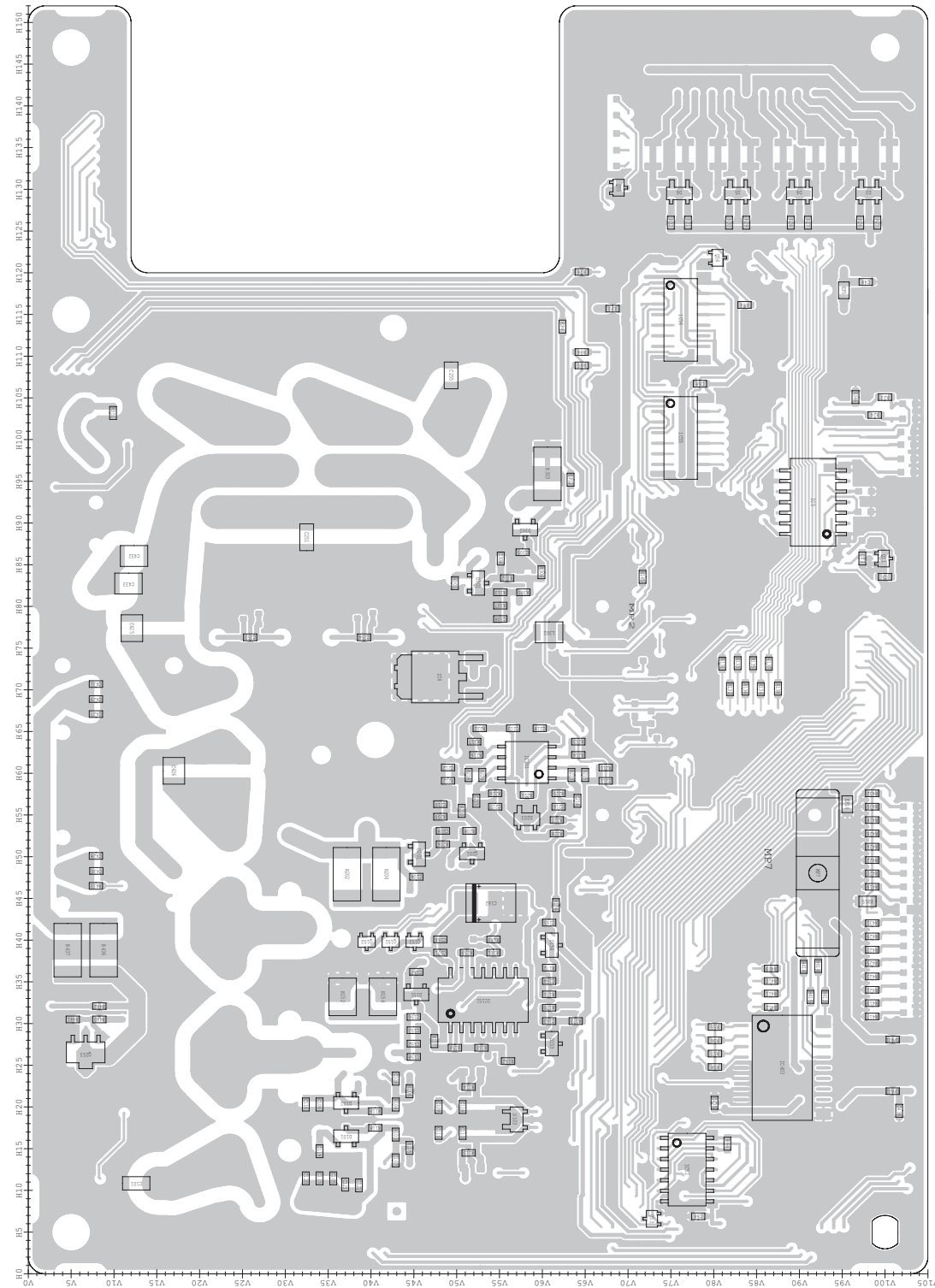

• ANT-SW UNIT
(BOTTOM VIEW)

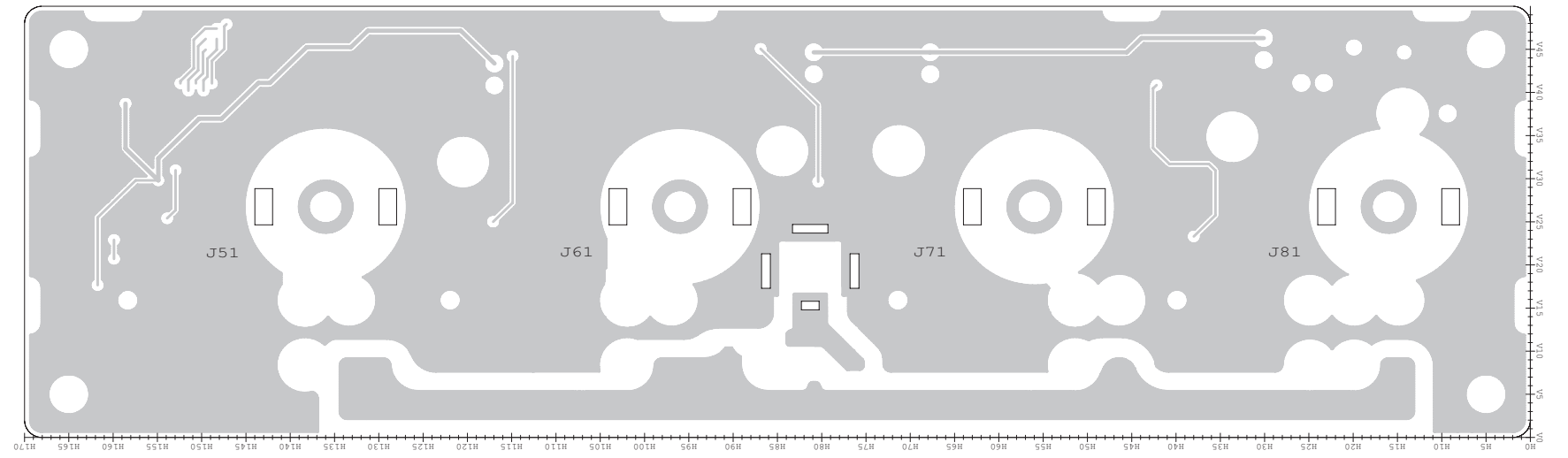

• NETWORK BOARD
(BOTTOM VIEW)

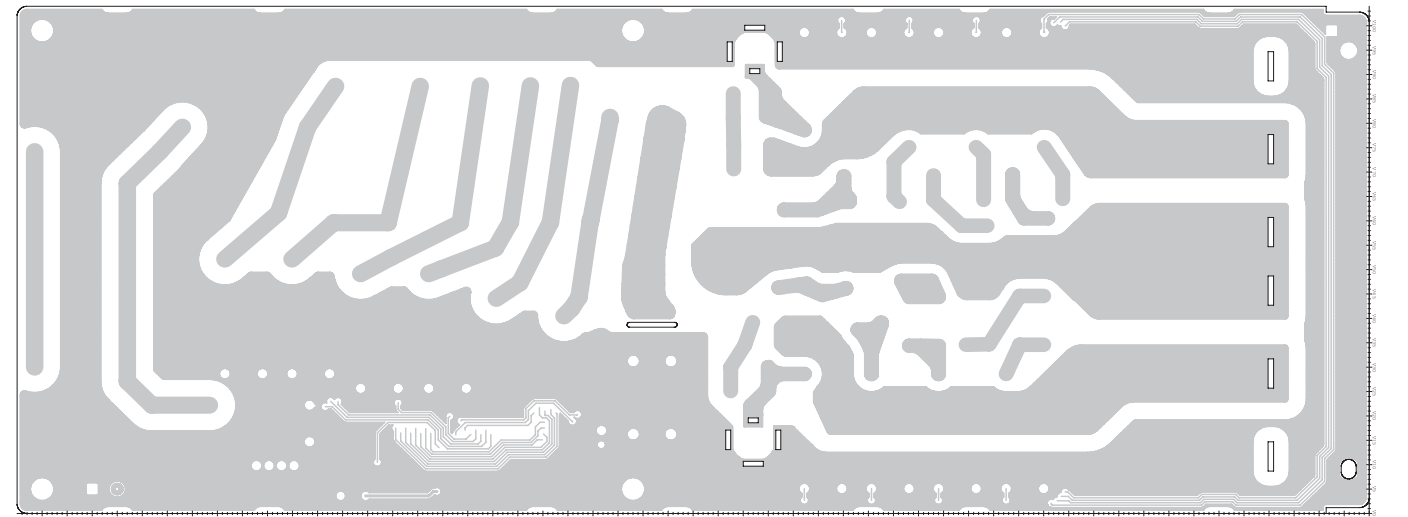

• RF UNIT (TOP VIEW)

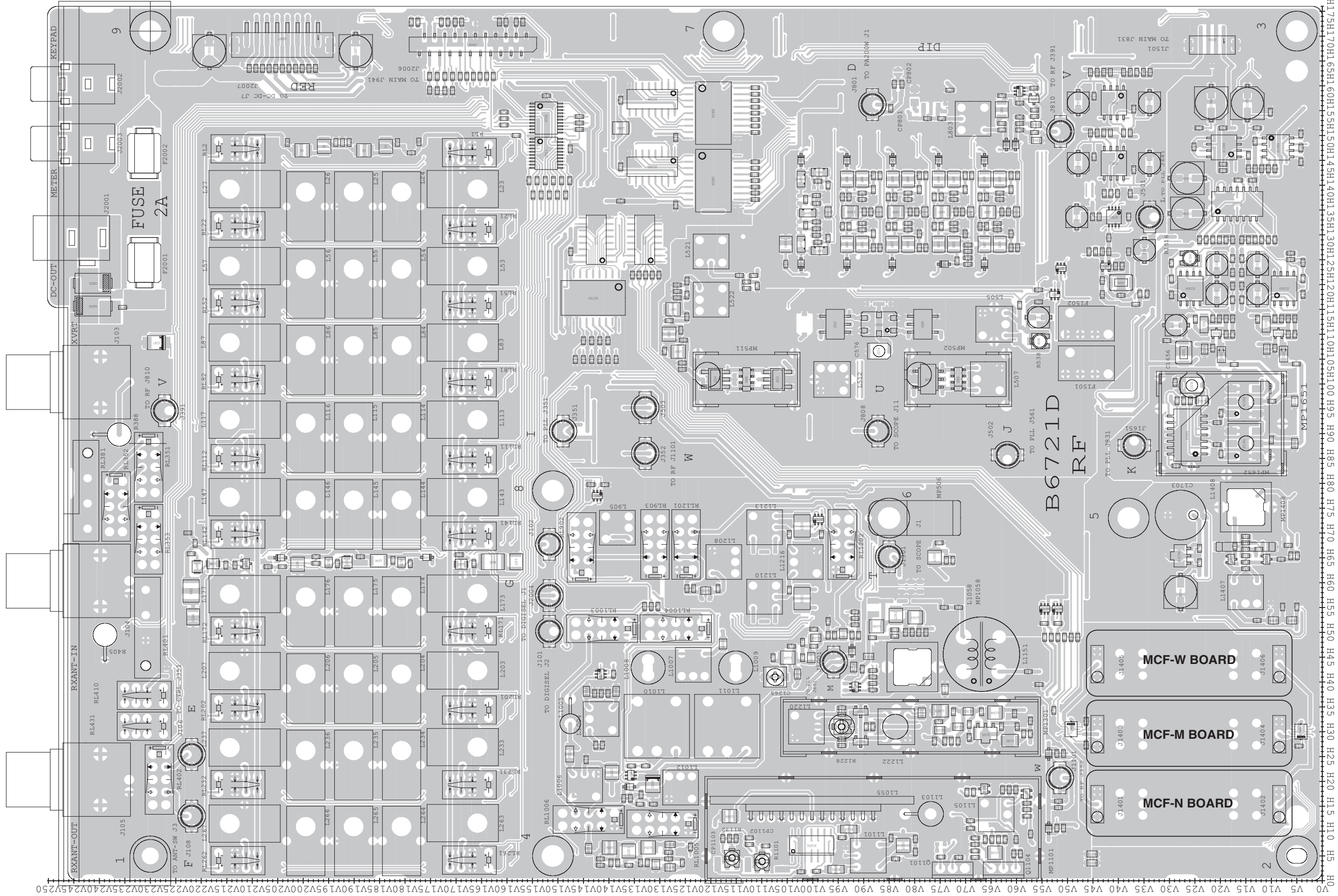

• MCF-M BOARD (TOP VIEW)

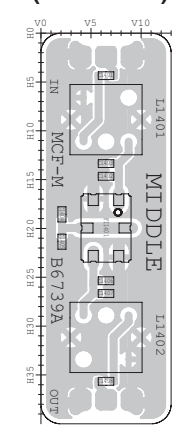

• MCF-N BOARD (TOP VIEW)

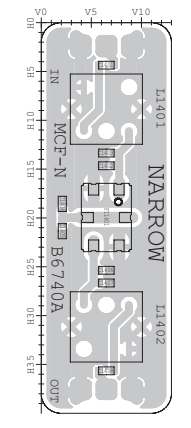

• MCF-W BOARD (TOP VIEW)

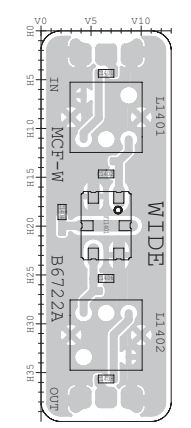

• MCF-M BOARD (BOTTOM VIEW)

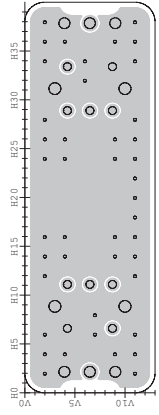

• MCF-N BOARD (BOTTOM VIEW)

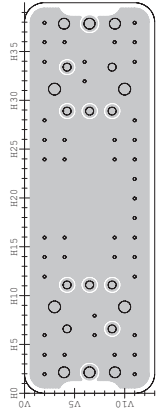

• MCF-W BOARD (BOTTOM VIEW)

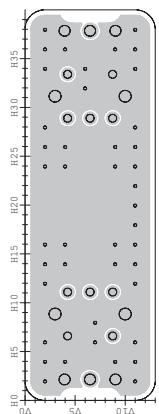

• RF UNIT (BOTTOM VIEW)

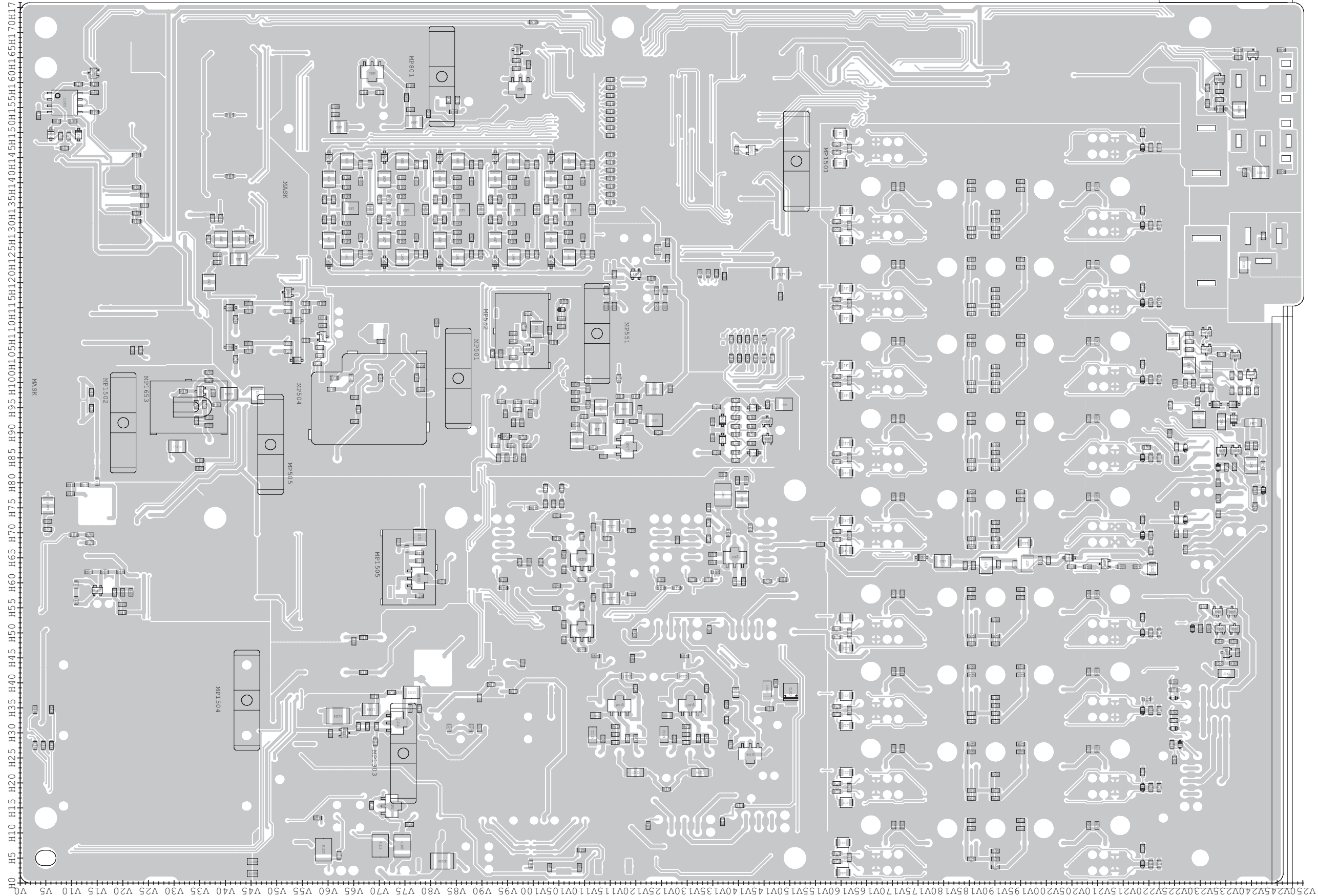

• FILTER UNIT
(BOTTOM VIEW)

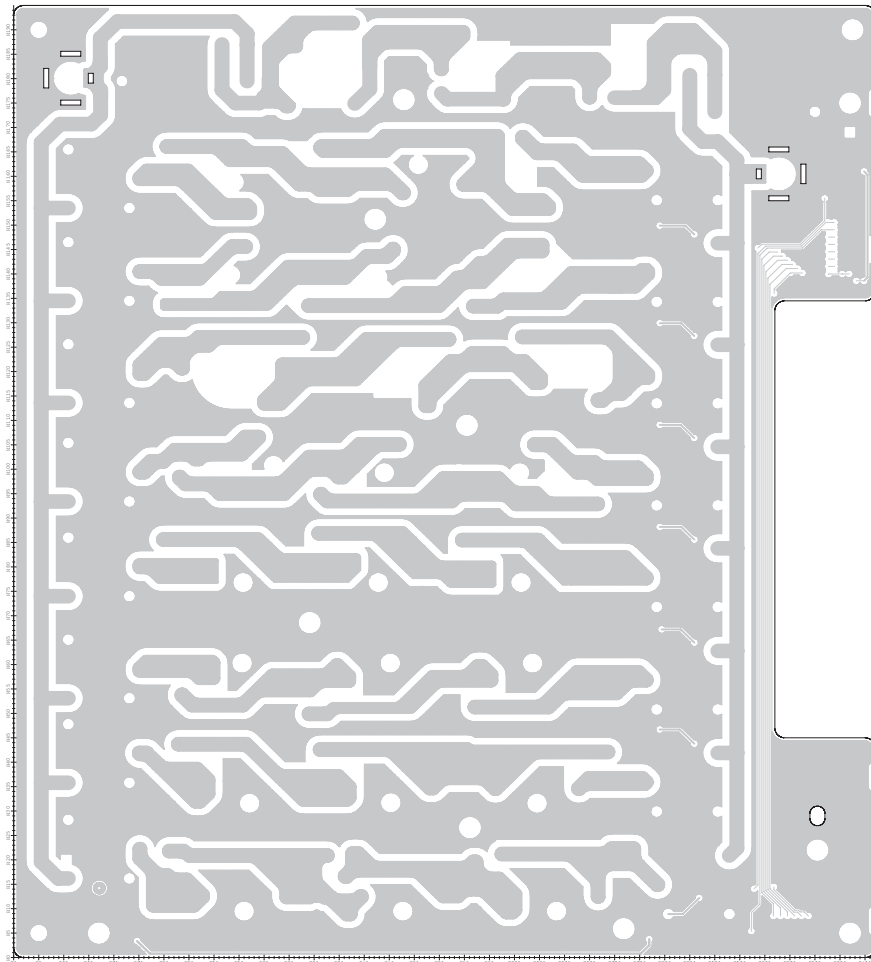

• PA200W BOARD
(BOTTOM VIEW)

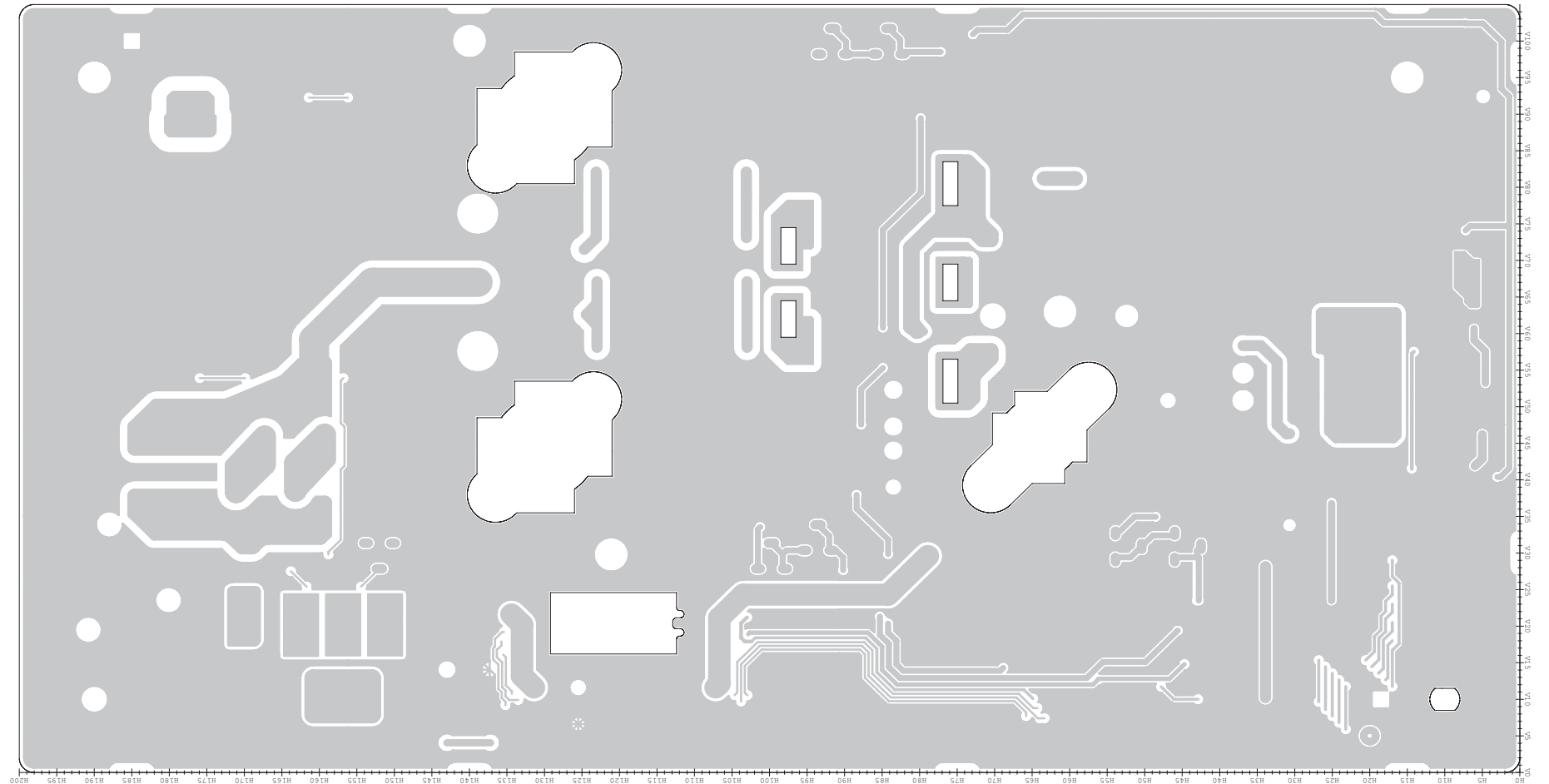

• OSC UNIT
(BOTTOM VIEW)

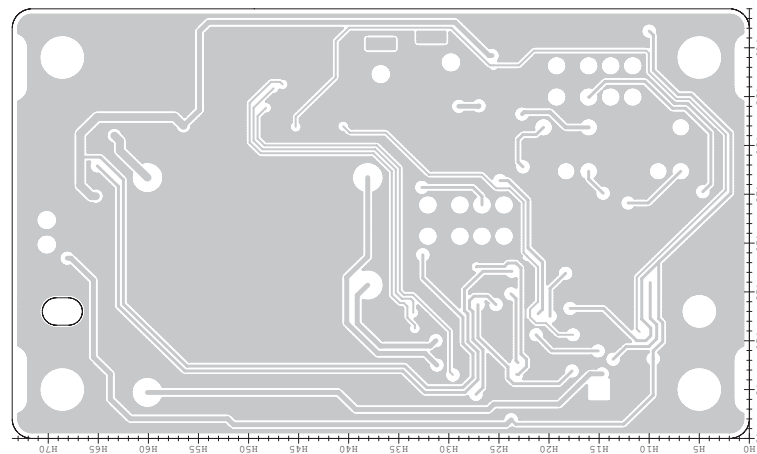

• PLL UNIT
(BOTTOM VIEW)

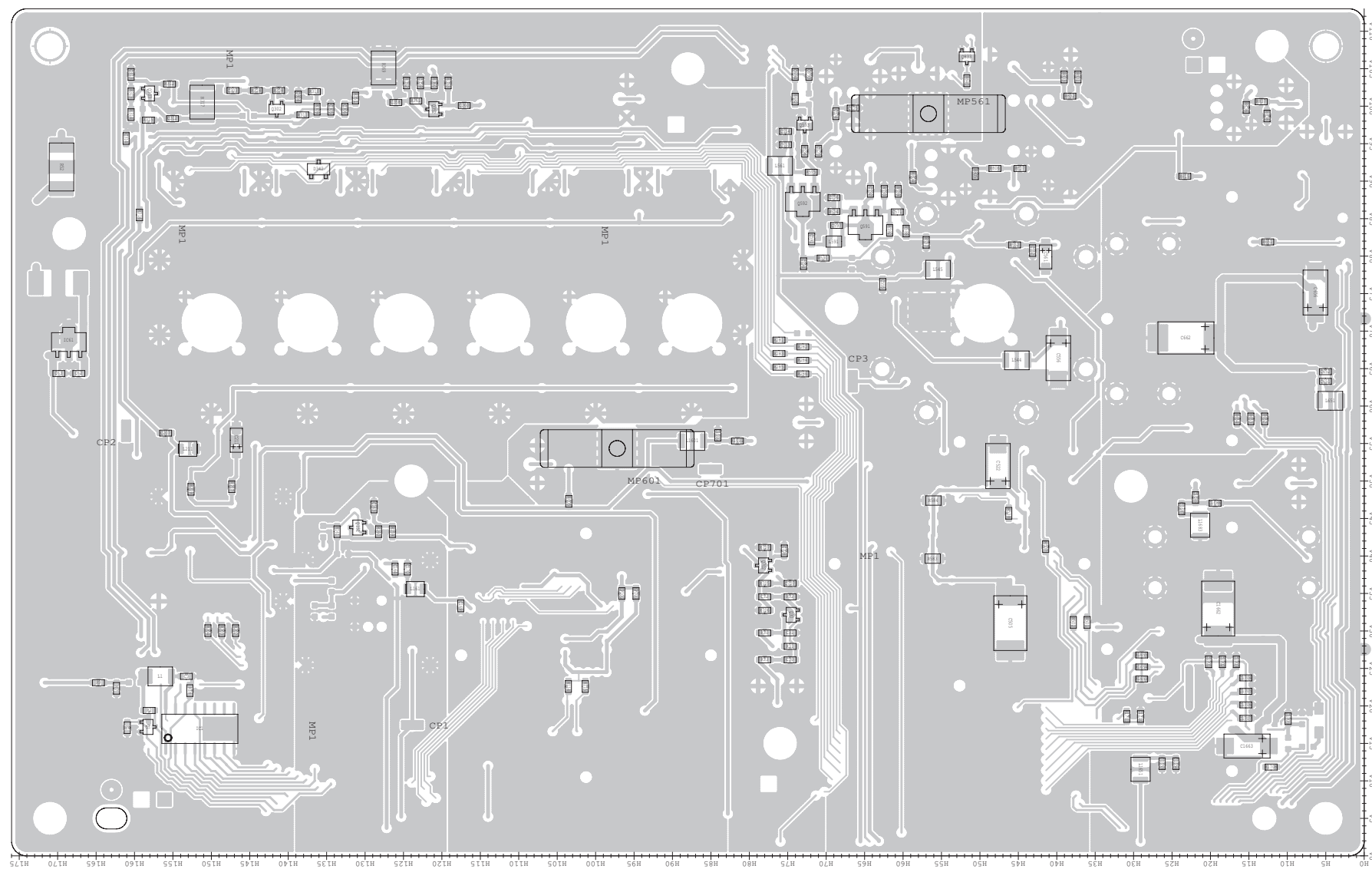

• OTHER THAN FRONT UNIT

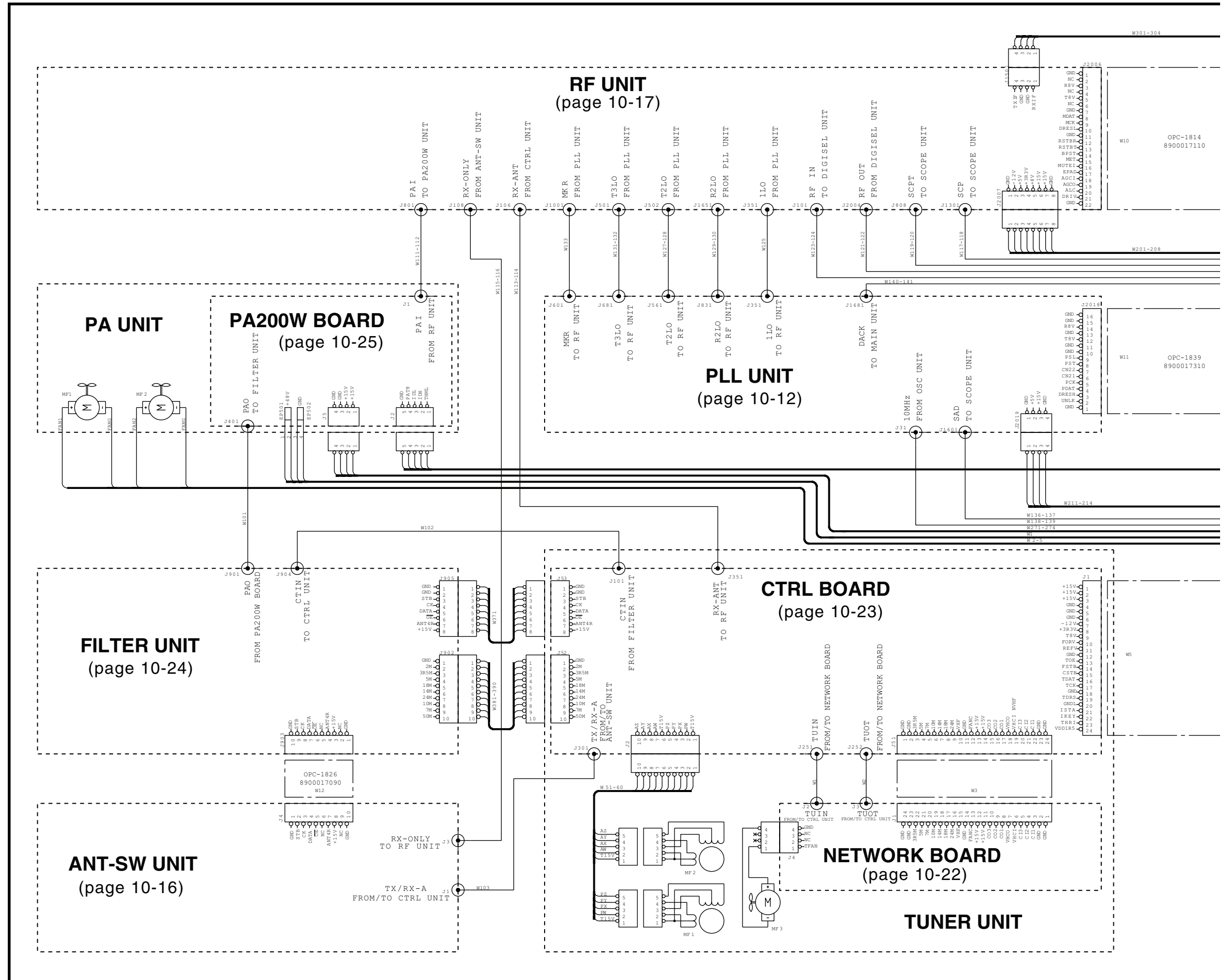

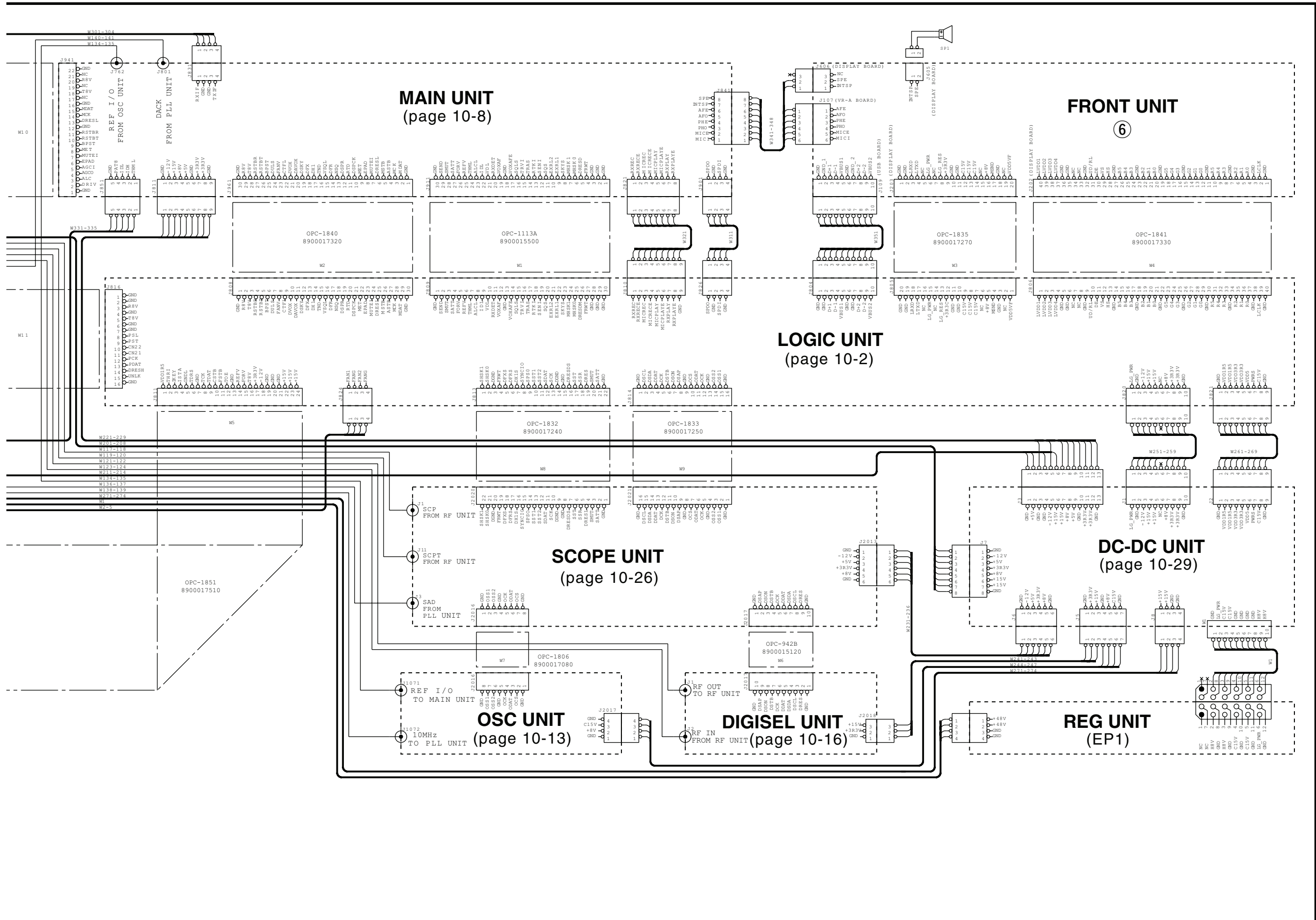

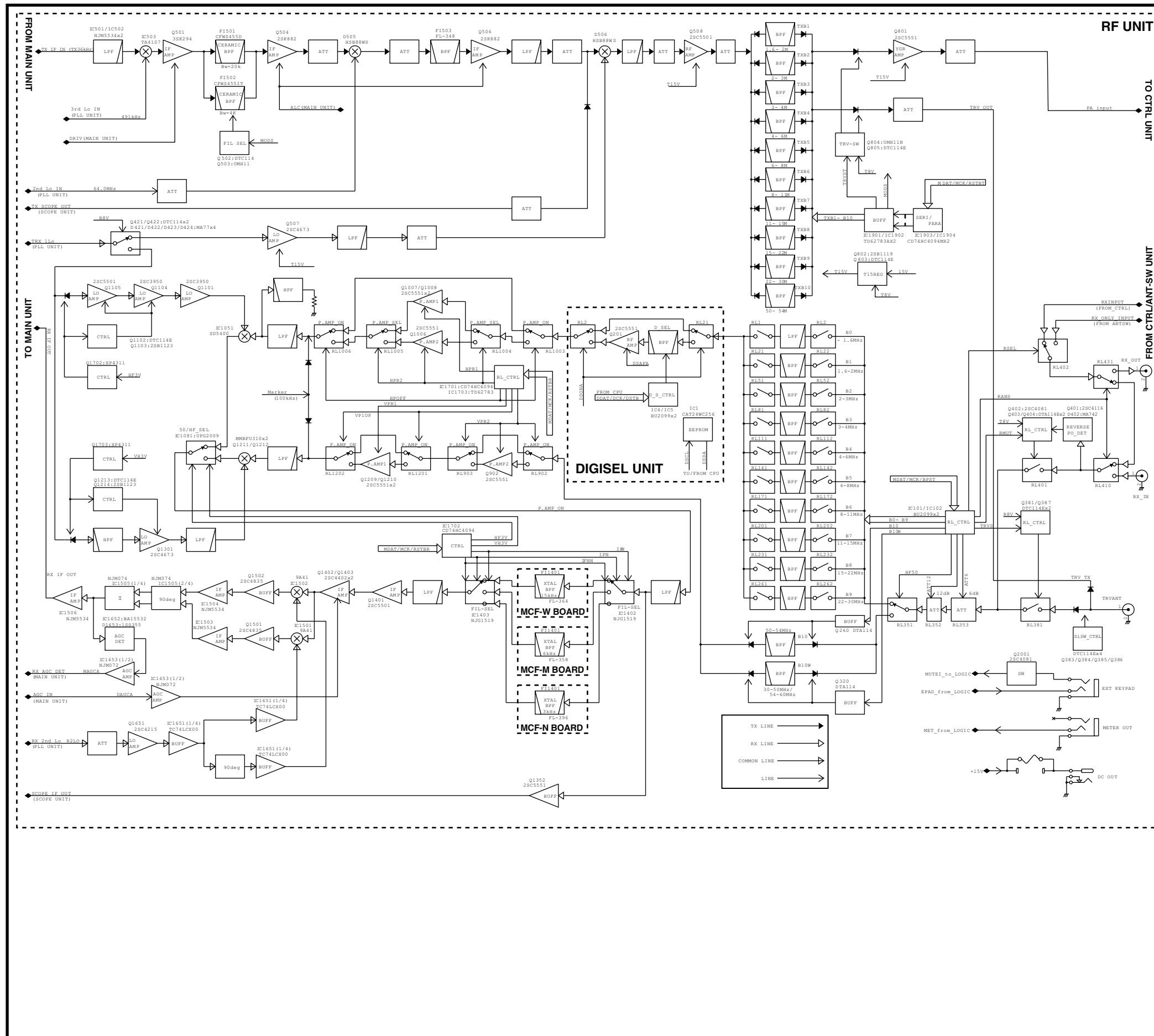

SECTION 10 SCHEMATIC DIAGRAM

• FRONT UNIT

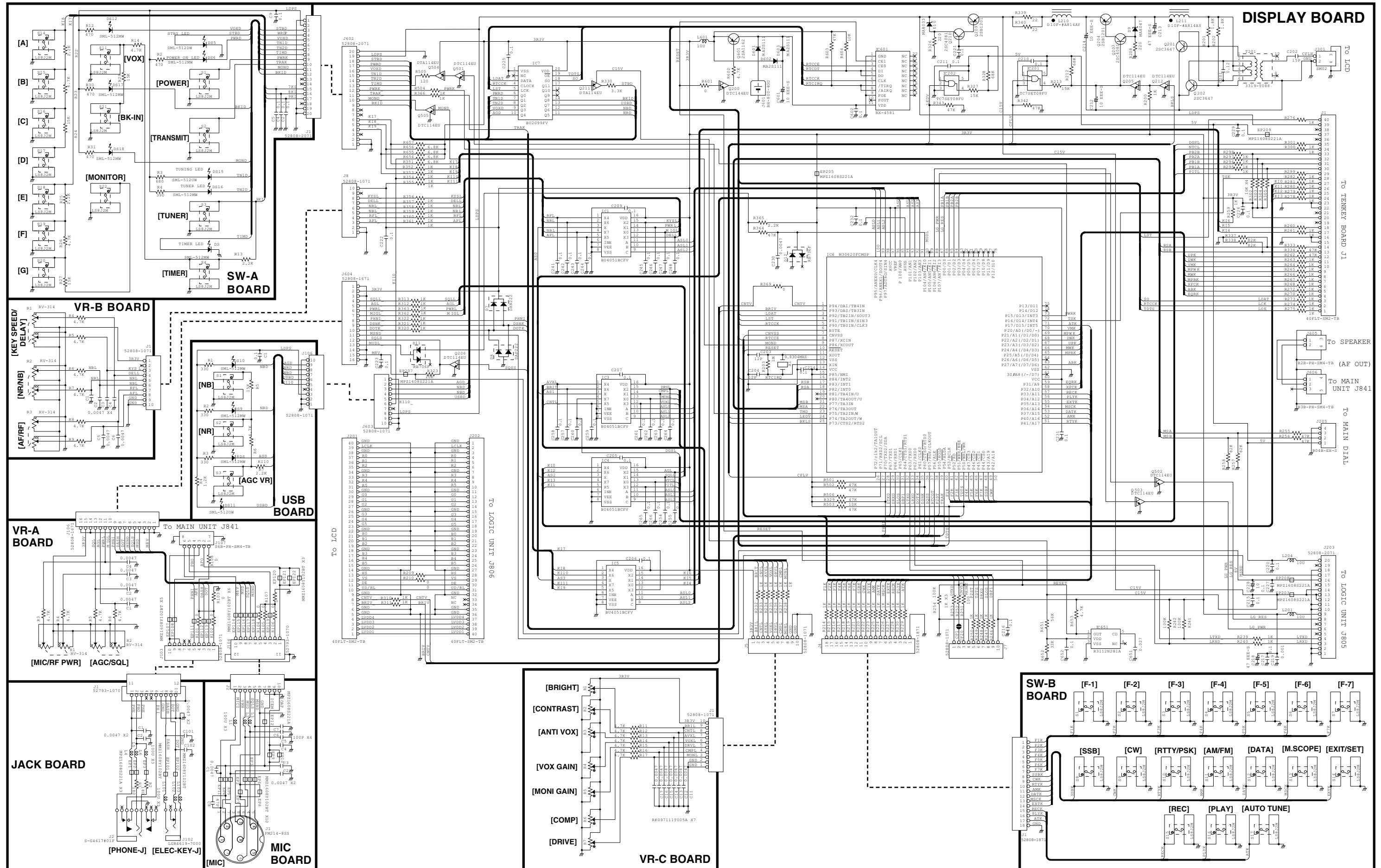

LOGIC UNIT (LOGIC-1)

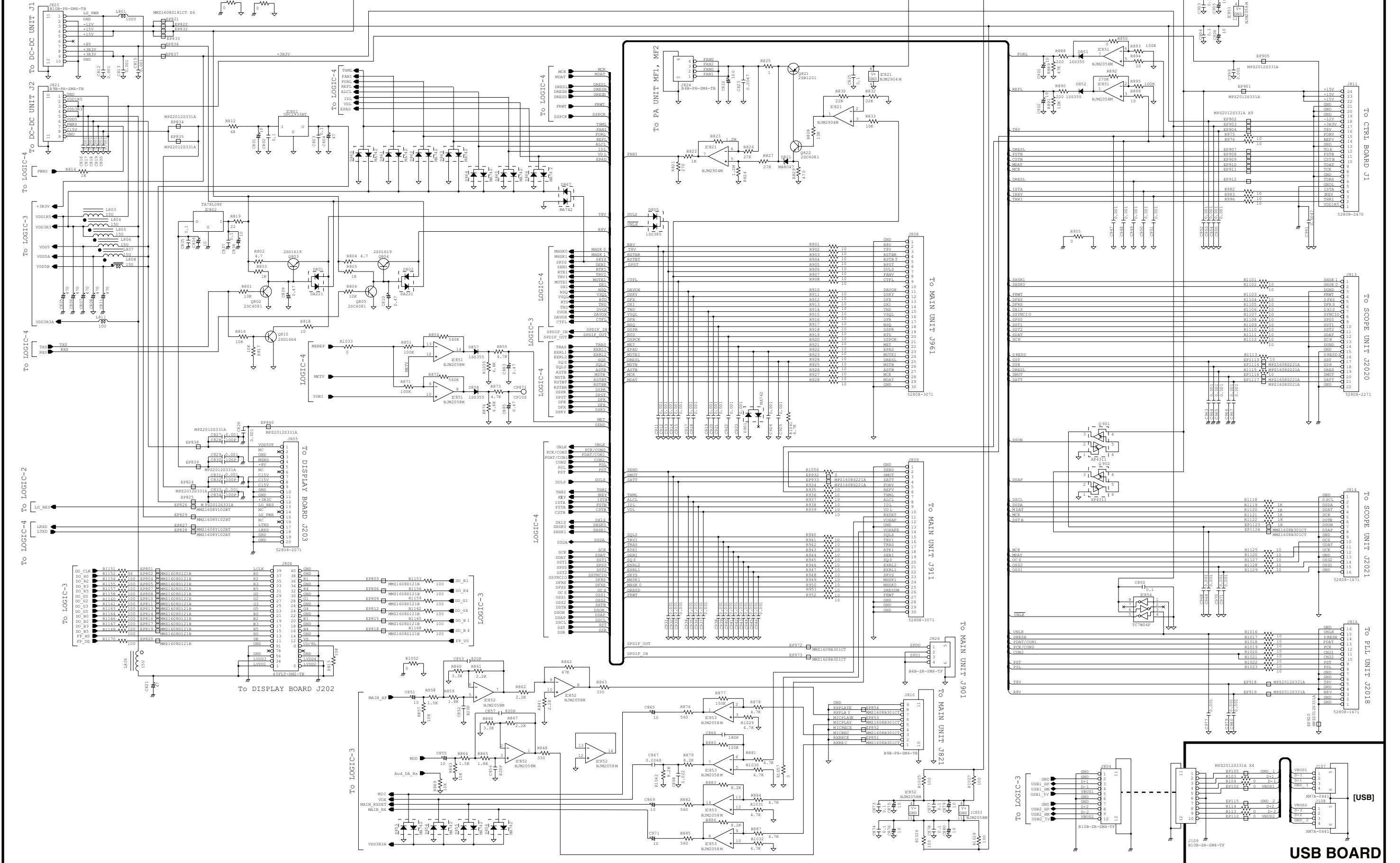

LOGIC UNIT (LOGIC-2)

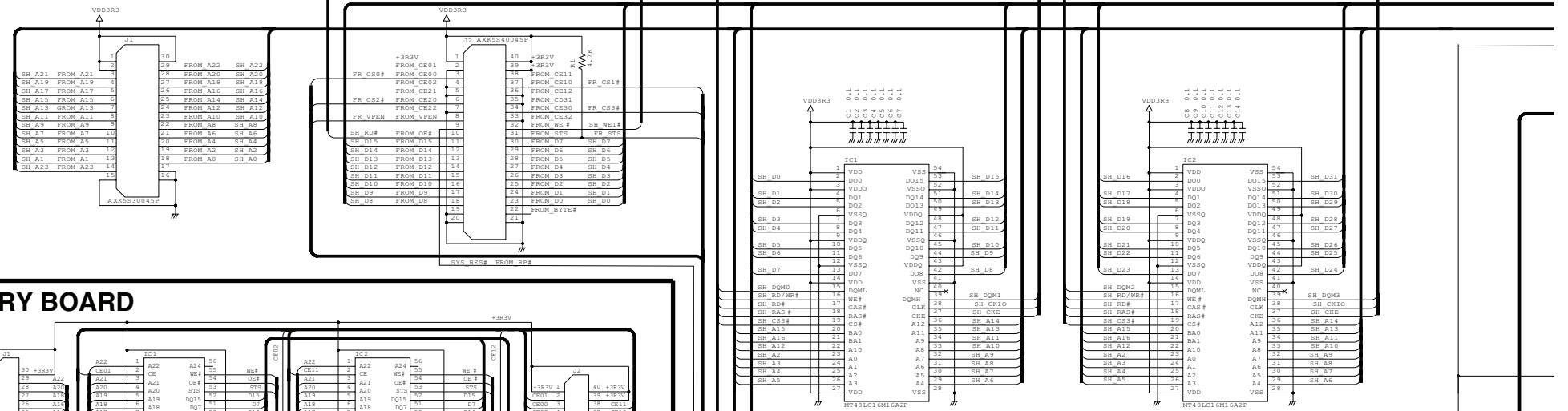

MEMORY BOARD

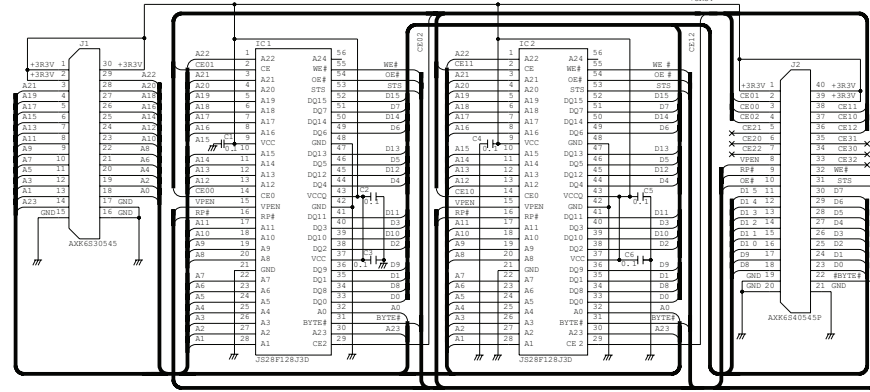

TO LOGIC-4

TO LOGIC-3

TO LOGIC-1

TO LOGIC-5

TO LOGIC-6

TO LOGIC-7

TO LOGIC-8

TO LOGIC-9

TO LOGIC-10

TO LOGIC-11

TO LOGIC-12

TO LOGIC-13

TO LOGIC-14

TO LOGIC-15

TO LOGIC-16

TO LOGIC-17

TO LOGIC-18

TO LOGIC-19

TO LOGIC-20

TO LOGIC-21

TO LOGIC-22

TO LOGIC-23

TO LOGIC-24

TO LOGIC-25

TO LOGIC-26

TO LOGIC-27

TO LOGIC-28

TO LOGIC-29

TO LOGIC-30

TO LOGIC-31

TO LOGIC-32

TO LOGIC-33

TO LOGIC-34

TO LOGIC-35

TO LOGIC-36

TO LOGIC-37

TO LOGIC-38

TO LOGIC-39

TO LOGIC-40

TO LOGIC-41

TO LOGIC-42

TO LOGIC-43

TO LOGIC-44

TO LOGIC-45

TO LOGIC-46

TO LOGIC-47

TO LOGIC-48

TO LOGIC-49

TO LOGIC-50

TO LOGIC-51

TO LOGIC-52

TO LOGIC-53

TO LOGIC-54

TO LOGIC-55

TO LOGIC-56

TO LOGIC-57

TO LOGIC-58

TO LOGIC-59

TO LOGIC-60

TO LOGIC-61

TO LOGIC-62

TO LOGIC-63

TO LOGIC-64

TO LOGIC-65

TO LOGIC-66

TO LOGIC-67

TO LOGIC-68

TO LOGIC-69

TO LOGIC-70

TO LOGIC-71

TO LOGIC-72

TO LOGIC-73

TO LOGIC-74

TO LOGIC-75

TO LOGIC-76

TO LOGIC-77

TO LOGIC-78

TO LOGIC-79

TO LOGIC-80

TO LOGIC-81

TO LOGIC-82

TO LOGIC-83

TO LOGIC-84

TO LOGIC-85

TO LOGIC-86

TO LOGIC-87

TO LOGIC-88

TO LOGIC-89

TO LOGIC-90

TO LOGIC-91

TO LOGIC-92

TO LOGIC-93

TO LOGIC-94

TO LOGIC-95

TO LOGIC-96

TO LOGIC-97

TO LOGIC-98

TO LOGIC-99

TO LOGIC-100

TO LOGIC-101

TO LOGIC-102

TO LOGIC-103

TO LOGIC-104

TO LOGIC-105

TO LOGIC-106

TO LOGIC-107

TO LOGIC-108

TO LOGIC-109

TO LOGIC-110

TO LOGIC-111

TO LOGIC-112

TO LOGIC-113

TO LOGIC-114

TO LOGIC-115

TO LOGIC-116

TO LOGIC-117

TO LOGIC-118

TO LOGIC-119

TO LOGIC-120

TO LOGIC-121

TO LOGIC-122

TO LOGIC-123

TO LOGIC-124

TO LOGIC-125

TO LOGIC-126

TO LOGIC-127

TO LOGIC-128

TO LOGIC-129

TO LOGIC-130

TO LOGIC-131

TO LOGIC-132

TO LOGIC-133

TO LOGIC-134

TO LOGIC-135

TO LOGIC-136

TO LOGIC-137

TO LOGIC-138

TO LOGIC-139

TO LOGIC-140

TO LOGIC-141

TO LOGIC-142

TO LOGIC-143

TO LOGIC-144

TO LOGIC-145

TO LOGIC-146

TO LOGIC-147

TO LOGIC-148

TO LOGIC-149

TO LOGIC-150

TO LOGIC-151

TO LOGIC-152

TO LOGIC-153

TO LOGIC-154

TO LOGIC-155

TO LOGIC-156

TO LOGIC-157

TO LOGIC-158

TO LOGIC-159

TO LOGIC-160

TO LOGIC-161

TO LOGIC-162

TO LOGIC-163

TO LOGIC-164

TO LOGIC-165

TO LOGIC-166

TO LOGIC-167

TO LOGIC-168

TO LOGIC-169

TO LOGIC-170

TO LOGIC-171

TO LOGIC-172

TO LOGIC-173

TO LOGIC-174

TO LOGIC-175

TO LOGIC-176

TO LOGIC-177

TO LOGIC-178

TO LOGIC-179

TO LOGIC-180

TO LOGIC-181

TO LOGIC-182

TO LOGIC-183

TO LOGIC-184

TO LOGIC-185

TO LOGIC-186

TO LOGIC-187

TO LOGIC-188

TO LOGIC-189

TO LOGIC-190

TO LOGIC-191

TO LOGIC-192

TO LOGIC-193

TO LOGIC-194

TO LOGIC-195

TO LOGIC-196

TO LOGIC-197

TO LOGIC-198

TO LOGIC-199

TO LOGIC-200

TO LOGIC-201

TO LOGIC-202

TO LOGIC-203

TO LOGIC-204

TO LOGIC-205

TO LOGIC-206

TO LOGIC-207

TO LOGIC-208

TO LOGIC-209

TO LOGIC-210

TO LOGIC-211

TO LOGIC-212

TO LOGIC-213

TO LOGIC-214

TO LOGIC-215

TO LOGIC-216

TO LOGIC-217

TO LOGIC-218

TO LOGIC-219

TO LOGIC-220

TO LOGIC-221

TO LOGIC-222

TO LOGIC-223

TO LOGIC-224

TO LOGIC-225

TO LOGIC-226

TO LOGIC-227

TO LOGIC-228

TO LOGIC-229

TO LOGIC-230

TO LOGIC-231

TO LOGIC-232

TO LOGIC-233

TO LOGIC-234

TO LOGIC-235

TO LOGIC-236

TO LOGIC-237

TO LOGIC-238

TO LOGIC-239

TO LOGIC-240

TO LOGIC-241

TO LOGIC-242

TO LOGIC-243

TO LOGIC-244

TO LOGIC-245

TO LOGIC-246

TO LOGIC-247

TO LOGIC-248

TO LOGIC-249

TO LOGIC-250

TO LOGIC-251

TO LOGIC-252

TO LOGIC-253

TO LOGIC-254

TO LOGIC-255

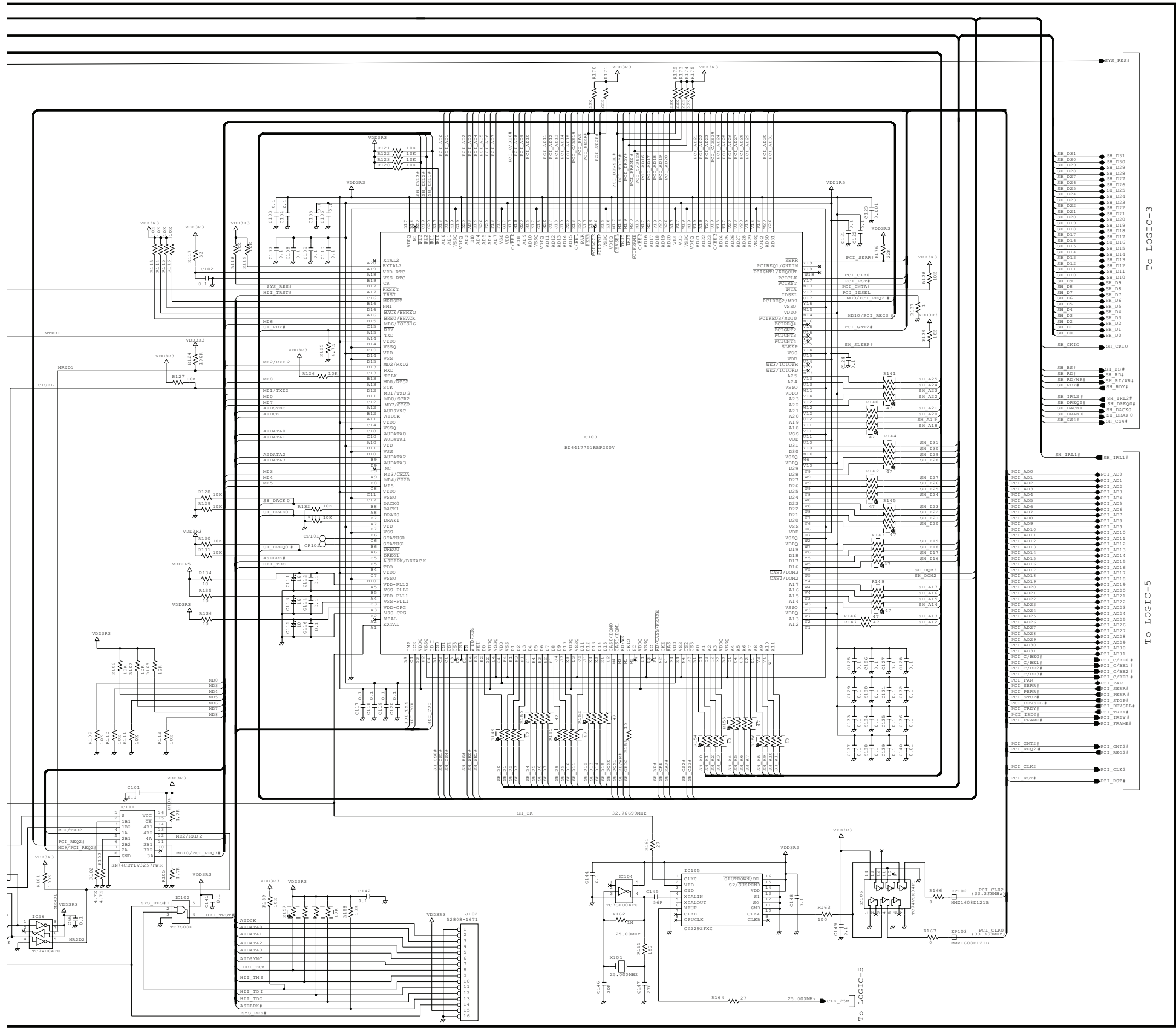

LOGIC UNIT (LOGIC-3)

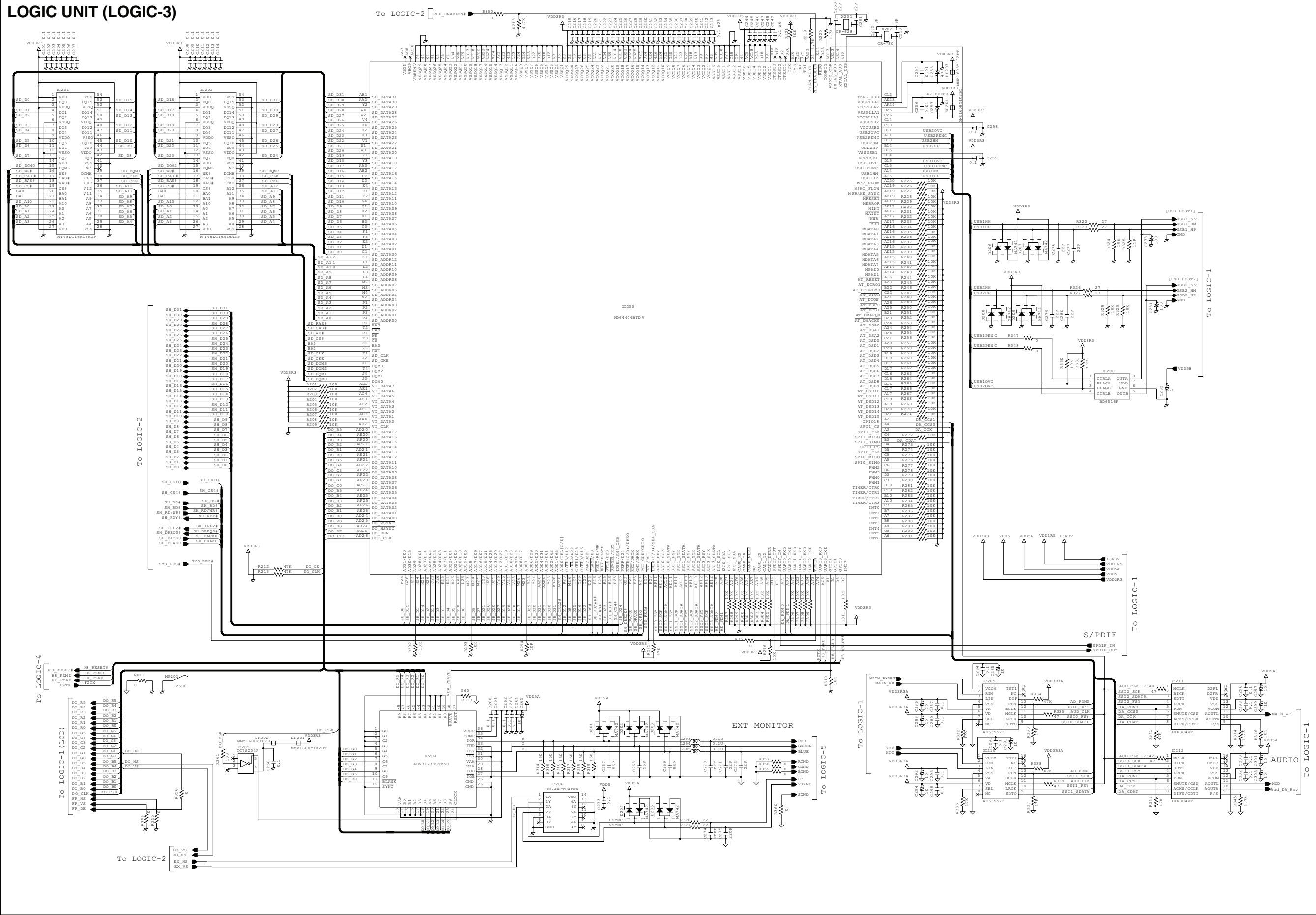

LOGIC UNIT (LOGIC-4)

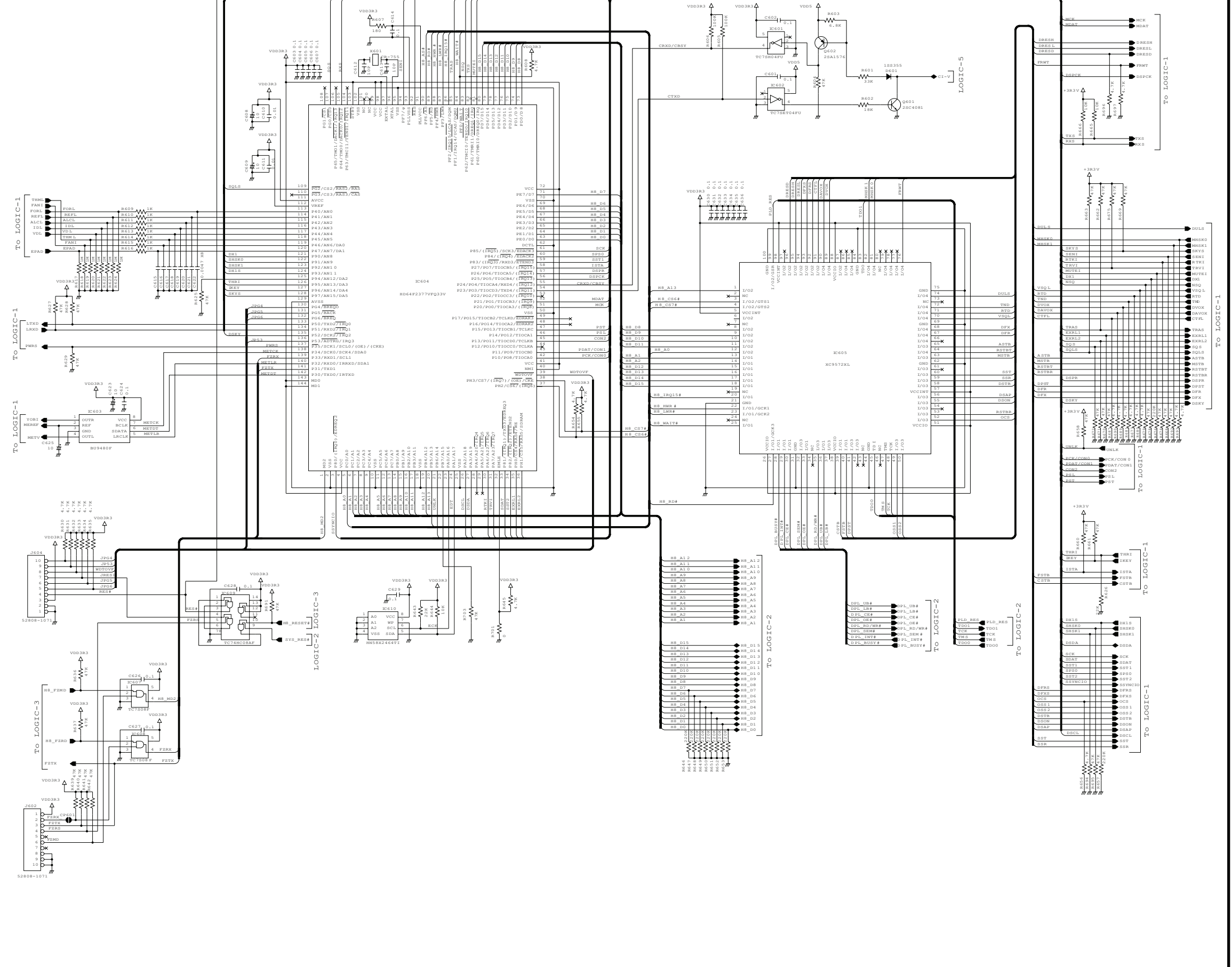

MAIN UNIT (MAIN-1)

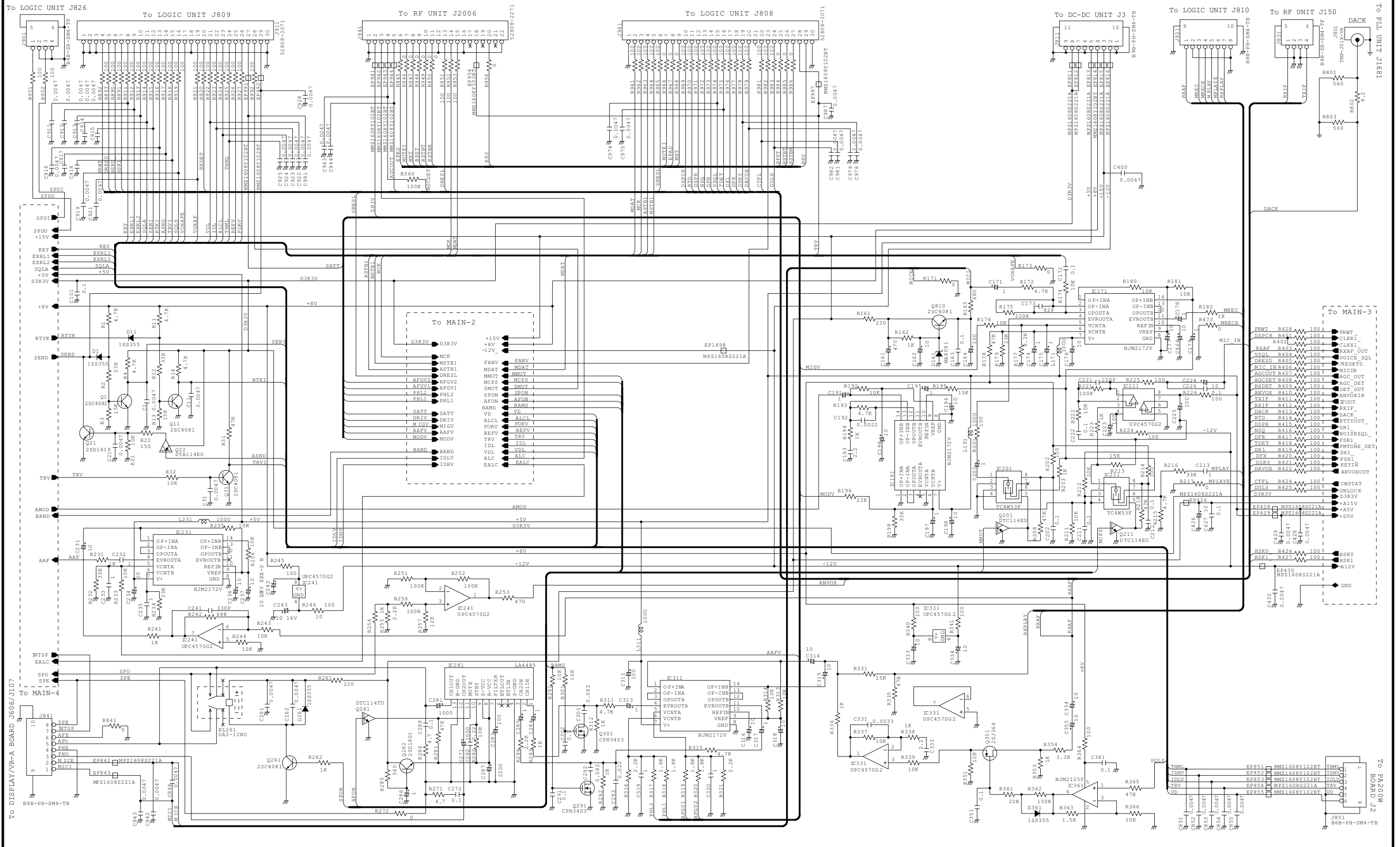

PLL UNIT (PLL-1)

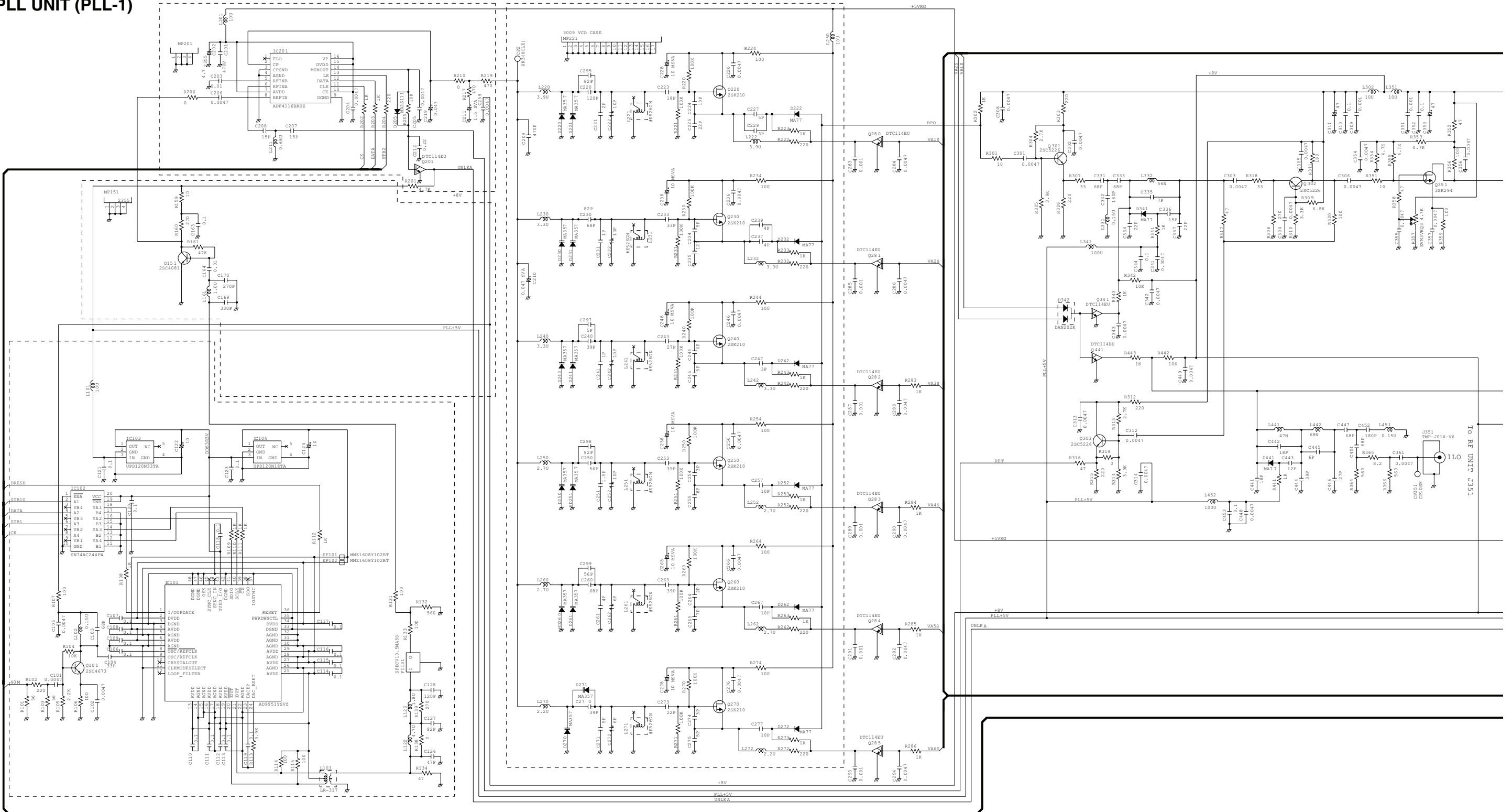

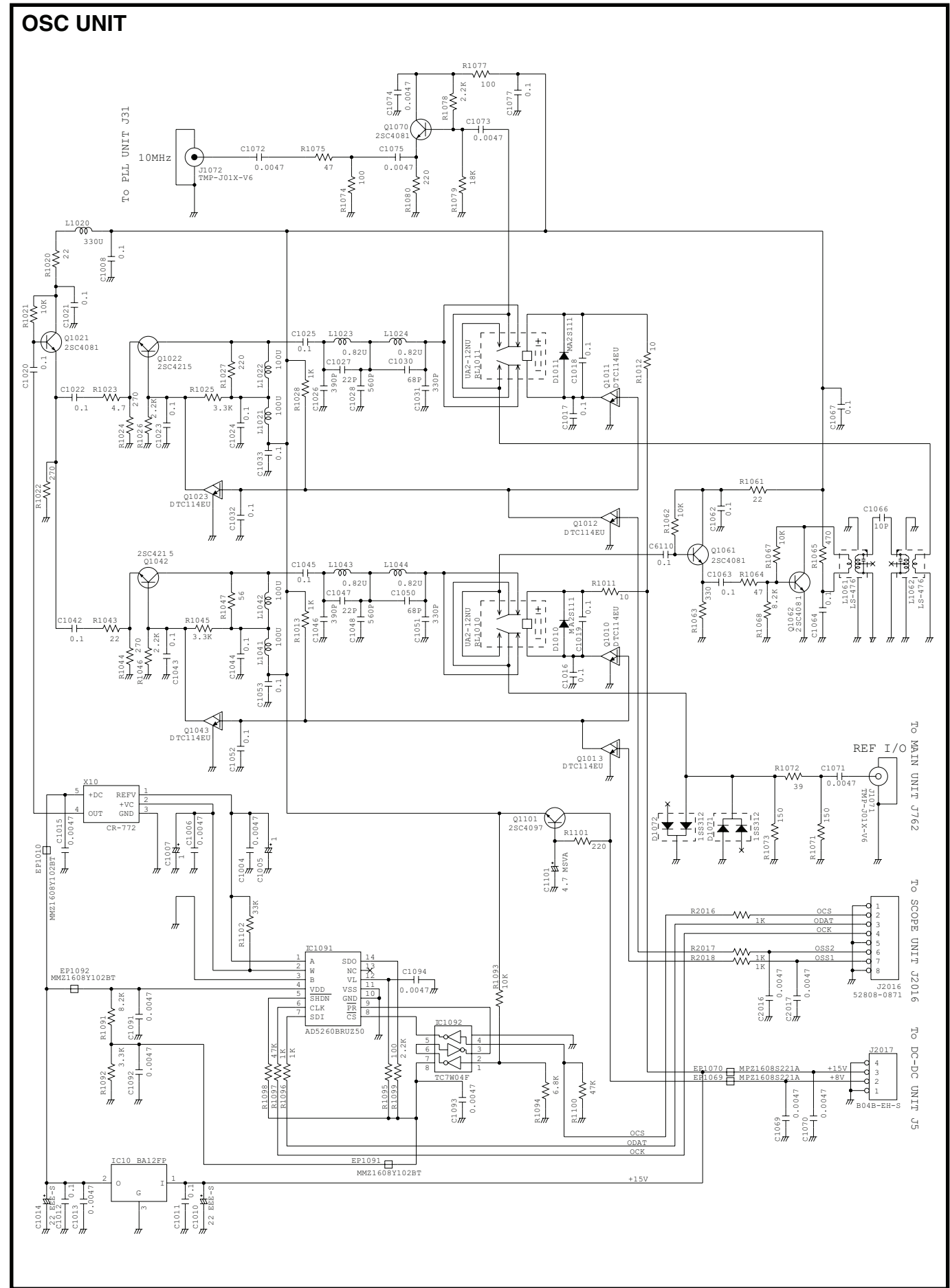
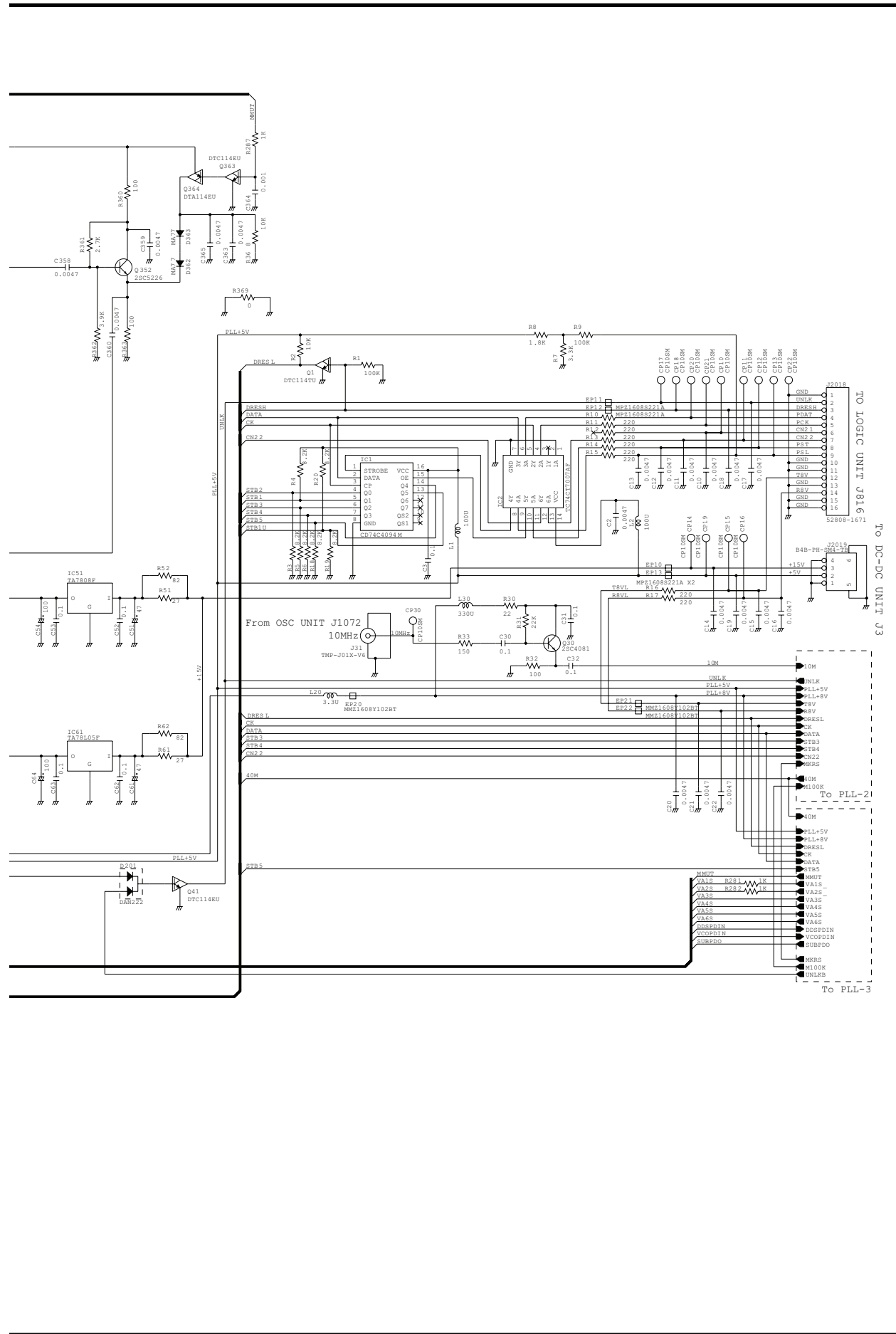

PLL UNIT (PLL-3)

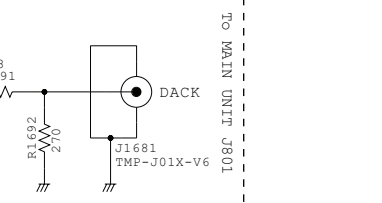
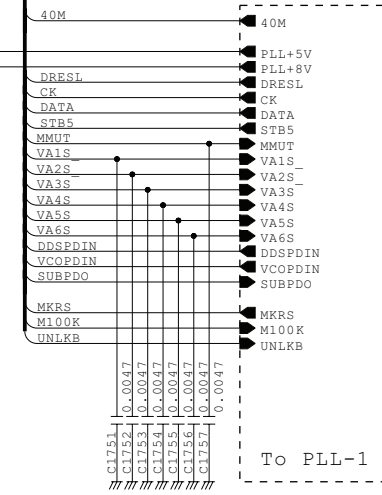
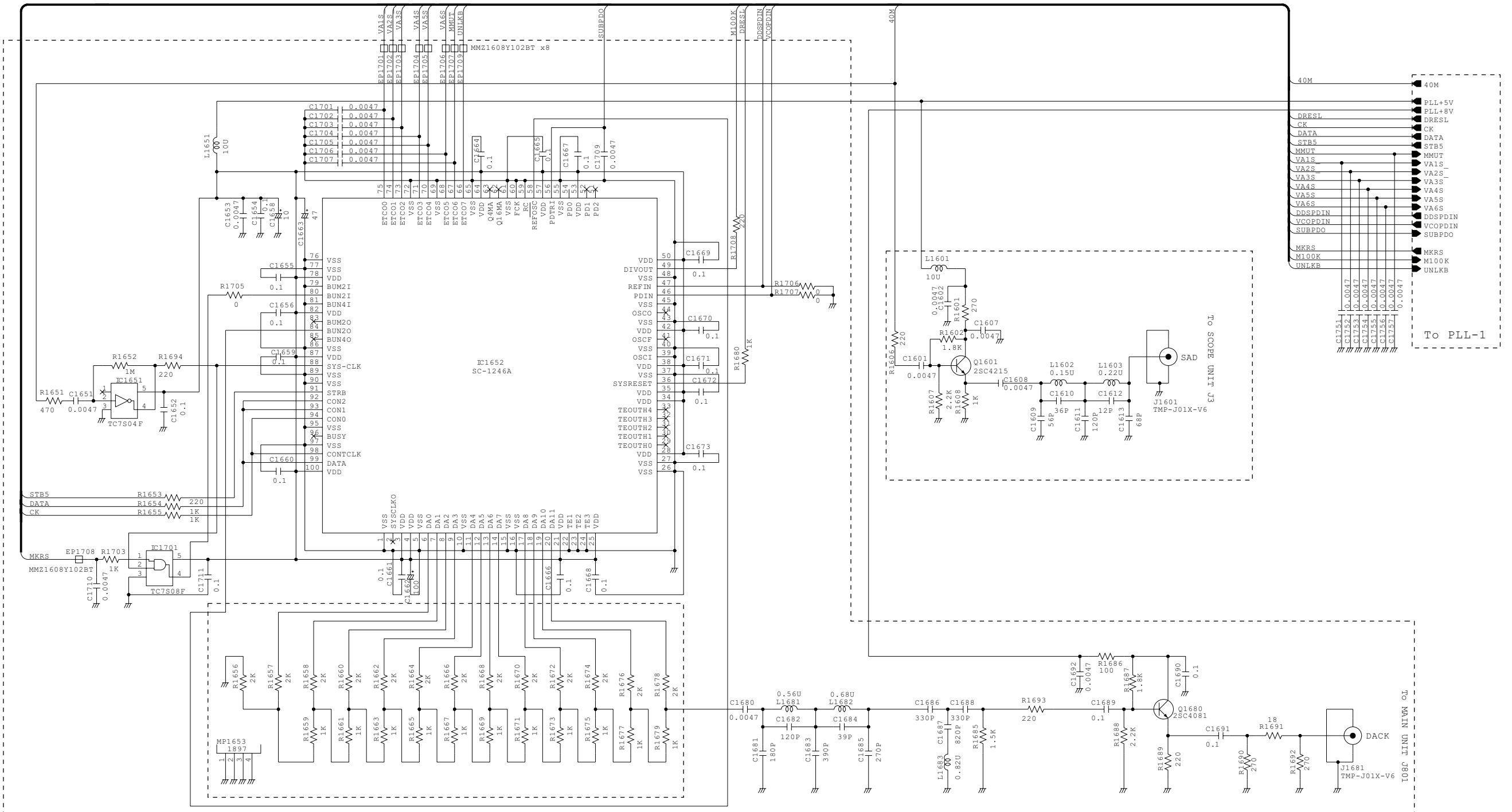

ANT-SW UNIT

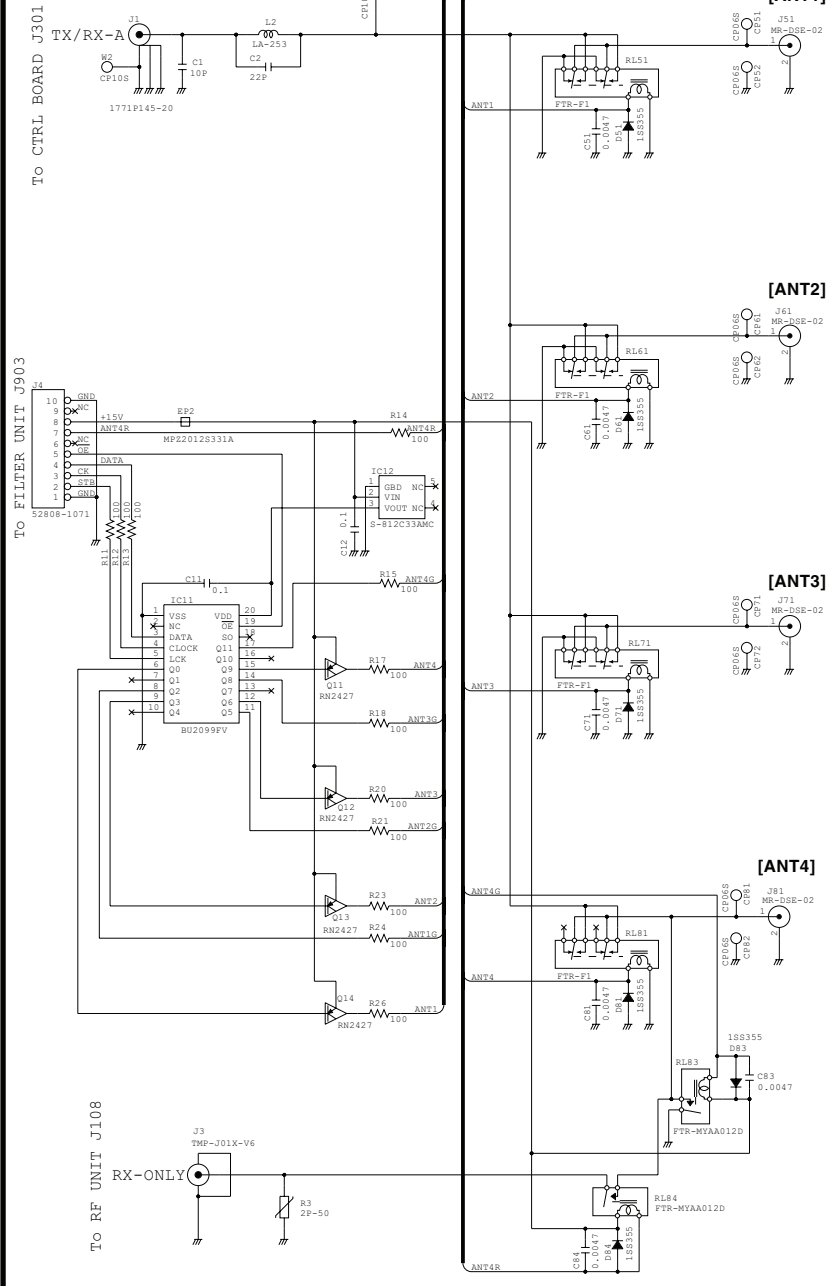

DIGISEL UNIT

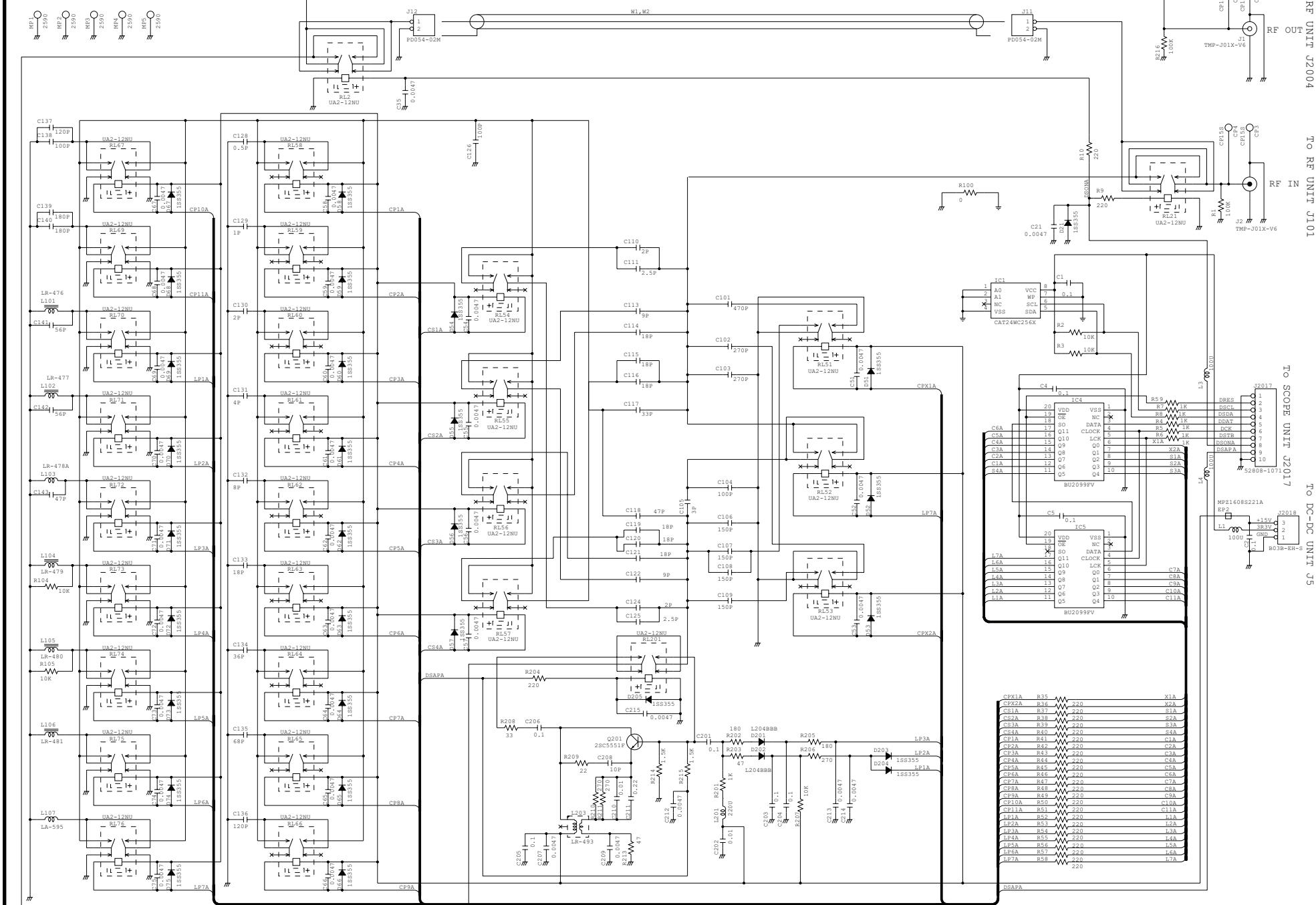

RF UNIT (RF-1)

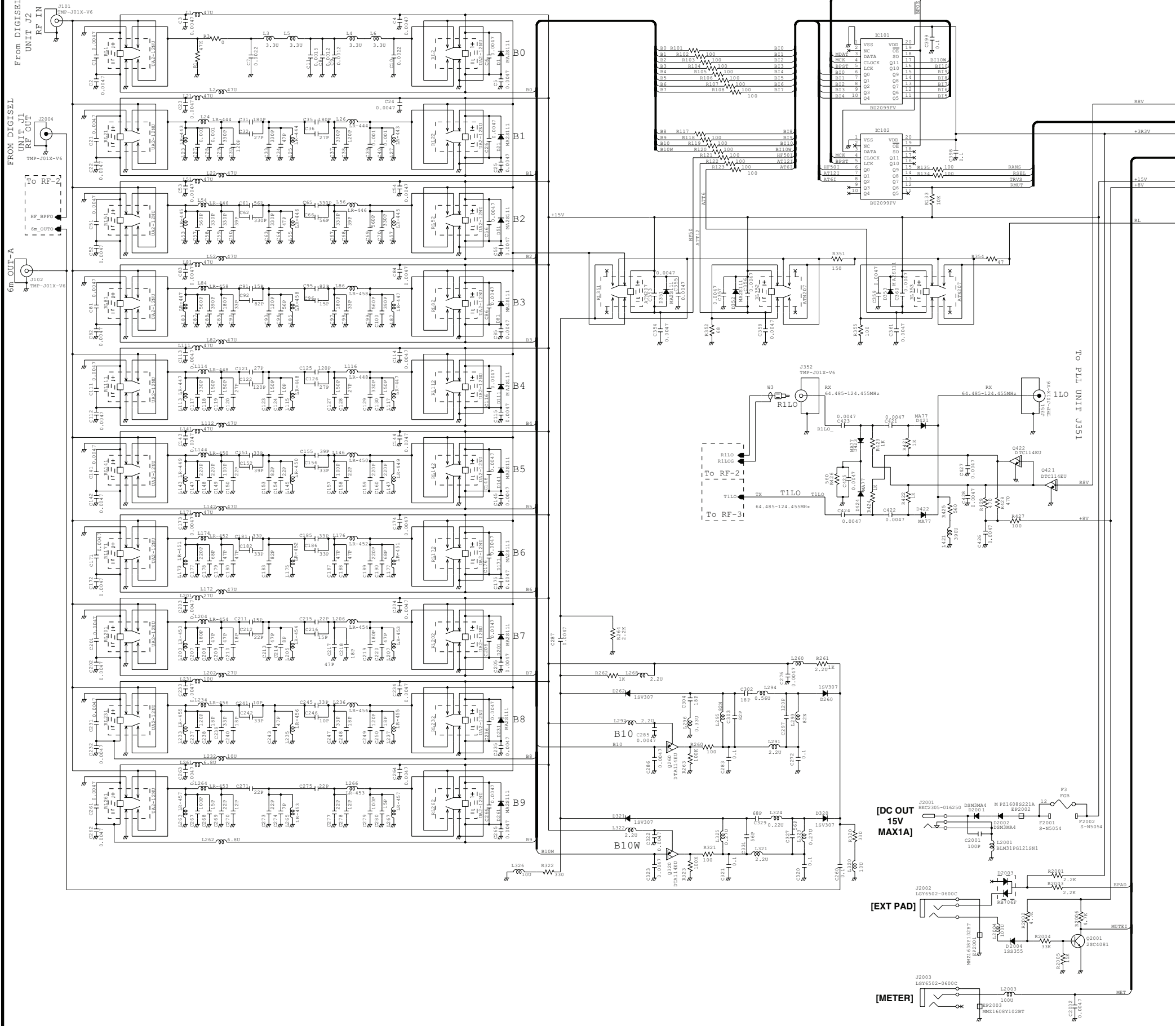

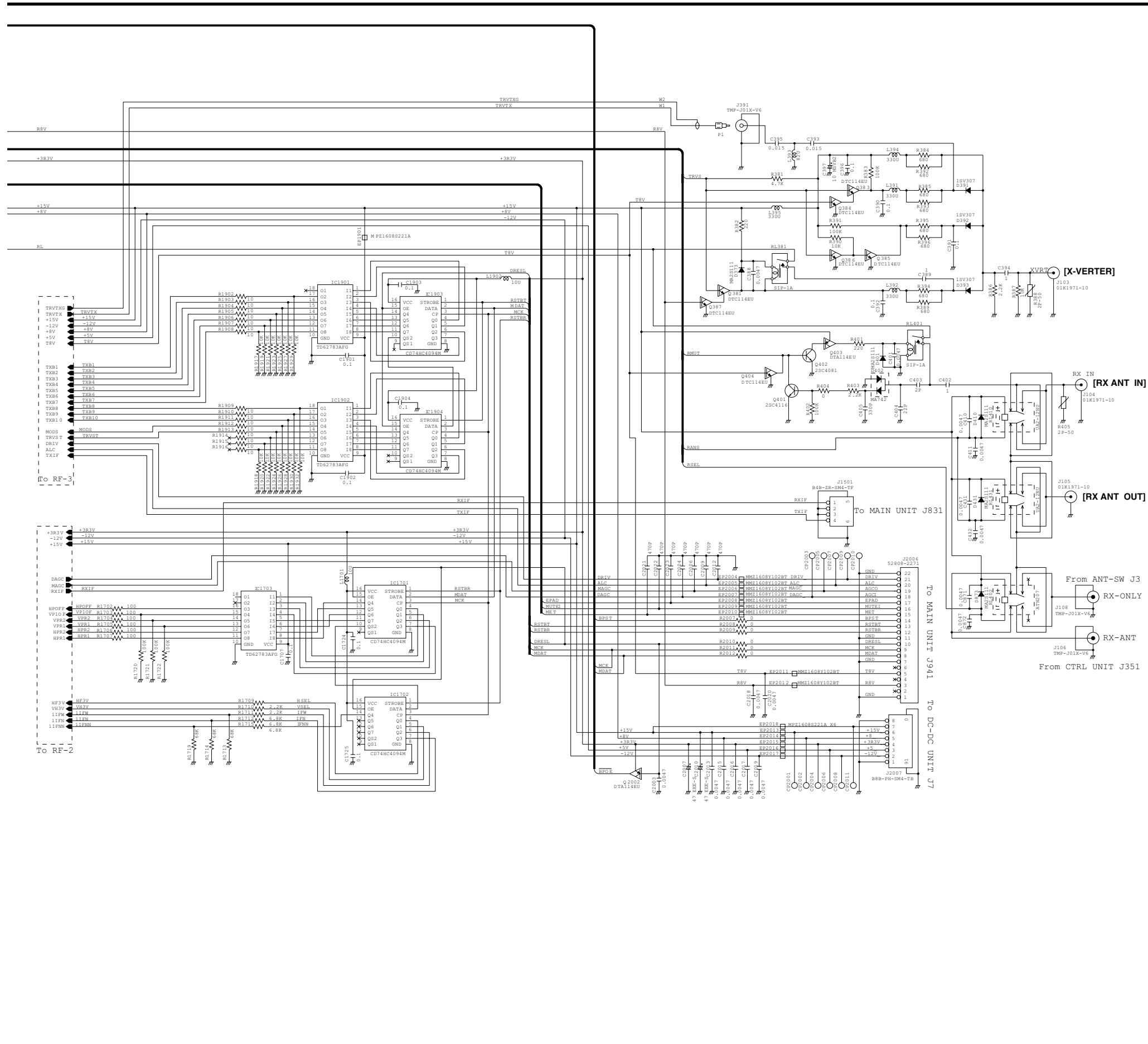

RF UNIT (RF-2)

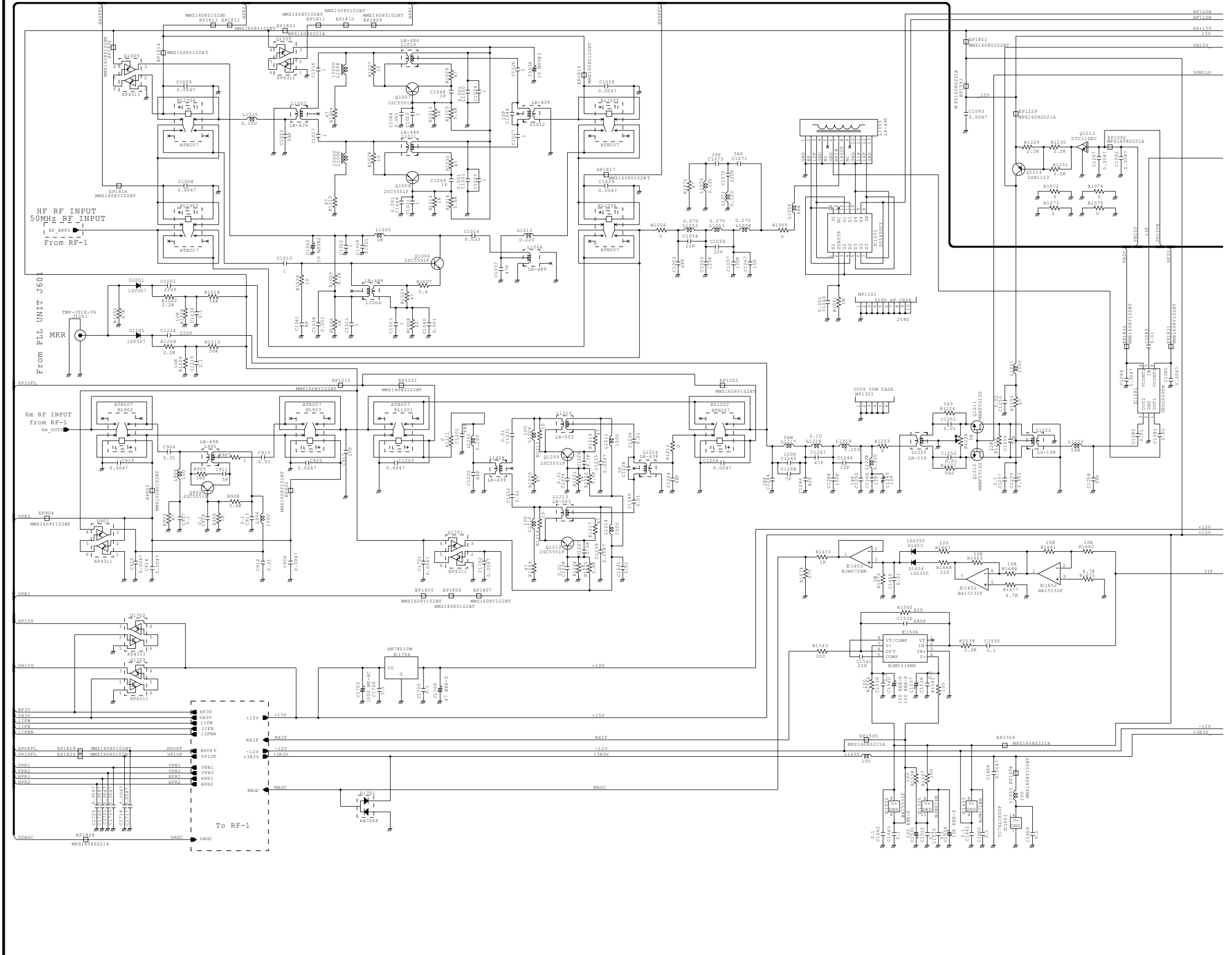

RF UNIT (RF-3)

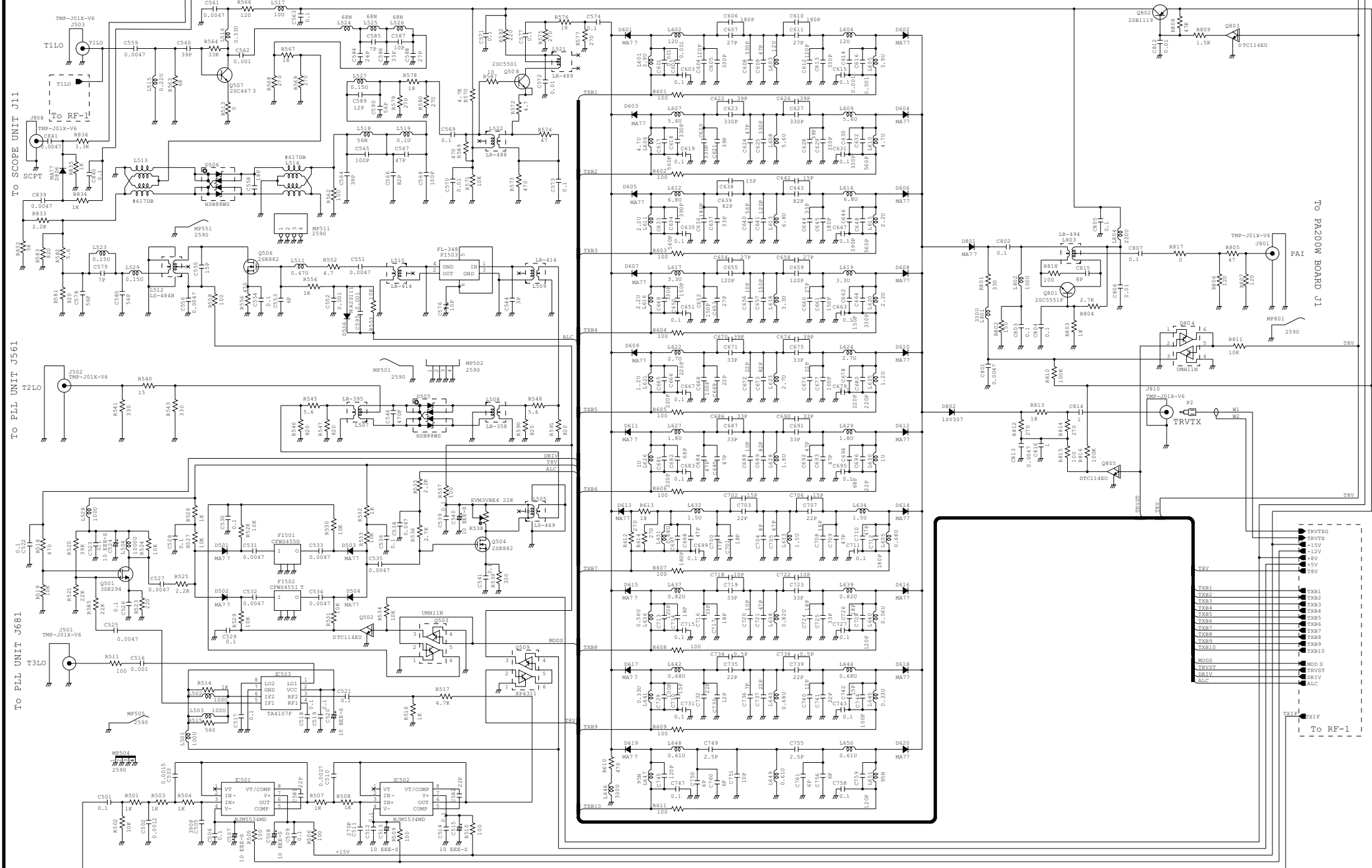

NETWORK BOARD

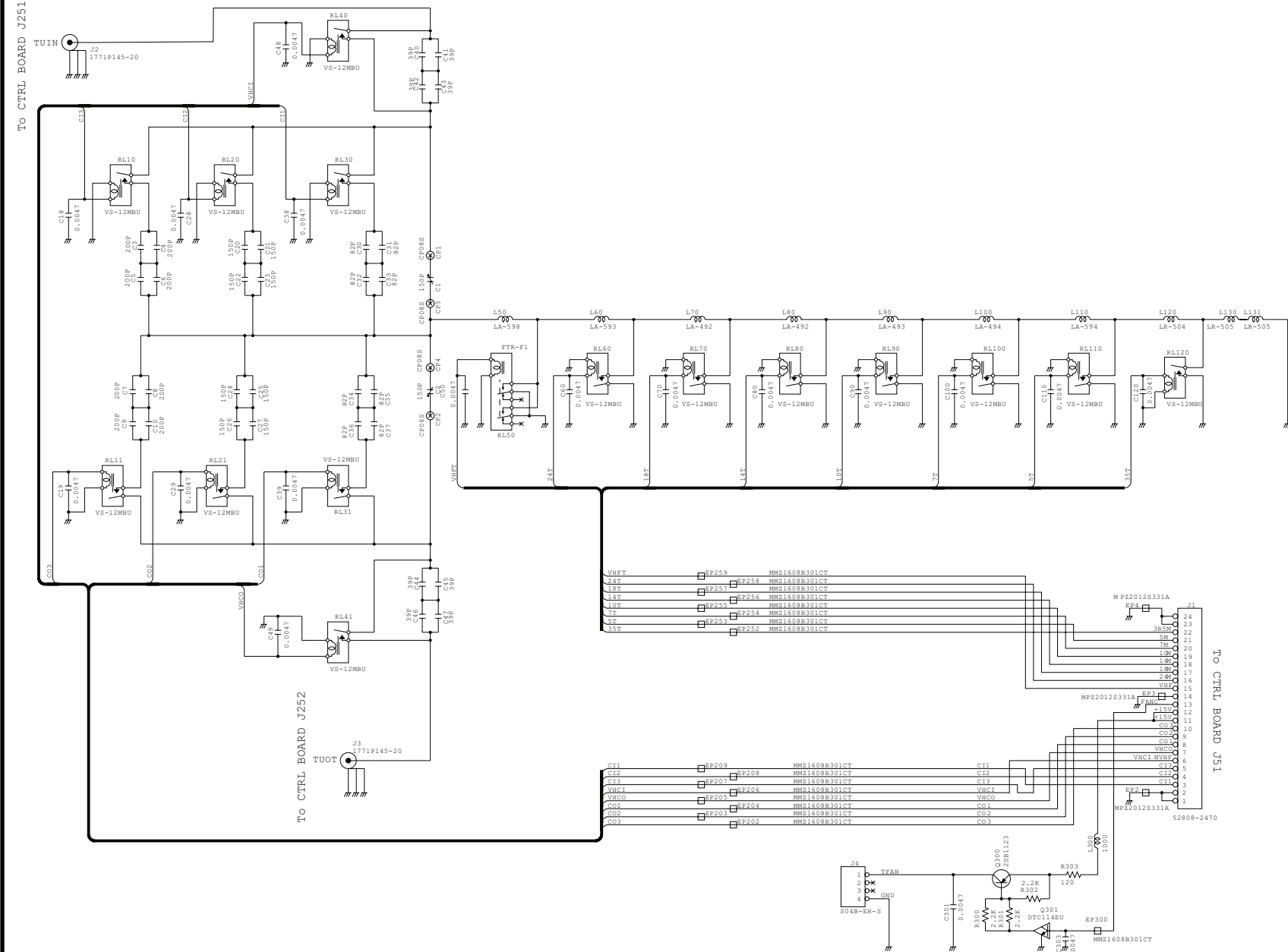

CTRL BOARD

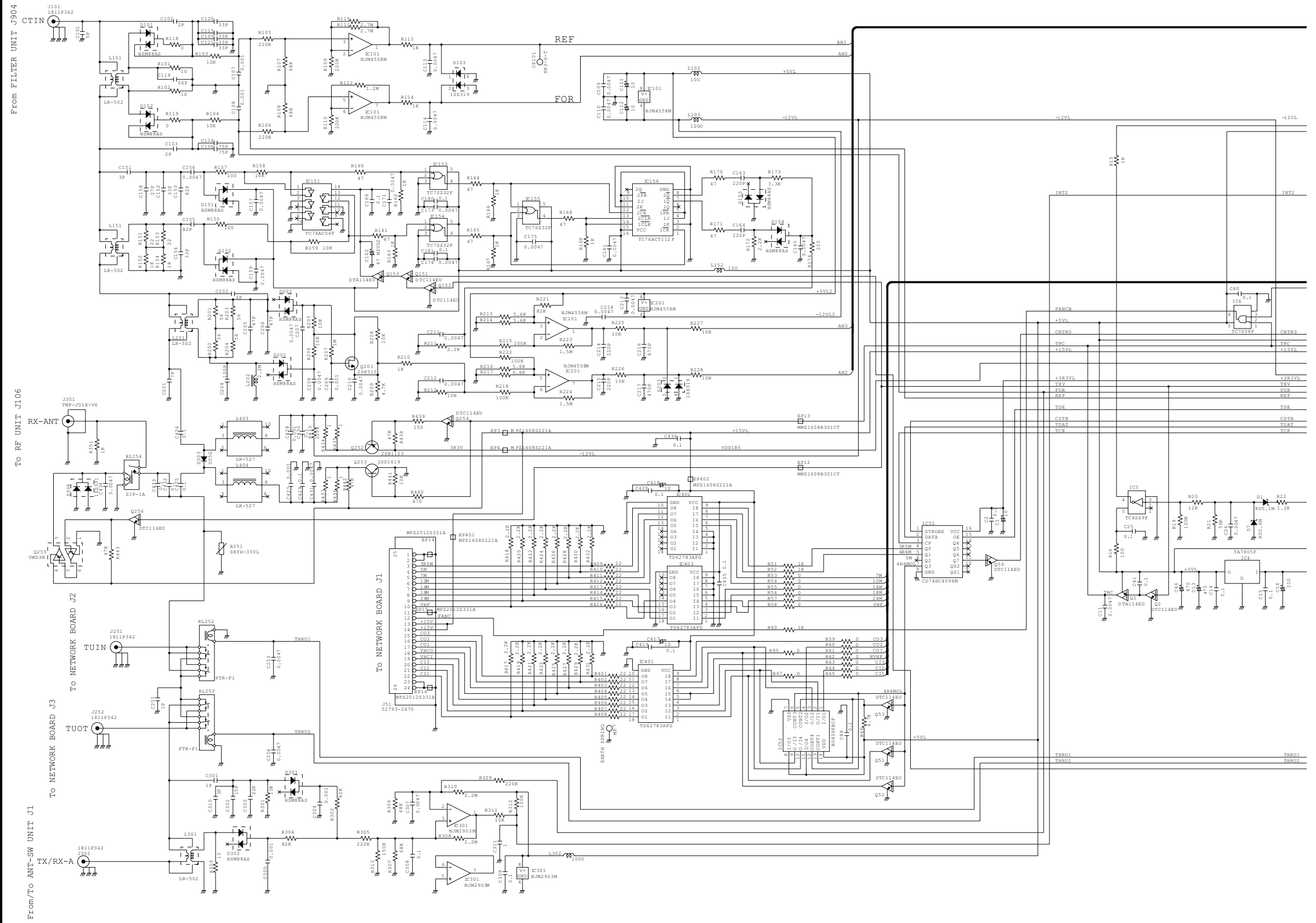

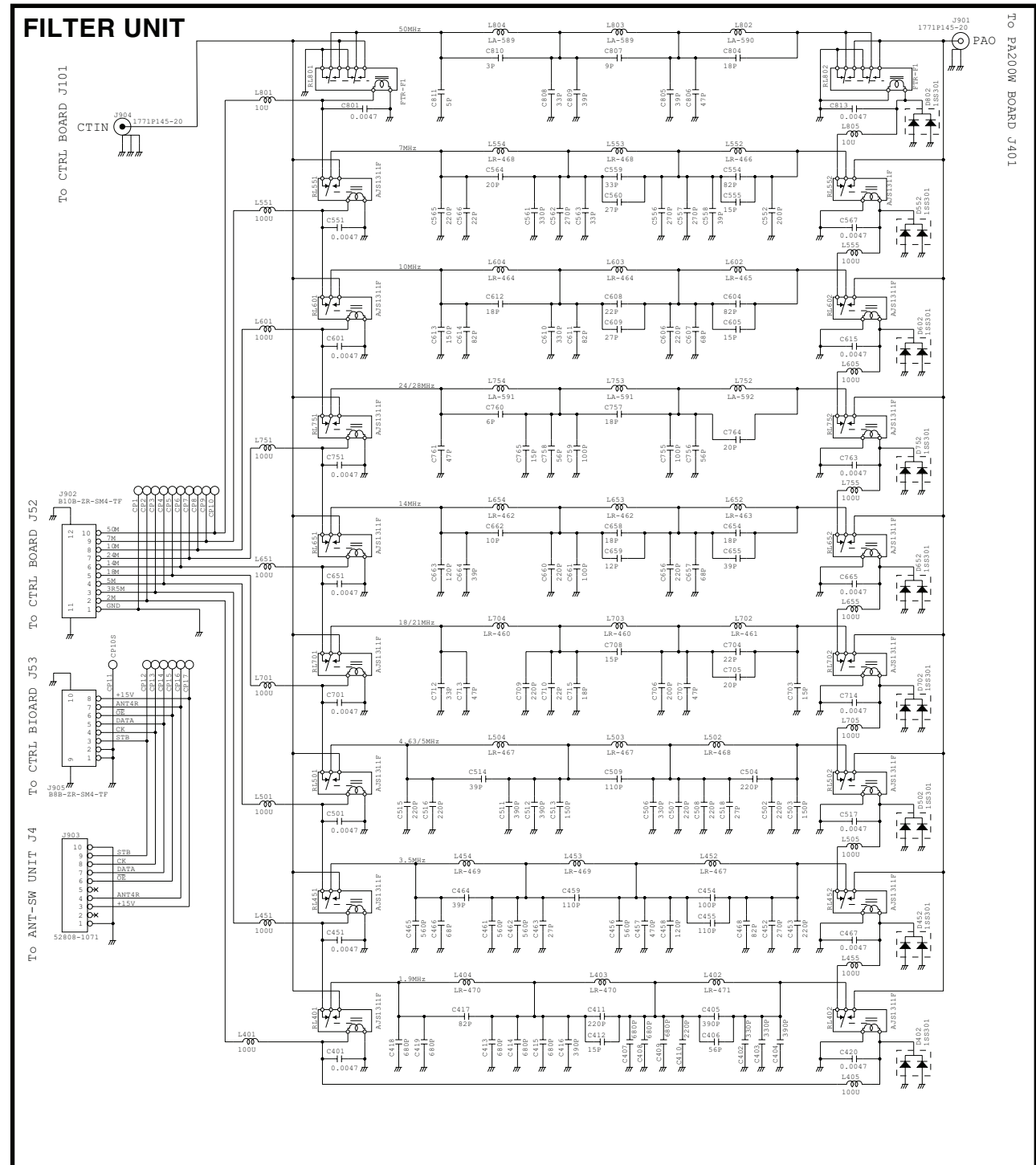
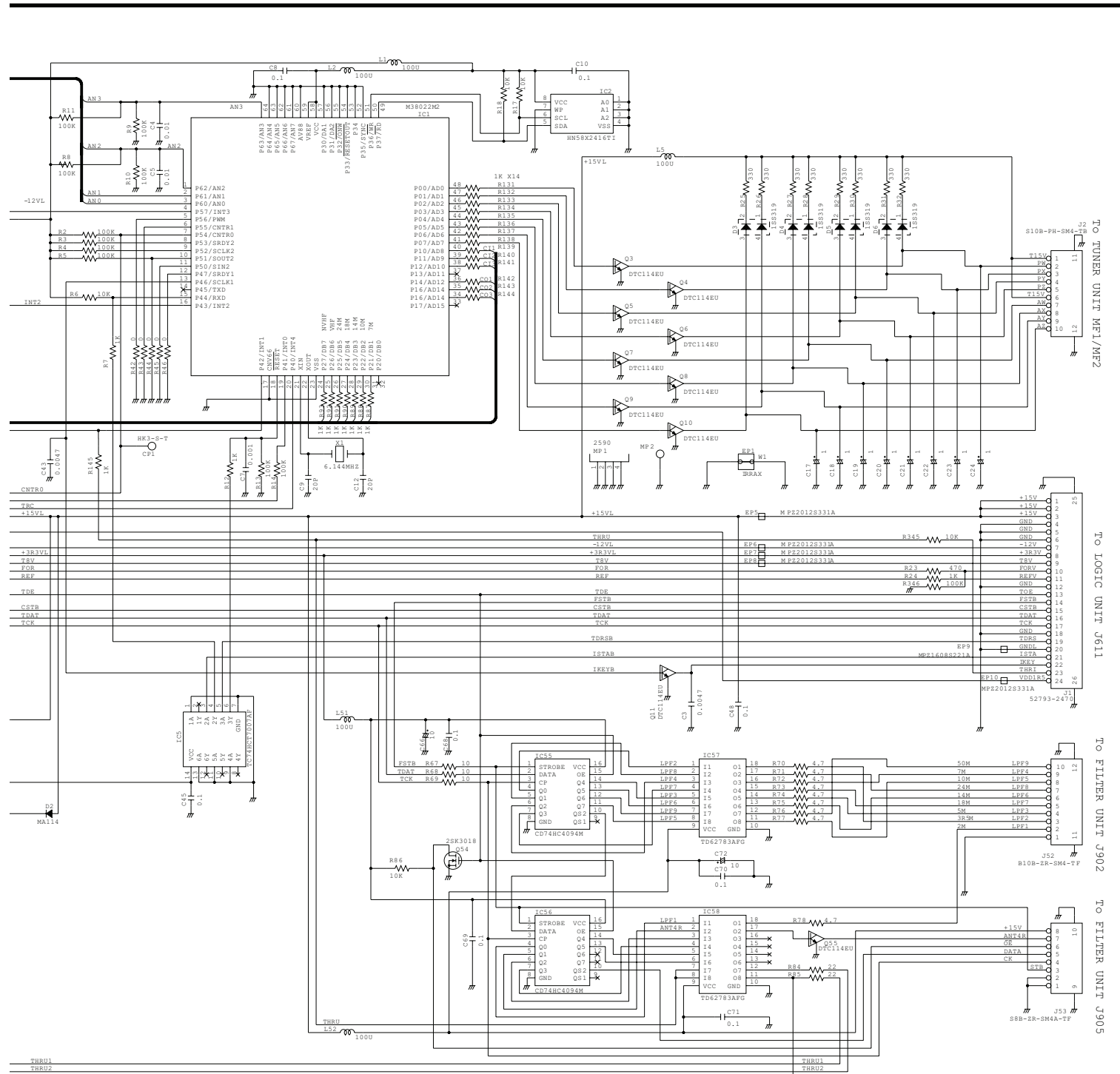

PA200W BOARD

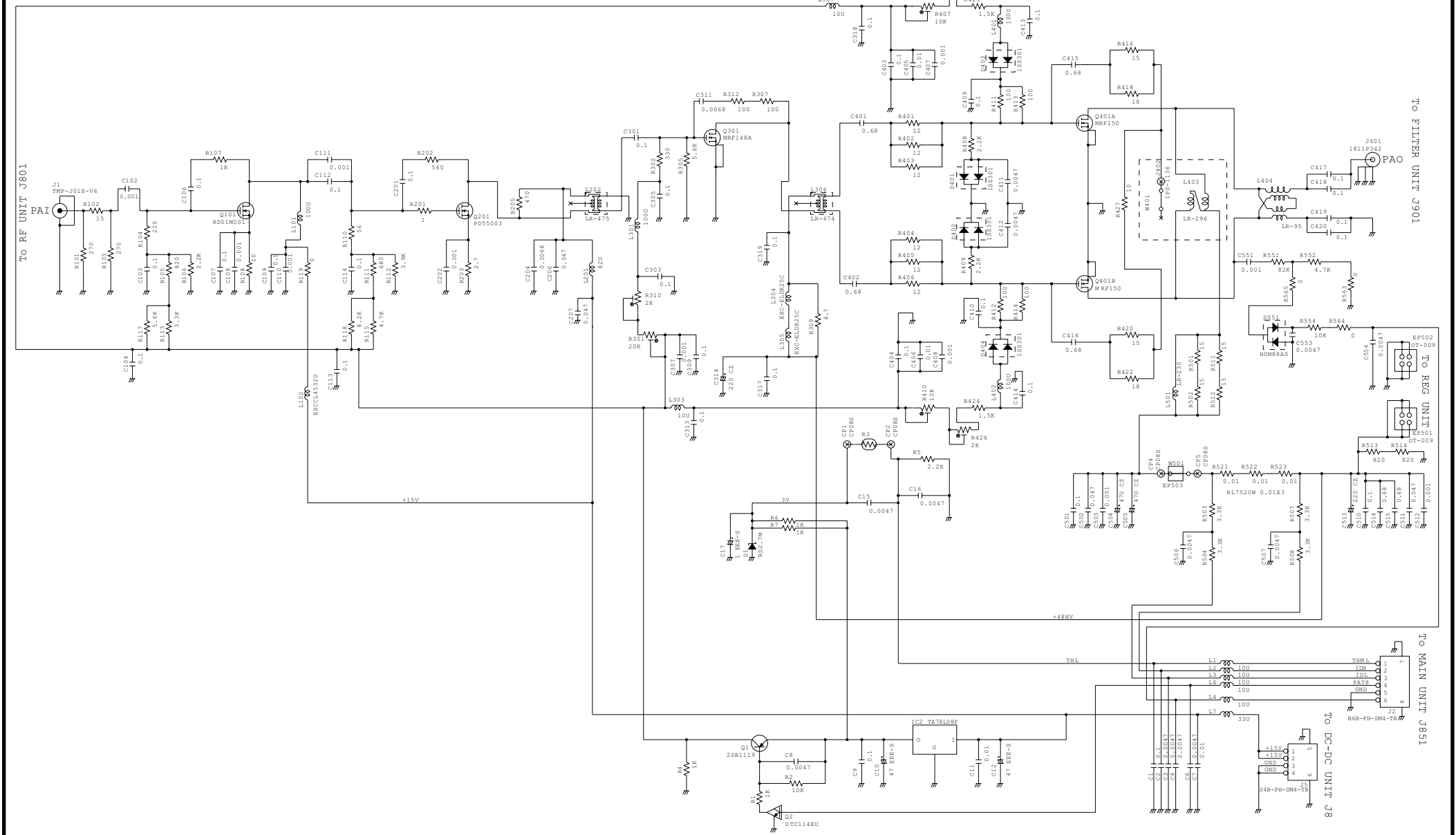

SCOPE UNIT (SCOPE-1)

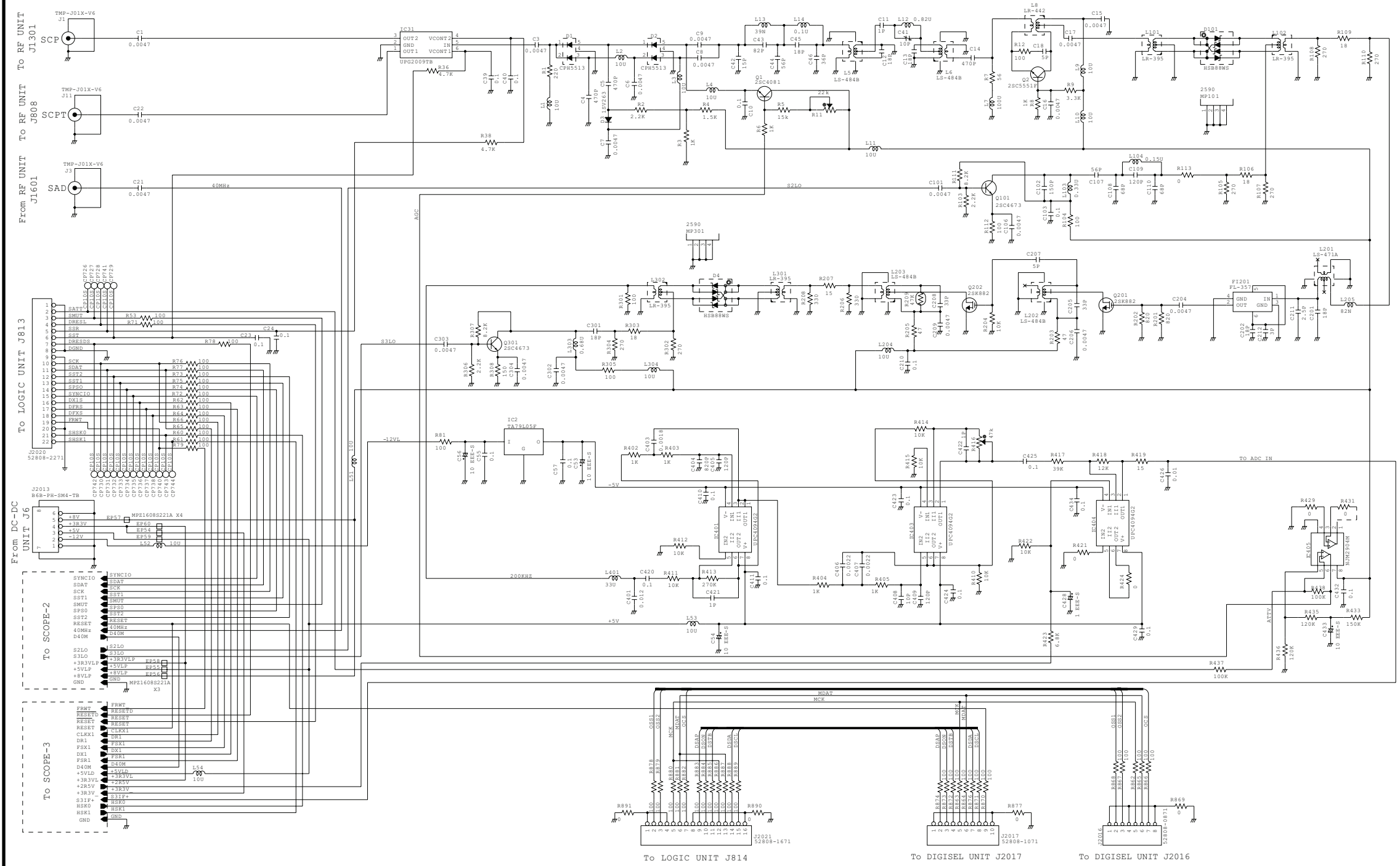

Icom Inc.

1-1-32, Kamiminami, Hirano-ku, Osaka 547-0003, Japan
Phone : +81 (06) 6793 5302
Fax : +81 (06) 6793 0013
URL : <http://www.icom.co.jp/world/index.html>

Icom America Inc.

<Corporate Headquarters>
2380 116th Avenue N.E., Bellevue, WA 98004, U.S.A.
Phone : +1 (425) 454-8155 Fax : +1 (425) 454-1509
URL : <http://www.icomamerica.com>
E-mail : sales@icomamerica.com
<Customer Service>
Phone : +1 (425) 454-7619

Icom Canada

Glenwood Centre #150-6165
Highway 17 Delta, B.C., V4K 5B8, Canada
Phone : +1 (604) 952-4266 Fax : +1 (604) 952-0090
URL : <http://www.icomcanada.com>
E-mail : info@icomcanada.com

Icom (Australia) Pty. Ltd.

Unit 1 / 103 Garden Road, Clayton VIC 3168 Australia
Phone : +61 (03) 9549-7500 Fax : +61 (03) 9549-7505
URL : <http://www.icom.net.au>
E-mail : sales@icom.net.au

Icom New Zealand

146A Harris Road, East Tamaki,
Auckland, New Zealand
Phone : +64 (09) 274 4062 Fax : +64 (09) 274 4708
URL : <http://www.icom.co.nz>
E-mail : inquiries@icom.co.nz

Beijing Icom Ltd.

10C07, Long silver Mansion, No.88, Yong Ding
Road, Haidian District, Beijing, 100039, China
Phone : +86 (010) 5889 5391/5392/5393
Fax : +86 (010) 5889 5395
E-mail : bjicom@bjicom.com
URL : <http://www.bjicom.com>

Icom (Europe) GmbH

Communication Equipment
Himmelgeister Str. 100, D-40225 Düsseldorf, Germany
Phone : +49 (0211) 346047 Fax : +49 (0211) 333639
URL : <http://www.icomeurope.com>
E-mail : info@icomeurope.com

Icom Spain S.L

Ctra. Rubi, No. 88 Bajos A 08174, Sant Cugat del Valles, Barcelona, Spain
Phone : +34 (93) 590 26 70 Fax : +34 (93) 589 04 46
URL : <http://www.icomspain.com>
E-mail : icom@icomspain.com

Icom (UK) Ltd.

Unit 9, Sea St., Herne Bay, Kent, CT6 8LD, U.K.
Phone : +44 (01227) 741741 Fax : +44 (01227) 741742
URL : <http://www.icomuk.co.uk>
E-mail : info@icomuk.co.uk

Icom France s.a.s.

Zac de la Plaine
1 Rue Brindejonc des Moulinais BP 5804
31505 Toulouse Cedex, France
Phone : +33 (5) 61 36 03 03 Fax : +33 (5) 61 36 03 00
URL : <http://www.icom-france.com>
E-mail : icom@icom-france.com

Asia Icom Inc.

6F No.68, Sec. 1 Cheng-Teh Road, Taipei, Taiwan, R.O.C.
Phone : +886 (02) 2559 1899 Fax : +886 (02) 2559 1874
URL : <http://www.asia-icom.com>
E-mail : sales@asia-icom.com

Icom Polska

81-850 Sopot, ul. 3 Maja 54, Poland
Phone : +48 (58) 550 7135 Fax : +48 (58) 551 0484
E-mail : icompolaska@icompolaska.com.pl

Count on us!

Icom Inc.

1-1-32, Kamiminami, Hirano-ku, Osaka 547-0003, Japan

S-14407XZ-C1
© 2008 Icom Inc.